

**MuPAD<sup>®</sup>**  
Reference



**MATLAB<sup>®</sup>**

R2018b



# How to Contact MathWorks



Latest news: [www.mathworks.com](http://www.mathworks.com)  
Sales and services: [www.mathworks.com/sales\\_and\\_services](http://www.mathworks.com/sales_and_services)  
User community: [www.mathworks.com/matlabcentral](http://www.mathworks.com/matlabcentral)  
Technical support: [www.mathworks.com/support/contact\\_us](http://www.mathworks.com/support/contact_us)



Phone: 508-647-7000



The MathWorks, Inc.  
3 Apple Hill Drive  
Natick, MA 01760-2098

*MuPAD® Reference*

© COPYRIGHT 1993–2018 by The MathWorks, Inc.

The software described in this document is furnished under a license agreement. The software may be used or copied only under the terms of the license agreement. No part of this manual may be photocopied or reproduced in any form without prior written consent from The MathWorks, Inc.

FEDERAL ACQUISITION: This provision applies to all acquisitions of the Program and Documentation by, for, or through the federal government of the United States. By accepting delivery of the Program or Documentation, the government hereby agrees that this software or documentation qualifies as commercial computer software or commercial computer software documentation as such terms are used or defined in FAR 12.212, DFARS Part 227.72, and DFARS 252.227-7014. Accordingly, the terms and conditions of this Agreement and only those rights specified in this Agreement, shall pertain to and govern the use, modification, reproduction, release, performance, display, and disclosure of the Program and Documentation by the federal government (or other entity acquiring for or through the federal government) and shall supersede any conflicting contractual terms or conditions. If this License fails to meet the government's needs or is inconsistent in any respect with federal procurement law, the government agrees to return the Program and Documentation, unused, to The MathWorks, Inc.

## Trademarks

MATLAB and Simulink are registered trademarks of The MathWorks, Inc. See [www.mathworks.com/trademarks](http://www.mathworks.com/trademarks) for a list of additional trademarks. Other product or brand names may be trademarks or registered trademarks of their respective holders.

## Patents

MathWorks products are protected by one or more U.S. patents. Please see [www.mathworks.com/patents](http://www.mathworks.com/patents) for more information.

**Revision History**

September 2012	Online only	New for Version 5.9 (Release 2012b)
March 2013	Online only	Revised for Version 5.10 (Release 2013a)
September 2013	Online only	Revised for Version 5.11 (Release 2013b)
March 2014	Online only	Revised for Version 6.0 (Release 2014a)
October 2014	Online only	Revised for Version 6.1 (Release 2014b)
March 2015	Online only	Revised for Version 6.2 (Release 2015a)
September 2015	Online only	Revised for Version 6.3 (Release 2015b)
March 2016	Online only	Revised for Version 7.0 (Release 2016a)
September 2016	Online only	Revised for Version 7.1 (Release 2016b)
March 2017	Online only	Revised for Version 7.2 (Release 2017a)
September 2017	Online only	Revised for Version 8.0 (Release 2017b)
March 2018	Online only	Revised for Version 8.1 (Release 2018a)
September 2018	Online only	Revised for Version 8.2 (Release 2018b)





<b>1</b>	<b><u>The Standard Library</u></b>
<b>2</b>	<b><u>adt - Abstract Datatypes</u></b>
<b>3</b>	<b><u>Ax - Axioms</u></b>
<b>4</b>	<b><u>Cat - Categories</u></b>
<b>5</b>	<b><u>combinat - Combinatorics</u></b>
<b>6</b>	<b><u>daetools - Analyze and Reduce Differential Algebraic Equations (DAEs)</u></b>
<b>7</b>	<b><u>Dom - Domains</u></b>

<b>8</b>	<b>export - Export Data</b>
<b>9</b>	<b>fp - Functional Programming</b>
<b>10</b>	<b>generate - Generate Input to Other Programs</b>
<b>11</b>	<b>Graph - Graph Theory</b>
<b>12</b>	<b>groebner - Gröbner bases</b>
<b>13</b>	<b>import - Import Data</b>
<b>14</b>	<b>intlib - Integration Utilities</b>

<b>15</b>	<b><u>linalg - Linear Algebra</u></b>
<b>16</b>	<b><u>linopt - Linear Optimization</u></b>
<b>17</b>	<b><u>listlib - Manipulating Lists</u></b>
<b>18</b>	<b><u>misc - Miscellanea</u></b>
<b>19</b>	<b><u>numeric - Numerical Algorithms</u></b>
<b>20</b>	<b><u>numlib - Number Theory</u></b>
<b>21</b>	<b><u>ode - Ordinary Differential Equations</u></b>



<b>22</b>	<b><u>orthpoly - Orthogonal Polynomials</u></b>
<b>23</b>	<b><u>output - Formatted Output</u></b>
<b>24</b>	<b><u>Graphics and Animations</u></b>
<b>25</b>	<b><u>polylib - Manipulating Polynomials</u></b>
<b>26</b>	<b><u>Pref - User Preferences</u></b>
<b>27</b>	<b><u>prog - Programmer's Toolbox</u></b>
<b>28</b>	<b><u>property - Properties and Assumptions</u></b>

<b>29</b>	<b>solvelib - Datatypes and Utilities for the Solver</b>
<b>30</b>	<b>stats - Statistics</b>
<b>31</b>	<b>stringlib - Manipulating Strings</b>
<b>32</b>	<b>Symbol - Typesetting Symbols</b>
<b>33</b>	<b>Type - Type Checking and Mathematical Properties</b>

# The Standard Library

---

## **:=\_assign**

Assign variables

### **Syntax**

`x := value`

`_assign(x, value)`

`[x1, x2, ...] := [value1, value2, ...]`

`_assign([x1, x2, ...], [value1, value2, ...])`

`f( X1, X2, ... ) := value`

`_assign(f(X1, X2, ...), value)`

### **Description**

`x := value` assigns the variable `x` a `value`.

`[x1, x2, ...] := [value1, value2, ...]` assigns the variables `x1`, `x2` etc. the corresponding values `value1`, `value2` etc.

`f(X1, X2, ... ) := value` adds an entry to the remember table on page 27-45 (Symbolic Math Toolbox) of the procedure `f`.

`_assign(x, value)` is equivalent to `x := value`.

`_assign([x1, x2, ...], [value1, value2, ...])` is equivalent to `[x1, x2, ...] := [value1, value2, ...]`. Both lists must have the same number of elements.

---

**Note** If `x` is neither a list on page 7-41, nor a table on page 1-2103, nor an array on page 7-2, nor an `harray` on page 7-27, nor a matrix on page 7-252, nor an element of a domain with a slot on page 1-1980 "set\_index", then an indexed assignment such as

`x[i] := value` implicitly turns the identifier `x` into a table with a single entry (`i = value`). See “Example 2” on page 1-4 (Symbolic Math Toolbox).

---

The assignment `f(X1, X2, ...) := value` adds an entry to the remember table on page 27-45 (Symbolic Math Toolbox) of the procedure `f`.

---

**Note** If `f` is neither procedure on page 1-2014 (Symbolic Math Toolbox) nor a function environment on page 1-1642 (Symbolic Math Toolbox), then `f` is implicitly turned into a (trivial) procedure with a single entry `(X1, X2, ...) = value` in its remember table. See “Example 4” on page 1-7 (Symbolic Math Toolbox).

---

Identifiers on the left hand side of an assignment are not evaluated (use `evalassign` if this is not desired). I.e., in `x := value`, the previous value of `x`, if any, is deleted and replaced by the new value. Note, however, that the index of an indexed identifier is evaluated. I.e., in `x[i] := value`, the index `i` is replaced by its current value before the corresponding entry of `x` is assigned the value. See “Example 5” on page 1-8 (Symbolic Math Toolbox).

## Examples

### Example 1

The assignment operator `:=` can be applied to a single identifier as well as to a list of identifiers:

```
x := 42:  
[x1, x2, x3] := [43, 44, 45]:  
x, x1, x2, x3
```

42, 43, 44, 45

In case of lists, all variables of the left-hand side are assigned their values *simultaneously*:

```
[x1, x2] := [3, 4]:  
[x1, x2] := [x2, x1]:  
x1, x2
```

4, 3

The functional equivalent of the assign operator := is the function `_assign`:

```
_assign(x, 13): _assign([x1, x2], [14, 15]): x, x1, x2
```

13, 14, 15

Assigned values are deleted via the keyword `delete`:

```
delete x, x1, x2:  
x, x1, x2
```

x, x1, x2

## Example 2

Assigning a value to an indexed identifier, a corresponding table (`table`, `DOM_TABLE`) is generated implicitly, if the identifier was not assigned a list on page 7-41, a table on page 1-2103, an array on page 7-2, an `hfarray` on page 7-27, or a matrix on page 1-2045 (Symbolic Math Toolbox) before:

```
delete x:  
x[1] := 7:  
x
```

$\overline{1|7}$

If `x` is a list, a table, an array, an `hfarray`, or a matrix, then an indexed assignment adds a further entry or changes an existing entry:

```
x[abc] := 8:  
x
```

$\overline{1|7}$   
 $abc|8$

```
x := [a, b, c, d]:
x[3] := new:
x
```

$[a, b, \text{new}, d]$

```
x := array(1..2, 1..2):
x[2, 1] := value:
x
```

$\begin{pmatrix} \text{NIL} & \text{NIL} \\ \text{value} & \text{NIL} \end{pmatrix}$

```
delete x:
```

### Example 3

For efficient use of indexed assignments (see “Example 2” on page 1-4 (Symbolic Math Toolbox) for an overview), programmers should note the following rules:

MuPAD® uses *reference counting* and thereby allows multiple references to identical data structures. Changing one of these logically distinct values means that the internal structure must be copied, which takes time:

```
n := 10^4:
L := [0$n]:
time((for i from 1 to n do
    L_old := L:
    L[i] := i:
end_for))
```

19310

Compare this with the situation where only one variable or identifier refers to the internal structure:

```
n := 10^4:
L := [0$n]:
time((for i from 1 to n do
    L[i] := i:
end_for))
```

60

For lists on page 7-41, there is another situation that requires copying the list structure: Changing the length of the list. The most frequently encountered example is appending to a list with `_concat` (`.`) or `append`:

```
n := 10^4:
L := []:
time((for i from 1 to n do
      L := L . [i]:
    end_for))
```

13180

A loop written as above takes running time roughly proportional to the *square of the number of elements*. It is advisable to rewrite such loops. In the case where you know the length of the final list in advance, you can construct such a list and replace its entries inside the loop:

```
n := 10^4:
L := [NIL$n]:
time((for i from 1 to n do
      L[i] := i:
    end_for))
```

60

If you don't know the final length, you can gain linear running time by first collecting the elements into a table on page 1-2103:

```
n := 10^4:
T := table()
time((for i from 1 to n do
      T[nops(T)+1] := i;
    end_for;
    L := [T[i] $ i = 1..nops(T)]))
```

190



## Example 4

Consider a simple procedure:

```
f := x -> sin(x)/x:
f(0)
```

```
Error: Division by zero.
Evaluating: f
```

The following assignment adds an entry to the remember table:

```
f(0) := 1:
f(0)
```

```
1
```

If  $f$  does not evaluate to a function, then a trivial procedure with a remember table is created implicitly:

```
delete f:
f(x) := x^2:
expose(f)
```

```
proc()
  name f;
  option remember;
begin
  procname(args())
end_proc
```

Note that the remember table only provides a result for the input  $x$ :

```
f(x), f(1.0*x), f(y)
```

```
 $x^2$ , f(1.0 x), f(y)
```

```
delete f:
```

## Example 5

The left hand side of an assignment is not evaluated. In the following, `x := 3` assigns a new value to `x`, not to `y`:

```
x := y:  
x := 3:  
x, y
```

3, y

Consequently, the following is not a multiple assignment to the identifiers in the list, but a single assignment to the list `L`:

```
L := [x1, x2]:  
L := [21, 22]:  
L, x1, x2
```

[21, 22], x1, x2

However, indices are evaluated in indexed assignments:

```
i := 2:  
x[i] := value:  
x
```

2 | value

```
for i from 1 to 3 do  
  x[i] := i^2;  
end_for:  
x
```

1 | 1  
2 | 4  
3 | 9

```
delete x, L, i:
```

## Example 6

Since an assignment has a return value (the assigned value), the following command assigns values to several identifiers simultaneously:

```
a := b := c := 42:  
a, b, c
```

```
42, 42, 42
```

For syntactical reasons, the inner assignment has to be enclosed by additional brackets in the following command:

```
a := sin((b := 3)):  
a, b
```

```
sin(3), 3
```

```
delete a, b, c:
```

## Parameters

**x, x1, x2, ...**

Identifiers or indexed identifiers

**value, value1, value2, ...**

Arbitrary MuPAD objects

**f**

A procedure on page 1-2014 (Symbolic Math Toolbox) or a function environment on page 1-1642 (Symbolic Math Toolbox)

**X1, X2, ...**

Arbitrary MuPAD objects

## **Return Values**

value or [value1, value2, ...], respectively.

## **See Also**

### **MuPAD Functions**

anames | assign | assignElements | delete | evalassign

## .\_concat

Concatenate objects

### Syntax

`object1. object2`

`._concat(object1, object2, ...)`

### Description

`object1.object2` concatenates two objects.

`._concat( object1, object2, ...)` concatenates an arbitrary number of objects.

`._concat( object1, object2)` is equivalent to `object1. object2`. The function call `._concat( object1, object2, object3, ...)` is equivalent to `(( object1. object2). object3). ... ._concat()` returns the void object of type `DOM_NULL`.

The following combinations are possible:

<b>object<sub>1</sub></b>	<b>object<sub>2</sub></b>	<b>object<sub>1</sub>. object<sub>2</sub></b>
string	string	string
string	identifier	string
string	integer	string
string	expression	string
identifier	string	identifier
identifier	identifier	identifier
identifier	integer	identifier
identifier	expression	identifier
list	list	list

E.g., `x.1` creates the identifier `x1`.

Note that the objects to be concatenated are evaluated before concatenation. Thus, if  $x := y$ ,  $i := 1$ , the concatenation  $x.i$  produces the identifier  $y1$ . However, the resulting identifier  $y1$  is *not* fully evaluated. Cf. “Example 2” on page 1-13 (Symbolic Math Toolbox).

## Examples

### Example 1

We demonstrate all possible combinations of types that can be concatenated. Strings are produced if the first object is a string:

```
"x"."1", "x".y, "x".1, "x".f(a)
```

```
"x1", "xy", "x1", "xf(a)"
```

Identifiers are produced if the first object is an identifier:

```
x."1", x.y , x.1, x.f(a)
```

```
x1, xy, x1, xf(a)
```

The concatenation operator `.` also serves for concatenating lists:

```
[1, 2] . [3, 4]
```

```
[1, 2, 3, 4]
```

```
L := []; for i from 1 to 10 do L := L . [x.i] end_for: L
```

```
[x1, x2, x3, x4, x5, x6, x7, x8, x9, x10]
```

```
delete L:
```

## Example 2

We demonstrate the evaluation strategy of concatenation. Before concatenation, the objects are evaluated:

```
x := "Val": i := ue: x.i
```

```
"Value"
```

```
ue := 1: x.i
```

```
"Val1"
```

An identifier produced via concatenation is not fully evaluated:

```
delete x: x1 := 17: x.1, eval(x.1)
```

```
x1, 17
```

The . operator can be used to create variables dynamically. They can be assigned values immediately:

```
delete x: for i from 1 to 5 do x.i := i^2 end_for:
```

Again, the result of the concatenation is not fully evaluated:

```
x.i $ i= 1..5
```

```
x1, x2, x3, x4, x5
```

```
eval(%)
```

```
1, 4, 9, 16, 25
```

```
delete i, ue: (delete x.i) $ i = 1..5:
```

### Example 3

The function `_concat` can be used to concatenate an arbitrary number of objects:

```
_concat("an", " ", "ex", "am", "ple")
```

```
"an example"
```

```
_concat("0", " ".i $ i = 1..15)
```

```
"0 1 2 3 4 5 6 7 8 9 10 11 12 13 14 15"
```

```
_concat([], [x.i] $ i = 1..10)
```

```
[x1, x2, x3, x4, x5, x6, x7, x8, x9, x10]
```

### Parameters

**object<sub>1</sub>**

A character string, an identifier, or a list

**object<sub>2</sub>, ...**

A character string, an identifier, an integer, a list, or an expression

### Return Values

Object of the same type as `object1`.

### Overloaded By

`object_1`, `object_2`



## See Also

### MuPAD Functions

@ | append

## `.._range`

Range operator

### Syntax

`l .. r`

`_range(l, r)`

### Description

`l .. r` defines a “range” with the left bound `l` and the right bound `r`.

A range is a technical construct that is used to specify ranges of numbers when calling various system functions such as `int`, `array`, `op`, or the sequence operator `$`. Usually, `l .. r` represents a real interval (e.g., `int(f(x), x = l .. r)`), or the sequence of integers from `l` to `r`.

`_range(l, r)` is equivalent to `l .. r`.

To create and operate on intervals in a mathematical sense, use the data type `Dom::Interval`.

### Examples

#### Example 1

A range can be defined with the `..` operator as well as with a call to the function `_range`:

```
_range(1, 42), 1..42
```

```
1..42, 1..42
```

In the following call, the range represents an interval:

```
int(x, x = l..r)
```

$$\frac{r^2}{2} - \frac{l^2}{2}$$

Ranges can be used for accessing the operands of expressions or to define the size of arrays and hfarrays:

```
op(f(a, b, c, d, e), 2..4)
```

*b, c, d*

```
array(1..3, [a1, a2,a3])
```

*( a1 a2 a3 )*

```
hfarray(1..3, 1..2)
```

$$\begin{pmatrix} 0.0 & 0.0 \\ 0.0 & 0.0 \\ 0.0 & 0.0 \end{pmatrix}$$

Ranges can also be used for creating expression sequences:

```
i^3 $ i = 1..5
```

*1, 8, 27, 64, 125*

## Example 2

The range operator .. is a technical device that does not check its parameters with respect to their semantics. It just creates a range which is interpreted in the context in which it is used later. Any bounds are accepted:

```
float(PI) .. -sqrt(2)/3
```

$$3.141592654.. - \frac{\sqrt{2}}{3}$$

## Parameters

$l, r$

Arbitrary MuPAD objects

## Return Values

Expression of type "`_range`".

## Overloaded By

### See Also

#### **MuPAD Domains**

`Dom::Interval`

#### **MuPAD Functions**

`$`

# `=_equal`

Equations (equal)

## Syntax

`x = y`

`_equal(x, y)`

## Description

`x = y` defines an equation.

`x = y` is equivalent to the function call `_equal(x, y)`.

The operator `=` returns a symbolic expression representing an equation. The resulting expression can be evaluated to `TRUE` or `FALSE` by the function `bool`. It also serves as control conditions in `if`, `repeat`, and `while` statements. In all these cases, testing for equality is a purely syntactical test. For example, `bool(0.5 = 1/2)` returns `FALSE` although both numbers coincide numerically. Further, Boolean expressions can be evaluated to `TRUE`, `FALSE`, or `UNKNOWN` by the function `is`. Tests using `is` are semantic comparing `x` and `y` applying mathematical considerations.

Equations have two operands: the left side and the right side. Use `lhs` and `rhs` to extract these operands.

The boolean expression `not x = y` is always converted to `x <> y`. The expression `not x <> y` is always converted to `x = y`.

## Examples

### Example 1

In the following example, note the difference between syntactical and numerical equality.

The numbers 1.5 and  $\frac{3}{2}$  coincide numerically. However, 1.5 is of domain type `DOM_FLOAT`,

whereas  $\frac{3}{2}$  is of domain type `DOM_RAT`. Consequently, they are not regarded as equal in the following syntactical test:

```
1.5 = 3/2;  
bool(%)
```

$$1.5 = \frac{3}{2}$$

FALSE

For equations with floating-point numbers, use the operator `~=` instead of `=`. The functions `bool` and `is` test whether the floating-point approximations coincide up to the relative precision given by `DIGITS`:

```
1.5 ~= 3/2;  
bool(1.5 ~= 3/2);  
is(1.5 ~= 3/2);
```

$$1.5 \approx \frac{3}{2}$$

TRUE

TRUE

The following expressions coincide syntactically:

```
_equal(1/x, diff(ln(x),x));  
bool(%)
```

$$\frac{1}{x} = \frac{1}{x}$$

TRUE

The Boolean operator `not` converts equalities and inequalities:

not a = b, not a <> b

$a \neq b, a = b$

## Example 2

In this example, use the operator = to compare non-mathematical objects:

```
if "text" = "t"."e"."x"."t" then "yes" else "no" end
```

"yes"

## Example 3

Test equality of these expressions by using the syntactical test via `bool` and the semantic test via `testeq`:

```
bool(1 = x/(x + y) + y/(x + y)),  
testeq(1 = x/(x + y) + y/(x + y))
```

FALSE, TRUE

## Example 4

Equations are typical input objects for system functions, such as `solve`:

```
solve(x^2 - 2*x = -1, x)
```

{1}

## Parameters

**x, y**

Arbitrary MuPAD objects

## Return Values

Expression of type "\_equal".

## See Also

### MuPAD Functions

< | <= | <> | > | >= | FALSE | TRUE | UNKNOWN | and | bool | if | lhs | not | or | repeat |  
rhs | solve | testeql | while | ~=



# `<>_unequal`

Inequalities (unequal)

## Syntax

`x <> y`

`_unequal(x, y)`

## Description

`x <> y` defines an inequality.

`x <> y` is equivalent to the function call `_unequal(x, y)`.

The operator `<>` returns a symbolic expression representing an inequality.

The resulting expression can be evaluated to `TRUE` or `FALSE` by the function `bool`. It also serves as control conditions in `if`, `repeat`, and `while` statements. In all these cases, testing for equality or inequality is a purely syntactical test. For example, `bool(0.5 <> 1/2)` returns `TRUE` although both numbers coincide numerically. Further, Boolean expressions can be evaluated to `TRUE`, `FALSE`, or `UNKNOWN` by the function `is`. Tests using `is` semantically compare `x` and `y` applying mathematical considerations.

Inequalities have two operands: the left side and the right side. Use `lhs` and `rhs` to extract these operands.

The boolean expression `not x = y` is always converted to `x <> y`.

The expression `not x <> y` is always converted to `x = y`.

## Examples

### Example 1

In the following example, note the difference between syntactical and numerical equality. The numbers 1.5 and  $\frac{3}{2}$  coincide numerically. However, 1.5 is of domain type DOM\_FLOAT, whereas  $\frac{3}{2}$  is of domain type DOM\_RAT. Consequently, they are not regarded as equal in the following syntactical test:

```
1.5 <> 3/2;  
bool(%)
```

$1.5 \neq \frac{3}{2}$

TRUE

The following expressions coincide syntactically:

```
_unequal(1/x, diff(ln(x),x));  
bool(%)
```

$\frac{1}{x} \neq \frac{1}{x}$

FALSE

The Boolean operator not converts equalities and inequalities:

```
not a = b, not a <> b
```

$a \neq b, a = b$

### Example 2

In this example, use the operator <> to compare two tables:

```
bool(table(a = PI) <> table(a = sqrt(2)))
```

TRUE

### Example 3

Test equality of these expressions by using the syntactical test via `bool` and the semantical test via `testeq`:

```
bool(1 <> x/(x + y) + y/(x + y)),  
testeq(1 <> x/(x + y) + y/(x + y))
```

TRUE, FALSE

### Example 4

Inequalities are typical input objects for system functions, such as `solve`:

```
solve(x^2 - 2*x <> -1, x)
```

$\mathbb{C} \setminus \{1\}$

## Parameters

**x, y**

Arbitrary MuPAD objects

## Return Values

Expression of type "`_unequal`".

## See Also

### MuPAD Functions

< | <= | = | > | >= | FALSE | TRUE | UNKNOWN | and | bool | if | lhs | not | or | repeat |  
rhs | solve | testeql | while | ~=

## ~=\_approx

Approximate equality

### Syntax

`x ~= y`

`_approx(x, y)`

### Description

`x ~= y` symbolizes approximate equality.

`x ~= y` is equivalent to the function call `_approx(x, y)`.

The operator `~=` returns a symbolic expression representing an approximate equality for numerical values `x` and `y`. The calls `bool(x ~= y)` and `is(x ~= y)` check whether  $|\text{float}((x - y)/x)| < 10^{(-\text{DIGITS})}$  is satisfied, provided  $x \neq 0$  and  $y \neq 0$ . Thus, `TRUE` is returned if `x` and `y` coincide within the relative numerical precision specified by `DIGITS`. For `x = 0`, the criterion is  $|\text{float}(y)| < 10^{(-\text{DIGITS})}$ . For `y = 0`, the criterion is  $|\text{float}(x)| < 10^{(-\text{DIGITS})}$ . If either `x` or `y` contains a symbolic object that cannot be converted to a real or complex floating-point number, the functions `bool` and `is` return the value `UNKNOWN`.

Approximate equalities have two operands: the left side and the right side. Use `lhs` and `rhs` to extract these operands.

---

**Note** `a ~= b` is not equivalent to `a - b ~= 0`.

---

## Examples

### Example 1

In the following example, note the difference between syntactical and numerical equality. The numbers 1.5 and  $\frac{3}{2}$  coincide numerically. However, 1.5 is of domain type DOM\_FLOAT, whereas  $\frac{3}{2}$  is of domain type DOM\_RAT. Consequently, they are not regarded as equal in the following syntactical test:

```
1.5 = 3/2; bool(%)
```

$$1.5 = \frac{3}{2}$$

FALSE

For equations with floating-point numbers, use the operator `~=` instead of `=`. The functions `bool` and `is` test whether the floating-point approximations coincide up to the relative precision given by `DIGITS`:

```
1.5 ~= 3/2;  
bool(1.5 ~= 3/2);  
is(1.5 ~= 3/2);
```

$$1.5 \approx \frac{3}{2}$$

TRUE

TRUE

## Parameters

**x, y**

Arbitrary MuPAD objects

## Return Values

Expression of type "\_approx".

## See Also

### MuPAD Functions

< | <= | <> | = | > | >= | FALSE | TRUE | UNKNOWN | and | bool | if | lhs | not | or |  
repeat | rhs | solve | testeql | while

## **<>\_less**

Inequalities “less than” and “greater than”

### **Syntax**

$x < y$

$x > y$

`_less(x, y)`

### **Description**

$x < y$  and  $x > y$  define inequalities.

$x < y$  represents the Boolean statement “ $x$  is less than  $y$ ”. It is equivalent to the function call `_less(x, y)`.

$x > y$  represents the Boolean statement “ $x$  is greater than  $y$ ”. It is always converted to  $y < x$ , which is equivalent to the function call `_less(y, x)`.

These operators return symbolic Boolean expressions. If only real numbers of `Type::Real` are involved, these expressions can be evaluated to `TRUE` or `FALSE` by the function `bool`. They also serve as control conditions in `if`, `repeat`, and `while` statements. For floating-point intervals on page 7-33, these operators are interpreted as “strictly less than” and “strictly greater than”. See “Example 2” on page 1-31 (Symbolic Math Toolbox). Further, Boolean expressions can be evaluated to `TRUE`, `FALSE`, or `UNKNOWN` by the function `is`. Tests using `is` can also be applied to constant symbolic expressions. See “Example 4” on page 1-32 (Symbolic Math Toolbox).

`bool` also handles inequalities involving character strings. It compares them with respect to the lexicographical ordering.

Inequalities have two operands: the left side and the right side. Use `lhs` and `rhs` to extract these operands.



## Examples

### Example 1

The operators `<` and `>` produce symbolic inequalities. They can be evaluated to `TRUE` or `FALSE` by the function `bool` if only real numbers of type `Type::Real` (integers, rationals, and floats) are involved:

```
1.4 < 3/2;  
bool(%)
```

$$1.4 < \frac{3}{2}$$

`TRUE`

### Example 2

Comparison of intervals is interpreted as “strict”, that is, all combinations of numbers in the intervals must fulfill the relation:

```
bool(0...1 < 2...3),  
bool(0...2 < 1...3),  
bool(0...1 < 1...2)
```

`TRUE, FALSE, FALSE`

### Example 3

Compare character strings:

```
if "text" < "t"."e"."x"."t"."book" then "yes" else "no" end
```

`"yes"`

```
bool("a" > "b")
```

FALSE

### Example 4

Note that `bool` does not perform symbolic simplification and therefore cannot handle some combinations of symbolic expressions. Use the function `is` for comparisons requiring symbolic simplification:

```
bool(sqrt(6) < sqrt(2)*sqrt(3))
```

```
Error: Unable to evaluate to Boolean. [_less]
```

```
is(sqrt(6) < sqrt(2)*sqrt(3))
```

FALSE

### Example 5

Inequalities are valid input objects for the system function `solve`:

```
solve(x^2 - 2*x < 3, x)
```

$(-1, 3) \cup \{1 + yi \mid y \in \mathbb{R}\}$

### Example 6

The operator `<` can be overloaded (Symbolic Math Toolbox) by user-defined domains:

```
myDom := newDomain("myDom");  
myDom::print := x -> extop(x):
```

Without overloading `_less` or `_leequal`, elements of this domain cannot be compared:

```
x := new(myDom, PI):  
y := new(myDom, sqrt(10)):  
bool(x < y)
```

Error: Unable to evaluate to Boolean. [\_less]

Now, define a slot on page 1-1980 "\_less". This slot is called when an inequality of type "\_less" is evaluated by `bool`. The slot compares floating-point approximations if the arguments are not of type `Type::Real`:

```
myDom::_less := proc(x, y)
begin
  x := extop(x, 1);
  y := extop(y, 1);
  if not testtype(x, Type::Real) then
    x := float(x);
    if not testtype(x, Type::Real) then
      error("cannot compare")
    end_if
  end_if;
  if not testtype(y, Type::Real) then
    y := float(y);
    if not testtype(y, Type::Real) then
      error("cannot compare")
    end_if
  end_if;
  bool(x < y)
end_proc;

x, y, bool(x < y), bool(x > y)
```

$\pi$ ,  $\sqrt{10}$ , TRUE, FALSE

```
bool(new(myDom, I) < new(myDom, PI))
```

Error: cannot compare [myDom::\_less]

```
delete myDom, x, y;
```

## Parameters

**x, y**

Arbitrary MuPAD objects

## Return Values

Expression of type "`_less`".

## Overloaded By

`x, y`

## See Also

### MuPAD Functions

`<=` | `<>` | `=` | `>=` | `FALSE` | `TRUE` | `UNKNOWN` | `and` | `bool` | `if` | `lhs` | `not` | `or` | `repeat` | `rhs` | `solve` | `while`

## `<=>=_leequal`

Inequalities “less than or equal to” and “greater than or equal to”

---

**Note** For `<=` in MATLAB®, see `le`.

---

### Syntax

`x <= y`

`x >= y`

`_leequal(x, y)`

### Description

`x <= y` and `x >= y` define inequalities.

`x <= y` represents the Boolean statement “x is less than or equal to y”. It is equivalent to the function call `_leequal(x, y)`.

`x >= y` represents the Boolean statement “x is greater than or equal to y”. It is always converted to `y <= x`, which is equivalent to the function call `_leequal(y, x)`.

These operators return symbolic Boolean expressions. If only real numbers of `Type::Real` are involved, these expressions can be evaluated to `TRUE` or `FALSE` by the function `bool`. They also serve as control conditions in `if`, `repeat`, and `while` statements. For floating-point intervals on page 7-33, these operators are interpreted as “strictly less than or equal to” and “strictly greater than or equal to”. See “Example 2” on page 1-36 (Symbolic Math Toolbox). Further, Boolean expressions can be evaluated to `TRUE`, `FALSE`, or `UNKNOWN` by the function `is`. Tests using `is` can also be applied to constant symbolic expressions. See “Example 4” on page 1-37 (Symbolic Math Toolbox).

`bool` also handles inequalities involving character strings. It compares them with respect to the lexicographical ordering.

Inequalities have two operands: the left side and the right side. Use `lhs` and `rhs` to extract these operands.

## Examples

### Example 1

The operators `<=` and `>=` produce symbolic inequalities. They can be evaluated to `TRUE` or `FALSE` by the function `bool` if only real numbers of type `Type: :Real` (integers, rationals, and floats) are involved:

```
1.5 <= 3/2; bool(%)
```

$$1.5 \leq \frac{3}{2}$$

`TRUE`

### Example 2

Comparison of intervals is interpreted as “strict”, that is, all combinations of numbers in the intervals must fulfill the relation:

```
bool(0...1 <= 2...3), bool(0...2 <= 1...3),  
bool(0...1 <= 1...2)
```

`TRUE, FALSE, TRUE`

### Example 3

Compare character strings:

```
if "text" <= "t"."e"."x"."t"."book" then "yes" else "no" end
```

`"yes"`

```
bool("a" >= "b")
```

FALSE

### Example 4

Note that `bool` does not perform symbolic simplification and therefore cannot handle some combinations of symbolic expressions; the function `is` does perform symbolic simplification:

```
bool(sqrt(6) <= sqrt(2)*sqrt(3))
```

Error: Unable to evaluate to Boolean. [`_leequal`]

```
is(sqrt(6) <= sqrt(2)*sqrt(3))
```

TRUE

### Example 5

Inequalities are valid input objects for the system function `solve`:

```
solve(x^2 - 2*x >= 3, x)
```

$(-\infty, -1] \cup [3, \infty)$

### Example 6

The operator `<=` can be overloaded (Symbolic Math Toolbox) by user-defined domains:

```
myDom := newDomain("myDom");  
myDom::print := x -> extop(x):
```

Without overloading `_leequal`, elements of this domain cannot be compared:

```
x := new(myDom, PI):  
y := new(myDom, sqrt(10)):  
bool(x <= y)
```

Error: Unable to evaluate to Boolean. [\_leequal]

Now, a slot on page 1-1980 "\_less" is defined. It is called, when an inequality of type "\_less" is evaluated by `bool`. The slot compares floating-point approximations if the arguments are not of type `Type::Real`:

```
myDom::_leequal := proc(x, y)
begin
  x := extop(x, 1):
  y := extop(y, 1):
  if not testtype(x, Type::Real) then
    x := float(x):
    if not testtype(x, Type::Real) then
      error("cannot compare")
    end_if
  end_if:
  if not testtype(y, Type::Real) then
    y := float(y):
    if not testtype(y, Type::Real) then
      error("cannot compare")
    end_if
  end_if:
  bool(x <= y)
end_proc:

x, y, bool(x <= y), bool(x >= y)
```

$\pi$ ,  $\sqrt{10}$ , TRUE, FALSE

```
bool(new(myDom, I) <= new(myDom, PI))
```

Error: cannot compare [myDom::\_leequal]

```
delete myDom, x, y:
```

## Parameters

**x, y**

Arbitrary MuPAD objects



## Return Values

Expression of type "`_leequal`".

## Overloaded By

`x, y`

## See Also

### MuPAD Functions

`< | <> | = | > | FALSE | TRUE | UNKNOWN | and | bool | if | lhs | not | or | repeat | rhs | solve | while`

## **+\_plus**

Add expressions

### **Syntax**

$x + y + \dots$

`_plus(x, y, ...)`

### **Description**

$x + y + \dots$  computes the sum of  $x$ ,  $y$  etc.

$x + y + \dots$  is equivalent to the function call `_plus(x, y, ...)`.

All terms that are numbers of type `Type::Numeric` are automatically combined to a single number.

Terms of a symbolic sum may be rearranged internally. Cf. “Example 1” on page 1-42 (Symbolic Math Toolbox). The user can control the ordering by the preference `Pref::keepOrder`. See also the documentation for `print`.

`_plus` accepts an arbitrary number of arguments. In conjunction with the sequence operator `$`, this function is the recommended tool for computing finite sums. Cf. “Example 2” on page 1-42 (Symbolic Math Toolbox). The function `sum` may also serve for computing such sums. However, `sum` is designed for the computation of symbolic and infinite sums. It is slower than `_plus`.

$x - y$  is internally represented as  $x + y*(-1) = \_plus(x, \_mult(y, -1))$ . See `_subtract` for details.

For adding equalities on page 1-19, inequalities on page 1-23, and comparisons on page 1-30, the following rules are implemented:

- Adding an arithmetical expression adds the expression to both sides.
- Adding an equality adds the left hand sides and the right hand sides separately.

- Adding a comparison does likewise, taking care of the correct operator. Adding a comparison to an inequality is not permitted.

Cf. “Example 4” on page 1-43 (Symbolic Math Toolbox).

Many library domains (Symbolic Math Toolbox) overload `_plus` by an appropriate slot on page 1-1980 “`_plus`”. Sums involving elements of library domains are processed as follows:

A sum  $x + y + \dots$  is searched for elements of library domains from left to right. Let  $z$  be the first term that is not of one of the basic types provided by the kernel (numbers, expressions, etc.). If the domain  $d = z :: \text{dom} = \text{domtype}(z)$  has a slot on page 1-1980 “`_plus`”, it is called in the form  $d :: \text{+_plus}(x, y, \dots)$ . The result returned by  $d :: \text{+_plus}$  is the result of  $x + y + \dots$ .

Users should implement the slot  $d :: \text{+_plus}$  of their domains  $d$  according to the following convention:

- If all terms are elements of  $d$ , an appropriate sum of type  $d$  should be returned.
- If at least one term cannot be converted to an element of  $d$ , the slot should return `FAIL`.
- Care must be taken if there are terms that are not of type  $d$ , but can be converted to type  $d$ . Such terms should be converted only if the mathematical semantics is obvious to any user who uses this domain as a 'black box' (e.g., integers may be regarded as rational numbers because of the natural mathematical embedding). If in doubt, the “`_plus`” method should return `FAIL` instead of using implicit conversions. If implicit conversions are used, they must be well-documented.

Cf. “Example 6” on page 1-45 (Symbolic Math Toolbox) and “Example 7” on page 1-46 (Symbolic Math Toolbox).

Most of the library domains in the MuPAD standard installation comply with this convention.

`_plus()` returns the number 0.

Polynomials of type `DOM_POLY` are added by `+`, if they have the same indeterminates and the same coefficient ring.

For finite sets  $X, Y$ , the sum  $X + Y$  is the set  $\{x + y \mid x \in X, y \in Y\}$ .

## Examples

### Example 1

Numerical terms are simplified automatically:

```
3 + x + y + 2*x + 5*x - 1/2 - sin(4) + 17/4
```

$$8x + y - \sin(4) + \frac{27}{4}$$

The ordering of the terms of a sum is not necessarily the same as on input:

```
x + y + z + a + b + c
```

$$a + b + c + x + y + z$$

```
1 + x + x^2 + x^10
```

$$x^{10} + x^2 + x + 1$$

Internally, this sum is a symbolic call of `_plus`:

```
op(%, 0), type(%)
```

```
_plus, "_plus"
```

### Example 2

The functional equivalent `_plus` of the operator `+` is a handy tool for computing finite sums. In the following, the terms are generated via the sequence operator `$`:

```
_plus(i^2 $ i = 1..100)
```

```
338350
```

E.g., it is easy to add up all elements in a set:

```
S := {a, b, 1, 2, 27}: _plus(op(S))
```

$$a + b + 30$$

The following command “zips” on page 1-2259 two lists by adding corresponding elements:

```
L1 := [a, b, c]: L2 := [1, 2, 3]: zip(L1, L2, _plus)
```

$$[a + 1, b + 2, c + 3]$$

```
delete S, L1, L2:
```

### Example 3

Polynomials of type DOM\_POLY are added by +, if they have the same indeterminates and the same coefficient ring:

```
poly(x^2 + 1, [x]) + poly(x^2 + x - 1, [x])
```

$$\text{poly}(2x^2 + x, [x])$$

If the indeterminates or the coefficient rings do not match, \_plus returns an error:

```
poly(x, [x]) + poly(x, [x, y])
```

```
Error: Invalid argument. [_plus]
```

```
poly(x, [x]) + poly(x, [x], Dom::Integer)
```

```
Error: Invalid argument. [_plus]
```

### Example 4

Adding a constant to an equality, an inequality, or a comparison amounts to adding it to both sides:

```
(a = b) + c, (a <> b) + c, (a <= b) + c, (a < b) + c
```

$$a + c = b + c, a + c \neq b + c, a + c \leq b + c, a + c < b + c$$

Adding an equality is performed by adding the left hand sides and the right hand sides separately:

$$(a = b) + (c = d), (a \langle \rangle b) + (c = d), \\ (a \leq b) + (c = d), (a < b) + (c = d)$$

$$a + c = b + d, a + c \neq b + d, a + c \leq b + d, a + c < b + d$$

Inequalities can only be added to equalities:

$$(a = b) + (c \langle \rangle d), (a \langle \rangle b) + (c \langle \rangle d), \\ (a \leq b) + (c \langle \rangle d), (a < b) + (c \langle \rangle d)$$

$$a + c \neq b + d, \text{ FAIL, FAIL, FAIL}$$

The addition of comparisons takes of the difference between  $<$  and  $\leq$  into account. Note that MuPAD uses only these two comparison operators;  $a > b$  and  $a \geq b$  are automatically rewritten:

$$(a = b) + (c \leq d), (a \langle \rangle b) + (c \leq d), \\ (a \leq b) + (c \leq d), (a < b) + (c \leq d);$$

$$a + c \leq b + d, \text{ FAIL, } a + c \leq b + d, a + c < b + d$$

$$(a = b) + (c < d), (a \langle \rangle b) + (c < d), \\ (a \leq b) + (c < d), (a < b) + (c < d);$$

$$a + c < b + d, \text{ FAIL, } a + c < b + d, a + c < b + d$$

$$(a = b) + (c \geq d), (a \langle \rangle b) + (c \geq d), \\ (a \leq b) + (c \geq d), (a < b) + (c \geq d);$$

$$a + d \leq b + c, \text{ FAIL, } a + d \leq b + c, a + d < b + c$$

$$(a = b) + (c > d), (a \langle \rangle b) + (c > d), \\ (a \leq b) + (c > d), (a < b) + (c > d);$$

$a + d < b + c$ , FAIL,  $a + d < b + c$ ,  $a + d < b + c$

## Example 5

For finite sets  $X, Y$ , the sum  $X + Y$  is the set  $\{x + y \mid x \in X, y \in Y\}$ :

$\{a, b, c\} + \{1, 2\}$

$\{a + 1, a + 2, b + 1, b + 2, c + 1, c + 2\}$

## Example 6

Various library domains such as matrix on page 7-252 domains overload `_plus`:

```
x := Dom::Matrix(Dom::Integer)([1, 2]):
y := Dom::Matrix(Dom::Rational)([2, 3]):
x + y, y + x
```

$\begin{pmatrix} 3 \\ 5 \end{pmatrix}, \begin{pmatrix} 3 \\ 5 \end{pmatrix}$

If the terms in a sum  $x + y$  are of different type, the first term  $x$  tries to convert  $y$  to the data type of  $x$ . If successful, the sum is of the same type as  $x$ . In the previous example,  $x$  and  $y$  have different types (both are matrices, but the component domains differ). Hence the sums  $x + y$  and  $y + x$  differ syntactically, because they inherit their type from the first term:

```
bool(x + y = y + x)
```

FALSE

```
domtype(x + y), domtype(y + x)
```

Dom::Matrix(Dom::Integer), Dom::Matrix(Dom::Rational)

If  $x$  does not succeed to convert  $y$ , then FAIL is returned. In the following call, the component  $2/3$  cannot be converted to an integer:

```
y := Dom::Matrix(Dom::Rational)([2/3, 3]): x + y
```

FAIL

```
delete x, y:
```

## Example 7

This example demonstrates how to implement a slot on page 1-1980 "`_plus`" for a domain. The following domain `myString` is to represent character strings. The sum of such strings is to be the concatenation of the strings.

The "`new`" method uses `expr2text` to convert any MuPAD object to a string. This string is the internal representation of elements of `myString`. The "`print`" method turns this string into the screen output:

```
myString := newDomain("myString"):
myString::new := proc(x)
begin
  if args(0) = 0 then x := "": end_if;
  case domtype(x)
  of myString do return(x);
  of DOM_STRING do return(new(dom, x));
  otherwise return(new(dom, expr2text(x)));
  end_case
end_proc:
myString::print := x -> extop(x, 1):
```

Without a "`_plus`" method, the system function `_plus` handles elements of this domain like any symbolic object:

```
y := myString(y): z := myString(z): 1 + x + y + z + 3/2
```

$$x + y + z + \frac{5}{2}$$

Now, we implement the "`_plus`" method. It checks all arguments. Arguments are converted, if they are not of type `myString`. Generally, such an implicit conversion should be avoided. In this case, however, any object has a corresponding string representation via `expr2text` and an implicit conversion is implemented. Finally, the sum of `myString` objects is defined as the concatenation of the internal strings:



```

myString::_plus := proc()
local n, Arguments, i;
begin
  print(Unquoted, "Info: myString::_plus called with the arguments:",
        args());
  n := args(0);
  Arguments := [args()];
  for i from 1 to n do
    if domtype(Arguments[i]) <> myString then
      // convert the i-th term to myString
      Arguments[i] := myString::new(Arguments[i]);
    end_if;
  end_for;
  myString::new(_concat(extop(Arguments[i], 1) $ i = 1..n))
end_proc:

```

Now, myString objects can be added:

```
myString("This ") + myString("is ") + myString("a string")
```

```
Info: myString::_plus called with the arguments:, This , is , a string
```

This is a string

In the following sum, y and z are elements of myString. The term y is the first term that is an element of a library domain. Its "\_plus" method is called and concatenates all terms to a string of type myString:

```
1 + x + y + z + 3/2;
```

```
Info: myString::_plus called with the arguments:, 1, x, y, z, -
3
2
```

1xyz3/2

```
delete myString, y, z:
```

## Parameters

**x, y, ...**

arithmetical expressions (Symbolic Math Toolbox), polynomials on page 1-431 (Symbolic Math Toolbox) of type `DOM_POLY`, sets on page 7-50, equations on page 1-19, inequalities on page 1-23, or comparisons on page 1-30

## Return Values

Arithmetical expression, a polynomial, a set, an equation, an inequality, or a comparison.

## Overloaded By

x, y

## See Also

### **MuPAD Functions**

\* | - | / | Pref::keepOrder | ^ | \_invert | \_subtract | poly | sum

## **-\_negate**

Negative of an expression

### **Syntax**

- x

`_negate(x)`

### **Description**

- x computes the negative of x.

-x is equivalent to the function call `_negate(x)`. Both calls represent the inverse of the element x of an additive group.

The negative of a number of type `Type::Numeric` is also a number.

If x is an element of a domain that does not have the `_negate` method (slot on page 1-1980), MuPAD internally represents -x as  $x*(-1) = \text{\_mult}(x, -1)$ .

If x is an element of a domain that has the `_negate` method (slot on page 1-1980), MuPAD uses this method to compute -x.

The difference  $x - y$  is equivalent to  $x + (-y) = \text{\_plus}(x, \text{\_negate}(y))$ .

The negative of a polynomial of type `DOM_POLY` produces a polynomial. The coefficients of the resulting polynomial are the negatives of the original coefficients.

For finite sets, -X is the set  $\{-x \mid x \in X\}$ .

## Examples

### Example 1

Compute the negatives of the following expressions. The negative of an expression is the inverse with respect to + (`_plus`):

```
x - x = x + _negate(x)
```

```
0 = 0
```

```
-1 + x - 2*x + 23
```

```
22 - x
```

### Example 2

Internally, MuPAD represents `-x` as `_mult(x, -1)`:

```
type(-x), op(-x, 0), op(-x, 1), op(-x, 2)
```

```
"_mult", _mult, x, -1
```

### Example 3

Compute the negative of a polynomial. The result is a polynomial with the coefficients that are the negatives of the coefficients of the original polynomial:

```
-poly(x^2 + x - 1, [x])
```

```
poly(-x^2 - x + 1, [x])
```

```
-poly(x, [x], Dom::Integer)
```

```
poly(-x, [x], Dom::Integer)
```

## Example 4

Compute the negative of a finite set. For finite sets,  $-X$  is the set  $\{-x \mid x \in X\}$ :

`-{a, b, c}`

$$\{-a, -b, -c\}$$

## Example 5

Various library domains such as matrix on page 7-252 domains or residue class on page 7-216 domains overload `_negate`:

`x := Dom::Matrix(Dom::IntegerMod(7))([2, 10]): x, -x, x + (-x)`

$$\begin{pmatrix} 2 \bmod 7 \\ 3 \bmod 7 \end{pmatrix}, \begin{pmatrix} 5 \bmod 7 \\ 4 \bmod 7 \end{pmatrix}, \begin{pmatrix} 0 \bmod 7 \\ 0 \bmod 7 \end{pmatrix}$$

`delete x:`

## Parameters

`x`

An arithmetical expression (Symbolic Math Toolbox), a polynomial on page 1-431 (Symbolic Math Toolbox) of type `DOM_POLY`, or a set on page 7-50

## Return Values

Arithmetical expression, a polynomial, or a set.

## Overloaded By

`x`

## See Also

### MuPAD Functions

\* | + | / | ^ | \_invert | \_subtract | poly

## \*\_mult

Multiply expressions

### Syntax

$x * y * \dots$

`_mult(x, y, ...)`

### Description

$x * y * \dots$  computes the product of  $x$ ,  $y$  etc.

$x * y * \dots$  is equivalent to the function call `_mult(x, y, ...)`.

All terms that are numbers of type `Type::Numeric` are automatically combined to a single number.

The terms of a symbolic product may be rearranged internally if no term belongs to a library domain that overloads `_mult`: on terms composed of kernel domains (numbers, identifiers, expressions etc.), multiplication is assumed to be commutative. Cf. “Example 1” on page 1-54 (Symbolic Math Toolbox).

Via overloading (Symbolic Math Toolbox), the user can implement a non-commutative product for special domains (Symbolic Math Toolbox).

`_mult` accepts an arbitrary number of arguments. In conjunction with the sequence operator `$`, this function is the recommended tool for computing finite products. Cf. “Example 2” on page 1-55 (Symbolic Math Toolbox). The function `product` may also serve for computing such products. However, `product` is designed for the computation of symbolic and infinite products. It is slower than `_mult`.

The quotient  $x/y$  is internally represented as  $x * (1/y) = \text{\_mult}(x, \text{\_power}(y, -1))$ . See `_divide` for details.

Many library domains (Symbolic Math Toolbox) overload `_mult` by an appropriate slot on page 1-1980 "`_mult`". Products involving elements of library domains are processed as follows:

A product `x * y * ...` is searched for elements of library domains from left to right. Let `z` be the first term that is not of one of the basic types provided by the kernel (numbers, expressions, etc.). If the domain `d = z::dom = domtype(z)` has a slot on page 1-1980 "`_mult`", it is called in the form `d::_mult(x, y, ...)`. The result returned by `d::_mult` is the result of `x * y * ...`.

Cf. "Example 6" on page 1-59 (Symbolic Math Toolbox) and "Example 7" on page 1-60 (Symbolic Math Toolbox).

`_mult()` returns the number 1.

Polynomials of type `DOM_POLY` are multiplied by `*`, if they have the same indeterminates and the same coefficient ring. Use `multcoeffs` to multiply polynomials with scalar factors.

For finite sets  $X, Y$ , the product  $X * Y$  is the set  $\{xy \mid x \in X, y \in Y\}$ .

Equalities on page 1-19, inequalities on page 1-23, and comparisons on page 1-30 can be multiplied with one another or with arithmetical expressions. The results of such combinations are demonstrated in "Example 5" on page 1-57 (Symbolic Math Toolbox).

## Examples

### Example 1

Numerical terms are simplified automatically:

```
3 * x * y * (1/18) * sin(4) * 4
```

$$\frac{2 x y \sin(4)}{3}$$

The ordering of the terms of a product is not necessarily the same as on input:

```
x * y * 3 * z * a * b * c
```



```
3 a b c x y z
```

Internally, this product is a symbolic call of `_mult`:

```
op(%, 0), type(%)
```

```
_mult, "_mult"
```

Note that the screen output does not necessarily reflect the internal order of the terms in a product:

```
op(%2)
```

```
a, b, c, x, y, z, 3
```

In particular, a numerical factor is internally stored as the last operand on page 1-1493. On the screen, a numerical factor is displayed in front of the remaining terms:

```
3 * x * y * 4
```

```
12 x y
```

```
op(%)
```

```
x, y, 12
```

## Example 2

The functional equivalent `_mult` of the operator `*` is a handy tool for computing finite products. In the following, the terms are generated via the sequence operator `$`:

```
_mult(i $ i = 1..20)
```

```
2432902008176640000
```

E.g., it is easy to multiply all elements in a set:

```
S := {a, b, 1, 2, 27}: _mult(op(S))
```

$54 a b$

The following command “zips” on page 1-2259 two lists by multiplying corresponding elements:

```
L1 := [1, 2, 3]: L2 := [a, b, c]: zip(L1, L2, _mult)
```

$[a, 2 b, 3 c]$

```
delete S, L1, L2:
```

### Example 3

Polynomials of type DOM\_POLY are multiplied by \*, if they have the same indeterminates and the same coefficient ring:

```
poly(x^2 + 1, [x]) * poly(x^2 + x - 1, [x])
```

$\text{poly}(x^4 + x^3 + x - 1, [x])$

If the indeterminates or the coefficient rings do not match, \_mult returns an error:

```
poly(x, [x]) * poly(x, [x, y])
```

Error: Invalid argument. [\_mult]

```
poly(x, [x]) * poly(x, [x], Dom::Integer)
```

Error: Invalid argument. [\_mult]

Using \*, you can multiply polynomials by scalar factors:

```
2 * y * poly(x, [x])
```

$\text{poly}((2 y) x, [x])$

Use `multcoeffs` instead:

```
multcoeffs(poly(x^2 - 2, [x]), 2*y)
```

$$\text{poly}((2 y) x^2 - 4 y, [x])$$

### Example 4

For finite sets  $X, Y$ , the product  $X * Y$  is the set  $\{x y \mid x \in X, y \in Y\}$ :

```
{a, b, c} * {1, 2}
```

$$\{a, b, c, 2 a, 2 b, 2 c\}$$

Note that complex numbers of type `DOM_INT`, `DOM_RAT`, `DOM_COMPLEX`, `DOM_FLOAT`, and identifiers are implicitly converted to one-element sets:

```
2 * {a, b, c}
```

$$\{2 a, 2 b, 2 c\}$$

```
a * {b, c}, PI * {3, 4}
```

$$\{a b, a c\}, \{3 \pi, 4 \pi\}$$

### Example 5

Multiplying by a constant expression is performed on both sides of an equation:

```
(a = b) * c
```

$$a c = b c$$

For inequalities, this step is only performed if the constant is known to be non-zero:

```
assume(d <> 0):  
(a <> b) * c, (a <> b) * d;  
delete d:
```

$$(a \neq b) c, a d \neq b d$$

The multiplication of a comparison with a constant is only defined for real numbers. Even for these, the result depends on the sign of the constant, since multiplication with a negative constant changes the direction of the comparison:

```
(a < b) * 2, (a < b) * (-3)
```

$$2 a < 2 b, -3 b < -3 a$$

```
(a < b) * I
```

Error: Inequalities must not be multiplied by complex numbers. [\_less::\_mult]

```
(a < b) * c, (a <= b) * c
```

$$\begin{cases} a c < b c & \text{if } 0 < c \\ b c < a c & \text{if } c < 0 \end{cases} \quad \begin{cases} a c \leq b c & \text{if } 0 \leq c \\ b c \leq a c & \text{if } c \leq 0 \end{cases}$$

Multiplication of two equalities is performed by multiplying the left hand sides and the right hand sides separately:

```
(a = b) * (c = d)
```

$$a c = b d$$

Inequalities cannot be multiplied with one another or with comparisons; multiplication with equalities is, however, defined, if at least one operand of the equation is known to be non-zero:

```
assume(d <> 0):  
(a <> b) * (c = d);  
delete d:
```

$$a c \neq b d$$

In other cases, the product is not expanded:

```
delete c, d:
(a <> b) * (c = d)
```

$$(a \neq b) (c = d)$$

Multiplication of comparisons with equalities and comparisons is performed similar to the cases above:

```
assume(c > 0):
(a < b) * (c = d);
delete c:
```

$$a c < b d$$

```
(a <= b) * (c <= d)
```

$$\begin{cases} a c \leq b d & \text{if } 0 \leq c \wedge 0 \leq d \\ b d \leq a c & \text{if } c \leq 0 \wedge d \leq 0 \end{cases}$$

## Example 6

Various library domains such as matrix on page 7-252 domains overload `_mult`. The multiplication is not commutative:

```
x := Dom::Matrix(Dom::Integer)([[1, 2], [3, 4]]):
y := Dom::Matrix(Dom::Rational)([[10, 11], [12, 13]]):
x * y, y * x
```

$$\begin{pmatrix} 34 & 37 \\ 78 & 85 \end{pmatrix}, \begin{pmatrix} 43 & 64 \\ 51 & 76 \end{pmatrix}$$

If the terms in `x * y` are of different type, the first term `x` tries to convert `y` to the data type of `x`. If successful, the product is of the same type as `x`. In the previous example, `x`

and  $y$  have different types (both are matrices, but the component domains differ). Hence  $x * y$  and  $y * x$  have different types that is inherited from the first term:

```
domtype(x * y), domtype(y * x)
```

```
Dom::Matrix(Dom::Integer), Dom::Matrix(Dom::Rational)
```

If  $x$  does not succeed to convert  $y$ , then  $y$  tries to convert  $x$ . In the following call, the component  $27/2$  cannot be converted to an integer. Consequently, in  $x * y$ , the term  $y$  converts  $x$  and produces a result that coincides with the domain type of  $y$ :

```
y := Dom::Matrix(Dom::Rational)([[10, 11], [12, 27/2]]):  
x * y, y * x
```

$$\begin{pmatrix} 34 & 38 \\ 78 & 87 \end{pmatrix}, \begin{pmatrix} 43 & 64 \\ \frac{105}{2} & 78 \end{pmatrix}$$

```
domtype(x * y), domtype(y * x)
```

```
Dom::Matrix(Dom::Rational), Dom::Matrix(Dom::Rational)
```

```
delete x, y:
```

## Example 7

This example demonstrates how to implement a slot on page 1-1980 "`_mult`" for a domain. The following domain `myString` is to represent character strings. Via overloading of `_mult`, integer multiples of such strings should produce the concatenation of an appropriate number of copies of the string.

The "`new`" method uses `expr2text` to convert any MuPAD object to a string. This string is the internal representation of elements of `myString`. The "`print`" method turns this string into the screen output:

```
myString := newDomain("myString"):  
myString::new := proc(x)  
begin  
  if args(0) = 0 then x := "": end_if;  
  case domtype(x)
```

```

    of myString do return(x);
    of DOM_STRING do return(new(dom, x));
    otherwise return(new(dom, expr2text(x)));
  end_case
end_proc:
myString::print := x -> extop(x, 1):

```

Without a "\_mult" method, the system function \_mult handles elements of this domain like any symbolic object:

```

y := myString(y):
z := myString(z):
4 * x * y * z * 3/2

```

*6 x y z*

Now, we implement the "\_mult" method. It uses `split` to pick out all integer terms in its argument list and multiplies them. The result is an integer `n`. If there is exactly one other term left (this must be a string of type `myString`), it is copied `n` times. The concatenation of the copies is returned:

```

myString::_mult:= proc()
local Arguments, intfactors, others, dummy, n;
begin
  print(Unquoted, "Info: myString::_mult called with the arguments:",
        args());
  Arguments := [args()];
  // split the argument list into integers and other factors:
  [intfactors, others, dummy] :=
    split(Arguments, testtype, DOM_INT);
  // multiply all integer factors:
  n := _mult(op(intfactors));
  if nops(others) <> 1 then
    return(FAIL)
  end_if;
  myString::new(_concat(extop(others[1], 1) $ n))
end_proc:

```

Now, integer multiples of `myString` objects can be constructed via the `*` operator:

```
2 * myString("string") * 3
```

*Info: myString::\_mult called with the arguments:, 2, string, 3*

stringstringstringstringstringstring

Only products of integers and myString objects are allowed:

```
3/2 * myString("a ") * myString("string")
```

```
Info: myString::_mult called with the arguments:, -, a , string
3
2
```

FAIL

```
delete myString, y, z:
```

## Parameters

**x, y, ...**

arithmetical expressions (Symbolic Math Toolbox), polynomials on page 1-431 (Symbolic Math Toolbox) of type DOM\_POLY, sets on page 7-50, equations on page 1-19, inequalities on page 1-23, or comparisons on page 1-30

## Return Values

Arithmetical expression, a polynomial, a set, an equation, an inequality, or a comparison.

## Overloaded By

x, y



## See Also

### MuPAD Functions

+ | - | / | ^ | \_invert | \_subtract | poly | product

## **/\_divide**

Divide expressions

### **Syntax**

$x / y$

`_divide(x, y)`

### **Description**

$x/y$  computes the quotient of  $x$  and  $y$ .

$x/y$  is equivalent to the function call `_divide(x, y)`.

For numbers of type `Type::Numeric`, the quotient is returned as a number.

If neither  $x$  nor  $y$  are elements of library domains (Symbolic Math Toolbox) with "`_divide`" methods,  $x/y$  is internally represented as  $x * y^{-1} = \text{\_mult}(x, \text{\_power}(y, -1))$ .

If  $x$  or  $y$  is an element of a domain with a slot on page 1-1980 "`_divide`", then this method is used to compute  $x/y$ . Many library domains (Symbolic Math Toolbox) overload the `/` operator by an appropriate "`_divide`" slot. Quotients are processed as follows:

$x/y$  is searched for elements of library domains from left to right. Let  $z$  (either  $x$  or  $y$ ) be the first term that is not of one of the basic types provided by the kernel (numbers, expressions, etc.). If the domain  $d = z::\text{dom} = \text{domtype}(z)$  has a slot on page 1-1980 "`_divide`", it is called in the form `d::_divide(x, y)`. The result returned by `d::_divide` is the result of  $x/y$ .

Cf. examples "Example 4" on page 1-66 (Symbolic Math Toolbox) and "Example 5" on page 1-67 (Symbolic Math Toolbox).

Polynomials of type `DOM_POLY` can be divided by `/`, if they have the same indeterminates and the same coefficient ring, and if exact division is possible. The function `divide` can be used to compute the quotient of polynomials with a remainder term.

For finite sets  $X, Y$ , the quotient  $X/Y$  is the set  $\left\{ \frac{x}{y} \mid x \in X, y \in Y \right\}$ .

## Examples

### Example 1

The quotient of numbers is simplified to a number:

`1234/234, 7.5/7, 6*I/2`

`$\frac{617}{117}$ , 1.071428571, 3 i`

Internally, a symbolic quotient  $x/y$  is represented as the product  $x * y^{(-1)}$ :

`type(x/y), op(x/y, 0), op(x/y, 1), op(x/y, 2)`

`"_mult", _mult, x,  $\frac{1}{y}$`

`op(op(x/y, 2), 0), op(op(x/y, 2), 1), op(op(x/y, 2), 2)`

`_power, y, -1`

### Example 2

For finite sets  $X, Y$ , the quotient  $X/Y$  is the set  $\left\{ \frac{x}{y} \mid x \in X, y \in Y \right\}$ :

`{a, b, c} / {2, 3}`

`$\left\{ \frac{a}{2}, \frac{a}{3}, \frac{b}{2}, \frac{b}{3}, \frac{c}{2}, \frac{c}{3} \right\}$`

### Example 3

Polynomials of type `DOM_POLY` can be divided by `/` if they have the same indeterminates, the same coefficient ring, and if exact division is possible:

```
poly(x^2 - 1, [x]) / poly(x - 1, [x])
```

```
poly(x + 1, [x])
```

```
poly(x^2 - 1, [x]) / poly(x - 2, [x])
```

```
FAIL
```

The function `divide` provides division with a remainder:

```
divide(poly(x^2 - 1, [x]), poly(x - 2, [x]))
```

```
poly(x + 2, [x]), poly(3, [x])
```

The polynomials must have the same indeterminates and the same coefficient ring:

```
poly(x^2 - 1, [x, y]) / poly(x - 1, [x])
```

```
Error: Invalid argument. [divide]
```

### Example 4

Various library domains such as `matrix` on page 7-252 domains overload `_divide`. The `matrix` domain defines `x/y` as `x * (1/y)`, where `1/y` is the inverse of `y`:

```
x := Dom::Matrix(Dom::Integer)([[1, 2], [3, 4]]):  
y := Dom::Matrix(Dom::Rational)([[10, 11], [12, 13]]):  
x/y
```

```

$$\begin{pmatrix} \frac{11}{2} & -\frac{9}{2} \\ \frac{9}{2} & -\frac{7}{2} \end{pmatrix}$$

```

The inverse of  $x$  has rational entries. Therefore,  $1/x$  returns FAIL, because the component ring of  $x$  is  $\text{Dom}::\text{Integer}$ . Consequently, also  $y/x$  returns FAIL:

$y/x$

FAIL

delete  $x, y$ :

## Example 5

This example demonstrates the behavior of `_divide` on user-defined domains. In the first case below, the user-defined domain does not have a `"_divide"` slot on page 1-1980. Thus  $x/y$  is transformed to  $x * (1/y)$ :

```
Do := newDomain("Do"): x := new(Do, 1): y := new(Do, 2):
x/y; op(x/y, 0..2)
```

$$\frac{\text{new}(\text{Do}, 1)}{\text{new}(\text{Do}, 2)}$$

$$\_mult, \text{new}(\text{Do}, 1), \frac{1}{\text{new}(\text{Do}, 2)}$$

After the slot on page 1-1980 `"_divide"` is defined in the domain `Do`, this method is used to divide elements:

```
Do::_divide := proc() begin "The Result" end: x/y
```

"The Result"

delete `Do, x, y`:

## Parameters

$x, y, \dots$

arithmetical expressions (Symbolic Math Toolbox), polynomials on page 1-431 (Symbolic Math Toolbox) of type `DOM_POLY`, or sets on page 7-50

## Return Values

Arithmetical expression, a polynomial, or a set.

## Overloaded By

$x, y$

## See Also

### **MuPAD Functions**

`*` | `+` | `-` | `^` | `_invert` | `_subtract` | `div` | `divide` | `pdivide` | `poly`

## ^\_power

Raise an expression to a power

---

**Note** For the power function in MATLAB®, see `power`.

---

### Syntax

$x \wedge y$

`_power(x, y)`

### Description

$x \wedge y$  computes the  $y$ -th power of  $x$ .

$x \wedge y$  is equivalent to the function call `_power(x, y)`.

The power operator  $\wedge$  is left associative:  $x \wedge y \wedge z$  is parsed as  $(x \wedge y) \wedge z$ . Cf. “Example 2” on page 1-71 (Symbolic Math Toolbox).

If  $x$  is a polynomial of type `DOM_POLY`, then  $y$  must be a nonnegative integer smaller than  $2^{31}$ .

`_power` is overloaded (Symbolic Math Toolbox) for matrix domains on page 7-252 (`matrix`). In particular,  $x \wedge (-1)$  returns the inverse of the matrix  $x$ .

Use `powermod` to compute modular powers. Cf. “Example 3” on page 1-71 (Symbolic Math Toolbox).

Mathematically, the call `sqrt(x)` is equivalent to  $x \wedge (1/2)$ . Note, however, that `sqrt` tries to simplify the result. Cf. “Example 4” on page 1-71 (Symbolic Math Toolbox).

If  $x$  or  $y$  is an element of a domain with a slot on page 1-1980 “`_power`”, then this method is used to compute  $x \wedge y$ . Many library domains (Symbolic Math Toolbox) overload the  $\wedge$  operator by an appropriate “`_power`” slot. Powers are processed as follows:

$x^y$  is searched for elements of library domains from left to right. Let  $z$  (either  $x$  or  $y$ ) be the first term that is not of one of the basic types provided by the kernel (numbers, expressions, etc.). If the domain  $d = z : : \text{dom} = \text{domtype}(z)$  has a slot on page 1-1980 "\_power", it is called in the form  $d : : \_power(x, y)$ . The result returned by  $d : : \_power$  is the result of  $x^y$ .

See "Example 6" on page 1-72 (Symbolic Math Toolbox) and "Example 7" on page 1-72 (Symbolic Math Toolbox).

For finite sets  $X, Y$ , the power  $X^Y$  is the set  $\{x^y \mid x \in X, y \in Y\}$ .

## Examples

### Example 1

Some powers are computed:

$2^{10}, i^{-5}, 0.3^{1/3}, x^{1/2} + y^{-1/2}, (x^{-10} + 1)^2$

$$1024, -i, 0.6694329501, \sqrt{x} + \frac{1}{\sqrt{y}}, \left(\frac{1}{x^{10}} + 1\right)^2$$

Use `expand` to "expand" powers of sums:

$(x + y)^2 = \text{expand}((x + y)^2)$

$$(x + y)^2 = x^2 + 2xy + y^2$$

Note that identities such as  $(x*y)^z = x^z * y^z$  only hold in certain areas of the complex plane:

$((-1)*(-1))^{1/2} \neq (-1)^{1/2} * (-1)^{1/2}$

$$1 \neq -1$$

Consequently, the following `expand` command does not expand its argument:



`expand((x*y)^(1/2))`

$$\sqrt{x y}$$

## Example 2

The power operator  $\wedge$  is left associative:

`2^3^4 = (2^3)^4, x^y^z`

$$4096 = 4096, (x^y)^z$$

## Example 3

Modular powers can be computed directly using  $\wedge$  and `mod`. However, `powermod` is more efficient:

`123^12345 mod 17 = powermod(123, 12345, 17)`

$$4 = 4$$

## Example 4

The function `sqrt` produces simpler results than `_power`:

`sqrt(4*x*y), (4*x*y)^(1/2)`

$$2 \sqrt{x y}, \sqrt{4 x y}$$

## Example 5

For finite sets,  $X^Y$  is the set  $\{x^y \mid x \in X, y \in Y\}$ :

`{a, b, c}^2, {a, b, c}^{q, r, s}`

$$\{a^2, b^2, c^2\}, \{a^q, a^r, b^q, a^s, b^r, c^q, b^s, c^r, c^s\}$$

## Example 6

Various library domains such as matrix on page 7-252 domains or residue class on page 7-216 domains overload `_power`:

```
x := Dom::Matrix(Dom::IntegerMod(7))([[2, 3], [3, 4]]):
x^2, x^(-1), x^3 * x^(-3)
```

$$\begin{pmatrix} 6 \bmod 7 & 4 \bmod 7 \\ 4 \bmod 7 & 4 \bmod 7 \end{pmatrix}, \begin{pmatrix} 3 \bmod 7 & 3 \bmod 7 \\ 3 \bmod 7 & 5 \bmod 7 \end{pmatrix}, \begin{pmatrix} 1 \bmod 7 & 0 \bmod 7 \\ 0 \bmod 7 & 1 \bmod 7 \end{pmatrix}$$

```
delete x:
```

## Example 7

This example demonstrates the behavior of `_power` on user-defined domains. Without a "power" slot on page 1-1980, powers of domain elements are handled like any other symbolic powers:

```
myDomain := newDomain("myDomain"): x := new(myDomain, 1): x^2
```

$$\text{new(myDomain, 1)}^2$$

```
type(x^2), op(x^2, 0), op(x^2, 1), op(x^2, 2)
```

```
"_power", _power, new(myDomain, 1), 2
```

After the `"_power"` slot is defined, this method is used to compute powers of `myDomain` objects:

```
myDomain::_power := proc() begin "The result" end: x^2
```

```
"The result"
```

`delete myDomain, x:`

## Parameters

**x, y**

arithmetical expressions (Symbolic Math Toolbox), polynomials on page 1-431 (Symbolic Math Toolbox) of type `DOM_POLY`, floating-point intervals on page 7-33, or sets on page 7-50

## Return Values

Arithmetical expression, a polynomial, a floating-point interval, or a set.

## Overloaded By

x, y

## See Also

### MuPAD Functions

`*` | `+` | `-` | `/` | `_invert` | `_subtract` | `numlib::ispower` | `powermod` | `surd`

## @\_fconcat

Compose functions

### Syntax

`f @ g @ ...`

`_fconcat(f, g, ...)`

### Description

`f@g` represents the composition  $x \rightarrow f(g(x))$  of the functions `f` and `g`.

In MuPAD, functions (Symbolic Math Toolbox) are usually represented by procedures on page 1-1654 of type `DOM_PROC`, function on page 1-1642 (Symbolic Math Toolbox)environments on page 1-1642 (Symbolic Math Toolbox), or functional expressions such as `f@g@exp + id^2`. In fact, practically any MuPAD object may serve as a function.

`f @ g` is equivalent to the function call `_fconcat(f, g)`.

`_fconcat()` returns the identity map `id`; `_fconcat(f)` returns `f`.

### Examples

#### Example 1

The following function `h` is the composition of the system functions `abs` and `sin`:

```
h := abs@sin
```

```
abs ◦ sin
```

```
h(x), h(y + 2), h(0.5)
```

$|\sin(x)|, |\sin(y+2)|, 0.4794255386$

The following functional expressions represent polynomials:

```
f := id^3 + 3*id - 1: f(x), (f@f)(x)
```

$x^3 + 3x - 1, 9x + (x^3 + 3x - 1)^3 + 3x^3 - 4$

The random generator `random` produces nonnegative integers with 12 digits. The following composition of `float` and `random` produces random floating-point numbers between 0.0 and 1.0:

```
rand := float@random/10^12: rand() $ k = 1..12
```

0.4274196691, 0.3211106933, 0.3436330737, 0.4742561436, 0.558458719, 0.7467538305,  
0.03206222209, 0.7229741218, 0.6043056139, 0.7455800374, 0.2598119527,  
0.3100754872

In conjunction with the function `map`, the composition operator `@` is a handy tool to apply composed functions to the operands of a data structure:

```
map([1, 2, 3, 4], (PI + id^2)@sin),  
map({1, 2, 3, 4}, cos@float)
```

$[\pi + \sin(1)^2, \pi + \sin(2)^2, \pi + \sin(3)^2, \pi + \sin(4)^2],$

$\{-0.9899924966, -0.6536436209, -0.4161468365, 0.5403023059\}$

```
delete h, f, rand:
```

## Example 2

Some simplifications of functional expressions are possible via `simplify`:

```
exp@ln + cos@arccos = simplify(cos@arccos + exp@ln)
```

$\exp \circ \ln + \cos \circ \arccos = 2 \text{ id}$

## Parameters

f, g, ...

functions (Symbolic Math Toolbox)

## Return Values

Expression of type "\_fconcat".

## Overloaded By

f, g

## See Also

**MuPAD Functions**

@@

# @@\_fnest

Iterate a function

## Syntax

```
f @@ n  
_fnest(f, n)
```

## Description

$f@@n$  represents the  $n$ -fold iterate  $x \rightarrow f(f(\dots(f(x))\dots))$  of the function  $f$ .

The statement  $f@@n$  is equivalent to the call `_fnest(f, n)`.

For positive  $n$ ,  $f@@n$  is also equivalent to `_fconcat(f $ n)`.

$f@@0$  returns the identity map `id`.

If  $f$  is a function environment on page 7-25 with the slot "inverse" set,  $n$  can also be negative. Cf. "Example 2" on page 1-78 (Symbolic Math Toolbox).

Iteration is only reasonable for functions that accept their own return values as input. Note that `fp::fixargs` is a handy tool for converting functions with parameters to univariate functions which may be suitable for iteration. Cf. "Example 3" on page 1-78 (Symbolic Math Toolbox).

## Examples

### Example 1

For a nonnegative integer  $n$ ,  $f@@n$  is equivalent to an `_fconcat` call:

```
f@@4, (f@@4)(x)
```

$$f \circ f \circ f \circ f, f(f(f(f(x))))$$

@@ simplifies the composition of symbolic iterates:

`(f@@n)@@m`

$$f@@(m\ n)$$

The iterate may be called like any other MuPAD function. If  $f$  evaluates to a procedure and  $n$  to an integer, a corresponding value is computed:

`f := x -> x^2: (f@@n)(x) $ n = 0..10`

$$x, x^2, x^4, x^8, x^{16}, x^{32}, x^{64}, x^{128}, x^{256}, x^{512}, x^{1024}$$

`delete f:`

## Example 2

For functions with a known inverse function,  $n$  may be negative. The function  $f$  must have been declared as a function environment on page 7-25 with the "inverse" slot. Examples of such functions include the trigonometric functions which are implemented as function environments in MuPAD:

`sin::"inverse", sin@@-3, (sin@@(-3))(x)`

$$\text{"arcsin", arcsin} \circ \text{arcsin} \circ \text{arcsin}, \text{arcsin}(\text{arcsin}(\text{arcsin}(x)))$$

## Example 3

@@ can only be used for functions that accept their own output domain as an input, i.e.,  $f: M \rightarrow M$  for some set  $M$ . If you want to use @@ with a function which needs additional parameters, `fp::fixargs` is a handy tool to generate a corresponding univariate function. In the following call, the function  $f: x \rightarrow g(x, p)$  is iterated:

`g := (x, y) -> x^2 + y: f := fp::fixargs(g, 1, p): (f@@4)(x)`



$$p + (p + (p + (x^2 + p)^2)^2)^2$$

delete g, f:

## Parameters

**f**

A function (Symbolic Math Toolbox)

**n**

An integer on page 7-31 or a symbolic name

## Return Values

Function

## See Also

### MuPAD Functions

@ | fp::fixargs | fp::fold | fp::nest | fp::nestvals

## **`$_seqgen` `_seqin` `_seqstep`**

Create an expression sequence

### **Syntax**

```
$ a .. b  
_seqgen(a .. b)  
$ c .. d step e  
_seqstep(c .. d, e)  
f $ n  
_seqgen(f, n)  
f $ c step e  
_seqstep(f, c, e)  
f $ i = a .. b  
_seqgen(f, i, a .. b)  
f $ i = c .. d step e  
_seqstep(f, i, c .. d, e)  
f $ i in object  
_seqin(f, i, object)
```

### **Description**

`$ a .. b` creates the sequence of integers from `a` through `b`.

`$ c .. d step e` creates the sequence of numbers from `c` through `d` with increment `e`.

`f $ n` creates the sequence `f, ..., f` consisting of `n` copies of `f`.

`f $ c step e` creates the sequence `f, ..., f` consisting of `trunc(c/e)` copies of `f`.

`f(i) $ i = a..b` creates the sequence `f(a), f(a+1), ..., f(b)`.

`f(i) $ i = c..d step e` creates the sequence `f(c), f(c+e), ..., f(c+j*e)`, with `j` such that `c+j*e <= d` and `c+(j+1)*e > d`.

`f(i) $ i in object` creates the sequence `f(i1), f(i2), ...,` where `i1, i2` etc. are the operands of the object.

The `$` operator is a most useful tool. It serves for generating sequences of objects. Sequences are used to define sets on page 7-50 or lists on page 7-41, and may be passed as arguments to system functions. See “Example 1” on page 1-82 (Symbolic Math Toolbox).

`$ a..b` and the equivalent function call `_seqgen(a..b)` produce the sequence of integers `a, a + 1, ..., b`. The void object of type `DOM_NULL` is produced if `a > b`.

`$ c..d step e` and the equivalent function call `_seqstep(c..d, e)` produce the sequence of numbers `c, c + e, ..., c + j*e`, with `j` such that `c + j*e <= d` and `c + (j + 1)*e > d`. The void object of type `DOM_NULL` is produced if `c > d`.

`f $ n` and the equivalent function call `_seqgen(f, n)` produce a sequence of `n` copies of the object `f`. Note that `f` is evaluated only once, before the sequence is created. The empty sequence of type `DOM_NULL` is produced if `n` is not positive.

`f $ c step e` and the equivalent function call `_seqstep(f, c, e)` produce a sequence of `trunc(c/e)` copies of the object `f`. Note that `f` is evaluated only once, before the sequence is created. The empty sequence of type `DOM_NULL` is produced if `trunc(c/e)` is not positive.

`f $ i = a..b` and the equivalent function call `_seqgen(f, i, a..b)` successively set `i := a` through `i := b` and evaluate `f` with these values. After this (or in case of an error, earlier), the previous value of `i` is restored.

Note that `f` is not evaluated before the first assignment. The void object of type `DOM_NULL` is produced if `a > b`.

`f $ i = c..d step e` and the equivalent function call `_seqstep(f, i, c..d, e)` successively set `i := c, i := c + e, ...` until the value of `i` exceeds `d` and evaluate `f` with these values. After this (or in case of an error, earlier), the previous value of `i` is restored.

Note that `f` is not evaluated before the first assignment. The void object of type `DOM_NULL` is produced if `c > d`.

`f $ i in object` and the equivalent function call `_seqin(f, i, object)` successively assign the operands of the `object` to `i`: they set `i := op(object, 1)` through `i := op(object, n)` and evaluate `f` with these values, returning the result. (`n = nops(object)` is the number of operands.)

Note that `f` is not evaluated before the assignments. The empty sequence of type `DOM_NULL` is produced if the `object` has no operands.

The “loop variable” `i` in `f $ i = a..b` and `f $ i in object` may have a value. This value is restored after the `$` statement returns.

## Examples

### Example 1

The following sequence can be passed as arguments to the function `_plus`, which adds up its arguments:

```
i^2 $ i = 1..5  
  
1, 4, 9, 16, 25  
  
_plus(i^2 $ i = 1..5)  
  
55
```

The 5-th derivative of the expression `exp(x^2)` is:

```
diff(exp(x^2), x $ 5)  
  
 $120 x e^{x^2} + 160 x^3 e^{x^2} + 32 x^5 e^{x^2}$ 
```

We compute the first derivatives of `sin(x)`:

```
diff(sin(x), x $ i) $ i = 0..5
```

```
sin(x), cos(x), -sin(x), -cos(x), sin(x), cos(x)
```

We use `ithprime` to compute the first 10 prime numbers:

```
ithprime(i) $ i = 1..10
```

```
2, 3, 5, 7, 11, 13, 17, 19, 23, 29
```

We select on page 1-1828 all primes on page 1-1110 from the set of integers between 1990 and 2010:

```
select({$ 1990..2010}, isprime)
```

```
{1993, 1997, 1999, 2003}
```

The 3×3matrix on page 1-2045 (Symbolic Math Toolbox) with entries  $A_{ij} = ij$  is generated:

```
n := 3: matrix([[i*j $ j = 1..n] $ i = 1..n])
```

```
( 1 2 3
  2 4 6
  3 6 9)
```

```
delete n:
```

## Example 2

In `f $ n`, the object `f` is evaluated only once. The result is copied `n` times. Consequently, the following call produces copies of one single random number:

```
random() $ 3
```

```
427419669081, 427419669081, 427419669081
```

The following call evaluates `random` for each value of `i`:

```
random() $ i = 1..3
```

```
321110693270, 343633073697, 474256143563
```

### Example 3

In the following call, `i` runs through the list:

```
i^2 $ i in [3, 2, 1]
```

```
9, 4, 1
```

Note that the screen output of sets does not necessarily coincide with the internal ordering:

```
set := {i^2 $ i = 1..19}:  
set;  
[op(set)]
```

```
{1, 4, 9, 16, 25, 36, 49, 64, 81, 100, 121, 144, 169, 196, 225, 256, 289, 324, 361}
```

```
[1, 4, 361, 9, 16, 25, 36, 49, 64, 81, 100, 121, 144, 169, 196, 225, 256, 289, 324]
```

The `$` operator respects the internal ordering:

```
i^2 $ i in set
```

```
1, 16, 130321, 81, 256, 625, 1296, 2401, 4096, 6561, 10000, 14641, 20736, 28561, 38416,  
50625, 65536, 83521, 104976
```

```
delete set:
```

### Example 4

Arbitrary objects `f` are allowed in `f $ i = a..b`. In the following call, `f` is an assignment (it has to be enclosed in brackets). The sequence computes a table `f[i] = i!`:

```
f[0] := 1: (f[i] := i*f[i - 1]) $ i = 1..4: f
```

```
0 | 1
1 | 1
2 | 2
3 | 6
4 | 24
```

delete f:

### Example 5

Apart from the usual sequence generator with the step size 1, `_seqstep` allows arbitrary integer, rational, or real numbers as step sizes:

```
1 $ 2 step 0.5
```

```
1, 1, 1, 1
```

```
$ 1..2 step .2
```

```
1, 1.2, 1.4, 1.6, 1.8, 2.0
```

```
f(i) $ i = 1..2 step 1/2
```

```
 $f(1), f\left(\frac{3}{2}\right), f(2)$ 
```

Like in a for-loop, the step size can be negative:

```
f(i) $ i = 5..1 step -2
```

```
 $f(5), f(3), f(1)$ 
```

In contrast to `_seqgen` the range bounds in `_seqstep` can be rational or floating-point numbers:

```
1 $ 5/2 step 0.5
```

```
1, 1, 1, 1, 1
```

`$ 1.1..2.1 step .2`

$1.1, 1.3, 1.5, 1.7, 1.9, 2.1$

`f(i) $ i = 1/2..5/2 step 1/2`

$f\left(\frac{1}{2}\right), f(1), f\left(\frac{3}{2}\right), f(2), f\left(\frac{5}{2}\right)$

## Example 6

the `$`-expression returns symbolically, if the given range is symbolic:

`x $ n, $ a..b, f(i) $ i = a..b`

$x \$ n, \$ a..b, f(i) \$ i = a..b$

## Parameters

### **f, object**

Arbitrary MuPAD objects

### **n, a, b**

integers on page 7-31

### **c, d, e**

integer on page 7-31, rational on page 7-48, or floating-point on page 7-23 numbers

### **i**

An identifier on page 7-29 or a local variable (`DOM_VAR`) of a procedure on page 1-1654



## Return Values

Expression sequence of type "`_exprseq`" on page 1-88 or the void object of type `DOM_NULL`.

## Overloaded By

`a..b`, `c..d`, `e`, `f`, `i`, `n`, `object`

## See Also

### MuPAD Functions

`_exprseq` | `null`

## **,\_exprseq**

Expression sequences

### **Syntax**

`object1, object2, ...`

`_exprseq(object1, object2, ...)`

### **Description**

The function call `_exprseq(object1, object2, ...)` is the internal representation of the expression sequence `object1, object2, ....`

In MuPAD, “sequences” are ordered collections of objects separated by commas. You may think of the comma as an operator that concatenates sequences. Internally, sequences are represented as function calls `_exprseq(object1, object2, ...)`. On the screen, sequences are printed as `object1, object2, ....`

`_exprseq()` and the equivalent call `null()` yield the void object of type `DOM_NULL`.

When evaluating an expression sequence, all void objects of type `DOM_NULL` are removed from it, automatically.

The `$` operator is a useful tool for generating sequences.

When a MuPAD function or procedure is called with more than one argument, the parameters are passed as an expression sequence.

### **Examples**

#### **Example 1**

A sequence is generated by “concatenating” objects with commas. The resulting object is of type `"_exprseq"`:

```
a, b, sin(x)
```

```
a, b, sin(x)
```

```
op(%, 0), type(%)
```

```
_exprseq, "_exprseq"
```

On the screen, `_exprseq` just returns its argument sequence:

```
_exprseq(1, 2, x^2 + 5) = (1, 2, x^2 + 5)
```

```
(1, 2, x^2 + 5) = (1, 2, x^2 + 5)
```

## Example 2

The object of domain `DOM_NULL` (the “empty sequence”) is automatically removed from expression sequences:

```
1, 2, null(), 3
```

```
1, 2, 3
```

Expression sequences are flattened (Symbolic Math Toolbox). The following sequence does not have 2 operands, where the second operand is a sequence. Instead, it is flattened to a sequence with 3 operands:

```
x := 1: y := 2, 3: x, y
```

```
1, 2, 3
```

```
delete x, y:
```

## Example 3

Sequences are used to build sets on page 7-50 and lists on page 7-41. Sequences can also be passed to functions that accept several arguments:

```
s := 1, 2, 3: {s}, [s], f(s)
```

```
{1, 2, 3}, [1, 2, 3], f(1, 2, 3)
```

```
delete s:
```

## Parameters

**object<sub>1</sub>, object<sub>2</sub>, ...**

Arbitrary MuPAD objects

## Return Values

Expression of type "\_exprseq" or the void object of type DOM\_NULL.

## See Also

### **MuPAD Functions**

`_stmtseq` | `null`

## %if

Conditional creation of code by the parser

### Syntax

```
%if condition1
then casetrue1
    elif condition2 then casetrue2
    elif condition3 then casetrue3
    ...
    else casefalse
end_if
```

### Description

`%if` controls the creation of code by the parser depending on a condition.

This statement is one of the more esoteric features of MuPAD. It is *not* executed at run time by the MuPAD interpreter. It controls the creation of code for the interpreter by the parser.

`%if` may be used to create different versions of a library which share a common code basis, or to insert debugging code which should not appear in the release version.

The first condition is executed by the parser in a Boolean context and must yield one of the Boolean values `TRUE` or `FALSE`:

- If the condition yields `TRUE`, the statement sequence `casetrue` is the code that is created by the parser for the `%if`-statement. The rest of the statement is ignored by the parser, no code is created for it.
- If the condition yields `FALSE`, then the condition of the next `elif`-part is evaluated and the parser continues as before.
- If all conditions evaluate to `FALSE` and no more `elif`-parts exist, the parser inserts the code of the statement sequence `casefalse` as the code for the `%if`-statement. If no `casefalse` exists, `NIL` is produced.

The whole statement sequence is read by the parser and must be syntactically correct. Also the parts that do not result in code must be syntactically correct.

Note that instead of `end_if`, one may also simply use the keyword `end`.

In case of an empty statement sequence, the parser creates `NIL` as code.

---

**Note** The conditions are parsed in the lexical context where they occur, but are *evaluated by the parser in the context where the parser is executed*. This is the case because the environment where the conditions are lexically bound simply does not exist during parsing. Thus, one must ensure that names in the conditions do not conflict with names of local variables or arguments in the surrounding lexical context. The parser does not check this!

---

No function exists in the interpreter which can execute the `%if`-statement. The reason is that the statement is implemented by the parser, not by the interpreter.

## Examples

### Example 1

In the following example, we create debugging code in a procedure depending on the value of the global identifier `DEBUG`.

Note that this example is somewhat academic, as the function `prog::trace` is a much more elegant way to trace a procedure during debugging.

```
DEBUG := TRUE:
p := proc(x) begin
    %if DEBUG = TRUE then
        print("entering p")
    end;
    x^2
end_proc:
p(2)
```

"entering p"

## 4

When we look at `p`, we see that only the `print` command was inserted by the parser:

```
expose(p)
```

```
proc(x)
  name p;
begin
  print("entering p");
  x^2
end_proc
```

Now we set `DEBUG` to `FALSE` and parse the procedure again to create the release version. No debug output is printed:

```
DEBUG := FALSE:
p := proc(x) begin
  %if DEBUG = TRUE then
    print("entering p")
  end;
  x^2
end_proc:
p(2)
```

## 4

If we look at the procedure we see that `NIL` was inserted for the `%if`-statement:

```
expose(p)
```

```
proc(x)
  name p;
begin
  NIL;
  x^2
end_proc
```

## Parameters

### **condition**

A Boolean expression

### **casetrue**

A statement sequence

### **casefalse**

A statement sequence

## Algorithms

This statement may remind C programmers of conditional compilation. In C, this is implemented by a pre-processor which is run before the parser. In MuPAD, such a pre-processor does not exist. The `%if`-statement is part of the parsing process.

## See Also

### **MuPAD Functions**

`if`



## ;:\_stmtseq

Statement sequences

### Syntax

```
object1; object2; ...
```

```
object1: object2: ...
```

```
_stmtseq(object1, object2, ...)
```

### Description

The function call `_stmtseq (object1, object2, ...)` is equivalent to the statement sequence `(object1; object2; ...)`.

The function call `_stmtseq (object1, object2, ...)` evaluates the statements `(object1; object2; ...)` from left to right.

`_stmtseq ()` returns the void object of type `DOM_NULL`.

### Examples

#### Example 1

Usually, statements are entered imperatively:

```
x := 2; x := x^2 + 17; sin(x + 1)
```

2

21

```
sin(22)
```

This sequence of statements is turned into a single command (a “statement sequence”) by enclosing it in brackets. Now, only the result of the “statement sequence” is printed. It is the result of the last statement inside the sequence:

```
(x := 2; x := x^2 + 17; sin(x + 1))
```

```
sin(22)
```

Alternatively, the statement sequence can be entered via `_stmtseq`. For syntactical reasons, the assignments have to be enclosed in brackets when using them as arguments for `_stmtseq`. Only the return value of the statement sequence (the return value of the last statement) is printed:

```
_stmtseq((x := 2), (x := x^2 + 17), sin(x + 1))
```

```
sin(22)
```

Statement sequences can be iterated:

```
x := 1: (x := x + 1; x := x^2; print(i, x)) $ i = 1..4
```

```
1, 4
```

```
2, 25
```

```
3, 676
```

```
4, 458329
```

```
delete x:
```

## Parameters

`object1`, `object2`, ...

Arbitrary MuPAD objects and statements

## Return Values

Return value of the last statement in the sequence.

## See Also

### MuPAD Functions

`_exprseq`

## abs

Absolute value of a real or complex number

### Syntax

`abs(z)`

`abs(L)`

### Description

`abs(z)` returns the absolute value of the number  $z$ .

For many constant expressions, `abs` returns the absolute value as an explicit number or expression. Cf. “Example 1” on page 1-99 (Symbolic Math Toolbox).

A symbolic call of `abs` is returned if the absolute value cannot be determined (e.g., because the argument involves identifiers). The result is subject to certain simplifications. In particular, `abs` extracts constant factors. Properties of identifiers are taken into account. See “Example 2” on page 1-99 (Symbolic Math Toolbox) and “Example 3” on page 1-100 (Symbolic Math Toolbox).

The `expand` function rewrites the absolute value of a product to a product of absolute values. E.g., `expand(abs(x*y))` yields `abs(x)*abs(y)`. Cf. “Example 4” on page 1-100 (Symbolic Math Toolbox).

The symbolic constants (Symbolic Math Toolbox) CATALAN, E, EULER, and PI are processed by `abs`. Cf. “Example 5” on page 1-100 (Symbolic Math Toolbox).

The absolute value of symbolic function calls can be defined via the slot “`abs`” of function environments on page 1-1642 (Symbolic Math Toolbox). Cf. “Example 7” on page 1-101 (Symbolic Math Toolbox).

In the same way, the absolute value of domain elements can be defined via overloading. Cf. “Example 8” on page 1-101 (Symbolic Math Toolbox).

This function is automatically mapped to all entries of container objects such as arrays, lists, matrices, polynomials, sets, and tables.

## Environment Interactions

abs respects properties (Symbolic Math Toolbox) of identifiers.

## Examples

### Example 1

For many constant expressions, the absolute value can be computed explicitly:

`abs(1.2)`, `abs(-8/3)`, `abs(3 + I)`, `abs(sqrt(-3))`

$$1.2, \frac{8}{3}, \sqrt{10}, \sqrt{3}$$

`abs(sin(42))`, `abs(PI^2 - 10)`, `abs(exp(3) - tan(157/100))`

$$-\sin(42), 10 - \pi^2, \tan\left(\frac{157}{100}\right) - e^3$$

`abs(exp(3 + I) - sqrt(2))`

$$\sqrt{e^6 \sin(1)^2 + (\cos(1) e^3 - \sqrt{2})^2}$$

### Example 2

Symbolic calls are returned if the argument contains identifiers without properties:

`abs(x)`, `abs(x + 1)`, `abs(sin(x + y))`

$$|x|, |x + 1|, |\sin(x + y)|$$

The result is subject to some simplifications. In particular, `abs` splits off constant factors in products:

```
abs(PI*x*y), abs((1 + I)*x), abs(sin(4)*(x + sqrt(3)))
```

$\pi |x y|, \sqrt{2} |x|, -\sin(4) |x + \sqrt{3}|$

### Example 3

`abs` is sensitive to properties of identifiers:

```
assume(x < 0): abs(3*x), abs(PI - x), abs(I*x)
```

$-3 x, \pi - x, -x$

```
unassume(x):
```

### Example 4

The `expand` function produces products of `abs` calls:

```
abs(x*(y + 1)), expand(abs(x*(y + 1)))
```

$|x (y+1)|, |y+1| |x|$

### Example 5

The absolute value of the symbolic constants `PI`, `EULER`, etc. are known:

```
abs(PI), abs(EULER + CATALAN^2)
```

$\pi, \text{EULER} + \text{CATALAN}^2$

### Example 6

Expressions containing `abs` can be differentiated:

```
diff(abs(x), x), diff(abs(x), x, x)
```

```
sign(x), 2 δ(x)
```

## Example 7

The slot on page 1-1980 "abs" of a function environment f defines the absolute value of symbolic calls of f:

```
abs(f(x))
```

```
|f(x)|
```

```
f := funcenv(f):
f::abs := x -> f(x)/sign(f(x)):
abs(f(x))
```

$$\frac{f(x)}{\text{sign}(f(x))}$$

```
delete f:
```

## Example 8

The slot on page 1-1980 "abs" of a domain d defines the absolute value of its elements:

```
d := newDomain("d"):
e1 := new(d, 2):
e2 := new(d, x):
d::abs := x -> abs(extop(x, 1)):
abs(e1), abs(e2)
```

```
2, |x|
```

```
delete d, e1, e2:
```

## Parameters

**z**

An arithmetical expression (Symbolic Math Toolbox)

**L**

A container object: an array on page 7-2, an hfarray on page 7-27, a list on page 7-41, a matrix on page 1-2045 (Symbolic Math Toolbox), a polynomial on page 1-1601, a set on page 7-50, or a table on page 1-2103.

## Return Values

arithmetical expression (Symbolic Math Toolbox) or a container object containing such expressions

## Overloaded By

**z**

## See Also

### **MuPAD Functions**

Im | Re | conjugate | norm | sign



# airyAi

Airy function of the first kind

## Syntax

`airyAi(z)`

`airyAi(z, n)`

## Description

`airyAi(z)` represents the Airy function of the first kind. The Airy functions of the first and second kind are linearly independent solutions of the differential equation

$$\frac{\partial^2}{\partial z^2} y - z y = 0.$$

`airyAi(z, n)` represents the  $n$ -th derivative of `airyAi(z)` with respect to  $z$ .

`airyAi(z)` is equivalent to `airyAi(z, 0)`.

For  $n \geq 2$ , derivatives of the Airy functions are automatically expressed in terms of the Airy functions and their first derivative. See “Example 1” on page 1-104 (Symbolic Math Toolbox).

`airyAi` returns special values for  $z = 0$  and  $z = \pm\infty$ . For all other symbolic values of  $z$ , unevaluated function calls are returned. See “Example 2” on page 1-104 (Symbolic Math Toolbox).

## Environment Interactions

When called with floating-point arguments, this function is sensitive to the environment variable `DIGITS` which determines the numerical working precision.

## Examples

### Example 1

Second and higher derivatives of Airy functions are rewritten in terms of Airy functions and their first derivatives:

`airyAi(x)`, `airyAi(x, 1)`, `airyAi(sin(x), 3)`

`airyAi(x, 0)`, `airyAi(x, 1)`, `airyAi(sin(x), 0) + sin(x) airyAi(sin(x), 1)`

### Example 2

For  $z = 0$ , special values are returned:

`airyAi(0)`, `airyAi(0, 1)`, `airyAi(0, 27)`

$$\frac{3^{1/3}}{3 \Gamma(\frac{2}{3})}, -\frac{3^{1/6} \Gamma(\frac{2}{3})}{2 \pi}, \frac{608608000 3^{1/3}}{3 \Gamma(\frac{2}{3})}$$

For  $n = 0$ ,  $n = 1$  and any symbolic  $z \neq 0$ ,  $z \neq \pm\infty$ , a symbolic call is returned:

`airyAi(-1)`, `airyAi(x, 1)`

`airyAi(-1, 0)`, `airyAi(x, 1)`

Floating-point values are returned for floating-point arguments:

`airyAi(0.0)`, `airyAi(-3.24819, 1)`, `airyAi(-3.45 + 2.75*I)`

`0.3550280539`, `0.00001031967672`, `-32.61802119 + 16.8576071 i`

### Example 3

`diff`, `float`, `limit`, `series`, and other functions handle expressions involving the Airy functions:

```
diff(airyAi(x^2), x)
```

$$2 x \operatorname{airyAi}(x^2, 1)$$

```
float(airyAi(PI))
```

0.00508935348

```
limit(airyAi(-x), x = infinity)
```

0

```
series(airyAi(x, 1), x = infinity)
```

$$-\frac{x^{1/4}}{2\sqrt{\pi}\sigma_1} - \frac{7}{96x^{5/4}\sqrt{\pi}\sigma_1} + \frac{455}{9216x^{11/4}\sqrt{\pi}\sigma_1} - \frac{95095}{1327104x^{17/4}\sqrt{\pi}\sigma_1} + O\left(\frac{1}{x^{23/4}\sigma_1}\right)$$

where

$$\sigma_1 = \left(e^{x^{3/2}}\right)^{2/3}$$

## Parameters

**z**

Arithmetical expression (Symbolic Math Toolbox)

**n**

Arithmetical expression representing a nonnegative integer

## **Return Values**

Arithmetical expression.

## **Overloaded By**

$z$

## **See Also**

### **MuPAD Functions**

`airyBi` | `besselI` | `besselJ` | `besselK`

# airyBi

Airy function of the second kind

## Syntax

`airyBi(z)`

`airyBi(z, n)`

## Description

`airyBi(z)` represents the Airy function of the second kind. The Airy functions of the first and second kind are linearly independent solutions of the differential equation

$$\frac{\partial^2}{\partial z^2} y - z y = 0.$$

`airyBi(z, n)` represents the  $n$ -th derivative of `airyBi(z)` with respect to  $z$ .

`airyBi(z)` is equivalent to `airyBi(z, 0)`.

For  $n \geq 2$ , derivatives of the Airy functions are automatically expressed in terms of the Airy functions and their first derivative. See “Example 1” on page 1-108 (Symbolic Math Toolbox).

`airyBi` returns special values for  $z = 0$  and  $z = \pm\infty$ . For all other symbolic values of  $z$ , unevaluated function calls are returned. See “Example 2” on page 1-108 (Symbolic Math Toolbox).

## Environment Interactions

When called with floating-point arguments, this functions is sensitive to the environment variable `DIGITS` which determines the numerical working precision.

## Examples

### Example 1

Second and higher derivatives of Airy functions are rewritten in terms of Airy functions and their first derivatives:

`airyBi(x), airyBi(x, 1), airyBi(sin(x), 3)`

`airyBi(x, 0), airyBi(x, 1), airyBi(sin(x), 0) + sin(x) airyBi(sin(x), 1)`

### Example 2

For  $z = 0$ , special values are returned:

`airyBi(0), airyBi(0, 1), airyBi(0, 27)`

$$\frac{3^{5/6}}{3 \Gamma(\frac{2}{3})}, \frac{3^{2/3} \Gamma(\frac{2}{3})}{2 \pi}, \frac{608608000 3^{5/6}}{3 \Gamma(\frac{2}{3})}$$

For  $n = 0$ ,  $n = 1$  and any symbolic  $z \neq 0$ ,  $z \neq \pm\infty$ , a symbolic call is returned:

`airyBi(-1), airyBi(x, 1)`

`airyBi(-1, 0), airyBi(x, 1)`

Floating-point values are returned for floating-point arguments:

`airyBi(0.0), airyBi(-3.24819, 1), airyBi(-3.45 + 2.75*I)`

`0.6149266274, -0.759660975, -16.85910551 - 32.61659997 i`

### Example 3

`diff`, `float`, `limit`, `series`, and other functions handle expressions involving the Airy functions:

```
diff(airyBi(x^2), x)
```

$$2 x \operatorname{airyBi}(x^2, 1)$$

```
float(airyBi(PI))
```

```
17.74733433
```

```
limit(airyBi(-x), x = infinity)
```

```
0
```

```
series(airyBi(x, 1), x = infinity)
```

$$\frac{x^{1/4} \sigma_1}{\sqrt{\pi}} - \frac{7 \sigma_1}{48 x^{5/4} \sqrt{\pi}} - \frac{455 \sigma_1}{4608 x^{11/4} \sqrt{\pi}} - \frac{95095 \sigma_1}{663552 x^{17/4} \sqrt{\pi}} + O\left(\frac{\sigma_1}{x^{23/4}}\right)$$

where

$$\sigma_1 = \left(e^{x^{3/2}}\right)^{2/3}$$

## Parameters

**z**

Arithmetical expression (Symbolic Math Toolbox)

**n**

Arithmetical expression representing a nonnegative integer

## **Return Values**

Arithmetical expression.

## **Overloaded By**

$z$

## **See Also**

### **MuPAD Functions**

`airyAi` | `besselI` | `besselJ` | `besselK`



# alias

Creates an alias

## Syntax

```
alias(x1 = object1, x2 = object2, ..., <Global>)
```

```
alias(<Global>)
```

## Description

`alias(x = object)` defines `x` as an abbreviation for `object`. It changes the configuration of the parser, replacing identifier on page 7-29x by `object` in the input, and then replacing `object` by `x` in the output.

`alias(f(y1,y2,...) = object)` defines `f` to be a macro. It changes the configuration of the parser so that a function call of the form `f(a1, a2, ...)`, where `a1,a2,...` is a sequence of arbitrary objects of the same length as `y1,y2,...`, is replaced by `object` with `a1` substituted for `y1`, `a2` substituted for `y2`, and so on. No substitution takes place if the number of parameters `y1,y2,...` differs from the number of arguments `a1,a2,...`. No substitution takes place in the output.

You can define a macro without any arguments via `alias(f()=object)`.

`alias` does not evaluate its arguments. Hence it has no effect if the aliased identifier has a value, and `alias` creates an alias for the right side of the alias definition and not for its evaluation. See “Example 2” on page 1-114 (Symbolic Math Toolbox).

An alias definition causes a substitution similar to the effect of `subs`, not just a textual replacement. See “Example 3” on page 1-115 (Symbolic Math Toolbox).

`alias` does not flatten (Symbolic Math Toolbox) its arguments. Thu, an expression sequence on page 1-88 is a valid right side of an alias definition. See “Example 5” on page 1-117 (Symbolic Math Toolbox).

An alias is in effect from the time when the call to `alias` has been evaluated. It affects exactly those inputs that are *parsed* after that moment. See “Example 9” on page 1-118

(Symbolic Math Toolbox). In particular, an alias definition inside a procedure on page 7-45 does not affect the rest of the procedure.

You can create several alias definitions in a single call. Abbreviations and macros can be mixed.

`alias()` displays all currently defined aliases and macros as a sequence of equations. For an abbreviation defined via `alias(x = object)`, the equation `x = object` is printed. For a macro defined via `alias(f(y1, y2, ...) = object)`, the equation `f(y1, y2, ...) = object` is printed. See “Example 11” on page 1-119 (Symbolic Math Toolbox).

Each identifier can be aliased to only one object. Each object can be abbreviated in only one way. Otherwise `alias` throws an error.

By default, back-substitution of aliases in the output happens only for abbreviations and not for macros. After a command of the form `alias(x = object)`, both the unevaluated object `object` and its evaluation are replaced by the unevaluated identifier `x` in the output. See “Example 2” on page 1-114 (Symbolic Math Toolbox).

You can control the behavior of the back-substitution in the output with the function `Pref::alias`; see the corresponding help page for details.

Substitutions in the output only happen for the results of computations at interactive level. The behavior of the functions `fprint`, `print`, `expr2text`, or `write` is not affected.

Alias substitutions are performed in parallel, both in the input and in the output. Thus it is not possible to define nested aliases. See “Example 10” on page 1-119 (Symbolic Math Toolbox).

---

**Note** If you use an identifier as an abbreviation, you cannot use that same identifier directly. You must use `unalias` before you can define another abbreviation or macro for the same identifier. See “Example 4” on page 1-116 (Symbolic Math Toolbox).

---

If a macro `f(y1, y2, ..., yn)` with  $n$  arguments is defined, you cannot call `f` with  $n$  arguments in its literal meaning any longer. However, you can still call `f` with a different number of arguments. See “Example 5” on page 1-117 (Symbolic Math Toolbox).

You can define macros with different numbers of arguments at the same time. See “Example 4” on page 1-116 (Symbolic Math Toolbox).

An alias definition affects all kinds of input: interactive input on the command line, input via the function `input`, input from a file using `finput`, `fread`, or `read` (for the latter two only if option `Plain` is not set), and input from a string on page 7-53 using `text2expr`. See “Example 8” on page 1-118 (Symbolic Math Toolbox).

An alias definition has no effect on the identifier used as an alias. In particular, that identifier retains its value and its properties (Symbolic Math Toolbox). The alias and the aliased object are still distinguished by the evaluator. See “Example 6” on page 1-117 (Symbolic Math Toolbox).

Assigning on page 1-257 a value to one of the identifiers on the left side of an alias definition, or deleting on page 1-499 its value does not affect the alias substitution, neither in the input nor in the output. See “Example 7” on page 1-117 (Symbolic Math Toolbox).

## Environment Interactions

`alias` with at least one argument changes the parser configuration in the way described in the “Details” section.

## Examples

### Example 1

Define `d` as a shortcut for `diff`:

```
delete f, g, x, y: alias(d = diff):
d(sin(x), x) = diff(sin(x), x);
d(f(x, y), x) = diff(f(x, y), x)
```

$$\cos(x) = \cos(x)$$

$$d(f(x, y), x) = d(f(x, y), x)$$

Define a macro `Dx(f)` for `diff(f(x), x)`. Note that `hold` does not prevent alias substitution:

```
alias(Dx(f) = diff(f(x), x)):
Dx(sin); Dx(f + g); hold(Dx(f + g))
```

$\cos(x)$

$d(f(x), x) + d(g(x), x)$

$d(f(x) + g(x), x)$

After the call `unalias(d, Dx)`, no alias substitutions happen any longer:

```
unalias(d, Dx):
d(sin(x), x), diff(sin(x), x), d(f(x, y), x), diff(f(x, y), x);
Dx(sin), Dx(f + g)
```

$d(\sin(x), x), \cos(x), d(f(x, y), x), \frac{\partial}{\partial x} f(x, y)$

$Dx(\sin), Dx(f + g)$

## Example 2

Suppose you want to avoid typing `longhardtotypeident` and therefore define an abbreviation `a` for it:

```
longhardtotypeident := 10; alias(a = longhardtotypeident):
```

`10`

Since `alias` does not evaluate its arguments, `a` is now an abbreviation for `longhardtotypeident` and not for the number `10`:

```
type(a), type(hold(a))
```

`DOM_INT, DOM_IDENT`

```
a + 1, hold(a) + 1, eval(hold(a) + 1)
```

```
11, a + 1, 11
```

```
longhardtotypeident := 2:
a + 1, hold(a) + 1, eval(hold(a) + 1)
```

```
3, a + 1, 3
```

However, by default alias back-substitution in the output happens for both the identifier and its current value:

```
2, 10, longhardtotypeident, hold(longhardtotypeident)
```

```
a, 10, a, a
```

The command `Pref::alias(FALSE)` switches alias re-substitution off:

```
p := Pref::alias(FALSE):
a, hold(a), 2, longhardtotypeident, hold(longhardtotypeident);
Pref::alias(p): unalias(a):
```

```
2, longhardtotypeident, 2, 2, longhardtotypeident
```

### Example 3

Aliases are substituted and not just replaced textually. In the following example, `3*succ(u)` is replaced by `3*(u+1)`, and not by `3*u+1`, which a search-and-replace function in a text editor would produce:

```
alias(succ(x) = x + 1): 3*succ(u);
unalias(succ):
```

```
3 u + 3
```

## Example 4

Define `a` to be an abbreviation for `b`. Then the next alias definition is really an alias definition for `b`:

```
delete a, b:  
alias(a = b): alias(a = 2): type(a), type(b); unalias(b):
```

`DOM_IDENT, DOM_INT`

Use `unalias` first before defining another alias for the identifier `a`:

```
unalias(a): alias(a = 2): type(a), type(b); unalias(a):
```

`DOM_INT, DOM_IDENT`

A macro definition can be added if the newly defined macro has a different number of arguments. `unalias(a)` removes all macros defined for `a`:

```
alias(a(x)=sin(x^2)): a(y); alias(a(x)=cos(x^2)):
```

`sin(y2)`

```
Error: Invalid operand. [_power]  
Evaluating: alias
```

```
alias(a(x, y) = sin(x + y)):  
a(u, v);  
alias():  
unalias(a):
```

`sin(u + v)`

```
a(x) = sin(x2)
```

```
a(x, y) = sin(x + y)
```

## Example 5

A macro definition has no effect when called with the wrong number of arguments, and the sequence of arguments is not flattened:

```
alias(plus(x, y) = x + y):
plus(1), plus(3, 2), plus((3, 2));
unalias(plus):
```

```
plus(1), 5, plus(3, 2)
```

Expression sequences can appear on the right side of an alias definition, but they have to be enclosed in parenthesis:

```
alias(x = (1, 2)): f := 0, 1, 2, x;
nops(f); unalias(x):
```

```
0, 1, 2, 1, 2
```

```
5
```

## Example 6

An identifier used as an abbreviation can still exist in its literal meaning inside expressions that were entered before the alias definition:

```
delete x: f := [x, 1]: alias(x = 1): f;
map(f, type); unalias(x):
```

```
[x, x]
```

```
[DOM_IDENT, DOM_INT]
```

## Example 7

An identifier used as an alias does not have to have a value:

```
a := 5: alias(a = 7): 7, 5; print(a); unalias(a):
```

```
a, 5
```

```
7
```

```
delete a:
```

### Example 8

Alias definitions also apply to input from files or strings:

```
alias(a = 3): type(text2expr("a")); unalias(a)
```

```
DOM_INT
```

### Example 9

An alias is valid for all input that is *parsed* after executing `alias`. A statement in a command line is not parsed before the previous commands in that command line have been executed. In the following example, the alias is already in effect for the second statement:

```
alias(a = 3): type(a); unalias(a)
```

```
DOM_INT
```

This can be changed by entering additional parentheses:

```
(alias(a = 3): type(a)); unalias(a)
```

```
DOM_IDENT
```



## Example 10

Define `b` to be an alias for `c`, which in turn is defined to be an alias for `2`. It is recommended to avoid such chains of alias definitions because of probably unwanted effects.

```
alias(b=c): alias(c=2):
```

Now each `b` in the input is replaced by `c`, but no additional substitution step is taken to replace this again by `2`:

```
print(b)
```

```
c
```

On the other hand, the number `2` is replaced by `c` in every output and that `c` is then replaced by `b`:

```
2
```

```
b
```

```
unalias(c): unalias(b):
```

## Example 11

When called without arguments, `alias` just displays all currently defined aliases:

```
alias(a = 5, F(x) = sin(x^2)):
```

```
alias(); unalias(F, a):
```

```
F(x) = sin(x^2)
```

```
a = 5
```

## Parameters

$x_1, x_2, \dots$

Identifiers on page 7-29 or symbolic expressions of the form  $f(y_1, y_2, \dots)$ , with identifiers  $f, y_1, y_2, \dots$

**object<sub>1</sub>, object<sub>2</sub>,...**

Any MuPAD objects

## Options

**Global**

Definition of an alias in the global parser context.

When an alias is defined in a library or package source file, it will be deleted automatically after reading the file. With the option **Global**, the alias is not active in the file being read, but in the interactive level after reading of the file is finished.

## Return Values

Both `alias` and `unalias` return the void object of type `DOM_NULL`.

## Algorithms

Aliases are stored in the parser configuration table displayed by `_parser_config()`. Note that by default, alias back-substitution happens for the right sides of the equations in this table, but not for the indices. Use `print(_parser_config())` to display this table without alias back-substitution.

Aliases are not used while a file is read using `read` or `fread` with the option **Plain**. Conversely, if an alias is defined in a file which is read with the option **Plain**, the alias is only used until the file has been read completely.

## See Also

### MuPAD Functions

:= | Pref::alias | finput | fprint | fread | input | print | proc | read | subs |  
text2expr | unalias | write

## unalias

Deletes an alias

### Syntax

```
unalias(x1, x2, ..., <Global>)
```

```
unalias(<Global>)
```

### Description

`unalias(x)` deletes the abbreviation or macro `x`. To delete a macro defined by `alias(f(y1, y2, ...) = object)`, use `unalias(f)`. If no alias for `x` or `f` is defined, then the call is ignored.

`unalias()` deletes all abbreviations and macros.

Multiple alias definitions may be deleted by a single call of `unalias`. The call `unalias()` deletes all currently defined aliases.

`unalias` does not evaluate its arguments.

---

**Note** If you use an identifier as an abbreviation, you cannot use that same identifier directly. You must use `unalias` before you can define another abbreviation or macro for the same identifier. See “Example 2” on page 1-124 (Symbolic Math Toolbox).

---

Assigning on page 1-257 a value to one of the identifiers on the left side of an alias definition, or deleting on page 1-499 its value does not affect the alias substitution, neither in the input nor in the output.

### Environment Interactions

`alias` with at least one argument and `unalias` change the parser configuration in the way described in the “Details” section.

## Examples

### Example 1

Define `d` as a shortcut for `diff`:

```
delete f, g, x, y: alias(d = diff):
d(sin(x), x) = diff(sin(x), x);
d(f(x, y), x) = diff(f(x, y), x)
```

$$\text{cos}(x) = \text{cos}(x)$$

$$d(f(x, y), x) = d(f(x, y), x)$$

Define a macro `Dx(f)` for `diff(f(x), x)`. Note that `hold` does not prevent alias substitution:

```
alias(Dx(f) = diff(f(x), x)):
Dx(sin); Dx(f + g); hold(Dx(f + g))
```

$$\text{cos}(x)$$

$$d(f(x), x) + d(g(x), x)$$

$$d(f(x) + g(x), x)$$

After the call `unalias(d, Dx)`, no alias substitutions happen any longer:

```
unalias(d, Dx):
d(sin(x), x), diff(sin(x), x), d(f(x, y), x), diff(f(x, y), x);
Dx(sin), Dx(f + g)
```

$$d(\text{sin}(x), x), \text{cos}(x), d(f(x, y), x), \frac{\partial}{\partial x} f(x, y)$$

`Dx(sin), Dx(f + g)`

## Example 2

Define `a` to be an abbreviation for `b`. Then the next alias definition is really an alias definition for `b`:

```
delete a, b;  
alias(a = b): alias(a = 2): type(a), type(b); unalias(b):
```

`DOM_IDENT, DOM_INT`

Use `unalias` first before defining another alias for the identifier `a`:

```
unalias(a): alias(a = 2): type(a), type(b); unalias(a):
```

`DOM_INT, DOM_IDENT`

A macro definition, however, can be added if the newly defined macro has a different number of arguments. `unalias(a)` removes all macros defined for `a`:

```
alias(a(x)=sin(x^2)): a(y); alias(a(x)=cos(x^2)):
```

`sin(y2)`

```
Error: Invalid operand. [_power]  
Evaluating: alias
```

```
alias(a(x, y) = sin(x + y)):  
a(u, v);  
alias():  
unalias(a):
```

`sin(u + v)`

```
a(x) = sin(x^2)
```

```
a(x, y) = sin(x + y)
```

### Example 3

When called without arguments, `alias` just displays all currently used aliases:

```
alias(a = 5, F(x) = sin(x^2)):
alias();
unalias(F, a):

F(x) = sin(x^2)
a = 5
```

## Parameters

$x_1, x_2, \dots$

Identifiers on page 7-29 or symbolic expressions of the form  $f(y_1, y_2, \dots)$ , with identifiers  $f, y_1, y_2, \dots$

`object1, object2, ...`

Any MuPAD objects

## Options

**Global**

Definition of an alias in the global parser context.

When an alias is defined in a library or package source file, it will be deleted automatically after reading the file. With option `Global` the alias is not active in the file being read, but in the interactive level after reading of the file is finished.

## Return Values

Both `alias` and `unalias` return the void object of type `DOM_NULL`.

## Algorithms

The aliases are stored in the parser configuration table displayed by `_parser_config()`. Note that by default, alias back-substitution happens for the right sides of the equations in this table, but not for the indices. Use `print(_parser_config())` to display this table without alias back-substitution.

Aliases are not used while a file is read using `read` or `fread` with the option `Plain`. Conversely, if an alias is defined in a file which is read with option the `Plain`, the alias is only used until the file has been read completely.

## See Also

### MuPAD Functions

`:=` | `Pref::alias` | `alias` | `finput` | `fprint` | `fread` | `input` | `print` | `proc` | `read` | `subs` | `text2expr` | `write`



## anames

Identifiers that have values or properties

### Syntax

```
anames(<All>, <User>)
```

```
anames(<Properties>, <User>)
```

```
anames(<Protected>, <User>)
```

```
anames(d, <User>)
```

### Description

`anames(All)` returns all identifiers that have values.

`anames(Properties)` returns all identifiers that have properties.

`anames(Protected)` returns all identifiers that are protected.

`anames(d)` returns all identifiers that have values from the given domain `d`.

The result returned by `anames` is a set of *unevaluated* identifiers.

`anames` does not take into account slots on page 1-1980 of function environments on page 7-25 or domains (Symbolic Math Toolbox). Moreover, functions of a MuPAD library are considered only if they are exported.

### Examples

#### Example 1

`anames(All, User)` returns all user-defined identifiers:

```
a := b: b := 2: c := {2, 3}:  
anames(All, User)
```

$\{a, b, c\}$

If the first argument is a domain, only identifiers with *values* from that domain are returned. These may differ from the identifiers whose *evaluation* belongs to the domain:

```
a, b;  
anames(DOM_IDENT, User);  
anames(DOM_INT, User)
```

2, 2

$\{a\}$

$\{b\}$

## Example 2

`anames(Properties)` returns all identifiers that have been attached properties via `assume`:

```
assume(x > y): anames(Properties)
```

$\{x, y\}$

## Example 3

`anames(Protected)` returns all identifiers that are protected via `protect`; since all system functions are protected, we use `anames(Protected, User)`:

```
protect(a): anames(Protected, User)
```

$\{a\}$

## Parameters

**d**

A domain (Symbolic Math Toolbox)

## Options

**ALL**

Get all identifiers on page 7-29 that have values

**Properties**

Get all identifiers on page 7-29 that have properties (Symbolic Math Toolbox)

**Protected**

Get all identifiers on page 7-29 that are protected on page 1-1679

**User**

Exclude all system variables

If the option `User` is given, only those identifiers are returned that have been assigned a value or a property, respectively, by the user.

## Return Values

set of identifiers on page 7-29.

## See Also

**MuPAD Domains**

`DOM_IDENT`

**MuPAD Functions**

:= | \_assign | assume

## and\_and

Logical “and”

### Syntax

$b_1$  and  $b_2$

`_and(b1, b2, ...)`

### Description

$b_1$  and  $b_2$  represents the logical and of the Boolean expressions  $b_1$ ,  $b_2$ .

MuPAD uses a three state logic with the Boolean constants TRUE, FALSE, and UNKNOWN. These are processed as follows:

and	TRUE	FALSE	UNKNOWN
TRUE	TRUE	FALSE	UNKNOWN
FALSE	FALSE	FALSE	FALSE
UNKNOWN	UNKNOWN	FALSE	UNKNOWN

Boolean expressions can be composed of these constants as well as of arbitrary arithmetical expressions. Typically, equations, such as  $x = y$ , and inequalities, such as  $x <> y$ ,  $x < y$ , and  $x \leq y$ , are used to construct Boolean expressions.

`_and(b1, b2, ...)` is equivalent to  $b_1$  and  $b_2$  and  $\dots$ . This expression represents TRUE if every single expression evaluates to TRUE. It represents FALSE if at least one expression evaluates to FALSE. It represents UNKNOWN if at least one expression evaluates to UNKNOWN and all others evaluate to TRUE.

`_and()` returns TRUE.

Combinations of the constants TRUE, FALSE, UNKNOWN inside a Boolean expression are simplified automatically. However, symbolic Boolean subexpressions, equalities, and inequalities are not evaluated and simplified by logical operators. Use `bool` to evaluate

such expressions to one of the Boolean constants. Note, however, that `bool` can evaluate inequalities  $x < y$ ,  $x \leq y$  and so on only if they are composed of numbers of type `Type::Real`. See “Example 2” on page 1-133 (Symbolic Math Toolbox).

Use `simplify` with the option `logic` to simplify expressions involving symbolic Boolean subexpressions. See “Example 3” on page 1-134 (Symbolic Math Toolbox).

The precedences of the logical operators are as follows. If in doubt, use parentheses to ensure that the expression is parsed as desired.

- The operator `not` is stronger binding than `and`, that is, `not b1 and b2 = (not b1) and b2`.
- The operator `and` is stronger binding than `xor`, that is, `b1 and b2 or b3 = (b1 and b2) xor b3`.
- The operator `xor` is stronger binding than `or`, that is, `b1 xor b2 or b3 = (b1 xor b2) or b3`.
- The operator `or` is stronger binding than `==>`, that is, `b1 or b2 ==> b3 = (b1 or b2) ==> b3`.
- The operator `==>` is stronger binding than `<=>`, that is, `b1 ==> b2 <=> b3 = (b1 ==> b2) <=> b3`.

In the conditional context of `if`, `repeat`, and `while` statements, Boolean expressions are evaluated via “lazy evaluation” (see `_lazy_and`, `_lazy_or`). In any other context, all operands are evaluated.

## Examples

### Example 1

Combinations of the Boolean constants `TRUE`, `FALSE`, and `UNKNOWN` are simplified automatically to one of the constants:

`TRUE and not (FALSE or TRUE)`

`FALSE`

`FALSE and UNKNOWN, TRUE and UNKNOWN`

## FALSE, UNKNOWN

**Example 2**

Logical operators simplify subexpressions that evaluate to the constants TRUE, FALSE, UNKNOWN.

b1 or b2 and TRUE

$b1 \vee b2$

FALSE or ((not b1) and TRUE)

$\neg b1$

b1 and (b2 or FALSE) and UNKNOWN

$UNKNOWN \wedge b1 \wedge b2$

FALSE or (b1 and UNKNOWN) or  $x < 1$

$(UNKNOWN \wedge b1) \vee x < 1$

TRUE and ((b1 and FALSE) or (b1 and TRUE))

b1

However, equalities and inequalities are not evaluated:

$(x = x)$  and  $(1 < 2)$  and  $(2 < 3)$  and  $(3 < 4)$

$x = x \wedge 1 < 2 \wedge 2 < 3 \wedge 3 < 4$

Boolean evaluation is enforced via `bool`:

`bool(%)`

TRUE

### Example 3

Expressions involving symbolic Boolean subexpressions are not simplified by `and`, `or`, `not`. Simplification has to be requested explicitly via the function `simplify`:

```
(b1 and b2) or (b1 and (not b2)) and (1 < 2)
```

```
(b1 ^ b2) v (b1 ^ ¬ b2 ^ 1 < 2)
```

```
simplify(%, logic)
```

b1

### Example 4

The Boolean functions `_and` and `_or` accept arbitrary sequences of Boolean expressions. The following call uses `isprime` to check whether *all* elements of the given set are prime:

```
set := {1987, 1993, 1997, 1999, 2001}:  
_and(isprime(i) $ i in set)
```

FALSE

The following call checks whether *at least one* of the numbers is prime:

```
_or(isprime(i) $ i in set)
```

TRUE

```
delete set:
```



## Parameters

$b_1, b_2, \dots$

Boolean expressions

## Return Values

Boolean expression.

## Overloaded By

$b, b_1, b_2$

## See Also

### MuPAD Functions

`<=>` | `==>` | `FALSE` | `TRUE` | `UNKNOWN` | `_lazy_and` | `_lazy_or` | `bool` | `is` | `not` | `or` | `xor`

## or\_or

Logical “or”

### Syntax

$b_1$  or  $b_2$

`_or(b1, b2, ...)`

### Description

$b_1$  or  $b_2$  represents the non-exclusive logical or of the Boolean expressions  $b_1$ ,  $b_2$ .

MuPAD uses a three state logic with the Boolean constants TRUE, FALSE, and UNKNOWN. These are processed as follows:

or	TRUE	FALSE	UNKNOWN
TRUE	TRUE	TRUE	TRUE
FALSE	TRUE	FALSE	UNKNOWN
UNKNOWN	TRUE	UNKNOWN	UNKNOWN

Boolean expressions can be composed of these constants as well as of arbitrary arithmetical expressions. Typically, equations, such as  $x = y$ , and inequalities, such as  $x <> y$ ,  $x < y$ , and  $x \leq y$ , are used to construct Boolean expressions.

`_or(b1, b2, ...)` is equivalent to  $b_1$  or  $b_2$  or  $\dots$ . This expression represents FALSE if every single expression evaluates to FALSE. It represents TRUE if at least one expression evaluates to TRUE. It represents UNKNOWN if at least one expression evaluates to UNKNOWN and all others evaluate to FALSE.

`_or()` returns FALSE.

Combinations of the constants TRUE, FALSE, UNKNOWN inside a Boolean expression are simplified automatically. However, symbolic Boolean subexpressions, equalities, and inequalities are not evaluated and simplified by logical operators. Use `bool` to evaluate

such expressions to one of the Boolean constants. Note, however, that `bool` can evaluate inequalities  $x < y$ ,  $x \leq y$ , and so on only if they are composed of numbers of type `Type::Real`. See “Example 2” on page 1-138 (Symbolic Math Toolbox).

Use `simplify` with the option `logic` to simplify expressions involving symbolic Boolean subexpressions. See “Example 3” on page 1-139 (Symbolic Math Toolbox).

The precedences of the logical operators are as follows. If in doubt, use parentheses to ensure that the expression is parsed as desired.

- The operator `not` is stronger binding than `and`, that is, `not b1 and b2 = (not b1) and b2`.
- The operator `and` is stronger binding than `xor`, that is, `b1 and b2 or b3 = (b1 and b2) xor b3`.
- The operator `xor` is stronger binding than `or`, that is, `b1 xor b2 or b3 = (b1 xor b2) or b3`.
- The operator `or` is stronger binding than `==>`, that is, `b1 or b2 ==> b3 = (b1 or b2) ==> b3`.
- The operator `==>` is stronger binding than `<=>`, that is, `b1 ==> b2 <=> b3 = (b1 ==> b2) <=> b3`.

In the conditional context of `if`, `repeat`, and `while` statements, Boolean expressions are evaluated via “lazy evaluation” (see `_lazy_and`, `_lazy_or`). In any other context, all operands are evaluated.

## Examples

### Example 1

Combinations of the Boolean constants `TRUE`, `FALSE`, and `UNKNOWN` are simplified automatically to one of these constants:

`TRUE and not (FALSE or TRUE)`

`FALSE`

`FALSE or UNKNOWN, TRUE or UNKNOWN`

## UNKNOWN, TRUE

### Example 2

Logical operators simplify subexpressions that evaluate to the constants TRUE, FALSE, UNKNOWN.

b1 or b2 and TRUE

$b1 \vee b2$

FALSE or ((not b1) and TRUE)

$\neg b1$

b1 and (b2 or FALSE) and UNKNOWN

$UNKNOWN \wedge b1 \wedge b2$

FALSE or (b1 and UNKNOWN) or x < 1

$(UNKNOWN \wedge b1) \vee x < 1$

TRUE and ((b1 and FALSE) or (b1 and TRUE))

b1

However, equalities and inequalities are not evaluated:

(x = x) and (1 < 2) and (2 < 3) or (3 < 4)

$3 < 4 \vee (x = x \wedge 1 < 2 \wedge 2 < 3)$

Boolean evaluation is enforced via bool:

bool(%)

TRUE

### Example 3

Expressions involving symbolic Boolean subexpressions are not simplified by `and`, `or`, `not`. Simplification has to be requested explicitly via the function `simplify`:

```
(b1 and b2) or (b1 and (not b2)) and (1 < 2)
```

$$(b1 \wedge b2) \vee (b1 \wedge \neg b2 \wedge 1 < 2)$$

```
simplify(%, logic)
```

b1

### Example 4

The Boolean functions `_and` and `_or` accept arbitrary sequences of Boolean expressions. The following call uses `isprime` to check whether *at least one* of the numbers is prime:

```
set := {1987, 1993, 1997, 1999, 2001}:
_or(isprime(i) $ i in set)
```

TRUE

```
delete set:
```

## Parameters

**b<sub>1</sub>, b<sub>2</sub>, ...**

Boolean expressions

## **Return Values**

Boolean expression.

## **Overloaded By**

b, b\_1, b\_2

## **See Also**

### **MuPAD Functions**

<=> | ==> | FALSE | TRUE | UNKNOWN | \_lazy\_and | \_lazy\_or | and | bool | is | not | xor

# not\_not

Logical negation

## Syntax

`not b`

`_not(b)`

## Description

`not b` represents the logical negation of the Boolean expression `b`.

MuPAD uses a three state logic with the Boolean constants `TRUE`, `FALSE`, and `UNKNOWN`. These are processed as follows:

- `not TRUE = FALSE`
- `not FALSE = TRUE`
- `not UNKNOWN = UNKNOWN`

`_not(b)` is equivalent to `not b`.

Boolean expressions can be composed of these constants as well as of arbitrary arithmetical expressions. Typically, equations, such as  $x = y$ , and inequalities, such as  $x <> y$ ,  $x < y$ , and  $x \leq y$ , are used to construct Boolean expressions.

Combinations of the constants `TRUE`, `FALSE`, `UNKNOWN` inside a Boolean expression are simplified automatically. However, symbolic Boolean subexpressions, equalities, and inequalities are not evaluated and simplified by logical operators. Use `bool` to evaluate such expressions to one of the Boolean constants. Note, however, that `bool` can evaluate inequalities  $x < y$ ,  $x \leq y$  and so on only if they are composed of numbers of type `Type::Real`. See “Example 2” on page 1-143 (Symbolic Math Toolbox).

Use `simplify` with the option `logic` to simplify expressions involving symbolic Boolean subexpressions. See “Example 3” on page 1-143 (Symbolic Math Toolbox).

The precedences of the logical operators are as follows. If in doubt, use brackets to make sure that the expression is parsed as desired.

- The operator `not` is stronger binding than `and`, that is, `not b1 and b2 = (not b1) and b2`.
- The operator `and` is stronger binding than `xor`, that is, `b1 and b2 or b3 = (b1 and b2) xor b3`.
- The operator `xor` is stronger binding than `or`, that is, `b1 xor b2 or b3 = (b1 xor b2) or b3`.
- The operator `or` is stronger binding than `==>`, that is, `b1 or b2 ==> b3 = (b1 or b2) ==> b3`.
- The operator `==>` is stronger binding than `<=>`, that is, `b1 ==> b2 <=> b3 = (b1 ==> b2) <=> b3`.

In the conditional context of `if`, `repeat`, and `while` statements, Boolean expressions are evaluated via “lazy evaluation” (see `_lazy_and`, `_lazy_or`). In any other context, all operands are evaluated.

## Examples

### Example 1

Combinations of the Boolean constants `TRUE`, `FALSE`, and `UNKNOWN` are simplified automatically to one of these constants:

`TRUE and not (FALSE or TRUE)`

`FALSE`

`not UNKNOWN`

`UNKNOWN`



## Example 2

Logical operators simplify subexpressions that evaluate to the constants TRUE, FALSE, UNKNOWN.

`b1 or b2 and (not FALSE)`

`b1 ∨ b2`

`FALSE or ((not b1) and TRUE)`

`¬ b1`

`b1 and (b2 or FALSE) and (not UNKNOWN)`

`UNKNOWN ∧ b1 ∧ b2`

However, equalities and inequalities are not evaluated:

`not(x = x) and (1 < 2) and (2 < 3) and (3 > 4)`

`x ≠ x ∧ 1 < 2 ∧ 2 < 3 ∧ 4 < 3`

Boolean evaluation is enforced via `bool`:

`bool(%)`

`FALSE`

## Example 3

Expressions involving symbolic Boolean subexpressions are not simplified by `and`, `or`, `not`. Simplification has to be requested explicitly via the function `simplify`:

`(b1 and b2) or (b1 and (not b2)) and (1 < 2)`

`(b1 ∧ b2) ∨ (b1 ∧ ¬ b2 ∧ 1 < 2)`

`simplify(%, logic)`

`bl`

## Parameters

**b**

Boolean expressions

## Return Values

Boolean expression.

## Overloaded By

b, b\_1, b\_2

## See Also

### MuPAD Functions

`<=>` | `==>` | `FALSE` | `TRUE` | `UNKNOWN` | `_lazy_and` | `_lazy_or` | `and` | `bool` | `is` | `or` | `xor`

## xor\_xor

Logical exclusive-or

### Syntax

$b_1 \text{ xor } b_2$

`_xor(b1, b2, ...)`

### Description

$b_1 \text{ xor } b_2$  represents the exclusive logical or of the Boolean expressions  $b_1$ ,  $b_2$ .

$\text{xor}$  is defined as follows:  $a \text{ xor } b$  is equivalent to  $(a \text{ or } b)$  and not  $(a \text{ and } b)$ .

MuPAD uses a three state logic with the Boolean constants **TRUE**, **FALSE**, and **UNKNOWN**. These are processed as follows:

or	TRUE	FALSE	UNKNOWN
TRUE	TRUE	TRUE	TRUE
FALSE	TRUE	FALSE	UNKNOWN
UNKNOWN	TRUE	UNKNOWN	UNKNOWN

Boolean expressions can be composed of these constants as well as of arbitrary arithmetical expressions. Typically, equations, such as  $x = y$ , and inequalities, such as  $x <> y$ ,  $x < y$ ,  $x \leq y$ , are used to construct Boolean expressions.

`_xor(b1, b2, ...)` is equivalent to  $b_1 \text{ xor } b_2 \text{ xor } \dots$ . This expression represents **TRUE** if an odd number of operands evaluate to **TRUE** and the others evaluate to **FALSE**. It represents **FALSE** if an even number of operands evaluate to **TRUE** and the others evaluate to **FALSE**. It represents **UNKNOWN** if at least one operand evaluates to **UNKNOWN**.

Combinations of the constants **TRUE**, **FALSE**, **UNKNOWN** inside a Boolean expression are simplified automatically. However, symbolic Boolean subexpressions, equalities, and inequalities are not evaluated and simplified by logical operators. Use `bool` to evaluate

such expressions to one of the Boolean constants. Note, however, that `bool` can evaluate inequalities  $x < y$ ,  $x \leq y$ , and so on only if they are composed of numbers of type `Type::Real`. See “Example 2” on page 1-147 (Symbolic Math Toolbox).

Use `simplify` with the option `logic` to simplify expressions involving symbolic Boolean subexpressions. See “Example 3” on page 1-148 (Symbolic Math Toolbox).

The precedences of the logical operators are as follows. If in doubt, use parentheses to ensure that the expression is parsed as desired.

- The operator `not` is stronger binding than `and`, that is, `not b1 and b2 = (not b1) and b2`.
- The operator `and` is stronger binding than `xor`, that is, `b1 and b2 or b3 = (b1 and b2) xor b3`.
- The operator `xor` is stronger binding than `or`, that is, `b1 xor b2 or b3 = (b1 xor b2) or b3`.
- The operator `or` is stronger binding than `==>`, that is, `b1 or b2 ==> b3 = (b1 or b2) ==> b3`.
- The operator `==>` is stronger binding than `<=>`, that is, `b1 ==> b2 <=> b3 = (b1 ==> b2) <=> b3`.

In the conditional context of `if`, `repeat`, and `while` statements, Boolean expressions are evaluated via “lazy evaluation” (see `_lazy_and`, `_lazy_or`). In any other context, all operands are evaluated.

## Examples

### Example 1

Combinations of the Boolean constants `TRUE`, `FALSE`, and `UNKNOWN` are simplified automatically to one of these constants:

`TRUE and (FALSE xor TRUE)`

`TRUE`

`FALSE xor UNKNOWN, TRUE xor FALSE`

UNKNOWN, TRUE

## Example 2

Logical operators simplify subexpressions that evaluate to the constants TRUE, FALSE, UNKNOWN.

`b1 xor b2 and TRUE`

`b1 xor b2`

`FALSE xor ((not b1) and TRUE)`

`¬ b1`

`b1 and (b2 xor FALSE) and UNKNOWN`

`UNKNOWN ∧ b1 ∧ b2`

`FALSE or (b1 and UNKNOWN) xor x < 1`

`(UNKNOWN ∧ b1) xor x < 1`

`TRUE xor ((b1 and FALSE) or (b1 and TRUE))`

`¬ b1`

However, equalities and inequalities are not evaluated:

`(x = x) and (1 < 2) and (2 < 3) xor (3 < 4)`

`(x = x ∧ 1 < 2 ∧ 2 < 3) xor 3 < 4`

Boolean evaluation is enforced via `bool`:

`bool(%)`

FALSE

### Example 3

Expressions involving symbolic Boolean subexpressions are not simplified by `and`, `or`, `not`. Simplification has to be requested explicitly via the function `simplify`:

```
(b1 and b2) xor (b1 and (not b2)) and (1 < 2)
```

```
(b1 ^ b2) xor (b1 ^ ~ b2 ^ 1 < 2)
```

```
simplify(%, logic)
```

```
b1
```

## Parameters

**b<sub>1</sub>, b<sub>2</sub>, ...**

Boolean expressions

## Return Values

Boolean expression.

## Overloaded By

b, b\_1, b\_2

## See Also

### MuPAD Functions

`<=>` | `==>` | `FALSE` | `TRUE` | `UNKNOWN` | `_lazy_and` | `_lazy_or` | `and` | `bool` | `is` | `not` | `or`

## **==>\_implies**

Logical implication

### **Syntax**

$b_1 \implies b_2$

`_implies(b1, b2)`

### **Description**

$b_1 \implies b_2$  represents the logical implication of the Boolean expressions  $b_1$ ,  $b_2$ .

$a \implies b$  is equivalent to `not a or b`. See “Example 1” on page 1-151 (Symbolic Math Toolbox).

`_implies(a, b)` is equivalent to  $a \implies b$ .

MuPAD uses a three state logic with the Boolean constants `TRUE`, `FALSE`, and `UNKNOWN`. These are processed as follows:

<code>and</code>	<code>TRUE</code>	<code>FALSE</code>	<code>UNKNOWN</code>
<code>TRUE</code>	<code>TRUE</code>	<code>FALSE</code>	<code>UNKNOWN</code>
<code>FALSE</code>	<code>FALSE</code>	<code>FALSE</code>	<code>FALSE</code>
<code>UNKNOWN</code>	<code>UNKNOWN</code>	<code>FALSE</code>	<code>UNKNOWN</code>

Boolean expressions can be composed of these constants as well as of arbitrary arithmetical expressions. Typically, equations, such as  $x = y$ , and inequalities, such as  $x <> y$ ,  $x < y$ ,  $x <= y$ , are used to construct Boolean expressions.

Combinations of the constants `TRUE`, `FALSE`, `UNKNOWN` inside a Boolean expression are simplified automatically. However, symbolic Boolean subexpressions, equalities, and inequalities are not evaluated and simplified by logical operators. Use `bool` to evaluate such expressions to one of the Boolean constants. Note, however, that `bool` can evaluate inequalities  $x < y$ ,  $x <= y$ , and so on, only if they are composed of numbers of type `Type::Real`.



Use `simplify` with the option `logic` to simplify expressions involving symbolic Boolean subexpressions. See “Example 1” on page 1-151 (Symbolic Math Toolbox).

The precedences of the logical operators are as follows. If in doubt, use parentheses to ensure that the expression is parsed as desired.

- The operator `not` is stronger binding than `and`, that is, `not b1 and b2 = (not b1) and b2`.
- The operator `and` is stronger binding than `xor`, that is, `b1 and b2 or b3 = (b1 and b2) xor b3`.
- The operator `xor` is stronger binding than `or`, that is, `b1 xor b2 or b3 = (b1 xor b2) or b3`.
- The operator `or` is stronger binding than `==>`, that is, `b1 or b2 ==> b3 = (b1 or b2) ==> b3`.
- The operator `==>` is stronger binding than `<=>`, that is, `b1 ==> b2 <=> b3 = (b1 ==> b2) <=> b3`.

In the conditional context of `if`, `repeat`, and `while` statements, Boolean expressions are evaluated via “lazy evaluation” (see `_lazy_and`, `_lazy_or`). In any other context, all operands are evaluated.

## Examples

### Example 1

`a ==> b` is equivalent to `not a or b`.

```
simplify((a ==> b), logic)
```

$$\neg a \vee b$$

```
not a or b
```

$$\neg a \vee b$$

## Parameters

**b<sub>1</sub>, b<sub>2</sub>**

Boolean expressions

## Return Values

Boolean expression.

## Overloaded By

**b, b\_1, b\_2**

## See Also

### **MuPAD Functions**

`<=>` | `FALSE` | `TRUE` | `UNKNOWN` | `_lazy_and` | `_lazy_or` | `and` | `bool` | `is` | `not` | `or` | `xor`

## <=>\_equiv

Logical equivalence

### Syntax

$b_1 \Leftrightarrow b_2$

`_equiv(b1, b2)`

### Description

$b_1 \Leftrightarrow b_2$  represents the logical equivalence of the Boolean expressions  $b_1$ ,  $b_2$ .

$a \Leftrightarrow b$  is equivalent to  $(a \Rightarrow b)$  and  $(b \Rightarrow a)$ , where  $a \Rightarrow b$  is equivalent to not  $a$  or  $b$ .

`_equiv(a, b)` is equivalent to  $a \Leftrightarrow b$ .

MuPAD uses a three state logic with the Boolean constants TRUE, FALSE, and UNKNOWN. These are processed as follows:

and	TRUE	FALSE	UNKNOWN
TRUE	TRUE	FALSE	UNKNOWN
FALSE	FALSE	FALSE	FALSE
UNKNOWN	UNKNOWN	FALSE	UNKNOWN

Boolean expressions can be composed of these constants as well as of arbitrary arithmetical expressions. Typically, equations, such as  $x = y$ , and inequalities, such as  $x <> y$ ,  $x < y$ ,  $x \leq y$ , are used to construct Boolean expressions.

Combinations of the constants TRUE, FALSE, UNKNOWN inside a Boolean expression are simplified automatically. However, symbolic Boolean subexpressions, equalities, and inequalities are not evaluated and simplified by logical operators. Use `bool` to evaluate such expressions to one of the Boolean constants. Note, however, that `bool` can evaluate inequalities  $x < y$ ,  $x \leq y$  and so on, only if they are composed of numbers of type `Type::Real`.

Use `simplify` with the option `logic` to simplify expressions involving symbolic Boolean subexpressions. See “Example 1” on page 1-154 (Symbolic Math Toolbox).

The precedences of the logical operators are as follows. If in doubt, use parentheses to ensure that the expression is parsed as desired.

- The operator `not` is stronger binding than `and`, that is, `not b1 and b2 = (not b1) and b2`.
- The operator `and` is stronger binding than `xor`, that is, `b1 and b2 or b3 = (b1 and b2) xor b3`.
- The operator `xor` is stronger binding than `or`, that is, `b1 xor b2 or b3 = (b1 xor b2) or b3`.
- The operator `or` is stronger binding than `==>`, that is, `b1 or b2 ==> b3 = (b1 or b2) ==> b3`.
- The operator `==>` is stronger binding than `<=>`, that is, `b1 ==> b2 <=> b3 = (b1 ==> b2) <=> b3`.

In the conditional context of `if`, `repeat`, and `while` statements, Boolean expressions are evaluated via “lazy evaluation” (see `_lazy_and`, `_lazy_or`). In any other context, all operands are evaluated.

## Examples

### Example 1

`a <=> b` is equivalent to `(a ==> b) and (b ==> a)`, where `a ==> b` is equivalent to `not a or b`.

```
simplify((a <=> b), logic)
```

```
(a & b) v (~a & ~b)
```

```
simplify((a ==> b) and (b ==> a), logic)
```

```
(a & b) v (~a & ~b)
```

## Parameters

`b1`, `b2`

Boolean expressions

## Return Values

Boolean expression.

## Overloaded By

`b`, `b_1`, `b_2`

## See Also

### MuPAD Functions

`==>` | `FALSE` | `TRUE` | `UNKNOWN` | `_lazy_and` | `_lazy_or` | `and` | `bool` | `is` | `not` | `or` | `xor`

## append

Add elements to a list

---

**Note** To append in MATLAB®, see “Concatenating matrices” at “Creating, Concatenating, and Expanding Matrices” (MATLAB).

---

### Syntax

```
append(l, object1, object2, ...)
```

### Description

`append(l, object)` adds `object` to the list `l`.

`append(l, object1, object2, ...)` appends `object1`, `object2`, etc. to the list on page 7-41 `l` and returns the new list as the result.

`append(f(x), object1, object2, ...)` appends `object1`, `object2`, etc. to the expression on page 7-20 `f(x)` and returns the new expression as the result.

The call `append(l)` is legal and returns `l`.

`append(l, object1, object2, ...)` is equivalent to both `[op(l), object1, object2, ...]` and `l.[object1, object2, ...]`. However, `append` is more efficient.

The function `append` always returns a new object. The first argument remains unchanged. See “Example 3” on page 1-157 (Symbolic Math Toolbox).

### Examples

#### Example 1

The function `append` adds new elements to the end of a list:

```
append([a, b], c, d)
```

*[a, b, c, d]*

If no new elements are given, the first argument is returned unmodified:

```
l := [a, b]: append(l)
```

*[a, b]*

The first argument may be an empty list:

```
append([], c)
```

*[c]*

## Example 2

The function `append` adds new elements to the end of an expression:

```
append(f(a, b), c, d)
```

*f(a, b, c, d)*

Expressions can be written in operator notation:

```
append(a + b, c)
```

*a + b + c*

## Example 3

The function `append` always returns a new object. The first argument remains unchanged:

```
l := [a, b]: append(l, c, d), l
```

$[a, b, c, d], [a, b]$

## Example 4

Users can overload (Symbolic Math Toolbox) `append` for their own domains (Symbolic Math Toolbox). For illustration, we create a new domain `T` and supply it with an "append" slot, which simply adds the remaining arguments to the internal operands of its first argument:

```
T := newDomain("T");  
T::append := x -> new(T, extop(x), args(2..args(0))):
```

If we now call `append` with an object of domain type `T`, the slot routine `T::append` is invoked:

```
e := new(T, 1, 2): append(e, 3)
```

$new(T, 1, 2, 3)$

## Parameters

⌋

A list on page 7-41 or an expression on page 7-20

**object1, object2, ...**

Arbitrary MuPAD objects

## Return Values

Extended list on page 7-41 or expression on page 7-20.

## Overloaded By

⌋



## See Also

### **MuPAD Domains**

DOM\_EXPR | DOM\_LIST

### **MuPAD Functions**

\_concat | \_index | op

# arcsin

Inverse sine function

---

**Note** For arcsine in MATLAB<sup>®</sup>, see `asin`.

---

## Syntax

`arcsin(x)`

## Description

`arcsin(x)` represents the inverse of the sine function.

The angle returned by this function is measured in radians, not in degrees. For example, the result  $\pi$  represents an angle of  $180^\circ$ .

`arcsin` is defined for complex arguments.

Floating-point values are returned for floating-point arguments. Floating-point intervals are returned for interval arguments. Unevaluated function calls are returned for most exact arguments.

If the argument is a rational multiple of  $\pi$ , the result is expressed in terms of hyperbolic functions. See “Example 2” on page 1-162 (Symbolic Math Toolbox).

The inverse sine function is multivalued. The MuPAD `arcsin` function returns the value on the main branch. The branch cuts are the real intervals  $(-\infty, -1)$  and  $(1, \infty)$ . Thus,

`arcsin` returns values, such that  $y = \arcsin(x)$  satisfies  $-\frac{\pi}{2} \leq \Re(y) \leq \frac{\pi}{2}$  for any finite complex  $x$ .

The `sin` function returns explicit values for arguments that are certain rational multiples of  $\pi$ . For these values, `arcsin` returns an appropriate rational multiple of  $\pi$  on the main branch. See “Example 3” on page 1-162 (Symbolic Math Toolbox).

The values jump when the arguments cross a branch cut. See “Example 4” on page 1-163 (Symbolic Math Toolbox).

The float attributes are kernel functions. Thus, floating-point evaluation is fast.

## Environment Interactions

When called with a floating-point argument, `arcsin` is sensitive to the environment variable `DIGITS` which determines the numerical working precision.

## Examples

### Example 1

Call `arcsin` with the following exact and symbolic input arguments:

```
arcsin(1), arcsin(1/sqrt(2)), arcsin(5 + I),
arcsin(1/3), arcsin(I), arcsin(sqrt(2))
```

$$\frac{\pi}{2}, \frac{\pi}{4}, \arcsin(5 + i), \arcsin\left(\frac{1}{3}\right), \operatorname{arcsinh}(1) i, \arcsin(\sqrt{2})$$

```
arcsin(-x), arcsin(x + 1), arcsin(1/x)
```

$$-\arcsin(x), \arcsin(x + 1), \arcsin\left(\frac{1}{x}\right)$$

Floating-point values are computed for floating-point arguments:

```
arcsin(0.1234), arcsin(5.6 + 7.8*I), arcsin(1.0/10^20)
```

$$0.1237153458, 0.6201083498 + 2.956002937 i, 1.0 \cdot 10^{-20}$$

Floating-point intervals are computed for interval arguments:

```
arcsin(-1/2...1/2), arcsin(0...1)
```

`-0.5235987756 ... 0.5235987756, 0.0 ... 1.570796327`

## Example 2

Arguments that are rational multiples of  $I$  are rewritten in terms of hyperbolic functions:

`arcsin(5*I), arcsin(5/4*I), arcsin(-3*I)`

`arcsinh(5) i, arcsinh( $\frac{5}{4}$ ) i, -arcsinh(3) i`

For other complex arguments unevaluated function calls without simplifications are returned:

`arcsin(1/2^(1/2) + I), arcsin(1 - 3*I)`

`arcsin( $\frac{\sqrt{2}}{2} + i$ ), arcsin(1 - 3 i)`

## Example 3

Some special values are implemented:

`arcsin(1/sqrt(2)), arcsin((5^(1/2) - 1)/4), arcsin(3^(1/2)/2)`

`$\frac{\pi}{4}$ ,  $\frac{\pi}{10}$ ,  $\frac{\pi}{3}$`

Such simplifications occur for arguments that are trigonometric images of rational multiples of  $\pi$ :

`sin(9/10*PI), arcsin(sin(9/10*PI))`

`$\frac{\sqrt{5}}{4} - \frac{1}{4}$ ,  $\frac{\pi}{10}$`

## Example 4

The values jump when crossing a branch cut:

```
arcsin(2.0 + I/10^10), arcsin(2.0 - I/10^10)
```

```
1.570796327 + 1.316957897 i, 1.570796327 - 1.316957897 i
```

On the branch cut, the values of arcsin coincide with the limit “from below” for real arguments  $x > 1$ :

```
limit(arcsin(2.0 - I/n), n = infinity);
limit(arcsin(2.0 + I/n), n = infinity);
arcsin(2.0)
```

```
1.570796327 - 1.316957897 i
```

```
1.570796327 + 1.316957897 i
```

```
1.570796327 - 1.316957897 i
```

The values coincide with the limit “from above” for real  $x < -1$ :

```
limit(arcsin(-2.0 - I/n), n = infinity);
limit(arcsin(-2.0 + I/n), n = infinity);
arcsin(-2.0)
```

```
- 1.570796327 - 1.316957897 i
```

```
- 1.570796327 + 1.316957897 i
```

```
- 1.570796327 + 1.316957897 i
```

## Example 5

The inverse sine function can be rewritten in terms of the logarithm function with complex arguments:

```
rewrite(arcsin(x), ln)
```

$$-\ln\left(\sqrt{1-x^2}+xi\right) i$$

## Example 6

diff, float, limit, or taylor, series, and other system functions handle expressions involving the inverse trigonometric functions:

```
diff(arcsin(x^2), x), float(arcsin(3)*arctan(5 + I))
```

$$\frac{2x}{\sqrt{1-x^4}}, 2.233958827 - 2.375264116 i$$

```
limit(arcsin(1 + sin(x)/x), x = PI)
```

$$\frac{\pi}{2}$$

```
taylor(arcsin(x), x = 0)
```

$$x + \frac{x^3}{6} + \frac{3x^5}{40} + O(x^7)$$

```
series(arcsin(2 + x), x, 3)
```

$$\frac{\pi}{2} + \text{signIm}(x+2) \arccos(2) + \frac{\sqrt{3} x \text{signIm}(x+2) i}{3} - \frac{\sqrt{3} x^2 \text{signIm}(x+2) i}{9} + O(x^3)$$

## Parameters

$x$

Arithmetical expression (Symbolic Math Toolbox) or floating-point interval on page 7-33

## Return Values

Arithmetical expression or floating-point interval.

## Overloaded By

$x$

## See Also

### MuPAD Functions

arccos | arccot | arccsc | arcsec | arctan | arg | cos | cot | csc | sec | sin | tan

## arccos

Inverse cosine function

### Syntax

`arccos(x)`

### Description

`arccos(x)` represents the inverse of the cosine function.

The angle returned by this function is measured in radians, not in degrees. For example, the result  $\pi$  represents an angle of  $180^\circ$ .

`arccos` is defined for complex arguments.

Floating-point values are returned for floating-point arguments. Floating-point intervals are returned for interval arguments. Unevaluated function calls are returned for most exact arguments.

If the argument is a rational multiple of  $\mathbf{I}$ , the result is expressed in terms of hyperbolic functions. See “Example 2” on page 1-168 (Symbolic Math Toolbox).

The inverse cosine function is multivalued. The MuPAD `arccos` function returns the value on the main branch. The branch cuts are the real intervals  $(-\infty, -1)$  and  $(1, \infty)$ . Thus,

`arccos` returns values, such that  $y = \text{arccos}(x)$  satisfies  $0 \leq \Re(y) \leq \pi$  for any finite complex  $x$ .

The `cos` function returns explicit values for arguments that are certain rational multiples of  $\pi$ . For these values, `arccos` returns an appropriate rational multiple of  $\pi$  on the main branch. See “Example 3” on page 1-168 (Symbolic Math Toolbox).

The values jump when the arguments cross a branch cut. See “Example 4” on page 1-168 (Symbolic Math Toolbox).

The float attributes are kernel functions. Thus, floating-point evaluation is fast.



## Environment Interactions

When called with a floating-point argument, `arccos` is sensitive to the environment variable `DIGITS` which determines the numerical working precision.

## Examples

### Example 1

Call `arccos` with the following exact and symbolic input arguments:

```
arccos(1), arccos(1/sqrt(2)), arccos(5 + I),
arccos(1/3), arccos(I), arccos(sqrt(2))
```

$$0, \frac{\pi}{4}, \arccos(5 + i), \arccos\left(\frac{1}{3}\right), \frac{\pi}{2} - \operatorname{arcsinh}(1) i, \arccos(\sqrt{2})$$

```
arccos(-x), arccos(x + 1), arccos(1/x)
```

$$\pi - \arccos(x), \arccos(x + 1), \arccos\left(\frac{1}{x}\right)$$

Floating-point values are computed for floating-point arguments:

```
arccos(0.1234), arccos(5.6 + 7.8*I), arccos(1.0/10^20)
```

$$1.447080981, 0.950687977 - 2.956002937 i, 1.570796327$$

Floating-point intervals are computed for interval arguments:

```
arccos(-1/2...1/2), arccos(0...1)
```

$$1.047197551 \dots 2.094395103, -3.469446952 \cdot 10^{-18} \dots 1.570796327$$

## Example 2

Arguments that are rational multiples of I are rewritten in terms of hyperbolic functions:

`arccos(2*I), arccos(-I/2), arccos(-3*I)`

$$\frac{\pi}{2} - \operatorname{arcsinh}(2) i, \frac{\pi}{2} + \operatorname{arcsinh}\left(\frac{1}{2}\right) i, \frac{\pi}{2} + \operatorname{arcsinh}(3) i$$

For other complex arguments unevaluated function calls without simplifications are returned:

`arccos(1/2^(1/2) + I), arccos(1 - 3*I)`

$$\operatorname{arccos}\left(\frac{\sqrt{2}}{2} + i\right), \operatorname{arccos}(1 - 3 i)$$

## Example 3

Some special values are implemented:

`arccos(1/sqrt(2)), arccos((5^(1/2) - 1)/4), arccos(1/2)`

$$\frac{\pi}{4}, \frac{2\pi}{5}, \frac{\pi}{3}$$

Such simplifications occur for arguments that are trigonometric images of rational multiples of  $\pi$ :

`cos(9/10*PI), arccos(cos(9/10*PI))`

$$-\frac{\sqrt{2}\sqrt{\sqrt{5}+5}}{4}, \frac{9\pi}{10}$$

## Example 4

The values jump when crossing a branch cut:

`arccos(-2.0 + I/10^10), arccos(-2.0 - I/10^10)`

`3.141592654 - 1.316957897 i, 3.141592654 + 1.316957897 i`

On the branch cut, the values of `arccos` coincide with the limit “from below” for real arguments  $x > 1$ :

`limit(arccos(2.0 - I/n), n = infinity);`  
`limit(arccos(2.0 + I/n), n = infinity);`  
`arccos(2.0)`

`1.316957897 i`

`- 1.316957897 i`

`1.316957897 i`

The values coincide with the limit “from above” for real  $x < -1$ :

`limit(arccos(-2.0 - I/n), n = infinity);`  
`limit(arccos(-2.0 + I/n), n = infinity);`  
`arccos(-2.0)`

`3.141592654 + 1.316957897 i`

`3.141592654 - 1.316957897 i`

`3.141592654 - 1.316957897 i`

## Example 5

The inverse cosine function can be rewritten in terms of the logarithm function with complex arguments:

`rewrite(arccos(x), ln)`

$$-\ln\left(x + \sqrt{1-x^2} i\right) i$$

## Example 6

diff, float, limit, taylor, series, and other system functions handle expressions involving the inverse trigonometric functions:

`diff(arccos(x), x), float(arccos(3)*arctan(5 + I))`

$$-\frac{1}{\sqrt{1-x^2}}, -0.06540673615 + 2.433548516 i$$

`limit(arccos(1 + sin(x)/x), x = 0)`

$$\ln(\sqrt{3} + 2) i$$

`taylor(arccos(x), x = 0)`

$$\frac{\pi}{2} - x - \frac{x^3}{6} - \frac{3x^5}{40} + O(x^7)$$

`series(arccos(2 + x), x, 3)`

$$-\operatorname{signIm}(x+2) \arccos(2) - \frac{\sqrt{3} x \operatorname{signIm}(x+2) i}{3} + \frac{\sqrt{3} x^2 \operatorname{signIm}(x+2) i}{9} + O(x^3)$$

## Parameters

**x**

Arithmetical expression (Symbolic Math Toolbox) or floating-point interval on page 7-33

## Return Values

Arithmetical expression or floating-point interval.

## Overloaded By

x

## See Also

### **MuPAD Functions**

arccot | arccsc | arcsec | arcsin | arctan | arg | cos | cot | csc | sec | sin | tan

# arctan

Inverse tangent function

---

**Note** For arctan in MATLAB®, see atan.

---

## Syntax

arctan(x)

arctan(y, x)

## Description

arctan(x) represents the inverse of the tangent function.

arctan(y, x) is an alias for arg(x, y).

The angle returned by this function is measured in radians, not in degrees. For example, the result  $\pi$  represents an angle of 180°.

arctan is defined for complex arguments.

Floating-point values are returned for floating-point arguments. Floating-point intervals are returned for interval arguments. Unevaluated function calls are returned for most exact arguments.

If the argument is a rational multiple of  $\mathbf{I}$ , the result is expressed in terms of hyperbolic functions. See “Example 2” on page 1-174 (Symbolic Math Toolbox).

The inverse tangent function is multivalued. The MuPAD arctan function returns the value on the main branch. The branch cuts are the intervals  $(-i\infty, -i]$  and  $[i, i\infty)$  on the imaginary axis. Thus, arctan returns values, such that  $y = arctan(x)$  satisfies

$$-\frac{\pi}{2} < \Re(y) < \frac{\pi}{2} \text{ for any finite complex } x.$$

The `tan` function returns explicit values for arguments that are certain rational multiples of  $\pi$ . For these values, `arctan` returns an appropriate rational multiple of  $\pi$  on the main branch. See “Example 3” on page 1-174 (Symbolic Math Toolbox).

The values jump when the arguments cross a branch cut. See “Example 4” on page 1-175 (Symbolic Math Toolbox).

The float attributes are kernel functions. Thus, floating-point evaluation is fast.

If you call `arctan` with two arguments,  $y$  and  $x$ , MuPAD calls the `arg` function that computes the polar angle of a complex number  $x + I*y$ . See “Example 7” on page 1-176 (Symbolic Math Toolbox) and the `arg` help page.

## Environment Interactions

When called with a floating-point argument, `arctan` is sensitive to the environment variable `DIGITS` which determines the numerical working precision.

## Examples

### Example 1

Call `arctan` with the following exact and symbolic input arguments:

```
arctan(-5), arctan(1/sqrt(2)), arctan(5 + I),
arctan(1/3), arctan(0), arctan(1)
```

$$-\arctan(5), \arctan\left(\frac{\sqrt{2}}{2}\right), \arctan(5 + i), \arctan\left(\frac{1}{3}\right), 0, \frac{\pi}{4}$$

```
arctan(-x), arctan(x + 1), arctan(1/x)
```

$$-\arctan(x), \arctan(x + 1), \arctan\left(\frac{1}{x}\right)$$

Floating-point values are computed for floating-point arguments:

```
arctan(0.1234), arctan(5.6 + 7.8*I), arctan(1.0/10^20)
```

$$0.1227793009, 1.509698741 + 0.08448597681 i, 1.0 \cdot 10^{-20}$$

Floating-point intervals are computed for interval arguments:

$$\arctan(-2 \dots 2), \arctan(0 \dots 10)$$

$$-1.107148718 \dots 1.107148718, 0.0 \dots 1.471127675$$

## Example 2

Arguments that are rational multiples of  $I$  are rewritten in terms of hyperbolic functions:

$$\arcsin(5 \cdot I), \arccos(5/4 \cdot I), \arctan(-3 \cdot I)$$

$$\operatorname{arcsinh}(5) i, \frac{\pi}{2} - \operatorname{arcsinh}\left(\frac{5}{4}\right) i, -\operatorname{arctanh}(3) i$$

For other complex arguments unevaluated function calls without simplifications are returned:

$$\arcsin(1/2^{(1/2)} + I), \arccos(1 - 3 \cdot I)$$

$$\arcsin\left(\frac{\sqrt{2}}{2} + i\right), \arccos(1 - 3 i)$$

## Example 3

Some special values are implemented:

$$\arctan(1), \arctan((5 - 2 \cdot 5^{(1/2)})^{(1/2)}), \arctan(3^{(1/2)} - 2)$$

$$\frac{\pi}{4}, \frac{\pi}{5}, -\frac{\pi}{12}$$

Such simplifications occur for arguments that are trigonometric images of rational multiples of  $\pi$ :



`tan(9/10*PI), arctan(tan(9/10*PI))`

$$-\frac{\sqrt{5} \sqrt{5-2\sqrt{5}}}{5}, -\frac{\pi}{10}$$

### Example 4

The values jump when crossing a branch cut:

`arctan(2.0*I + 10^(-10)), arctan(2.0*I - 10^(-10))`

$$1.570796327 + 0.5493061443 i, -1.570796327 + 0.5493061443 i$$

On the branch cut, the values of `arctan` coincide with the limit “from the right” for imaginary arguments  $x = c*i$  where  $c > 1$ :

`limit(arctan(2.0*I - 1/n), n = infinity);`  
`limit(arctan(2.0*I + 1/n), n = infinity);`  
`arctan(2.0*I)`

$$-1.570796327 + 0.5493061443 i$$

$$1.570796327 + 0.5493061443 i$$

$$1.570796327 + 0.5493061443 i$$

The values coincide with the limit “from the left” for imaginary arguments  $x = c*i$  where  $c < -1$ :

`limit(arctan(-2.0*I - 1/n), n = infinity);`  
`limit(arctan(-2.0*I + 1/n), n = infinity);`  
`arctan(-2.0*I)`

$$-1.570796327 - 0.5493061443 i$$

$$1.570796327 - 0.5493061443 i$$

$$-1.570796327 - 0.5493061443 i$$

### Example 5

The inverse tangent function can be rewritten in terms of the logarithm function with complex arguments:

`rewrite(arctan(x), ln)`

$$\frac{\ln(1 - xi) i}{2} - \frac{\ln(1 + xi) i}{2}$$

### Example 6

`diff`, `float`, `limit`, `taylor`, and other system functions handle expressions involving the inverse trigonometric functions:

`diff(arctan(x), x), float(arccos(3)*arctan(5 + I))`

$$\frac{1}{x^2 + 1}, -0.06540673615 + 2.433548516 i$$

`limit(arctan(sin(x)/tan(x)), x = 0)`

$$\frac{\pi}{4}$$

`taylor(arctan(x), x = 0)`

$$x - \frac{x^3}{3} + \frac{x^5}{5} + O(x^7)$$

### Example 7

When you call `arctan` with two arguments, MuPAD calls the `arg` function and computes the polar angle of a complex number:

`arctan(y, x)`

`arg(x + y i)`

## Parameters

**x**

Arithmetical expression (Symbolic Math Toolbox) or floating-point interval on page 7-33

**y, x**

Arithmetical expressions (Symbolic Math Toolbox) representing real numbers

## Return Values

Arithmetical expression or floating-point interval.

## Overloaded By

x

## See Also

### MuPAD Functions

`arccos` | `arccot` | `arccsc` | `arcsec` | `arcsin` | `arg` | `cos` | `cot` | `csc` | `sec` | `sin` | `tan`

## arccsc

Inverse cosecant function

### Syntax

`arccsc(x)`

### Description

`arccsc(x)` represents the inverse of the cosecant function.

The angle returned by this function is measured in radians, not in degrees. For example, the result  $\pi$  represents an angle of  $180^\circ$ .

`arccsc` is defined for complex arguments.

Floating-point values are returned for floating-point arguments. Floating-point intervals are returned for interval arguments. Unevaluated function calls are returned for most exact arguments.

If the argument is a rational multiple of  $\mathbf{I}$ , the result is expressed in terms of hyperbolic functions. See “Example 2” on page 1-180 (Symbolic Math Toolbox).

MuPAD rewrites `arccsc` as `arccsc(x) = arcsin(1/x)`.

The inverse cosecant functions is multivalued. The MuPAD `arccsc` function returns values on the main branch. The branch cut is the real interval  $(-1, 1)$ . Thus, `arccsc`

returns values, such that  $y = \text{arccsc}(x)$  satisfies  $-\frac{\pi}{2} \leq \Re(y) \leq \frac{\pi}{2}$ ,  $y \neq 0$  for any finite complex  $x$ .

The `arccsc` function returns explicit values for arguments that are certain rational multiples of  $\pi$ . For these values, the inverse functions return an appropriate rational multiple of  $\pi$  on the main branch. See “Example 3” on page 1-180 (Symbolic Math Toolbox).

The values jump when the arguments cross a branch cut. See “Example 4” on page 1-181 (Symbolic Math Toolbox).

The float attributes are kernel functions. Thus, floating-point evaluation is fast.

## Environment Interactions

When called with a floating-point argument, `arccsc` is sensitive to the environment variable `DIGITS` which determines the numerical working precision.

## Examples

### Example 1

Call `arccsc` with the following exact and symbolic input arguments:

```
arccsc(1), arccsc(1/sqrt(2)), arccsc(5 + I),
arccsc(1/3), arccsc(I), arccsc(-1)
```

$$\frac{\pi}{2}, \arcsin(\sqrt{2}), \arcsin\left(\frac{5}{26} - \frac{i}{26}\right), \arcsin(3), -\operatorname{arcsinh}(1) i, -\frac{\pi}{2}$$

```
arccsc(-x), arccsc(x + 1), arccsc(1/x)
```

$$-\arcsin\left(\frac{1}{x}\right), \arcsin\left(\frac{1}{x+1}\right), \arcsin(x)$$

Floating-point values are computed for floating-point arguments:

```
arccsc(0.1234), arccsc(5.6 + 7.8*I), arccsc(1.0/10^20)
```

$$1.570796327 - 2.781642534 i, 0.06055755512 - 0.08465291511 i, \\ 1.570796327 - 46.74484904 i$$

Floating-point intervals are computed for interval arguments:

```
arccsc(-2...-1), arccsc(1...5)
```

$$-1.570796327 \dots -0.5235987755, 0.2013579207 \dots 1.570796327$$

Note that certain types of input lead to severe overestimation, sometimes returning the whole image set of the function in question:

`arccsc(-2...2);`  
`csc(arccsc(-2...2))`

$$\begin{aligned} & -3.141592654 \dots 2.382564905 \cdot 10^{-323228497} + -0.6931471806 \dots \text{RD\_INF } i \\ & \cup -2.382564905 \cdot 10^{-323228497} \dots 3.141592654 + \text{RD\_NINF} \dots 0.6931471806 \ i \\ & \text{RD\_NINF} \dots \text{RD\_INF} + \text{RD\_NINF} \dots \text{RD\_INF } i \end{aligned}$$

## Example 2

Arguments that are rational multiples of I are rewritten in terms of hyperbolic functions:

`arccsc(5*I), arccsc(5/4*I), arccsc(-3*I)`

$$-\operatorname{arcsinh}\left(\frac{1}{5}\right) i, -\operatorname{arcsinh}\left(\frac{4}{5}\right) i, \operatorname{arcsinh}\left(\frac{1}{3}\right) i$$

For other complex arguments unevaluated function calls without simplifications are returned:

`arccsc(1/2^(1/2) + I), arccsc(1 - 3*I)`

$$\operatorname{arcsin}\left(\frac{1}{\frac{\sqrt{2}}{2} + i}\right), \operatorname{arcsin}\left(\frac{1}{10} + \frac{3i}{10}\right)$$

## Example 3

Some special values are implemented:

$\text{arccsc}(\sqrt{2}), \text{arccsc}(4/(5^{1/2} - 1)), \text{arccsc}(2/3^{1/2})$

$$\frac{\pi}{4}, \frac{\pi}{10}, \frac{\pi}{3}$$

Such simplifications occur for arguments that are trigonometric images of rational multiples of  $\pi$ :

$\text{csc}(9/10*\text{PI}), \text{arccsc}(\text{csc}(9/10*\text{PI}))$

$$\frac{1}{\frac{\sqrt{5}}{4} - \frac{1}{4}}, \frac{\pi}{10}$$

## Example 4

The values jump when crossing a branch cut:

$\text{arccsc}(0.5 + \text{I}/10^{10}), \text{arccsc}(0.5 - \text{I}/10^{10})$

$$1.570796327 - 1.316957897 \text{ i}, 1.570796327 + 1.316957897 \text{ i}$$

On the branch cut, the values of  $\text{arccsc}$  coincide with the limit “from above” for real arguments  $0 < x < 1$ :

$\text{limit}(\text{arccsc}(0.5 - \text{I}/n), n = \text{infinity});$   
 $\text{limit}(\text{arccsc}(0.5 + \text{I}/n), n = \text{infinity});$   
 $\text{arccsc}(0.5)$

$$1.570796327 + 1.316957897 \text{ i}$$

$$1.570796327 - 1.316957897 \text{ i}$$

$$1.570796327 - 1.316957897 \text{ i}$$

The values coincide with the limit “from below” for real  $-1 < x < 0$ :

```
limit(arccsc(-0.5 - I/n), n = infinity);
limit(arccsc(-0.5 + I/n), n = infinity);
arccsc(-0.5)
```

$$-1.570796327 + 1.316957897 i$$

$$-1.570796327 - 1.316957897 i$$

$$-1.570796327 + 1.316957897 i$$

### Example 5

The inverse cosecant function can be rewritten in terms of the logarithm function with complex arguments:

```
rewrite(arccsc(x), ln)
```

$$-\ln\left(\sqrt{1 - \frac{1}{x^2}} + \frac{i}{x}\right) i$$

### Example 6

diff, float, limit, taylor, series, and other system functions handle expressions involving the inverse trigonometric functions:

```
diff(arccsc(x^2), x), float(arccsc(3)*arctan(5 + I))
```

$$-\frac{2}{x^3 \sqrt{1 - \frac{1}{x^4}}}, 0.4691595135 + 0.01260964896 i$$

```
limit(arccsc(1 + sin(x)/x), x = 0)
```

$$\frac{\pi}{6}$$



`taylor(arccsc(1/x), x = 0)`

$$x + \frac{x^3}{6} + \frac{3x^5}{40} + O(x^7)$$

`series(arccsc(x), x = 0, Right)`

$$-\ln(2i) i + \ln(x) i + \frac{x^2 i}{4} + \frac{3x^4 i}{32} + O(x^6)$$

## Parameters

**x**

Arithmetical expression (Symbolic Math Toolbox) or floating-point interval on page 7-33

## Return Values

Arithmetical expression or floating-point interval.

## Overloaded By

x

## See Also

### MuPAD Functions

`arccos` | `arccot` | `arcsec` | `arcsin` | `arctan` | `arg` | `cos` | `cot` | `csc` | `sec` | `sin` | `tan`

## arcsec

Inverse secant function

### Syntax

`arcsec(x)`

### Description

`arcsec(x)` represents the inverse of the secant function.

The angle returned by this function is measured in radians, not in degrees. For example, the result  $\pi$  represents an angle of  $180^\circ$ .

`arcsec` is defined for complex arguments.

Floating-point values are returned for floating-point arguments. Floating-point intervals are returned for interval arguments. Unevaluated function calls are returned for most exact arguments.

If the argument is a rational multiple of  $\mathbf{I}$ , the result is expressed in terms of hyperbolic functions. See “Example 2” on page 1-186 (Symbolic Math Toolbox).

MuPAD rewrites `arcsec` as `arcsec(x) = arccos(1/x)`.

The inverse secant function is multivalued. The MuPAD `arcsec` function returns values on the main branch. The branch cut is the real interval  $(-1, 1)$ . Thus, `arcsec` returns

values, such that  $y = \text{arcsec}(x)$  satisfies  $0 \leq \Re(y) \leq \pi$ ,  $y \neq \frac{\pi}{2}$  for any finite complex  $x$ .

The `arcsec` function returns explicit values for arguments that are certain rational multiples of  $\pi$ . For these values, the inverse functions return an appropriate rational multiple of  $\pi$  on the main branch. See “Example 3” on page 1-186 (Symbolic Math Toolbox).

The values jump when the arguments cross a branch cut. See “Example 4” on page 1-187 (Symbolic Math Toolbox).

The float attributes are kernel functions. Thus, floating-point evaluation is fast.

## Environment Interactions

When called with a floating-point argument, `arcsec` is sensitive to the environment variable `DIGITS` which determines the numerical working precision.

## Examples

### Example 1

Call `arcsec` with the following exact and symbolic input arguments:

```
arcsec(-1), arcsec(1/sqrt(2)), arcsec(5 + I),
arcsec(1/3), arcsec(I), arcsec(1)
```

$$\pi, \arccos(\sqrt{2}), \arccos\left(\frac{5}{26} - \frac{i}{26}\right), \arccos(3), \frac{\pi}{2} + \operatorname{arcsinh}(1) i, 0$$

```
arcsec(-x), arcsec(x + 1), arcsec(1/x)
```

$$\pi - \arccos\left(\frac{1}{x}\right), \arccos\left(\frac{1}{x+1}\right), \arccos(x)$$

Floating-point values are computed for floating-point arguments:

```
arcsec(0.1234), arcsec(5.6 + 7.8*I), arcsec(I + 1.0/10^20)
```

$$2.781642534 i, 1.510238772 + 0.08465291511 i, 1.570796327 + 0.881373587 i$$

Floating-point intervals are computed for interval arguments:

```
arcsec(-2...-1), arcsec(2...10)
```

2.094395102 ... 3.141592654, 1.047197551 ... 1.470628906

Note that certain types of input lead to severe overestimation, sometimes returning the whole image set of the function in question:

`arcsec(-2...2);`  
`sec(arcsec(-2...2))`

$-1.570796327 \dots 1.570796327 + -0.6931471806 \dots \text{RD\_INF } i$   
 $\cup 1.570796326 \dots 4.712388981 + \text{RD\_NINF} \dots 0.6931471806 i$

$\text{RD\_NINF} \dots \text{RD\_INF} + \text{RD\_NINF} \dots \text{RD\_INF } i$

## Example 2

Arguments that are rational multiples of I are rewritten in terms of hyperbolic functions:

`arcsec(5*I), arcsec(5/4*I), arcsec(-3*I)`

$\frac{\pi}{2} + \text{arcsinh}\left(\frac{1}{5}\right) i, \frac{\pi}{2} + \text{arcsinh}\left(\frac{4}{5}\right) i, \frac{\pi}{2} - \text{arcsinh}\left(\frac{1}{3}\right) i$

For other complex arguments function calls without simplifications are returned:

`arcsec(1/2^(1/2) + I), arcsec(1 - 3*I)`

$\arccos\left(\frac{1}{\frac{\sqrt{2}}{2} + i}\right), \arccos\left(\frac{1}{10} + \frac{3i}{10}\right)$

## Example 3

Some special values are implemented:

`arcsec(sqrt(2)), arcsec(4/(5^(1/2) - 1)), arcsec(2/3^(1/2))`

$$\frac{\pi}{4}, \frac{2\pi}{5}, \frac{\pi}{6}$$

Such simplifications occur for arguments that are trigonometric images of rational multiples of  $\pi$ :

$$\sec(9/10*\pi), \operatorname{arcsec}(\sec(9/10*\pi))$$

$$-\frac{2\sqrt{2}}{\sqrt{\sqrt{5}+5}}, \frac{9\pi}{10}$$

### Example 4

The values jump when crossing a branch cut:

$$\operatorname{arcsec}(-0.5 + i/10^{10}), \operatorname{arcsec}(-0.5 - i/10^{10})$$

$$3.141592653 + 1.316957897 i, 3.141592653 - 1.316957897 i$$

On the branch cut, the values of  $\operatorname{arcsec}$  coincide with the limit “from above” for real arguments  $0 < x < 1$ :

$$\begin{aligned} &\operatorname{limit}(\operatorname{arcsec}(0.5 - i/n), n = \text{infinity}); \\ &\operatorname{limit}(\operatorname{arcsec}(0.5 + i/n), n = \text{infinity}); \\ &\operatorname{arcsec}(0.5) \end{aligned}$$

$$-1.316957897 i$$

$$1.316957897 i$$

$$1.316957897 i$$

The values coincide with the limit “from below” for real  $-1 < x < 0$ :

```
limit(arcsec(-0.5 - I/n), n = infinity);
limit(arcsec(-0.5 + I/n), n = infinity);
arcsec(-0.5)
```

$$3.141592654 - 1.316957897 i$$

$$3.141592654 + 1.316957897 i$$

$$3.141592654 - 1.316957897 i$$

### Example 5

The inverse secant function can be rewritten in terms of the logarithm function with complex arguments:

```
rewrite(arcsec(x), ln)
```

$$-\ln\left(\frac{1}{x} + \sqrt{1 - \frac{1}{x^2} i}\right) i$$

### Example 6

diff, float, limit, taylor, series, and other system functions handle expressions involving the inverse trigonometric functions:

```
diff(arcsec(x), x), float(arcsec(3)*arctan(5 + I))
```

$$\frac{1}{x^2 \sqrt{1 - \frac{1}{x^2}}}, 1.699392577 + 0.04567475076 i$$

```
limit(arcsec(1 + sin(x)/x), x = 0)
```

$$\frac{\pi}{3}$$

`taylor(arcsec(1/x), x = 0)`

$$\frac{\pi}{2} - x - \frac{x^3}{6} - \frac{3x^5}{40} + O(x^7)$$

`series(arcsec(x), x = 0, Right)`

$$\frac{\pi}{2} + \ln(2i)i - \ln(x)i - \frac{x^2i}{4} - \frac{3x^4i}{32} + O(x^6)$$

## Parameters

**x**

Arithmetical expression (Symbolic Math Toolbox) or floating-point interval on page 7-33

## Return Values

Arithmetical expression or floating-point interval.

## Overloaded By

x

## See Also

### MuPAD Functions

`arccos` | `arccot` | `arccsc` | `arcsin` | `arctan` | `arg` | `cos` | `cot` | `csc` | `sec` | `sin` | `tan`

# arccot

Inverse cotangent function

## Syntax

`arccot(x)`

## Description

`arccot(x)` represents the inverse of the cotangent function.

The angle returned by this function is measured in radians, not in degrees. For example, the result  $\pi$  represents an angle of  $180^\circ$ .

`arccot` is defined for complex arguments.

Floating-point values are returned for floating-point arguments. Floating-point intervals are returned for interval arguments. Unevaluated function calls are returned for most exact arguments.

If the argument is a rational multiple of  $\mathbf{I}$ , the result is expressed in terms of hyperbolic functions. See “Example 2” on page 1-192 (Symbolic Math Toolbox).

The inverse cotangent function is multivalued. The MuPAD `arccot` function returns the value on the main branch. The branch cut is the interval  $[-i, i]$  on the imaginary axis.

Thus, `arccot` returns values, such that  $y = \text{arccot}(x)$  satisfies  $-\frac{\pi}{2} < \Re(y) \leq \frac{\pi}{2}$  for any finite complex  $x$ .

The `cot` function returns explicit values for arguments that are certain rational multiples of  $\pi$ . For these values, `arccot` returns an appropriate rational multiple of  $\pi$  on the main branch. See “Example 3” on page 1-192 (Symbolic Math Toolbox).

The values jump when the arguments cross a branch cut. See “Example 4” on page 1-193 (Symbolic Math Toolbox).



---

**Note** MuPAD defines  $\operatorname{arccot}(x) = \arctan(1/x)$ , although  $\operatorname{arccot}$  can return an unevaluated function call and does not rewrite itself in terms of  $\arctan$ . As a consequence of this definition, the real line crosses the branch cut, and  $\operatorname{arccot}$  has a jump discontinuity at the origin.

---

The float attributes are kernel functions. Thus, floating-point evaluation is fast.

## Environment Interactions

When called with a floating-point argument,  $\operatorname{arccot}$  is sensitive to the environment variable DIGITS which determines the numerical working precision.

## Examples

### Example 1

Call  $\operatorname{arccot}$  with the following exact and symbolic input arguments:

$\operatorname{arccot}(1)$ ,  $\operatorname{arccot}(1/\sqrt{2})$ ,  $\operatorname{arccot}(5 + I)$ ,  
 $\operatorname{arccot}(1/3)$ ,  $\operatorname{arccot}(0)$ ,  $\operatorname{arccot}(I/2)$

$$\frac{\pi}{4}, \operatorname{arccot}\left(\frac{\sqrt{2}}{2}\right), \operatorname{arccot}(5 + i), \operatorname{arccot}\left(\frac{1}{3}\right), \frac{\pi}{2}, -\operatorname{arccoth}\left(\frac{1}{2}\right) i$$

$\operatorname{arccot}(-x)$ ,  $\operatorname{arccot}(x + 1)$ ,  $\operatorname{arccot}(1/x)$

$$-\operatorname{arccot}(x), \operatorname{arccot}(x + 1), \operatorname{arccot}\left(\frac{1}{x}\right)$$

Floating-point values are computed for floating-point arguments:

$\operatorname{arccot}(0.1234)$ ,  $\operatorname{arccot}(5.6 + 7.8*I)$ ,  $\operatorname{arccot}(1.0/10^{20})$

$$1.448017026, 0.06109758535 - 0.08448597681 i, 1.570796327$$

Floating-point intervals are computed for interval arguments:

`arccot(-4...4), arccot(0...1)`

`-1.570796327 ... -0.2449786631 ∪ 0.2449786631 ... 1.570796327,  
0.7853981633 ... 1.570796327`

## Example 2

Arguments that are rational multiples of I are rewritten in terms of hyperbolic functions:

`arccot(5*I), arccot(5/4*I), arccot(-3*I)`

`-arccoth(5) i, -arccoth(5/4) i, arccoth(3) i`

For other complex arguments unevaluated function calls without simplifications are returned:

`arccot(1/2^(1/2) + I), arccot(1 - 3*I)`

`arccot(√2/2 + i), arccot(1 - 3 i)`

## Example 3

Some special values are implemented:

`arccot(1), arccot((5 - 2*5^(1/2))^(1/2)), arccot(3^(1/2) - 2)`

`π/4, 3π/10, -5π/12`

Such simplifications occur for arguments that are trigonometric images of rational multiples of π:

`cot(9/10*PI), arccot(cot(9/10*PI))`

`-√2√5+5, -π/10`

## Example 4

The values jump when crossing a branch cut:

```
arccot(0.5*I + 10^(-10)), arccot(0.5*I - 10^(-10))
```

```
1.570796327 - 0.5493061443 i, -1.570796327 - 0.5493061443 i
```

On the branch cut, the values of arccot coincide with the limit “from the right” for imaginary arguments  $x = c*i$  where  $0 < c < 1$ :

```
limit(arccot(0.5*I - 1/n), n = infinity);
limit(arccot(0.5*I + 1/n), n = infinity);
arccot(0.5*I)
```

```
-1.570796327 - 0.5493061443 i
```

```
1.570796327 - 0.5493061443 i
```

```
-1.570796327 - 0.5493061443 i
```

The values coincide with the limit “from the left” for imaginary arguments  $x = c*i$  where  $-1 < c < 0$ :

```
limit(arccot(-0.5*I - 1/n), n = infinity);
limit(arccot(-0.5*I + 1/n), n = infinity);
arccot(-0.5*I)
```

```
-1.570796327 + 0.5493061443 i
```

```
1.570796327 + 0.5493061443 i
```

```
1.570796327 + 0.5493061443 i
```

## Example 5

The inverse cotangent function can be rewritten in terms of the logarithm function with complex arguments:

```
rewrite(arccot(x), ln)
```

$$\frac{\ln(1 - \frac{i}{x})}{2} - \frac{\ln(1 + \frac{i}{x})}{2}$$

## Example 6

diff, float, limit, taylor, series, and other system functions handle expressions involving the inverse trigonometric functions:

```
diff(arccot(x^2), x), float(arccos(3)*arccot(5 + I))
```

$$-\frac{2x}{x^4 + 1}, 0.06540673615 + 0.3353682705i$$

```
limit(arccot(1 - sin(x)/x), x = 0)
```

$$\frac{\pi}{2}$$

```
taylor(arccot(1/x), x = 0)
```

$$x - \frac{x^3}{3} + \frac{x^5}{5} + O(x^7)$$

```
series(arccot(x), x = 0)
```

$$\frac{\pi \operatorname{signIm}(\frac{i}{x})}{2} - x + \frac{x^3}{3} - \frac{x^5}{5} + O(x^7)$$

## Parameters

$x$

Arithmetical expression (Symbolic Math Toolbox) or floating-point interval on page 7-33

## Return Values

Arithmetical expression or floating-point interval.

## Overloaded By

$x$

## See Also

### MuPAD Functions

arccos | arccsc | arcsec | arcsin | arctan | arg | cos | cot | csc | sec | sin | tan

# arcsinh

Inverse of the hyperbolic sine function

## Syntax

`arcsinh(x)`

## Description

`arcsinh(x)` represents the inverse of the hyperbolic sine function.

`arcsinh` is defined for complex arguments.

Floating-point values are returned for floating-point arguments. Floating-point intervals are returned for floating-point interval arguments. Unevaluated function calls are returned for most exact arguments.

The following special value is implemented:  $\text{arcsinh}(0) = 0$ .

The inverse hyperbolic sine function is multivalued. The MuPAD implementation returns values on the main branch defined by the following restriction of the imaginary part. For

any finite complex  $x$ ,  $-\frac{\pi}{2} \leq \Im(\text{arcsinh}(x)) \leq \frac{\pi}{2}$ .

The inverse hyperbolic sine function is implemented according to the following relation to the logarithm function:  $\text{arcsinh}(x) = \ln(x + \sqrt{x^2 + 1})$ . See “Example 2” on page 1-198 (Symbolic Math Toolbox).

Consequently, the branch cuts are the intervals  $(-i\infty, -i)$  and  $(i, i\infty)$  on the imaginary axis. The values jump when the argument crosses a branch cut. See “Example 3” on page 1-198 (Symbolic Math Toolbox).

The float attributes are kernel functions, and floating-point evaluation is fast.

## Environment Interactions

When called with a floating-point argument, `arcsinh` is sensitive to the environment variable `DIGITS` which determines the numerical working precision.

## Examples

### Example 1

Call `arcsinh` with the following exact and symbolic input arguments:

```
arcsinh(1), arcsinh(-1/sqrt(3)), arcsinh(5 + I),
arcsinh(1/3), arcsinh(I), arcsinh(2)
```

$$\operatorname{arcsinh}(1), -\operatorname{arcsinh}\left(\frac{\sqrt{3}}{3}\right), \operatorname{arcsinh}(5 + i), \operatorname{arcsinh}\left(\frac{1}{3}\right), \frac{\pi i}{2}, \operatorname{arcsinh}(2)$$

```
arcsinh(-x), arcsinh(x + 1), arcsinh(1/x)
```

$$-\operatorname{arcsinh}(x), \operatorname{arcsinh}(x + 1), \operatorname{arcsinh}\left(\frac{1}{x}\right)$$

Floating-point values are computed for floating-point arguments:

```
arcsinh(0.1234), arcsinh(5.6 + 7.8*I), arcsinh(1.0/10^20)
```

$$0.1230889466, 2.954269101 + 0.9455497357 i, 1.0 \cdot 10^{-20}$$

Floating-point intervals are computed for interval arguments:

```
arcsinh(-0.5...1.5), arcsinh(0.1234...0.12345)
```

$$-0.4812118251 \dots 1.194763218, 0.1230889466 \dots 0.1231385701$$

## Example 2

The inverse hyperbolic sine function can be rewritten in terms of the logarithm function:

```
rewrite(arcsinh(x), ln)
```

$$\ln\left(x + \sqrt{x^2 + 1}\right)$$

## Example 3

The values jump when crossing a branch cut:

```
arcsinh(2.0*I + 10^(-10)), arcsinh(2.0*I - 10^(-10))
```

$$1.316957897 + 1.570796327 i, -1.316957897 + 1.570796327 i$$

On the branch cut  $(i, i\infty)$ , the values of `arcsinh` coincide with the limit “from the right” for imaginary arguments:

```
limit(arcsinh(2.0*I - 1/n), n = infinity);  
limit(arcsinh(2.0*I + 1/n), n = infinity);  
arcsinh(2.0*I)
```

$$-1.316957897 + 1.570796327 i$$

$$1.316957897 + 1.570796327 i$$

$$1.316957897 + 1.570796327 i$$

On the branch cut  $(-i\infty, -i)$ , the values of `arcsinh` coincide with the limit “from the left” for imaginary arguments:

```
limit(arcsinh(-2.0*I - 1/n), n = infinity);  
limit(arcsinh(-2.0*I + 1/n), n = infinity);  
arcsinh(-2.0*I)
```



$$-1.316957897 - 1.570796327 i$$

$$1.316957897 - 1.570796327 i$$

$$-1.316957897 - 1.570796327 i$$

### Example 4

diff, float, limit, taylor, series, and other system functions handle expressions involving the inverse hyperbolic functions:

`diff(arcsinh(x^2), x), float(arcsinh(3)*arctanh(5 + I))`

$$\frac{2x}{\sqrt{x^4 + 1}}, 0.3535535298 + 2.783825741 i$$

`limit(arcsinh(x)/x, x = 0)`

$$1$$

`taylor(arcsinh(x), x = 0)`

$$x - \frac{x^3}{6} + \frac{3x^5}{40} + O(x^7)$$

`series(arcsinh(1/x), x = 0, Right)`

$$\ln(2) - \ln(x) + \frac{x^2}{4} - \frac{3x^4}{32} + O(x^6)$$

## Parameters

$x$

Arithmetical expression (Symbolic Math Toolbox) or floating-point interval on page 7-33

## Return Values

Arithmetical expression or floating-point interval

## Overloaded By

$x$

## See Also

### **MuPAD Functions**

arccosh | arccoth | arccsch | arcsech | arctanh | cosh | coth | csch | sech | sinh  
| tanh

# arccosh

Inverse of the hyperbolic cosine function

## Syntax

`arccosh(x)`

## Description

`arccosh(x)` represents the inverse of the hyperbolic cosine function.

`arccosh` is defined for complex arguments.

Floating-point values are returned for floating-point arguments. Floating-point intervals are returned for floating-point interval arguments. Unevaluated function calls are returned for most exact arguments.

The following special values are implemented:

$$\operatorname{arccosh}(-1) = i\pi, \quad \operatorname{arccosh}(0) = \frac{i\pi}{2}, \quad \operatorname{arccosh}(1) = 0.$$

The inverse hyperbolic cosine function is multivalued. The MuPAD implementation returns values on the main branch defined by the following restriction of the imaginary

part. For any finite complex  $x$ ,  $-\pi < \Im(\operatorname{arccosh}(x)) \leq \pi$ .

The inverse hyperbolic cosine function is implemented according to the following relation to the logarithm function:  $\operatorname{arccosh}(x) = \ln(x + (x-1)^{1/2} * (x+1)^{1/2})$ . See “Example 2” on page 1-203 (Symbolic Math Toolbox).

Consequently, the branch cuts are the real interval  $(-\infty, 1)$  and the imaginary axis. The values jump when the argument crosses a branch cut. See “Example 3” on page 1-203 (Symbolic Math Toolbox).

The float attributes are kernel functions, and floating-point evaluation is fast.

## Environment Interactions

When called with a floating-point argument, `arccosh` is sensitive to the environment variable `DIGITS` which determines the numerical working precision.

## Examples

### Example 1

Call `arccosh` with the following exact and symbolic input arguments:

```
arccosh(2), arccosh(1/sqrt(3)), arccosh(5 + I),  
arccosh(1/3), arccosh(I), arccosh(2 - I)
```

```
arccosh(2), arccosh( $\frac{\sqrt{3}}{3}$ ), arccosh(5 + i), arccosh( $\frac{1}{3}$ ), arccosh(i), arccosh(2 - i)
```

```
arccosh(-x), arccosh(x + 1), arccosh(1/x)
```

```
arccosh(-x), arccosh(x + 1), arccosh( $\frac{1}{x}$ )
```

Floating-point values are computed for floating-point arguments:

```
arccosh(1.1234), arccosh(2.0), arccosh(5.6 + 7.8*I)
```

```
0.4918178816, 1.316957897, 2.956002937 + 0.950687977 i
```

Floating-point intervals are computed for interval arguments:

```
arccosh(1.1...5.5), arccosh(1.1234...1.12345)
```

```
0.4435682543 ... 2.389526435, 0.4918178816 ... 0.4919155492
```

## Example 2

The inverse hyperbolic cosine function can be rewritten in terms of the logarithm function:

```
rewrite(arccosh(x), ln)
```

$$\ln(x + \sqrt{x-1} \sqrt{x+1})$$

## Example 3

The values jump when crossing a branch cut:

```
arccosh(0.5 + I/10^10), arccosh(0.5 - I/10^10)
```

$$0.0000000001154700519 + 1.047197551 i, 0.0000000001154700519 - 1.047197551 i$$

On the branch cut, the values of `arccosh` coincide with the limit “from below” for real arguments  $x < 0$ :

```
limit(arccosh(-0.5 - I/n), n = infinity);
limit(arccosh(-0.5 + I/n), n = infinity);
arccosh(-0.5)
```

$$-2.094395102 i$$

$$2.094395102 i$$

$$2.094395102 i$$

The values coincide with the limit “from above” for real  $0 < x < 1$ :

```
limit(arccosh(0.5 - I/n), n = infinity);
limit(arccosh(0.5 + I/n), n = infinity);
arccosh(0.5)
```

$$-1.047197551 i$$

1.047197551 i

1.047197551 i

### Example 4

`diff`, `float`, `limit`, `series`, and other system functions handle expressions involving the inverse hyperbolic functions:

`diff(arccosh(x^2), x), float(arccosh(3)*arctanh(5 + I))`

$$\frac{2x}{\sqrt{x^2-1}\sqrt{x^2+1}}, 0.3427241326 + 2.698556745 i$$

`limit(arccosh(x)/x, x = infinity)`

0

`series(arccosh(1/x), x = 0, 3)`

$$\ln\left(\frac{1}{x}\right) + \ln(2) - \frac{x^2}{4} + O(x^3)$$

## Parameters

**x**

Arithmetical expression (Symbolic Math Toolbox) or floating-point interval on page 7-33

## Return Values

Arithmetical expression or floating-point interval

## Overloaded By

x

## See Also

### MuPAD Functions

arccoth | arccsch | arcsech | arcsinh | arctanh | cosh | coth | csch | sech | sinh  
| tanh

# arctanh

Inverse of the hyperbolic tangent function

## Syntax

`arctanh(x)`

## Description

`arctanh(x)` represents the inverse of the hyperbolic tangent function.

`arctanh` is defined for complex arguments.

Floating-point values are returned for floating-point arguments. Floating-point intervals are returned for floating-point interval arguments. Unevaluated function calls are returned for most exact arguments.

The following special value is implemented:  $\text{arctanh}(0) = 0$ .

The inverse hyperbolic tangent function is multivalued. The MuPAD implementation returns values on the main branch defined by the following restriction of the imaginary

part. For any finite complex  $x$ ,  $-\frac{\pi}{2} < \Im(\text{arctanh}(x)) < \frac{\pi}{2}$ .

The inverse hyperbolic tangent function is implemented according to the following relation to the logarithm function:  $\text{arctanh}(x) = (\ln(1 + x) - \ln(1 - x))/2$ . See “Example 2” on page 1-208 (Symbolic Math Toolbox).

Consequently, the branch cuts are the real intervals  $(-\infty, -1]$  and  $[1, \infty)$ . The values jump when the argument crosses a branch cut. See “Example 3” on page 1-208 (Symbolic Math Toolbox).

The float attributes are kernel functions, and floating-point evaluation is fast.



## Environment Interactions

When called with a floating-point argument, `arctanh` is sensitive to the environment variable `DIGITS` which determines the numerical working precision.

## Examples

### Example 1

Call `arctanh` with the following exact and symbolic input arguments:

`arctanh(-1/2)`, `arctanh(1/sqrt(3))`, `arctanh(5 + I)`,  
`arctanh(1/3)`, `arctanh(I)`, `arctanh(2)`

$-\operatorname{arctanh}\left(\frac{1}{2}\right)$ ,  $\operatorname{arctanh}\left(\frac{\sqrt{3}}{3}\right)$ ,  $\operatorname{arctanh}(5 + i)$ ,  $\operatorname{arctanh}\left(\frac{1}{3}\right)$ ,  $\frac{\pi i}{4}$ ,  $\operatorname{arctanh}(2)$

`arctanh(-x)`, `arctanh(x + 1)`, `arctanh(1/x)`

$-\operatorname{arctanh}(x)$ ,  $\operatorname{arctanh}(x + 1)$ ,  $\operatorname{arctanh}\left(\frac{1}{x}\right)$

Floating-point values are computed for floating-point arguments:

`arctanh(0.1234)`, `arctanh(-0.5)`, `arctanh(5.6 + 7.8*I)`

0.1240321461, -0.5493061443, 0.06037760705 + 1.486089805 i

Floating-point intervals are computed for interval arguments:

`arctanh(-0.7...0.7)`, `arctanh(0.1234...0.12345)`

-0.8673005277 ... 0.8673005277, 0.124032146 ... 0.1240829196

The inverse of the hyperbolic tangent function has real values only in the interval  $(-1, 1)$ :

`arctanh(-2...-1)`, `arctanh(2...3)`

```
RD_NINF ... -0.3465735902 + 1.570796326 ... 1.570796327 i,  
0.202732554 ... 0.6931471806 + - 1.570796327 ... - 1.570796326 i
```

## Example 2

The inverse hyperbolic tangent function can be rewritten in terms of the logarithm function:

```
rewrite(arctanh(x), ln)
```

$$\frac{\ln(x+1)}{2} - \frac{\ln(1-x)}{2}$$

## Example 3

The values jump when crossing a branch cut:

```
arctanh(2.0 + I/10^10), arctanh(2.0 - I/10^10)
```

```
0.5493061443 + 1.570796327 i, 0.5493061443 - 1.570796327 i
```

On the branch cut, the values of `arctanh` coincide with the limit “from below” for real arguments  $x > 1$ :

```
limit(arctanh(2.0 - I/n), n = infinity);  
limit(arctanh(2.0 + I/n), n = infinity);  
arctanh(2.0)
```

```
0.5493061443 - 1.570796327 i
```

```
0.5493061443 + 1.570796327 i
```

```
0.5493061443 - 1.570796327 i
```

The values coincide with the limit “from above” for real  $x < -1$ :

```
limit(arctanh(-2.0 - I/n), n = infinity);
limit(arctanh(-2.0 + I/n), n = infinity);
arctanh(-2.0)
```

$$-0.5493061443 - 1.570796327 i$$

$$-0.5493061443 + 1.570796327 i$$

$$-0.5493061443 + 1.570796327 i$$

### Example 4

diff, float, limit, taylor, series, and other system functions handle expressions involving the inverse hyperbolic functions:

```
diff(arctanh(x^2), x), float(arccosh(3)*arctanh(5 + I))
```

$$-\frac{2x}{x^4 - 1}, 0.3427241326 + 2.698556745 i$$

```
limit(arcsinh(x)/arctanh(x), x = 0)
```

$$1$$

```
taylor(arctanh(x), x = 0)
```

$$x + \frac{x^3}{3} + \frac{x^5}{5} + O(x^7)$$

```
series(arctanh(1/x), x = 0)
```

$$\frac{\pi \operatorname{signIm}\left(\frac{1}{x}\right) i}{2} + x + \frac{x^3}{3} + \frac{x^5}{5} + O(x^7)$$

## Parameters

$x$

Arithmetical expression (Symbolic Math Toolbox) or floating-point interval on page 7-33

## Return Values

Arithmetical expression or floating-point interval

## Overloaded By

$x$

## See Also

### **MuPAD Functions**

arccosh | arccoth | arccsch | arcsech | arcsinh | cosh | coth | csch | sech | sinh  
| tanh

# arccsch

Inverse of the hyperbolic cosecant function

## Syntax

`arccsch(x)`

## Description

`arccsch(x)` represents the inverse of the hyperbolic cosecant function.

`arccsch` is defined for complex arguments.

Floating-point values are returned for floating-point arguments. Floating-point intervals are returned for floating-point interval arguments. Unevaluated function calls are returned for most exact arguments.

The inverse hyperbolic cosecant function is multivalued. MuPAD rewrites `arccsch` as `arccsch(x) = arcsinh(1/x)`. The MuPAD implementation for `arcsinh` returns values on the main branch defined by the following restriction of the imaginary part. For

any finite complex  $x$ ,  $-\frac{\pi}{2} \leq \Im(\operatorname{arcsinh}(x)) \leq \frac{\pi}{2}$

The inverse hyperbolic cosecant function is implemented according to the following relation to the logarithm function: `arccsch(x) = ln(1/x + sqrt(1/x^2 + 1))`. See “Example 2” on page 1-213 (Symbolic Math Toolbox).

Consequently, the branch cut is the interval  $(-i, i)$  on the imaginary axis. The values jump when the argument crosses a branch cut. See “Example 3” on page 1-213 (Symbolic Math Toolbox).

The float attributes are kernel functions, and floating-point evaluation is fast.

## Environment Interactions

When called with a floating-point argument, `arccsch` is sensitive to the environment variable `DIGITS` which determines the numerical working precision.

## Examples

### Example 1

Call `arccsch` with the following exact and symbolic input arguments:

```
arccsch(-1), arccsch(1/sqrt(3)), arccsch(5 + I),  
arccsch(1/3), arccsch(I), arccsch(2)
```

```
- arcsinh(1), arcsinh(sqrt(3)), arcsinh(5/26 - i/26), arcsinh(3), -pi*i/2, arcsinh(1/2)
```

```
arccsch(-x), arccsch(x + 1), arccsch(1/x)
```

```
- arcsinh(1/x), arcsinh(1/(x + 1)), arcsinh(x)
```

Floating-point values are computed for floating-point arguments:

```
arccsch(0.1234), arccsch(5.6 + 7.8*I), arccsch(1.0/10^20)
```

```
2.789256682, 0.06091755094 - 0.084542645 i, 46.74484904
```

Floating-point intervals are computed for interval arguments:

```
arccsch(-1.5...-0.5), arccsch(0.1234...0.12345)
```

```
-1.443635476 ... -0.6251451172, 2.788854628 ... 2.789256682
```

## Example 2

The inverse hyperbolic cosecant function can be rewritten in terms of the logarithm function:

```
rewrite(arccsch(x), ln)
```

$$\ln\left(\sqrt{\frac{1}{x^2} + 1} + \frac{1}{x}\right)$$

## Example 3

The values jump when crossing a branch cut:

```
arccsch(0.5*I + 1/10^10), arccsch(0.5*I - 1/10^10)
```

$$1.316957897 - 1.570796327 i, -1.316957897 - 1.570796327 i$$

On the branch cut, the values of arccsch coincide with the limit “from the left” for imaginary arguments  $x = c*i$  where  $-1 < c < 0$ :

```
limit(arccsch(0.5*I - 1/n), n = infinity);
limit(arccsch(0.5*I + 1/n), n = infinity);
arccsch(0.5*I)
```

$$-1.316957897 - 1.570796327 i$$

$$1.316957897 - 1.570796327 i$$

$$-1.316957897 - 1.570796327 i$$

The values coincide with the limit “from the right” for imaginary arguments  $x = c*i$  where  $0 < c < 1$ :

```
limit(arccsch(-0.5*I - 1/n), n = infinity);
limit(arccsch(-0.5*I + 1/n), n = infinity);
arccsch(-0.5*I)
```

$$-1.316957897 + 1.570796327 i$$

$$1.316957897 + 1.570796327 i$$

$$1.316957897 + 1.570796327 i$$

### Example 4

diff, float, limit, taylor, series, and other system functions handle expressions involving the inverse hyperbolic functions:

`diff(arccsch(x^2), x), float(arccsch(3)*arctanh(5 + I))`

$$-\frac{2}{x^3 \sqrt{\frac{1}{x^4} + 1}}, 0.06366486946 + 0.5012873228 i$$

`limit(x/arccsch(1/x), x = 0)`

1

`taylor(arccsch(1/x), x = 0)`

$$x - \frac{x^3}{6} + \frac{3x^5}{40} + O(x^7)$$

`series(arccsch(x), x = 0, Right)`

$$\ln(2) - \ln(x) + \frac{x^2}{4} - \frac{3x^4}{32} + O(x^6)$$



## Parameters

$x$

Arithmetical expression (Symbolic Math Toolbox) or floating-point interval on page 7-33

## Return Values

Arithmetical expression or floating-point interval

## Overloaded By

$x$

## See Also

### MuPAD Functions

arccosh | arccoth | arcsech | arcsinh | arctanh | cosh | coth | csch | sech | sinh  
| tanh

## arcsech

Inverse of the hyperbolic secant function

### Syntax

`arcsech(x)`

### Description

`arcsech(x)` represents the inverse of the hyperbolic secant function.

`arcsech` is defined for complex arguments.

Floating-point values are returned for floating-point arguments. Floating-point intervals are returned for floating-point interval arguments. Unevaluated function calls are returned for most exact arguments.

The inverse hyperbolic secant function is multivalued. MuPAD rewrites `arcsech` as `arcsech(x) = arccosh(1/x)`. The MuPAD implementation for `arccosh` returns values on the main branch defined by the following restriction of the imaginary part. For

any finite complex  $x$ ,  $-\pi < \Im(\operatorname{arccosh}(x)) \leq \pi$ .

The inverse hyperbolic secant function is implemented according to the following relation to the logarithm function:  $\operatorname{arcsech}(x) = \ln(1/x + (1/x - 1)^{1/2}) - \ln(1/x + 1)^{1/2}$ . See “Example 2” on page 1-218 (Symbolic Math Toolbox).

Consequently, the branch cuts are the real intervals  $(-\infty, 0)$  and  $(1, \infty)$  together with the imaginary axis.

The values jump when the argument crosses a branch cut. See “Example 3” on page 1-218 (Symbolic Math Toolbox).

The float attributes are kernel functions, and floating-point evaluation is fast.

## Environment Interactions

When called with a floating-point argument, `arcsech` is sensitive to the environment variable `DIGITS` which determines the numerical working precision.

## Examples

### Example 1

Call `arcsech` with the following exact and symbolic input arguments:

```
arcsech(1), arcsech(1/sqrt(3)), arcsech(5 + I),
arcsech(1/3), arcsech(I), arcsech(2)
```

$$0, \operatorname{arccosh}(\sqrt{3}), \operatorname{arccosh}\left(\frac{5}{26} - \frac{i}{26}\right), \operatorname{arccosh}(3), \operatorname{arccosh}(-i), \frac{\pi i}{3}$$

```
arcsech(-x), arcsech(x + 1), arcsech(1/x)
```

$$\operatorname{arccosh}\left(-\frac{1}{x}\right), \operatorname{arccosh}\left(\frac{1}{x+1}\right), \operatorname{arccosh}(x)$$

Floating-point values are computed for floating-point arguments:

```
arcsech(0.1234), arcsech(5.6 + 7.8*I), arcsech(1.0/10^20)
```

$$2.781642534, 0.08465291511 - 1.510238772 i, 46.74484904$$

Floating-point intervals are computed for interval arguments:

```
arcsech(0.5...1), arcsech(0.1234...0.12345)
```

$$0.0 \dots 1.316957897, 2.781234308 \dots 2.781642534$$

## Example 2

The inverse hyperbolic functions can be rewritten in terms of the logarithm function:

```
rewrite(arcsech(x), ln)
```

$$\ln\left(\sqrt{\frac{1}{x}-1} \sqrt{\frac{1}{x}+1} + \frac{1}{x}\right)$$

## Example 3

The values jump when crossing a branch cut:

```
arcsech(2.0 + I/10^10), arcsech(2.0 - I/10^10)
```

$$2.886751255 \cdot 10^{-11} - 1.047197551 i, 2.886751255 \cdot 10^{-11} + 1.047197551 i$$

On the branch cut, the values of `arcsech` coincide with the limit “from below” for real arguments  $x > 1$ :

```
limit(arcsech(2.0 - I/n), n = infinity);
limit(arcsech(2.0 + I/n), n = infinity);
arcsech(2.0)
```

$$1.047197551 i$$

$$-1.047197551 i$$

$$1.047197551 i$$

The values coincide with the limit “from above” for real  $x < 0$ :

```
limit(arcsech(-2.0 - I/n), n = infinity);
limit(arcsech(-2.0 + I/n), n = infinity);
arcsech(-2.0)
```

$$2.094395102 i$$

$-2.094395102 i$

$2.094395102 i$

## Example 4

`diff`, `float`, `limit`, `series`, and other system functions handle expressions involving the inverse hyperbolic functions:

`diff(arcsech(x), x), float(arcsech(3)*arctanh(5 + I))`

$-\frac{1}{x^2 \sqrt{\frac{1}{x}-1} \sqrt{\frac{1}{x}+1}}, -1.884452795 + 0.2393306907 i$

`limit(x/arcsech(x), x = 0)`

$0$

`series(arcsech(x), x = 0, 3)`

$\ln\left(\frac{1}{x}\right) + \ln(2) - \frac{x^2}{4} + O(x^3)$

## Parameters

**x**

Arithmetical expression (Symbolic Math Toolbox) or floating-point interval on page 7-33

## Return Values

Arithmetical expression or floating-point interval

## Overloaded By

x

## See Also

### **MuPAD Functions**

arccosh | arccoth | arccsch | arcsinh | arctanh | cosh | coth | csch | sech | sinh  
| tanh

# arccoth

Inverse of the hyperbolic cotangent function

## Syntax

`arccoth(x)`

## Description

`arccoth(x)` represents the inverse of the hyperbolic cotangent function.

`arccoth` is defined for complex arguments.

Floating-point values are returned for floating-point arguments. Floating-point intervals are returned for floating-point interval arguments. Unevaluated function calls are returned for most exact arguments.

The following special value is implemented:  $\text{arccoth}(0) = \frac{i\pi}{2}$ .

The inverse hyperbolic cotangent function is multivalued. The MuPAD implementation returns values on the main branch defined by the following restriction of the imaginary

part. For any finite complex  $x$ ,  $-\frac{\pi}{2} < \Im(\text{arccoth}(x)) \leq \frac{\pi}{2}$ .

`arccoth` is defined by  $\text{arccoth}(x) = \text{arctanh}(1/x)$ . However, MuPAD does not automatically rewrite it in terms of `arctanh`.

The inverse hyperbolic tangent function is implemented according to the following relation to the logarithm function:  $\text{arccoth}(x) = (\ln(1 + 1/x) - \ln(1 - 1/x))/2$ . See “Example 2” on page 1-223 (Symbolic Math Toolbox).

Consequently, the branch cut is the real interval  $[-1, 1]$ . The values jump when the argument crosses a branch cut. See “Example 3” on page 1-223 (Symbolic Math Toolbox).

The float attributes are kernel functions, thus, floating-point evaluation is fast.

## Environment Interactions

When called with a floating-point argument, `arccoth` is sensitive to the environment variable `DIGITS` which determines the numerical working precision.

## Examples

### Example 1

Call `arccoth` with the following exact and symbolic input arguments:

```
arccoth(-3), arccoth(3/sqrt(3)), arccoth(5 + I),  
arccoth(1/3), arccoth(I), arccoth(2)
```

```
- arccoth(3), arccoth(√3), arccoth(5 + i), arccoth( $\frac{1}{3}$ ),  $-\frac{\pi i}{4}$ , arccoth(2)
```

```
arccoth(-x), arccoth(x + 1), arccoth(1/x)
```

```
- arccoth(x), arccoth(x + 1), arccoth( $\frac{1}{x}$ )
```

Floating-point values are computed for floating-point arguments:

```
arccoth(-1.1234), arccoth(5.6 + 7.8*I), arccoth(1.0/10^20)
```

```
- 1.422671373, 0.06037760705 - 0.08470652194 i, - 1.570796327 i
```

Floating-point intervals are computed for interval arguments:

```
arccoth(-1.5...-1.1), arccoth(1.1234...1.12345)
```

```
- 1.522261219 ... - 0.8047189562, 1.422480593 ... 1.422671373
```



## Example 2

The inverse hyperbolic cotangent function can be rewritten in terms of the logarithm function:

`rewrite(arccoth(x), ln)`

$$\frac{\ln\left(\frac{1}{x}+1\right)}{2} - \frac{\ln\left(1-\frac{1}{x}\right)}{2}$$

## Example 3

The values jump when crossing a branch cut:

`arccoth(0.5 + I/10^10), arccoth(0.5 - I/10^10)`

$$0.5493061443 - 1.570796327 i, 0.5493061443 + 1.570796327 i$$

On the branch cut, the values of `arccoth` coincide with the limit “from above” for real arguments  $0 < x < 1$ :

`limit(arccoth(0.5 - I/n), n = infinity);`  
`limit(arccoth(0.5 + I/n), n = infinity);`  
`arccoth(0.5)`

$$0.5493061443 + 1.570796327 i$$

$$0.5493061443 - 1.570796327 i$$

$$0.5493061443 - 1.570796327 i$$

The values coincide with the limit “from below” for real  $-1 < x < 0$ :

`limit(arccoth(-0.5 - I/n), n = infinity);`  
`limit(arccoth(-0.5 + I/n), n = infinity);`  
`arccoth(-0.5)`

$$-0.5493061443 + 1.570796327 i$$

$$-0.5493061443 - 1.570796327 i$$

$$-0.5493061443 + 1.570796327 i$$

### Example 4

diff, float, limit, taylor, series, and other system functions handle expressions involving the inverse hyperbolic functions:

diff(arccoth(x^2), x), float(arccosh(3)\*arccoth(5 + I))

$$-\frac{2x}{x^4 - 1}, 0.3427241326 - 0.07036004086 i$$

limit(1/arccoth(sin(x)/x), x = 0)

$$0$$

taylor(arccoth(1/x), x = 0)

$$x + \frac{x^3}{3} + \frac{x^5}{5} + O(x^7)$$

series(arccoth(x), x = 0)

$$\frac{\pi \operatorname{signIm}\left(\frac{1}{x}\right) i}{2} + x + \frac{x^3}{3} + \frac{x^5}{5} + O(x^7)$$

## Parameters

$x$

Arithmetical expression (Symbolic Math Toolbox) or floating-point interval on page 7-33

## Return Values

Arithmetical expression or floating-point interval

## Overloaded By

$x$

## See Also

### **MuPAD Functions**

arccosh | arccsch | arcsech | arcsinh | arctanh | cosh | coth | csch | sech | sinh  
| tanh

## arg

Argument (polar angle) of a complex number

### Syntax

`arg(z)`

`arg(x, y)`

### Description

`arg(z)` returns the argument of the complex number  $z$ .

`arg(x, y)` returns the argument of the complex number with real part  $x$  and imaginary part  $y$ .

This function is also known as `atan2` in other mathematical languages.

The argument of a non-zero complex number  $z = x + iy = |z|e^{i\phi}$  is its real polar angle  $\phi$ .

`arg(x, y)` represents the principal value  $\phi \in (-\pi, \pi]$ . For  $x \neq 0$ ,  $y \neq 0$ , it is given by

$$\mathbf{arg(x, y) = arctan\left(\frac{y}{x}\right) + \frac{\pi}{2} \mathbf{sign(y) (1 - sign(x))}$$

An error occurs if `arg` is called with two arguments and either one of the arguments  $x$ ,  $y$  is a non-real numerical value. Symbolic arguments are assumed to be real.

On the other hand, if `arg` is called with only one argument  $x + I*y$ , it is not assumed that  $x$  and  $y$  are real.

A floating-point number is returned if one argument is given which is a floating-point number; or if two arguments are given, both of them are numerical and at least one of them is a floating-point number.

If the sign of the arguments can be determined, then the result is expressed in terms of `arctan`. Cf. “Example 2” on page 1-228 (Symbolic Math Toolbox). Otherwise, a symbolic

call of `arg` is returned. Numerical factors are eliminated from the first argument. Cf. “Example 3” on page 1-228 (Symbolic Math Toolbox).

A symbolic call to `arg` returned has only one argument.

The call `arg(0, 0)`, or equivalently `arg(0)`, returns `0`.

An alternative representation is  $\arg(x, y) = -i \ln\left(\frac{z}{|z|}\right) = -i \ln(\text{sign}(z))$ . Cf. “Example 4” on page 1-229 (Symbolic Math Toolbox).

## Environment Interactions

When called with floating-point arguments, the function is sensitive to the environment variable `DIGITS` which determines the numerical working precision. Properties (Symbolic Math Toolbox) of identifiers are taken into account.

## Examples

### Example 1

We demonstrate some calls with exact and symbolic input data:

`arg(2, 3)`, `arg(x, 4)`, `arg(4, y)`, `arg(x, y)`, `arg(10, y + PI)`

`arctan(3/2)`, `arg(x + 4 i)`, `arctan(y/4)`, `arg(x + y i)`, `arctan(y/10 + pi/10)`

If `arg` is called with two arguments, the arguments are implicitly assumed to be real, which allows some additional simplifications compared to a call with only one argument:

`arg(1, y)`, `arg(1 + I*y)`

`arctan(y)`, `arg(1 + y i)`

`arg(x, infinity)`, `arg(-infinity, 3)`, `arg(-infinity, -3)`

$$\frac{\pi}{2}, \pi, -\pi$$

Floating point values are computed for floating-point arguments:

`arg(2.0, 3), arg(2, 3.0), arg(10.0^100, 10.0^(-100))`

$$0.9827937232, 0.9827937232, 1.0 \cdot 10^{-200}$$

## Example 2

`arg` reacts to properties (Symbolic Math Toolbox) of identifiers set via `assume`:

`assume(x > 0): assume(y < 0): arg(x, y)`

$$\arctan\left(\frac{y}{x}\right)$$

`assume(x < 0): assume(y > 0): arg(x, y)`

$$\pi + \arctan\left(\frac{y}{x}\right)$$

`assume(x <> 0): arg(x, 3)`

$$\arctan\left(\frac{3}{x}\right) - \frac{\pi (\text{sign}(x) - 1)}{2}$$

`unassume(x), unassume(y):`

## Example 3

Certain simplifications may occur in unevaluated calls. In particular, numerical factors are eliminated from the first argument:

`arg(3*x, 9*y), arg(-12*sqrt(2)*x, 12*y)`

$$\arg(x + 3y i), \arg(-\sqrt{2}x + y i)$$

### Example 4

Use `rewrite` to convert symbolic calls of `arg` to the logarithmic representation:

```
rewrite(arg(x, y), ln)
```

$$-\ln\left(\frac{x + y i}{|x + y i|}\right) i$$

### Example 5

System functions such as `float`, `limit`, or `series` handle expressions involving `arg`:

```
limit(arg(x, x^2/(1+x)), x = infinity)
```

$$\frac{\pi}{4}$$

```
series(arg(x, x^2), x = 1, 4, Real)
```

$$\frac{\pi}{4} + \frac{x-1}{2} - \frac{(x-1)^2}{4} + \frac{(x-1)^3}{12} + O((x-1)^4)$$

## Parameters

**z**

arithmetical expression (Symbolic Math Toolbox)

**x, y**

arithmetical expressions (Symbolic Math Toolbox) representing real numbers

## **Return Values**

Arithmetical expression.

## **Overloaded By**

x, z

## **See Also**

### **MuPAD Functions**

Im | Re | arctan | rectform



## args

Access procedure parameters

### Syntax

`args()`

`args(0)`

`args(i)`

`args(i .. j)`

### Description

`args(0)` returns the number of parameters of the current procedure.

`args(i)` returns the value of the *i*th parameter of the current procedure.

`args` accesses the actual parameters of a procedure on page 7-45 and can only be used in procedures. It is mainly intended for procedures with a variable number of arguments, since otherwise parameters can simply be accessed by their names.

`args()` returns an expression sequence on page 1-88 of all actual parameters.

`args(i .. j)` returns an expression sequence on page 1-88 containing the *i*th up to the *j*th parameter.

In procedures with option `hold`, `args` returns the parameters without further evaluation. Use `context` or `eval` to enforce a subsequent evaluation. See “Example 2” on page 1-233 (Symbolic Math Toolbox).

`procname ( args() )` returns a symbolic function call of the current procedure with evaluated arguments.

Assigning values to formal parameters of a procedure changes the result of `args`. Cf. “Example 4” on page 1-233 (Symbolic Math Toolbox). `args(0)` remains unchanged.

## Examples

### Example 1

This example demonstrates the various ways of using `args`:

```
f := proc() begin
  print(Unquoted, "number of arguments" = args(0));
  print(Unquoted, "sequence of all arguments" = args());
  if args(0) > 0 then
    print(Unquoted, "first argument" = args(1));
  end_if:
  if args(0) >= 3 then
    print(Unquoted, "second, third argument" = args(2..3));
  end_if:
end_proc:
```

```
f():
```

```
number of arguments = 0
```

```
sequence of all arguments =
```

```
f(42):
```

```
number of arguments = 1
```

```
sequence of all arguments = 42
```

```
first argument = 42
```

```
f(a, b, c, d):
```

```
number of arguments = 4
```

```
sequence of all arguments = (a, b, c, d)
```

```
first argument = a
```

```
second, third argument = (b, c)
```

## Example 2

args does not evaluate the returned parameters in procedures with the option hold. Use context to achieve this:

```
f := proc()
  option hold;
begin
  args(1), context(args(1))
end_proc:

delete x, y: x := y: y := 2: f(x)
```

```
x, 2
```

## Example 3

We use args to access parameters of a procedure with an arbitrary number of arguments:

```
f := proc() begin
  args(1) * _plus(args(2..args(0)))
end_proc:
f(2, 3), f(2, 3, 4)
```

```
6, 14
```

## Example 4

Assigning values to formal parameters affects the behavior of args. In the following example, args returns the value 4, which is assigned inside the procedure, and not the value 1, which is the argument of the procedure call:

```
f := proc(a) begin a := 4; args() end_proc:  
f(1)
```

4

## Parameters

*i*, *j*

Positive integers on page 7-31

## Return Values

`args(0)` returns a nonnegative integer on page 7-31. All other calls return an arbitrary MuPAD object or a sequence of such objects.

## See Also

### MuPAD Domains

`DOM_PROC` | `DOM_VAR`

### MuPAD Functions

`Pref::typeCheck` | `context` | `proc` | `procname` | `testargs`

# array

Create an array

---

**Note** For arrays in MATLAB®, see “Matrices and Arrays” (MATLAB).

---

## Syntax

```
array(m1 .. n1, <m2 .. n2, ...>)
```

```
array(m1 .. n1, <m2 .. n2, ...>, index1 = entry1, index2 = entry2, ...)
```

```
array(m1 .. n1, <m2 .. n2, ...>, List)
```

```
array(<m1 .. n1, m2 .. n2, ...>, ListOfLists)
```

## Description

`array(...)` creates an array, which is an  $n$ -dimensional rectangular structure holding arbitrary data.

`array(m1..n1, m2..n2, ...)` creates an array with uninitialized entries, where the first index runs from  $m_1$  to  $n_1$ , the second index runs from  $m_2$  to  $n_2$ , and so on.

`array(m1..n1, m2..n2, ..., List)` creates an array with entries initialized from `List`.

`array(ListOfLists)` creates an array with entries initialized from `ListOfLists`. The dimension of the array is the same as the dimension of `ListOfLists`.

Arrays are container objects for storing data. In contrast to `tables`, the indices must be sequences of integers. While `tables` can grow in size dynamically, the number of entries in an array created by `array` on page 7-2 is fixed.

Arrays created by `array` are of domain type `DOM_ARRAY`. They may contain arbitrary MuPAD objects as entries.

For an array `A` of type `DOM_ARRAY` or `DOM_HFARRAY` and a sequence of integers `index` forming a valid array index, an indexed on page 1-1017 call `A[index]` returns the corresponding entry. If the entry of an array of type `DOM_ARRAY` is uninitialized, then the indexed expression `A[index]` is returned. See “Example 1” on page 1-237 (Symbolic Math Toolbox) and “Example 5” on page 1-240 (Symbolic Math Toolbox).

An indexed assignment on page 1-257 of the form `A[index] := entry` initializes or overwrites the entry corresponding to `index`. See “Example 1” on page 1-237 (Symbolic Math Toolbox) and “Example 5” on page 1-240 (Symbolic Math Toolbox).

The index boundaries must satisfy  $m_1 \leq n_1$ ,  $m_2 \leq n_2$ , and so on. The dimension of the resulting array is the number of given range arguments; at least one range argument must be specified. The total number of entries of the resulting array is  $(n_1 - m_1 + 1)(n_2 - m_2 + 1) \dots$

If only index range arguments are given, then `array` creates an array with uninitialized entries. Entries are automatically set to 0.0 if no values are specified. See “Example 1” on page 1-237 (Symbolic Math Toolbox).

If equations on page 1-19 of the form `index = entry` are present, then the array entry corresponding to `index` is initialized with `entry`. This is useful for selectively initializing some particular array entries.

Each index must be a valid array index of the form `i1` for one-dimensional arrays and `(i1, i2, ...)` for higher-dimensional arrays, where `i1`, `i2`, ... are integers within valid boundaries, satisfying  $m_1 \leq i_1 \leq n_1$ ,  $m_2 \leq i_2 \leq n_2$ , and so on, and the number of integers in `index` matches the dimension of the array.

If you use the argument `List`, then the resulting array is initialized with the entries from `List`. This is useful for initializing all array entries at once. `List` must have  $(n_1 - m_1 + 1)(n_2 - m_2 + 1) \dots$  elements, each becoming an operand of the array to be created. In case of two-dimensional arrays, regarded as matrices, the list contains the entries row after row.

The argument `ListOfLists` must be a nested list on page 7-41 matching the structure of the array exactly. The nesting depth of the list must be greater or equal to the dimension of the array. The number of list entries at the  $k$ -th nesting level must be equal to the size of the  $k$ -th index range, that is,  $n_k - m_k + 1$ . See “Example 7” on page 1-241 (Symbolic Math Toolbox).

`delete A[index]` deletes the entry corresponding to `index`, so that it becomes uninitialized. See “Example 5” on page 1-240 (Symbolic Math Toolbox).

---

**Note** Internally, uninitialized entries of an array of domain type `DOM_ARRAY` have the value `NIL`. Thus assigning `NIL` to an array entry has the same effect as deleting it via `delete`. Afterwards, an indexed call of the form `A[index]` returns the symbolic expression `A[index]`, and not `NIL`. See “Example 5” on page 1-240 (Symbolic Math Toolbox).

---

A one-dimensional array is printed as a row vector. The index corresponds to the column number.

A two-dimensional array is printed as a matrix. The first index corresponds to the row number, and the second index corresponds to the column number.

Big arrays that exceed the maximal output width `TEXTWIDTH` are printed in the form `array( m_1..n_1, m_2..n_2, dots, index_1 = entry_1, index_2 = entry_2, dots )`. See “Example 6” on page 1-241 (Symbolic Math Toolbox), “Example 7” on page 1-241 (Symbolic Math Toolbox), and “Example 10” on page 1-243 (Symbolic Math Toolbox).

Arithmetic operations are not defined for arrays of domain type `DOM_ARRAY`. Use `matrix` to create one-dimensional vectors or two-dimensional matrices in the mathematical sense.

Note the following special feature of arrays of domain type `DOM_ARRAY`:

---

**Note** If an array is evaluated, it is only returned. The evaluation does not map recursively on the array entries! This is due to performance reasons. You have to `map` the function `eval` explicitly on the array in order to fully evaluate its entries. See “Example 8” on page 1-242 (Symbolic Math Toolbox)

---

## Examples

### Example 1

Create an uninitialized one-dimensional array with indices ranging from 2 to 4:

```
A := array(2..4)
```

```
( NIL NIL NIL )
```

The NILs in the output indicate that the array entries are not initialized. Set the middle entry to 5 and last entry to "MuPAD":

```
A[3] := 5: A[4] := "MuPAD": A
```

```
( NIL 5 "MuPAD" )
```

You can access array entries by using indexed calls. Because the entry A[2] is not initialized, the symbolic expression A[2] is returned:

```
A[2], A[3], A[4]
```

```
A2, 5, "MuPAD"
```

You can initialize an array already when creating it by passing initialization equations to array:

```
A := array(2..4, 3 = 5, 4 = "MuPAD")
```

```
( NIL 5 "MuPAD" )
```

You can initialize all entries of an array when creating it by passing a list of initial values to array:

```
array(2..4, [PI, 5, "MuPAD"])
```

```
( π 5 "MuPAD" )
```

## Example 2

Array boundaries can be specified by negative integers:

```
A := array(-1..1, [2, sin(x), FAIL])
```

```
( 2 sin(x) FAIL )
```

```
A[-1], A[0], A[1]
```



2, sin(x), FAIL

delete A:

### Example 3

If the dimension and size of the array are not specified explicitly, then both values are taken from the given list:

```
array([[1,2],[3,4],[5,6]]) = array(1..3, 1..2, [[1,2],[3,4],[5,6]]);
bool(%)
```

$$\begin{pmatrix} 1 & 2 \\ 3 & 4 \\ 5 & 6 \end{pmatrix} = \begin{pmatrix} 1 & 2 \\ 3 & 4 \\ 5 & 6 \end{pmatrix}$$

TRUE

Note that all subfields of one dimension must have the same size and dimension. Therefore, the following input leads to an error:

```
array([[1],[3,4],[5,6]])
```

Error: Invalid argument. [array]

### Example 4

You can use the \$ operator to create a sequence of initialization equations:

```
array(1..8, i = i^2 $ i = 1..8)
```

( 1 4 9 16 25 36 49 64 )

Equivalently, you can use the \$ operator to create an initialization list:

```
array(1..8, [i^2 $ i = 1..8])
```

( 1 4 9 16 25 36 49 64 )

### Example 5

Create a 2×2 matrix as a two-dimensional array:

`A := array(1..2, 1..2, (1, 2) = 42, (2, 1) = 1 + I)`

( NIL 42 )  
( 1+i NIL )

Internally, array entries are stored in a linearized form. They can be accessed in this form via `op`. Uninitialized entries internally have the value `NIL`:

`op(A, 1), op(A, 2), op(A, 3), op(A, 4)`

NIL, 42, 1 + i, NIL

Note the difference to the indexed access:

`A[1, 1], A[1, 2], A[2, 1], A[2, 2]`

$A_{1,1}$ , 42, 1 + i,  $A_{2,2}$

Modify an array entry by an indexed assignment:

`A[1, 1] := 0: A[1, 2] := 5:`  
`A`

( 0 5 )  
( 1+i NIL )

Delete the value of an array entry via `delete`. Afterwards, it is uninitialized again:

`delete A[2, 1]: A[2, 1], op(A, 3)`

$A_{2,1}$ , NIL

Assigning NIL to an array entry has the same effect as deleting it:

```
A[1, 2] := NIL: A[1, 2], op(A, 2)
```

$A_{1,2}, \text{NIL}$

## Example 6

Define a three-dimensional array with index values between 1 and 8 in each of the three dimensions. Initialize two of the entries via initialization equations:

```
A := array(1..8, 1..8, 1..8, (1, 1, 1) = 111, (8, 8, 8) = 888)
```

```
array(1..8, 1..8, 1..8,
      (1, 1, 1) = 111
      (8, 8, 8) = 888
      )
```

```
A[1, 1, 1], A[1, 1, 2]
```

$111, A_{1,1,2}$

```
delete A
```

## Example 7

You can use a nested list to initialize a two-dimensional array. The inner lists are the rows of the created matrix:

```
array(1..2, 1..3, [[1, 2, 3], [4, 5, 6]])
```

$\begin{pmatrix} 1 & 2 & 3 \\ 4 & 5 & 6 \end{pmatrix}$

Create a three-dimensional array and initialize it from a nested list of depth three. The outer list has two entries for the first dimension. Each of these entries is a list with three

entries for the second dimension. Finally, the innermost lists each have one entry for the third dimension:

```
array(2..3, 1..3, 1..1,  
      [  
        [ [1], [2], [3] ],  
        [ [4], [5], [6] ]  
      ]  
)
```

```
array(2..3, 1..3, 1..1,  
      (2, 1, 1) = 1  
      (2, 2, 1) = 2  
      (2, 3, 1) = 3  
      (3, 1, 1) = 4  
      (3, 2, 1) = 5  
      (3, 3, 1) = 6  
    )
```

## Example 8

If an array is evaluated, it is only returned. The evaluation does not map recursively on the array entries. Here, the entries `a` and `b` are not evaluated:

```
A := array(1..2, [a, b]):  
a := 1: b := 2:  
A, eval(A)
```

```
( a b ), ( a b )
```

Due to the special evaluation of arrays the index operator evaluates array entries after extracting them from the array:

```
A[1], A[2]
```

```
1, 2
```

To fully evaluate its entries, map the function `eval` explicitly on the array:

```
map(A, eval)
```

```
( 1 2 )
```

## Example 10

A two-dimensional array is usually printed in a matrix form:

```
A := array(1..4, 1..4, (1, 1) = 11, (4, 4) = 44)
```

```
( 11 NIL NIL NIL
  NIL NIL NIL NIL
  NIL NIL NIL NIL
  NIL NIL NIL 44 )
```

If the output does not fit into TEXTWIDTH, a more compact output is used in print:

```
PRETTYPRINT := FALSE:
TEXTWIDTH := 20:
print(Plain, A)
```

```
array(1..4, 1..4, (\
1, 1) = 11, (4, 4) \
= 44)
```

```
PRETTYPRINT := TRUE:
```

```
delete A, TEXTWIDTH
```

## Parameters

$m_1, n_1, m_2, n_2, \dots$

The index boundaries: integers on page 7-31

$index_1, index_2, \dots$

A sequence of integers on page 7-31 defining a valid array index

**entry<sub>1</sub>, entry<sub>2</sub>, ...**

Arbitrary objects

### **List**

A plain list on page 7-41 of entries for initializing the array

### **ListOfLists**

A nested list (of lists of lists of ...) of entries for initializing the array

## **Return Values**

Object of type DOM\_ARRAY.

## **See Also**

### **MuPAD Domains**

DOM\_ARRAY | DOM\_HFARRAY | DOM\_LIST | DOM\_TABLE

### **MuPAD Functions**

\_assign | \_index | assignElements | delete | hfarray | indexval | matrix | table

# hfarray

Create an array of hardware floating-point values

## Syntax

```
hfarray( $m_1$  ..  $n_1$ ,  $\langle m_2$  ..  $n_2$ , ... $\rangle$ )
```

```
hfarray( $m_1$  ..  $n_1$ ,  $\langle m_2$  ..  $n_2$ , ... $\rangle$ ,  $index_1 = number_1$ ,  $index_2 = number_2$ , ...)
```

```
hfarray( $m_1$  ..  $n_1$ ,  $\langle m_2$  ..  $n_2$ , ... $\rangle$ , List)
```

```
hfarray( $\langle m_1$  ..  $n_1$ ,  $m_2$  ..  $n_2$ , ... $\rangle$ , ListOfLists)
```

## Description

`hfarray(...)` creates an array specialized to hold hardware floating-point values. These values *do not* react to DIGITS, and no symbolic expressions can be placed into an `hfarray`. The values can be real or complex. If you pass symbolic objects to `hfarray`, it throws an error.

`hfarray( $m_1$ .. $n_1$ ,  $m_2$ .. $n_2$ , ...)` creates an array of floating-point zeroes, where the first index runs from  $m_1$  to  $n_1$ , the second index runs from  $m_2$  to  $n_2$ , and so on.

`hfarray( $m_1$ .. $n_1$ ,  $m_2$ .. $n_2$ , ..., List)` creates an array of floating-point numbers with entries initialized from `List`.

`hfarray(ListOfLists)` creates an array of floating-point numbers with entries initialized from `ListOfLists`. The dimension of the `hfarray` is the same as the dimension of `ListOfLists`.

Arrays are container objects for storing data. In contrast to `tables`, the indices must be sequences of integers. While `tables` can grow in size dynamically, the number of entries in an array created by `hfarray` on page 7-27 is fixed.

Arrays created via `hfarray` are of domain type `DOM_HFARRAY`. They can only contain floating-point numbers as entries. Internally, these floating-point numbers are stored as hardware floating values with about 15 significant decimal digits (“double precision”).

This data type serves for storing large amounts of numerical data. For example, an array of floating-point values with 15 significant decimal digits created via `array` (using `DIGITS = 15`) takes nearly 10 times as much storage space as the corresponding array created by `hfarray`.

On input, the entries passed to `hfarray` can be MuPAD floating-point numbers, integers or rational numbers, or exact numerical expressions such as `PI + sin(sqrt(2))` that can be converted to floating-point numbers. Exact input data are automatically converted to hardware floating-point values of double precision. This conversion does not depend on the current value of `DIGITS`!

---

**Note** Entries of absolute value smaller than about  $10^{-308}$  are stored as 0.0 by `hfarray`!

---

For an array `A` of type `DOM_HFARRAY` and a sequence of integers `index` forming a valid array index, an indexed on page 1-1017 call `A[index]` returns the corresponding entry. See “Example 1” on page 1-247 (Symbolic Math Toolbox) and “Example 5” on page 1-250 (Symbolic Math Toolbox).

An indexed assignment on page 1-257 of the form `A[index] := entry` initializes or overwrites the entry corresponding to `index`. See “Example 1” on page 1-247 (Symbolic Math Toolbox) and “Example 5” on page 1-250 (Symbolic Math Toolbox).

The index boundaries must satisfy  $m_1 \leq n_1$ ,  $m_2 \leq n_2$ , and so on. The dimension of the resulting array is the number of given range arguments; at least one range argument must be specified. The total number of entries of the resulting array is  $(n_1 - m_1 + 1)(n_2 - m_2 + 1) \dots$

Arrays created by `hfarray` cannot have uninitialized entries. Entries are automatically set to 0.0 if no values are specified. See “Example 1” on page 1-247 (Symbolic Math Toolbox).

If equations on page 1-19 of the form `index = entry` are present, then the array entry corresponding to `index` is initialized with `entry`. This is useful for selectively initializing some particular array entries.

Each index must be a valid array index of the form `i1` for one-dimensional arrays and `(i1, i2, ...)` for higher-dimensional arrays, where `i1`, `i2`, ... are integers within the valid boundaries, satisfying  $m_1 \leq i_1 \leq n_1$ ,  $m_2 \leq i_2 \leq n_2$ , and so on, and the number of integers in `index` matches the dimension of the array.



If you use the argument `List`, then the resulting array is initialized with the entries from `List`. This is useful for initializing all array entries at once. The list must have  $(n_1 - m_1 + 1)(n_2 - m_2 + 1) \dots$  elements, each becoming an operand of the array to be created. In case of two-dimensional arrays, regarded as a matrix, the list contains the entries row after row.

The argument `ListOfLists` must be a nested list on page 7-41 matching the structure of the array exactly. The nesting depth of the list must be greater or equal to the dimension of the array. The number of list entries at the  $k$ -th nesting level must be equal to the size of the  $k$ -th index range, that is,  $n_k - m_k + 1$ . See “Example 7” on page 1-251 (Symbolic Math Toolbox).

A one-dimensional array is printed as a row vector. The index corresponds to the column number.

A two-dimensional array is printed as a matrix. The first index corresponds to the row number, and the second index corresponds to the column number.

Arrays of dimension greater than two are printed in the form `hfarray(m_1..n_1, m_2..n_2, dots, index_1 = entry_1, index_2 = entry_2, ...)`. See “Example 6” on page 1-251 (Symbolic Math Toolbox) and “Example 7” on page 1-251 (Symbolic Math Toolbox).

Arithmetic operations are not defined for arrays of domain type `DOM_ARRAY`. Use `matrix` to create 1-dimensional vectors or 2-dimensional matrices in the mathematical sense.

Arithmetic operations are defined for arrays of domain type `DOM_HFARRAY`. For example, linear combination of arrays `A`, `B` can be computed via `a*A + b*B` if `A`, `B` have the same format and if the scalar factors `a`, `b` are numbers (floating-point values, integers, or rationals). Two-dimensional `hfarrays` `A`, `B` are processed like matrices: operations, such as matrix multiplication `A*B`, matrix powers `A^n`, or matrix inversion `1/A`, are possible wherever this is meaningful mathematically. See “Example 8” on page 1-252 (Symbolic Math Toolbox).

## Examples

### Example 1

Hardware float arrays do not have uninitialized entries. If no initialization value is given, the corresponding entry is set to 0.0:

```
hfarray(-1..5)
```

```
( 0.0 0.0 0.0 0.0 0.0 0.0 )
```

Set one of the entries to the floating-point approximation of PI and another entry to the floating-point approximation of  $\sqrt{2} \cdot \exp(2)$ :

```
hfarray(-1..5, 2 = PI, 4 = sqrt(2)*exp(2))
```

```
( 0.0 0.0 0.0 3.141592654 0.0 10.44970335 0.0 )
```

Use a list of random values to specify entries of the array:

```
hfarray(-1..5, [frandom() $ i = -1..5])
```

```
[[0.2703581656, 0.8310371787, 0.153156516, 0.9948127808, 0.2662729021, 0.1801642277,  
0.452083055]]
```

Use a nested list to specify entries of an array:

```
hfarray(1..2, 1..3, [[1, 2, 3], [4, 5, 6]])
```

```
( 1.0 2.0 3.0  
  4.0 5.0 6.0 )
```

Alternatively, use a flat list:

```
hfarray(1..2, 1..3, [1, 2, 3, 4, 5, 6])
```

```
( 1.0 2.0 3.0  
  4.0 5.0 6.0 )
```

## Example 2

Array boundaries may be negative integers as well:

```
A := hfarray(-1..2, -3..-1, [[-1, -1, -1],  
                             [ 0,  0,  0],
```

```
[ 1, 1, 1],
[ 2, 2, 2]]
```

$$\begin{pmatrix} -1.0 & -1.0 & -1.0 \\ 0.0 & 0.0 & 0.0 \\ 1.0 & 1.0 & 1.0 \\ 2.0 & 2.0 & 2.0 \end{pmatrix}$$

```
A[-1, -2], A[0, -3], A[2, -3]
```

```
-1.0, 0.0, 2.0
```

```
delete A:
```

### Example 3

If the dimension and size of the hfarray are not specified explicitly, then both values are taken from the given list:

```
hfarray([1.0,2.0,3.0,4.0,5.0]) = hfarray(1..5, [1.0,2.0,3.0,4.0,5.0]);
bool(%)
```

```
(1.0 2.0 3.0 4.0 5.0) = (1.0 2.0 3.0 4.0 5.0)
```

```
TRUE
```

Note that all subfields of one dimension must have the same size and dimension. Therefore, the following input leads to an error:

```
hfarray([[1],[3,4],[5,6]])
```

```
Error: Invalid argument. [hfarray]
```

### Example 4

You can use the \$ operator to create a sequence of initialization equations:

```
hfarray(1..4, 1..4, (i, i) = 1 $ i = 1..4)
```

```
( 1.0 0.0 0.0 0.0
  0.0 1.0 0.0 0.0
  0.0 0.0 1.0 0.0
  0.0 0.0 0.0 1.0)
```

Equivalently, you can use the \$ operator to create an initialization list:

```
hfarray(1..8, [i*PI $ i = 1..8])
```

```
[[3.141592654, 6.283185307, 9.424777961, 12.56637061, 15.70796327, 18.84955592,
  21.99114858, 25.13274123]]
```

## Example 5

Create a 2×2 matrix as a 2-dimensional array:

```
A := hfarray(1..2, 1..2, (1, 1) = 1.0, (2, 2) = 1.0)
```

```
( 1.0 0.0
  0.0 1.0)
```

Internally, array entries are stored in a linearized form. They can be accessed in this form via `op` or via indexed access:

```
op(A, 1), op(A, 2), op(A, 3), op(A, 4)
```

```
1.0, 0.0, 0.0, 1.0
```

```
A[1, 1], A[1, 2], A[2, 1], A[2, 2]
```

```
1.0, 0.0, 0.0, 1.0
```

Modify an array entry by an indexed assignment:

```
A[2, 2] := PI:
A[1, 2] := 5:
A
```

```
(1.0 5.0
 0.0 3.141592654)
```

```
delete A:
```

## Example 6

Create a 3-dimensional hfarray:

```
A := hfarray(1..2, 2..3, 3..4, (1, 2, 3) = 123, (2, 3, 4) = 234)
```

```
hfarray(1..2, 2..3, 3..4, [123.0, 0.0, 0.0, 0.0, 0.0, 0.0, 0.0, 234.0])
```

```
delete A:
```

## Example 7

You can use a nested list to initialize a two-dimensional hfarray. The inner lists are the rows of the created matrix:

```
hfarray(1..2, 1..3, [[1, 2, 3], [4, 5, 6]])
```

```
(1.0 2.0 3.0
 4.0 5.0 6.0)
```

Create a three-dimensional hfarray and initialize it from a nested list of depth three. The outer list has two entries for the first dimension. Each of these entries is a list with three entries for the second dimension. Finally, the innermost lists each have one entry for the third dimension:

```
hfarray(2..3, 1..3, 1..1,
  [
    [ [1], [2], [3] ],
    [ [4], [5], [6] ]
  ])
```

```
hfarray(2..3, 1..3, 1..1, [1.0, 2.0, 3.0, 4.0, 5.0, 6.0])
```

## Example 8

Basic arithmetic is available for arrays of domain type DOM\_HFARRAY:

```
A := hfarray(1..5, [1, 2, 3, 4, 5]):  
B := hfarray(1..5, [5, 4, 3, 2, 1]):  
A + B
```

```
( 6.0 6.0 6.0 6.0 6.0 )
```

```
2*A
```

```
( 2.0 4.0 6.0 8.0 10.0 )
```

```
2*A - 3* B
```

```
( -13.0 -8.0 -3.0 2.0 7.0 )
```

Two-dimensional arrays of type DOM\_HFARRAY are regarded as matrices. They can be multiplied accordingly:

```
A := hfarray(1..3, 1..3, [frandom() $ i = 1..9]):  
B := hfarray(1..3, 1..2, [frandom() $ i = 1..6]):  
A, B, A * B, A^10 * B
```

```
( 0.6787819563 0.3549849261 0.6818588132 ) ( 0.8791601269 0.9193848479 )  
( 0.7219186551 0.4738297742 0.7889814922 ) ( 0.7350574234 0.7875450269 )  
( 0.2115258358 0.8556871754 0.04489739417 ) ( 0.9371484273 0.2953238727 )  
  
( 1.49669525 1.104997644 ) ( 104.6209923 83.25909538 )  
( 1.722366954 1.269888425 ) ( 121.6963323 96.84792749 )  
( 0.8570198134 0.8816251003 ) ( 80.3865413 63.97259571 )
```

The following command computes the matrix inverse of A:

```
1/A
```

$$\begin{pmatrix} 15.13041048 & -13.13273828 & 0.9952407788 \\ -3.111891486 & 2.632361162 & 1.001982382 \\ -11.97546309 & 11.70303455 & -1.512395388 \end{pmatrix}$$

Some functions, such as `norm`, accept hfarrays:

```
norm(A)
```

```
1.984729921
```

## Parameters

**`m1`, `n1`, `m2`, `n2`, ...**

The index boundaries: integers on page 7-31

**`index1`, `index2`, ...**

A sequence of integers on page 7-31 defining a valid array index

**`number1`, `number2`, ...**

Real or complex floating-point numbers or numerical expressions that can be converted to real or complex floating-point numbers

**List**

A plain list on page 7-41 of entries for initializing the array

**ListOfLists**

A nested list (of lists of lists of ...) of entries for initializing the array

## Return Values

Object of type `DOM_ARRAY` or `DOM_HFARRAY`, respectively.

## See Also

### **MuPAD Domains**

DOM\_ARRAY | DOM\_HFARRAY | DOM\_LIST | DOM\_TABLE

### **MuPAD Functions**

\_assign | \_index | array | assignElements | delete | indexval | matrix | table



# assert

Assertions for debugging

## Syntax

```
assert(cond)
```

## Description

The statement `assert(cond)` declares that the condition `cond` holds true at the moment when the statement is evaluated. By default, MuPAD does not care about assertions. After setting `testargs(TRUE)`, however, MuPAD checks every assertion and stops with an error if boolean evaluation of `cond` does not give `TRUE`.

Assertions are a major debugging tool for programmers: by stating frequently what they think to have achieved, programmers make it easy for themselves to detect the first unintended intermediate result.

## Examples

### Example 1

Suppose we want to write a function `f` that takes an integer as its argument and returns 0 if that integer is a multiple of 3, and 1 otherwise. One idea how to code this could be the following: given an integer  $n$ ,  $n$  modulo 3 must be equal to one of -1, 1, or 0. In any case, `abs(n mod 3)` should do what we want:

```
f := proc(n: DOM_INT): DOM_INT
local k: DOM_INT;
begin
  k := n mod 3;
  assert(k = 1 or k = -1 or k = 0);
  abs(k)
end_proc
```

```
proc f(n) ... end
```

Checking assertions is switched on or off using `testargs`:

```
oldtestargs := testargs(): testargs(FALSE): f(5)
```

2

The result does not equal 1. For debugging purposes, we switch on assertion checking:

```
testargs(TRUE): f(5)
```

```
Error: Assertion 'k = 1 or k = -1 or k = 0' has failed. [f]
```

This shows that the local variable `k` must have gotten a wrong value. Indeed, when writing our program we overlooked the difference between `mod` and the symmetric remainder given by `mods`.

```
testargs(oldtestargs):
```

## Parameters

**cond**

A boolean expression

## Return Values

`assert` returns `TRUE` or raises an error.

## See Also

**MuPAD Functions**

`testargs`

# assign

Perform assignments given as equations

## Syntax

`assign(L)`

`assign(L, S)`

## Description

For each equation in a list, a set, or a table of equations `L`, `assign(L)` evaluates both sides of the equation and assigns the evaluated right hand side to the evaluated left hand side.

`assign(L, S)` does the same, but only for those equations whose left hand side is in the set `S`.

Since the arguments of `assign` are evaluated, the *evaluation* of the left hand side of each equation in `L` must be an admissible left hand side for an assignment. See the help page of the assignment operator `:=` for details.

Several assignments are performed from left to right. See “Example 4” on page 1-259 (Symbolic Math Toolbox).

`assign` can be conveniently used after a call to `solve` to assign a particular solution of a system of equations to the unknowns. See “Example 5” on page 1-259 (Symbolic Math Toolbox).

## Examples

### Example 1

We assign values to the three identifiers `B1`, `B2`, `B3`:

```
delete B1, B2, B3:  
assign([B1 = 42, B2 = 13, B3 = 666]): B1, B2, B3
```

42, 13, 666

We specify a second argument to carry out only those assignments with left hand side B1:

```
delete B1, B2, B3:  
assign([B1 = 42, B2 = 13, B3 = 666], {B1}): B1, B2, B3
```

42, B2, B3

The first argument may also be a table of equations:

```
delete B1, B2, B3:  
assign(table(B1 = 42, B2 = 13, B3 = 666)): B1, B2, B3
```

42, 13, 666

## Example 2

Unlike `_assign`, `assign` evaluates the left hand sides:

```
delete a, b: a := b: assign({a = 3}): a, b
```

3, 3

```
delete a, b: a := b: a := 3: a, b
```

3, *b*

## Example 3

The object assigned may also be a sequence:

```
assign([X=(2,7)])
```

$$[X = (2, 7)]$$

X

$$2, 7$$

### Example 4

The assignments are carried out one after another, from left to right. Since the right hand side is evaluated, the identifier C gets the value 3 in the following example:

```
assign([B=3, C=B])
```

$$[B = 3, C = B]$$

```
level(C,1)
```

$$3$$

### Example 5

When called for an algebraic system, `solve` often returns a set of lists of assignments. `assign` can then be used to assign the solutions to the variables of the system:

```
sys:={x^2+y^2=2, x+y=5}:
S:= solve(sys)
```

$$\left\{ \left[ x = \frac{5}{2} - \frac{\sqrt{21}i}{2}, y = \frac{5}{2} + \frac{\sqrt{21}i}{2} \right], \left[ x = \frac{5}{2} + \frac{\sqrt{21}i}{2}, y = \frac{5}{2} - \frac{\sqrt{21}i}{2} \right] \right\}$$

We want to check whether the first solution is really a solution:

```
assign(S[1]): sys
```

$$\left\{ 5 = 5, \left( -\frac{5}{2} + \frac{\sqrt{21}i}{2} \right)^2 + \left( \frac{5}{2} + \frac{\sqrt{21}i}{2} \right)^2 = 2 \right\}$$

Things become clearer if we use floating-point evaluation:

```
float(sys)
```

```
{2.0 = 2.0, 5.0 = 5.0}
```

## Parameters

**L**

A list on page 7-41, a set on page 7-50, or a table on page 1-2103 of equations on page 1-19

**S**

A set on page 7-50

## Return Values

L.

## See Also

### MuPAD Functions

:= | \_assign | assignElements | delete | evalassign

# assignElements

Assign values to entries of an array, a list, or a table

## Syntax

```
assignElements(L, [index1] = value1, [index2] = value2, ...)
```

```
assignElements(L, [[index1], value1], [[index2], value2], ...)
```

## Description

`assignElements(L, [index1] = value1, [index2] = value2, ...)` returns a copy of `L` with `value1` stored at `index1`, `value2` stored at `index2`, etc.

`R := assignElements(L, [index1]=value1, [index2]=value2, ...)` has the same effect as the sequence of assignments `R:=L: R[index1]:=value1: R[index2]:=value2: ... R`, but is more efficient.

`assignElements` returns a modified copy of its first argument, which remains unchanged. See “Example 1” on page 1-262 (Symbolic Math Toolbox).

The second variant of the `assignElements` call, with lists instead of equations, is equivalent to the first variant. In fact, both equations and lists may be mixed in a single call. See “Example 1” on page 1-262 (Symbolic Math Toolbox).

All assignments are performed simultaneously, i.e., the order of the arguments is irrelevant. See “Example 3” on page 1-263 (Symbolic Math Toolbox).

All rules for indexed assignments on page 1-257 apply, in particular with respect to the validity of indices. If `L` is a list on page 7-41, the indices must be positive integers on page 7-31 not exceeding the length of `L`. If `L` is an array on page 7-2, the indices must be (sequences of) integers matching the dimension and lying within the valid ranges of the array. If `L` is a table on page 1-2103, the indices may be arbitrary objects.

## Examples

### Example 1

Assignments may given as equations or lists, and both forms may be mixed in a single call:

```
L := array(1..3, [3, 4, 5]);  
assignElements(L, [1] = one, [2] = two, [3] = three);  
assignElements(L, [[1], one], [[2], two], [[3], three]);  
assignElements(L, [1] = one, [[2], two], [3] = three);
```

( 3 4 5 )

( one two three )

( one two three )

( one two three )

The array L itself is not modified by assignElements:

L

( 3 4 5 )

### Example 2

Sequences, too, may be assigned as values to array elements, but they must be put in parentheses:

```
R := assignElements(array(1..2), [1] = (1, 7), [2] = PI);  
[R[1]], [R[2]]
```

((1, 7)  $\pi$ )



```
[1, 7], [π]
```

### Example 3

The sequence generator \$ is useful to create sequences of assignments:

```
L := [i $ i = 1..10];
assignElements(L, [i] = L[i] + L[i + 1] $ i = 1..9)
```

```
[1, 2, 3, 4, 5, 6, 7, 8, 9, 10]
```

```
[3, 5, 7, 9, 11, 13, 15, 17, 19, 10]
```

The order of the arguments is irrelevant:

```
assignElements(L, [10 - i] = L[10 - i] + L[11 - i] $ i = 1..9)
```

```
[3, 5, 7, 9, 11, 13, 15, 17, 19, 10]
```

### Example 4

The indices of a table may be arbitrary objects, for example, strings:

```
assignElements(table(), [expr2text(i)] = i^2 $ i = 1..4)
```

```

┌───┬───┐
│"1"│ 1  │
│"2"│ 4  │
│"3"│ 9  │
│"4"│16  │
└───┴───┘
```

### Example 5

For arrays of dimension greater than one, the indices are sequences of as many integers as determined by the dimension of the array:

```
assignElements(array(1..3, 1..3),  
  ([i, j] = i + j $ i = 1..3) $ j = 1..3)
```

$$\begin{pmatrix} 2 & 3 & 4 \\ 3 & 4 & 5 \\ 4 & 5 & 6 \end{pmatrix}$$

## Parameters

**L**

An array on page 7-2, an hfarray on page 7-27, a list on page 7-41, or a table on page 1-2103

**index1, index2, ...**

Valid indices for L

**value1, value2, ...**

Any MuPAD objects

## Return Values

Object of the same type as L.

## See Also

### MuPAD Domains

DOM\_ARRAY | DOM\_HFARRAY | DOM\_LIST | DOM\_TABLE

### MuPAD Functions

:= | \_assign | \_index | array | assign | delete | evalassign | table

## assume

Set permanent assumption

### Syntax

```
assume(condition)
```

```
assume(expr, set)
```

### Description

`assume(condition)` sets the assumption that `condition` is true for all further calculations. This call removes all previous assumptions containing identifiers used in `condition`.

`assume(expr, set)` attaches the property `set` to the identifier or expression `expr`. This call overwrites all previous assumptions containing identifiers used in `expr`.

Assumptions are mathematical conditions that are assumed to hold true for all calculations. By default, all MuPAD identifiers are independent of each other and can take any value in the complex plane. For example, `sign(1 + x^2)` cannot be simplified any more because MuPAD assumes that `x` is a complex number. If you set an assumption that `x` is a real number, then MuPAD can simplify `sign(1 + x^2)` to 1.

For this reason, many MuPAD functions return very general or piecewise-defined results that depend on further conditions. For example, `solve` or `int` can return piecewise results.

Many mathematical theorems hold only under certain conditions. For example,  $x^b y^b = (x y)^b$  holds if `b` is an integer. But this equation is not true for all combinations of `x`, `y`, and `b`. For example, it is not true if `x = y = -1`, `b = 1/2`. In such cases, you can use assumptions to get more specific results.

If you use `assume` inside a function or procedure, MuPAD uses the new assumption and ignores existing assumptions only inside the function or procedure. After the function or procedure call, MuPAD removes the new assumption and restores the assumptions that were set before the function or procedure call.

If `condition` is a relation (for example,  $x < y$ ), then MuPAD implicitly assumes that both sides of the relation are real. See “Example 4” on page 1-268 (Symbolic Math Toolbox).

To delete assumptions previously set on `x`, use `unassume(x)` or `delete x`.

When you assign a value to an identifier with assumptions, the assigned value can be inconsistent with existing assumptions. Assignments overwrite all assumptions previously set on an identifier. See “Example 5” on page 1-270 (Symbolic Math Toolbox).

`assume` accepts any `condition` and Boolean combinations of `conditions`. See “Example 7” on page 1-271 (Symbolic Math Toolbox).

If `expr` is a list, vector, or matrix, use the syntax `assume(expr, set)`. Here `set` must be specified as one of `C_`, `R_`, `Q_`, `Z_`, `N_`, or an expression constructed with the set operations, such as `union`, `intersect`, or `minus`. `set` also can be a function of the Type library, for example, `Type::Real`, `Type::Integer`, `Type::PosInt`, and so on.

Do not use the syntaxes `assume(expr in set)` and `assume(condition)` for nonscalar `expr`.

## Examples

### Example 1

Set an assumption that identifier `n` is an integer. Here, `assume(n, Type::Integer)` is equivalent to `assume(n in Z_)` because `n` is a scalar.

```
assume(n, Type::Integer):  
assume(n in Z_):  
getprop(n);
```

$\mathbb{Z}$

Check if `n^2` is a nonnegative integer. MuPAD uses the assumption that you set on `n`.

```
is(n^2, Type::NonNegInt)
```

TRUE

Other system functions take this assumption into account:

```
abs(n^2 + 1);
simplify(sin(2*n*PI))
```

$$n^2 + 1$$

$$0$$

For further computations, delete the identifier n:

```
delete n
```

## Example 2

To keep the existing assumptions and combine them with the new ones, use `assumeAlso`:

```
assume(n, Type::Integer):
getprop(n);
```

$$\mathbb{Z}$$

```
assumeAlso(n, Type::Positive):
getprop(n);
```

$$\mathbb{Z} \cap [1, \infty)$$

For further computations, delete the identifier n:

```
delete n
```

Alternatively, set multiple assumptions in one function call:

```
assume(n, Type::Integer and Type::Positive):
getprop(n);
```

$$\mathbb{Z} \cap [1, \infty)$$

For further computations, delete the identifier `n`:

```
delete n
```

### Example 3

You can set separate assumptions on the real and imaginary parts of an identifier:

```
assume(Re(z) > 0);  
assumeAlso(Im(z) < 0):
```

```
abs(Re(z));  
sign(Im(z))
```

```
ℜ(z)
```

```
-1
```

```
is(z, Type::Real), is(z > 0)
```

```
FALSE, FALSE
```

For further computations, delete the identifier `z`:

```
delete z
```

### Example 4

Using `assume`, set the assumption  $x > y$ . Assumptions set as relations affect the properties of both identifiers.

```
assume(x > y)
```

To see the assumptions set on identifiers, use `getprop`:

```
getprop(x);  
getprop(y);
```

```
(y, ∞)
```

$$(-\infty, x)$$

To keep an existing assumption on  $y$  and add a new one, use `assumeAlso`. For example, add the new assumption that  $y$  is greater than 0 while keeping the assumption that  $y$  is less than  $x$ :

```
assumeAlso(y > 0)
is(x^2 >= y^2)
```

TRUE

Relations, such as  $x > y$ , imply that the involved identifiers are real on page 33-111:

```
is(x, Type::Real), is(y, Type::Real)
```

TRUE, TRUE

You also can set a relational assumption where one side is not an identifier, but an expression:

```
assume(x > 1/y)
getprop(x);
getprop(y)
```

$$\left(\frac{1}{y}, \infty\right)$$

$\mathbb{R}$

For further computations, delete the identifiers  $x$  and  $y$ :

```
delete x, y
```

## Example 5

`_assign` and `:=` do not check if an identifier has any assumptions. The assignment operation overwrites all assumptions:

```
assume(a > 0):  
a := -2:  
a, getprop(a)
```

```
-2, {-2}
```

For further computations, delete the identifier `a`:

```
delete a
```

## Example 6

Set the assumption that `x` is positive and find the absolute value of `x`, the sign of `x`, and the real and imaginary parts of `x`. These system functions take assumptions set on identifiers into account:

```
assume(x > 0):  
abs(x), sign(x), Re(x), Im(x)
```

```
x, 1, x, 0
```

Try expanding the expression  $\ln(z1*z2)$  without additional assumptions. It does not expand because  $\ln(z1*z2) = \ln(z1) + \ln(z2)$  is not true for arbitrary `z1`, `z2` in the complex plane:

```
expand(ln(z1*z2))
```

```
ln(z1 z2)
```

Now, set the assumption that one number is real and positive. Expand the same expression:

```
assume(z1 > 0): expand(ln(z1*z2))
```



$$\ln(z1) + \ln(z2)$$

For further computations, remove the assumptions on  $x$  and  $z1$ :

```
unassume(x); unassume(z1)
```

## Example 7

Set these two assumptions on the identifier  $a$ . To combine the assumptions, use the Boolean operator `and`:

```
assume(a > 0 and a in Z_):
is(a = 0);
is(a = 1/2);
is(a = 2);
```

FALSE

FALSE

UNKNOWN

## Parameters

### **expr**

Identifier on page 7-29, mathematical expression, list, vector, or matrix containing identifiers.

If `expr` is a list, vector, or matrix, then only the syntax `assume(expr, set)` is valid.

### **set**

Property representing a set of numbers or a set returned by `solve`.

For example, this set can be an element of `Dom::Interval`, `Dom::ImageSet`, `piecewise`, or one of `C_`, `R_`, `Q_`, `Z_`, `N_`. It also can be an expression constructed with

the set operations, such as `union`, `intersect` or `minus`. For more examples, see “Properties” (Symbolic Math Toolbox).

### **condition**

Equality, inequality, element of relation, or Boolean combination (with the operators `and` or `or`).

## **Return Values**

Void object `null()` of type `DOM_NULL`.

## **See Also**

### **MuPAD Functions**

`assumeAlso` | `assuming` | `assumingAlso` | `getprop` | `is` | `property::hasprop` | `property::showprops` | `unassume`

## **Topics**

“Use Permanent Assumptions” (Symbolic Math Toolbox)

# assumeAlso

Add permanent assumption

## Syntax

```
assumeAlso(condition)
```

```
assumeAlso(expr, set)
```

## Description

`assumeAlso(condition)` adds the assumption that `condition` is true for all further calculations. It does not remove previous assumptions containing identifiers used in `condition`.

`assumeAlso(expr, set)` attaches the property `set` to the identifier or expression `x`. It does not remove previous assumptions containing identifiers used in `expr`.

Assumptions are mathematical conditions that are assumed to hold true for all calculations. By default, all MuPAD identifiers are independent of each other and can take any value in the complex plane. For example, `sign(1 + x^2)` cannot be simplified any more because `x` MuPAD assumes that `x` is a complex number. If you set an assumption that `x` is a real number, then MuPAD can simplify `sign(1 + x^2)` to 1.

For this reason, many MuPAD functions return very general or piecewise-defined results depending on further conditions. For example, `solve` or `int` can return piecewise results.

Many mathematical theorems hold only under certain conditions. For example,  $x^b y^b = (x y)^b$  holds if `b` is an integer. But this equation is not true for all combinations of `x`, `y`, and `b`. For example, it is not true if `x = y = -1`, `b = 1/2`. In such cases, you can use assumptions to get more specific results.

If you use `assumeAlso` inside a function or procedure, MuPAD uses that assumption only inside the function or procedure. After the function or procedure call, MuPAD removes that assumption and only keeps the assumptions that were set before the function or procedure call.

If `condition` is a relation (for example,  $x < y$ ), then MuPAD implicitly assumes that both sides of the relation are real. See “Example 4” on page 1-276 (Symbolic Math Toolbox).

To delete assumptions previously set on `x`, use `unassume(x)` or `delete x`.

When assigning a value to an identifier with assumptions, the assigned value can be inconsistent with existing assumptions. Assignments overwrite all assumptions previously set on an identifier. See “Example 5” on page 1-278 (Symbolic Math Toolbox).

`assumeAlso` accepts any `condition` and Boolean combinations of `conditions`. See “Example 7” on page 1-278 (Symbolic Math Toolbox).

If `expr` is a list, vector, or matrix, use the syntax `assumeAlso(expr, set)`. Here, `set` must be specified as one of `C_`, `R_`, `Q_`, `Z_`, `N_`, or an expression constructed with the set operations, such as `union`, `intersect`, or `minus`. `set` also can be a function of the Type library, for example, `Type::Real`, `Type::Integer`, `Type::PosInt`, and so on.

Do not use the syntaxes `assumeAlso(expr in set)` and `assumeAlso(condition)` for nonscalar `expr`.

## Examples

### Example 1

Solve this equation without any assumptions on the variable `x`:

```
solve(x^5 - x, x)
```

```
{-1, 0, 1, -i, i}
```

Suppose, your computations deal with real numbers only. In this case, use the `assume` function to set the permanent assumption that `x` is real:

```
assume(x in R_)
```

If you solve the same equation now, you will get three real solutions:

```
solve(x^5 - x, x)
```

$$\{-1, 0, 1\}$$

If you also want to get only nonzero solutions, use `assumeAlso` to add the corresponding assumption:

```
assumeAlso(x <> 0);
solve(x^5 - x, x)
```

$$\{-1, 1\}$$

MuPAD keeps both assumptions for further computations:

```
getprop(x)
```

$$\mathbb{R} \setminus \{0\}$$

For further computations, delete the identifier `x`:

```
delete x
```

## Example 2

When you use `assumeAlso`, MuPAD does not remove existing assumptions. Instead, it combines them with new assumptions. For example, assume that `n` is an integer:

```
assume(n, Type::Integer);
getprop(n);
```

$$\mathbb{Z}$$

Add the assumption that `n` is positive:

```
assumeAlso(n, Type::Positive);
getprop(n);
```

$$\mathbb{Z} \cap [1, \infty)$$

For further computations, delete the identifier `n`:

```
delete n
```

Alternatively, set multiple assumptions in one function call using the Boolean operator `and`:

```
assume(n, Type::Integer and Type::Positive):  
getprop(n);
```

```
 $\mathbb{Z} \cap [1, \infty)$ 
```

For further computations, delete the identifier `n`:

```
delete n
```

### Example 3

You can set separate assumptions on the real and imaginary parts of an identifier:

```
assume(Re(z) > 0);  
assumeAlso(Im(z) < 0):
```

```
abs(Re(z));  
sign(Im(z))
```

```
 $\Re(z)$ 
```

```
-1
```

For further computations, delete the identifier `z`:

```
delete z
```

### Example 4

Using `assume`, set the assumption `x > y`. Assumptions set as relations affect the properties of both identifiers.

```
assume(x > y)
```

To see the assumptions set on identifiers, use `getprop`:

```
getprop(x);
getprop(y);
```

$$(y, \infty)$$

$$(-\infty, x)$$

To keep an existing assumption on  $y$  and add a new one, use `assumeAlso`. For example, add the new assumption that  $y$  is greater than  $\theta$  while keeping the assumption that  $y$  is less than  $x$ :

```
assumeAlso(y > \theta)
is(x^2 >= y^2)
```

TRUE

Relations, such as  $x > y$ , imply that the involved identifiers are real on page 33-111:

```
is(x, Type::Real), is(y, Type::Real)
```

TRUE, TRUE

```
delete x, y:
```

You also can add a relational assumption where one side is not an identifier, but an expression:

```
assumeAlso(x > 1/y)
getprop(x);
getprop(y)
```

$$\left(\frac{1}{y}, \infty\right)$$

$\mathbb{R}$

For further computations, delete the identifiers `x` and `y`:

```
delete x, y
```

## Example 5

`_assign` and `:=` do not check if an identifier has any assumptions. The assignment operation overwrites all assumptions:

```
assume(a > 0):  
a := -2:  
a, getprop(a)
```

```
-2, {-2}
```

For further computations, delete the identifier `a`:

```
delete a
```

## Example 7

Use `assume` to set the assumption that the identifier `a` is positive:

```
assume(a > 0)
```

Now, add two new assumptions using one call to `assumeAlso`. To combine the assumptions, use the Boolean operator `and`:

```
assumeAlso(a in Z_ and a < 5):  
is(a = 0);  
is(a = 1/2);  
is(a = 2);  
is(a = 6);
```

```
FALSE
```

```
FALSE
```

```
UNKNOWN
```



FALSE

## Parameters

### **expr**

Identifier on page 7-29, mathematical expression, list, vector, or matrix containing identifiers.

If `expr` is a list, vector, or matrix, then only the syntax `assumeAlso(expr, set)` is valid.

### **set**

Property representing a set of numbers or a set returned by `solve`. This set can be an element of `Dom::Interval`, `Dom::ImageSet`, `piecewise`, or one of `C_`, `R_`, `Q_`, `Z_`, `N_`. It also can be an expression constructed with the set operations, such as `union`, `intersect` or `minus`. For more examples, see “Properties” (Symbolic Math Toolbox).

### **condition**

Equality, inequality, element of relation, or Boolean combination (with the operators `and` or `or`).

## Return Values

Void object `null()` of type `DOM_NULL`.

## See Also

### **MuPAD Functions**

`assume` | `assuming` | `assumingAlso` | `getprop` | `is` | `property::hasprop` | `property::showprops` | `unassume`

**Topics**

“Use Permanent Assumptions” (Symbolic Math Toolbox)

# assuming\_assuming

Set temporary assumption

## Syntax

```
calculation assuming condition  
calculation assuming (expr, set)  
_assuming(calculation, condition)  
_assuming(calculation, (expr, set))
```

## Description

`calculation assuming condition` evaluates `calculation` under the assumption that `condition` is true for that calculation.

`calculation assuming(expr, set)` temporarily attaches the property `set` to the identifier or expression `expr` and evaluates `calculation`. This call ignores all previous assumptions containing identifiers used in `expr`.

`calculation assuming condition` is equivalent to `_assuming(calculation, condition)`.

`calculation assuming (expr, set)` is equivalent to `_assuming(calculation, (expr, set))`.

`assuming` sets temporary assumptions. Temporary assumptions hold true only while the argument `calculation` is evaluated. After this evaluation, MuPAD removes these assumptions. Therefore, they do not affect further computations. MuPAD also removes temporary assumptions if the evaluation stops with an error.

`assuming` temporarily overwrites existing assumptions. If you have permanent assumptions, MuPAD ignores them while evaluating `calculation`. Instead, it uses temporary assumptions set by `assuming`.

If assumptions contain linear equations with one variable, `assuming` solves these equations. Then the command inserts the solutions into `calculation` and evaluates the result. See “Example 6” on page 1-284 (Symbolic Math Toolbox).

If `expr` is a list, vector, or matrix, use the syntaxes `calculation assuming(expr, set)` and `_assuming(calculation, (expr, set))`. Here, `set` is specified as one of `C_`, `R_`, `Q_`, `Z_`, `N_`, or an expression constructed with the set operations, such as `union`, `intersect`, or `minus`. `set` also can be a function of the `Type` library, for example, `Type::Real`, `Type::Integer`, `Type::PosInt`, and so on.

Do not use the syntaxes `calculation assuming (expr in set)` (or its equivalent `_assuming(calculation, expr in set)`) and `calculation assuming condition` (or its equivalent `_assuming(calculation, condition)`) for nonscalar `expr`.

## Examples

### Example 1

Find the sign of the expression  $x^2 + 1$  assuming that the identifier `x` represents a real number:

```
sign(x^2+1) assuming (x, Type::Real)
```

1

### Example 2

Simplify this sine function assuming that `n` is an integer:

```
simplify(sin(n*PI)) assuming n in Z_
```

0

### Example 3

Additional assumptions let you simplify some expressions. For example, compute the right limit of  $x^p$ :

```
limit(x^p, x = 0, Right)
```

$$\left\{ \begin{array}{ll} 1 & \text{if } p = 0 \\ \infty & \text{if } p < 0 \\ 0 & \text{if } 0 < \Re(p) \\ \lim_{x \rightarrow 0^+} x^p & \text{if } \Re(p) < 0 \wedge \neg p \leq 0 \end{array} \right.$$

Compute the right limit of the same expression for negative, positive, and zero values of  $p$ :

```
limit(x^p, x = 0, Right) assuming p < 0
```

$\infty$

```
limit(x^p, x = 0, Right) assuming p > 0
```

0

```
limit(x^p, x = 0, Right) assuming p = 0
```

1

### Example 4

Assumptions set by `assuming` are temporary. They do not affect any previous or future computations:

```
getprop(a);
getprop(a) assuming a > 0;
getprop(a)
```

$\mathbb{C}$  $(0, \infty)$  $\mathbb{C}$ 

### Example 5

If you already use a permanent assumption and want to add a temporary assumption on the same object, do not use `assuming`. It temporarily overwrites the permanent assumption:

```
assume(x in Z_):  
solve(x^3 - (44*x^2)/3 + (148*x)/3 - 80/3 = 0, x) assuming x < 5
```

 $\left\{\frac{2}{3}, 4\right\}$ 

Instead, use `assumingAlso`:

```
solve(x^3 - (44*x^2)/3 + (148*x)/3 - 80/3 = 0, x) assumingAlso x < 5
```

 $\{4\}$ 

### Example 6

If assumptions contain linear equations with one variable, `assuming` solves the equations, inserts the solutions into the expression, and then evaluates the expression:

```
a^2 + 1 assuming a - 2 = 1;
```

 $10$ 

`assume` and `assumeAlso` do not solve equations:

```
assume(a - 2 = 1) ;  
a^2 + 1
```

$$a^2 + 1$$

## Parameters

### calculation

Any MuPAD command or expression that you want to evaluate under the temporary assumption.

### condition

Equality, inequality, element of relation, or Boolean combination (with the operators and or or).

### expr

Identifier on page 7-29, mathematical expression, list, vector, or matrix containing identifiers.

If `expr` is a list, vector, or matrix, then only the syntaxes `calculation assuming(expr, set)` and `_assuming(calculation, (expr, set))` are valid.

### set

Property representing a set of numbers or a set returned by `solve`.

For example, this set can be an element of `Dom::Interval`, `Dom::ImageSet`, `piecewise`, or one of `C_`, `R_`, `Q_`, `Z_`, `N_`. It also can be an expression constructed with the set operations, such as `union`, `intersect` or `minus`. For more examples, see "Properties" (Symbolic Math Toolbox).

## Return Values

`assuming` returns the result of evaluating `calculation`.

## See Also

### MuPAD Functions

`assume` | `assumeAlso` | `assumingAlso` | `getprop` | `is` | `property::hasprop` | `property::showprops` | `unassume`

### Topics

“Use Temporary Assumptions” (Symbolic Math Toolbox)



# assumingAlso\_assumingAlso

Add temporary assumption

## Syntax

```
calculation assumingAlso condition  
calculation assumingAlso (expr, set)  
_assumingAlso(calculation, condition)  
_assumingAlso(calculation, (expr, set))
```

## Description

`calculation assumingAlso condition` evaluates `calculation` under all existing assumptions along with the new assumption that `condition` is true for that calculation.

`calculation assumingAlso(expr, set)` temporarily attaches the property `set` to the identifier or expression `expr` and evaluates `calculation`. This call takes into account all previous assumptions containing identifiers used in `expr`.

`calculation assumingAlso condition` is equivalent to `_assumingAlso(calculation, condition)`.

`calculation assumingAlso (expr, set)` is equivalent to `_assumingAlso(calculation, (expr, set))`.

`assumingAlso` sets temporary assumptions in addition to existing permanent assumptions. Here, `condition` holds true only while the argument `calculation` is evaluated. After this evaluation, `condition` is removed. Therefore, it does not affect further computations. `condition` is also removed if the evaluation stops with an error.

If assumptions contain linear equations with one variable, `assumingAlso` solves these equations. Then the command inserts the solutions into `calculation` and evaluates the result. See “Example 3” on page 1-289 (Symbolic Math Toolbox).

If `expr` is a list, vector, or matrix, use the syntaxes `calculation assumingAlso(expr, set)` and `_assumingAlso(calculation, (expr, set))`. Here, `set` is specified as one of `C_`, `R_`, `Q_`, `Z_`, `N_`, or an expression constructed with the set operations, such as `union`, `intersect`, or `minus`. `set` also can be a function of the Type library, for example, `Type::Real`, `Type::Integer`, `Type::PosInt`, and so on.

Do not use the syntaxes `calculation assumingAlso (expr in set)` (or its equivalent `_assumingAlso(calculation, expr in set)`) and `calculation assumingAlso condition` (or its equivalent `_assumingAlso(calculation, condition)`) for nonscalar `expr`.

## Examples

### Example 1

Solve this equation without any assumptions on the variable `x`:

```
solve(x^5 - x, x)
```

```
{-1, 0, 1, -i, i}
```

Suppose your computations deal with real numbers only. In this case, use the `assume` function to set the permanent assumption that `x` is real:

```
assume(x in R_)
```

If you solve the same equation now, you will get three real solutions:

```
solve(x^5 - x, x)
```

```
{-1, 0, 1}
```

To get only nonzero solutions for this particular equation, use `assumingAlso` to temporarily add the corresponding assumption:

```
solve(x^5 - x, x) assumingAlso x <> 0
```

```
{-1, 1}
```

After solving this equation, MuPAD discards the temporary assumption, but keeps the permanent one:

```
getprop(x)
```

 $\mathbb{R}$ 

## Example 2

If you already use a permanent assumption and want to add a temporary assumption on the same object, do not use `assuming`. It temporarily overwrites the permanent assumption:

```
assume(x in Z_):
solve(x^3 - (44*x^2)/3 + (148*x)/3 - 80/3 = 0, x) assuming x < 5
```

 $\left\{\frac{2}{3}, 4\right\}$ 

Instead, use `assumingAlso`:

```
solve(x^3 - (44*x^2)/3 + (148*x)/3 - 80/3 = 0, x) assumingAlso x < 5
```

 $\{4\}$ 

## Example 3

If assumptions contain linear equations with one variable, `assumingAlso` solves the equations, inserts the solutions into the expression, and then evaluates the expression:

```
a^2 + 1 assumingAlso a - 2 = 1;
```

 $10$ 

`assume` and `assumeAlso` do not solve equations:

```
assumeAlso(a - 2 = 1) ;
a^2 + 1
```

$$a^2 + 1$$

## Parameters

### **calculation**

Any MuPAD command or expression that you want to evaluate under the temporary assumption.

### **condition**

Equality, inequality, element of relation, or Boolean combination (with the operators `and` or `or`).

### **expr**

Identifier on page 7-29, mathematical expression, list, vector, or matrix containing identifiers.

If `expr` is a list, vector, or matrix, then only the syntaxes `calculation assumingAlso(expr, set)` and `_assumingAlso(calculation, (expr, set))` are valid.

### **set**

Property representing a set of numbers or a set returned by `solve`. This set can be an element of `Dom::Interval`, `Dom::ImageSet`, `piecewise`, or one of `C_`, `R_`, `Q_`, `Z_`, `N_`. It also can be an expression constructed with the set operations, such as `union`, `intersect` or `minus`. For more examples, see “Properties” (Symbolic Math Toolbox).

## Return Values

`assumingAlso` returns the result of evaluating `calculation`.

## See Also

### MuPAD Functions

assume | assumeAlso | assuming | getprop | is | property::hasprop |  
property::showprops | unassume

### Topics

“Use Temporary Assumptions” (Symbolic Math Toolbox)

## asympt

Compute an asymptotic series expansion

### Syntax

```
asympt(f, x)
```

```
asympt(f, x, <order>, <dir>)
```

```
asympt(f, x = x0, <order>, <Left | Right>)
```

### Description

`asympt(f, x)` computes the first terms of an asymptotic series expansion of `f` with respect to the variable `x` around the point infinity.

`asympt` is used to compute an asymptotic expansion of `f` when `x` tends to `x0`. If such an expansion can be computed, a series object of domain type `Series::gseries` or `Series::Puisseux` is returned.

In contrast to the default behavior of `series`, `asympt` computes directed expansions that may be valid along the real line only.

`asympt` can compute more general types of asymptotic expansions than the related function `series`. Cf. "Example 5" on page 1-295 (Symbolic Math Toolbox).

If `x0` is a regular point of `f`, a pole, or an algebraic branch point, then `asympt` returns a `Puisseux` expansion. In this case it is recommended to use the faster function `series` instead.

If `asympt` cannot compute an asymptotic expansion, then a symbolic expression of type "asympt" is returned. Cf. "Example 4" on page 1-295 (Symbolic Math Toolbox).

The number of requested terms for the expansion is `order` if specified. Otherwise, the value of the environment variable `ORDER` is used. You can change the default value 6 by assigning a new value to `ORDER`.

The number of terms is counted from the lowest degree term on for finite expansion points, and from the highest degree term on for expansions around infinity, i.e., “order” has to be regarded as a “relative truncation order”.

---

**Note** The actual number of terms in the resulting series expansion may differ from the requested number of terms. See `series` for details.

---

The function `asympt` returns an object of domain type `Series::gseries` or `Series::Puiseux`. It can be manipulated via the standard arithmetic operations and various system functions. For example, `coeff` returns the coefficients; `expr` converts the series to an expression, removing the error term; `lmonomial` returns the leading monomial; `lterm` returns the leading term; `lcoeff` returns the leading coefficient; `map` applies a function to the coefficients; `nthcoeff` returns the  $n$ -th coefficient, `nthterm` the  $n$ -th term, and `nthmonomial` the  $n$ -th monomial.

## Environment Interactions

The function is sensitive to the environment variable `ORDER`, which determines the default number of terms in series computations.

## Examples

### Example 1

We compute an asymptotic expansion for  $x \rightarrow \infty$ :

```
s := asympt(sin(1/x + exp(-x)) - sin(1/x), x)
```

$$e^{-x} - \frac{e^{-x}}{2x^2} + \frac{e^{-x}}{24x^4} - \frac{e^{-x}}{720x^6} + \frac{e^{-x}}{40320x^8} - \frac{e^{-x}}{3628800x^{10}} + O\left(\frac{e^{-x}}{x^{11}}\right)$$

The leading term and the third term are extracted:

```
lmonomial(s), nthterm(s, 3)
```

$$e^{-x}, \frac{e^{-x}}{x^4}$$

In the following call, only 2 terms of the expansion are requested:

```
asympt(
  exp(sin(1/x + exp(-exp(x)))) - exp(sin(1/x)), x, 2
)
```

$$e^{-e^x} + \frac{e^{-e^x}}{x} + O\left(\frac{e^{-e^x}}{x^2}\right)$$

delete s:

## Example 2

We compute a expansion around a finite real point. By default, the expansion is valid “to the right” of the expansion point:

```
asympt(abs(x)/(1+x)), x = 0)
```

$$x - x^2 + x^3 - x^4 + x^5 - x^6 + O(x^7)$$

A different expansion is valid “to the left” of the expansion point:

```
asympt(abs(x)/(1 + x), x = 0, Left)
```

$$-x + x^2 - x^3 + x^4 - x^5 + x^6 + O(-x^7)$$

## Example 3

The following expansion is exact. Therefore, it has no “error term”:

```
asympt(exp(x), x = infinity)
```

$$e^x$$



## Example 4

Here is an example where `asympt` cannot compute an asymptotic series expansion:

```
asympt(cos(gamma(x*s))/s, x = infinity)
```

$$\text{asympt}\left(\frac{\cos(\Gamma(s x))}{s}, x = \infty\right)$$

## Example 5

If we apply the function `series` to the following expression, it essentially returns the expression itself:

```
series(sin(x)/x, x = 0)
```

$$1 - \frac{x^2}{6} + \frac{x^4}{120} + O(x^6)$$

In this example, `asympt` computes a more detailed series expansion:

```
asympt(sin(x)/x, x = 0)
```

$$1 - \frac{x^2}{6} + \frac{x^4}{120} - \frac{x^6}{5040} + \frac{x^8}{362880} - \frac{x^{10}}{39916800} + O(x^{11})$$

## Parameters

**f**

An arithmetical expression (Symbolic Math Toolbox) representing a function in  $x$

**x**

An identifier on page 7-29

$x_0$

The expansion point: an arithmetical expression; if not specified, the default expansion point `infinity` is used

**order**

The number of terms to be computed: a nonnegative integer; the default order is given by the environment variable `ORDER` (default value 6)

## Options

**Left, Right**

With `Left`, the expansion is valid for real  $x < x_0$ ; with `Right`, it is valid for  $x > x_0$ . For finite expansion points  $x_0$ , the default is `Right`.

## Return Values

Object of domain type `Series::gseries` or `Series::Puisseux`, or an expression of type "asympt".

## Overloaded By

f

## See Also

**MuPAD Functions**

0 | `ORDER` | `Series::Puisseux` | `Series::gseries` | `Type::Series` | `limit` | `mtaylor` | `series` | `taylor`

# bernoulli

Bernoulli numbers and polynomials

## Syntax

`bernoulli(n)`

`bernoulli(n, x)`

## Description

`bernoulli(n)` returns the  $n$ -th Bernoulli number.

`bernoulli(n, x)` returns the  $n$ -th Bernoulli polynomial in  $x$ .

The Bernoulli polynomials are defined by the generating function

$$\frac{t e^{x t}}{e^t - 1} = \sum_{n=0}^{\infty} \frac{\text{bernoulli}(n, x)}{n!} t^n$$

The Bernoulli numbers are defined by `bernoulli(n) = bernoulli(n, 0)`.

An error occurs if  $n$  is a numerical value not representing a nonnegative integer.

If  $n$  is an integer larger than the value returned by `Pref::autoExpansionLimit()`, then the call `bernoulli(n)` is returned symbolically. Use `expand(bernoulli(n))` to get an explicit numerical result for large integers  $n$ .

If  $n$  contains non-numerical symbolic identifiers, then the call `bernoulli(n)` is returned symbolically. In most cases, the same holds true for calls `bernoulli(n, x)`. Some simplifications are implemented for special numerical values such as  $x = 0$ ,  $x = 1/2$ ,  $x = 1$  etc. for symbolic  $n$ . Cf. "Example 3" on page 1-299 (Symbolic Math Toolbox).

---

**Note** Note that floating-point evaluation for high degree polynomials may be numerically unstable. Cf. "Example 4" on page 1-300 (Symbolic Math Toolbox).

---

The floating-point evaluation on the standard interval  $x \in [0, 1]$  is numerically stable for arbitrary  $n$ .

## Environment Interactions

When called with a floating-point value  $x$ , the function is sensitive to the environment variable DIGITS which determines the numerical working precision.

## Examples

### Example 1

The first Bernoulli numbers are:

```
bernoulli(n) $ n = 0..11
```

$$1, -\frac{1}{2}, \frac{1}{6}, 0, -\frac{1}{30}, 0, \frac{1}{42}, 0, -\frac{1}{30}, 0, \frac{5}{66}, 0$$

The first Bernoulli polynomials:

```
bernoulli(n, x) $ n = 0..4
```

$$1, x - \frac{1}{2}, x^2 - x + \frac{1}{6}, x^3 - \frac{3x^2}{2} + \frac{x}{2}, x^4 - 2x^3 + x^2 - \frac{1}{30}$$

If  $n$  is symbolic, then a symbolic call is returned:

```
bernoulli(n, x), bernoulli(n + 3/2, x), bernoulli(n + 5*I, x)
```

$$\text{bernoulli}(n, x), \text{bernoulli}\left(n + \frac{3}{2}, x\right), \text{bernoulli}(n + 5i, x)$$

## Example 2

If  $x$  is not an indeterminate, then the evaluation of the Bernoulli polynomial at the point  $x$  is returned:

`bernoulli(50, 1 + I)`

$$\frac{132549963452557267373179389125}{66} + 25 i$$

`bernoulli(3, 1 - y), expand(bernoulli(3, 1 - y))`

$$\frac{1}{2} - \frac{3(y-1)^2}{2} - (y-1)^3 - \frac{y}{2}, -y^3 + \frac{3y^2}{2} - \frac{y}{2}$$

## Example 3

Certain simplifications occur for some special numerical values of  $x$ , even if  $n$  is symbolic:

`bernoulli(n, 0), bernoulli(n, 1/2), bernoulli(n, 1)`

$$\text{bernoulli}(n), \text{bernoulli}(n) \left( 2^{1-n} - 1 \right), (-1)^n \text{bernoulli}(n)$$

Calls with numerical arguments between  $\frac{1}{2}$  and 1 are automatically rewritten in terms of calls with arguments between 0 and  $\frac{1}{2}$ :

`bernoulli(n, 2/3), bernoulli(n, 0.7)`

$$(-1)^n \text{bernoulli}\left(n, \frac{1}{3}\right), (-1)^n \text{bernoulli}(n, 0.3)$$

Calls with negative numerical arguments are automatically rewritten in terms of calls with positive arguments:

`bernoulli(n, -2)`

$$(-1)^n \text{bernoulli}(n, 2) + (-1)^n 2^{n-1} n$$

```
bernoulli(n, -12.345)
```

$$(-1)^n \text{bernoulli}(n, 12.345) + (-1)^n 12.345^{n-1} n$$

### Example 4

Float evaluation of high degree polynomials may be numerically unstable:

```
exact := bernoulli(50, 1 + I): float(exact);
```

$$2.00833278 \cdot 10^{27} + 25.0 \, i$$

```
bernoulli(50, float(1 + I))
```

$$2.00833278 \cdot 10^{27} - 10835184500.0 \, i$$

```
DIGITS := 40: bernoulli(50, float(1 + I))
```

$$\begin{aligned} &2.008332779584201020805748320075757575758 \cdot 10^{27} \\ &+ 24.999999999999999999999999999916700020247471852 \, i \end{aligned}$$

```
delete exact, DIGITS:
```

### Example 5

Some system functions such as `diff` or `expand` handle symbolic calls of `bernoulli`:

Some system functions such as `diff` or `expand` handle symbolic calls of `bernoulli`:

```
diff(bernoulli(n, f(x)), x)
```

$$n \text{bernoulli}(n - 1, f(x)) \frac{\partial}{\partial x} f(x)$$

`expand(bernoulli(n, x + 2))`

$$\text{bernoulli}(n, x) + \frac{n(x+1)^n}{x+1} + \frac{n x^n}{x}$$

`expand(bernoulli(n, -x))`

$$(-1)^n \text{bernoulli}(n, x) + \frac{n(-x)^n}{x}$$

`expand(bernoulli(n, 3*x))`

$$\frac{3^n \text{bernoulli}(n, x)}{3} + \frac{3^n \text{bernoulli}(n, x + \frac{1}{3})}{3} + \frac{3^n \text{bernoulli}(n, x + \frac{2}{3})}{3}$$

## Parameters

**n**

An arithmetical expression (Symbolic Math Toolbox) representing a nonnegative integer

**x**

An arithmetical expression (Symbolic Math Toolbox)

## Return Values

Arithmetical expression.

## References

M. Abramowitz and I. Stegun, "Handbook of Mathematical Functions", Dover Publications Inc., New York (1965).

## **See Also**

**MuPAD Functions**

euler



# bernstein

Bernstein polynomials

## Syntax

```
bernstein(f, n, t)
```

```
bernstein(g, <var>, n, t)
```

## Description

`bernstein(n, f, t)` with a univariate function `f` returns the  $n$ th-order Bernstein polynomial  $\sum(\text{binomial}(n,k)*t^k*(1-t)^{(n-k)}*f(k/n), k = 0..n)$  evaluated at the point `t`. This polynomial is an approximation of `f` over the interval  $[0, 1]$ . See “Example 1” on page 1-303 (Symbolic Math Toolbox).

`bernstein(g, <var>, n, t)` with a symbolic expression `g` returns the  $n$ th-order Bernstein polynomial approximation of `g`, evaluated at the point `t`. This syntax regards `g` as a univariate function of the variable `var`. You can omit specifying the variable `var` if the expression `g` is univariate. If it is multivariate, you must specify `var`. See “Example 2” on page 1-304 (Symbolic Math Toolbox) and “Example 3” on page 1-305 (Symbolic Math Toolbox).

The Bernstein representation of a polynomial is numerically stable when substituting numerical values between 0 and 1 for `t`. Nevertheless, if you simplify a Bernstein polynomial, the result can be unstable when substituting numerical values for `t`. See “Example 4” on page 1-306 (Symbolic Math Toolbox).

## Examples

### Example 1

Define the function representing a linear ramp as a MuPAD function:

```
f := t -> triangularPulse(1/4, 3/4, infinity, t):
```

Approximate  $f$  by the fifth-order Bernstein polynomials in the variable  $t$ :

```
b5 := bernstein(f, 5, t)
```

$$7t^3(t-1)^2 - 3t^2(t-1)^3 - 5t^4(t-1) + t^5$$

## Example 2

Approximate the sine function  $\sin(2\pi t)$  by the 10th- and 100th-degree Bernstein polynomials:

```
b10 := bernstein(sin(2*PI*t), 10, t):  
b100 := bernstein(sin(2*PI*t), 100, t):
```

Plot  $\sin(2\pi t)$  and its approximations:

```
p1 := plot::Function2d(sin(2*PI*t), t = 0..1,  
    LegendText = "sine function",  
    Color = RGB::Red):  
p2 := plot::Function2d(b10, t = 0..1,  
    LegendText = "10th degree polynomial",  
    Color = RGB::Green):  
p3 := plot::Function2d(b100, t = 0..1,  
    LegendText = "100th degree polynomial",  
    Color = RGB::Blue):  
plot(p1, p2, p3, LegendVisible = TRUE)
```

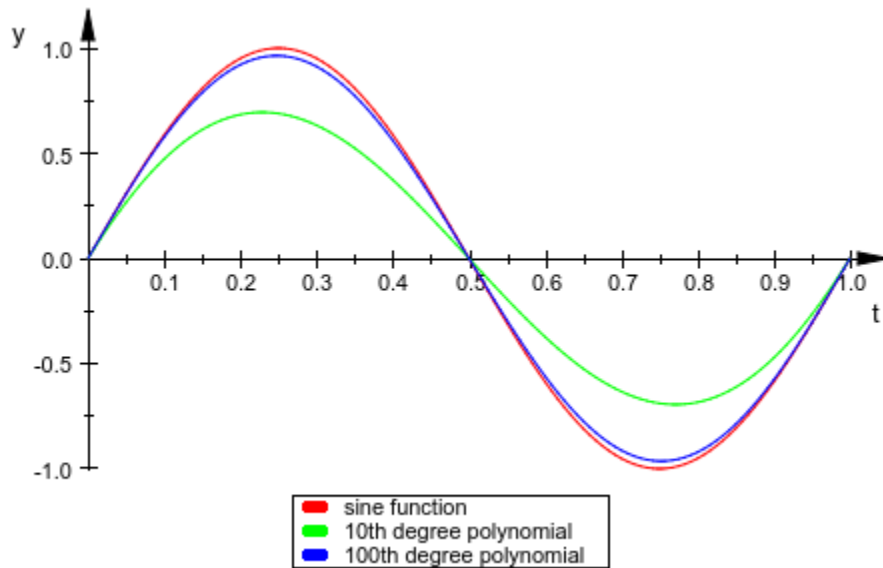

### Example 3

Approximate the exponential function by the second-order Bernstein polynomial in the variable  $t$ :

```
bernstein(exp(x), 2, t)
```

$$(t-1)^2 + t^2 e - 2 t \sqrt{e} (t-1)$$

Approximate the multivariate exponential function  $y \cdot \exp(x \cdot y)$ . You must specify the variable because this expression contains more than one variable. `bernstein` regards the expression as a univariate function of that variable. For example, to treat this expression as a univariate function of  $x$ , enter:

```
bernstein(y*exp(x*y), x, 2, t)
```

$$y(t-1)^2 + t^2 y e^y - 2 t y e^{\frac{y}{2}} (t-1)$$

To treat this expression as a univariate function of  $y$ , enter:

```
bernstein(y*exp(x*y), y, 2, t)
```

$$t^2 e^x - t e^{\frac{x}{2}} (t-1)$$

## Example 4

When you simplify a high-order symbolic Bernstein polynomial, the result often cannot be evaluated in a numerically stable way.

Approximate this rectangular pulse function by the 100th-degree Bernstein polynomial, and then simplify the result:

```
f := rectangularPulse(1/4,3/4,t):  
f1 := bernstein(f, 100, t):  
f2 := simplify(f1):
```

Compare the plot of the original rectangular pulse function  $f$ , its numerically stable Bernstein representation  $f1$ , and its simplified version  $f2$ . The simplified version shows a region of numerical instability.

```
plot(f, f1, f2, t = 0..1)
```

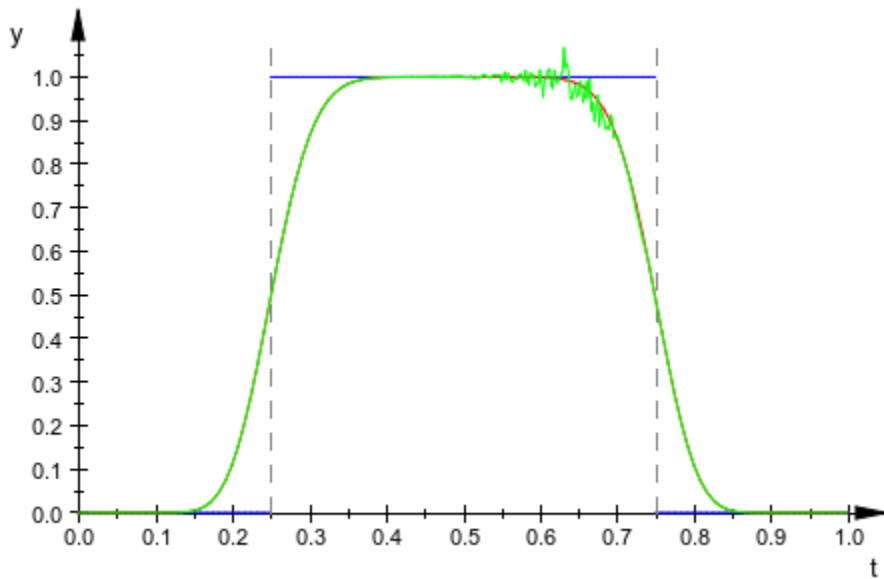

## Parameters

**n**

Nonnegative integer.

**f**

Function accepting one input parameter and returning an arithmetical expression.

**g**

Arithmetical expression.

**t**

Arithmetical expression.

**var**

Indeterminate, specified as an identifier or indexed identifier.

## Return Values

Arithmetical expression.

## Algorithms

A Bernstein polynomial of degree  $n$  is defined as follows:

$$B(t) = \sum_{k=0}^n \beta_k b_{k,n}(t)$$

Here

$$b_{k,n}(t) = \binom{n}{k} t^k (1-t)^{n-k}$$

$$k = 0, \dots, n$$

are the Bernstein basis polynomials, and

$$\binom{n}{k}$$

is a binomial coefficient.

The coefficients

$$\beta_k$$

are called Bernstein coefficients or Bezier coefficients.

If  $f$  is a continuous function on the interval  $[0, 1]$  and

$$B_n(f)(t) = \sum_{k=0}^n f\left(\frac{k}{n}\right) b_{k,n}(t)$$

is the approximating Bernstein polynomial, then

$$\lim_{n \rightarrow \infty} B_n(f)(t) = f(t)$$

uniformly in  $t$  on the interval  $[0, 1]$ .

## See Also

### MuPAD Functions

`bernsteinMatrix` | `binomial` | `fact` | `sum`

# bernsteinMatrix

Bernstein matrix

## Syntax

`bernsteinMatrix(n, t)`

## Description

`bernsteinMatrix(n, t)`, where `t` is a vector of length `m`, returns the `m`-by- $(n+1)$  Bernstein matrix `M`, such that  $M(i, k+1) = \text{binomial}(n, k) * t[i]^k * (1-t[i])^{(n-k)}$ . Here, the index `i` runs from 1 to `m`, and the index `k` runs from 0 to `n`. See “Example 2” on page 1-304 (Symbolic Math Toolbox) and “Example 3” on page 1-305 (Symbolic Math Toolbox).

The Bernstein matrix is also called the Bezier matrix.

Use Bernstein matrices to construct Bezier curves:

```
bezierCurve = bernsteinMatrix(n, t)*P
```

Here, the rows of matrix `P` specify the control points of the Bezier curve. For example, to construct the second-order 3-D Bezier curve, specify the control points as:

```
P = [p0x, p0y, p0z; p1x, p1y, p1z; p2x, p2y, p2z]
```

## Examples

### Example 1

Plot the fourth-order 2-D Bezier curve specified by the control points  $p_0 = [0, 1]$ ,  $p_1 = [4, 3]$ ,  $p_2 = [6, 2]$ ,  $p_3 = [3, 0]$ ,  $p_4 = [2, 4]$ . Create a matrix with each row representing a control point:

```
P := matrix([[0, 1], [4, 3], [6, 2], [3, 0], [2, 4]]):
```



Construct the fourth-order Bernstein matrix B:

```
B := bernsteinMatrix(4, t)
```

$$\begin{pmatrix} (t-1)^4 & -4t(t-1)^3 & 6t^2(t-1)^2 & -4t^3(t-1) & t^4 \end{pmatrix}$$

Construct the Bezier curve:

```
bezierCurve := simplify(B*P)
```

$$\begin{pmatrix} -2t(-5t^3+6t^2+6t-8) & 5t^4+8t^3-18t^2+8t+1 \end{pmatrix}$$

Plot the curve and control points:

```
plot(plot::PointList2d(P),
      plot::Curve2d(bezierCurve, t = 0..a, a = 0..1))
```

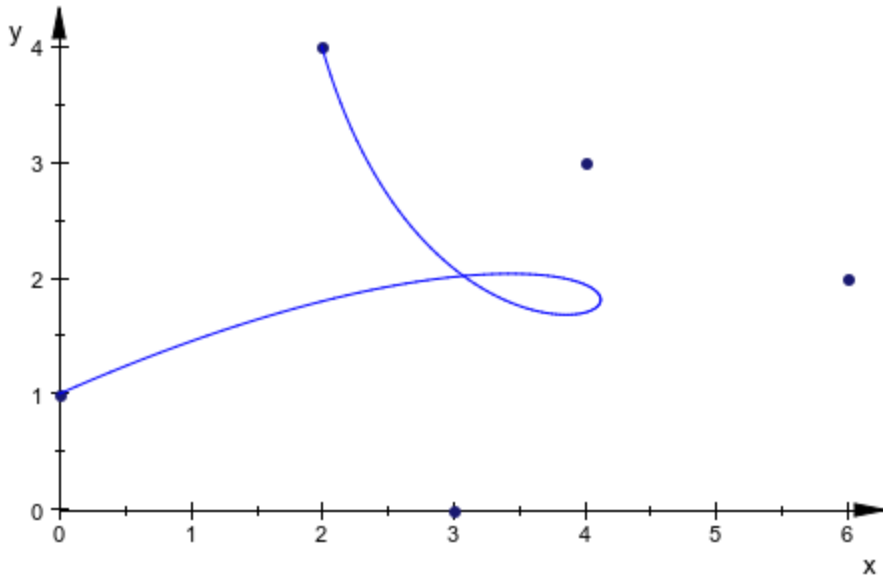

## Example 2

Construct the third-order 3-D Bezier curve specified by the 3-by-3 matrix P of control points. Each control point corresponds to a row of matrix P.

```
P := matrix([[0, 0, 0], [2, 2, 2], [2, -1, 1], [6, 1, 3]]):
```

Construct the Bernstein matrix:

```
B := bernsteinMatrix(3, t)
```

$$\begin{pmatrix} -(t-1)^3 & 3t(t-1)^2 & -3t^2(t-1) & t^3 \end{pmatrix}$$

Construct the Bezier curve:

```
bezierCurve := simplify(B*P)
```

$$\begin{pmatrix} 6t(t^2-t+1) & t(10t^2-15t+6) & 3t(2t^2-3t+2) \end{pmatrix}$$

Plot the control points and Bezier curve:

```
plot(plot::PointList3d(P),  
      plot::Curve3d(bezierCurve, t = 0..a, a = 0..1))
```

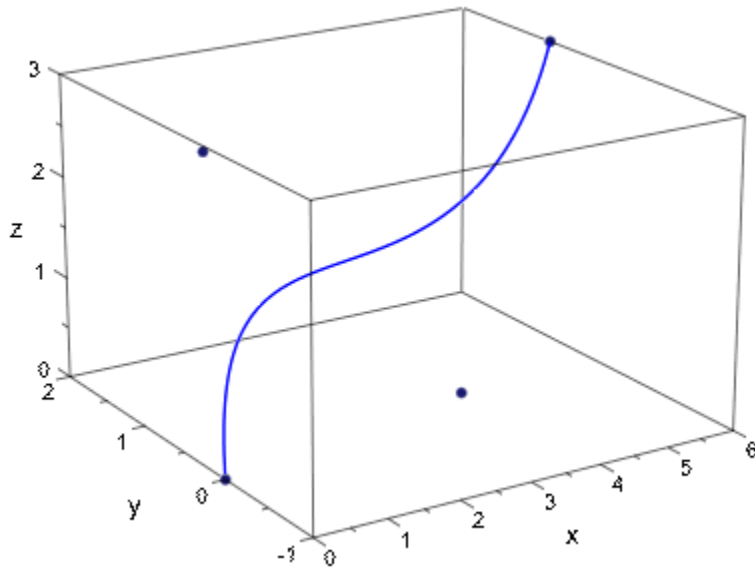

## Parameters

**n**

Nonnegative integer.

**t**

Arithmetical expression, a list of expressions, or a vector of expressions. In MuPAD, a  $1 \times m$  or an  $m \times 1$  matrix represents a row or column vector, respectively.

## Return Values

$\text{nops}(t) \times (n+1)$  matrix of the domain type (Symbolic Math Toolbox) `Dom::Matrix()`.

## Algorithms

A Bernstein polynomial of degree  $n$  is defined as follows:

$$B(t) = \sum_{k=0}^n \beta_k b_{k,n}(t)$$

Here,

$$b_{k,n}(t) = \binom{n}{k} t^k (1-t)^{n-k}$$

$$k = 0, \dots, n$$

are the Bernstein basis polynomials, and

$$\binom{n}{k}$$

is a binomial coefficient.

The coefficients

$$\beta_k$$

are called Bernstein coefficients or Bezier coefficients.

The Bernstein polynomial is given by the matrix multiplication of the Bernstein matrix and the vector of coefficients:

$$B(t) = b_{0n}(t) \ b_{1n}(t) \ \dots \ b_{nn}(t) \begin{pmatrix} \beta_0 \\ \beta_1 \\ \vdots \\ \beta_n \end{pmatrix}$$

## See Also

### MuPAD Functions

bernstein | binomial | fact | sum

# besselI

Modified Bessel functions of the first kind

## Syntax

besselI( $\nu$ ,  $z$ )

## Description

besselI( $\nu$ ,  $z$ ) represents the modified Bessel functions of the first kind:

$$I_{\nu}(z) = \frac{\left(\frac{z}{2}\right)^{\nu}}{\sqrt{\pi} \Gamma\left(\nu + \frac{1}{2}\right)} \int_0^{\pi} e^{z \cos(t)} \sin(t)^{2\nu} dt$$

The Bessel functions are defined for complex arguments  $\nu$  and  $z$ .

A floating-point value is returned if either of the arguments is a floating-point number and the other argument is numerical. For most exact arguments the Bessel functions return an unevaluated function call. Special values at index  $\nu = 0$  and/or argument  $z = 0$  are implemented. Explicit symbolic expressions are returned, when the index  $\nu$  is a half integer. See “Example 2” on page 1-316 (Symbolic Math Toolbox).

For nonnegative integer indices  $\nu$  some of the Bessel functions have a branch cut along the negative real axis. A jump occurs when crossing this cut. See “Example 3” on page 1-317 (Symbolic Math Toolbox).

## Environment Interactions

When called with floating-point arguments, these functions are sensitive to the environment variable DIGITS which determines the numerical working precision.

## Examples

### Example 1

Unevaluated calls are returned for exact or symbolic arguments:

`besselI(2, 1 + I)`, `besselI(0, x)`, `besselI(v, x)`

$$I_2(1 + i), I_0(x), I_\nu(x)$$

Floating point values are returned for floating-point arguments:

`besselI(2, 5.0)`, `besselI(3.2 + I, 10000.0)`

$$17.50561497, 3.511832963 \cdot 10^{4340} - 1.123842765 \cdot 10^{4337} i$$

### Example 2

Bessel functions can be expressed in terms of elementary functions if the index is an odd integer multiple of  $\frac{1}{2}$ :

`besselI(1/2, x)`, `besselI(3/2, x)`

$$\frac{\sqrt{2} \sinh(x)}{\sqrt{x} \sqrt{\pi}}, \frac{\sqrt{2} \left( \cosh(x) - \frac{\sinh(x)}{x} \right)}{\sqrt{x} \sqrt{\pi}}$$

`besselI(7/2, x)`, `besselI(-7/2, x)`

$$-\frac{\sqrt{2} \left( \sinh(x) \left( \frac{6}{x} + \frac{15}{x^3} \right) - \cosh(x) \left( \frac{15}{x^2} + 1 \right) \right)}{\sqrt{x} \sqrt{\pi}},$$
$$-\frac{\sqrt{2} \left( \cosh(x) \left( \frac{6}{x} + \frac{15}{x^3} \right) - \sinh(x) \left( \frac{15}{x^2} + 1 \right) \right)}{\sqrt{x} \sqrt{\pi}}$$

### Example 3

The negative real axis is a branch cut of the Bessel functions for non-integer indices  $\nu$ . A jump occurs when crossing this cut:

```
besseli(-3/4, -1.2),
besseli(-3/4, -1.2 + I/10^10),
besseli(-3/4, -1.2 - I/10^10)
```

```
-0.76061492 - 0.76061492 i, -0.76061492 - 0.7606149199 i,
-0.76061492 + 0.7606149199 i
```

### Example 4

The functions `diff`, `float`, `limit`, and `series` handle expressions involving the Bessel functions:

```
diff(besseli(0, x), x, x), float(ln(3 + besseli(17, sqrt(PI))))
```

```
 $I_0(x) - \frac{I_1(x)}{x}$ , 1.098612289
```

```
limit(1/besseli(2, x^2 + 1)*sqrt(x), x = infinity)
```

```
0
```

```
series(besseli(3, x)/x, x = infinity, 3)
```

```
 $\frac{\sqrt{2} e^x}{2 x^{3/2} \sqrt{\pi}} - \frac{35 \sqrt{2} e^x}{16 x^{5/2} \sqrt{\pi}} + \frac{945 \sqrt{2} e^x}{256 x^{7/2} \sqrt{\pi}} + O\left(\frac{e^x}{x^{9/2}}\right)$ 
```

## Parameters

**$\nu$ ,  $z$**

arithmetical expressions (Symbolic Math Toolbox)

## Return Values

Arithmetical expression.

## Overloaded By

$z$

## Algorithms

The modified Bessel functions  $I_\nu(z)$  and  $K_\nu(z)$  satisfy the modified Bessel equation:

$$z^2 \frac{\partial^2}{\partial z^2} w + z \frac{\partial}{\partial z} w - (z^2 + \nu^2) w = 0$$

When the index  $\nu$  is an integer, the modified Bessel functions of the first kind are governed by reflection formulas:

$$I_{-\nu}(z) = I_\nu(z)$$

## See Also

### MuPAD Functions

besselJ | besselK | besselY



# besselJ

Bessel functions of the first kind

## Syntax

`besselJ(v, z)`

## Description

`besselJ(v, z)` represents the Bessel functions of the first kind:

$$J_\nu(z) = \frac{\left(\frac{z}{2}\right)^\nu}{\sqrt{\pi} \Gamma\left(\nu + \frac{1}{2}\right)} \int_0^\pi \cos(z \cos(t)) \sin(t)^{2\nu} dt$$

The Bessel functions are defined for complex arguments  $\nu$  and  $z$ .

A floating-point value is returned if either of the arguments is a floating-point number and the other argument is numerical. For most exact arguments the Bessel functions return an unevaluated function call. Special values at index  $\nu = 0$  and/or argument  $z = 0$  are implemented. Explicit symbolic expressions are returned, when the index  $\nu$  is a half integer. See “Example 2” on page 1-320 (Symbolic Math Toolbox).

For nonnegative integer indices  $\nu$  some of the Bessel functions have a branch cut along the negative real axis. A jump occurs when crossing this cut. See “Example 3” on page 1-321 (Symbolic Math Toolbox).

If floating-point approximations are desired for arguments that are exact numerical expressions, then we recommend to use `besselJ(v, float(x))` rather than `float(besselJ(v, x))`. In particular, for half integer indices the symbolic result `besselJ(v, x)` is costly to compute. Further, floating-point evaluation of the resulting symbolic expression may be numerically unstable. See “Example 4” on page 1-321 (Symbolic Math Toolbox).

## Environment Interactions

When called with floating-point arguments, these functions are sensitive to the environment variable DIGITS which determines the numerical working precision.

## Examples

### Example 1

Unevaluated calls are returned for exact or symbolic arguments:

`besselJ(2, 1 + I), besselJ(0, x), besselJ(v, x)`

$$J_2(1 + i), J_0(x), J_v(x)$$

Floating point values are returned for floating-point arguments:

`besselJ(2, 5.0), besselJ(3.2 + I, 10000.0)`

$$0.04656511628, -0.01419654275 - 0.01293852174 i$$

### Example 2

Bessel functions can be expressed in terms of elementary functions if the index is an odd integer multiple of  $\frac{1}{2}$ :

`besselJ(1/2, x), besselJ(3/2, x)`

$$\frac{\sqrt{2} \sin(x)}{\sqrt{x} \sqrt{\pi}}, -\frac{\sqrt{2} \left( \cos(x) - \frac{\sin(x)}{x} \right)}{\sqrt{x} \sqrt{\pi}}$$

`besselJ(5/2, x), besselJ(-5/2, x)`

$$-\frac{\sqrt{2} \left( \frac{3 \cos(x)}{x} - \sin(x) \left( \frac{3}{x^2} - 1 \right) \right)}{\sqrt{x} \sqrt{\pi}}, \frac{\sqrt{2} \left( \frac{3 \sin(x)}{x} + \cos(x) \left( \frac{3}{x^2} - 1 \right) \right)}{\sqrt{x} \sqrt{\pi}}$$

### Example 3

The negative real axis is a branch cut of the Bessel functions for non-integer indices  $\nu$ . A jump occurs when crossing this cut:

```
besselJ(-3/4, -1.2),
besselJ(-3/4, -1.2 + I/10^10),
besselJ(-3/4, -1.2 - I/10^10)
```

```
0.06963180097 + 0.06963180097 i, 0.06963180102 + 0.06963180093 i,
0.06963180102 - 0.06963180093 i
```

### Example 4

The symbolic expressions returned by Bessel functions with half integer indices can be unsuitable for floating-point evaluation:

```
y := besselJ(51/2, PI)
```

$$\frac{\sqrt{2} \left( \frac{450675225}{\pi^4} - \frac{52650}{\pi^2} - \frac{1466947857375}{\pi^6} + \dots + 1 \right)}{\pi}$$

Floating point evaluation of this exact result is subject to numerical cancellation. The following result is dominated by round-off:

```
float(y)
```

```
- 57.62024423
```

The numerical working precision has to be increased to obtain a more accurate result:

```
DIGITS:= 39: float(y)
```

1.16012957421211164937710323507482182361 10<sup>-21</sup>

Direct floating-point evaluation via the Bessel function yields a correct result within working precision:

```
DIGITS := 5: besselJ(51/2, float(PI))
```

1.1601 10<sup>-21</sup>

```
delete y, DIGITS:
```

### Example 5

The functions `diff`, `float`, `limit`, and `series` handle expressions involving the Bessel functions:

```
diff(besselJ(0, x), x, x), float(ln(3 + besselJ(17, sqrt(PI))))
```

$$\frac{J_1(x)}{x} - J_0(x), 1.098612289$$

```
limit(besselJ(2, x^2 + 1)*sqrt(x), x = infinity)
```

0

```
series(besselJ(1, x), x = infinity, 3)
```

$$\frac{\sqrt{2} \cos\left(x - \frac{3\pi}{4}\right)}{\sqrt{x} \sqrt{\pi}} - \frac{3 \sqrt{2} \sin\left(x - \frac{3\pi}{4}\right)}{8 x^{3/2} \sqrt{\pi}} + \frac{15 \sqrt{2} \cos\left(x - \frac{3\pi}{4}\right)}{128 x^{5/2} \sqrt{\pi}} + O\left(\frac{1}{x^{7/2}}\right)$$

## Parameters

$v, z$

arithmetical expressions (Symbolic Math Toolbox)

## Return Values

Arithmetical expression.

## Overloaded By

$z$

## Algorithms

The Bessel functions are regular (holomorphic) functions of  $z$  throughout the  $z$ -plane cut along the negative real axis, and for fixed  $z \neq 0$ , each is an entire (integral) function of  $v$ .

$J_\nu(z)$  and  $Y_\nu(z)$  satisfy Bessel's equation in  $w(v, z)$ :

$$z^2 \frac{\partial^2}{\partial z^2} w + z \frac{\partial}{\partial z} w + (z^2 - \nu^2) w = 0$$

When the index  $\nu$  is an integer, the Bessel functions of the first kind are governed by reflection formulas:

$$J_{-\nu}(z) = (-1)^\nu J_\nu(z)$$

## See Also

### **MuPAD Functions**

besselI | besselK | besselY

# besselK

Modified Bessel functions of the second kind

## Syntax

`besselK(v, z)`

## Description

`besselK(v, z)` represents the modified Bessel functions of the second kind:

$$K_\nu(z) = \frac{\frac{\pi}{2} \left( I_{-\nu}(z) - I_\nu(z) \right)}{\sin(\nu \pi)}$$

Here  $I_\nu(z)$  are the modified Bessel functions of the first kind:

$$I_\nu(z) = \frac{\left(\frac{z}{2}\right)^\nu}{\sqrt{\pi} \Gamma\left(\nu + \frac{1}{2}\right)} \int_0^\pi e^{z \cos(t)} \sin(t)^{2\nu} dt$$

The Bessel functions are defined for complex arguments  $\nu$  and  $z$ .

A floating-point value is returned if either of the arguments is a floating-point number and the other argument is numerical. For most exact arguments the Bessel functions return an unevaluated function call. Special values at index  $\nu = 0$  and/or argument  $z = 0$  are implemented. Explicit symbolic expressions are returned, when the index  $\nu$  is a half integer. See “Example 2” on page 1-326 (Symbolic Math Toolbox).

For nonnegative integer indices  $\nu$  some of the Bessel functions have a branch cut along the negative real axis. A jump occurs when crossing this cut. See “Example 3” on page 1-327 (Symbolic Math Toolbox).

## Environment Interactions

When called with floating-point arguments, these functions are sensitive to the environment variable DIGITS which determines the numerical working precision.

## Examples

### Example 1

Unevaluated calls are returned for exact or symbolic arguments:

`besselK(2, 1 + I), besselK(0, x), besselK(v, x)`

$$K_2(1 + i), K_0(x), K_v(x)$$

Floating point values are returned for floating-point arguments:

`besselK(2, 5.0), besselK(3.2 + I, 10000.0)`

$$0.005308943712, 1.423757712 \cdot 10^{-4345} + 4.555796986 \cdot 10^{-4349} i$$

### Example 2

Bessel functions can be expressed in terms of elementary functions if the index is an odd integer multiple of  $\frac{1}{2}$ :

`besselK(1/2, x), besselK(3/2, x)`

$$\frac{\sqrt{2} \sqrt{\pi} e^{-x}}{2 \sqrt{x}}, \frac{\sqrt{2} \sqrt{\pi} e^{-x} (\frac{1}{x} + 1)}{2 \sqrt{x}}$$

`besselK(7/2, x), besselK(-7/2, x)`



$$\frac{\sqrt{2} \sqrt{\pi} e^{-x} \left( \frac{6}{x} + \frac{15}{x^2} + \frac{15}{x^3} + 1 \right)}{2 \sqrt{x}}, \frac{\sqrt{2} \sqrt{\pi} e^{-x} \left( \frac{6}{x} + \frac{15}{x^2} + \frac{15}{x^3} + 1 \right)}{2 \sqrt{x}}$$

### Example 3

The negative real axis is a branch cut of the Bessel functions for non-integer indices  $\nu$ . A jump occurs when crossing this cut:

```
besselK(-3/4, -1.2),
besselK(-3/4, -1.2 + I/10^10),
besselK(-3/4, -1.2 - I/10^10)
```

```
-0.2686021911 - 3.110720859 i, -0.2686021914 - 3.110720859 i,
-0.2686021914 + 3.110720859 i
```

### Example 4

The functions `diff`, `float`, `limit`, and `series` handle expressions involving the Bessel functions:

```
diff(besselK(0, x), x, x), float(ln(3 + besselK(17, sqrt(PI))))
```

$$\frac{K_1(x)}{x} + K_0(x), 31.98300353$$

```
limit(besselK(2, x^2 + 1)*sqrt(x), x = infinity)
```

```
0
```

```
series(besselK(3, x), x = infinity, 3)
```

$$\frac{\sqrt{2} \sqrt{\pi} e^{-x}}{2 \sqrt{x}} + \frac{35 \sqrt{2} \sqrt{\pi} e^{-x}}{16 x^{3/2}} + \frac{945 \sqrt{2} \sqrt{\pi} e^{-x}}{256 x^{5/2}} + O\left(\frac{e^{-x}}{x^{7/2}}\right)$$

## Parameters

$v, z$

arithmetical expressions (Symbolic Math Toolbox)

## Return Values

Arithmetical expression.

## Overloaded By

$z$

## Algorithms

The modified Bessel functions  $I_\nu(z)$  and  $K_\nu(z)$  satisfy the modified Bessel equation:

$$z^2 \frac{\partial^2}{\partial z^2} w + z \frac{\partial}{\partial z} w - (z^2 + \nu^2) w = 0$$

When the index  $\nu$  is an integer, the modified Bessel functions of the second kind are governed by reflection formula:

$$K_{-\nu}(z) = K_\nu(z)$$

## See Also

### MuPAD Functions

besselI | besselJ | besselY

# bessely

Bessel functions of the second kind

## Syntax

`bessely(v, z)`

## Description

`besselj(v, z)` represent the Bessel functions of the second kind:

$$Y_\nu(z) = \frac{J_\nu(z) \cos(\nu \pi) - J_{-\nu}(z)}{\sin(\nu \pi)}$$

Here  $J_\nu(z)$  are the Bessel functions of the first kind:

$$J_\nu(z) = \frac{\left(\frac{z}{2}\right)^\nu}{\sqrt{\pi} \Gamma\left(\nu + \frac{1}{2}\right)} \int_0^\pi \cos(z \cos(t)) \sin(t)^{2\nu} dt$$

The Bessel functions are defined for complex arguments  $\nu$  and  $z$ .

A floating-point value is returned if either of the arguments is a floating-point number and the other argument is numerical. For most exact arguments the Bessel functions return an unevaluated function call. Special values at index  $\nu = 0$  and/or argument  $z = 0$  are implemented. Explicit symbolic expressions are returned, when the index  $\nu$  is a half integer. See “Example 2” on page 1-330 (Symbolic Math Toolbox).

For nonnegative integer indices  $\nu$  some of the Bessel functions have a branch cut along the negative real axis. A jump occurs when crossing this cut. See “Example 3” on page 1-331 (Symbolic Math Toolbox).

## Environment Interactions

When called with floating-point arguments, these functions are sensitive to the environment variable DIGITS which determines the numerical working precision.

## Examples

### Example 1

Unevaluated calls are returned for exact or symbolic arguments:

`besselY(2, 1 + I), besselY(0, x), besselY(v, x)`

$$Y_2(1 + i), Y_0(x), Y_v(x)$$

Floating point values are returned for floating-point arguments:

`besselY(2, 5.0), besselY(3.2 + I, 10000.0)`

$$0.3676628826, -0.01410805868 + 0.01301967054 i$$

### Example 2

Bessel functions can be expressed in terms of elementary functions if the index is an odd integer multiple of  $\frac{1}{2}$ :

`besselY(1/2, x), besselY(3/2, x)`

$$-\frac{\sqrt{2} \cos(x)}{\sqrt{x} \sqrt{\pi}}, -\frac{\sqrt{2} \left( \sin(x) + \frac{\cos(x)}{x} \right)}{\sqrt{x} \sqrt{\pi}}$$

`besselY(5/2, x), besselY(-5/2, x)`

$$-\frac{\sqrt{2} \left( \frac{3 \sin(x)}{x} + \cos(x) \left( \frac{3}{x^2} - 1 \right) \right)}{\sqrt{x} \sqrt{\pi}}, -\frac{\sqrt{2} \left( \frac{3 \cos(x)}{x} - \sin(x) \left( \frac{3}{x^2} - 1 \right) \right)}{\sqrt{x} \sqrt{\pi}}$$

### Example 3

The negative real axis is a branch cut of the Bessel functions for non-integer indices  $\nu$ . A jump occurs when crossing this cut:

```
bessely(-3/4, -1.2),
bessely(-3/4, -1.2 + I/10^10),
bessely(-3/4, -1.2 - I/10^10)
```

```
-0.5292185449 + 0.6684821469 i, -0.5292185449 + 0.6684821469 i,
-0.5292185449 - 0.6684821469 i
```

### Example 4

The functions `diff`, `float`, `limit`, and `series` handle expressions involving the Bessel functions:

```
diff(bessely(0, x), x, x), float(ln(3 + bessely(17, sqrt(PI))))
```

$$\frac{Y_1(x)}{x} - Y_0(x), 31.62959634 + 3.141592654 i$$

```
limit(bessely(2, x^2 + 1)*sqrt(x), x = infinity)
```

```
0
```

```
series(bessely(3, x), x = infinity, 3)
```

$$\frac{\sqrt{2} \sin\left(x - \frac{7\pi}{4}\right)}{\sqrt{x} \sqrt{\pi}} + \frac{35 \sqrt{2} \cos\left(x - \frac{7\pi}{4}\right)}{8 x^{3/2} \sqrt{\pi}} - \frac{945 \sqrt{2} \sin\left(x - \frac{7\pi}{4}\right)}{128 x^{5/2} \sqrt{\pi}} + O\left(\frac{1}{x^{7/2}}\right)$$

## Parameters

$v, z$

arithmetical expressions (Symbolic Math Toolbox)

## Return Values

Arithmetical expression.

## Overloaded By

$z$

## Algorithms

The Bessel functions are regular (holomorphic) functions of  $z$  throughout the  $z$ -plane cut along the negative real axis, and for fixed  $z \neq 0$ , each is an entire (integral) function of  $v$ .

$J_\nu(z)$  and  $Y_\nu(z)$  satisfy Bessel's equation in  $w(v, z)$ :

$$z^2 \frac{\partial^2}{\partial z^2} w + z \frac{\partial}{\partial z} w + (z^2 - \nu^2) w = 0$$

When the index  $\nu$  is an integer, the Bessel functions of the second kind are governed by reflection formulas:

$$Y_{-\nu}(z) = (-1)^\nu Y_\nu(z)$$

## See Also

### MuPAD Functions

besselI | besselJ | besselK

## beta

Beta function

## Syntax

`beta(x, y)`

## Description

`beta(x, y)` represents the beta function  $\frac{\Gamma(x)\Gamma(y)}{\Gamma(x+y)}$ .

The beta function is defined for complex arguments  $x$  and  $y$ .

The result is expressed by calls to the gamma function if both arguments are of type `Type::Numeric`. Note that the beta function may have a regular value, even if  $\Gamma(x)$  or  $\Gamma(y)$  and  $\Gamma(x + y)$  are singular. In such cases `beta` returns the limit of the quotients of the singular terms.

A floating-point value is returned if both arguments are numerical and at least one of them is a floating-point value.

An unevaluated call of `beta` is returned, if none of the arguments vanishes and at least one of the arguments does not evaluate to a number of type `Type::Numeric`.

## Environment Interactions

When called with floating-point arguments, the function is sensitive to the environment variable `DIGITS` which determines the numerical working precision.



## Examples

### Example 1

We demonstrate some calls with exact and symbolic input data:

```
beta(1, 5), beta(I, 3/2), beta(1, y + 1), beta(x, y)
```

$$\frac{1}{5}, \frac{\sqrt{\pi} \Gamma(i)}{2 \Gamma(\frac{3}{2} + i)}, \frac{1}{y+1}, \beta(x, y)$$

Floating point values are computed for floating-point arguments:

```
beta(3.5, sqrt(2)), beta(sqrt(2), 2.0 + 10.0*I)
```

$$0.1395855454, -0.01112350756 - 0.03108193098 i$$

### Example 2

The gamma function is singular if its argument is a nonpositive integer. Nevertheless, beta has a regular value for the following arguments:

```
beta(-3, 2)
```

$$\frac{1}{6}$$

### Example 3

The functions `diff`, `expand` and `float` handle expressions involving beta:

```
diff(beta(x^2, x), x)
```

$$\beta(x, x^2) (\psi(x) + 2 x \psi(x^2) - \psi(x^2 + x) (2 x + 1))$$

```
expand(beta(x - 1, y + 1))
```

$$-\frac{y \Gamma(x) \Gamma(y)}{\Gamma(x+y) - x \Gamma(x+y)}$$

```
float(beta(100, 1000))
```

$$7.730325902 \cdot 10^{-147}$$

### Example 4

The functions `diff` and `series` can handle `beta`:

```
diff(beta(x, y), x);  
diff(beta(x, y), y);
```

$$-\beta(x, y) (\psi(x+y) - \psi(x))$$

$$-\beta(x, y) (\psi(x+y) - \psi(y))$$

```
normal(series(beta(x, y), y = 0, 3))
```

$$\frac{1}{y} - \text{EULER} - \psi(x) + y \left( \frac{\psi(x)^2}{2} + \text{EULER} \psi(x) + \frac{\text{EULER}^2}{2} + \frac{\pi^2}{12} - \frac{\psi'(x)}{2} \right) + O(y^2)$$

```
series(beta(x, x), x = infinity, 4)
```

$$\frac{2 \left(\frac{1}{4}\right)^x \sqrt{\pi}}{\sqrt{x}} + \frac{\left(\frac{1}{4}\right)^x \sqrt{\pi}}{4 x^{3/2}} + \frac{\left(\frac{1}{4}\right)^x \sqrt{\pi}}{64 x^{5/2}} + O\left(\frac{\left(\frac{1}{4}\right)^x}{x^{7/2}}\right)$$

## Parameters

**x, y**

arithmetical expressions (Symbolic Math Toolbox) or floating-point intervals on page 7-33

## Return Values

Arithmetical expression or a floating-point interval.

## Overloaded By

x

## See Also

### **MuPAD Functions**

binomial | fact | gamma | psi

# binomial

Binomial coefficients

## Syntax

`binomial(n, k)`

## Description

`binomial(n, k)` represents the binomial coefficient  $\binom{n}{k} = \frac{n!}{(n-k)!k!}$ .

Binomial coefficients are defined for complex arguments via the `gamma` function:

$$\binom{n}{k} = \frac{\Gamma(n+1)}{\Gamma(k+1)\Gamma(n-k+1)}$$

With  $\Gamma(n+1) = n!$ , this coincides with the usual binomial coefficients for integer arguments satisfying  $0 \leq k \leq n$ .

A symbolic function call is returned if one of the arguments cannot be evaluated to a number of type `Type::Numeric`. However, for  $k = 0$ ,  $k = 1$ ,  $k = n - 1$ , and  $k = n$ , simplified results are returned for any  $n$ .

Let  $n$  be a number of type `Type::Numerical`. If  $k$  evaluates to a nonnegative integer,

then  $\frac{n(n-1)\dots(n-k+1)}{k!}$  is returned. If  $n - k$  evaluates to a nonnegative integer, then

$\frac{n(n-1)\dots(k+1)}{k!}$  is returned. If  $k$  or  $n - k$  evaluates to a negative integer, then 0 is returned. If  $k$  evaluates to a floating-point number, then a floating-point value is returned. In all other cases, a symbolic call of `binomial` is returned.

A floating-point value is returned if both arguments are numerical and at least one of them is a floating-point value.

## Environment Interactions

When called with floating-point arguments, the function is sensitive to the environment variable DIGITS which determines the numerical working precision.

## Examples

### Example 1

We demonstrate some calls with exact and symbolic input data:

```
binomial(10, k) $ k=-2..12
```

```
0, 0, 1, 10, 45, 120, 210, 252, 210, 120, 45, 10, 1, 0, 0
```

```
binomial(-23/12, 3), binomial(1 + I, 3)
```

```
- 37835  
-----, - i  
10368, 3
```

```
binomial(n, k), binomial(n, 1), binomial(n, 4)
```

```
 $\binom{n}{k}$ , n,  $\binom{n}{4}$ 
```

Floating point values are computed for floating-point arguments:

```
binomial(-235/123, 3.0), binomial(3.0, 1 + I)
```

```
-3.624343742, 4.411293492 + 2.205646746 i
```

### Example 2

The expand function handles expressions involving binomial:

```
binomial(n, 3) = expand(binomial(n, 3))
```

$$\binom{n}{3} = \frac{n^3}{6} - \frac{n^2}{2} + \frac{n}{3}$$

`binomial(2, k) = expand(binomial(2, k))`

$$\binom{2}{k} = \frac{2 \sin(\pi k)}{\pi k (k-1) (k-2)}$$

The `float` attribute handles `binomial` if all arguments can be converted to floating-point numbers:

`binomial(sin(3), 5/4), float(binomial(sin(3), 5/4))`

$$\binom{\sin(3)}{\frac{5}{4}}, -0.08360571366$$

### Example 3

The functions `diff` and `series` can handle `binomial`:

`diff(binomial(n, k), n);`  
`diff(binomial(n, k), k);`

$$-(\psi(n-k+1) - \psi(n+1)) \binom{n}{k}$$

$$(\psi(n-k+1) - \psi(k+1)) \binom{n}{k}$$

`normal(series(binomial(n, k), k = 0, 3))`

$$1 + k (\text{EULER} + \psi(n+1)) + k^2 \left( \frac{\psi(n+1)^2}{2} + \text{EULER} \psi(n+1) - \frac{\psi'(n+1)}{2} + \frac{\text{EULER}^2}{2} - \frac{\pi^2}{12} \right) + O(k^3)$$

```
series(binomial(2*n, n), n = infinity, 4)
```

$$\frac{4^n}{\sqrt{n} \sqrt{\pi}} - \frac{4^n}{8 n^{3/2} \sqrt{\pi}} + \frac{4^n}{128 n^{5/2} \sqrt{\pi}} + O\left(\frac{4^n}{n^{7/2}}\right)$$

## Parameters

**n, k**

arithmetical expressions (Symbolic Math Toolbox)

## Return Values

Arithmetical expression.

## See Also

### MuPAD Functions

beta | fact | gamma | psi

## block

Create an object protected against evaluation

### Syntax

`block(a)`

### Description

`block(a)` creates a block — an object of special type that contains an unevaluated copy of `a`. It is treated as atomic and remains unchanged by evaluation.

`block` and domains derived thereof form a hierarchy of data types designed to provide control over the evaluation of certain subexpressions. Any object can be put as content into any type of block.

`block` is a domain on page 7-8. If `d` is any block domain, `d(a)` creates a block belonging to that domain, with content `a`.

`block(a)` puts its argument into a block, without evaluating it. In order to evaluate `a` normally before putting it into a block, use `eval(hold(block)(a))`.

Blocks are invariant under evaluation.

Blocks of type `block` are atomic: the only operand of a block is the block itself.

Sequences can also be put into blocks. In the case of `block`, they are not flattened (Symbolic Math Toolbox). See “Example 2” on page 1-343 (Symbolic Math Toolbox).

You can create further block domains using inheritance. This is particularly useful for creating own `evaluate` or `testtype` methods. See “Example 4” on page 1-344 (Symbolic Math Toolbox).

In case of nested blocks, `expr` and `unlock` remove only the outermost block.



## Examples

### Example 1

A block is a sort of container that protects its content against evaluation:

```
y := 1;
bl:= block(1 + y)
```

$$1 + y$$

Blocks are atomic; thus  $y$  and  $1$  are not visible as operands:

```
op(bl), nops(bl)
```

$$1 + y, 1$$

Although blocks are not arithmetical expressions, some basic arithmetical operations are defined for them:

```
collect(x + bl + x*bl, bl)
```

$$(x+1)(1+y)+x$$

```
delete y, bl
```

### Example 2

A block can also contain a sequence; flattening (Symbolic Math Toolbox) is suppressed:

```
block((x, y),z)
```

$$x, y, z$$

### Example 3

The content of a block can be extracted and evaluated using `unblock`:

```
y := 1:  
unblock(block(y))
```

```
1
```

```
delete y
```

## Example 4

Create blocks that represent arithmetical expressions. To do this, you need your own block domain that overloads `testtype`:

```
domain myblock  
  inherits block;  
  category Cat::BaseCategory;  
  testtype:= (bl, T) -> if T = Type::Arithmetical or T = dom then  
    TRUE  
  else  
    block::testtype(bl, T)  
  end_if;  
end_domain:
```

This lets you to make the number zero invisible for the evaluator by enclosing it into a block, but to retain the option to plug it into special functions:

```
f := sin(x+myblock(0))
```

```
sin(x+0)
```

Now you can manipulate this expression, without being disturbed by automatic simplification:

```
expand(f)
```

```
cos(0) sin(x) + cos(x) sin(0)
```

```
eval(unblock(%))
```

```
sin(x)
```

## Parameters

**a**

Any object or sequence of objects

## Return Values

block creates objects of its own type.

## See Also

### **MuPAD Functions**

blockIdentifies | blockTransparent | freeze | hold | unblock

## blockIdents

Create a block with some identifiers protected against evaluation

### Syntax

`blockIdents(S) (a)`

### Description

`blockIdents(S) (a)` creates a transparent block which is evaluated like `a`, except that the identifiers in `S` are not substituted by their values, and their properties on page 1-265 are not used.

`blockIdents` is a parametrized family of domains on page 7-8, depending on a set `S`. If `d` is any block domain, `d(a)` creates a block belonging to that domain, with content `a`.

`blockIdents(S) (a)` replaces all identifiers in `a` that belong to `S` by newly created identifiers, evaluates the result and substitutes back; the final result is put into a block. In order to evaluate `a` normally before putting it into a block, `useeval(hold(blockIdents(S))(a))`.

Blocks of type `blockIdents(S)` are evaluated in the same way as their contents at the time of creation.

Blocks of type `blockIndents(S)` have the same operands as their content.

Sequences can also be put into blocks.

The call `expr(b)` replaces all transparent blocks in `b` by their content, without evaluating that content.

In case of nested blocks, `expr` and `unlock` remove only the outermost block.

## Examples

### Example 1

A block is a sort of container that protects its content against evaluation. With `blockIds`, you can suppress evaluation for particular identifiers:

```
bl := blockIds({x,y})(x + y + a):
[a,x,y] := [1,2,3]:
bl
```

`x + y + 1`

```
delete x, y:
```

### Example 2

You can extract and evaluate the content of a block using `unlock`:

```
bl := blockIds({y})(x + y):
y := 1:
bl
```

`x + y`

```
unlock(bl)
```

`x + 1`

```
delete y
```

## Parameters

**a**

Any object or sequence of objects

## **S**

Set of identifiers

## **Return Values**

`blockIdent`s creates objects of its own type.

## **See Also**

### **MuPAD Functions**

`block` | `blockTransparent` | `freeze` | `hold` | `unlock`

# blockTransparent

Create a transparent block protected against evaluation

## Syntax

`blockTransparent(a)`

## Description

`blockTransparent(a)` creates a transparent block, which is left unchanged by evaluation, but treated as expression with the same operands as `a`.

`blockTransparent` is a domain on page 7-8. If `d` is any block domain, `d(a)` creates a block belonging to that domain, with content `a`.

`blockTransparent(a)` puts its argument into a block, without evaluating it. In order to evaluate `a` normally before putting it into a block of some kind, use `eval(hold(blockTransparent)(a))`.

Transparent blocks are invariant under evaluation, but such blocks have the same operands as their content.

Sequences can also be put into block. In the case of `blockTransparent`, they are not flattened (Symbolic Math Toolbox). See "Example 2" on page 1-350 (Symbolic Math Toolbox).

The call `expr(b)` replaces all transparent blocks in `b` by their content, without evaluating that content. Thus, `expr(blockTransparent(a))` is similar to `hold(a)`.

In case of nested blocks, only the outermost block is removed by both `expr` and `unlock`.

## Examples

### Example 1

A block, including transparent blocks, is a sort of container that protects its content against evaluation:

```
y := 2:  
bl := blockTransparent(x + y + z)
```

```
x + y + z
```

Transparent block allow access to the operands of its content:

```
op(bl,1), subs(bl, hold(y) = y)
```

```
x, x + 2 + z
```

```
delete bl, y
```

### Example 2

A block can also contain a sequence; flattening (Symbolic Math Toolbox) is suppressed:

```
blockTransparent((x, y),z)
```

```
x, y, z
```

### Example 3

The content of a block can be extracted and evaluated using `unblock`:

```
bl := blockTransparent(x + y):  
[x, y] := [1, 2]:  
bl
```

```
x + y
```



`unlock(bl)`

`3`

`delete y`

## Parameters

**a**

Any object or sequence of objects

## Return Values

blockTransparent creates objects of its own type.

## See Also

### MuPAD Functions

`block` | `blockIdents` | `freeze` | `hold` | `unlock`

# unlock

Replace blocks by their contents

## Syntax

```
unlock(b, <blockdomain, <Recurse>>)
```

## Description

`unlock(b)` replaces all blocks that appear as subexpressions in `b` by their contents.

`unlock(b)` replaces all blocks in `b` by the result of evaluating their content. Thus, `unlock(block(a))` should in most cases be equivalent to `a`. The behavior of `unlock` may be controlled by additional arguments. If a second argument `blockdomain` is given, only blocks belonging to a domain that inherits from `blockdomain` are replaced by their content. If `FALSE` is provided as a third argument, only `b` is replaced by its content if it is a block of suitable type itself.

The call `expr(b)` replaces all transparent blocks in `b` by their content, without evaluating that content. Thus, `expr(blockTransparent(a))` is similar to `hold(a)`.

In case of nested blocks, only the outermost block is removed by both `expr` and `unlock`.

## Examples

### Example 1

A block is a sort of container that protects its content against evaluation:

```
y := 1:  
bl:= block(1 + y)
```

`1 + y`

Blocks are atomic; thus `y` and `1` are not visible as operands:

```
op(bl), nops(bl)
```

```
1 + y, 1
```

The content of a block may be extracted and evaluated using `unblock`:

```
unblock(bl)
```

```
2
```

```
delete y
```

## Parameters

**b**

Any object

**blockdomain**

Any domain that inherits from `block`

**Recurse**

TRUE or FALSE

## Return Values

In most cases, the object `b`.

## See Also

**MuPAD Functions**

`block` | `blockIdents` | `blockTransparent` | `freeze` | `hold`

# bool

Boolean evaluation

---

**Note** For booleans in MATLAB®, see `logical`.

---

## Syntax

`bool(b)`

## Description

`bool(b)` evaluates the Boolean expression `b`.

The function `bool` serves for reducing Boolean expressions to one of the Boolean constants `TRUE`, `FALSE`, or `UNKNOWN`.

Boolean expressions are expressions that are composed of equalities on page 1-19, inequalities on page 1-30, elementhood relations on page 1-1006, and these constants, combined via the logical operators `and`, `or`, `not`.

The function `bool` evaluates all equalities and inequalities inside a Boolean expression to either `TRUE` or `FALSE`. The resulting logical combination of the Boolean constants is reduced according to the rules of the MuPAD three state logic (see `and`, `or`, `not`).

---

**Note** Equations  $x = y$  and inequalities  $x <> y$  are evaluated *syntactically* by `bool`. It does not test equality in any mathematical sense.

---

---

**Note** Inequalities  $x < y$ ,  $x <= y$  etc. can be evaluated by `bool` if and only if `x` and `y` are real numbers of type `Type::Real`. Otherwise, an error occurs.

---

`bool` evaluates *all* subexpressions of a Boolean expression before simplifying the result. The functions `_lazy_and`, `_lazy_or` provide an alternative: “lazy Boolean evaluation”.

There is no need to use `bool` in the conditional part of `if`, `repeat`, and `while` statements. Internally, these statements enforce Boolean evaluation by `_lazy_and` and `_lazy_or`. Cf. “Example 5” on page 1-357 (Symbolic Math Toolbox).

Use `simplify` with the option `logic` to simplify expressions involving symbolic Boolean subexpressions. Cf. “Example 7” on page 1-358 (Symbolic Math Toolbox).

`bool` is overloadable not only for domains, but also for function environments on page 7-25. This means that, if `f` evaluates to a function environment, then `bool(f(x1, ..., xn))` returns `f::bool(x1, ..., xn)`, or an error if no slot `f::bool` exists.

The call `bool(x ~= y)` serves for comparing numerical values `x` and `y`. If both `x` and `y` can be converted to non-zero real or complex floating-point numbers, it is checked whether `float((x - y)/x) | < 10^(-DIGITS)` is satisfied. Thus, `TRUE` is returned if `x` and `y` coincide within the relative numerical precision set by `DIGITS`. For `x = 0`, the criterion is `|float(y)| < 10^(-DIGITS)`. For `y = 0`, the criterion is `|float(x)| < 10^(-DIGITS)`. If either `x` or `y` contains a symbolic object that cannot be converted to a real or complex floating point number, the function `bool` returns the value `UNKNOWN`.

## Examples

### Example 1

MuPAD realizes that 1 is less than 2:

```
1 < 2 = bool(1 < 2)
```

```
1 < 2 = TRUE
```

Note that `bool` can fail to compare real numbers expressed symbolically:

```
bool(sqrt(14) <= sqrt(2)*sqrt(7))
```

```
Error: Unable to evaluate to Boolean. [_leequal]
```

You can compare floating-point approximations. Alternatively, you can use `is`:

```
bool(float(sqrt(14)) <= float(sqrt(2)*sqrt(7))),
is(sqrt(14) <= sqrt(2)*sqrt(7))
```

TRUE, TRUE

## Example 2

The Boolean operators `and`, `or`, `not` do not evaluate equations and inequalities logically, and return a symbolic Boolean expression. Boolean evaluation and simplification is enforced by `bool`:

```
a = a and 3 < 4
```

```
a = a ^ 3 < 4
```

```
bool(a = a and 3 < 4)
```

TRUE

## Example 3

`bool` handles the special Boolean constant `UNKNOWN`:

```
bool(UNKNOWN and 1 < 2), bool(UNKNOWN or 1 < 2),  
bool(UNKNOWN and 1 > 2), bool(UNKNOWN or 1 > 2)
```

UNKNOWN, TRUE, FALSE, UNKNOWN

## Example 4

`bool` must be able to reduce all parts of a composite Boolean expression to one of the Boolean constants. No symbolic Boolean subexpressions may be involved:

```
b := b1 and b2 or b3: bool(b)
```

```
Error: Unable to evaluate to Boolean. [bool]
```

```
b1 := 1 < 2: b2 := x = x: b3 := FALSE: bool(b)
```

TRUE

```
delete b, b1, b2, b3:
```

## Example 5

There is no need to use `bool` explicitly in the conditional parts of `if`, `repeat`, and `while` statements. Note, however, that these structures internally use “lazy evaluation” via `_lazy_and` and `_lazy_or` rather than “complete Boolean evaluation” via `bool`:

```
x := 0: if x <> 0 and sin(1/x) = 0 then 1 else 2 end
```

2

In contrast to “lazy evaluation”, `bool` evaluates *all* conditions. Consequently, a division by zero occurs in the evaluation of `sin(1/x) = 0`:

```
bool(x <> 0 and sin(1/x) = 0)
```

```
Error: Division by zero. [_invert]
```

```
delete x:
```

## Example 6

Note that `bool` does not operate recursively. The following calls are completely different, the first one comparing the expression `TRUE = TRUE` and the constant `TRUE` (syntactically), the second one comparing the result of another `bool`-call with `TRUE`:

```
bool((TRUE = TRUE) = TRUE);
bool(bool(TRUE = TRUE) = TRUE)
```

FALSE

TRUE

Since `if`, `while` and similar constructs use the same Boolean evaluation internally, this also effects conditions in such clauses:

```
if (is(a < b) = TRUE) or (3 = 3) then YES else NO end;  
if (is(a < b) or (3 = 3)) = TRUE then YES else NO end
```

YES

NO

## Example 7

Expressions involving symbolic Boolean subexpressions cannot be processed by `bool`. However, `simplify` with the option `logic` can be used for simplification:

```
(b1 and b2) or (b1 and (not b2)) and (1 < 2)
```

```
(b1 ∧ b2) ∨ (b1 ∧ ¬ b2 ∧ 1 < 2)
```

```
simplify(%, logic)
```

```
b1
```

## Parameters

**b**

A Boolean expression

## Return Values

TRUE, FALSE, or UNKNOWN.



## Overloaded By

b

## See Also

### MuPAD Functions

FALSE | TRUE | UNKNOWN | `_lazy_and` | `_lazy_or` | `if` | `is` | `repeat` | `while`

## break\_break

Terminate a loop or a Case switch prematurely

### Syntax

`break`

`_break()`

### Description

`break` terminates `for`, `repeat`, `while` loops, and `case` statements.

The `break` statement is equivalent to the function call `_break()`. The return value is the void object of type `DOM_NULL`.

Inside `for`, `repeat`, `while`, and `case` statements, the `break` statement exits from the loop/switch. Execution proceeds with the next statement after the `end` clause of the loop/switch.

In nested loops, only the innermost loop is terminated by `break`.

`break` also terminates a statement sequence `_stmtseq(..., break, ...)`.

Outside `for`, `repeat`, `while`, `case`, and `_stmtseq`, the `break` statement has no effect.

### Examples

#### Example 1

Loops are exited prematurely by `break`:

```
for i from 1 to 10 do
  print(i);
```

```
    if i = 2 then break end_if  
end_for
```

1

2

```
delete i:
```

## Example 2

In a case statement, all commands starting with the first matching branch are executed:

```
x := 2;  
case x  
  of 1 do print(1); x^2;  
  of 2 do print(2); x^2;  
  of 3 do print(3); x^2;  
  otherwise print(UNKNOWN)  
end_case:
```

2

3

UNKNOWN

In the next version, `break` ensures that only the statements in the matching branch are evaluated:

```
case x  
  of 1 do print(1); x^2; break;  
  of 2 do print(2); x^2; break;  
  of 3 do print(3); x^2; break;  
  otherwise print(UNKNOWN)  
end_case:
```

2

delete x:

## See Also

### **MuPAD Functions**

case | for | next | repeat | return | while

# buildnumber

The Build number of

## Syntax

```
buildnumber()
```

## Description

`buildnumber()` returns the “build number” of the MuPAD library.

`buildnumber` is a natural number increasing over time which enables the MuPAD developers to exactly identify the version of the library used. Its primary use is for cooperating partners with access to development versions.

## Examples

### Example 1

At the time of this writing, the MuPAD build number was 42703:

```
buildnumber()
```

```
42703
```

## Return Values

Integer.

## See Also

### **MuPAD Functions**

Pref::kernel | version

# bytes

Memory used by the current session

## Syntax

```
bytes()
```

## Description

`bytes()` returns the current memory consumption.

`bytes` returns the following three numbers:

- The number of bytes used logically; this is the amount of memory which is actually used for storing MuPAD data.
- The number of bytes physically allocated by the memory management; this is the amount of memory MuPAD has allocated from the operating system. The difference between the physical and the logical bytes is the amount of memory which has already been reserved for future calculations.
- The maximum number of bytes ever allocated from the operating system during the current session. This value *never* decreases, not even on a call to `reset`.

## Examples

### Example 1

In a freshly started MuPAD session, `bytes` may return the following data on the memory consumption of the session:

```
bytes()
```

```
837168, 1572864, 1703936
```

Each computation increases the memory usage:

```
sin(PI): bytes()
```

```
970204, 1638400, 1703936
```

```
solve(x-1=0, x): bytes()
```

```
2361864, 3014656, 3014656
```

## Return Values

Sequence of three integers.

## See Also

### MuPAD Functions

`rtime` | `time`



# card

Cardinality of a set

## Syntax

```
card(set)
```

```
card(d)
```

## Description

`card(set)` returns the cardinality of `set`.

If `set` is a `DOM_SET`, the number of operands is returned; `card` does not attempt to investigate whether the members of `set` really represent pairwise different mathematical objects.

`card` does not distinguish different infinite cardinals; it just returns `infinity` if `set` is infinite.

`card` returns a symbolic call to itself if it cannot determine the cardinality.

If applied to a domain `d`, `card` returns the domain entry `d::size`. A domain that does not have this entry is not regarded as a set.

## Examples

### Example 1

The cardinality of a finite set equals the number of its operands:

```
card({1, 2, 3})
```

3

This holds true even if there exist two operands of the set that represent the same mathematical object:

```
card({1, 1.0})
```

2

### Example 2

card does not distinguish different sizes of infinite sets:

```
card(R_), card(Z_)
```

$\infty, \infty$

### Example 3

Set-theoretic expressions containing symbols are legal input, but usually card will not be able to determine their cardinality:

```
card(S union {3})
```

$|\{3\} \cup S|$

### Example 4

Domains that have a "size" entry are regarded as sets:

```
card(Dom::IntegerMod(7))
```

7

## Parameters

### **set**

A set of type `DOM_SET`, or a set-theoretic expression

### **d**

A domain (Symbolic Math Toolbox) representing a set

## Return Values

Nonnegative integer, or `infinity`.

## Overloaded By

`d`, `set`

## See Also

### **MuPAD Functions**

`nops`

## caseofotherwiseend\_case\_case

Switch statement

---

**Note** For switch-case in MATLAB®, see `switch`.

---

### Syntax

```
case x
  of match1 do
    statements1
  of match2 do
    statements2
  ...
  otherwise
    otherstatements
end_case
```

```
case x
  of match1 do
    statements1
  of match2 do
    statements2
  ...
end_case
```

```
_case(x, match1, statements1, match2, statements2, , ..., <otherstatements>)
```

### Description

A case-end\_case statement allows to switch between various branches in a program.

The case statement is a control structure that extends the functionality of the if statement. In a case statement, an object is compared with a number of given values and one or more statement sequences are executed.

If the value of `x` equals one of the values `match1`, `match2` etc., the first matching branch *and all its following branches (including `otherwise`)* are executed, until the execution is terminated by a `break` or a `return` statement, or the `end_case`.

If the value of `x` does not equal any of the values `match1`, `match2`, . . . , only the `otherwise` branch is executed. If no `otherwise` branch exists, the case statement terminates and returns the void object of type `DOM_NULL`.

The keyword `end_case` may be replaced by the keyword `end`.

## Examples

### Example 1

All statements after the first match are executed:

```
x := 2:
case x
  of 1 do print(1)
  of 2 do print(4)
  of 3 do print(9)
  otherwise print("otherwise")
end_case:
```

4

9

"otherwise"

`break` may be used to ensure that only one matching branch is executed:

```
case x
  of 1 do print(1); 1; break
  of 2 do print(4); 4; break
  of 3 do print(9); 9; break
  otherwise print("otherwise")
end_case:
```

4

`delete x:`

## Example 2

The functionality of the `case` statement allows to share code that is to be used in several branches. The following function uses the statement `print(x, "is a real number")` for the three branches that correspond to real MuPAD numbers:

```
isReal := proc(x)
begin
  case domtype(x)
  of DOM_INT do
  of DOM_RAT do
  of DOM_FLOAT do print(x, "is a real number"); break
  of DOM_COMPLEX do print(x, "is not a real number"); break
  otherwise print(x, "cannot decide");
  end_case
end_proc:
isReal(3), isReal(3/7), isReal(1.23), isReal(3 + I), isReal(z)
```

3, "is a real number"

$\frac{3}{7}$ , "is a real number"

1.23, "is a real number"

3 + i, "is not a real number"

z, "cannot decide"

`delete isReal:`

## Example 3

The correspondence between the functional and the imperative form of the case statement is demonstrated:

```
hold(_case(x, match1, (1; break), match2, (4; break),
          print("otherwise")))
```

```
case x
  of match1 do
    1;
    break
  of match2 do
    4;
    break
  otherwise
    print("otherwise")
end_case
```

```
hold(_case(x, match1, (1; break), match2, (4; break)))
```

```
case x
  of match1 do
    1;
    break
  of match2 do
    4;
    break
end_case
```

## Parameters

**x, match1, match2, ...**

Arbitrary MuPAD objects

**statements1, otherstatements, ...**

Arbitrary sequences of statements

## **Return Values**

Result of the last command executed inside the `case` statement. The void object of type `DOM_NULL` is returned if no matching branch was found and no `otherwise` branch exists. `NIL` is returned if a matching branch was encountered, but no command was executed inside this branch.

## **Algorithms**

The functionality of the `case` statement corresponds to the `switch` statement of the C programming language.

## **See Also**

### **MuPAD Functions**

`break` | `if` | `return`



# ceil

Round up to the next integer

---

**Note** For the `ceil` function in MATLAB®, see `ceil`.

---

## Syntax

`ceil(x)`

## Description

`ceil` rounds a number to the next larger integer.

For complex arguments, `ceil` rounds the real and the imaginary parts separately.

For real numbers and exact expressions representing real numbers, `ceil` returns integers.

For arguments that contain symbolic identifiers, `ceil` returns unevaluated function calls.

For floating-point intervals on page 7-33, `ceil` returns floating-point intervals containing all the results of applying `ceil` to the real or complex numbers inside the interval.

---

**Note** If the argument is a floating-point number of absolute value larger than  $10^{DIGITS}$ , the resulting integer is affected by internal non-significant digits. See “Example 2” on page 1-376 (Symbolic Math Toolbox).

---

---

**Note** Internally, exact numerical expressions that are neither integers nor rational numbers are approximated by floating-point numbers before rounding. Thus, the resulting integer depends on the current `DIGITS` setting. See “Example 3” on page 1-377 (Symbolic Math Toolbox).

---

## Environment Interactions

The functions are sensitive to the environment variable DIGITS which determines the numerical working precision.

### Examples

#### Example 1

Round the following real and complex numbers:

```
ceil(3.5), ceil(-7/2), ceil(3 + 5/2*I)
```

```
4, -3, 3 + 3 i
```

Round the following symbolic expression representing a number:

```
ceil(PI*I + 7*sin(exp(2)))
```

```
7 + 4 i
```

Rounding of expressions with symbolic identifiers produces unevaluated function calls:

```
ceil(x)
```

```
[x]
```

#### Example 2

Rounding floating-point numbers of large absolute value is affected by internal non-significant digits:

```
x := 10^30/3.0
```

```
3.333333333 1029
```

Note that only the first 10 decimal digits are “significant”. Further digits are subject to round-off effects caused by the internal binary representation. These “insignificant” digits are part of the integer produced by rounding:

```
ceil(x)
```

```
3333333333333333332997967970304
```

```
delete x:
```

### Example 3

Exact numerical expressions are internally converted to floating-point numbers before rounding. Consequently, the current setting of DIGITS can affect the result:

```
x := 10^30 - exp(30)^ln(10)
```

```
1000000000000000000000000000000000000000000000 - (e30)ln(10)
```

Note that the exact value of this number is 0. Floating-point evaluation is subject to severe cancellations:

```
DIGITS := 10:  
float(x), ceil(x)
```

```
-6.157265116 1013, 671088640
```

The floating-point result is more accurate when calculated with a higher precision. The rounded values change accordingly:

```
DIGITS := 20:  
float(x), ceil(x)
```

```
5504.0, 5504
```

```
DIGITS := 30:  
float(x), ceil(x)
```

0.00000031292438507080078125, 1

delete x, DIGITS:

## Example 4

On floating-point intervals, `ceil` behaves as follows:

`ceil(3.5...6.7)`

4.0 ... 7.0

This interval contains the results of `ceil(x)` for all  $x \in 3.5 \dots 6.7$ .

Because there are finite numbers represented as `RD_INF` and `RD_NINF`, respectively, `ceil` returns very small or large representable numbers in certain cases:

`ceil(RD_NINF...RD_NINF)`

`RD_NINF ... -2.098578716 10323228496`

## Parameters

**x**

An arithmetical expression (Symbolic Math Toolbox) or floating-point interval on page 7-33

## Return Values

Arithmetical expression.

## Overloaded By

x

## See Also

### MuPAD Functions

floor | frac | round | trunc

# floor

Round down to the next integer

---

**Note** For the `floor` function in MATLAB®, see `floor`.

---

## Syntax

`floor(x)`

## Description

`floor` rounds a number to the next smaller integer.

For complex arguments, `floor` rounds the real and the imaginary parts separately.

For real numbers and exact expressions representing real numbers, `floor` returns integers.

For arguments that contain symbolic identifiers, `floor` returns unevaluated function calls.

For floating-point intervals on page 7-33, `floor` returns floating-point intervals containing all the results of applying `floor` to the real or complex numbers inside the interval.

---

**Note** If the argument is a floating-point number of absolute value larger than  $10^{DIGITS}$ , the resulting integer is affected by internal non-significant digits. See “Example 2” on page 1-381 (Symbolic Math Toolbox).

---

---

**Note** Internally, exact numerical expressions that are neither integers nor rational numbers are approximated by floating-point numbers before rounding. Thus, the resulting integer depends on the current `DIGITS` setting. See “Example 3” on page 1-382 (Symbolic Math Toolbox).

---

## Environment Interactions

The functions are sensitive to the environment variable DIGITS which determines the numerical working precision.

### Examples

#### Example 1

Round the following real and complex numbers:

```
floor(3.5), floor(-7/2), floor(4.3 + 7*I)
```

$3, -4, 4 + 7i$

Round the following symbolic expression representing a number:

```
floor(PI*I + 7*sin(exp(2)))
```

$6 + 3i$

Rounding of expressions with symbolic identifiers produces unevaluated function calls:

```
floor(x - 1)
```

$\lfloor x - 1 \rfloor$

#### Example 2

Rounding floating-point numbers of large absolute value is affected by internal non-significant digits:

```
x := 10^30/3.0
```

$3.333333333 \cdot 10^{29}$

Note that only the first 10 decimal digits are “significant”. Further digits are subject to round-off effects caused by the internal binary representation. These “insignificant” digits are part of the integer produced by rounding:

```
floor(x)
```

```
3333333333333333332997967970304
```

```
delete x:
```

### Example 3

Exact numerical expressions are internally converted to floating point numbers before rounding. Consequently, the current setting of DIGITS can affect the result:

```
x := 10^30 - exp(30)^ln(10)
```

```
10000000000000000000000000000000 - (e30)ln(10)
```

Note that the exact value of this number is 0. Floating-point evaluation is subject to severe cancellations:

```
DIGITS := 10:
float(x), floor(x)
```

```
-6.157265116 1013, 671088640
```

The floating-point result is more accurate when calculated with a higher precision. The rounded values change accordingly:

```
DIGITS := 20:
float(x), floor(x)
```

```
5504.0, 5504
```

```
DIGITS := 30:
float(x), floor(x)
```



0.00000031292438507080078125, 0

delete x, DIGITS:

## Example 4

On floating-point intervals, `floor` behaves as follows:

`floor(3.5...6.7)`

3.0 ... 6.0

This interval contains the results of `floor(x)` for all  $x \in 3.5 \dots 6.7$ .

Because there are finite numbers represented as `RD_INF` and `RD_NINF`, respectively, `floor` returns very small or large representable numbers in certain cases:

`ceil(RD_NINF...RD_NINF)`

`RD_NINF ... -2.098578716 10323228496`

## Parameters

**x**

Arithmetical expression (Symbolic Math Toolbox) or floating-point interval on page 7-33

## Return Values

Arithmetical expression.

## Overloaded By

x

## See Also

### **MuPAD Functions**

ceil | frac | round | trunc

# round

Rounding to the nearest integer

## Syntax

`round(x, <n>)`

## Description

`round` rounds a number to the nearest integer.

For complex arguments, `round` rounds the real and the imaginary parts separately.

For arguments that contain symbolic identifiers, `round` returns unevaluated function calls.

For floating-point intervals on page 7-33, `round` returns floating-point intervals containing all the results of applying `round` to the real or complex numbers inside the interval.

`round(x, n)` returns a floating-point number with the rounded  $n$ -th decimal digit after the decimal point and sets all further digits to zero. If  $n$  is a negative integer, then `round` rounds the corresponding digit to the left of the decimal point. See “Example 2” on page 1-386 (Symbolic Math Toolbox).

---

**Note** If the argument is a floating-point number of absolute value larger than  $10^{DIGITS}$ , the resulting integer is affected by internal non-significant digits. See “Example 3” on page 1-387 (Symbolic Math Toolbox).

---

---

**Note** Internally, exact numerical expressions that are neither integers nor rational numbers are approximated by floating-point numbers before rounding. Thus, the resulting integer depends on the current `DIGITS` setting. See “Example 4” on page 1-387 (Symbolic Math Toolbox).

---

## Environment Interactions

The functions are sensitive to the environment variable DIGITS which determines the numerical working precision.

### Examples

#### Example 1

Round the following real and complex numbers:

```
round(3.5), round(-7/2), round(I/2)
```

```
4, -3, i
```

Round the following symbolic expression representing a number:

```
round(PI*I + 7*sin(exp(2)))
```

```
6 + 3 i
```

Rounding of expressions with symbolic identifiers produces unevaluated function calls:

```
round(x + 1)
```

```
round(x + 1)
```

#### Example 2

`round(x, n)` rounds the  $n$ -th decimal digit of the floating-point representation of  $x$ :

```
round(123.456, 1), round(123.456, 2), round(123.456, 3),  
round(123.456, 4), round(123.456, 5)
```

```
123.5, 123.46, 123.456, 123.456, 123.456
```

```
float(exp(5)*PI), round(exp(5)*PI, 3)
```

```
466.2536903, 466.254
```

If second argument is a negative integer, `round` rounds the digits to the left of the decimal point:

```
round(123.45, 1), round(123.45, 0), round(123.45, -1),
round(123.45, -2), round(123.45, -3)
```

```
123.4, 123.0, 120.0, 100.0, 0.0
```

### Example 3

Rounding floating-point numbers of large absolute value is affected by internal non-significant digits:

```
x := 10^30/3.0
```

```
3.333333333 10-29
```

Note that only the first 10 decimal digits are “significant”. Further digits are subject to round-off effects caused by the internal binary representation. These “insignificant” digits are part of the integer produced by rounding:

```
round(x)
```

```
33333333333333333332997967970304
```

```
delete x:
```

### Example 4

Exact numerical expressions are internally converted to floating-point numbers before rounding. Consequently, the current setting of `DIGITS` can affect the result:

```
x := 10^30 - exp(30)^ln(10)
```

```
10000000000000000000000000000000 - (e30)ln(10)
```

Note that the exact value of this number is 0. Floating-point evaluation is subject to severe cancellations:

```
DIGITS := 10:  
float(x), round(x)
```

```
-6.157265116 1013, 671088640
```

The floating-point result is more accurate when calculated with a higher precision. The rounded values change accordingly:

```
DIGITS := 20:  
float(x), round(x)
```

```
5504.0, 5504
```

```
DIGITS := 30:  
float(x), round(x)
```

```
0.00000031292438507080078125, 0
```

```
delete x, DIGITS:
```

## Example 5

On floating-point intervals, round behaves as follows:

```
round(3.5...6.7)
```

```
3.0 ... 7.0
```

This interval contains the results of round( $x$ ) for all  $x \in 3.5 \dots 6.7$ .

Because there are finite numbers represented as RD\_INF and RD\_NINF, respectively, round returns very small or large representable numbers in certain cases:

`round(RD_NINF...RD_NINF)`

`RD_NINF ... -2.098578716 10323228496`

## Parameters

**x**

Arithmetical expression (Symbolic Math Toolbox) or floating-point interval on page 7-33

**n**

Integer. If *n* is positive, the *n*-th digit after the decimal point is rounded. If *n* is negative, the  $|n|$ -th digit before the decimal point is rounded.

## Return Values

Arithmetical expression.

## Overloaded By

x

## See Also

### MuPAD Functions

`ceil` | `floor` | `frac` | `trunc`

## trunc

Rounding towards zero

### Syntax

`trunc(x)`

### Description

`trunc` rounds a number to the next integer in the direction of 0.

For complex arguments, `trunc` rounds the real and the imaginary parts separately.

For real numbers and exact expressions representing real numbers, `trunc` returns integers.

For arguments that contain symbolic identifiers, `trunc` returns unevaluated function calls.

For floating-point intervals on page 7-33, `trunc` returns floating-point intervals containing all the results of applying `trunc` to the real or complex numbers inside the interval.

If  $x$  is a floating-point number, then `trunc(x)` truncates the digits after the decimal point. Thus, `trunc` coincides with `floor` for real positive arguments and with `ceil` for real negative arguments.

---

**Note** If the argument is a floating-point number of absolute value larger than  $10^{DIGITS}$ , the resulting integer is affected by internal non-significant digits. See “Example 2” on page 1-391 (Symbolic Math Toolbox).

---

---

**Note** Internally, exact numerical expressions that are neither integers nor rational numbers are approximated by floating-point numbers before rounding. Thus, the resulting integer depends on the current `DIGITS` setting. See “Example 3” on page 1-392 (Symbolic Math Toolbox).

---



## Environment Interactions

The functions are sensitive to the environment variable DIGITS which determines the numerical working precision.

## Examples

### Example 1

Round the following real and complex numbers:

```
trunc(3.5), trunc(-7/2), trunc(I/2)
```

3, -3, 0

Round the following symbolic expression representing a number:

```
trunc(PI*I + 7*sin(exp(2)))
```

6 + 3 i

Rounding of expressions with symbolic identifiers produces unevaluated function calls:

```
trunc(x^2 + 3)
```

$\text{trunc}(x^2 + 3)$

### Example 2

Rounding floating-point numbers of large absolute value is affected by internal non-significant digits:

```
x := 10^30/3.0
```

3.333333333 10<sup>29</sup>

Note that only the first 10 decimal digits are “significant”. Further digits are subject to round-off effects caused by the internal binary representation. These “insignificant” digits are part of the integer produced by rounding:

```
trunc(x)
```

```
3333333333333333332997967970304
```

```
delete x:
```

### Example 3

Exact numerical expressions are internally converted to floating-point numbers before rounding. Consequently, the current setting of DIGITS can affect the result:

```
x := 10^30 - exp(30)^ln(10)
```

```
100000000000000000000000000000 - (e30)ln(10)
```

Note that the exact value of this number is 0. Floating-point evaluation is subject to severe cancellations:

```
DIGITS := 10:  
float(x), trunc(x)
```

```
-6.157265116 1013, 671088640
```

The floating-point result is more accurate when a higher precision is used. The rounded values change accordingly:

```
DIGITS := 20:  
float(x), trunc(x)
```

```
5504.0, 5504
```

```
DIGITS := 30:  
float(x), trunc(x)
```

```
0.00000031292438507080078125, 0
```

```
delete x, DIGITS:
```

## Example 4

On floating-point intervals, `trunc` behaves as follows:

```
round(3.5...6.7)
```

```
3.0 ... 7.0
```

This interval contains the results of `trunc(x)` for all  $x \in 3.5 \dots 6.7$ .

Because there are finite numbers represented as `RD_INF` and `RD_NINF`, respectively, `trunc` returns very small or large representable numbers in certain cases:

```
ceil(RD_NINF...RD_NINF)
```

```
RD_NINF ... -2.098578716 10323228496
```

## Parameters

**x**

Arithmetical expression (Symbolic Math Toolbox) or floating-point interval on page 7-33

## Return Values

Arithmetical expression.

## Overloaded By

x

## See Also

### **MuPAD Functions**

ceil | floor | frac | round

# Ci

Cosine integral function

## Syntax

`Ci(x)`

## Description

`Ci(x)` represents the cosine integral  $\text{EULER} + \ln(x) + \int_0^x \frac{\cos(t) - 1}{t} dt$ .

If `x` is a floating-point number, then `Ci(x)` returns floating-point results. The special values `Ci(∞) = 0` and `Ci(-∞) = iπ` are implemented. For all other arguments, `Ci` returns symbolic function calls.

The float attribute of `Ci` is a kernel function, thus, floating-point evaluation is fast.

## Environment Interactions

When called with a floating-point argument, the functions are sensitive to the environment variable `DIGITS` which determines the numerical working precision.

## Examples

### Example 1

Most calls with exact arguments return themselves unevaluated:

`Ci(1)`, `Ci(sqrt(2))`, `Ci(x + 1)`, `Ci(infinity)`, `Ci(-infinity)`

$\text{Ci}(1)$ ,  $\text{Ci}(\sqrt{2})$ ,  $\text{Ci}(x+1)$ ,  $0$ ,  $\pi i$

To approximate exact results with floating-point numbers, use `float`:

`float(Ci(1))`, `float(Ci(sqrt(2)))`

0.3374039229, 0.4636528024

Alternatively, use a floating-point value as an argument:

`Ci(1.0)`, `Ci(2.0 + 10.0*I)`

0.3374039229, -242.5252694 - 1185.8387 i

## Example 2

$\text{Ci}$  is singular at the origin:

`Ci(0)`

Error: Singularity. [Ci]

The negative real axis is a branch cut of  $\text{Ci}$ . A jump of height  $2\pi i$  occurs when crossing this cut:

`Ci(-1.0)`, `Ci(-1.0 + 10-10*I)`, `Ci(-1.0 - 10-10*I)`

0.3374039229 + 3.141592654 i, 0.3374039229 + 3.141592654 i,  
0.3374039229 - 3.141592654 i

## Example 3

`diff`, `float`, `series`, and other functions handle expressions involving  $\text{Ci}$ :

`diff(Ci(x), x, x, x)`, `float(ln(3 + Ci(sqrt(PI))))`

$$\frac{2 \cos(x)}{x^3} - \frac{\cos(x)}{x} + \frac{2 \sin(x)}{x^2}, 1.241299561$$

`series(Ci(x), x = 0)`

$$\text{EULER} + \ln(x) - \frac{x^2}{4} + \frac{x^4}{96} + O(x^6)$$

`series(Ci(x), x = infinity, 5)`

$$\frac{\sin(x)}{x} - \frac{\cos(x)}{x^2} - \frac{2 \sin(x)}{x^3} + \frac{6 \cos(x)}{x^4} + \frac{24 \sin(x)}{x^5} + O\left(\frac{1}{x^6}\right)$$

## Parameters

**x**

An arithmetical expression (Symbolic Math Toolbox)

## Return Values

Arithmetical expression.

## Overloaded By

x

## Algorithms

The functions  $\text{Ci}(x) - \ln(x)$  and  $\text{Chi}(x) - \ln(x)$  are entire functions. Thus,  $\text{Ci}$  and  $\text{Chi}$  have a logarithmic singularity at the origin and a branch cut along the negative real axis. The values on the negative real axis coincide with the limit “from above”:

$$\operatorname{Ci}(x) = \lim_{\varepsilon \rightarrow 0^+} \operatorname{Ci}(x + \varepsilon i), \operatorname{Chi}(x) = \lim_{\varepsilon \rightarrow 0^+} \operatorname{Chi}(x + \varepsilon i)$$

for real  $x < 0$ .

$\operatorname{Ci}$  and  $\operatorname{Chi}$  are related by  $\operatorname{Ci}(x) - \ln(x) = \operatorname{Chi}(ix) - \ln(ix)$  for all  $x$  in the complex plane.

## References

- [1] Abramowitz, M. and I. Stegun, "Handbook of Mathematical Functions", Dover Publications Inc., New York (1965).

## See Also

### MuPAD Functions

`Chi` | `Ei` | `Shi` | `Si` | `Ssi` | `cos` | `int`



# Chi

Hyperbolic cosine integral function

## Syntax

Chi(x)

## Description

Chi(x) represents the hyperbolic cosine integral  $\text{EULER} + \ln(x) + \int_0^x \frac{\cosh(t) - 1}{t} dt$ .

If x is a floating-point number, then Chi(x) returns floating-point results. The special values  $\text{Chi}(\infty) = \infty$ ,  $\text{Chi}(-\infty) = \infty + i\pi$ ,  $\text{Chi}(i\infty) = i\pi/2$ , and  $\text{Chi}(-i\infty) = -i\pi/2$  are implemented. For all other arguments Chi returns symbolic function calls.

## Environment Interactions

When called with a floating-point argument, the functions are sensitive to the environment variable DIGITS which determines the numerical working precision.

## Examples

### Example 1

Most calls with exact arguments return themselves unevaluated:

`Chi(1)`, `Chi(sqrt(2))`, `Chi(x + 1)`, `Chi(I*infinity)`, `Chi(-I*infinity)`

$$\text{Chi}(1), \text{Chi}(\sqrt{2}), \text{Chi}(x+1), \frac{\pi i}{2}, -\frac{\pi i}{2}$$

To approximate exact results with floating-point numbers, use `float`:

```
float(Chi(1)), float(Chi(sqrt(2)))
```

```
0.837866941, 1.46735827
```

Alternatively, use a floating-point value as an argument:

```
Chi(1.0), Chi(2.0 + 10.0*I)
```

```
0.837866941, -0.229320148 + 1.848954746 i
```

## Example 2

`Chi` is singular at the origin:

```
Chi(0)
```

```
Error: Singularity. [Chi]
```

The negative real axis is a branch cut of `Chi`. A jump of height  $2\pi i$  occurs when crossing this cut:

```
Chi(-1.0), Chi(-1.0 + 10^(-10)*I), Chi(-1.0 - 10^(-10)*I)
```

```
0.837866941 + 3.141592654 i, 0.837866941 + 3.141592653 i, 0.837866941 - 3.141592653 i
```

## Example 3

`diff`, `float`, `series`, and other functions handle expressions involving `Chi`:

```
diff(Chi(x), x, x, x), float(ln(3 + Chi(sqrt(PI))))
```

```
 $\frac{\cosh(x)}{x} + \frac{2 \cosh(x)}{x^3} - \frac{2 \sinh(x)}{x^2}$ , 1.618452185
```

```
series(Chi(x), x = 0)
```

$$\text{EULER} + \ln(x) + \frac{x^2}{4} + \frac{x^4}{96} + O(x^6)$$

```
series(Chi(x), x = infinity, 3);
```

$$\frac{e^x}{2x} + \frac{e^x}{2x^2} + \frac{e^x}{x^3} + \frac{3e^x}{x^4} + O\left(\frac{e^x}{x^5}\right)$$

## Parameters

**x**

An arithmetical expression (Symbolic Math Toolbox)

## Return Values

Arithmetical expression.

## Overloaded By

x

## Algorithms

The functions  $\text{Ci}(x) - \ln(x)$  and  $\text{Chi}(x) - \ln(x)$  are entire functions. Thus,  $\text{Ci}$  and  $\text{Chi}$  have a logarithmic singularity at the origin and a branch cut along the negative real axis. The values on the negative real axis coincide with the limit “from above”:

$$\text{Ci}(x) = \lim_{\varepsilon \rightarrow 0^+} \text{Ci}(x + \varepsilon i), \quad \text{Chi}(x) = \lim_{\varepsilon \rightarrow 0^+} \text{Chi}(x + \varepsilon i)$$

for real  $x < 0$ .

$Ci$  and  $Chi$  are related by  $Ci(x) - \ln(x) = Chi(ix) - \ln(ix)$  for all  $x$  in the complex plane.

## References

[1] Abramowitz, M. and I. Stegun, "Handbook of Mathematical Functions", Dover Publications Inc., New York (1965).

## See Also

### MuPAD Functions

$Ci$  |  $Ei$  |  $Shi$  |  $Si$  |  $Ssi$  |  $\cos$  |  $\int$

# coeff

Coefficients of a polynomial

## Syntax

```
coeff(p, <All>)
```

```
coeff(p, <x>, n, <All>)
```

```
coeff(p, <[x, ...]>, [n, ...], <All>)
```

```
coeff(f, <vars>, <All>)
```

```
coeff(f, <vars>, <x>, n, <All>)
```

```
coeff(f, <vars>, <[x, ...]>, [n, ...], <All>)
```

## Description

`coeff(p)` returns a sequence of all nonzero coefficients of the polynomial `p`.

`coeff(p, x, n)` regards `p` as a univariate polynomial in `x` and returns the coefficient of the term  $x^n$ .

`coeff(p, [x, ...], [n, ...])` regards `p` as a multivariate polynomial in `x, ...` and returns the coefficient of the term  $x^n, \dots$

If the first argument `f` is not element of a polynomial domain, then `coeff` converts the expression internally to a polynomial of type `DOM_POLY` via `poly(f)`. If a list of indeterminates is specified, the polynomial `poly(f, vars)` is considered.

Coefficients of polynomial expressions `f` are returned as arithmetical expressions (Symbolic Math Toolbox).

There are various ways to call `coeff` with a polynomial `p` of type `DOM_POLY`:

- `coeff(p)` returns a sequence of all nonzero coefficients of `p`. They are ordered according to the lexicographical term ordering. The order is descending.

The returned coefficients are elements of the coefficient ring of  $p$ .

- `coeff(p, x, n)` regards  $p$  as a univariate polynomial in the variable  $x$  and returns the coefficient of the term  $x^n$ .

For univariate polynomials, the returned coefficients are elements of the coefficient ring of  $p$ .

For multivariate polynomials, the coefficients are returned as polynomials of type `DOM_POLY` in the “remaining” variables.

- `coeff(p, n)` is equivalent to `coeff(p, x, n)`, where  $x$  is the “main variable” of  $p$ . This variable is the first element of the list of indeterminates `op(p, 2)`.
- `coeff(p, [x1,x2,...], [n1,n2,...])` regards  $p$  as a multivariate polynomial in the variables  $x_1, x_2, \dots$  and returns the coefficient of the term  $x_1^{n_1} x_2^{n_2} \dots$ . Variable and exponent lists must have the same length.

The returned coefficients are either elements of the coefficient ring of  $p$  or polynomials of type `DOM_POLY` in the “remaining” variables.

- `coeff(p, [n1,n2,...])` is equivalent to `coeff(p, [x1,x2,...], [n1,n2,...])`, where the variables  $x_1, x_2, \dots$  are the “main variables” of  $p$ , i.e., the leading elements of the list of indeterminates `op(p, 2)`.
- `coeff(p, All)` returns a sequence of coefficients of  $p$  including those equal to zero. The function returns the result in ascending lexicographical order. For univariate polynomial  $p$ , the call `coeff(p, All)` is equivalent to `coeff(p, i) $ i = 0 .. degree(p)`.

`coeff` returns 0 or a zero polynomial if the polynomial does not contain a term corresponding to the specified powers. In particular, this happens for a univariate polynomial if  $n$  is larger than the degree of the polynomial.

`coeff` returns `FAIL` if an expression cannot be regarded as a polynomial.

The result of `coeff` is not fully evaluated. Evaluation can be enforced by the function `eval`. See “Example 5” on page 1-407 (Symbolic Math Toolbox).

## Examples

### Example 1

coeff(f) returns a sequence of all non-zero coefficients:

```
f := 10*x^10 + 5*x^5 + 2*x^2: coeff(f)
```

```
10, 5, 2
```

coeff(f, i) returns a single coefficient:

```
coeff(f, i) $ i = 0..15
```

```
0, 0, 2, 0, 0, 5, 0, 0, 0, 0, 10, 0, 0, 0, 0, 0
```

```
delete f:
```

### Example 2

We demonstrate how the indeterminates influence the result:

```
f := 3*x^3 + x^2*y^2 + 17*x + 23*y + 2
```

```
3 x^3 + x^2 y^2 + 17 x + 23 y + 2
```

```
coeff(f); coeff(f, [x, y]); coeff(f, [y, x])
```

```
3, 1, 17, 23, 2
```

```
3, 1, 17, 23, 2
```

```
1, 23, 3, 17, 2
```

```
delete f:
```

### Example 3

The coefficients of  $f$  are selected with respect to the main variable  $x$  which is the first entry of the list of indeterminates:

```
f := 3*x^3 + x^2*y^2 + 2: coeff(f, [x, y], i) $ i = 0..3
```

```
2, 0, y^2, 3
```

The coefficients of  $f$  can be selected with respect to another main variable (in this case,  $y$ ):

```
coeff(f, [y, x], i) $ i = 0..2
```

```
3 x^3 + 2, 0, x^2
```

Alternatively:

```
coeff(f, y, i) $ i = 0..2
```

```
3 x^3 + 2, 0, x^2
```

The coefficients of  $f$  can also be selected with respect to a multivariate term:

```
coeff(f, [x,y], [3,0]),  
coeff(f, [x,y], [2,2]),  
coeff(f, [x,y], [0,0])
```

```
3, 1, 2
```

```
delete f:
```

### Example 4

In the same way, `coeff` can be applied to polynomials of type `DOM_POLY`:

```
p := poly(3*x^3 + x, [x], Dom::IntegerMod(7)):  
coeff(p)
```



3 mod 7, 1 mod 7

```
coeff(p, i) $ i = 0..3
```

0 mod 7, 1 mod 7, 0 mod 7, 3 mod 7

For multivariate polynomials, the coefficients with respect to an indeterminate are polynomials in the other indeterminates:

```
p := poly(3*x^3 + x^2*y^2 + 2, [x, y]):
coeff(p, y, 0), coeff(p, y, 1), coeff(p, y, 2);
```

poly(3 x<sup>3</sup> + 2, [x]), poly(0, [x]), poly(x<sup>2</sup>, [x])

```
coeff(p, x, 0), coeff(p, x, 1), coeff(p, x, 2)
```

poly(2, [y]), poly(0, [y]), poly(y<sup>2</sup>, [y])

Note that the indeterminates passed to `coeff` will be used, even if the polynomial provides different indeterminates :

```
coeff(p, z, 0), coeff(p, z, 1), coeff(p, z, 2)
```

poly(3 x<sup>3</sup> + x<sup>2</sup> y<sup>2</sup> + 2, [x, y]), poly(0, [x, y]), poly(0, [x, y])

```
delete p:
```

## Example 5

The result of `coeff` is not fully evaluated:

```
p := poly(27*x^2 + a*x, [x]): a := 5:
coeff(p, x, 1), eval(coeff(p, x, 1))
```

a, 5

```
delete p, a:
```

## Example 6

To return all coefficients of a polynomial, use the `All` option:

```
p := poly(a*x^3 + b*x^2 + c*x + d, [x, y]):  
coefficients := coeff(p, All)
```

*d, c, b, a*

To revert the order of the resulting sequence, use the `revert` function. This function does not operate on sequences. To convert a sequence to a list, call `revert` for this list, and convert the result back to a sequence:

```
op(revert([coefficients]))
```

*a, b, c, d*

The `All` option also works for polynomial expressions:

```
p_expr := 2*x^5 + 5*x^2 + 10*x + 3:  
coeff(p_expr, All)
```

*3, 10, 5, 0, 0, 2*

You can use the `coeff` function with the `All` option to compute scalar products of polynomials. For example, the following procedure computes a scalar product of two polynomials in an orthonormal basis. The `coeff` function extracts the coefficients of the polynomials and returns two lists of coefficients. The `zip` function multiplies the entries of these lists pairwise and returns a list. The `op` function accesses the entries of that list. Finally, the `_plus` function computes the sum of all products:

```
scalarProduct := proc(p, q)  
  local lp, lq;  
begin  
  lp := [coeff(p, All)];  
  lq := [coeff(conjugate(q), All)];  
  _plus(op(zip(lp, lq, _mult)));  
end_proc;
```

The following polynomials are orthogonal:

```
scalarProduct(poly(x^2 + 2), poly(x^3 + 2*x^2 - 1))
```

0

## Example 7

`coeff(p, All)` also works for multivariate polynomials and polynomial expressions:

```
p := poly(2*x^2*y + PI*x + y^2 - 2, [x, y]):
coeff(p, All)
```

-2, 0, 1,  $\pi$ , 0, 0, 0, 2, 0

For a multivariate polynomial or polynomial expression, the order in which `coeff` returns the coefficients is such that the coefficient of the exponent vector  $[e_1, e_2, \dots]$  appears at position  $e_1 d_1 + e_2 d_2 + \dots + 1$ . For example, represent the coefficients returned for bivariate polynomial as a matrix:

```
A := matrix(degree(p, x) + 1, degree(p, y) + 1, [coeff(p, All)])
```

$$\begin{pmatrix} -2 & 0 & 1 \\ \pi & 0 & 0 \\ 0 & 2 & 0 \end{pmatrix}$$

## Parameters

**p**

A polynomial (Symbolic Math Toolbox) of type `DOM_POLY`

**x**

An indeterminate

**n**

A power: a nonnegative integer

**f**

A polynomial expression (Symbolic Math Toolbox)

**vars**

A list on page 7-41 of indeterminates of the polynomial: typically, identifiers on page 7-29 or indexed identifiers on page 1-1017

## Options

**ALL**

The `coeff` function with this option returns all the coefficients of a polynomial or a polynomial expression including those equal to zero. The function returns the result in ascending lexicographical order. See “Example 6” on page 1-408 (Symbolic Math Toolbox) and “Example 7” on page 1-409 (Symbolic Math Toolbox).

## Return Values

One or more coefficients of the coefficient ring on page 1-1601 of the polynomial, or a polynomial, or FAIL.

## Overloaded By

f, p

## See Also

### MuPAD Functions

[collect](#) | [content](#) | [degree](#) | [degreevec](#) | [ground](#) | [icontent](#) | [lcoeff](#) | [ldegree](#) | [lmonomial](#) | [lterm](#) | [monomials](#) | [nterms](#) | [nthcoeff](#) | [nthmonomial](#) | [nthterm](#) | [poly](#) | [poly2list](#) | [tcoeff](#)

## coerce

Type conversion

### Syntax

`coerce(object, T)`

### Description

`coerce(object, T)` tries to convert `object` into an element of the domain `T`.

If this is not possible or not implemented, then `FAIL` is returned.

Domains (Symbolic Math Toolbox) usually implement the two methods "`convert`" and "`convert_to`" for conversion tasks.

`coerce` uses these methods in the following way: It first calls `T::convert(object)` to perform the conversion. If this call yields `FAIL`, then the result of the call `object::dom::convert_to(object, T)` is returned, which again may be the value `FAIL`.

To find out the possible conversions for the `object` or which conversions are provided by the domain `T`, please read the description of the method "`coerce`" or "`convert`", respectively, that can be found on the help page of the domain `T`, and the description of the method "`convert_to`" on the help page of the domain of `object`.

Only few basic domains (Symbolic Math Toolbox) currently implement the methods "`convert`" and "`convert_to`".

Use the function `expr` to convert an object into an element of a basic domain.

Note that often a conversion can also be achieved by a call of the constructor of the domain `T`. See "Example 3" on page 1-415 (Symbolic Math Toolbox).

## Examples

### Example 1

We start with the conversion of an array into a list of domain type DOM\_LIST:

```
a := array(1..2, 1..3, [[1, 2, 3], [4, 5, 6]])
```

$$\begin{pmatrix} 1 & 2 & 3 \\ 4 & 5 & 6 \end{pmatrix}$$

```
coerce(a, DOM_LIST)
```

$$[1, 2, 3, 4, 5, 6]$$

We convert the array into an harray of type DOM\_HFARRAY:

```
coerce(a, DOM_HFARRAY)
```

$$\begin{pmatrix} 1.0 & 2.0 & 3.0 \\ 4.0 & 5.0 & 6.0 \end{pmatrix}$$

The conversion of an array into a polynomial is not implemented, and thus `coerce` returns FAIL:

```
coerce(a, DOM_POLY)
```

$$\text{FAIL}$$

One can convert a one- or two-dimensional array into a matrix on page 1-2045 (Symbolic Math Toolbox), and vice versa. An example:

```
A := coerce(a, matrix); domtype(A)
```

$$\begin{pmatrix} 1 & 2 & 3 \\ 4 & 5 & 6 \end{pmatrix}$$

`Dom::Matrix()`

The conversion of a matrix into a list is also possible. The result is then a list of inner lists, where the inner lists represent the rows of the matrix:

```
coerce(A, DOM_LIST)
```

`[[1, 2, 3], [4, 5, 6]]`

```
coerce([1, 2, 3, 2], DOM_SET)
```

`{1, 2, 3}`

Any MuPAD object can be converted into a string on page 7-53, such as the arithmetical expression  $2*x + \sin(x^2)$ :

```
coerce(2*x + sin(x^2), DOM_STRING)
```

`"2*x + sin(x^2)"`

## Example 2

The function `factor` computes a factorization of a polynomial expression and returns an object of the library domain `Factored`:

```
f := factor(x^2 + 2*x + 1);  
domtype(f)
```

`(x + 1)2`

`Factored`

This domain implements the conversion routine `"convert_to"`, which we can call directly to convert the factorization into a list (see `factor` for details):

```
Factored::convert_to(f, DOM_LIST)
```



$$[1, x + 1, 2]$$

However, it is more convenient to use `coerce`, which internally calls the slot routine `Factored::convert_to`:

```
coerce(f, DOM_LIST)
```

$$[1, x + 1, 2]$$

### Example 3

Note that often a conversion can also be achieved by a call of the constructor of a domain `T`. For example, the following call converts an array into a matrix of the domain type `Dom::Matrix(Dom::Rational)`:

```
a := array(1..2, 1..2, [[1, 2], [3, 4]]):
MatQ := Dom::Matrix(Dom::Rational):
```

```
MatQ(a)
```

$$\begin{pmatrix} 1 & 2 \\ 3 & 4 \end{pmatrix}$$

The call `MatQ(a)` implies the call of the method "new" of the domain `MatQ`, which in fact calls the method "convert" of the domain `MatQ` to convert the array into a matrix.

Here, the same can be achieved with the use of `coerce`:

```
A := coerce(a, MatQ):
domtype(A)
```

$$\begin{pmatrix} 1 & 2 \\ 3 & 4 \end{pmatrix}$$

$$\text{Dom::Matrix(Dom::Rational)}$$

Note that the constructor of a domain `T` is supposed to *create* objects, not to convert objects of other domains into the domain type `T`. The constructor often allows more than

one argument which allows to implement various user-friendly ways to create the objects (e.g., see the several possibilities for creating matrices offered by `matrix`).

## Parameters

### **object**

Any object

### **T**

Any domain (Symbolic Math Toolbox)

## Return Values

Object of the domain (Symbolic Math Toolbox) `T`, or the value `FAIL`.

## Overloaded By

`T`

## See Also

### **MuPAD Functions**

`domtype` | `expr` | `testtype` | `type`

# collect

Collect terms with the same powers

## Syntax

`collect(p, g, <f>)`

`collect(p, [g1, g2, ...], <f>)`

## Description

`collect(p, g)` groups terms with the same powers of  $g$  in an expression  $p$ .

`collect(p, [g1, g2, ...])` groups terms with the same powers of  $g_1, g_2, \dots$  in a multivariate expression  $p$ .

If you pass a function name  $f$  as a third argument to `collect`, the procedure collects the powers of  $g$  ( $g_1, g_2, \dots$  for multivariate expression). Then it applies the function  $f$  to the coefficients.

`collect(p, g)` presents  $p$  as a sum  $\sum_{i=0}^n a_i g^i$ . The coefficients  $a_i$  are not polynomials in  $g$ . These coefficients can contain some terms with  $g$ , for example,  $\sin(g)$  or  $e^g$ .

`collect` returns a modified copy of a polynomial. The function does not change the polynomial itself. See "Example 1" on page 1-418 (Symbolic Math Toolbox).

If  $p$  is a rational expression in  $g$ , `collect` handles the numerator and denominator separately.

If  $p$  is a multivariate expression, `collect(p, [g1, g2, ...])` returns an expression in the following form:

$$\sum_{i_1 i_2 \dots} \left( a_{i_1, i_2, \dots} g_1^{i_1} g_2^{i_2} \dots \right)$$

The coefficients  $a_{i_1, i_2, \dots}$  are not polynomials in  $g$ . These coefficients can contain some terms with  $g_1, g_2, \dots$ , for example,  $\sin(g_1)e^{g_2}$ .

If  $p$  is a rational expression in  $g_1, g_2, \dots$ , the `collect` command handles the numerator and denominator separately.

For polynomial expressions, `collect` internally calls two functions: `poly` and then `expr`. The function `poly` converts an expression  $p$  into a polynomial on page 1-1601 in the given unknowns. This function returns a polynomial with the terms collected by the same powers. Then `expr` converts this polynomial into a polynomial expression. See `poly` for more information and examples. When applied to a rational expression, `collect` handles the numerator and denominator separately.

You can use arbitrary expressions as indeterminates. See “Example 2” on page 1-419 (Symbolic Math Toolbox).

You can specify a function name instead of a variable. In this case, `collect` treats all calls of the function with different arguments as different variables. See “Example 4” on page 1-420 (Symbolic Math Toolbox).

`collect` does not recursively collect the operands of nonpolynomial subexpressions of  $p$ . See “Example 2” on page 1-419 (Symbolic Math Toolbox).

If  $p$  is not a polynomial expression, `collect` can return the unchanged expression  $p$ . See “Example 5” on page 1-421 (Symbolic Math Toolbox).

## Examples

### Example 1

You can define a polynomial expression  $p$  and collect terms with the same powers of  $x$  and  $y$ :

```
p := x*y + z*x*y + y*x^2 - z*y*x^2 + x + z*x;  
collect(p, [x, y])
```

$$x + x y + x z + x^2 y - x^2 y z + x y z$$

$$(1 - z) x^2 y + (z + 1) x y + (z + 1) x$$

`collect` does not modify the original expression:

`p`

$$x + x y + x z + x^2 y - x^2 y z + x y z$$

You can collect terms with same powers of `x`:

`collect(p, [x])`

$$(y - y z) x^2 + (y + z + y z + 1) x$$

If an expression contains only one indeterminate, you can omit the square brackets in the second argument of the function call:

`collect(p, x)`

$$(y - y z) x^2 + (y + z + y z + 1) x$$

To factor coefficients in a resulting expression, pass `factor` as a third argument to `collect`:

`collect(p, x, factor)`

$$-(y(z - 1)) x^2 + ((z + 1)(y + 1)) x$$

## Example 2

`collect` does not modify nonpolynomial subexpressions even if they contain a given indeterminate. In particular, `collect` does not recursively handle the operands of a nonpolynomial subexpression:

`collect(sin((x + 1)^2)*(x + 1) + 5*sin((x + 1)^2) + x, x)`

$$(\sin((x+1)^2) + 1)x + 6 \sin((x+1)^2)$$

`collect` accepts nonpolynomial subexpressions as indeterminates:

```
collect(sin((x + 1)^2)*(x + 1) + 5*sin((x + 1)^2) + x,  
        sin((x + 1)^2))
```

$$(x+6) \sin((x+1)^2) + x$$

### Example 3

`collect` normalizes a rational expression, and then handles the numerator and denominator separately:

```
collect(z/(x+y) + 3*z/(x+z), z)
```

$$\frac{z^2 + (4x + 3y)z}{(x+y)z + x^2 + yx}$$

### Example 4

If you specify the name of a function as an indeterminate, `collect` handles functions calls with different arguments as different indeterminates:

```
collect(a*f(1) + c*f(1) + f(2) + d*f(2), f)
```

$$(a+c) f(1) + (d+1) f(2)$$

```
collect(a*sin(x) + b*sin(x) + c*sin(y) + d*sin(y), sin)
```

$$(a+b) \sin(x) + (c+d) \sin(y)$$

```
p:= diff(besselJ(0, x), x $ 4);  
collect(p, besselJ);  
collect(p, besselJ, expand);
```

$$\frac{2 J_1(x)}{x^3} - \frac{J_1(x)}{x} + \frac{\frac{J_1(x)}{x^2} - J_1(x) + \frac{J_1(x) - J_0(x)}{x}}{x} + J_0(x) + \frac{2 \left( \frac{J_1(x)}{x} - J_0(x) \right)}{x^2}$$

$$\left( 1 - \frac{3}{x^2} \right) J_0(x) + \left( \frac{\frac{2}{x^2} - 1}{x} - \frac{1}{x} + \frac{4}{x^3} \right) J_1(x)$$

$$\left( 1 - \frac{3}{x^2} \right) J_0(x) + \left( \frac{6}{x^3} - \frac{2}{x} \right) J_1(x)$$

### Example 5

If  $p$  is not a polynomial expression, `collect` can return the unchanged expression  $p$ :

```
p := y^2*sin(x) + y*sin(x) + y^2*cos(x) + y*cos(x);
collect(p, x)
```

$$y^2 \cos(x) + y^2 \sin(x) + y \cos(x) + y \sin(x)$$

$$y^2 \cos(x) + y^2 \sin(x) + y \cos(x) + y \sin(x)$$

The expression  $p$  is a polynomial expression in  $y$ . You can group the terms with the same powers in this variable:

```
collect(p, y)
```

$$(\cos(x) + \sin(x)) y^2 + (\cos(x) + \sin(x)) y$$

## Parameters

**p**

An arithmetical expression (Symbolic Math Toolbox).

**x, x1, x2, ...**

The indeterminates: typically, identifiers on page 7-29 or indexed identifiers.

**f**

A function (Symbolic Math Toolbox).

## Return Values

arithmetical expression (Symbolic Math Toolbox).

## Overloaded By

**p**

## See Also

### **MuPAD Functions**

`coeff` | `combine` | `expand` | `factor` | `indets` | `normal` | `poly` | `rectform` | `rewrite` | `simplify`

### **Topics**

“Manipulate Expressions” (Symbolic Math Toolbox)

“Choose Simplification Functions” (Symbolic Math Toolbox)



# combine

Combine terms of same algebraic structure

## Syntax

```
combine(f, <IgnoreAnalyticConstraints>)
```

```
combine(f, target, <IgnoreAnalyticConstraints>)
```

```
combine(f, [target1, target2, ...], <IgnoreAnalyticConstraints>)
```

## Description

`combine(f)` rewrites products of powers in the expression `f` as a single power.

`combine(f, target)` combines several calls to the target function(s) in the expression `f` to a single call.

`combine(f)` applies these rewriting rules to products of powers occurring as subexpressions in an arithmetical expression (Symbolic Math Toolbox) `f`:

- $x^a x^b = x^{a+b}$ ,
- $x^b y^b = (xy)^b$ ,
- $(x^a)^b = x^{ab}$ .

The last two rules are only valid under certain additional restrictions, such as when  $b$  is an integer. Except for the third rule, this behavior of `combine` is the inverse functionality of `expand`. See “Example 1” on page 1-426 (Symbolic Math Toolbox).

---

**Note** In certain cases, the MuPAD internal simplifier automatically applies these rules in the reverse direction, and `combine` sometimes has no effect. See “Example 2” on page 1-427 (Symbolic Math Toolbox).

---

`combine(f, target)` applies rewriting rules applicable to the target function(s) to an arithmetical expression (Symbolic Math Toolbox) `f`. Some of the rules are only valid under certain additional restrictions. For most of the rules, `combine` implements the inverse functionality of `expand`. This list shows the rewriting rules for the targets.

- `target = arctan`:

$$\arctan(x) + \arctan(y) = \arctan\left(\frac{x+y}{1-xy}\right)$$

for  $-1 < x < 1$  and  $-1 < y < 1$ .

- `target = exp` (see “Example 4” on page 1-428 (Symbolic Math Toolbox)):

- $e^a e^b = e^{a+b}$ ,
- $(e^a)^b = e^{ab}$ ,

where valid, reacting to properties.

- `target = int` (see “Example 5” on page 1-428 (Symbolic Math Toolbox)):

- $a \int f(x) dx = \int af(x) dx.$
- $\int f(x) dx + \int g(x) dx = \int f(x) + g(x) dx.$
- $\int_a^b f(x) dx + \int_a^b g(x) dx = \int_a^b f(x) + g(x) dx.$
- $\int_a^b f(x) dx + \int_a^b g(y) dy = \int_a^b f(y) + g(y) dy.$
- $\int_a^b yf(x) dx + \int_a^b xg(y) dy = \int_a^b yf(c) + xf(c) dc.$

- `target = gamma` (see “Example 6” on page 1-429 (Symbolic Math Toolbox)):

- $a \Gamma(a) = \Gamma(a+1)$ ,

- $\frac{\Gamma(a+1)}{\Gamma(a)} = a$ ,
- $\Gamma(1-a)\Gamma(a) = \frac{\pi}{\sin(\pi a)}$ ,
- $\Gamma(-a)\Gamma(a) = -\frac{\pi}{a \sin(\pi a)}$ ,
- $\Gamma(a+n)\Gamma(a) = \Gamma(a)^2 \left( \prod_{i=0}^{n-1} (a+i) \right)$ ,

for positive integers n.

- `target = ln` (see “Example 7” on page 1-429 (Symbolic Math Toolbox)):

- $\ln(a) + \ln(b) = \ln(ab)$ ,
- $b \ln(a) = \ln(a^b)$ ,

if  $b$  is less than  $N$ . By default,  $N = 1000$ . You can change the number  $N$  using the `Pref:autoExpansionLimit` command. See “Example 8” on page 1-429 (Symbolic Math Toolbox).

The rules do not hold for arbitrary complex values of  $a$ ,  $b$ . Specify appropriate properties on page 1-265 for  $a$  or  $b$  to enable these rewriting rules. These rules are only applied to *natural* logarithms.

- `target = sincos` (see “Example 3” on page 1-427 (Symbolic Math Toolbox)):

- $\sin(x) \sin(y) = \frac{\cos(x-y)}{2} - \frac{\cos(x+y)}{2}$ ,

where similar rules apply to  $\sin(x) \cos(y)$  and  $\cos(x) \cos(y)$ :

- $A \cos(x) + B \sin(x) = A \sqrt{1 + \frac{B^2}{A^2}} \cos\left(x + \arctan\left(-\frac{B}{A}\right)\right)$ .

- `target = sinhcosh:`

- $$\sinh(x) \sinh(y) = \frac{\cosh(x+y)}{2} - \frac{\cosh(x-y)}{2}$$

where similar rules apply to  $\sinh(x) \cosh(y)$  and  $\cosh(x) \cosh(y)$ .

- These rules apply recursively to powers of  $\sinh$  and  $\cosh$  with positive integral exponents.

`combine` works recursively on the subexpressions of `f`.

If the second argument is a list of targets, then `combine` is applied to `f` subsequently for each of the targets in the list. See “Example 10” on page 1-431 (Symbolic Math Toolbox).

If `f` is an array on page 7-2, a list on page 7-41, or a set on page 7-50, `combine` is applied to all entries of `f`. See “Example 11” on page 1-431 (Symbolic Math Toolbox). If `f` is a polynomial (Symbolic Math Toolbox) or a series expansion, of type `Series::Puisseux` or `Series::gseries`, `combine` is applied to each coefficient. See “Example 12” on page 1-431 (Symbolic Math Toolbox).

## Environment Interactions

`combine` reacts to properties of identifiers appearing in the input.

## Examples

### Example 1

Combine powers of the same base using `combine`.

```
combine(sin(x) + x*y*x^(exp(1)))
```

$$\sin(x) + x^{e+1} y$$

`combine` also combines powers with the same exponent in certain cases:

```
combine(sqrt(2)*sqrt(3))
```

$$\sqrt{6}$$

## Example 2

In most cases, however, `combine` does not combine powers with the same exponent:

```
combine(y^5*x^5)
```

$$x^5 y^5$$

## Example 3

Rewrite products of sines and cosines as a sum of sines and cosines by setting the second argument to `sincos`:

```
combine(sin(a)*cos(b) + sin(b)^2, sincos)
```

$$\frac{\sin(a+b)}{2} - \frac{\cos(2b)}{2} + \frac{\sin(a-b)}{2} + \frac{1}{2}$$

Rewrite sums of sines and cosines by setting the second argument to `sincos`:

```
combine(cos(a) + sin(a), sincos)
```

$$\sqrt{2} \cos\left(a - \frac{\pi}{4}\right)$$

Powers of sines or cosines with negative integer exponents are not rewritten:

```
combine(sin(b)^(-2), sincos)
```

$$\frac{1}{\sin(b)^2}$$

### Example 4

Combine terms with the exponential function by specifying the second argument as `exp`.

```
combine(exp(3)*exp(2), exp)
```

$$e^5$$

```
combine(exp(a)^2, exp)
```

$$e^{2a}$$

### Example 5

Rewrite integrals by setting the second argument to `int`.

```
combine(int(f(x),x)+int(g(x),x),int)
```

$$\int (f(x) + g(x)) \, dx$$

`combine` combines a constant term with the integral.

```
combine(a*int(f(x),x),int)
```

$$\int a f(x) \, dx$$

`combine` combines integrals with the same limits.

```
combine(int(f(x),x=a..b)+int(g(y),y=a..b),int)
```

$$\int_a^b (f(x) + g(x)) \, dx$$

## Example 6

Combine calls to `gamma` by specifying the target as `gamma`. The `combine` function simplifies quotients of gammas to rational expressions.

```
combine(gamma(n+3)*gamma(n+4/3) / gamma(n+1) / gamma(n+10/3), gamma)
```

$$\frac{n^2 + 3n + 2}{n^2 + \frac{11n}{3} + \frac{28}{9}}$$

## Example 7

This example shows the application of rules for the logarithm, and their dependence on properties of the identifiers appearing in the input. In the complex plane, the logarithm of a product does not always equal the sum of the logarithms of its factors. For real positive numbers, however, this rule can apply.

Try to combine terms with calls to `ln` by specifying the target as `ln`.

```
combine(ln(a) + ln(b), ln)
```

$$\ln(a) + \ln(b)$$

`combine` does not combine the terms. Set the appropriate assumptions to combine the terms.

```
assume(a > 0): assume(b > 0):
combine(ln(a) + ln(b), ln)
```

$$\ln(a b)$$

```
unassume(a): unassume(b):
```

## Example 8

If  $a$  and  $b$  are integer or rational numbers and  $b$  is less than 1000, `combine` returns logarithms.

```
combine(3*ln(2), ln)
```

$\ln(8)$

If  $b$  is greater than or equal to 1000, combine returns results as  $b \ln(a)$ :

```
combine(1234*ln(5), ln)
```

$1234 \ln(5)$

You can change the limit on the number  $b$  by using the `Pref::autoExpansionLimit` function. For example, when you use the default value  $N = 1000$ , combine returns the following result for this logarithm:

```
combine(12*ln(12), ln)
```

$\ln(8916100448256)$

If you set the value of `Pref::autoExpansionLimit` to 10, combine returns this logarithm in its original form:

```
Pref::autoExpansionLimit(10):  
combine(12*ln(12), ln)
```

$12 \ln(12)$

For further computations, restore the default value of `Pref::autoExpansionLimit`:

```
Pref::autoExpansionLimit(NIL):
```

## Example 9

The `IgnoreAnalyticConstraints` option applies a set of purely algebraic simplifications including the equality of sum of logarithms and a logarithm of a product. Using the `IgnoreAnalyticConstraints` option, you get a simpler result, but one that might be incorrect for some of the values of  $a$ .

Combine logarithms using the `IgnoreAnalyticConstraints` option.



```
combine(ln(a^5) - ln(a^4), ln, IgnoreAnalyticConstraints)
```

$$\ln(a)$$

Without using this option, you get a mathematically correct, but long result:

```
combine(ln(a^5) - ln(a^4), ln)
```

$$\ln(a^5) - \ln(a^4)$$

### Example 10

The second argument also can be a list of targets. Then the rewriting rules for each of the targets in the list are applied.

Rewrite `ln` and `sincos` terms in the expression.

```
combine(ln(2) + ln(3) + sin(a)*cos(a), [ln, sincos])
```

$$\frac{\sin(2 a)}{2} + \ln(6)$$

### Example 11

`combine` maps to sets:

```
combine({sqrt(2)*sqrt(5), sqrt(2)*sqrt(11)})
```

$$\{\sqrt{10}, \sqrt{22}\}$$

### Example 12

`combine` maps to the coefficients of polynomials:

```
combine(poly(sin(x)*cos(x)*y, [y]), sincos)
```

$$\text{poly}\left(\frac{\sin(2x)}{2}, y, [y]\right)$$

However, it does not touch the polynomial's indeterminates:

```
combine(poly(sin(x)*cos(x)), sincos)
```

$$\text{poly}(\cos(x) \sin(x), [\cos(x), \sin(x)])$$

## Parameters

**f**

An arithmetical expression (Symbolic Math Toolbox), an array on page 7-2, a list on page 7-41, a polynomial (Symbolic Math Toolbox), or a set on page 7-50

**target**

One of the identifiers: arctan, exp, int, gamma, ln, sincos, or sinhcos

## Options

**IgnoreAnalyticConstraints**

Apply purely algebraic simplifications to an expression. For more information see the options for the Simplify command.

## Return Values

Object of the same type as the input object f.

## Overloaded By

f

## Algorithms

Advanced users can extend the functionality of `combine` by implementing additional rewriting rules for other target functions. To extend functionality, define a new slot `target` of `combine`. To define a new slot, you need to first unprotect the identifier `combine` using `unprotect` on page 1-2213. Afterwards, the command `combine(f, target)` leads to the call `combine::target(f)` of the corresponding slot routine.

By default, `combine` handles a subexpression  $g(x_1, x_2, \dots)$  of  $f$  by calling itself recursively for the operands  $x_1, x_2$ , etc. Users can change this behavior for their own mathematical function given by a function environment on page 7-25  $g$  by implementing a `combine` slot of  $g$ . To handle the subexpression  $g(x_1, x_2, \dots)$ , `combine` then calls the slot routine `g::combine` with the argument sequence  $x_1, x_2, \dots$  of  $g$ .

## See Also

### MuPAD Functions

`denom` | `expand` | `factor` | `normal` | `numer` | `radsimp` | `rectform` | `rewrite` | `simplify`

## Topics

“Manipulate Expressions” (Symbolic Math Toolbox)

“Choose Simplification Functions” (Symbolic Math Toolbox)

**Introduced in R2007b**

# complexInfinity

Complex infinity

## Syntax

`complexInfinity`

## Description

`complexInfinity` represents the only non-complex point of the one-point compactification of the complex numbers.

Mathematically, `complexInfinity` is the north pole of the Riemann sphere, with the unit circle as equator and the point 0 at the south pole.

With respect to arithmetic, `complexInfinity` behaves like “ $1/0$ ”. In particular, non-zero complex numbers may be multiplied or divided by `complexInfinity` or  $1/\text{complexInfinity}$ . Adding `complexInfinity` to a finite number yields again `complexInfinity`.

With respect to arithmetical operations, `complexInfinity` is incompatible with the real infinity.

## Examples

### Example 1

`complexInfinity` can be used in arithmetical operations with complex numbers. The result in multiplications or divisions is either `complexInfinity`, `0`, or `undefined`:

```
3*complexInfinity, I*complexInfinity, 0*complexInfinity;  
3/complexInfinity, I/complexInfinity, 0/complexInfinity;  
complexInfinity/3, complexInfinity/I;  
complexInfinity*complexInfinity, complexInfinity/complexInfinity;
```

complexInfinity, complexInfinity, undefined

0, 0, 0

complexInfinity, complexInfinity

complexInfinity, undefined

The result in additions is undefined if one of the operands is infinite, and complexInfinity otherwise:

```
complexInfinity + complexInfinity, infinity + complexInfinity;
3 + complexInfinity, I + complexInfinity, PI + complexInfinity
```

undefined, undefined

complexInfinity, complexInfinity, complexInfinity

Symbolic expressions in arithmetical operations involving complexInfinity are implicitly assumed to be different from both 0 and complexInfinity:

```
delete x:
x*complexInfinity, x/complexInfinity, complexInfinity/x,
x + complexInfinity
```

complexInfinity, 0, complexInfinity, complexInfinity

## Algorithms

complexInfinity is the only element of the domain (Symbolic Math Toolbox) `stdlib::CInfinity`.

## See Also

### **MuPAD Functions**

infinity

# conjugate

Complex conjugation

## Syntax

`conjugate(z)`

`conjugate(L)`

## Description

`conjugate(z)` computes the conjugate  $\mathcal{H}(z) - i\mathcal{I}(z)$  of a complex number  $z = \mathcal{H}(z) + i\mathcal{I}(z)$ .

For numbers (Symbolic Math Toolbox) of type `DOM_INT`, `DOM_RAT`, `DOM_FLOAT`, or `DOM_COMPLEX`, the conjugate is computed directly and very efficiently.

`conjugate` can handle symbolic expressions. Properties (Symbolic Math Toolbox) of identifiers are taken into account (see `assume`). An identifier `z` without any property is assumed to be complex, and the symbolic call `conjugate(z)` is returned. See “Example 2” on page 1-438 (Symbolic Math Toolbox).

`conjugate` knows how to handle special mathematical functions, such as:

<code>_mult</code>	<code>_plus</code>	<code>_power</code>	<code>abs</code>	<code>cos</code>	<code>cosh</code>	<code>cot</code>
<code>coth</code>	<code>csc</code>	<code>csch</code>	<code>erf</code>	<code>erfc</code>	<code>exp</code>	<code>gamma</code>
<code>igamma</code>	<code>sec</code>	<code>sech</code>	<code>sin</code>	<code>sinh</code>	<code>tan</code>	<code>tanh</code>

See “Example 1” on page 1-438 (Symbolic Math Toolbox).

If `conjugate` does not know how to handle a special mathematical function, then a symbolic `conjugate` call is returned. See “Example 3” on page 1-438 (Symbolic Math Toolbox).

This function is automatically mapped to all entries of container objects such as arrays, lists, matrices, polynomials, sets, and tables.

## Environment Interactions

`conjugate` is sensitive to properties (Symbolic Math Toolbox) of identifiers set via `assume`.

### Examples

#### Example 1

`conjugate` knows how to handle sums, products, the exponential function and the sine function:

```
conjugate((1 + I)*exp(2 - 3*I))
```

$$e^{2+3i} (1 - i)$$

```
delete z: conjugate(z + 2*sin(3 - 5*I))
```

$$2 \sin(3 + 5 i) + \bar{z}$$

#### Example 2

`conjugate` reacts to properties of identifiers:

```
delete x, y: assume(x, Type::Real):  
conjugate(x), conjugate(y)
```

$$x, \bar{y}$$

#### Example 3

If the input contains a function that the system does not know, then a symbolic `conjugate` call is returned:

```
delete f, z: conjugate(f(z) + I)
```



$$\overline{f(z)} - i$$

Now suppose that  $f$  is some user-defined mathematical function, and that  $\overline{f(z)} = f(\overline{z})$  holds for all complex numbers  $z$ . To extend the functionality of `conjugate` to  $f$ , we embed it into a function environment on page 7-25 and suitably define its "conjugate" slot:

```
f := funcenv(f):
f::conjugate := u -> f(conjugate(u)):
```

Now, whenever `conjugate` is called with an argument of the form  $f(u)$ , it calls `f::conjugate(u)`, which in turn returns  $f(\text{conjugate}(u))$ :

```
conjugate(f(z) + I), conjugate(f(I))
```

$$f(\overline{z}) - i, f(-i)$$

## Parameters

**z**

An arithmetical expression (Symbolic Math Toolbox)

**L**

A container object: an array on page 7-2, an `harray` on page 7-27, a list on page 7-41, a matrix on page 1-2045 (Symbolic Math Toolbox), a polynomial on page 1-1601, a set on page 7-50, or a table on page 1-2103.

## Return Values

arithmetical expression (Symbolic Math Toolbox) or a container object containing such expressions

## Overloaded By

z

## Algorithms

If a subexpression of the form  $f(u, \dots)$  occurs in  $z$  and  $f$  is a function environment on page 7-25, then `conjugate` attempts to call the slot "conjugate" of  $f$  to determine the conjugate of  $f(u, \dots)$ . In this way, you can extend the functionality of `conjugate` to your own special mathematical functions.

The slot "conjugate" is called with the arguments  $u, \dots$  of  $f$ .

If  $f$  has no slot "conjugate", then the subexpression  $f(u, \dots)$  is replaced by the symbolic call `conjugate(f(u, \dots))` in the returned expression.

See "Example 3" on page 1-438 (Symbolic Math Toolbox).

Similarly, if an element  $d$  of a library domain (Symbolic Math Toolbox) $T$  occurs as a subexpression of  $z$ , then `conjugate` attempts to call the slot "conjugate" of that domain with  $d$  as argument to compute the conjugate of  $d$ .

If  $T$  does not have a slot "conjugate", then  $d$  is replaced by the symbolic call `conjugate(d)` in the returned expression.

## See Also

### MuPAD Functions

`Im` | `Re` | `abs` | `assume` | `rectform` | `sign`

# contains

Test if an entry exists in a container

## Syntax

```
contains(s, object)
```

```
contains(l, object, <i>)
```

```
contains(t, object)
```

## Description

`contains(s, object)` tests if `object` is an element of the set `s`.

`contains(l, object)` returns the index of `object` in the list `l`.

`contains(t, object)` tests if the array, table, or domain `t` has an entry corresponding to the index `object`.

`contains` is a fast membership test for the MuPAD basic container data types. For lists on page 7-41 and sets on page 7-50, `contains` searches the elements for the given `object`. However, for arrays on page 7-2, tables on page 1-2103, and domains (Symbolic Math Toolbox), `contains` searches the indices.

`contains` works syntactically, i.e., mathematically equivalent objects are considered to be equal only if they are syntactically identical. `contains` does *not* represent elementhood in the mathematical sense. See “Example 2” on page 1-442 (Symbolic Math Toolbox).

`contains` does not descend recursively into subexpressions; use `has` to achieve this. See “Example 3” on page 1-443 (Symbolic Math Toolbox).

`contains(s, object)` returns `TRUE` if `object` is an element of the set on page 7-50 `s`. Otherwise, it returns `FALSE`.

`contains(l, object)` returns the position of `object` in the list on page 7-41 `l` as a positive integer if `object` is an entry of `l`. Otherwise, the return value is `0`. If more than one entry of `l` is equal to `object`, then the index of the first occurrence is returned.

By passing a third argument `i` to `contains`, you can specify a position in the list where the search is to start. Then, entries with index less than `i` are not taken into account. If `i` is out of range, then the return value is `0`.

See “Example 4” on page 1-443 (Symbolic Math Toolbox) and “Example 5” on page 1-444 (Symbolic Math Toolbox).

`contains(t, object)` returns `TRUE` if the array on page 7-2, table on page 1-2103, or domain (Symbolic Math Toolbox) `t` has an entry corresponding to the index `object`. Otherwise, it returns `FALSE`. Cf. “Example 6” on page 1-444 (Symbolic Math Toolbox).

## Examples

### Example 1

`contains` may be used to test if a set on page 7-50 contains a given element:

```
contains({a, b, c}, a), contains({a, b, c}, 2)
```

`TRUE, FALSE`

### Example 2

`contains` works syntactically, i.e., mathematically equivalent objects are considered to be equal only if they are syntactically identical. In this example `contains` returns `FALSE` since  $y*(x + 1)$  and  $y*x + y$  are different representations of the same mathematical expression:

```
contains({y*(x + 1)}, y*x + y)
```

`FALSE`

Elementhood in the mathematical sense is represented by the operator `in`:

```
simplify(y*x + y in {y*(x+1)}, condition)
```

TRUE

### Example 3

contains does not descend recursively into the operands of its first argument. In the following example, c is not an element of the set, and therefore FALSE is returned:

```
contains({a, b, c + d}, c)
```

FALSE

If you want to test whether a given expression is contained *somewhere inside* a complex expression, please use has:

```
has({a, b, c + d}, c)
```

TRUE

### Example 4

contains applied to a list returns the position of the specified object in the list:

```
contains([a, b, c], b)
```

2

If the list does not contain the object, 0 is returned:

```
contains([a, b, c], d)
```

0

## Example 5

`contains` returns the position of the first occurrence of the given object in the list if it occurs more than once:

```
l := [a, b, a, b]: contains(l, b)
```

2

A starting position for the search may be given as optional third argument:

```
contains(l, b, 1), contains(l, b, 2),  
contains(l, b, 3), contains(l, b, 4)
```

2, 2, 4, 4

If the third argument is out of range, then the return value is 0:

```
contains(l, b, -1), contains(l, b, 0), contains(l, b, 5)
```

0, 0, 0

## Example 6

For tables on page 1-2103, `contains` returns TRUE if the second argument is a valid index in the table. The entries stored in the table are not considered:

```
t := table(13 = value): contains(t, 13), contains(t, value)
```

TRUE, FALSE

Similarly, `contains` tests if an array has a value for a given index. The array `a` has a value corresponding to the index (1, 1), but none for the index (1, 2):

```
a := array(1..3, 1..2, (1, 1) = x, (2, 1) = PI):  
contains(a, (1, 1)), contains(a, (1, 2))
```

TRUE, FALSE

contains is not intended for testing if an array contains a given value:

```
contains(a, PI)
```

```
Error: Index dimension does not match. [array]
```

Even if the dimensions match, the index must not be out of range:

```
contains(a, (4, 4))
```

```
Error: Invalid argument. [array]
```

## Example 7

contains may be used to test, whether a domain (Symbolic Math Toolbox) has the specified slot:

```
T := newDomain("T"): T::index := value:
contains(T, index), contains(T, value)
```

```
FALSE, FALSE
```

There is no entry corresponding to the slot `index` in `T`. Please keep in mind that the syntax `T::index` is equivalent to `slot(T, "index")`:

```
contains(T, "index")
```

```
TRUE
```

## Example 8

Users can overload (Symbolic Math Toolbox) `contains` for their own domains (Symbolic Math Toolbox). For illustration, we create a new domain `T` and supply it with an "contains" slot, which tests if the set of entries of an element contains the given value `idx`:

```
T := newDomain("T"):
T::contains := (e, idx) -> contains({extop(e)}, idx):
```

If we now call `contains` with an object of domain type `T`, the slot routine `T::contains` is invoked:

```
e := new(T, 1, 2): contains(e, 2), contains(e, 3)
```

```
TRUE, FALSE
```

## Parameters

**s**

A set on page 7-50

**l**

A list on page 7-41

**t**

An array on page 7-2 of type `DOM_ARRAY`, a table on page 1-2103, or a domain (Symbolic Math Toolbox)

**object**

An arbitrary MuPAD object

**i**

An integer on page 7-31

## Return Values

For sets, arrays, tables, or domains, `contains` returns one of the Boolean values `TRUE` or `FALSE`. For lists, the return value is a nonnegative integer on page 7-31.

## Overloaded By

`l`, `s`, `t`



## See Also

### MuPAD Functions

[\\_index](#) | [has](#) | [in](#) | [op](#) | [slot](#)

# content

Content of a polynomial

## Syntax

`content(p)`

`content(f, <vars>)`

## Description

`content(p)` computes the content of the polynomial `p` or polynomial expression, i.e., the greatest common divisor of its coefficients.

If `p` is the zero polynomial, then `content` returns 0.

If `p` is a non-zero polynomial on page 1-1601 with coefficient ring `IntMod(n)` and `n` is a prime number, then `content` returns 1. If `n` is not a prime number, an error message is issued.

If `p` is a polynomial on page 1-1601 with a library domain (Symbolic Math Toolbox) `R` as coefficient ring, the `gcd` of its coefficients is computed using the slot `gcd` of `R`. If no such slot exists, then `content` returns `FAIL`.

If `p` is a polynomial on page 1-1601 with coefficient ring `Expr`, then `content` does the following.

If all coefficients of `p` are either integers on page 7-31 or rational numbers on page 7-48, `content(p)` is equivalent to `gcd(coeff(p))`, and the return value is a positive integer or rational number. See “Example 1” on page 1-449 (Symbolic Math Toolbox).

If at least one coefficient is a floating point number on page 7-23 or a complex number on page 7-84 and all other coefficients are numbers (Symbolic Math Toolbox), then `content` returns 1. See “Example 2” on page 1-450 (Symbolic Math Toolbox).

If at least one coefficient is not a number (Symbolic Math Toolbox) and all coefficients of  $p$  can be converted into polynomials via `poly`, then `content(p)` is equivalent to `gcd(coeff(p))`. See “Example 3” on page 1-450 (Symbolic Math Toolbox).

Otherwise, `content` returns 1.

A polynomial expression (Symbolic Math Toolbox)  $f$  is converted into a polynomial (Symbolic Math Toolbox) with coefficient ring `Expr` via `p := poly(f, vars)`, and then `content` is applied to  $p$ . See “Example 1” on page 1-449 (Symbolic Math Toolbox).

Use `icontent` for polynomials that are known to have integer or rational coefficients, since it is much faster than `content`.

Dividing the coefficients of  $p$  by its `content` gives its primitive part. This one can also be obtained directly using `polylib::primpart`.

## Examples

### Example 1

If  $p$  is a polynomial with integer or rational coefficients, the result is the same as for `icontent`:

```
content(poly(6*x^3*y + 3*x*y + 9*y, [x, y]))
```

3

The following call, where the first argument is a polynomial expression and not a polynomial, is equivalent to the one above:

```
content(6*x^3*y + 3*x*y + 9*y, [x, y])
```

3

If no list of indeterminates is specified, then `poly` converts the expression into a polynomial with respect to all occurring indeterminates, and we obtain yet another equivalent call:

```
content(6*x^3*y + 3*x*y + 9*y)
```

3

Above, we considered the polynomial as a bivariate polynomial with integer coefficients. We can also consider the same expression as a univariate polynomial in  $x$ , whose coefficients contain a parameter  $y$ . Then the coefficients and their gcd—the content—are polynomial expressions in  $y$ :

```
content(poly(6*x^3*y + 3*x*y + 9*y, [x]))
```

3 y

Here is another example where the coefficients and the content are again polynomial expressions:

```
content(poly(4*x*y + 6*x^3 + 6*x*y^2 + 9*x^3*y, [x]))
```

3 y+2

The following call is equivalent to the previous one:

```
content(4*x*y + 6*x^3 + 6*x*y^2 + 9*x^3*y, [x])
```

3 y+2

## Example 2

If a polynomial or polynomial expression has numeric coefficients and at least one floating-point number is among them, its content is 1:

```
content(2.0*x+2.0)
```

1

## Example 3

If not all of the coefficients are numbers, the gcd of the coefficients is returned:

```
content(poly(x^2*y+x, [y]))
```

*x*

## Parameters

**p**

A polynomial (Symbolic Math Toolbox) of type DOM\_POLY

**f**

A polynomial expression (Symbolic Math Toolbox)

**vars**

A list on page 7-41 of indeterminates of the polynomial: typically, identifiers on page 7-29 or indexed identifiers on page 1-1017

## Return Values

an object of the same type as the coefficients of the polynomial or the value FAIL.

## Overloaded By

p

## See Also

### MuPAD Functions

coeff | factor | gcd | icontent | ifactor | igcd | ilcm | lcm | poly |  
polylib::primpart

## context

Evaluate an object in the enclosing context

### Syntax

```
context(object)
```

### Description

Within a procedure, `context(object)` evaluates `object` in the context of the calling procedure.

Most MuPAD procedures on page 7-45 evaluate their arguments before executing the body of the procedure. However, if the procedure is declared with option `hold`, then the arguments are passed to the procedure unevaluated. `context` serves to evaluate such arguments a posteriori from within the procedure.

Like most MuPAD procedures, `context` first evaluates its argument `object` as usual in the context of the current procedure. Then the result is evaluated again in the dynamical context that was valid before the current procedure was called. The enclosing context is either the interactive level or the procedure that called the current procedure.

"`func_call`"-methods of domains (Symbolic Math Toolbox) never evaluate their arguments, whether the option `hold` is used or not. See "Example 2" on page 1-454 (Symbolic Math Toolbox).

`context` is sensitive to the value of the environment variable `LEVEL`, which determines the maximal depth of the recursive process that replaces an identifier on page 7-29 by its value during evaluation. The evaluation of the argument takes place with the value of `LEVEL` that is valid in the current procedure, which is 1 by default. The second evaluation uses the value of `LEVEL` that is valid in the enclosing context, which is usually 1 if the enclosing context is also a procedure, while it is 100 by default if the enclosing context is the interactive level. See "Example 3" on page 1-455 (Symbolic Math Toolbox).

---

**Note** The function `context` must not be called at interactive level, and `context` calls must not be nested. Thus it is not possible to evaluate an object in higher levels of the dynamical call stack. See “Example 4” on page 1-455 (Symbolic Math Toolbox).

---

## Environment Interactions

`context` is sensitive to the value of the environment variable `LEVEL`, which determines the maximal substitution depth for identifiers.

## Examples

### Example 1

We define a procedure `f` with option `hold`. If this procedure is called with an identifier as argument, such as `a` below, the identifier itself is the actual argument inside of `f`. `context` may be used to get the value of `a` in the outer context:

```
a := 2;
f := proc(i)
    option hold;
    begin
        print(i, context(i), i^2 + 2, context(i^2 + 2));
    end_proc;
f(a):
```

$a, 2, a^2 + 2, 6$

If a procedure with option `hold` is called from another procedure you will see strange effects if the procedure with option `hold` does not evaluate its formal parameters with `context`. Here, the value of the formal parameter `j` in `g` is the variable `i` which is defined in the context of procedure `f` and not its value 4. When you want to access the value of this variable you have to use `context`, otherwise you see the output `DOM_VAR(0, 2)` which is the variable `i` of `f` which has lost its scope:

```
f := proc()
    local i;
    begin
```

```
        i := 4:
        g(i);
    end_proc:
g := proc(j)
    option hold;
    begin
        print(j, eval(j), context(j));
        print(j + 1)
    end_proc:
f()
```

DOM\_VAR(0, 2), DOM\_VAR(0, 2), 4

DOM\_VAR(0, 2) + 1

## Example 2

The "func\_call" method of a domain is implicitly declared with `option hold`. We define a "func\_call" method for the domain `DOM_STRING` of MuPAD strings. The slot routine converts its remaining arguments into strings and appends them to the first argument, which coincides with the string that is the 0th operand of the function call:

```
unprotect(DOM_STRING):
DOM_STRING::func_call :=
    string -> _concat(string, map(args(2..args(0)), expr2text)):
a := 1: "abc"(1, a, x)
```

"abc1ax"

You see that the identifier `a` was added to the string, and not its value 1. Use `context` to access the value that `a` has before the "func\_call" method is invoked:

```
DOM_STRING::func_call :=
    string -> _concat(string, map(context(args(2..args(0))),
                                expr2text)):
"abc"(1, a, x);
delete DOM_STRING::func_call: protect(DOM_STRING, Error):
```

"abc11x"



### Example 3

This example shows the influence of the environment variable `LEVEL` on the evaluation of `context` and the differences to the functions `eval` and `level`. `p` is a function with option `hold`. `x` is a formal parameter of this procedure. When evaluating their arguments `context`, `eval` and `level` all replace `x` first by its value `a`. Then `eval` evaluates `a` in the current context with `LEVEL = 1` and yields the value `b`. `context` evaluates `a` in the enclosing context (which is the interactive level) with `LEVEL = 100` and yields `c`. `level` always returns the result of the first evaluation step, which is `a`.

When the `LEVEL` of the interactive level is 1, `context` returns `b` like `eval` since the second evaluation is performed with `LEVEL = 1` like in `eval`.

The local variable `b` of `p` does not influence the evaluation in `context`, `eval` and `level` since it is only a locally declared variable of type `DOM_VAR` which has nothing to do with the identifier `b`, which is the value of `a`:

```
delete a, b, c: a := b: b := c:
p := proc(x)
  option hold;
  local b;
  begin
    b := 2;
    eval(x), context(x), level(x), level(x,2);
  end:
p(a);
LEVEL := 1: p(a);
delete LEVEL:
```

*b, c, a, a*

*b, b, a, a*

### Example 4

The function `context` must not be called at interactive level:

```
context(x)
```

Error: Function call not supported on interactive level. [context]

Error: Function call not  
allowed on interactive level. [context]

## Parameters

### **object**

Any MuPAD object

## Return Values

Evaluated object.

## See Also

### **MuPAD Domains**

DOM\_PROC

### **MuPAD Functions**

LEVEL | MAXLEVEL | eval | freeze | hold | level | proc

# contfrac

Domain of continued fractions

## Syntax

`contfrac(r, <n>)`

`contfrac(f, x, <m>)`

`contfrac(f, x = x0, <m>)`

## Description

`contfrac(r)` creates a continued fraction approximation of the real number  $r$ .

`contfrac(f, x = x0)` creates a continued fraction approximation of the expression  $f$  as a function of  $x$  around  $x = x0$ .

The continued fraction expansion `contfrac(r n)` of a real number or numerical expression  $r$  is an expansion of the form

$$a_1 + \frac{1}{a_2 + \frac{1}{a_3 + \frac{1}{\dots + a_{k-1} + \frac{1}{a_k + \dots}}}}$$

where  $a_1$  is the integer `floor(r)` and  $a_2, a_3, \dots$  are positive integers.

The continued fraction is computed by `numlib::contfrac(r < n >)`; the expansion returned by `contfrac` is of domain type `numlib::contfrac`.

See the documentation of `numlib::contfrac` for further details.

A continued fraction expansion `contfrac(f, x = x0)` of a symbolic expression  $f$  in the indeterminate  $x$  is an expansion of the form

$$a_1 + \frac{(x-x_0)^{e_1}}{a_2 + \frac{(x-x_0)^{e_2}}{a_3 + \frac{(x-x_0)^{e_3}}{\dots + a_{k-1} + \frac{(x-x_0)^{e_{k-1}}}{a_k + O((x-x_0)^{e_k}})}}}$$

where

- $a_1, \dots, a_k$  are arithmetical expressions (Symbolic Math Toolbox) not containing powers of  $x - x_0$ . The coefficients  $a_2, \dots, a_k$  are non-zero.
- $e_1$  is a rational number and  $e_2, \dots, e_k$  are positive rational numbers. If  $a_1 \neq 0$ , then  $e_1$  is positive as well.

If  $x_0 = \pm\infty$  or  $x_0 = \text{complexInfinity}$ , the terms  $(x - x_0)^{e_i}$  have to be replaced by  $\frac{1}{x^{e_i}}$ .

For symbolic expressions  $f$ , `contfrac(f, x = x0)` returns an expansion of domain type `contfrac`.

One may also call `contfrac(f)` without specifying an identifier  $x$ . In this case, `contfrac` extracts the indeterminates in  $f$  automatically via `indets`. `FAIL` is returned if more than one indeterminate is found.

If  $m$  is not specified, the default value  $m = \text{ORDER}$  is used.

`contfrac` uses the function `Series::Puisseux::contfrac` to compute the continued fraction in the symbolic case. If  $f$  is a rational function with respect to the expansion variable  $x$ , and the 'truncation order' on page 31-20 (Symbolic Math Toolbox)  $m$  is not specified, then `contfrac` returns an exact continued fraction expansion of  $f$ . Cf. "Example 3" on page 1-460 (Symbolic Math Toolbox).

## Environment Interactions

When called with an irrational numerical value  $r$ , the function is sensitive to the environment variable `DIGITS` which determines the numerical working precision. For

symbolic expressions `f`, the function is sensitive to the environment variable `ORDER` which determines the number of terms in truncated series expansions.

## Examples

### Example 1

We compute some continued fraction expansions of real numbers:

```
contfrac(27/31), contfrac(PI, 5)
```

$$1 + \frac{1}{6 + \frac{1}{1 + \frac{1}{3 + \dots}}}, 3 + \frac{1}{7 + \frac{1}{15 + \frac{1}{1 + \dots}}}$$

They can also be computed by direct calls to `numlib::contfrac`:

```
numlib::contfrac(27/31), numlib::contfrac(PI, 5)
```

$$1 + \frac{1}{6 + \frac{1}{1 + \frac{1}{3 + \dots}}}, 3 + \frac{1}{7 + \frac{1}{15 + \frac{1}{1 + \dots}}}$$

### Example 2

We compute symbolic continued fractions of functions:

```
contfrac(exp(x), x = 0), contfrac(exp(-3*x^2), x = 0)
```

$$1 + \frac{x}{1 + \frac{x}{-2 + \frac{x}{-3 + \frac{x}{2 + \frac{x}{5 + O(x)}}}}}, 1 + \frac{x^2}{-\frac{1}{3} + \frac{x^2}{-2 + \frac{x^2}{1 + O(x^2)}}}$$

If no expansion variable is specified, the symbolic expression to be expanded must be univariate:

```
contfrac(exp(x*y))
```

Error: First argument must be a univariate expression. [contfrac::function]

Symbolic parameters are accepted if the expansion variable is specified:

```
contfrac(exp(x*y), x)
```

$$1 + \frac{x}{y^{-1} + \frac{x}{-2 + \frac{x}{-3y^{-1} + \frac{x}{2 + \frac{x}{5y^{-1} + O(x)}}}}}$$

In the next call, we specify the expansion point  $x = 1$  and request a specific 'number of terms' by the third argument:

```
contfrac(exp(x*y), x = 1, 3);
```

$$e^y + \frac{x-1}{y^{-1} e^{-y} + \frac{x-1}{-2e^y + O(x-1)}}$$

### Example 3

For rational functions, exact representations are returned when no specific 'number of terms' is requested. The method "rational" returns the rational expression equivalent to the continued fraction:

```
cf := contfrac((x - y)/(x^3 + y^3), x, 2):
cf, contfrac::rational(cf);
```

$$-y^{-2} + \frac{x}{y^3 + O(x)}, \frac{x-y}{y^3}$$

```
cf := contfrac((x - y)/(x^3 + y^3), x):
cf, contfrac::rational(cf);
```

$$-y^{-2} + \frac{x}{y^3 + \frac{x^2}{-y^{-1} + \frac{x}{-y^2 + \frac{x}{\frac{y}{2} + \frac{x}{2y^2}}}}}, \frac{x-y}{x^3 + y^3}$$

### Example 4

The coefficients and expansion terms of a continued fraction can be accessed by the functions `nthcoeff` and `nthterm`:

```
cf := contfrac(sin(1/x), x = infinity, 4)
```

$$\frac{x^{-1}}{1 + \frac{x^{-2}}{6 + O(x^{-2})}}$$

```
nthcoeff(cf, 1), nthcoeff(cf, 2), nthcoeff(cf, 3), nthcoeff(cf, 4);
```

0, 1, 6, FAIL

```
nthterm(cf, 1), nthterm(cf, 2), nthterm(cf, 3)
```

$\frac{1}{x}$ ,  $\frac{1}{x^2}$ , FAIL

```
delete cf;
```

### Example 5

We can compute a series expansion of a continued fraction via `series`:

```
cf := contfrac(sin(x)/(x - PI) - 1, x = PI)
```

$$-2 + \frac{(x - \pi)^2}{6 + \frac{(x - \pi)^2}{\frac{10}{3} + O((x - \pi)^2)}}$$

If no further arguments are given in `series`, the default expansion variable is `op(cf, 3)`; the default expansion point is `op(cf, 4)`:

```
op(cf, 3), op(cf, 4)
```

```
x, pi
```

```
series(cf)
```

$$-2 + \frac{(x - \pi)^2}{6} - \frac{(x - \pi)^4}{120} + O((x - \pi)^6)$$

Both the series variable as well as the expansion point may be passed explicitly to `series`.

```
series(cf, x = PI)
```

$$-2 + \frac{(x - \pi)^2}{6} - \frac{(x - \pi)^4}{120} + O((x - \pi)^6)$$

However, the values must coincide with the values used to compute the continued fraction: In the following call, the default expansion point `x = 0` is used by `series`. This clashes with the expansion point `x = PI` of the continued fraction:

```
series(cf, x)
```

```
Error: Expansion point 'PI' of the continued fraction does not coincide with the requested expansion point '0'
```

```
delete cf:
```



## Parameters

**r**

A real number or a numerical expression that can be converted to a real floating-point number

**n**

The number of significant decimal digits: a positive integer. The default value is `n = DIGITS`.

**f**

An arithmetical expression (Symbolic Math Toolbox) interpreted as a function of  $x$

**x**

An identifier

**x0**

The expansion point: an arithmetical expression (Symbolic Math Toolbox),  $\pm\infty$  or `complexInfinity`. The default value is 0.

**m**

The 'number of terms': a positive integer. The default value is `m = ORDER`.

## Return Values

Call `contfrac(r n)` with a numerical value  $r$  returns an object of type `numlib::contfrac`. The call `contfrac(f, x = x0 m)` with a symbolic expression  $f$  returns an object of type `contfrac`. FAIL is returned if no series expansion of  $f$  around  $x_0$  could be computed.

## Methods

### Mathematical Methods

**series** — Serie of a continued fraction

`series(cf, <m>)`

`series(cf, <x>, <m>)`

`series(cf, <x = x0>, <m>)`

If  $x$  is not specified, the default series variable is `op(cf, 3)`. If  $x_0$  is not specified, the default expansion point is `op(cf, 4)`. If no `number of terms'  $m$  is specified,  $m = \text{ORDER}$  is used.

This method overloads the function `series`.

### Access Methods

**op** — Operand of the continued fraction

`op(cf, <n>)`

### See Also

**MuPAD Functions**

`numlib::contfrac` | `series`

# copyClosure

Copies the lexical closure of a procedure

## Syntax

```
copyClosure(f)
```

## Description

`copyClosure(f)` copies the lexical closure of a procedure or procedure environment `f`.

Usually, when a procedure is copied, for example by assigning it to an identifier, the lexical closure of the procedure is not copied. Via the copied procedure one can change the lexical closure of the original procedure. Thus, the lexical closure of a procedure shows the so-called *reference effect*.

`copyClosure` may be used to copy the lexical closure of a procedure. Changes in the closure of the copy no longer affect the original procedure's closure.

Closures are implemented by procedure environments (kernel type `DOM_PROC_ENV`) in MuPAD. `copyClosure` works by copying all lexically enclosing procedure environments of a procedure.

`copyClosure` may also be used to copy a procedure environment and all its lexically enclosing environments only.

## Examples

### Example 1

Procedure closures show the reference effect: The procedure `f` generated by `gen` changes its closure via the variable `i`. A “normal” copy `g` of `f` changes the variable in the same closure, as is seen by repeatedly calling `f` versus `g`.

```
gen:= proc()
  option escape;
  local i;
begin
  i := 0;
  proc() begin i := i+1 end
end:

f := gen():
g := f:
f(), g(), f(), g()
```

1, 2, 3, 4

If one now generates `f` again by calling `gen`, but copies `g` by calling `copyClosure`, then `g` has its own closure and now longer changes the variable `i` in the closure of `f`.

```
f := gen():
g := copyClosure(f):
f(), g(), f(), g()
```

1, 1, 2, 2

## Parameters

**f**

A procedure or procedure environment to be copied

## Return Values

Copied procedure or procedure environment

## See Also

### MuPAD Functions

`_assign`

# curl

Curl of a vector field

## Syntax

`curl(v, x)`

`curl(v, x, ogCoord, <c>)`

## Description

`curl(v, x)` computes the curl of the three-dimensional vector field  $\vec{v}$  with respect to the three-dimensional vector  $\vec{x}$  in Cartesian coordinates. This is the vector field

$$\text{curl}(\vec{v}) = \begin{pmatrix} \frac{\partial}{\partial x_2} v_3 - \frac{\partial}{\partial x_3} v_2 \\ \frac{\partial}{\partial x_3} v_1 - \frac{\partial}{\partial x_1} v_3 \\ \frac{\partial}{\partial x_1} v_2 - \frac{\partial}{\partial x_2} v_1 \end{pmatrix}.$$

`curl(v, x, ogCoord)` computes the curl of  $v$  with respect to  $x$  in the orthogonally curvilinear coordinate system specified by `ogCoord`.

`ogCoord` can be the name of a three-dimensional orthogonal coordinate system predefined in the table `linalg::ogCoordTab`. See “Example 2” on page 1-469 (Symbolic Math Toolbox).

Alternatively, `ogCoord` can be a list of vector of algebraic expressions representing the scale factors of the coordinate system. See example “Example 3” on page 1-470 (Symbolic Math Toolbox). For details, see the description of the `Scales` option on the `linalg::ogCoordTab` page.

If  $v$  is a vector then the component ring of  $v$  must be a field (a domain of category `Cat::Field`) for which differentiation with respect to  $x$  is defined.

`curl` returns a vector of the domain `Dom::Matrix()`.

## Examples

### Example 1

Compute the curl of the vector field  $\vec{v}(x, y, z) = (x, y, 2y, z)$  in Cartesian coordinates:

```
delete x, y, z:
curl([x*y, 2*y, z], [x, y, z])
```

$$\begin{pmatrix} 0 \\ 0 \\ -x \end{pmatrix}$$

### Example 2

Compute the curl of the vector field  $\vec{v}(r, \phi, z) = (r, \cos(\phi), z)$ , ( $0 \leq \phi < 2\pi$ ) in cylindrical coordinates:

```
delete r, phi, z: V := matrix([r, cos(phi), z]):
curl(V, [r, phi, z], Cylindrical)
```

$$\begin{pmatrix} 0 \\ 0 \\ \frac{\cos(\phi)}{r} \end{pmatrix}$$

The following relations between Cartesian and cylindrical coordinates hold:

$$x = r \cos(\phi), \quad y = r \sin(\phi), \quad z = z$$

Other predefined orthogonal coordinate systems can be found in the table `linalg::ogCoordTab`.

### Example 3

Compute the curl of a vector field in spherical coordinates  $r, \theta, \phi$  given by

$$\vec{x} = \begin{pmatrix} x \\ y \\ z \end{pmatrix} = \begin{pmatrix} r \sin(\theta) \cos(\phi) \\ r \sin(\theta) \sin(\phi) \\ r \cos(\theta) \end{pmatrix}$$

with  $0 \leq \theta \leq \pi$ ,  $0 \leq \phi < 2\pi$ . The vectors

$$\vec{e}_r = \frac{\frac{\partial \vec{x}}{\partial r}}{\left| \frac{\partial \vec{x}}{\partial r} \right|} = \begin{pmatrix} \sin(\theta) \cos(\phi) \\ \sin(\theta) \sin(\phi) \\ \cos(\theta) \end{pmatrix}, \quad \vec{e}_\theta = \frac{\frac{\partial \vec{x}}{\partial \theta}}{\left| \frac{\partial \vec{x}}{\partial \theta} \right|} = \begin{pmatrix} \cos(\theta) \cos(\phi) \\ \cos(\theta) \sin(\phi) \\ -\sin(\theta) \end{pmatrix},$$

$$\vec{e}_\phi = \frac{\frac{\partial \vec{x}}{\partial \phi}}{\left| \frac{\partial \vec{x}}{\partial \phi} \right|} = \begin{pmatrix} -\sin(\phi) \\ \cos(\phi) \\ 0 \end{pmatrix}$$

form an orthogonal system of unit vectors corresponding to the spherical coordinates. The scaling factors of the coordinate transformation (see `linalg::ogCoordTab`) are

$\left| \frac{\partial \vec{x}}{\partial r} \right| = 1$ ,  $\left| \frac{\partial \vec{x}}{\partial \theta} \right| = r$ ,  $\left| \frac{\partial \vec{x}}{\partial \phi} \right| = r \sin(\theta)$ , which we use in the following example to compute the curl of the vector field  $\vec{v}(r, \theta, \phi) = r^2 \vec{e}_\phi$ :

```
delete r, Theta, phi;
curl([0, 0, r^2], [r, Theta, phi], [1, r, r*sin(Theta)])
```

$$\begin{pmatrix} \frac{r \cos(\text{Theta})}{\sin(\text{Theta})} \\ -3r \\ 0 \end{pmatrix}$$



These are the coefficients of the curl of  $\vec{v}$  in the bases given by the vectors  $\vec{e}_r, \vec{e}_\theta, \vec{e}_\phi$ ,

that is, the curl of  $\vec{v}$  is given by the vector field  $\frac{r \cos(\theta)}{\sin(\theta)} \vec{e}_r - 3r \vec{e}_\theta$ .

The spherical coordinates are already defined in `linalg::ogCoordTab`. The last result can also be achieved with the input `curl([0, 0, r^2], [r, Theta, phi], Spherical)`.

`curl([0, 0, r^2], [r, Theta, phi], Spherical)`

$$\begin{pmatrix} \frac{r \cos(\text{Theta})}{\sin(\text{Theta})} \\ -3r \\ 0 \end{pmatrix}$$

## Parameters

**v**

A list of three arithmetical expressions, or a three-dimensional vector (a  $3 \times 1$  or  $1 \times 3$  matrix of a domain of category `Cat::Matrix`)

**x**

A list of three (indexed) identifiers

**ogCoord**

The name of a three-dimensional orthogonal coordinate system predefined in the table `linalg::ogCoordTab`, or a list of algebraic expressions representing the scale factors of an orthogonal coordinate system.

**c**

The parameter of the coordinate systems `EllipticCylindrical` on page 15-167 and `Torus` on page 15-167, respectively: an arithmetical expression (Symbolic Math Toolbox). The default value is `c = 1`.

## Return Values

Column vector.

## See Also

### **MuPAD Functions**

`divergence` | `gradient` | `laplacian` | `linalg::ogCoordTab` | `potential` | `vectorPotential`

# 'D

Differential operator for functions

## Syntax

$f'$

$D(f)$

$D([n_1, n_2, \dots], f)$

## Description

$D(f)$  or, alternatively,  $f'$  computes the derivative of the univariate function  $f$ .

$D([n_1, n_2, \dots], f)$  computes the partial derivative  $\frac{\partial}{\partial x_{n_2}} \frac{\partial}{\partial x_{n_1}} \dots f$  of the multivariate function  $f(x_1, x_2, \dots)$ .

MuPAD has two functions for differentiation: `diff` and `D`. `D` represents the differential operator that may be applied to functions (Symbolic Math Toolbox); `diff` is used to differentiate arithmetical expressions (Symbolic Math Toolbox). Mathematically,  $D(f)(x)$  coincides with  $\text{diff}(f(x), x)$ ;  $D([1, 2], f)(x, y)$  coincides with  $\text{diff}(f(x, y), x, y)$ . Symbolic calls of `D` and `diff` can be converted to one another via `rewrite`. Cf. "Example 8" on page 1-479 (Symbolic Math Toolbox).

$D(f)$  returns the derivative  $f'$  of the univariate function (Symbolic Math Toolbox).  $f'$  is shorthand for  $D(f)$ .

If  $f$  is a multivariate function (Symbolic Math Toolbox) and  $D_n f$  denotes the partial derivative of  $f$  with respect to its  $n$ -th argument, then  $D([n_1, n_2, \dots], f)$  computes

the partial derivative  $D_{n_2} D_{n_1} \dots f$ . Cf. "Example 5" on page 1-477 (Symbolic Math Toolbox). In particular,  $D([], f)$  returns  $f$  itself.

**Note** It is assumed that partial derivatives commute. Internally,  $D([n1, n2, \dots], f)$  is converted to  $D([m1, m2, \dots], f)$ , where  $[m1, m2, \dots] = \text{sort}([n1, n2, \dots])$ .

---

$f$  may be any object which can represent a function. In particular,  $f$  may be a functional expression built from simple functions by means of arithmetic operators (+, -, \*, /, ^, @, @@). Any identifier different from CATALAN (Symbolic Math Toolbox), EULER (Symbolic Math Toolbox), and PI (Symbolic Math Toolbox) is regarded as an “unknown” function; the same holds for elements of kernel domains not explicitly mentioned on this page. Cf. “Example 1” on page 1-475 (Symbolic Math Toolbox). Any number (Symbolic Math Toolbox) and each of the three constant identifiers above is regarded as a constant function. Cf. “Example 2” on page 1-476 (Symbolic Math Toolbox).

If  $f$  is a list on page 7-41, a set on page 7-50, a table on page 1-2103, or an array on page 7-2, then  $D$  is applied to each entry of  $f$ . Cf. “Example 3” on page 1-476 (Symbolic Math Toolbox).

A polynomial (Symbolic Math Toolbox)  $f$  of type DOM\_POLY is regarded as polynomial function, the indeterminates being the arguments of the function. Cf. “Example 6” on page 1-478 (Symbolic Math Toolbox).

If  $f$  is a function environment on page 7-25, a procedure on page 7-45, then  $D$  can compute the derivative in some cases; see the “Background” section below. If this is not possible, a symbolic  $D$  call is returned.

Higher partial derivatives  $D([n1], D([n2], f))$  are simplified to  $D([n1, n2], f)$ . Cf. “Example 7” on page 1-478 (Symbolic Math Toolbox).

The derivative of a univariate function  $f$ —denoted by  $D(f)$ —is syntactically distinguished from the partial derivative  $D([1], f)$  with respect to the first variable, even if  $f$  represents a univariate function.

The usual rules of differentiation are implemented:

- $D(f + g) = D(f) + D(g)$ ,
- $D(f * g) = f * D(g) + g * D(f)$ ,
- $D(1/f) = -D(f) / f^2$ ,
- $D(f @ g) = D(f) @ g * D(g)$ .

Note that the composition of functions is written as  $f@g$  and *not* as  $f(g)$ .

In order to express the  $n$ -th derivative of a univariate function for symbolic  $n$ , you can use the “repeated composition operator” @@. Cf. “Example 9” on page 1-479 (Symbolic Math Toolbox).

## Environment Interactions

D uses option `remember`.

## Examples

### Example 1

`D(f)` computes the derivative of the function `f`:

```
D(sin), D(x -> x^2), D(id)
```

```
cos, (x -> 2 x), 1
```

D also works for more complex functional expressions:

```
D(sin @ exp + 2*(x -> x*ln(x)) + id^2)
```

```
(cos @ exp) exp + 2 (x -> ln(x) + 1) + 2 id
```

If `f` is an identifier without a value, a symbolic D call is returned:

```
delete f: D(f + sin)
```

```
f' + cos
```

The same holds for objects of kernel type that cannot be regarded as functions:

```
D(NIL)
```

```
NIL'
```

$f'$  is shorthand for  $D(f)$ :

`(f + sin)', (x -> x^2)', id'`

$f' + \cos, (x \rightarrow 2x), 1$

## Example 2

Constants are regarded as constant functions:

`PI', 3', (1/2)'`

$0, 0, 0$

## Example 3

The usual rules of differentiation are implemented. Note that lists and sets may also be taken as input; in this case,  $D$  is applied to each element of the list or set:

`delete f, g: D([f+g, f*g]); D({1/f, f@g})`

$[f' + g', f'g + fg']$

$\left\{ g' (f' \circ g), -\frac{f'}{f^2} \right\}$

## Example 4

The derivatives of most special functions of the library can be computed. Again, `id` denotes the identity function:

`D(tan); D(sin*cos); D(1/sin); D(sin@cos); D(2*sin + ln)`

$\tan^2 + 1$

$$\cos^2 - \sin^2$$

$$-\frac{\cos}{\sin^2}$$

$$-(\cos \circ \cos) \sin$$

$$\frac{1}{\text{id}} + 2 \cos$$

## Example 5

D can also compute derivatives of procedures:

```
f := x -> x^2:
g := proc(x) begin tan(ln(x)) end:
D(f), D(g)
```

$$(x \rightarrow 2x), \frac{(\tan \circ \ln)^2 + 1}{\text{id}}$$

We differentiate a function of two arguments by passing a list of indices as first argument to D. In the example below, we first differentiate with respect to the second argument and then differentiate the result with respect to the first argument:

```
D([1, 2], (x, y) -> sin(x*y))
```

$$(x, y) \rightarrow \cos(xy) - xy \sin(xy)$$

The order of the partial derivatives is not relevant:

```
D([2, 1], (x, y) -> sin(x*y))
```

$$(x, y) \rightarrow \cos(xy) - xy \sin(xy)$$

delete f, g:

## Example 6

A polynomial is regarded as a polynomial function:

```
D(poly(x^2 + 3*x + 2, [x]))
```

$\text{poly}(2x + 3, [x])$

We differentiate the following bivariate polynomial  $f$  twice with respect to its second variable  $y$  and once with respect to its first variable  $x$ :

```
f := poly(x^3*y^3, [x, y]):  
D([1, 2, 2], f) = diff(f, y, y, x)
```

$\text{poly}(18x^2y, [x, y]) = \text{poly}(18x^2y, [x, y])$

delete f:

## Example 7

Nested calls to  $D$  are flattened:

```
D([1], D([2], f))
```

$D_{1,2}(f)$

However, this does not hold for calls with only one argument, since  $D(f)$  and  $D([1], f)$  are not considered to be the same:

```
D(D(f))
```

$f''$



## Example 8

D may only be applied to functions whereas `diff` makes only sense for expressions:

```
D(sin), diff(sin(x), x)
```

```
cos, cos(x)
```

Applying D to expressions and `diff` to functions makes no sense:

```
D(sin(x)), diff(sin, x)
```

```
(sin(x))', 0
```

`rewrite` allows to rewrite expressions with D into `diff`-expression:

```
rewrite(D(f)(y), diff), rewrite(D(D(f))(y), diff)
```

$$\frac{\partial}{\partial y} f(y), \frac{\partial^2}{\partial y^2} f(y)$$

The reverse conversion is possible as well:

```
map(%, rewrite, D)
```

$$f'(y), f''(y)$$

## Example 9

Sometimes you may need the  $n$ -th derivative of a function, where  $n$  is unknown. This can be achieved using the repeated composition operator. For example, let us write a function that computes the  $k$ -th Taylor polynomial of a function  $f$  at a point  $x_0$  and uses  $x$  as variable for that polynomial:

```
kthtaylorpoly:=
(f, k, x, x0) -> _plus(((D@@n)(f)(x0) * (x - x0)^n / n!) $ n = 0..k):
kthtaylorpoly(sin, 7, x, 0)
```

$$-\frac{x^7}{5040} + \frac{x^5}{120} - \frac{x^3}{6} + x$$

delete kthtaylorpoly:

## Example 10

Advanced users can extend D to their own special mathematical functions (see “Background” section below). To this end, embed your mathematical function  $f$ , say, into a function environment on page 7-25f and implement the behavior of D for this function as the “D” slot of the function environment. The slot must handle two cases: it may be either called with only one argument which equals  $f$ , or with two arguments where the second one equals  $f$ . In the latter case, the first argument is a list of arbitrary many indices; that is, the slot must be able to handle higher partial derivatives also.

Suppose, for example, that we are given a function  $f(t, x, y)$ , and that we do not know anything about  $f$  except that it is differentiable infinitely often and satisfies the partial

differential equation  $\frac{\partial}{\partial t} f = \frac{\partial^2}{\partial x^2} f + \frac{\partial^2}{\partial y^2} f$ . To make MuPAD eliminate derivatives with respect to  $t$ , we can do the following

```
f := funcenv(f):
f::D :=
proc(indexlist, ff)
  local
    n      : DOM_INT,    // Number of t-derivatives.
    list_2_3 : DOM_LIST; // List of indices of 2's and 3's.
                                // These remain unchanged.
begin
  if args(0) <> 2 then
    error("Wrong number of arguments")
  end_if;
  n      := nops(select(indexlist, _equal, 1));
  list_2_3 := select(indexlist, _unequal, 1);
  // rewrite (d/dt)^n = (d^2/dx^2 + d^2/dy^2)^n
  _plus(binomial(n, k) *
        hold(D)(sort([2 $ 2*(n-k), 3 $ 2*k].list_2_3), ff)
        $ k = 0..n)
end_proc:
```

Now, partial derivatives with respect to the first argument  $t$  are rewritten by derivatives with respect to the second and third argument:

$D([1], f^2)(t, x, y)$

$$2 (D_{2,2}(f)(t, x, y) + D_{3,3}(f)(t, x, y)) f(t, x, y)$$

$D([1, 2, 1], f)$

$$D_{2,2,2,2,2}(f) + 2 D_{2,2,2,3,3}(f) + D_{2,3,3,3,3}(f)$$

delete f:

## Parameters

**f**

A function (Symbolic Math Toolbox) or a functional expression, an array on page 7-2, a list on page 7-41, a polynomial (Symbolic Math Toolbox), a set on page 7-50, or a table on page 1-2103

**n1, n2, ...**

Indices: positive integers

## Return Values

function (Symbolic Math Toolbox) or a functional expression. If **f** is an array or a list etc., a corresponding object containing the derivatives of the entries is returned.

## Overloaded By

f

## Algorithms

If  $f$  is a domain (Symbolic Math Toolbox) or a function environment on page 7-25 with a slot on page 1-1980 "D", this slot is called to compute the derivative. The slot procedure has the same calling syntax as `D`. In particular—and in contrast to the slot on page 1-1980 "diff"—the slot must be able to compute higher partial derivatives because the list of indices may have length greater than one. Cf. "Example 10" on page 1-480 (Symbolic Math Toolbox).

If  $f$  is a procedure on page 7-45, a function environment on page 7-25 without a "D" slot, then  $f$  is called with auxiliary identifiers as arguments. The result of the call is then differentiated using the function `diff`. If the result of `diff` yields an expression which can be regarded as function in the auxiliary identifiers, then this function is returned, otherwise an unevaluated call of `D` is returned.

Let us take the function environment on page 7-25 `sin` as an example. It has no "D" slot, thus the procedure `op(sin, 1)`, which is responsible for evaluating the sine function, is used to compute  $D(\sin)$ , as follows. This procedure is applied to an auxiliary identifier, say  $x$ , and differentiated with respect to this identifier via `diff`. The result is `diff(sin(x), x) = cos(x)`. Via `fp::expr_unapply` and `fp::unapply`, the function `cos` is computed as the derivative of `sin`.

## See Also

### MuPAD Functions

`diff` | `int` | `poly`

### Topics

"Choose Differentiation Function" (Symbolic Math Toolbox)

"Differentiate Expressions" (Symbolic Math Toolbox)

"Differentiate Functions" (Symbolic Math Toolbox)

# dawson

Dawson's integral

## Syntax

`dawson(x)`

## Description

`dawson(x)` represents Dawson's integral, which is defined as  $e^{-x^2} \int_0^x e^{t^2} dt$ .

`dawson(x)` returns special values for  $x = 0$  and  $x = \pm\infty$ . For all other symbolic values of  $x$ , unevaluated function calls are returned. Cf. "Example 1" on page 1-483 (Symbolic Math Toolbox).

## Environment Interactions

When called with floating-point arguments, this function is sensitive to the environment variable DIGITS which determines the numerical working precision.

## Examples

### Example 1

For the following arguments, special values are returned:

`dawson(0)`, `dawson(infinity)`, `dawson(-infinity)`

`0, 0, 0`

For other symbolic arguments, a symbolic call is returned:

```
dawson(1), dawson(5+I)
```

```
dawson(1), dawson(5 + i)
```

Floating point values are returned for floating-point arguments:

```
dawson(0.0), dawson(1.0), dawson(-3.4 + 0.2*I)
```

```
0.0, 0.5380795069, -0.1538060524 - 0.0100961726 i
```

## Example 2

The functions `diff`, `float`, `limit`, and `series` handle expressions involving the dawson function:

```
diff(dawson(x^2), x), float(dawson(7))
```

```
-2 x (2 x^2 dawson(x^2) - 1), 0.07218097466
```

```
limit(x*dawson(x), x = infinity)
```

```
 $\frac{1}{2}$ 
```

```
series(dawson(x), x = infinity, 4)
```

```
 $\frac{1}{2}x + \frac{1}{4}x^3 + O\left(\frac{1}{x^5}\right)$ 
```

## Parameters

**x**

An arithmetical expression (Symbolic Math Toolbox)

## Return Values

Arithmetical expression.

## Overloaded By

x

## See Also

### **MuPAD Functions**

erf | erfc

## debug

Execute a procedure in single-step mode

### Syntax

`debug()`

`debug(statement)`

### Description

`debug(statement)` starts the MuPAD debugger, allowing to execute `statement` step by step.

`debug` called with an argument switches the state of the MuPAD kernel to *debug mode* and, if `statement` contains procedure on page 7-45 calls that can be debugged, enters the interactive MuPAD debugger for controlled single-step execution of `statement`.

If `debug` is called without arguments, the current state is returned *without* changing the state. If the debugger is on, the return value is `TRUE`, otherwise `FALSE`.

In a MuPAD version with a graphical user interface, a separate debugger window pops up. In the UNIX<sup>®</sup> terminal version, the text interface of the command line debugger is activated.

The debugger features single stepping, inspection of variables and stack frames, breakpoints, etc. Read the online help of the debugger window for a description.

Debugging is possible only for procedures on page 7-45 written in the MuPAD language that do not have the option `noDebug`. In particular, debugging of kernel functions is not possible.

After calling `Pref::ignoreNoDebug(TRUE)`, the procedure option `noDebug` is ignored.

You can also debug a sequence of statements on page 1-95 separated by semicolons if the sequence is enclosed in parentheses.



`debug(statement)` returns the same result as `statement`, if the execution is not aborted within the debugger by the user.

## Examples

### Example 1

`debug()` is called to check whether the kernel is in debug mode:

```
debug()
```

```
FALSE
```

To switch on the debugger mode, `debug(1)` is called:

```
debug(1)
```

```
Activating debugger... For those library functions which are already  
loaded, the format of the source code displayed by the debugger  
may differ from that of the original source code file. To avoid this,  
restart the kernel in debug mode. Execution completed.
```

```
1
```

```
debug()
```

```
TRUE
```

### Example 2

We start the debugger for stepwise execution of the statement `int(cos(x), x)`, which integrates the cosine function:

```
debug(int(cos(x), x)):
```

## Parameters

### statement

Any MuPAD object; typically a function call

## Return Values

Return value of statement or TRUE or FALSE.

## Algorithms

In debug mode, the MuPAD parser is re-configured. When a procedure is read from a file, the parser inserts additional *debug nodes* containing file identifications and line numbers into procedures. These debug nodes allow the debugger to associate the currently executed piece of MuPAD code with the corresponding source text file.

If the debug mode is activated and MuPAD encounters a procedure without debug nodes, it will write the procedure to a temporary file and add debug nodes on the fly. This allows interactively entered procedures to be debugged in the same way as procedures read from files. The temporary debug file is deleted at the end of the session.

Since this also applies to procedures that were read before debug mode was switched on, it is recommended to start the kernel in debug mode (see below) when bigger applications are to be debugged.

If the MuPAD kernel was not started in debug mode, this mode is turned on at the first execution of `debug`. It remains activated until the end of the session.

It is possible to start the kernel in debug mode. In the MuPAD Notebook, this can be configured by choosing "Configure ..." in the "View" menu ("Preferences..." on the Apple Macintosh) and then clicking on "Kernel". Enter "-g" in the text field "Arguments:".

## See Also

### MuPAD Functions

`Pref::ignoreNoDebug` | `prog::check` | `prog::profile` | `prog::trace`

## dedekindEta

The Dedekind eta function

### Syntax

`dedekindEta(z)`

### Description

`dedekindEta(z)` represents the Dedekind eta function  $e^{\frac{\pi iz}{12}} \left( \prod_{n=1}^{\infty} (1 - e^{2\pi izn}) \right)$ .

The Dedekind eta function is defined for all complex numbers  $z$  with positive imaginary part.

Floating-point results are computed for floating-point arguments. For all other arguments, the function returns symbolically.

### Environment Interactions

When called with a floating-point argument, the function is sensitive to the environment variable `DIGITS` which determines the numerical working precision.

### Examples

#### Example 1

The Dedekind eta function takes on small values near the real axis:

```
dedekindEta(1 + 0.001*I)
```

$$6.122295553 \cdot 10^{-113} + 1.640464149 \cdot 10^{-113} i$$

## Example 2

A symbolic call is returned if the argument is not a floating-point number:

`dedekindEta(I)`, `dedekindEta(x)`

`dedekindEta(i)`, `dedekindEta(x)`

## Parameters

**z**

An arithmetical expression (Symbolic Math Toolbox)

## Return Values

Arithmetical expression

## See Also

**MuPAD Functions**

theta

## degree

Degree of a polynomial

### Syntax

`degree(p)`

`degree(p, x)`

`degree(f, <vars>)`

`degree(f, <vars>, x)`

### Description

`degree(p)` returns the total degree of the polynomial `p`.

`degree(p, x)` returns the degree of `p` with respect to the variable `x`.

If the first argument `f` is not element of a polynomial domain, then `degree` converts the expression internally to a polynomial of type `DOM_POLY` via `poly(f)`. If a list of indeterminates is specified, the polynomial `poly(f, vars)` is considered.

`degree(f, vars, x)` returns 0 if `x` is not an element of the list `vars`.

The degree of the zero polynomial is defined as 0.

### Examples

#### Example 1

The total degree of the terms in the following polynomial expression is computed:

`degree(x^3 + x^2*y^2 + 2)`

4

## Example 2

degree may be applied to polynomials of type DOM\_POLY:

```
degree(poly(x^2*z + x*z^3 + 1, [x, z]))
```

4

## Example 3

The next expression is regarded as a bi-variate polynomial in x and z. The degree with respect to z is computed:

```
degree(x^2*z + x*z^3 + 1, [x, z], z)
```

3

## Example 4

The degree of the zero polynomial is defined as 0:

```
degree(0, [x, y])
```

0

## Parameters

**p**

A polynomial (Symbolic Math Toolbox) of type DOM\_POLY

**f**

A polynomial expression (Symbolic Math Toolbox)

**vars**

A list on page 7-41 of indeterminates of the polynomial: typically, identifiers on page 7-29 or indexed identifiers on page 1-1017

**x**

An indeterminate

## Return Values

Nonnegative number. FAIL is returned if the input cannot be converted to a polynomial.

## Overloaded By

f, p

## See Also

### MuPAD Functions

coeff | degreevec | ground | lcoeff | ldegree | lmonomial | lterm | monomials | nterms | nthcoeff | nthmonomial | nthterm | poly | poly2list | tcoeff



# degreevec

Exponents of the leading term of a polynomial

## Syntax

```
degreevec(p, <order>)
```

```
degreevec(f, <vars>, <order>)
```

## Description

`degreevec(p)` returns a list with the exponents of the leading term of the polynomial  $p$ .

For a polynomial in the variables  $x_1, x_2, \dots, x_n$  with the leading term on page 1-1309  $x_1^{e_1} x_2^{e_2} \dots x_n^{e_n}$ , the exponent vector  $[e_1, e_2, \dots, e_n]$  is returned.

`degreevec` returns a list of zeroes for the zero polynomial.

If the first argument  $f$  is not element of a polynomial domain, then `degreevec` converts the expression internally to a polynomial of type `DOM_POLY` via `poly(f)`. If a list of indeterminates is specified, the polynomial `poly(f, vars)` is considered. `FAIL` is returned if  $f$  cannot be converted to a polynomial.

## Examples

### Example 1

The leading term of the following polynomial expression (with respect to the main variable  $x$ ) is  $x^4$ :

```
degreevec(x^4 + x^2*y^3 + 2, [x, y])
```

```
[4, 0]
```

With the main variable  $y$ , the leading term is  $x^2y^3$ :

```
degreevec(x^4 + x^2*y^3 + 2, [y, x])
```

```
[3, 2]
```

For polynomials of type `DOM_POLY`, the indeterminates are an integral part of the data type:

```
degreevec(poly(x^4 + x^2*y^3 + 2, [x, y])),  
degreevec(poly(x^4 + x^2*y^3 + 2, [y, x]))
```

```
[4, 0], [3, 2]
```

## Example 2

For a univariate polynomial, the standard term orderings regard the same term as “leading”:

```
degreevec(poly(x^2*z + x*z^3 + 1, [x]), LexOrder),  
degreevec(poly(x^2*z + x*z^3 + 1, [x]), DegreeOrder),  
degreevec(poly(x^2*z + x*z^3 + 1, [x]), DegInvLexOrder)
```

```
[2], [2], [2]
```

In the multivariate case, different polynomial orderings may yield different leading exponent vectors:

```
degreevec(poly(x^2*z + x*z^3 + 1, [x, z])),  
degreevec(poly(x^2*z + x*z^3 + 1, [x, z]), DegreeOrder)
```

```
[2, 1], [1, 3]
```

```
degreevec(x^3 + x*y^2*z - 5*y^4, [x, y, z], LexOrder),  
degreevec(x^3 + x*y^2*z - 5*y^4, [x, y, z], DegreeOrder),  
degreevec(x^3 + x*y^2*z - 5*y^4, [x, y, z], DegInvLexOrder)
```

```
[3, 0, 0], [1, 2, 1], [0, 4, 0]
```

### Example 3

The exponent vector of the zero polynomial is a list of zeroes:

```
degreevec(0, [x, y, z])
```

```
[0, 0, 0]
```

## Parameters

**p**

A polynomial (Symbolic Math Toolbox) of type `DOM_POLY`

**f**

A polynomial expression (Symbolic Math Toolbox)

**vars**

A list on page 7-41 of indeterminates of the polynomial: typically, identifiers on page 7-29 or indexed identifiers on page 1-1017

**order**

The term ordering: either `LexOrder`, or `DegreeOrder`, or `DegInvLexOrder`, or a user-defined term ordering of type `Dom::MonomOrdering`. The default is the lexicographical ordering `LexOrder`.

## Return Values

List of nonnegative integers. `FAIL` is returned if the input cannot be converted to a polynomial.

## Overloaded By

f, p

## See Also

### **MuPAD Functions**

`coeff` | `degree` | `ground` | `lcoeff` | `ldegree` | `lmonomial` | `lterm` | `monomials` | `nterms` | `nthcoeff` | `nthmonomial` | `nthterm` | `poly` | `poly2list` | `tcoeff`

# delete\_delete

Delete the value of an identifier

## Syntax

```
delete x1, x2, ...  
_delete(x1, x2, ...)
```

## Description

The statement `delete x` deletes the value of the identifier `x`.

For many computations, symbolic variables are needed. E.g., solving on page 1-259 (Symbolic Math Toolbox) an equation for an unknown `x` requires an identifier `x` that does not have a value. If `x` has a value, the statement `delete x` deletes the value and `x` can be used as a symbolic variable.

The statement `delete x1, x2, ...` is equivalent to the function call `_delete(x1, x2, ...)`. The values of all specified identifiers are deleted.

The statement `delete x[j]` deletes the entry `j` of a list on page 7-41, an array on page 7-2, an `hfarray` on page 7-27, or a table on page 1-2103 named `x`. Deletion of elements or entries reduces the size of lists and tables, respectively.

If `x` is an identifier carrying properties (Symbolic Math Toolbox) set via `assume`, then `delete x` detaches all properties from `x`, i.e., `delete x` has the same effect as `unassume(x)`. Cf. "Example 3" on page 1-501 (Symbolic Math Toolbox).

## Examples

### Example 1

The identifiers `x`, `y` are assigned values. After deletion, the identifiers have no values any longer:

```
x := 42: y := 7: delete x: x, y
```

```
x, 7
```

```
delete y: x, y
```

```
x, y
```

More than one identifier can be deleted by one call:

```
a := b := c := 42: a, b, c
```

```
42, 42, 42
```

```
delete a, b, c: a, b, c
```

```
a, b, c
```

## Example 2

`delete` can also be used to delete specific elements of lists on page 7-41, arrays on page 7-2, hfarrays on page 7-27, and tables on page 1-2103:

```
L := [7, 13, 42]
```

```
[7, 13, 42]
```

```
delete L[2]: L
```

```
[7, 42]
```

```
A := array(1..3, [7, 13, 42])
```

```
(7 13 42)
```

```
delete A[2]: A, A[2]
```

( 7 NIL 42 ),  $A_2$

`T := table(1 = 7, 2 = 13, 3 = 42)`

1	7
2	13
3	42

`delete T[2]: T`

1	7
3	42

Note that `delete` does not evaluate the objects that are to be deleted. In the following, an element of the list `U` is deleted. The original value of `U` (the list `L`) is not changed:

`U := L: delete U[1]: U, L`

[42], [7, 42]

Finally, all assigned values are deleted:

`delete U, L, A, T: U, L, A, T`

$U, L, A, T$

### Example 3

`delete` can also be used to delete properties of identifiers set via `assume`. With the assumption "`x > 1`", the expression `ln(x)` has the property "`ln(x) > 0`", i.e., its sign is 1:

`assume(x > 1): sign(ln(x))`

1

Without a property of `x`, the function `sign` cannot determine the sign of `ln(x)`:

```
delete x: sign(ln(x))
```

```
sign(ln(x))
```

## Parameters

$x_1, x_2, \dots$

identifiers on page 7-29 or indexed identifiers on page 1-1017

## Return Values

Void object of type DOM\_NULL.

## See Also

### MuPAD Functions

:= | `_assign` | `assign` | `assignElements` | `evalassign`



# denom

Denominator of a rational expression

## Syntax

`denom(f)`

## Description

`denom(f)` returns the denominator of the expression `f`.

`denom` regards the input as a rational expression (Symbolic Math Toolbox): non-rational subexpressions such as  $\sin(x)$ ,  $x^{1/2}$  etc. are internally replaced by “temporary variables”. The denominator of this rationalized expression is computed, the temporary variables are finally replaced by the original subexpressions.

---

**Note** Numerator and denominator are not necessarily cancelled: the denominator returned by `denom` may have a non-trivial gcd with the numerator returned by `numer`. Pre-process the expression by `normal` to enforce cancellation of common factors. Cf. “Example 2” on page 1-504 (Symbolic Math Toolbox).

---

## Examples

### Example 1

We compute the denominators of some expressions:

```
denom(-3/4)
```

```
4
```

```
denom(x + 1/(2/3*x - 2/x))
```

$$2x^2 - 6$$

```
denom((cos(x)^2 - 1)/(cos(x) - 1))
```

$$\cos(x) - 1$$

## Example 2

denom performs no cancellations if the rational expression is of the form “numerator/denominator”:

```
r := (x^2 - 1)/(x^3 - x^2 + x - 1); denom(r)
```

$$x^3 - x^2 + x - 1$$

This denominator has a common factor with the numerator of r; normal enforces cancellation of common factors:

```
denom(normal(r))
```

$$x^2 + 1$$

However, automatic normalization occurs if the input expression is a sum:

```
denom(r + x/(x + 1) + 1/(x + 1) - 1)
```

$$x^2 + 1$$

```
delete r:
```

## Parameters

**f**

An arithmetical expression (Symbolic Math Toolbox)

## Return Values

Arithmetical expression.

## Overloaded By

f

## See Also

### **MuPAD Functions**

factor | gcd | normal | numer

## densematrix

Create a matrix or a vector

### Syntax

`densematrix(Array)`

`densematrix(List)`

`densematrix(ListOfRows)`

`densematrix(Matrix)`

`densematrix(m, n)`

`densematrix(m, n, Array)`

`densematrix(m, n, List)`

`densematrix(m, n, ListOfRows)`

`densematrix(m, n, f)`

`densematrix(m, n, List, Diagonal)`

`densematrix(m, n, g, Diagonal)`

`densematrix(m, n, List, Banded)`

`densematrix(1, n, Array)`

`densematrix(1, n, List)`

`densematrix(m, 1, Array)`

`densematrix(m, 1, List)`

### Description

`densematrix(m, n, [[a11, a12, ...], [a21, a22, ...], ...])` returns the  $m \times n$  matrix

$$\begin{pmatrix} a_{11} & a_{12} & \dots \\ a_{21} & a_{22} & \dots \\ \vdots & \vdots & \vdots \end{pmatrix}$$

`densematrix(n, 1, [a1, a2, ...])` returns the  $n \times 1$  column vector

$$\begin{pmatrix} a_{11} \\ a_{21} \\ \vdots \end{pmatrix}$$

`densematrix(1, n, [a1, a2, ...])` returns the  $1 \times n$  row vector

$$(a_{11} \ a_{21} \ \dots)$$

`densematrix` creates matrices and vectors. A vector with  $n$  entries is either an  $n \times 1$  matrix (a column vector) or a  $1 \times n$  matrix (a row vector).

Matrix and vector components must be arithmetical expressions (Symbolic Math Toolbox). For specific component domains, refer to the help page of `Dom::DenseMatrix`.

Arithmetical operations with matrices can be performed by using the standard arithmetical operators of MuPAD.

E.g., if  $A$  and  $B$  are two matrices defined by `densematrix`, then  $A + B$  computes the sum and  $A * B$  computes the product of the two matrices, provided that the dimensions are correct.

Similarly,  $A^{-1}$  or  $1/A$  computes the inverse of a square matrix  $A$  if it exists. Otherwise, FAIL is returned.

See “Example 1” on page 1-510 (Symbolic Math Toolbox).

Many system functions accept matrices as input, such as `map`, `subs`, `has`, `zip`, `conjugate` to compute the complex conjugate of a matrix, `norm` to compute matrix norms, or even `exp` to compute the exponential of a matrix. See “Example 4” on page 1-513 (Symbolic Math Toolbox).

Most of the functions in the MuPAD linear algebra package `linalg` (Symbolic Math Toolbox) work with matrices. For example, the command `linalg::gaussJordan(A)`

performs Gauss-Jordan elimination on  $A$  to transform  $A$  to its reduced row echelon form. See “Example 2” on page 1-512 (Symbolic Math Toolbox).

See the help page of `linalg` (Symbolic Math Toolbox) for a list of available functions of this package.

`densematrix` is an abbreviation for the domain `Dom::DenseMatrix()`. You find more information about this data type for matrices on the corresponding help page.

Matrix components can be extracted by the usual index operator `[ ]`, which also works for lists on page 7-41, arrays on page 7-2, `hfarrays` on page 7-27, and tables on page 1-2103. The call `A[i, j]` extracts the matrix component in the  $i$ th row and the  $j$ th column.

Assignments on page 1-257 to matrix components are performed similarly. The call `A[i, j] := c` replaces the matrix component in the  $i$ th row and the  $j$ th column of  $A$  by  $c$ .

If one of the indices is not in its valid range, then an error message is issued.

The index operator also extracts submatrices. The call `A[r1..r2, c1..c2]` creates the submatrix of  $A$  comprising the rows with the indices  $r_1, r_1 + 1, \dots, r_2$  and the columns with the indices  $c_1, c_1 + 1, \dots, c_2$  of  $A$ .

See “Example 3” on page 1-512 (Symbolic Math Toolbox) and “Example 5” on page 1-515 (Symbolic Math Toolbox).

`densematrix(Array)` or `densematrix(Matrix)` create a new matrix with the same dimension and the components of `Array` or `Matrix`, respectively. The array on page 7-2 must not contain any uninitialized entries. If `Array` is one-dimensional, then the result is a column vector. Cf. “Example 7” on page 1-518 (Symbolic Math Toolbox).

`densematrix(List)` creates an  $m \times 1$  column vector with components taken from the nonempty list on page 7-41, where  $m$  is the number of entries of `List`. See “Example 5” on page 1-515 (Symbolic Math Toolbox).

`densematrix(ListOfRows)` creates an  $m \times n$  matrix with components taken from the nested list on page 7-41 `ListOfRows`, where  $m$  is the number of inner lists of `ListOfRows`, and  $n$  is the maximal number of elements of an inner list. Each inner list corresponds to a row of the matrix. Both  $m$  and  $n$  must be non-zero.

If an inner list has less than  $n$  entries, then the remaining components in the corresponding row of the matrix are set to zero. See “Example 6” on page 1-517 (Symbolic Math Toolbox).

It might be a good idea first to create a two-dimensional array on page 7-2 from that list before calling `densematrix`. This is due to the fact that creating a matrix from an array is the fastest way one can achieve. However, in this case the sublists must have the same number of elements.

The call `densematrix(m, n)` returns the  $m \times n$  zero matrix.

The call `densematrix(m, n, Array)` creates an  $m \times n$  matrix with components taken from `Array`, which must be an array on page 7-2 or an `hfarray` on page 7-27. `Array` must have  $m n$  operands. The first  $m$  operands define the first row, the next  $m$  operands define the second row, etc. The formatting of the array is irrelevant. E.g., any array with 6 elements can be used to create matrices of dimension  $1 \times 6$ , or  $2 \times 3$ , or  $3 \times 2$ , or  $6 \times 1$ .

`densematrix(m, n, List)` creates an  $m \times n$  matrix with components taken row after row from the non-empty list on page 7-41. The list must contain  $m n$  entries. Cf. "Example 6" on page 1-517 (Symbolic Math Toolbox).

`densematrix(m, n, ListOfRows)` creates an  $m \times n$  matrix with components taken from the list on page 7-41 `ListOfRows`.

If  $m \geq 2$  and  $n \geq 2$ , then `ListOfRows` must consist of at most  $m$  inner lists, each having at most  $n$  entries. The inner lists correspond to the rows of the returned matrix.

If an inner list has less than  $n$  entries, then the remaining components of the corresponding row of the matrix are set to zero. If there are less than  $m$  inner lists, then the remaining lower rows of the matrix are filled with zeroes. See "Example 6" on page 1-517 (Symbolic Math Toolbox).

`densematrix(m, n, f)` returns the matrix whose  $(i, j)$ th component is  $f(i, j)$ . The row index  $i$  runs from 1 to  $m$  and the column index  $j$  from 1 to  $n$ . See "Example 8" on page 1-519 (Symbolic Math Toolbox).

`densematrix(m, 1, Array)` returns the  $m \times 1$  column vector with components taken from `Array`. The array or `hfarray` `Array` must have  $m$  entries.

`densematrix(m, 1, List)` returns the  $m \times 1$  column vector with components taken from `List`. The list `List` must have at most  $m$  entries. If there are fewer entries, then the remaining vector components are set to zero. See "Example 5" on page 1-515 (Symbolic Math Toolbox).

`densematrix(1, n, Array)` returns the  $1 \times n$  row vector with components taken from `Array`. The array or `hfarray Array` must have  $n$  entries.

`densematrix(1, n, List)` returns the  $1 \times n$  row vector with components taken from `List`. The list `List` must have at most  $n$  entries. If there are fewer entries, then the remaining vector components are set to zero. See “Example 5” on page 1-515 (Symbolic Math Toolbox).

---

**Note** The components of a matrix are no longer evaluated after the creation of the matrix, i.e., if they contain free identifiers they will not be replaced by their values.

---

## Examples

### Example 1

We create the  $2 \times 2$  matrix

$$\begin{pmatrix} 1 & 5 \\ 2 & 3 \end{pmatrix}$$

by passing a list of two rows to `densematrix`, where each row is a list of two elements, as follows:

```
A := densematrix([[1, 5], [2, 3]])
```

$$\begin{pmatrix} 1 & 5 \\ 2 & 3 \end{pmatrix}$$

In the same way, we generate the following  $2 \times 3$  matrix:

```
B := densematrix([[-1, 5/2, 3], [1/3, 0, 2/5]])
```

$$\begin{pmatrix} -1 & \frac{5}{2} & 3 \\ \frac{1}{3} & 0 & \frac{2}{5} \end{pmatrix}$$



We can do matrix arithmetic using the standard arithmetical operators of MuPAD. For example, the matrix product  $AB$ , the 4th power of  $A$ , and the scalar multiplication of  $A$  by  $\frac{1}{3}$  are given by:

$A * B, A^4, 1/3 * A$

$$\begin{pmatrix} \frac{2}{3} & \frac{5}{2} & 5 \\ -1 & 5 & \frac{36}{5} \end{pmatrix}, \begin{pmatrix} 281 & 600 \\ 240 & 521 \end{pmatrix}, \begin{pmatrix} \frac{1}{3} & \frac{5}{3} \\ \frac{2}{3} & 1 \end{pmatrix}$$

Since the dimensions of the matrices  $A$  and  $B$  differ, the sum of  $A$  and  $B$  is not defined and MuPAD returns an error message:

$A + B$

Error: Dimensions do not match. [(Dom::DenseMatrix(Dom::ExpressionField()))::\_plus]

To compute the inverse of  $A$ , enter:

$1/A$

$$\begin{pmatrix} -\frac{3}{7} & \frac{5}{7} \\ \frac{2}{7} & -\frac{1}{7} \end{pmatrix}$$

If a matrix is not invertible, then the result of this operation is FAIL:

$C := \text{densematrix}([[2, 0], [0, 0]])$

$$\begin{pmatrix} 2 & 0 \\ 0 & 0 \end{pmatrix}$$

$C^{(-1)}$

FAIL

## Example 2

In addition to standard matrix arithmetic, the library `linalg` (Symbolic Math Toolbox) offers a lot of functions handling matrices. For example, the function `linalg::rank` determines the rank of a matrix:

```
A := densematrix([[1, 5], [2, 3]])
```

$$\begin{pmatrix} 1 & 5 \\ 2 & 3 \end{pmatrix}$$

```
linalg::rank(A)
```

2

The function `linalg::eigenvectors` computes the eigenvalues and the eigenvectors of A:

```
linalg::eigenvectors(A)
```

$$\left[ \left[ 2 - \sqrt{11}, 1, \begin{bmatrix} -\frac{\sqrt{11}}{2} - \frac{1}{2} \\ 1 \end{bmatrix} \right], \left[ \sqrt{11} + 2, 1, \begin{bmatrix} \frac{\sqrt{11}}{2} - \frac{1}{2} \\ 1 \end{bmatrix} \right] \right]$$

To determine the dimension of a matrix use the function `linalg::matdim`:

```
linalg::matdim(A)
```

[2, 2]

The result is a list of two positive integers, the row and column number of the matrix.

Use `info(linalg)` to obtain a list of available functions, or enter `?linalg` for details about this library.

## Example 3

Matrix entries can be accessed with the index operator `[ ]`:

```
A := densematrix([[1, 2, 3, 4], [2, 0, 4, 1], [-1, 0, 5, 2]])
```

$$\begin{pmatrix} 1 & 2 & 3 & 4 \\ 2 & 0 & 4 & 1 \\ -1 & 0 & 5 & 2 \end{pmatrix}$$

```
A[2, 1] * A[1, 2] - A[3, 1] * A[1, 3]
```

```
7
```

You can redefine a matrix entry by assigning a value to it:

```
A[1, 2] := a^2: A
```

$$\begin{pmatrix} 1 & a^2 & 3 & 4 \\ 2 & 0 & 4 & 1 \\ -1 & 0 & 5 & 2 \end{pmatrix}$$

The index operator can also be used to extract submatrices. The following call creates a copy of the submatrix of  $A$  comprising the second and the third row and the first three columns of  $A$ :

```
A[2..3, 1..3]
```

$$\begin{pmatrix} 2 & 0 & 4 \\ -1 & 0 & 5 \end{pmatrix}$$

The index operator does *not* allow to replace a submatrix of a given matrix by another matrix. Use `linalg::substitute` to achieve this.

## Example 4

Some system functions can be applied to matrices. For example, if you have a matrix with symbolic entries and want to have all entries in expanded form, simply apply the function `expand`:

```
delete a, b:
A := densematrix([
```

```
[(a - b)^2, a^2 + b^2],
[a^2 + b^2, (a - b)*(a + b)]
])
```

$$\begin{pmatrix} (a-b)^2 & a^2+b^2 \\ a^2+b^2 & (a+b)(a-b) \end{pmatrix}$$

```
expand(A)
```

$$\begin{pmatrix} a^2-2ab+b^2 & a^2+b^2 \\ a^2+b^2 & a^2-b^2 \end{pmatrix}$$

You can differentiate all matrix components with respect to some indeterminate:

```
diff(A, a)
```

$$\begin{pmatrix} 2a-2b & 2a \\ 2a & 2a \end{pmatrix}$$

The following command evaluates all matrix components at a given point:

```
subs(A, a = 1, b = -1)
```

$$\begin{pmatrix} 4 & 2 \\ 2 & 0 \end{pmatrix}$$

Note that the function `subs` does not evaluate the result of the substitution. For example, we define the following matrix:

```
A := densematrix([[sin(x), x], [x, cos(x)]])
```

$$\begin{pmatrix} \sin(x) & x \\ x & \cos(x) \end{pmatrix}$$

Then we substitute  $x = 0$  in each matrix component:

```
B := subs(A, x = 0)
```

$$\begin{pmatrix} \sin(0) & 0 \\ 0 & \cos(0) \end{pmatrix}$$

You see that the matrix components are not evaluated completely: for example, if you enter `sin(0)` directly, it evaluates to zero.

The function `eval` can be used to evaluate the result of the function `subs`. However, `eval` does not operate on matrices directly, and you must use the function `map` to apply the function `eval` to each matrix component:

```
map(B, eval)
```

$$\begin{pmatrix} 0 & 0 \\ 0 & 1 \end{pmatrix}$$

The function `zip` can be applied to matrices. The following call combines two matrices  $A$  and  $B$  by dividing each component of  $A$  by the corresponding component of  $B$ :

```
A := densematrix([[4, 2], [9, 3]]):
B := densematrix([[2, 1], [3, -1]]):
zip(A, B, '/')
```

$$\begin{pmatrix} 2 & 2 \\ 3 & -3 \end{pmatrix}$$

## Example 5

A vector is either an  $m \times 1$  matrix (a column vector) or a  $1 \times n$  matrix (a row vector). To create a vector with `densematrix`, pass the dimension of the vector and a list of vector components as argument to `densematrix`:

```
row_vector := densematrix(1, 3, [1, 2, 3]);
column_vector := densematrix(3, 1, [1, 2, 3])
```

$$(1 \ 2 \ 3)$$

$$\begin{pmatrix} 1 \\ 2 \\ 3 \end{pmatrix}$$

If the only argument of `densematrix` is a non-nested list or a one-dimensional array, then the result is a column vector:

```
densematrix([1, 2, 3])
```

$$\begin{pmatrix} 1 \\ 2 \\ 3 \end{pmatrix}$$

For a row vector `r`, the calls `r[1, i]` and `r[i]` both return the *i*th vector component of `r`. Similarly, for a column vector `c`, the calls `c[i, 1]` and `c[i]` both return the *i*th vector component of `c`.

For example, to extract the second component of the vectors `row_vector` and `column_vector`, we enter:

```
row_vector[2], column_vector[2]
```

2, 2

Use the function `linalg::vecdim` to determine the number of components of a vector:

```
linalg::vecdim(row_vector), linalg::vecdim(column_vector)
```

3, 3

The number of components of a vector can also be determined directly by the call `nops(vector)`.

The dimension of a vector can be determined as described above in the case of matrices:

```
linalg::matdim(row_vector),  
linalg::matdim(column_vector)
```

[1, 3], [3, 1]

See the `linalg` (Symbolic Math Toolbox) package for functions working with vectors, and the help page of `norm` for computing vector norms.

## Example 6

In the following examples, we illustrate various calls of `densematrix` as described above. We start by passing a nested list to `densematrix`, where each inner list corresponds to a row of the matrix:

```
densematrix([[1, 2], [2]])
```

$$\begin{pmatrix} 1 & 2 \\ 2 & 0 \end{pmatrix}$$

The number of rows of the created matrix is the number of inner lists, namely  $m = 2$ . The number of columns is determined by the maximal number of entries of an inner list. In the example above, the first list is the longest one, and hence  $n = 2$ . The second list has only one element, and therefore the second entry in the second row of the returned matrix was set to zero.

In the following call, we use the same nested list, but in addition pass two dimension parameters to create a  $4 \times 4$  matrix:

```
densematrix(4, 4, [[1, 2], [2]])
```

$$\begin{pmatrix} 1 & 2 & 0 & 0 \\ 2 & 0 & 0 & 0 \\ 0 & 0 & 0 & 0 \\ 0 & 0 & 0 & 0 \end{pmatrix}$$

In this case, the dimension of the matrix is given by the dimension parameters. As before, missing entries in an inner list correspond to zero, and in addition missing rows are treated as zero rows.

If the dimension  $m \times n$  of the matrix is stated explicitly, the entries may also be specified by a plain list with  $m n$  elements. The matrix is filled with these elements row by row:

```
densematrix(2, 3, [1, 2, 3, 4, 5, 6])
```

$$\begin{pmatrix} 1 & 2 & 3 \\ 4 & 5 & 6 \end{pmatrix}$$

```
densematrix(3, 2, [1, 2, 3, 4, 5, 6])
```

$$\begin{pmatrix} 1 & 2 \\ 3 & 4 \\ 5 & 6 \end{pmatrix}$$

### Example 7

A one- or two-dimensional array of arithmetical expressions, such as:

```
a := array(1..3, 2..4, [[ 1, 1/3, 0 ],  
                        [-2, 3/5, 1/2],  
                        [-3/2, 0, -1 ]])
```

$$\begin{pmatrix} 1 & \frac{1}{3} & 0 \\ -2 & \frac{3}{5} & \frac{1}{2} \\ -\frac{3}{2} & 0 & -1 \end{pmatrix}$$

can be converted into a matrix as follows:

```
A := densematrix(a)
```

$$\begin{pmatrix} 1 & \frac{1}{3} & 0 \\ -2 & \frac{3}{5} & \frac{1}{2} \\ -\frac{3}{2} & 0 & -1 \end{pmatrix}$$

Arrays serve, for example, as an efficient structured data type for programming. However, arrays do not have any algebraic meaning, and no mathematical operations are defined for them. If you convert an array into a matrix, you can use the full functionality defined for matrices as described above. For example, let us compute the matrix  $2A - A^2$  and the Frobenius norm of  $A$ :

```
2*A - A^2, norm(A, Frobenius)
```



$$\begin{pmatrix} \frac{5}{3} & \frac{2}{15} & -\frac{1}{6} \\ -\frac{1}{20} & \frac{113}{75} & \frac{6}{5} \\ -3 & \frac{1}{2} & -3 \end{pmatrix}, \frac{\sqrt{450} \sqrt{4037}}{450}$$

Note that an array may contain uninitialized entries:

```
b := array(1..4): b[1] := 2: b[4] := 0: b
```

```
(2 NIL NIL 0)
```

`densematrix` cannot handle arrays that have uninitialized entries, and responds with an error message:

```
densematrix(b)
```

```
Error: Unable to define a matrix over 'Dom::ExpressionField()'. [(Dom::DenseMatrix(Dom
```

We initialize the remaining entries of the array `b` and convert it into a matrix, or more precisely, into a column vector:

```
b[2] := 0: b[3] := -1: densematrix(b)
```

$$\begin{pmatrix} 2 \\ 0 \\ -1 \\ 0 \end{pmatrix}$$

## Example 8

We show how to create a matrix whose components are defined by a function of the row and the column index. The entry in the  $i$ th row and the  $j$ th column of a Hilbert matrix (see

also `linalg::hilbert`) is  $\frac{1}{(i+j-1)}$ . Thus the following command creates a  $2 \times 2$  Hilbert matrix:

```
densematrix(2, 2, (i, j) -> 1/(i + j - 1))
```

$$\begin{pmatrix} 1 & \frac{1}{2} \\ \frac{1}{2} & \frac{1}{3} \end{pmatrix}$$

The following two calls produce different results. In the first call, `x` is regarded as an unknown function, while it is a constant in the second call:

```
delete x:  
densematrix(2, 2, x), densematrix(2, 2, (i, j) -> x)
```

$$\begin{pmatrix} x(1, 1) & x(1, 2) \\ x(2, 1) & x(2, 2) \end{pmatrix}, \begin{pmatrix} x & x \\ x & x \end{pmatrix}$$

## Example 9

Diagonal matrices can be created by passing the option `Diagonal` and a list of diagonal entries:

```
densematrix(3, 4, [1, 2, 3], Diagonal)
```

$$\begin{pmatrix} 1 & 0 & 0 & 0 \\ 0 & 2 & 0 & 0 \\ 0 & 0 & 3 & 0 \end{pmatrix}$$

Hence, you can generate the 3×3 identity matrix as follows:

```
densematrix(3, 3, [1 $ 3], Diagonal)
```

$$\begin{pmatrix} 1 & 0 & 0 \\ 0 & 1 & 0 \\ 0 & 0 & 1 \end{pmatrix}$$

Equivalently, you can use a function of one argument:

```
densematrix(3, 3, i -> 1, Diagonal)
```

$$\begin{pmatrix} 1 & 0 & 0 \\ 0 & 1 & 0 \\ 0 & 0 & 1 \end{pmatrix}$$

Since the integer 1 also represents a constant function, the following shorter call creates the same matrix:

```
densematrix(3, 3, 1, Diagonal)
```

$$\begin{pmatrix} 1 & 0 & 0 \\ 0 & 1 & 0 \\ 0 & 0 & 1 \end{pmatrix}$$

## Example 10

Banded Toeplitz matrices (see above) can be created with the option `Banded`. The following command creates a matrix of bandwidth 3 with all main diagonal entries equal to 2 and all entries on the first sub- and superdiagonal equal to -1:

```
densematrix(4, 4, [-1, 2, -1], Banded)
```

$$\begin{pmatrix} 2 & -1 & 0 & 0 \\ -1 & 2 & -1 & 0 \\ 0 & -1 & 2 & -1 \\ 0 & 0 & -1 & 2 \end{pmatrix}$$

## Parameters

### Array

A one- or two-dimensional array on page 7-2 of type `DOM_ARRAY` or `DOM_HFARRAY`

### List

A list on page 7-41 of arithmetical expressions (Symbolic Math Toolbox)

### ListOfRows

A nested list on page 7-41 of rows, each row being a list of arithmetical expressions (Symbolic Math Toolbox)

## **Matrix**

A matrix, i.e., an object of a data type of category `Cat::Matrix`

### **m**

The number of rows: a positive integer on page 7-31

### **n**

The number of columns: a positive integer on page 7-31

### **f**

A function (Symbolic Math Toolbox) or a functional expression (Symbolic Math Toolbox) of two arguments

### **g**

A function or a functional expression of one argument

## **Options**

### **Diagonal**

Create a diagonal matrix

With the option `Diagonal`, diagonal matrices can be created with diagonal elements taken from a list on page 7-41, or computed by a function (Symbolic Math Toolbox) or a functional expression (Symbolic Math Toolbox).

`densematrix(m, n, List, Diagonal)` creates the  $m \times n$  diagonal matrix whose diagonal elements are the entries of `List`. See “Example 9” on page 1-520 (Symbolic Math Toolbox).

`List` must have at most  $\min(m, n)$  entries. If it has fewer elements, then the remaining diagonal elements are set to zero.

`densematrix(m, n, g, Diagonal)` returns the matrix whose  $i$ th diagonal element is  $g(i, i)$ , where the index  $i$  runs from 1 to  $\min(m, n)$ . See “Example 9” on page 1-520 (Symbolic Math Toolbox).

## Banded

Create a banded Toeplitz matrix

A *banded matrix* has all entries zero outside the main diagonal and some of the adjacent sub- and superdiagonals.

`densematrix(m, n, List, Banded)` creates an  $m \times n$  banded Toeplitz matrix with the elements of `List` as entries. The number of entries of `List` must be odd, say  $2h + 1$ , and must not exceed  $n$ . The bandwidth of the resulting matrix is at most  $h$ .

All elements of the main diagonal of the created matrix are initialized with the middle element of `List`. All elements of the  $i$ th subdiagonal are initialized with the  $(h + 1 - i)$ th element of `List`. All elements of the  $i$ th superdiagonal are initialized with the  $(h + 1 + i)$ th element of `List`. All entries on the remaining sub- and superdiagonals are set to zero.

See “Example 10” on page 1-521 (Symbolic Math Toolbox).

## Return Values

Matrix of the domain type (Symbolic Math Toolbox)`Dom::DenseMatrix()`.

## See Also

### MuPAD Domains

`DOM_ARRAY` | `DOM_HFARRAY` | `Dom::DenseMatrix` | `Dom::Matrix`

### MuPAD Functions

`array` | `hfarray` | `matrix`

# det

Determinant of a matrix

## Syntax

`det(A, options)`

## Description

`det(A)` returns the determinant of the matrix  $A$ .

If the input matrix is an array of domain type `DOM_ARRAY`, then `numeric::det(A, Symbolic)` is called to compute the result.

The determinant of hfarrays of domain type `DOM_HFARRAY` is internally computed via `numeric::det(A)`.

If the argument does not evaluate to a matrix of one of the types mentioned above, a symbolic call `det(A)` is returned.

The `MinorExpansion` option is useful for small matrices (typically, matrices of dimension up to 10) containing many symbolic entries. By default, `det` tries to recognize matrices that can benefit from using `MinorExpansion`, and uses this option when computing their determinants. Nevertheless, `det` does not always recognize these matrices. Also, identifying that a matrix is small enough and contains many symbolic entries takes time. To improve performance, use the `MinorExpansion` option explicitly.

By default, `det` calls `normal` before returning results. This additional internal call ensures that the final result is normalized. This call can be computationally expensive. It also affects the result returned by `det` only if a matrix contains variables or exact expressions, such as `sqrt(5)` or `sin(PI/7)`.

To avoid this additional call, specify `Normal = FALSE`. In this case, `det` also can return normalized results, but does not guarantee such normalization. See “Example 3” on page 1-526 (Symbolic Math Toolbox) and “Example 4” on page 1-526 (Symbolic Math Toolbox).

## Examples

### Example 1

We compute the determinant of a matrix given by various data types:

```
A := array(1..2, 1..2, [[1, 2], [3, PI]]);
det(A)
```

$$\begin{pmatrix} 1 & 2 \\ 3 & \pi \end{pmatrix}$$

$$\pi - 6$$

```
B := hfarray(1..2, 1..2, [[1, 2], [3, PI]]);
det(B)
```

$$\begin{pmatrix} 1.0 & 2.0 \\ 3.0 & 3.141592654 \end{pmatrix}$$

$$-2.858407346$$

```
C := matrix(2, 2, [[1, 2], [3, PI]]);
det(C)
```

$$\begin{pmatrix} 1 & 2 \\ 3 & \pi \end{pmatrix}$$

$$\pi - 6$$

```
delete A, B, C;
```

### Example 2

If the input does not evaluate to a matrix, then symbolic calls are returned:

```
delete A, B:  
det(A + 2*B)
```

$\det(A + 2B)$

### Example 3

If you use the `Normal` option, `det` calls the `normal` function for final results. This call ensures that `det` returns results in normalized form:

```
det(matrix([[x, x^2], [x/(x + 2), 1/x]]))
```

$$\frac{-x^3 + x + 2}{x + 2}$$

If you specify `Normal = FALSE`, `det` does not call `normal` for the final result:

```
det(matrix([[x, x^2], [x/(x + 2), 1/x]]), Normal = FALSE)
```

$$1 - \frac{x^3}{x + 2}$$

### Example 4

Using `Normal` can significantly decrease performance of `det`. For example, computing the determinant of this matrix takes a long time:

```
n := 5:  
det5 := det(matrix([[x[i*j]^(i + j) + x[i+j]^j]/(i + j) $  
                    j = 1..n] $  
                    i = 1..n])):
```

For better performance, specify `Normal = FALSE`:

```
n := 5:  
det5 := det(matrix([[x[i*j]^(i + j) + x[i+j]^j]/(i + j) $  
                    j = 1..n] $  
                    i = 1..n]),  
                  Normal = FALSE):
```



## Parameters

**A**

Square matrix: either a two-dimensional array, a two-dimensional harray, or an object of the category `Cat::Matrix`

## Options

### **MinorExpansion**

Compute the determinant by a recursive minor expansion along the first column.

### **Normal**

Option, specified as `Normal = b`

Return normalized results. The value `b` must be `TRUE` or `FALSE`. By default, `Normal = TRUE`, meaning that `det` guarantees normalization of the returned results. Normalizing results can be computationally expensive.

## Return Values

Arithmetical expression.

## Overloaded By

**A**

## See Also

### **MuPAD Functions**

`numeric::det`

**Topics**

“Compute Determinants and Traces of Square Matrices” (Symbolic Math Toolbox)

# diff

Differentiate an expression or a polynomial

## Syntax

`diff(f)`

`diff(f, x)`

`diff(f, x1, x2, ...)`

## Description

`diff(f, x)` computes the derivative  $\frac{\partial}{\partial x} f$  of the function  $f$  with respect to the variable  $x$ .

`diff(f, x)` computes the partial derivative of the arithmetical expression (Symbolic Math Toolbox) (or polynomial (Symbolic Math Toolbox))  $f$  with respect to the indeterminate  $x$ .

`diff(f)` computes the 0th derivative of  $f$ . Since the 0th derivative of  $f$  is  $f$  itself, `diff(f)` returns its evaluated argument.

`diff(f, x1, x2, ...)` is equivalent to `diff(...diff(diff(f, x1), x2)...)...`. In both cases, MuPAD first differentiates  $f$  with respect to  $x_1$ , then differentiates the result

with respect to  $x_2$ , and so on. The result is the partial derivative  $\dots \frac{\partial}{\partial x_1} \frac{\partial}{\partial x_2} f$ . See “Example 2” on page 1-531 (Symbolic Math Toolbox).

If you use nested `diff` calls, the system internally converts them into a single `diff` call with multiple arguments. See “Example 3” on page 1-532 (Symbolic Math Toolbox).

When computing the second and higher derivatives, use the sequence operator on page 1-80 as a shortcut. If  $n$  is a nonnegative integer, `diff(f, x $ n)` returns the  $n$ th derivative of  $f$  with respect to  $x$ . See “Example 4” on page 1-532 (Symbolic Math Toolbox).

The indeterminates  $x$ ,  $x_1$ ,  $x_2$ , ... must be identifiers of domain type `DOM_IDENT` or indexed identifiers on page 1-1017 of the form  $x[n]$  where  $x$  is an identifier and  $n$  is an integer. If any indeterminate comes in any other form, MuPAD returns an unresolved `diff` call. See "Example 5" on page 1-532 (Symbolic Math Toolbox).

If  $f$  is an arithmetical expression (Symbolic Math Toolbox), `diff` returns an arithmetical expression. If  $f$  is a polynomial (Symbolic Math Toolbox), `diff` returns a polynomial. See "Example 6" on page 1-532 (Symbolic Math Toolbox).

If the system cannot compute the derivative, it returns an unresolved `diff` call. See "Example 7" on page 1-533 (Symbolic Math Toolbox).

MuPAD assumes that partial derivatives with respect to different indeterminates commute. The function calls `diff(f, x1, x2)` and `diff(f, x2, x1)` produce the same result `diff(f, y1, y2)`. Here  $[y_1, y_2] = \text{sort}([x_1, x_2])$ . See "Example 8" on page 1-533 (Symbolic Math Toolbox).

MuPAD provides two functions, `diff` and `D`, for computing derivatives. Use the differential operator `D` to compute the derivatives of functions (Symbolic Math Toolbox). Use the `diff` function to compute the derivatives of arithmetical expressions (Symbolic Math Toolbox). Mathematically,  $D(f)(x)$  coincides with `diff(f(x), x)` and  $D([1, 2], f)(x, y)$  coincides with `diff(f(x, y), x, y)`. You can convert symbolic calls of `D` to the calls of `diff` and vice versa by using `rewrite`. See "Example 10" on page 1-534 (Symbolic Math Toolbox).

You can extend the functionality of `diff` for your own special mathematical functions via overloading (Symbolic Math Toolbox). This approach works by turning the corresponding function into a function environment on page 7-25 and implementing the differentiation rule for the function as the "diff" slot of the function environment.

If a subexpression of the form  $g(\dots)$  occurs in  $f$ , and  $g$  is a function environment on page 7-25, then `diff(f, x)` attempts to call the "diff" slot of  $g$  to determine the derivative of  $g(\dots)$ .

The system calls the "diff" slot with the arguments  $g(\dots)$ ,  $x$ .

If  $g$  does not have a "diff" slot, then the system function `diff` returns the symbolic expression `diff(g(\dots), x)` for the derivative of the subexpression.

The system always calls the "diff" slot with exactly two arguments. If you call the `diff` function with more indeterminates (for example, if you compute a higher derivative), then MuPAD calls the "diff" slot several times. Each call computes the derivative with

respect to one indeterminate. The system caches the results of the calls of "diff" slots in `diff` in order to prevent redundant function calls. See "Example 11" on page 1-535 (Symbolic Math Toolbox).

Similarly, if an element `d` of a library domain (Symbolic Math Toolbox) `T` occurs as a subexpression of `f`, then `diff(f, x)` calls the slot `T::diff(d, x)` to compute the derivative of `d`.

If the domain `T` does not have a "diff" slot, then `diff` considers this object as a constant and returns 0 for the corresponding subexpression.

If you differentiate an expression or function containing `abs` or `sign`, ensure that the arguments are real values. For complex arguments of `abs` and `sign`, the `diff` function formally computes the derivative, but this result is not generally valid because `abs` and `sign` are not differentiable over complex numbers.

## Examples

### Example 1

Compute the derivative of  $x^2$  with respect to  $x$ :

```
diff(x^2, x)
```

```
2 x
```

### Example 2

You can differentiate with respect to multiple variables within a single `diff` call. For example, differentiate this expression with respect to  $x$ , and then with differentiate the result with respect to  $y$ :

```
diff(x^2*sin(y), x, y) = diff(diff(x^2*sin(y), x), y)
```

```
2 x cos(y) = 2 x cos(y)
```

### Example 3

MuPAD internally converts nested `diff` calls into a single `diff` call with multiple arguments:

```
diff(diff(f(x, y), x), y)
```

$$\frac{\partial}{\partial y} \frac{\partial}{\partial x} f(x, y)$$

### Example 4

Use the sequence operator `$` as a shortcut to compute the third derivative of this expression with respect to `x`:

```
diff(sin(x)*cos(x), x $ 3)
```

$$4 \sin(x)^2 - 4 \cos(x)^2$$

### Example 5

You can differentiate with respect to an indexed identifier. For example, differentiate this expression with respect to `x[1]`:

```
diff(x[1]*y + x[1]*x[r], x[1])
```

$$y + x_r + \delta_{r-1,0} x_1$$

### Example 6

You can differentiate `polynomials` with respect to the polynomial indeterminates or the parameters in the coefficients. For example, differentiate this polynomial with respect to the indeterminate `x`:

```
diff(poly(sin(a)*x^3 + 2*x, [x]), x)
```

$$\text{poly}((3 \sin(a)) x^2 + 2, [x])$$

Now differentiate the same polynomial with respect to its symbolic parameter a:

```
diff(poly(sin(a)*x^3 + 2*x, [x]), a)
```

$$\text{poly}(\cos(a) x^3, [x])$$

### Example 7

MuPAD returns the derivative of an unknown function as an unresolved `diff` call:

```
diff(f(x) + x, x)
```

$$\frac{\partial}{\partial x} f(x) + 1$$

### Example 8

MuPAD assumes that all partial derivatives with respect to different indeterminates commute. Therefore, the system can change the order of indeterminates:

```
diff(f(x, y), x, y) = diff(f(x, y), y, x);
```

$$\frac{\partial}{\partial y} \frac{\partial}{\partial x} f(x, y) = \frac{\partial}{\partial y} \frac{\partial}{\partial x} f(x, y)$$

### Example 9

You can use `diff` to differentiate symbolic integrals. For example, compute the second derivative of this indefinite integral:

```
F1 := int(f(x), x):
diff(F1, x, x)
```

$$\frac{\partial}{\partial x} f(x)$$

Now compute the derivative of the definite integral:

```
F2 := int(f(t, x), t = x..x^2):
diff(F2, x)
```

$$\int_x^{x^2} \frac{\partial}{\partial x} f(t, x) dt - f(x, x) + 2x f(x^2, x)$$

### Example 10

Use the operator `D` to compute the derivatives of functions. Use the `diff` function to compute the derivatives of expressions:

```
D(sin), diff(sin(x), x)
```

```
cos, cos(x)
```

Applying `D` to expressions and `diff` to functions makes no sense:

```
D(sin(x)), diff(sin, x)
```

```
(sin(x))', 0
```

Use the `rewrite` function to rewrite an expression replacing the operator `D` with the `diff` function:

```
rewrite(D(f)(x), diff), rewrite(D(D(f))(x), diff)
```

$$\frac{\partial}{\partial x} f(x), \frac{\partial^2}{\partial x^2} f(x)$$

Also, use `rewrite` to rewrite an expression replacing `diff` with `D`:

```
diff(f(x, x), x) = rewrite(diff(f(x, x), x), D)
```

$$\frac{\partial}{\partial x} f(x, x) = D_1(f)(x, x) + D_2(f)(x, x)$$



## Example 11

You can extend `diff` to your own special functions. To do so, embed your function, `f`, into a function environment on page 7-25, `g`, and implement the behavior of `diff` for this function as the "diff" slot on page 1-1980 of the function environment.

If a subexpression of the form `g(...)` occurs in an expression `f`, then `diff(f, x)` calls `g::diff(g(...), x)` to determine the derivative of the subexpression `g(...)`.

This example demonstrates extending `diff` to the exponential function. Since the function environment `exp` already has a "diff" slot, call the new function environment `Exp` to avoid overwriting the existing system function `exp`.

Here, the "diff" slot implements the chain rule for the exponential function. The derivative is the product of the original function call and the derivative of the argument:

```
Exp := funcenv(Exp):
Exp::diff := proc(f, x)
begin
  // f = Exp(something), i.e., something = op(f, 1)
  f*diff(op(f, 1), x):
end_proc:
diff(Exp(x^2), x)
```

$$2 x \text{Exp}(x^2)$$

The report created by `prog::trace` shows one call to `Exp::diff` with two arguments. Instead of calling `Exp::diff` twice, the system reads the required result of the second call from an internal cache for intermediate results in `diff`:

```
prog::trace(Exp::diff):
diff(Exp(x^2), x, x)

enter Exp::diff(Exp(x^2), x)
computed 2*x*Exp(x^2)
```

$$2 \text{Exp}(x^2) + 4 x^2 \text{Exp}(x^2)$$

```
prog::untrace(Exp::diff): delete f, Exp:
```

## Parameters

**f**

An arithmetical expression (Symbolic Math Toolbox) or a polynomial (Symbolic Math Toolbox) of type `DOM_POLY`

**x, x1, x2, ...**

Indeterminates: identifiers on page 7-29 or indexed identifiers on page 1-1017

## Return Values

arithmetical expression (Symbolic Math Toolbox) or a polynomial (Symbolic Math Toolbox)

## Overloaded By

**f**

## See Also

### **MuPAD Functions**

`D` | `int` | `limit` | `poly` | `taylor`

## Topics

“Choose Differentiation Function” (Symbolic Math Toolbox)

“Differentiate Expressions” (Symbolic Math Toolbox)

“Differentiate Functions” (Symbolic Math Toolbox)

# DIGITS

Significant digits of floating-point numbers

## Description

The environment variable `DIGITS` determines the number of significant decimal digits in floating-point numbers. The default value is `DIGITS = 10`.

Possible values: a positive integer larger than 1 and smaller than  $2^{29} + 1$ .

Floating point numbers are created by applying the function `float` to exact numbers (Symbolic Math Toolbox) or numerical expressions (Symbolic Math Toolbox). Elementary objects are approximated by the resulting floats with a relative precision of  $10^{-(DIGITS)}$ , i.e., the first `DIGITS` decimal digits are correct. See “Example 1” on page 1-538 (Symbolic Math Toolbox).

In arithmetical operations with floating-point numbers, only the first `DIGITS` decimal digits are taken into account. The numerical error propagates and may grow in the course of computations. See “Example 2” on page 1-539 (Symbolic Math Toolbox).

If a real floating-point number is entered directly (e.g., by `x := 1.234`), a number with at least `DIGITS` internal decimal digits is created.

If a real float is entered with more than `DIGITS` digits, the internal representation stores the extra digits. However, they are not taken into account in arithmetical operations, unless `DIGITS` is increased accordingly. See “Example 3” on page 1-540 (Symbolic Math Toolbox).

In particular, complex floating-point numbers are created by adding the real and imaginary part. This addition truncates extra decimal places in the real and imaginary part.

The value of `DIGITS` may be changed at any time during a computation. If `DIGITS` is decreased, only the leading digits of existing floating numbers are taken into account in the following arithmetical operations. If `DIGITS` is increased, existing floating-point numbers are internally padded with trailing binary zeroes. See “Example 4” on page 1-540 (Symbolic Math Toolbox).

Depending on DIGITS, certain functions such as the trigonometric functions may give wrong results if floats as arguments are too inaccurate. See “Example 5” on page 1-541 (Symbolic Math Toolbox).

Depending on DIGITS, only significant digits of floating-point numbers are displayed on the screen. The preferences `Pref::floatFormat` and `Pref::trailingZeroes` can be used to modify the screen output. See “Example 4” on page 1-540 (Symbolic Math Toolbox).

At least one digit after the decimal point is displayed; if it is insignificant, it is replaced by zero. See “Example 6” on page 1-541 (Symbolic Math Toolbox).

Internally, floating-point numbers are created and stored with some extra “guard digits.” These are also taken into account by the basic arithmetical operations.

For example, for DIGITS = 10, the function `float` converts exact numbers to floats with some more decimal digits. The number of guard digits depends on DIGITS.

At least 2 internal guard digits are available for any value of DIGITS.

See “Example 4” on page 1-540 (Symbolic Math Toolbox) and “Example 7” on page 1-541 (Symbolic Math Toolbox).

Environment variables such as DIGITS are global variables. Upon return from a procedure that changes DIGITS, the new value is valid outside the context of the procedure as well! Use `save DIGITS` to restrict the modified value of DIGITS to the procedure. See “Example 8” on page 1-542 (Symbolic Math Toolbox).

The default value of DIGITS is 10; DIGITS has this value after starting or resetting the system via `reset`. Also the command `delete DIGITS;` restores the default value.

See the helppage of `float` for further information.

## Examples

### Example 1

We convert some exact numbers and numerical expressions to floating point approximations:

```
DIGITS := 10:
float(PI), float(1/7), float(sqrt(2) + exp(3)), float(exp(-20))
```

```
3.141592654, 0.1428571429, 21.49975049, 0.000000002061153622
```

```
DIGITS := 20:
float(PI), float(1/7), float(sqrt(2) + exp(3)), float(exp(-20))
```

```
3.1415926535897932385, 0.14285714285714285714, 21.49975048556076279,
0.000000002061153622438557828
```

```
delete DIGITS:
```

## Example 2

We illustrate error propagation in numerical computations. The following rational number approximates  $\exp(2)$  to 17 decimal digits:

```
r := 738905609893065023/100000000000000000:
```

The following `float` call converts `exp(2)` and `r` to floating point approximations. The approximation errors propagate and are amplified in the following numerical expression:

```
DIGITS := 6: float(10^20*(r - exp(2)))
```

```
16777200.0
```

None of the digits in this result is correct. A better result is obtained by increasing `DIGITS`:

```
DIGITS := 20: float(10^20*(r - exp(2)))
```

```
276.95725393295288086
```

```
delete r, DIGITS:
```

### Example 3

In the following, only 10 of the entered 30 digits are regarded as significant. The extra digits are stored internally, anyway:

```
DIGITS := 10:  
a := 1.23456789666666666666666666;  
b := 1.23456789444444444444444444
```

```
1.234567897
```

```
1.234567894
```

We increase DIGITS. Because the internal representation of a and b is correct to 30 decimal place, the difference can be computed correctly to 20 decimal places:

```
DIGITS := 30: a - b
```

```
0.000000002222222222222222222200000001
```

```
delete a, b, DIGITS:
```

### Example 4

We compute a floating-point number with a precision of 10 digits. Internally, this number is stored with some guard digits. Increasing DIGITS to 30, the correct guard digits become visible. With the the call `Pref::trailingZeroes(TRUE)`, trailing zeroes of the decimal representation become visible:

```
DIGITS := 10: a := float(1/9)
```

```
0.111111111
```

```
0.11111111111111111111014737584667955161421559751033782958984375
```

```
Pref::trailingZeroes(TRUE): DIGITS := 100: a
```

```
0.111111111111111111110147375846679551614215597510337829589843750000000000000000000000
```

`Pref::trailingZeroes(FALSE): delete a, DIGITS:`

## Example 5

For the float evaluation of the sine function, the argument is reduced to the standard interval  $[0, 2\pi]$ . For this reduction, the argument must be known to some digits after the decimal point. For small DIGITS, the digits after the decimal point are pure round-off if the argument is a large floating-point number:

```
DIGITS := 10: sin(float(2*10^30))
```

```
-0.6054240282
```

Increasing DIGITS to 50, the argument of the the sine function has about 30 correct digits after the decimal point. The first 30 digits of the following result are reliable:

```
DIGITS := 50: sin(float(2*10^30))
```

```
0.17950046751493908795061771231643809505098047699633
```

`delete DIGITS:`

## Example 6

At least one digit after the decimal point is always displayed. In the following example, the number 39.9 is displayed as 40.0 because “40.” is not be a valid MuPAD input:

```
DIGITS := 2: float(10*PI), 39.9, -30.2
```

```
31.0, 40.0, -30.0
```

`delete DIGITS:`

## Example 7

We compute `float(10^40*8/9)` with various values of DIGITS. Rounding takes into account all guard digits, i.e., the resulting integer makes all guard digits visible:

```
for DIGITS in [7, 8, 9, 17, 18, 19, 26, 27, 28] do
  print("DIGITS" = DIGITS, round(float(10^40*8/9)))
end_for:
```

"DIGITS" = 7, 888888888888888888888888084320185610999548608512

"DIGITS" = 8, 888888888888888889293246005225628723314688

"DIGITS" = 9, 88888888888888888839898822870142782799872

"DIGITS" = 17, 8888888888888888888888888888418786584035328

"DIGITS" = 18, 888888888888888888888888888840999049101312

"DIGITS" = 19, 888888888888888888888888888893775607234560

"DIGITS" = 26, 8888888888888888888888888888888655872

"DIGITS" = 27, 888888888888888888888888888888918016

"DIGITS" = 28, 88888888888888888888888888888885248

### **Example 8**

The following procedure allows to compute numerical approximations with a specified precision without changing DIGITS as a global variable. Internally, DIGITS is set to the desired precision and the float approximation is computed. Because of `save DIGITS`, the value of DIGITS is not changed outside the procedure:

```
myfloat := proc(x, digits)
  save DIGITS;
  begin
```



```

DIGITS := digits:
float(x);
end_proc:

```

The float approximation of the following value  $x$  suffers from numerical cancellation. The procedure `myfloat` is used to approximate  $x$  with 30 digits. The result is displayed with only 7 digits because of the value `DIGITS = 7` valid outside the procedure. However, all displayed digits are correct:

```

x := PI^7 - exp(8013109200945801/1000000000000000):
DIGITS := 7:
float(x), myfloat(x, 30)

```

$5.09317 \cdot 10^{-11}, 6.614563 \cdot 10^{-13}$

```

delete myfloat, x, DIGITS:

```

## Algorithms

If a floating-point number  $x$  has been created with high precision, and the computation is to continue at a lower precision, the easiest method to get rid of memory-consuming insignificant digits is `x := x + 0.0`.

## See Also

### MuPAD Functions

`Pref::floatFormat` | `Pref::outputDigits` | `Pref::trailingZeroes` | `float`

## dilog

Dilogarithm function

### Syntax

dilog(x)

### Description

dilog(x) represents the dilogarithm function  $\int_1^x \frac{\ln(t)}{1-t} dt$ .

If x is a floating-point number, then dilog(x) returns the numerical value of the dilogarithm function. The special values:

$$\text{dilog}(-1) = \frac{\pi^2}{4} - i \pi \ln(2),$$

$$\text{dilog}(0) = \frac{\pi^2}{6},$$

$$\text{dilog}(1/2) = \frac{\pi^2}{12} - \frac{\ln(2)^2}{2},$$

$$\text{dilog}(1) = 0,$$

$$\text{dilog}(2) = -\frac{\pi^2}{12},$$

$$\text{dilog}(I) = \frac{\pi^2}{16} - i \text{CATALAN} - \frac{i \pi \ln(2)}{4},$$

$$\text{dilog}(-I) = \frac{\pi^2}{16} + i \text{CATALAN} + \frac{i \pi \ln(2)}{4},$$

$$\text{dilog}(1+I) = -\frac{\pi^2}{48} - i \text{CATALAN}.$$

$$\text{dilog}(1-I) = -\frac{\pi^2}{48} + i \text{ CATALAN}$$

$$\text{dilog}(\text{infinity}) = -\text{infinity}$$

are implemented. For all other arguments, `dilog` returns a symbolic function call.

Functional identities are used to rewrite the result for exact numerical arguments of Type: :Numeric that have a negative real part or are of absolute value larger than 1. Cf. "Example 2" on page 1-546 (Symbolic Math Toolbox).

`dilog(x)` coincides with `polylog(2, 1-x)`.

## Environment Interactions

When called with a floating-point argument, the function is sensitive to the environment variable DIGITS which determines the numerical working precision.

## Examples

### Example 1

We demonstrate some calls with exact and symbolic input data:

```
dilog(0), dilog(2/3), dilog(sqrt(2)), dilog(1 + I), dilog(x)
```

$$\frac{\pi^2}{6}, \text{Li}_2\left(\frac{2}{3}\right), \text{Li}_2(\sqrt{2}), -\frac{\pi^2}{48} - \text{CATALAN } i, \text{Li}_2(x)$$

Floating point values are computed for floating-point arguments:

```
dilog(-1.2), dilog(3.4 - 5.6*I)
```

$$2.458586602 - 2.477011851 i, -2.529187195 + 2.25273709 i$$

## Example 2

Arguments built from integers and rational numbers are rewritten, if they lie in the left half of the complex plane or are of absolute value larger than 1. The following arguments have a negative real part:

`dilog(-400/3), dilog(-1/2 + I)`

$$\operatorname{Li}_2\left(\frac{3}{403}\right) - \ln\left(\frac{403}{3}\right) \left(\ln\left(\frac{400}{3}\right) + \pi i\right) + \frac{\pi^2}{6} + \frac{\ln\left(\frac{403}{3}\right)^2}{2}, \operatorname{Li}_2\left(\frac{6}{13} + \frac{4i}{13}\right) - \ln\left(-\frac{1}{2} + i\right) \sigma_1 + \frac{\pi^2}{6} + \frac{\sigma_1^2}{2}$$

where

$$\sigma_1 = \ln\left(\frac{3}{2} - i\right)$$

The following arguments have an absolute value larger than 1:

`dilog(31/30), dilog(1 + 2/3*I)`

$$-\operatorname{Li}_2\left(\frac{30}{31}\right) - \frac{\ln\left(\frac{31}{30}\right)^2}{2}, -\operatorname{Li}_2\left(\frac{9}{13} - \frac{6i}{13}\right) - \frac{\ln\left(1 + \frac{2i}{3}\right)^2}{2}$$

## Example 3

The negative real axis is a branch cut of `dilog`. A jump of height  $2\pi i \ln(1 - x)$  occurs when crossing this cut at the real point  $x < 0$ :

`dilog(-1.2), dilog(-1.2 + I/10^100), dilog(-1.2 - I/10^100)`

2.458586602 - 2.477011851 i, 2.458586602 - 2.477011851 i, 2.458586602 + 2.477011851 i

## Example 4

The functions `diff`, `float`, `limit`, and `series` handle expressions involving `dilog`:

`diff(dilog(x), x, x, x), float(ln(3 + dilog(sqrt(PI))))`

$$\frac{2}{x(x-1)^2} + \frac{1}{x^2(x-1)} - \frac{2 \ln(x)}{(x-1)^3}, 0.8503829845$$

`limit(dilog(x^10 + 1)/x, x = infinity)`

0

`series(dilog(x + 1/x)/x, x = -infinity, 3)`

$$-\frac{\frac{\pi^2}{6} + \frac{(\ln(-x) + \pi i)^2}{2}}{x} + \frac{\ln(-x) + 1 + \pi i}{x^2} - \frac{\frac{\ln(-x)}{2} - \frac{1}{4} + \frac{\pi i}{2}}{x^3} + O\left(\frac{1}{x^4}\right)$$

## Parameters

**x**

An arithmetical expression (Symbolic Math Toolbox)

## Return Values

Arithmetical expression.

## Overloaded By

x

## References

L. Lewin (ed.), "Structural Properties of Polylogarithms", Mathematical Surveys and Monographs Vol. 37, American Mathematical Society, Providence (1991).

## Algorithms

$\operatorname{dilog}(x)$  coincides with  $\sum_{k=1}^{\infty} \frac{(1-x)^k}{k^2}$  for  $|x| < 1$ .

$\operatorname{dilog}$  has a branch cut along the negative real axis. The value at a point  $x$  on the cut coincides with the limit “from above”:

$$\operatorname{Li}_2(x) = \lim_{\varepsilon \rightarrow 0^+} x + \varepsilon i = \left( \lim_{\varepsilon \rightarrow 0^-} x + \varepsilon i \right) - 2\pi i \ln(1-x)$$

## See Also

### MuPAD Functions

`ln` | `polylog`

# dirac

The Dirac delta distribution

## Syntax

`dirac(x)`

`dirac(x, n)`

## Description

`dirac(x)` represents the Dirac delta distribution.

`dirac(x, n)` represents the  $n$ -th derivative of the delta distribution.

The calls `dirac(x, 0)` and `dirac(x)` are equivalent.

If the argument  $x$  represents a non-zero number, then 0 is returned. If  $x$  is a non-real number of domain type `DOM_COMPLEX`, then `undefined` is returned. For all other arguments, a symbolic function call is returned.

`dirac` does not have a predefined value at the origin. Use

```
unprotect(dirac): dirac(0) := myValue:
```

and

```
dirac(float(0)) := myFloatValue: protect(dirac):
```

to assign a value (e.g., `infinity`).

For univariate linear expressions, the simplification rule

$$\delta^{(n)}(ax - b) = \frac{\text{sign}(a)}{a^{n+1}} \delta^{(n)}\left(x - \frac{b}{a}\right)$$

is implemented for real numerical values  $a$ .

The integration function `int` treats `dirac` as the usual delta distribution. Cf. “Example 3” on page 1-551 (Symbolic Math Toolbox).

## Environment Interactions

`dirac` reacts to properties (Symbolic Math Toolbox) of identifiers.

## Examples

### Example 1

`dirac` returns 0 for arguments representing non-zero real numbers:

```
dirac(-3), dirac(3/2), dirac(2.1, 1),  
dirac(3*PI), dirac(sqrt(3), 3)
```

```
0, 0, 0.0, 0, 0
```

Arguments of domain type `DOM_COMPLEX` yield undefined:

```
dirac(1 + I), dirac(2/3 + 7*I), dirac(0.1*I, 1), dirac(ln(-5))
```

```
undefined, undefined, undefined, undefined
```

A symbolic call is returned for other arguments:

```
dirac(0), dirac(x), dirac(x + I, 2), dirac(x, n)
```

```
 $\delta(0)$ ,  $\delta(x)$ ,  $\delta''(x+i)$ ,  $\delta^{(n)}(x)$ 
```

```
dirac(2*x - 1, n)
```

```
 $\frac{1}{2^{n+1}} \delta^{(n)}\left(x - \frac{1}{2}\right)$ 
```



A natural value for `dirac(0)` is `infinity`:

```
unprotect(dirac): dirac(0) := infinity: dirac(0)
```

$$\infty$$

```
delete dirac(0): protect(dirac): dirac(0)
```

$$\delta(0)$$

## Example 2

`dirac` reacts to assumptions set by `assume`:

```
assume(x < 0): dirac(x)
```

$$0$$

```
assume(x, Type::Real): assume(x <> 0, _and): dirac(x)
```

$$0$$

```
unassume(x):
```

## Example 3

The symbolic integration function `int` treats `dirac` as the delta distribution:

```
int(f(x)*dirac(x - y^2), x = -infinity..infinity)
```

$$f(y^2)$$

```
int(int(f(x, y)*dirac(x - y^2), x = -infinity..infinity),
    y = -1..1)
```

$$\int_{-1}^1 f(y^2, y) \, dy$$

The indefinite integral of `dirac` involves the `sign` function:

```
int(f(x)*dirac(x), x), int(f(x)*dirac(x, 1), x)
```

$$\frac{f(0) \operatorname{sign}(x)}{2}, f(0) \delta(x) - \frac{f'(0) \operatorname{sign}(x)}{2}$$

`int` can handle the distribution only if the argument of `dirac` is linear in the integration variable:

```
int(f(x)*dirac(2*x - 3), x = -10..10),
int(f(x)*dirac(x^2), x = -10..10)
```

$$\frac{f(\frac{3}{2})}{2}, \int_{-10}^{10} \delta(x^2) f(x) \, dx$$

Also note that `dirac` should not be used for numerical integration, since the numerical algorithm will typically fail to detect the delta peak:

```
numeric::int(dirac(x - 3), x = -10..10)
```

0.0

## Parameters

**x**

An arithmetical expression (Symbolic Math Toolbox)

**n**

An arithmetical expression (Symbolic Math Toolbox) representing a nonnegative integer

## **Return Values**

Arithmetical expression.

## **Overloaded By**

x

## **See Also**

### **MuPAD Functions**

heaviside

# discont

Discontinuities of a function

## Syntax

```
discont(f, x)
```

```
discont(f, x, <Undefined>)
```

```
discont(f, x, <Real>)
```

```
discont(f, x = a .. b)
```

```
discont(f, x = a .. b, <Undefined>)
```

```
discont(f, x = a .. b, <Real>)
```

## Description

`discont(f, x)` computes the set of all discontinuities of the function  $f(x)$ .

`discont(f, x = a..b)` computes the set of all discontinuities of  $f(x)$  lying in the interval  $[a, b]$ .

`discont(f, x)` returns a set of numbers containing all discontinuities of  $f$  when  $f$  is regarded as a function of  $x$  on the set of all complex numbers that may be attained by  $x$  as values, as specified by the assumptions on  $x$ . Please note that a real number that is a discontinuity of a complex function need not be a discontinuity of the restriction of that function to the set of real numbers: consider, for example, a function that has its branch cut on the real axis, as in “Example 2” on page 1-555 (Symbolic Math Toolbox) below.

Discontinuities include points where the function is not defined as well as points where the function is defined but not continuous. If the option `Undefined` is used, only points where the function is not defined are returned.

If the option `Real` is used, it is assumed that  $f$  and all of its subexpressions represent real numbers.

If a range  $a..b$  is given, it is assumed that  $x$  can take on values only in the interval  $[a, b]$ .

The set returned by `discont` may contain numbers that are not discontinuities of  $f$ . See “Example 7” on page 1-557 (Symbolic Math Toolbox).

If `discont` is unable to compute the discontinuities, then a symbolic `discont` call is returned; see “Example 8” on page 1-557 (Symbolic Math Toolbox).

`discont` can be extended to user-defined mathematical functions via overloading (Symbolic Math Toolbox). To this end, embed the mathematical function in a function environment on page 7-25 and assign the set of real discontinuities to its "realDiscont" slot, the set of its complex discontinuities to its "complexDiscont" slot, and the set of points where the function is not defined to its "undefined" slot. See `solve` for an overview of the various types of sets. See also “Example 8” on page 1-557 (Symbolic Math Toolbox) below.

## Environment Interactions

`discont` reacts to properties of free parameters both in  $f$  as well as in  $a$  and  $b$ . `discont` sometimes reacts to properties of  $x$ .

## Examples

### Example 1

The gamma function has poles at all integers less or equal to zero. Hence  $x \rightarrow \gamma(x/2)$  has poles at all even integers less or equal to zero:

```
discont(gamma(x/2), x)
```

$$(-\infty, 0] \cap \{2k \mid k \in \mathbb{Z}\}$$

### Example 2

The logarithm has a branch cut on the negative real axis; hence, it is not continuous there. However, its restriction to the real numbers is continuous at every point except zero:

```
discont(ln(x), x), discont(ln(x), x, Real)
```

```
(-∞, 0], {0}
```

### Example 3

The function `sign` is defined everywhere; it is not continuous at zero:

```
discont(sign(x), x), discont(sign(x), x, Undefined)
```

```
{0}, ∅
```

### Example 4

If a range is given, only the discontinuities in that range are returned.

```
discont(1/x/(x - 1), x = 0..1/2)
```

```
{0}
```

### Example 5

A range may have arbitrary arithmetical expressions as boundaries. `discont` implicitly assumes that the right boundary is greater or equal to the left boundary:

```
discont(1/x, x = a..b)
```

```
{ {0} if a ≤ 0 ∧ 0 ≤ b  
  ∅ if 0 < a ∨ b < 0
```

### Example 6

As can be seen from the previous example, `discont` reacts to properties of free parameters (because `piecewise` does). The result also depends on the properties of `x`: it may omit values that `x` cannot take on anyway because of its properties.

```
assume(x > 0):
discont(1/x, x)
```

$$\emptyset$$

```
delete x:
```

## Example 7

Sometimes, `discont` returns a proper superset of the set of discontinuities:

```
discont(piecewise([x<>0, x*sin(1/x)], [x=0, 0]), x)
```

$$\{0\}$$

## Example 8

If `discont` cannot determine the discontinuities of a given function, then `discont` assumes the function is continuous and returns an empty set:

```
delete f: discont(f(x), x)
```

$$\emptyset$$

You can provide the necessary information by adding slots to `f`. For example, assume that `f` is not continuous at 1 but everywhere else; and that also its restriction to the real numbers remains discontinuous at 1. After adding the corresponding slots, `discont` takes care to handle `f` correctly also if it appears in a more complicated expression:

```
f:= funcenv(x->procname(x)):
f::realDiscont:= {1}:
f::complexDiscont:= {1}:
discont(f(sin(x)), x=-4..34)
```

$$\left\{ \frac{\pi}{2}, \frac{5\pi}{2}, \frac{9\pi}{2}, \frac{13\pi}{2}, \frac{17\pi}{2}, \frac{21\pi}{2} \right\}$$

## Example 9

We define a function that implements the logarithm to base 2. For simplicity, we let it always return the unevaluated function call. The logarithm has a branch cut on the negative real axis; its restriction to the reals is continuous everywhere except at zero:

```
binlog := funcenv(x -> procname(x)):
binlog::realDiscont := {0}:
binlog::undefined := {0}:
binlog::complexDiscont := Dom::Interval(-infinity, [0]):
discont(binlog(x), x);
discont(binlog(x), x=-2..2, Real);
discont(binlog(x), x=-2..2, Undefined)
```

$(-\infty, 0]$

$\{0\}$

$\{0\}$

## Parameters

**f**

An arithmetical expression (Symbolic Math Toolbox) representing a function in  $x$

**x**

An identifier on page 7-29

**a, b**

Interval boundaries: arithmetical expressions (Symbolic Math Toolbox)



## Options

### Undefined

Return only those points where  $f$  is not defined (and not just discontinuous).

### Real

Assume that all subexpressions of  $f$  are real.

## Return Values

Set—see the help page for `solve` for an overview of all types of sets—or a symbolic `discont` call.

## Overloaded By

$f$

## See Also

### MuPAD Functions

`limit` | `solve`

## **div\_div**

Integer part of a quotient

### **Syntax**

```
m div n  
_div(x, m)
```

### **Description**

$x \text{ div } m$  represents the integer  $q$  satisfying  $x = qm + r$  with  $0 \leq r < |m|$ .

For positive  $x$  and  $m$ ,  $q = x \text{ div } m$  is the integer part of the quotient  $x/m$ , i.e.,  $q = \text{trunc}(x/m)$ .

$x \text{ div } m$  is equivalent to the function call `_div(x, m)`.

An integer is returned if both  $x$  and  $m$  evaluate to integers. A symbolic expression of type "`_div`" is returned if either  $x$  or  $m$  does not evaluate to a number. An error is raised if  $x$  or  $m$  evaluates to a number that is not an integer.

`div` does not operate on polynomials. Use `divide`.

### **Examples**

#### **Example 1**

With the default setting for `mod`, the identity  $(x \text{ div } m) * m + (x \text{ mod } m) = x$  holds for integer numbers  $x$  and  $m$ :

```
43 div 13 = trunc(43/13), 43 mod 13 = frac(43/13) * 13
```

```
3 = 3, 4 = 4
```

```
(43 div 13) * 13 + (43 mod 13) = 43
```

```
43 = 43
```

## Example 2

Symbolic expressions of type "\_div" are returned, if either  $x$  or  $m$  does not evaluate to a number:

```
43 div m, x div 13, x div m
```

```
43 div m, x div 13, x div m
```

```
type(x div m)
```

```
"_div"
```

If  $x$  or  $m$  are numbers, they must be integer numbers:

```
1/2 div 2
```

```
Error: Invalid argument. [div]
```

```
x div 2.0
```

```
Error: Invalid argument. [div]
```

## Parameters

**$x$ ,  $m$**

Integers or symbolic arithmetical expressions (Symbolic Math Toolbox);  $m$  must not be zero.

## **Return Values**

Integer or an arithmetical expression of type "\_div".

## **Overloaded By**

m, x

## **See Also**

### **MuPAD Functions**

/ | divide | mod | mod | modp | mods

# divergence

Divergence of a vector field

## Syntax

`divergence(v, x)`

`divergence(v, x, ogCoord, <c>)`

## Description

`divergence(v, x)` computes the divergence of the vector field  $\vec{v}$  with respect to  $\vec{x}$  in

Cartesian coordinates. This is the sum  $\operatorname{div}(\vec{v}) = \sum_{i=1}^n \frac{\partial}{\partial x_i} v_i$

`ogCoord` can be the name of a three-dimensional orthogonal coordinate system predefined in the table `linalg::ogCoordTab`. See “Example 2” on page 1-564 (Symbolic Math Toolbox).

Alternatively, `ogCoord` can be a list of vector of algebraic expressions representing the scale factors of the coordinate system. See example “Example 3” on page 1-564 (Symbolic Math Toolbox). For details, see the description of the `Scales` option on the `linalg::ogCoordTab` page.

If `v` is a vector then the component ring of `v` must be a field (a domain of category `Cat::Field`) for which differentiation with respect to `x` is defined.

## Examples

### Example 1

Compute the divergence of the vector field  $\vec{v}(x, y, z) = (x^2, 2y, z)$  in Cartesian coordinates:

```
delete x, y, z:
v := matrix([x^2, 2*y, z])
```

$$\begin{pmatrix} x^2 \\ 2y \\ z \end{pmatrix}$$

```
divergence(v, [x, y, z])
```

$$2x + 3$$

## Example 2

Compute the divergence of the vector field  $\vec{v}(r, \phi, z) = (r, \cos(\phi), z)$  ( $0 \leq \phi < 2\pi$ ) in cylindrical coordinates:

```
delete r, phi, z:
divergence([r, sin(phi), z], [r, phi, z], Cylindrical)
```

$$\frac{3r + \cos(\phi)}{r}$$

The following relations between Cartesian and cylindrical coordinates hold:

$$x = r \cos(\phi), \quad y = r \sin(\phi), \quad z = z$$

Other predefined orthogonal coordinate systems can be found in the table `linalg::ogCoordTab`.

## Example 3

Compute the divergence of a vector field in spherical coordinates  $r, \theta, \phi$  given by

$$\vec{x} = \begin{pmatrix} x \\ y \\ z \end{pmatrix} = \begin{pmatrix} r \sin(\theta) \cos(\phi) \\ r \sin(\theta) \sin(\phi) \\ r \cos(\theta) \end{pmatrix}$$

with  $0 \leq \theta \leq \pi$ ,  $0 \leq \phi < 2\pi$ . The vectors

$$\vec{e}_r = \frac{\frac{\partial \vec{x}}{\partial r}}{\left| \frac{\partial \vec{x}}{\partial r} \right|} = \begin{pmatrix} \sin(\theta) \cos(\phi) \\ \sin(\theta) \sin(\phi) \\ \cos(\theta) \end{pmatrix}, \quad \vec{e}_\theta = \frac{\frac{\partial \vec{x}}{\partial \theta}}{\left| \frac{\partial \vec{x}}{\partial \theta} \right|} = \begin{pmatrix} \cos(\theta) \cos(\phi) \\ \cos(\theta) \sin(\phi) \\ -\sin(\theta) \end{pmatrix},$$

$$\vec{e}_\phi = \frac{\frac{\partial \vec{x}}{\partial \phi}}{\left| \frac{\partial \vec{x}}{\partial \phi} \right|} = \begin{pmatrix} -\sin(\phi) \\ \cos(\phi) \\ 0 \end{pmatrix}$$

form an orthogonal system of unit vectors corresponding to the spherical coordinates. The scaling factors of the coordinate transformation (see `linalg::ogCoordTab`) are

$\left| \frac{\partial \vec{x}}{\partial r} \right| = 1$ ,  $\left| \frac{\partial \vec{x}}{\partial \theta} \right| = r$ ,  $\left| \frac{\partial \vec{x}}{\partial \phi} \right| = r \sin(\theta)$ , which we use in the following example to compute the divergence of the vector field  $\vec{v}(r, \theta, \phi) = r^2 \vec{e}_r$ :

```
delete r, Theta, phi:
divergence([r^2, 0, 0], [r, Theta, phi], [1, r, r*sin(Theta)])
```

`4 r`

Note that the spherical coordinates are already defined in `linalg::ogCoordTab`. The last result can also be achieved with the input `divergence([r^2, 0, 0], [r, Theta, phi], Spherical)`:

```
divergence([r^2, 0, 0], [r, Theta, phi], Spherical)
```

`4 r`

## Parameters

**v**

A list of arithmetical expressions, or a vector (i.e., an  $n \times 1$  or  $1 \times n$  matrix of a domain of category `Cat::Matrix`)

**x**

A list of identifiers or indexed identifiers

**ogCoord**

The name of a 3 dimensional orthogonal coordinate system predefined in the table `linalg::ogCoordTab`, or a list of algebraic expressions representing the scale factors of an orthogonal coordinate system.

**c**

The parameter of the coordinate systems `EllipticCylindrical` on page 15-167 and `Torus` on page 15-167, respectively: an arithmetical expression (Symbolic Math Toolbox). The default value is  $c = 1$ .

## Return Values

Arithmetical expression, or an element of the component ring of  $v$ .

## See Also

**MuPAD Functions**

`curl` | `gradient` | `laplacian` | `linalg::ogCoordTab` | `potential` | `vectorPotential`



# divide

Divide polynomials

## Syntax

`divide(p, q, <[x]>, <order>, options)`

`divide(p, q, <[x1, x2, ...]>, <order>, options)`

`divide(p, q1, q2, ..., <order>, options)`

## Description

`divide(p, q)` divides polynomials or polynomial expressions  $p$  and  $q$ . By default, the function returns the quotient  $s$  and the remainder  $r$ , such that  $p = s q + r$ . Here  $\text{degree}(r) < \text{degree}(q)$ .

`divide(p, q1, q2, q3, ..., qn)` divides a polynomial or a polynomial expression  $p$  by polynomials or polynomial expressions  $q_1, q_2, q_3, \dots, q_n$ . The function returns the quotients  $s_1, s_2, s_3, \dots, s_n$  and the remainder  $r$ , such that  $p = s_1 q_1 + s_2 q_2 + s_3 q_3 + \dots + s_n q_n + r$ . Here the leading coefficient of the remainder  $r$  cannot be divided by the leading coefficients of any of divisors  $q_1, q_2, q_3, \dots, q_n$ .

`divide(p, q)` divides the polynomial or polynomial expression  $p$  by the polynomial or polynomial expression  $q$ . Use the Quo option to return the quotient only. Use the Rem option to return the remainder only.

The `divide` function operates on polynomials (Symbolic Math Toolbox) or polynomial expressions (Symbolic Math Toolbox).

Polynomials must be of the same type: their variables and coefficient rings must be identical.

When you call `divide` for polynomial expressions, MuPAD internally converts these expressions to polynomials. See the `poly` function. If you do not specify the list of indeterminates, `divide` treats all symbolic variables in the expressions as

indeterminates. If the expressions cannot be converted to polynomials, the `divide` function returns FAIL. See “Example 1” on page 1-569 (Symbolic Math Toolbox).

If you call `divide` for polynomials, it returns polynomials. If you call `divide` for polynomial expressions, the function returns polynomial expressions. See “Example 2” on page 1-569 (Symbolic Math Toolbox).

If you divide polynomial expressions that contain more than one variable, you can specify particular variables to be treated as variables. The `divide` function treats all other variables as symbolic parameters. By default, `divide` assumes that all variables in polynomial expressions are variables, and none of them is a symbolic parameter. See “Example 3” on page 1-570 (Symbolic Math Toolbox).

`divide(p, q1, q2, q3, ..., qn)` divides a polynomial or a polynomial expression  $p$  by polynomials or polynomial expressions  $q_1, q_2, q_3, \dots, q_n$ . The function returns quotients  $s_1, s_2, s_3, \dots, s_n$  and remainder  $r$ , such that  $p = s_1 q_1 + s_2 q_2 + s_3 q_3 + \dots + s_n q_n + r$ . Here the leading coefficient of the remainder  $r$  cannot be divided by the leading coefficients of any of the divisors  $q_1, q_2, q_3, \dots, q_n$ . See “Example 6” on page 1-571 (Symbolic Math Toolbox).

When dividing a polynomial by one or more polynomials, you can select the term ordering. The ordering accepts the following values:

- `LexOrder` sets the lexicographical ordering.
- `DegreeOrder` sets the total degree ordering. When using this ordering, MuPAD sorts the terms of a polynomial according to the total degree of each term (the sum of the exponents of the variables).
- `DegInvLexOrder` sets the total degree inverse lexicographic ordering. When using this ordering, MuPAD sorts the terms of a polynomial according to the total degree of each term (the sum of the exponents of the variables). If the several terms have equal total degrees, MuPAD sorts them using the inverse lexicographic ordering.
- your custom term ordering of type `Dom::MonomOrdering`.

The coefficient ring of the polynomials must implement the “`_divide`” method on page 1-1980. MuPAD uses this method internally to divide coefficients. If the coefficients cannot be divided, this method must return FAIL.

## Examples

### Example 1

For polynomial expressions, `divide` internally calls the `poly` function, which converts an expression to a polynomial. If you do not specify the indeterminate of an expression, MuPAD assumes that all variables are indeterminates. For example, The `divide` function cannot divide the following polynomial expressions because it assumes that both  $x$  and  $y$  are indeterminates:

```
divide(x/y, x)
```

FAIL

If you specify that only  $x$  is an indeterminate, the result is:

```
divide(x/y, x, [x])
```

$\frac{1}{y}, 0$

### Example 2

The `divide` divides polynomials or polynomial expressions. When you divide polynomials, the function returns polynomials:

```
divide(poly(x^3 + x + 1, [x]), poly(x^2 + x + 1, [x]))
```

$\text{poly}(x - 1, [x]), \text{poly}(x + 2, [x])$

When you divide polynomial expressions, MuPAD internally converts these expressions to polynomials, divides these polynomials, and then converts the result of division to polynomial expressions:

```
divide(x^3 + x + 1, x^2 + x + 1)
```

$x - 1, x + 2$

### Example 3

When dividing multivariate polynomials, you can specify the list of variables. The `divide` function assumes all other variables are symbolic parameters. For example, divide the following two polynomial expressions specifying that both  $x$  and  $y$  are variables:

```
divide(x^2 - 2*x - y, y*x - 1, [x, y])
```

$$0, x^2 - 2x - y$$

Divide the same polynomial expressions specifying that only  $x$  is a variable. MuPAD assumes that  $y$  is a symbolic parameter:

```
divide(x^2 - 2*x - y, y*x - 1, [x])
```

$$\frac{\frac{1}{y} - 2}{y} + \frac{x}{y}, \frac{\frac{1}{y} - 2}{y} - y$$

Now, divide these expressions specifying that only  $y$  is a variable. MuPAD assumes that  $x$  is a symbolic parameter:

```
divide(x^2 - 2*x - y, y*x - 1, [y])
```

$$-\frac{1}{x}, x^2 - \frac{1}{x} - 2x$$

By default, the `divide` function treats polynomial expressions with more than one variable as multivariate polynomial expressions. The function does not assume that any of the variables are symbolic parameters:

```
divide(x^2 - 2*x - y, y*x - 1)
```

$$0, x^2 - 2x - y$$

### Example 4

By default, `divide` returns the quotient and the remainder of the division of polynomials:

```
divide(x^3 + x + 1, x^2 + x + 1)
```

```
x - 1, x + 2
```

To return the quotient only, use the Quo option:

```
divide(x^3 + x + 1, x^2 + x + 1, Quo)
```

```
x - 1
```

To return the remainder only, use the Rem option:

```
divide(x^3 + x + 1, x^2 + x + 1, Rem)
```

```
x + 2
```

## Example 5

Suppose, you want to get the result of the division only when the exact division is possible. To return the quotient  $s$  of the exact division of polynomials or polynomial expressions, use the Exact option:

```
divide(x^4 + 12*x^3 + 28*x^2 + 204*x + 187, x + 11, Exact)
```

```
x3 + x2 + 17x + 17
```

When exact division without remainder is impossible, the `divide` function with the Exact option returns FAIL:

```
divide(x^4 + 12*x^3 + 28*x^2 + 204*x + 187, x + 12, Exact)
```

```
FAIL
```

## Example 6

The `divide` function allows you to divide a polynomial (or polynomial expression) by multiple polynomials (or polynomial expressions):

```
divide(4*x^4 + 2*x^2 + 1, x^3 - x + 1, x - 1)
```

```
4 x, 6 x + 2, 3
```

When dividing a polynomial by multiple polynomials, you can select the term ordering:

```
divide(x^2+y^3+1, x-y^2, y, LexOrder)
```

```
y^2 + x, y^3 + y^2, 1
```

```
divide(x^2+y^3+1, x-y^2, y, DegreeOrder)
```

```
- y, x, x^2 + 1
```

## Parameters

**p, q**

Univariate or multivariate polynomials (Symbolic Math Toolbox) or polynomial expressions (Symbolic Math Toolbox).

**p, q<sub>1</sub>, q<sub>2</sub>, ...**

Univariate or multivariate polynomials (Symbolic Math Toolbox) or polynomial expressions (Symbolic Math Toolbox).

**x**

The indeterminate of the polynomial: typically, an identifier on page 7-29 or an indexed identifier on page 1-1017. `divide` treats the expressions as univariate polynomials in the indeterminate `x`.

**x<sub>1</sub>, x<sub>2</sub>, ...**

The indeterminates of the polynomial: typically, identifiers on page 7-29 or indexed identifiers on page 1-1017. `divide` treats multivariate expressions as multivariate polynomials in these indeterminates.

**order**

The term ordering when dividing one multivariate polynomial by one or more multivariate polynomials: `LexOrder`, `DegreeOrder`, `DegInvLexOrder`, or a custom term ordering of type `Dom::MonomOrdering`. The default is the lexicographical ordering `LexOrder`.

## Options

**Exact**

Return the quotient `s` of the exact division of multivariate polynomials. If no exact division without remainder is possible, return `FAIL`.

**Quo, Rem**

Return the quotient `s` or the remainder `r`. By default, the `divide` function returns both the quotient and the remainder.

## Return Values

Polynomial, a polynomial expression, a sequence of polynomials or polynomial expressions, or the value `FAIL`.

## Overloaded By

`p`, `q`

## See Also

**MuPAD Functions**

`/` | `content` | `degree` | `div` | `factor` | `gcd` | `gcdex` | `groebner::normalf` | `ground` | `lcoeff` | `mod` | `multcoeffs` | `pdivide` | `poly` | `powermod`

## domtype

Data type of an object

### Syntax

`domtype(object)`

### Description

`domtype(object)` returns the domain (Symbolic Math Toolbox) type (the data type) of the object.

For most data types, the domain type as returned by `domtype` coincides with the type returned by the function `type`. Only for expressions of domain type `DOM_EXPR`, the function `type` yields a distinction according to the 0-th operand. Cf. “Example 2” on page 1-575 (Symbolic Math Toolbox).

In contrast to most other functions, `domtype` does not flatten (Symbolic Math Toolbox) arguments that are expression sequences on page 1-88.

### Examples

#### Example 1

Real floating-point numbers are of domain type `DOM_FLOAT`:

```
domtype(12.345)
```

```
DOM_FLOAT
```

Complex numbers are of domain type `DOM_COMPLEX`. The operands may be integers (`DOM_INT`), rational numbers (`DOM_RAT`), or floating-point numbers (`DOM_FLOAT`). The operands can be accessed via `op`:



```
domtype(1 - 2*I), op(1 - 2*I);  
domtype(1/2 - I), op(1/2 - I);  
domtype(2.0 - 3.0*I), op(2.0 - 3.0*I)
```

```
DOM_COMPLEX, 1, -2
```

```
DOM_COMPLEX,  $\frac{1}{2}$ , -1
```

```
DOM_COMPLEX, 2.0, -3.0
```

## Example 2

Expressions are objects of the domain type DOM\_EXPR. The type of expressions can be queried further with the function type:

```
domtype(x + y), type(x + y);  
domtype(x - 1.0*I), type(x - 1.0*I);  
domtype(x*I), type(x*I);  
domtype(x^y), type(x^y);  
domtype(x[i]), type(x[i])
```

```
DOM_EXPR, "_plus"
```

```
DOM_EXPR, "_plus"
```

```
DOM_EXPR, "_mult"
```

```
DOM_EXPR, "_power"
```

```
DOM_EXPR, "_index"
```

### Example 3

`domtype` evaluates its argument. In this example, the assignment is first evaluated and `domtype` is applied to the return value of the assignment. This is the right hand side of the assignment, i.e., 5:

```
domtype((a := 5))
```

```
DOM_INT
```

```
delete a:
```

### Example 4

Here the identifier `a` is first evaluated to the expression `sequence3, 4`. Its domain type is `DOM_EXPR`, its type is `"_exprseq"`:

```
a := 3, 4: domtype(a), type(a)
```

```
DOM_EXPR, "_exprseq"
```

```
delete a:
```

### Example 5

`factor` creates objects of the domain type `Factored`:

```
domtype(factor(x^2 - x))
```

```
Factored
```

### Example 6

`matrix` creates objects of the domain type `Dom::Matrix()`:

```
domtype(matrix([[1, 2], [3, 4]]))
```

```
Dom::Matrix()
```

## Example 7

Domains are of the domain type DOM\_DOMAIN:

```
domtype(DOM_INT), domtype(DOM_DOMAIN)
```

```
DOM_DOMAIN, DOM_DOMAIN
```

## Example 8

domtype is overloadable (Symbolic Math Toolbox), i.e., a domain can pretend to be of another domain type. The special slot "dom" always gives the actual domain:

```
d := newDomain("d"): d::domtype := x -> "domain type d":  
e := new(d, 1): e::dom, type(e), domtype(e)
```

```
d, d, "domain type d"
```

```
delete d, e:
```

## Parameters

### object

Any MuPAD object

## Return Values

Data type, i.e., an object of type DOM\_DOMAIN.

## Overloaded By

object

## See Also

### **MuPAD Domains**

DOM\_DOMAIN

### **MuPAD Functions**

coerce | hastype | testtype | type

# doprint

Print large matrices

## Syntax

```
doprint(object1, object2, ...)
```

## Description

`doprint` serves for displaying large matrices on the screen. In fact, `doprint(object)` displays any MuPAD object like `print(object)`. The only difference is that large matrices contained in the object are printed, too.

Matrices of type `matrix` or of the more general type `Dom::Matrix(R)` with some coefficient ring  $R$  are not willing to print themselves on the screen if they are large.

An  $m \times n$  matrix  $A$  is printed like a formatted two-dimensional array only if  $m \cdot n \leq \text{printMaxSize}$ , where the default value of `printMaxSize` is 500. (You can change the `printMaxSize` value to any other integer value  $m$  by calling `A::dom::setPrintMaxSize(m)`).

For larger matrices, a warning is issued and some symbolic dummy object without the matrix entries is printed.

This serves to avoid output problems when printing is invoked accidentally (the output for large formatted arrays is very expensive concerning time and memory).

If you do insist on printing large matrices on the screen, the function `doprint` can be used to create a sparse table like output of the matrix.

---

**Note** With `doprint`, only non-zero entries of large matrices are printed!

---

`doprint` allows to print arbitrary MuPAD objects. It behaves like `print` for all objects apart from matrices contained in the object.

For small matrices, it switches off the formatted array like output and replaces it by a sparse table like output. For large matrices, it suppresses warnings such as "This matrix is too large for display. ..." and prints matrices using the sparse table like output.

See "Example 1" on page 1-580 (Symbolic Math Toolbox) and "Example 2" on page 1-581 (Symbolic Math Toolbox).

## Environment Interactions

`doprint` is sensitive to the environment variables `DIGITS`, `PRETTYPRINT`, and `TEXTWIDTH`, and to the output preferences `Pref::floatFormat`, `Pref::keepOrder`, and `Pref::trailingZeroes`.

## Examples

### Example 1

Small matrices are printed like formatted arrays:

```
A := matrix(5, 5, [i $ i = 1..30], Diagonal)
```

$$\begin{pmatrix} 1 & 0 & 0 & 0 & 0 \\ 0 & 2 & 0 & 0 & 0 \\ 0 & 0 & 3 & 0 & 0 \\ 0 & 0 & 0 & 4 & 0 \\ 0 & 0 & 0 & 0 & 5 \end{pmatrix}$$

Calling `doprint`, this matrix is printed in a different way:

```
doprint(A)
```

```
Dom::Matrix()(5, 5, [(1, 1) = 1, (2, 2) = 2, (3, 3) = 3, (4, 4) = 4, (5, 5) = 5])
```

We create a larger diagonal matrix of dimension 30 × 30:

```
A := matrix(30, 30, [i $ i = 1..30], Diagonal):
```

If we had not suppressed the output by the colon terminating the command above, the following warning would have been issued by the output system:

A

Warning: Matrix too large for display. To see all nonzero entries of a matrix A, use 'A

```
Dom::Matrix()(30, 30, ["..."])
```

```
Warning: This matrix is too
large for display. If you want to see all nonzero entries of a matrix,
say A, then call 'A::dom::doprint(A)'. [(Dom::Matrix(Dom::ExpressionField()))::print]
```

```
Warning: This matrix is too large for display.
If you want to see all nonzero entries of a matrix, say A, then call
'A::dom::doprint(A)'. [(Dom::Matrix(Dom::ExpressionField()))::print]
```

```
Dom::Matrix()(30, 30, ["..."])
```

Since the matrix is extremely sparse, it does make sense to print the matrix. Calling `doprint`, we obtain a print output of all non-zero elements:

```
doprint(A)
```

```
Dom::Matrix()(30, 30, [(1, 1) = 1, (2, 2) = 2, (3, 3) = 3, (4, 4) = 4, (5, 5) = 5, (6, 6) = 6,
(7, 7) = 7, (8, 8) = 8, (9, 9) = 9, (10, 10) = 10, (11, 11) = 11, (12, 12) = 12,
(13, 13) = 13, (14, 14) = 14, (15, 15) = 15, (16, 16) = 16, (17, 17) = 17, (18, 18) = 18,
(19, 19) = 19, (20, 20) = 20, (21, 21) = 21, (22, 22) = 22, (23, 23) = 23, (24, 24) = 24,
(25, 25) = 25, (26, 26) = 26, (27, 27) = 27, (28, 28) = 28, (29, 29) = 29, (30, 30) = 30])
```

```
delete A:
```

## Example 2

We compute a numerical *QR* factorization of a zero matrix of dimension  $30 \times 30$ . Since the command is not terminated by a colon, the output system tries to print the list with the factors *Q* and *R*. Both matrices send a warning:

```
[Q, R] := numeric::factorQR(matrix(30, 30, [])):
Q, R
```

Warning: Matrix too large for display. To see all nonzero entries of a matrix A, use 'A

Warning: Matrix too large for display. To see all nonzero entries of a matrix A, use 'A

```
Dom::Matrix()(30, 30, ["..."]), Dom::Matrix()(30, 30, ["..."])
```

```
Warning: This matrix is too
large for display. If you want to see all nonzero entries of a matrix,
say A, then call 'A::dom::doprint(A)'. [(Dom::Matrix(Dom::ExpressionField()))::print]
```

```
Warning: This matrix is too large for display.
If you want to see all nonzero entries of a matrix, say A, then call
'A::dom::doprint(A)'. [(Dom::Matrix(Dom::ExpressionField()))::print]
```

```
Warning: This matrix is too large for display.
If you want to see all nonzero entries of a matrix, say A, then call
'A::dom::doprint(A)'. [(Dom::Matrix(Dom::ExpressionField()))::print]
```

```
Warning: This matrix is too large for display.
If you want to see all nonzero entries of a matrix, say A, then call
'A::dom::doprint(A)'. [(Dom::Matrix(Dom::ExpressionField()))::print]
```

```
Dom::Matrix()(30, 30, ["..."]), Dom::Matrix()(30, 30, ["..."])
```

We can enforce a sparse output via `doprint`. The matrix factor  $Q$  is the identity matrix, the matrix factor  $R$  is zero:

```
doprint([Q, R])
```

```
[Dom::Matrix()(30, 30, [(1, 1) = 1.0, (2, 2) = 1.0, (3, 3) = 1.0, (4, 4) = 1.0, (5, 5) = 1.0,
(6, 6) = 1.0, (7, 7) = 1.0, (8, 8) = 1.0, (9, 9) = 1.0, (10, 10) = 1.0, (11, 11) = 1.0,
(12, 12) = 1.0, (13, 13) = 1.0, (14, 14) = 1.0, (15, 15) = 1.0, (16, 16) = 1.0,
(17, 17) = 1.0, (18, 18) = 1.0, (19, 19) = 1.0, (20, 20) = 1.0, (21, 21) = 1.0,
(22, 22) = 1.0, (23, 23) = 1.0, (24, 24) = 1.0, (25, 25) = 1.0, (26, 26) = 1.0,
(27, 27) = 1.0, (28, 28) = 1.0, (29, 29) = 1.0, (30, 30) = 1.0]), Dom::Matrix()(30, 30, [])]
```

```
delete Q, R:
```



## Parameters

`object1, object2, ...`

Any MuPAD objects

## Return Values

`doprint` returns the void object `null()` of type `DOM_NULL`.

## Overloaded By

## See Also

### MuPAD Functions

`DIGITS` | `PRETTYPRINT` | `Pref::floatFormat` | `Pref::keepOrder` |  
`Pref::trailingZeroes` | `TEXTWIDTH` | `expose` | `expr2text` | `fprint` | `print` |  
`protocol` | `strprint` | `write`

# Ei

Exponential integral function

## Syntax

`Ei(x)`

`Ei(n, x)`

## Description

`Ei(x)` represents the exponential integral  $\int_{-\infty}^x \frac{e^t}{t} dt$ .

`Ei(n, x)` represents the exponential integral  $\int_1^{\infty} \frac{e^{-xt}}{t^n} dt$ .

If `x` is a floating-point number, then `Ei(x)` returns the numerical value of the exponential integral. The special values  $Ei(\infty) = \infty$  and  $Ei(-\infty) = 0$  are implemented. For all other arguments, `Ei(x)` returns a symbolic function call.

If both `n` and `x` are numerical values and if at least one of them is a floating-point number, then `Ei(n, x)` returns a floating-point value.

The special values  $Ei(n, \infty) = 0$  and  $Ei(n, -\infty) = -\infty$  are implemented for arbitrary `n`.

If `n` is a non-positive integer not larger than `Pref::autoExpansionLimit()`, then `Ei(n, x)` returns an explicit expression of the form  $\exp(-x) * p(1/x)$ , where `p` is a polynomial of degree  $1 - n$ . E.g.:

$$Ei(0, x) = \frac{e^{-x}}{x}, Ei(-1, x) = e^{-x} \left( \frac{1}{x} + \frac{1}{x^2} \right), Ei(-2, x) = e^{-x} \left( \frac{1}{x} + \frac{2}{x^2} + \frac{2}{x^3} \right)$$

Use `expand` if such representations are also desired for  $|n|$  larger than `Pref::autoExpansionLimit()`.

If  $x$  is a positive constant,  $Ei(1, x)$  returns  $- Ei(-x)$ . For a negative constant  $x$ ,  $Ei(1, x)$  returns  $- Ei(-x) - \pi i$ .

For all other arguments  $Ei(n, x)$  returns a symbolic function call.

## Environment Interactions

When called with a floating-point argument, the function is sensitive to the environment variable DIGITS which determines the numerical working precision.

## Examples

### Example 1

We demonstrate some calls with exact and symbolic input data:

$Ei(1)$ ,  $Ei(\sqrt{2})$ ,  $Ei(x + 1)$ ,  $Ei(\infty)$ ,  $Ei(-\infty)$

$Ei(1)$ ,  $Ei(\sqrt{2})$ ,  $Ei(x + 1)$ ,  $\infty$ ,  $0$

$Ei(\sqrt{2})$ ,  $\pi i$ ,  $Ei(2, x + 1)$ ,  $Ei(3, \infty)$ ,  $Ei(1, -\infty)$

$Ei(\sqrt{2}, \pi)$ ,  $Ei(2, x + 1)$ ,  $0$ ,  $-\infty$

If the first argument is a non-positive integer, an explicit expression is returned:

$Ei(-5, x)$

$$e^{-x} \left( \frac{1}{x} + \frac{5}{x^2} + \frac{20}{x^3} + \frac{60}{x^4} + \frac{120}{x^5} + \frac{120}{x^6} \right)$$

Floating point values are computed for floating-point arguments:

$Ei(-1000.0)$ ,  $Ei(1.0)$ ,  $Ei(12.3)$ ,  $Ei(2.0 + 10.0*I)$

$-5.07089306 \cdot 10^{-438}$ ,  $1.895117816$ ,  $19643.40095$ ,  $-0.4549646329 + 3.710255582 i$

`Ei(3, -1000.0), Ei(1 + I, 1.0), Ei(-2, 12.3), Ei(1.0 + I, 2 + 10*I)`

`-1.976005087 10431, 0.1866485916 - 0.08748205256 i,`

`0.0000004351250372, 0.003718889079 + 0.01125612573 i`

For a positive constant  $x$ , `Ei(1, x)` returns  $- Ei(-x)$ . For a negative constant  $x$ , `Ei(1, x)` returns  $- Ei(-x) - \pi i$ :

`Ei(1, 3), Ei(1, -3)`

`-Ei(-3), -Ei(3) -  $\pi i$`

## Example 2

The 1-argument function `Ei(x)` is singular at the origin:

`Ei(0)`

`Error: Singularity. [Ei]`

The negative real axis is a branch cut. A jump of height  $2\pi i$  occurs when crossing this cut:

`Ei(-1.0), Ei(-1.0 + 10(-10)*I), Ei(-1.0 - 10(-10)*I)`

`-0.2193839344, -0.2193839344 + 3.141592654 i, -0.2193839344 - 3.141592654 i`

## Example 3

System functions such as `diff`, `float`, `limit`, `expand`, and `series` handle expressions involving `Ei`:

`diff(Ei(x), x, x, x), float(ln(3 + Ei(sqrt(PI))))`

$\frac{e^x}{x} - \frac{2e^x}{x^2} + \frac{2e^x}{x^3}, 1.968209389$

```
diff(Ei(3, x), x, x, x), float(ln(3 + Ei(I, sqrt(PI))))
```

$$-\frac{e^{-x}}{x}, 1.126485483 - 0.01132113135 i$$

```
limit(Ei(2*x^2/(1+x)), x = infinity)
```

$$\infty$$

```
expand(Ei(3, x))
```

$$\frac{e^{-x}}{2} - \frac{x e^{-x}}{2} + \frac{x^2 \operatorname{Ei}(1, x)}{2}$$

```
series(Ei(3, x), x = 0, 3)
```

$$\frac{1}{2} - x - x^2 \left( \frac{\operatorname{EULER}}{2} + \frac{\ln(x)}{2} - \frac{3}{4} \right) + O(x^3)$$

```
series(Ei(7/2, x), x = infinity, 3)
```

$$\frac{e^{-x}}{x} - \frac{7 e^{-x}}{2 x^2} + \frac{63 e^{-x}}{4 x^3} + O\left(\frac{e^{-x}}{x^4}\right)$$

## Parameters

**n, x**

arithmetical expressions (Symbolic Math Toolbox)

## Return Values

Arithmetical expression.

## Overloaded By

$n, x$

## Algorithms

If  $n$  is a non-positive integer, then  $Ei(n, x)$  is an analytic function of  $x$  throughout the complex plane apart from a pole at the origin. For all other values of  $n$ , the function  $Ei(n, x)$  has a branch cut along the negative real semi axis, where the values coincide with the limit “from above”:

$$Ei(x) = \lim_{\varepsilon \rightarrow 0^+} Ei(x + \varepsilon i)$$

for real  $x < 0$ .

The 1-argument function  $Ei(x)$  is related to the 2-argument function by

$$Ei(x) = -Ei(1, -x) + \frac{\ln(x) - \ln\left(\frac{1}{x}\right)}{2} - \ln(-x)$$

It has a logarithmic singularity at the origin and a branch cut along the negative real axis. Unlike the 2-argument function  $Ei(n, x)$  the 1-argument function  $Ei(x)$  is not continuous from either above or below along the branch cut.

The functions  $Ei(n, x)$  are related to the incomplete gamma function `igamma` by

$$Ei(n, x) = x^{n-1} \Gamma(1-n, x).$$

The functions  $Ei(x)$  and  $Ei(n, x)$  correspond to the exponential integral functions  $Ei(x)$  and  $E_n(x)$  considered in M. Abramowitz and I. Stegun, “Handbook of Mathematical Functions”, Dover Publications Inc., New York (1965).

## See Also

### MuPAD Functions

Chi | Ci | Li | Shi | Si | Ssi | exp | igamma | int

# ellipticK

Complete elliptic integral of the first kind

## Syntax

`ellipticK(m)`

## Description

`ellipticK(m)` represents the complete elliptic integral of the first kind  $K(m)$  which is defined as

$$K(m) = F\left(\frac{\pi}{2} \middle| m\right) = \int_0^{\pi/2} \frac{1}{\sqrt{1 - m \sin^2 \theta}} d\theta$$

The complete elliptic integral of the first kind is defined for a complex argument  $m$ .

For floating-point values  $m$ , `ellipticK(m)` returns floating-point results. For most exact arguments, it returns unevaluated symbolic calls. You can approximate such results with floating-point numbers using the `float` function.

## Environment Interactions

When called with floating-point arguments, this function is sensitive to the environment variable `DIGITS` which determines the numerical working precision.



## Examples

### Example 1

Most calls with exact arguments return themselves unevaluated. To approximate such values with floating-point numbers, use `float`:

```
ellipticK(PI/4);  
float(ellipticK(PI/4))
```

$$K\left(\frac{\pi}{4}\right)$$

2.225253684

Alternatively, use a floating-point value as an argument:

```
ellipticK(1/2);  
ellipticK(0.5)
```

$$K\left(\frac{1}{2}\right)$$

1.854074677

`ellipticK(0)` has a special value:

```
ellipticK(0)
```

$$\frac{\pi}{2}$$

## Parameters

`m`

An arithmetical expression specifying the parameter.

## Return Values

Arithmetical expression.

## See Also

### **MuPAD Functions**

`ellipticCE` | `ellipticCK` | `ellipticCPi` | `ellipticE` | `ellipticF` | `ellipticPi`

# ellipticCK

Complementary complete elliptic integral of the first kind

## Syntax

`ellipticCK(m)`

## Description

`ellipticCK(m)` represents the complementary complete elliptic integral of the first kind

$K'(m) = K(1-m)$ , where  $K(m)$  is the complete elliptic integral of the first kind:

$$K(m) = F\left(\frac{\pi}{2} \middle| m\right) = \int_0^{\pi/2} \frac{1}{\sqrt{1-m\sin^2\theta}} d\theta$$

The complementary complete elliptic integral of the first kind is defined for a complex argument  $m$ .

For floating-point values  $m$ , `ellipticCK(m)` returns floating-point results. For most exact arguments, it returns unevaluated symbolic calls. You can approximate such results with floating-point numbers using the `float` function.

## Environment Interactions

When called with floating-point arguments, this function is sensitive to the environment variable `DIGITS` which determines the numerical working precision.

## Examples

### Example 1

Most calls with exact arguments return themselves unevaluated. To approximate such values with floating-point numbers, use `float`:

```
ellipticCK(PI/4);  
float(ellipticCK(PI/4))
```

$$K'\left(\frac{\pi}{4}\right)$$

1.667061338

Alternatively, use a floating-point value as an argument:

```
ellipticCK(1/2);  
ellipticCK(0.5)
```

$$K'\left(\frac{1}{2}\right)$$

1.854074677

`ellipticCK(1)` has a special value:

```
ellipticCK(1)
```

$$\frac{\pi}{2}$$

## Parameters

$m$

An arithmetical expression specifying the parameter.

## Return Values

Arithmetical expression.

## See Also

### **MuPAD Functions**

`ellipticCE` | `ellipticCPi` | `ellipticE` | `ellipticF` | `ellipticK` | `ellipticPi`

## ellipticF

Incomplete elliptic integral of the first kind

### Syntax

```
ellipticF(phi, m)
```

### Description

`ellipticF(phi, m)` represents the incomplete elliptic integral of the first kind  $F(\phi|m)$  which is defined as

$$F(\phi|m) = \int_0^{\phi} \frac{1}{\sqrt{1 - m \sin^2 \theta}} d\theta$$

The incomplete elliptic integral of the first kind is defined for complex arguments  $\phi$  and  $m$ .

If all arguments are numerical and at least one is a floating-point value, `ellipticF` returns floating-point results. For most exact arguments, it returns unevaluated symbolic calls. You can approximate such results with floating-point numbers using the `float` function.

### Environment Interactions

When called with floating-point arguments, this function is sensitive to the environment variable `DIGITS` which determines the numerical working precision.

## Examples

### Example 1

Most calls with exact arguments return themselves unevaluated. To approximate such values with floating-point numbers, use `float`:

```
ellipticF(PI/4, I);
float(ellipticF(PI/4, I))
```

$$F\left(\frac{\pi}{4} \mid i\right)$$

$$0.7702389127 + 0.06683072312 i$$

Alternatively, use floating-point values as arguments. If one argument is a floating-point value and the others can be converted to a floating-point values, then a floating-point result will be returned:

```
ellipticE(1/4, I);
ellipticE(0.25, I)
```

$$E\left(\frac{1}{4} \mid i\right)$$

$$0.2500236825 - 0.002571289128 i$$

Some special arguments return explicit symbolic representations:

```
ellipticF(0, m),
ellipticF(p, 0)
```

$$0, p$$

## Parameters

**m**

An arithmetical expression specifying the parameter.

**phi**

An arithmetical expression specifying the amplitude.

## Return Values

Arithmetical expression.

## See Also

### **MuPAD Functions**

`ellipticCE` | `ellipticCK` | `ellipticCPi` | `ellipticE` | `ellipticK` | `ellipticPi`



# ellipticE

Complete and incomplete elliptic integrals of the second kind

## Syntax

ellipticE(< $\phi$ >, m)

## Description

ellipticE(m) represents the complete elliptic integral of the second kind  $E(m)$  which is defined as

$$E(m) = E\left(\frac{\pi}{2} \middle| m\right) = \int_0^{\pi/2} \sqrt{1 - m \sin^2 \theta} d\theta$$

ellipticE( $\phi$ , m) represents the incomplete elliptic integral of the second kind  $E(\phi|m)$  which is defined as

$$E(\phi|m) = \int_0^{\phi} \sqrt{1 - m \sin^2 \theta} d\theta$$

The elliptic integrals of the second kind are defined for complex arguments  $\phi$  and  $m$ .

If all arguments are numerical and at least one is a floating-point value, ellipticE returns floating-point results. For most exact arguments, it returns unevaluated symbolic calls. You can approximate such results with floating-point numbers using the float function.

## Environment Interactions

When called with floating-point arguments, this function is sensitive to the environment variable DIGITS which determines the numerical working precision.

## Examples

### Example 1

Most calls with exact arguments return themselves unevaluated. To approximate such values with floating-point numbers, use `float`:

```
ellipticE(-PI/4),  
ellipticE(PI/4, I);  
  
float(ellipticE(-PI/4)),  
float(ellipticE(PI/4, I))
```

$$E\left(-\frac{\pi}{4}\right), E\left(\frac{\pi}{4} \mid i\right)$$

1.844349247, 0.7907334926 – 0.07039826142 i

Alternatively, use floating-point values as arguments. If one argument is a floating-point value and the others can be converted to a floating-point values, then a floating-point result will be returned:

```
ellipticE(1/2),  
ellipticE(1/4, I);  
  
ellipticE(0.5),  
ellipticE(0.25, I)
```

$$E\left(\frac{1}{2}\right), E\left(\frac{1}{4} \mid i\right)$$

1.350643881, 0.2500236825 – 0.002571289128 i

Some special arguments return explicit symbolic representations:

```
ellipticE(0),  
ellipticE(1),  
ellipticE(0, m),  
ellipticE(p, 0)
```

$\frac{\pi}{2}, 1, 0, p$

## Parameters

**m**

An arithmetical expression specifying the parameter.

**$\varphi$**

An arithmetical expression specifying the amplitude. The default is  $\frac{\pi}{2}$ .

## Return Values

Arithmetical expression.

## See Also

### MuPAD Functions

ellipticCE | ellipticCK | ellipticCPi | ellipticF | ellipticK | ellipticPi

## ellipticCE

Complementary complete elliptic integral of the second kind

### Syntax

`ellipticCE(m)`

### Description

`ellipticCE(m)` represents the complementary complete elliptic integral of the second kind  $E'(m) = E(1-m)$ , where  $E(m)$  is the complete elliptic integral of the second kind:

$$E(m) = E\left(\frac{\pi}{2} \middle| m\right) = \int_0^{\pi/2} \sqrt{1 - m \sin^2 \theta} d\theta$$

The complementary complete elliptic integral of the second kind is defined for a complex argument  $m$ .

For floating-point values  $m$ , `ellipticCE(m)` returns floating-point results. For most exact arguments, it returns unevaluated symbolic calls. You can approximate such results with floating-point numbers using the `float` function.

### Environment Interactions

When called with floating-point arguments, this function is sensitive to the environment variable `DIGITS` which determines the numerical working precision.

## Examples

### Example 1

Most calls with exact arguments return themselves unevaluated. To approximate such values with floating-point numbers, use `float`:

```
ellipticCE(PI/4);  
float(ellipticCE(PI/4))
```

$$E'\left(\frac{\pi}{4}\right)$$

1.482786927

Alternatively, use a floating-point value as an argument:

```
ellipticCE(1/2);  
ellipticCE(0.5)
```

$$E'\left(\frac{1}{2}\right)$$

1.350643881

`ellipticCE(0)` and `ellipticCE(1)` have special values:

```
ellipticCE(0)
```

1

```
ellipticCE(1)
```

$\frac{\pi}{2}$

## Parameters

`m`

An arithmetical expression specifying the parameter.

## Return Values

Arithmetical expression.

## See Also

### **MuPAD Functions**

`ellipticCK` | `ellipticCPi` | `ellipticE` | `ellipticF` | `ellipticK` | `ellipticPi`

# ellipticPi

Complete and incomplete elliptic integrals of the third kind

## Syntax

`ellipticPi(n, <φ>, m)`

## Description

`ellipticPi(n, m)` represents the complete elliptic integral of the third kind

$$\Pi(n, m) = \Pi\left(n; \frac{\pi}{2} \mid m\right) = \int_0^{\pi/2} \frac{1}{(1 - n \sin^2 \theta) \sqrt{1 - m \sin^2 \theta}} d\theta$$

`ellipticPi(n, φ, m)` represents the incomplete elliptic integral of the third kind

$$\Pi(n, m) = \Pi(n; \varphi \mid m) = \int_0^{\varphi} \frac{1}{(1 - n \sin^2 \theta) \sqrt{1 - m \sin^2 \theta}} d\theta$$

The elliptic integrals of the third kind are defined for complex arguments  $m$ ,  $\phi$ , and  $n$ .

If all arguments are numerical and at least one is a floating-point value, `ellipticPi(n, <φ>, m)` returns floating-point results. For most exact arguments, it returns unevaluated symbolic calls. You can approximate such results with floating-point numbers using the `float` function.

## Environment Interactions

When called with floating-point arguments, this function is sensitive to the environment variable `DIGITS` which determines the numerical working precision.

## Examples

### Example 1

Most calls with exact arguments return themselves unevaluated. To approximate such values with floating-point numbers, use `float`:

```
ellipticPi(PI/4, I);  
float(ellipticPi(PI/4, I))
```

$$\Pi\left(\frac{\pi}{4} \mid i\right)$$

$$2.915856063 + 0.8257054693 i$$

Alternatively, use a floating-point value as an argument:

```
ellipticPi(1/2, 1, 1/4);  
ellipticPi(0.5, 1, 1/4)
```

$$\Pi\left(\frac{1}{2}; 1 \mid \frac{1}{4}\right)$$

$$1.228014414$$

Some special arguments return explicit symbolic representations:

```
ellipticPi(n, 0);  
ellipticPi(0, m);  
ellipticPi(0, p, m);  
ellipticPi(1, p, m)
```

$$\frac{\pi}{2\sqrt{1-n}}$$

$$K(m)$$



$F(p \mid m)$ 

$$F(p \mid m) - \frac{\tan(p) \sqrt{1 - m \sin(p)^2} - E(p \mid m)}{m - 1}$$

## Parameters

**m**

An arithmetical expression specifying the parameter.

 **$\varphi$** 

An arithmetical expression specifying the amplitude. The default is  $\frac{\pi}{2}$ .

**n**

An arithmetical expression specifying the characteristic.

## Return Values

Arithmetical expression.

## See Also

### MuPAD Functions

ellipticCE | ellipticCK | ellipticCPi | ellipticE | ellipticF | ellipticK

## ellipticCPi

Complementary complete elliptic integral of the third kind

### Syntax

`ellipticCPi(n,m)`

### Description

`ellipticCPi(n,m)` represents the complementary complete elliptic integral of the third kind  $\Pi'(n|m) = \Pi(n|1-m)$ , where  $\Pi(n|m)$  is the complete elliptic integral of the third kind:

$$\Pi(n,m) = \Pi\left(n; \frac{\pi}{2} \mid m\right) = \int_0^{\pi/2} \frac{1}{(1-n\sin^2\theta)\sqrt{1-m\sin^2\theta}} d\theta$$

The complementary complete elliptic integral of the third kind is defined for complex arguments  $m$  and  $n$ .

If all arguments are numerical and at least one is a floating-point value, `ellipticCPi(n,m)` returns floating-point results. For most exact arguments, it returns unevaluated symbolic calls. You can approximate such results with floating-point numbers using the `float` function.

### Environment Interactions

When called with floating-point arguments, this function is sensitive to the environment variable `DIGITS` which determines the numerical working precision.

## Examples

### Example 1

Most calls with exact arguments return themselves unevaluated. To approximate such values with floating-point numbers, use `float`:

```
ellipticCPi(-1, PI/4);
float(ellipticCPi(-1, PI/4))
```

$$\Pi'(-1 \mid \frac{\pi}{4})$$

1.166679569

Alternatively, use floating-point values as arguments. If one argument is a floating-point value and the others can be converted to a floating-point values, then a floating-point result will be returned:

```
ellipticCPi(1/2, 1/4);
ellipticCPi(0.5, 1/4)
```

$$\Pi'(\frac{1}{2} \mid \frac{1}{4})$$

3.234773471

Some special arguments return explicit symbolic representations:

```
ellipticCPi(0, m);
ellipticCPi(n, 1)
```

$$K'(m)$$

$$\frac{\pi}{2\sqrt{1-n}}$$

## Parameters

**m**

An arithmetical expression specifying the parameter.

**n**

An arithmetical expression specifying the characteristic.

## Return Values

Arithmetical expression.

## See Also

### **MuPAD Functions**

`ellipticCE` | `ellipticCK` | `ellipticE` | `ellipticF` | `ellipticK` | `ellipticPi`

# ellipticNome

Elliptic nome

## Syntax

`ellipticNome(m)`

## Description

`ellipticNome(m)` represents the elliptic nome  $q$  which is defined as

$$q(m) = e^{-\frac{\pi K'(m)}{K(m)}}$$

The elliptic nome  $q(m)$  is defined for complex arguments  $m$ .

$|q(m)| \leq 1$  holds for all  $m \in \mathbb{C}$ .

## Environment Interactions

When called with floating-point arguments, these functions are sensitive to the environment variable `DIGITS` which determines the numerical working precision.

## Examples

### Example 1

For most exact arguments, `ellipticNome` returns unevaluated:

```
ellipticNome(1/3),  
ellipticNome(2),  
ellipticNome(I)
```

$q\left(\frac{1}{3}\right)$ ,  $q(2)$ ,  $q(i)$

To approximate such values with floating-point numbers, use `float`:

```
float(ellipticNome(3/4))
```

0.0857957337

Alternatively, use a floating-point value as an argument:

```
ellipticNome(0.5)
```

0.04321391826

For  $m = 0$ ,  $m = 1/2$ , and  $m = 1$ , `ellipticNome` returns explicit results:

```
ellipticNome(0),  
ellipticNome(1/2),  
ellipticNome(1)
```

0,  $e^{-\pi}$ , 1

## Parameters

`m`

An arithmetical expression specifying the parameter.

## Return Values

Arithmetical expression.

## See Also

### MuPAD Functions

[ellipticCK](#) | [ellipticK](#)

## end

Close a block statement

## Description

end is a keyword which, depending on the context, is parsed as one of the following keywords:

- end\_case
- end\_for
- end\_if
- end\_proc
- end\_repeat
- end\_while

## Examples

### Example 1

Each of the keywords `proc`, `case`, `if`, `for`, `repeat`, and `while` starts some block construct in the MuPAD language. Each block can be closed with `end` or with the corresponding special keyword `end_proc`, `end_case` etc.:

```
f :=  
proc(a, b)  
  local i;  
begin  
  for i from a to b do  
    if isprime(i) then  
      print(Unquoted, expr2text(i)." is a prime")  
    end  
  end  
end:  
  
f(20, 30):
```



```
23 is a prime
```

```
29 is a prime
```

The parser translates `end` to the appropriate keyword matching the type of the block:

```
expose(f)
```

```
proc(a, b)
  name f;
  local i;
begin
  for i from a to b do
    if isprime(i) then
      print(Unquoted, expr2text(i)." is a prime")
    end_if
  end_for
end_proc
```

```
delete f:
```

## See Also

### MuPAD Functions

`end_case` | `end_for` | `end_if` | `end_proc` | `end_repeat` | `end_while`

# erf

Error function

## Syntax

`erf(x)`

## Description

`erf(x)` represents the error function  $\frac{2}{\sqrt{\pi}} \int_0^x e^{-t^2} dt$ .

This function is defined for all complex arguments  $x$ . For floating-point arguments, `erf` returns floating-point results.

The implemented exact values are:  $\text{erf}(0) = 0$ ,  $\text{erf}(\infty) = 1$ ,  $\text{erf}(-\infty) = -1$ ,  $\text{erf}(i\infty) = i\infty$ , and  $\text{erf}(-i\infty) = -i\infty$ . For all other arguments, the error function returns symbolic function calls.

For the function call `erf(x) = 1 - erfc(x)` with floating-point arguments of large absolute value, internal numerical underflow or overflow can happen. If a call to `erfc` causes underflow or overflow, this function returns:

- The result truncated to `0.0` if  $x$  is a large positive real number
- The result rounded to `2.0` if  $x$  is a large negative real number
- `RD_NAN` if  $x$  is a large complex number and MuPAD cannot approximate the function value

The error function `erf(x) = 1 - erfc(x)` returns corresponding values for large arguments. See “Example 2” on page 1-618 (Symbolic Math Toolbox).

MuPAD can simplify expressions that contain error functions and their inverses. For real values  $x$ , the system applies the following simplification rules:

- $\text{inverf}(\text{erf}(x)) = \text{inverf}(1 - \text{erfc}(x)) = \text{inverfc}(1 - \text{erf}(x)) = \text{inverfc}(\text{erfc}(x)) = x$
- $\text{inverf}(-\text{erf}(x)) = \text{inverf}(\text{erfc}(x) - 1) = \text{inverfc}(1 + \text{erf}(x)) = \text{inverfc}(2 - \text{erfc}(x)) = -x$

For any value  $x$ , the system applies the following simplification rules:

- $\text{inverf}(-x) = -\text{inverf}(x)$
- $\text{inverfc}(2 - x) = -\text{inverfc}(x)$
- $\text{erf}(\text{inverf}(x)) = \text{erfc}(\text{inverfc}(x)) = x$
- $\text{erf}(\text{inverfc}(x)) = \text{erfc}(\text{inverf}(x)) = 1 - x$

## Environment Interactions

When called with a floating-point argument, the functions are sensitive to the environment variable DIGITS, which determines the numerical working precision.

## Examples

### Example 1

You can call the error function with exact and symbolic arguments:

```
erf(0), erf(3/2), erf(sqrt(2)), erf(infinity)
```

```
0, erf(3/2), erf(sqrt(2)), 1
```

To approximate exact results with floating-point numbers, use `float`:

```
float(erf(3/2)), float(erf(sqrt(2)))
```

```
0.9661051465, 0.9544997361
```

Alternatively, use a floating-point value as an argument:

```
erf(-7.2), erf(2.0 + 3.5*I), erfc(3.0, 4), erf(5.5 + 1.0*I)
- 1.0, 421.8123327 + 343.6612334 i, 0.000000009433438115, 1.0 - 1.939028357 10-14 i
```

## Example 2

For large complex arguments, the error function can return **NaN**:

```
erf(38000.0 + 3801.0*I)
```

NaN

## Example 3

`diff`, `float`, `limit`, `series`, and other functions handle expressions involving the error function:

```
diff(erf(x), x, x, x)
```

$$\frac{8 x^2 e^{-x^2}}{\sqrt{\pi}} - \frac{4 e^{-x^2}}{\sqrt{\pi}}$$

```
limit(x/(1 + x)*erf(x), x = infinity)
```

1

```
series(erf(x), x = infinity, 3)
```

$$1 - \frac{e^{-x^2}}{x \sqrt{\pi}} + \frac{e^{-x^2}}{2 x^3 \sqrt{\pi}} + O\left(\frac{e^{-x^2}}{x^4}\right)$$

## Parameters

**x**

Arithmetical expression (Symbolic Math Toolbox)

## Return Values

Arithmetical expression

## Algorithms

`erf`, `erfc`, and `erfi` are entire functions.

## See Also

### MuPAD Functions

`erfc` | `erfi` | `inverf` | `inverfc` | `stats::normalQuantile`

## Topics

“Error Functions and Fresnel Functions” (Symbolic Math Toolbox)

# erfc

Complementary error function

## Syntax

`erfc(x)`

`erfc(x, n)`

## Description

$\text{erfc}(x) = 1 - \text{erf}(x) = \frac{2}{\sqrt{\pi}} \int_x^{\infty} e^{-t^2} dt$  computes the complementary error function.

$\text{erfc}(x, n) = \int_x^{\infty} \text{erfc}(t, n-1) dt$  with  $\text{erfc}(x, 0) = \text{erfc}(x)$  and  $\text{erfc}(x, -1) = \frac{2}{\sqrt{\pi}} e^{-x^2}$  returns the iterated integrals of the complementary error function. The calls `erfc(x)` and `erfc(x, 0)` are equivalent.

`erfc` is defined for all complex arguments  $x$ . For floating-point arguments, `erfc` returns floating-point results.

The implemented exact values are:

- $\text{erfc}(0) = 1, \text{erfc}(\infty) = 0, \text{erfc}(-\infty) = 2, \text{erfc}(i\infty) = 1 - i\infty, \text{erfc}(-i\infty) = 1 + i\infty$
- 

$$\text{erfc}(0, n) = \frac{1}{2^n \Gamma\left(\frac{n}{2} + 1\right)}, \text{erfc}(\infty, n) = 0, \text{erfc}(-\infty, n) = \infty$$

For all other arguments, the error function returns symbolic function calls.

If a numerical value of  $n$  is not an integer or if  $n < -1$ , the function call `erfc(x, n)` returns an error. The function also accepts symbolic values of  $n$ .

If  $n$  is a numerical value, you can use `expand(erfc(x, n))` to apply the following rules. See “Example 3” on page 1-623 (Symbolic Math Toolbox).

- 

The recurrence 
$$\text{erfc}(x, n) = \frac{\text{erfc}(x, n-2)}{2n} - \frac{x \text{erfc}(x, n-1)}{n}$$

- 

The reflection rule 
$$\text{erfc}(-x, n) = (-1)^{n+1} \text{erfc}(x, n) + \frac{H(n, ix)}{i^n 2^{n-1}}$$
, where  $H(n, ix)$  is the  $n$ -th degree Hermite polynomial at the point  $ix$ . See `orthpoly::hermite`.

For the function `erfc` with floating-point arguments of large absolute value, internal numerical underflow or overflow can happen. See “Example 2” on page 1-623 (Symbolic Math Toolbox). If a call to `erfc` causes underflow or overflow, this function returns:

- The result truncated to `0.0` if  $x$  is a large positive real number
- The result rounded to `2.0` if  $x$  is a large negative real number
- `RD_NAN` if  $x$  is a large complex number and MuPAD cannot approximate the function value

MuPAD can simplify expressions that contain error functions and their inverses. For real values  $x$ , the system applies the following simplification rules:

- $\text{inverf}(\text{erf}(x)) = \text{inverf}(1 - \text{erfc}(x)) = \text{inverfc}(1 - \text{erf}(x)) = \text{inverfc}(\text{erfc}(x)) = x$
- $\text{inverf}(-\text{erf}(x)) = \text{inverf}(\text{erfc}(x) - 1) = \text{inverfc}(1 + \text{erf}(x)) = \text{inverfc}(2 - \text{erfc}(x)) = -x$

For any value  $x$ , the system applies the following simplification rules:

- $\text{inverf}(-x) = -\text{inverf}(x)$
- $\text{inverfc}(2 - x) = -\text{inverfc}(x)$
- $\text{erf}(\text{inverf}(x)) = \text{erfc}(\text{inverfc}(x)) = x$
- $\text{erf}(\text{inverfc}(x)) = \text{erfc}(\text{inverf}(x)) = 1 - x$

## Environment Interactions

When called with a floating-point argument, the functions are sensitive to the environment variable DIGITS, which determines the numerical working precision.

## Examples

### Example 1

You can call the complementary error function with exact and symbolic arguments:

```
erfc(0), erfc(x + 1), erfc(-infinity), erfc(3/2), erfc(sqrt(2))
```

```
1, erfc(x + 1), 2, erfc( $\frac{3}{2}$ ), erfc( $\sqrt{2}$ )
```

```
erfc(0, n), erfc(x + 1, -1), erfc(-infinity, 5)
```

```
 $\frac{1}{2^n \Gamma(\frac{n}{2} + 1)}$ ,  $\frac{2 e^{-(x+1)^2}}{\sqrt{\pi}}$ ,  $\infty$ 
```

To approximate exact results with floating-point numbers, use `float`:

```
float(erfc(3/2)), float(erfc(sqrt(2)))
```

```
0.03389485352, 0.0455002639
```

Alternatively, use floating-points value as arguments:

```
erfc(-7.2), erfc(2.0 + 3.5*I), erfc(3.0, 4)
```

```
2.0, -420.8123327 - 343.6612334 i, 0.000000009433438115
```



## Example 2

For large complex arguments, the complementary error function can return **NaN**:

```
erfc(38000.0 + 3801.0*I)
```

NaN

For large floating-point arguments with positive real parts, erfc can return values truncated to 0.0:

```
erfc(27281.1), erfc(27281.2)
```

$4.085187475 \cdot 10^{-323227329}$ , 0.0

## Example 3

diff, float, limit, expand, rewrite, series, and other functions handle expressions involving the complementary error function:

```
diff(erfc(x, 3), x, x)
```

$\text{erfc}(x, 1)$

```
limit(x/(1 + x)*(1 - erfc(x)), x = infinity)
```

1

```
expand(erfc(x, 3))
```

$$\frac{e^{-x^2}}{6\sqrt{\pi}} - \frac{x^3 \text{erfc}(x)}{6} - \frac{x \text{erfc}(x)}{4} + \frac{x^2 e^{-x^2}}{6\sqrt{\pi}}$$

```
rewrite(erfc(x), erf),
rewrite(erfc(x), erfi)
```

`1 - erf(x), 1 + erfi(x i) i`

`series(erfc(x), x = infinity, 3)`

$$\frac{e^{-x^2}}{x\sqrt{\pi}} - \frac{e^{-x^2}}{2x^3\sqrt{\pi}} + O\left(\frac{e^{-x^2}}{x^4}\right)$$

## Parameters

**x**

Arithmetical expression (Symbolic Math Toolbox)

**n**

Arithmetical expression (Symbolic Math Toolbox) representing an integer larger than or equal to -1.

## Return Values

Arithmetical expression

## Algorithms

`erf`, `erfc`, and `erfi` are entire functions.

## See Also

### MuPAD Functions

`erf` | `erfi` | `inverf` | `inverfc` | `stats::normalQuantile`

**Topics**

"Error Functions and Fresnel Functions" (Symbolic Math Toolbox)

# erfi

Imaginary error function

## Syntax

`erfi(x)`

## Description

$$\text{erfi}(x) = -i \text{erf}(ix) = \frac{2}{\sqrt{\pi}} \int_0^x e^{t^2} dt$$
 computes the imaginary error function.

This function is defined for all complex arguments  $x$ . For floating-point arguments, `erfi` returns floating-point results.

The implemented exact values are:  $\text{erfi}(0) = 0$ ,  $\text{erfi}(\infty) = \infty$ ,  $\text{erfi}(-\infty) = -\infty$ ,  $\text{erfi}(i\infty) = i$ , and  $\text{erfi}(-i\infty) = -i$ . For all other arguments, the error function returns symbolic function calls.

For the function call  $\text{erfi}(x) = -i \cdot \text{erf}(i \cdot x) = i \cdot (\text{erfc}(i \cdot x) - 1)$  with floating-point arguments of large absolute value, internal numerical underflow or overflow can happen. If a call to `erfc` causes underflow or overflow, this function returns:

- The result truncated to `0.0` if  $x$  is a large positive real number
- The result rounded to `2.0` if  $x$  is a large negative real number
- `RD_NAN` if  $x$  is a large complex number and MuPAD cannot approximate the function value

The imaginary error function  $\text{erfi}(x) = i \cdot (\text{erfc}(i \cdot x) - 1)$  returns corresponding values for large arguments. See “Example 2” on page 1-628 (Symbolic Math Toolbox).

MuPAD can simplify expressions that contain error functions and their inverses. For real values  $x$ , the system applies the following simplification rules:

- $\text{inverf}(\text{erf}(x)) = \text{inverf}(1 - \text{erfc}(x)) = \text{inverfc}(1 - \text{erf}(x)) = \text{inverfc}(\text{erfc}(x)) = x$
- $\text{inverf}(-\text{erf}(x)) = \text{inverf}(\text{erfc}(x) - 1) = \text{inverfc}(1 + \text{erf}(x)) = \text{inverfc}(2 - \text{erfc}(x)) = -x$

For any value  $x$ , the system applies the following simplification rules:

- $\text{inverf}(-x) = -\text{inverf}(x)$
- $\text{inverfc}(2 - x) = -\text{inverfc}(x)$
- $\text{erf}(\text{inverf}(x)) = \text{erfc}(\text{inverfc}(x)) = x$
- $\text{erf}(\text{inverfc}(x)) = \text{erfc}(\text{inverf}(x)) = 1 - x$

## Environment Interactions

When called with a floating-point argument, the functions are sensitive to the environment variable DIGITS, which determines the numerical working precision.

## Examples

### Example 1

You can call the imaginary error function with exact and symbolic arguments:

```
erfi(0), erfi(x + 1), erfi(-infinity), erfi(3/2), erfi(sqrt(2))
```

```
0, erfi(x + 1), -∞, erfi( $\frac{3}{2}$ ), erfi( $\sqrt{2}$ )
```

To approximate exact results with floating-point numbers, use `float`:

```
float(erfi(3/2)), float(erfi(sqrt(2)))
```

```
4.584733257, 3.773122512
```

Alternatively, use floating-points value as arguments:

```
erfi(0.2), erfi(2.0 + 3.5*I), erfi(5.5 + 1.0*I)
```

```
0.2287212992, 0.00003369461013 + 1.000012586 i, -93412361266.0 - 5.089108513 1011 i
```

## Example 2

For large complex arguments, the imaginary error function can return **NaN**:

```
erfi(38000.0 + 3801.0*I)
```

```
NaN
```

## Example 3

`diff`, `float`, `limit`, `expand`, `rewrite`, and `series` handle expressions involving the error functions:

```
diff(erfi(x), x, x, x)
```

$$\frac{4 e^{x^2}}{\sqrt{\pi}} + \frac{8 x^2 e^{x^2}}{\sqrt{\pi}}$$

```
float(ln(3 + erfi(sqrt(PI)*I)))
```

```
1.150079617 + 0.3180894436 i
```

```
limit(x/(1 + x)*erfi(I*x)*I, x = infinity)
```

```
-1
```

```
rewrite(erfi(x), erfc)
```

```
erfc(x i) i - i
```

```
series(erfi(x), x = I*infinity, 3)
```

$$i + \frac{e^{x^2}}{x\sqrt{\pi}} + \frac{e^{x^2}}{2x^3\sqrt{\pi}} + O\left(\frac{e^{x^2}}{x^4}\right)$$

## Parameters

**x**

Arithmetical expression (Symbolic Math Toolbox)

## Return Values

Arithmetical expression

## Algorithms

erf, erfc, and erfi are entire functions.

## See Also

### MuPAD Functions

erf | erfc | inverf | inverfc | stats::normalQuantile

## Topics

“Error Functions and Fresnel Functions” (Symbolic Math Toolbox)

# inverf

Inverse of the error function

## Syntax

`inverf(x)`

## Description

`inverf(x)` computes the inverse of the error function. This function is defined for all complex arguments  $x$ .

The inverse function `inverf` is singular at the points  $x = -1$  and  $x = 1$ .

The inverses of the error functions return floating-point values only for floating-point arguments that belong to a particular interval. Thus, the inverse of the error function `inverf(x)` returns floating-point values for real values  $x$  from the interval  $[-1, 1]$ . The implemented exact values are: `inverf(-1) = -∞`, `inverf(0) = 0`, `inverf(1) = ∞`. For all other arguments, the error functions return symbolic function calls.

MuPAD can simplify expressions that contain error functions and their inverses. For real values  $x$ , the system applies the following simplification rules:

- $\text{inverf}(\text{erf}(x)) = \text{inverf}(1 - \text{erfc}(x)) = \text{inverfc}(1 - \text{erf}(x)) = \text{inverfc}(\text{erfc}(x)) = x$
- $\text{inverf}(-\text{erf}(x)) = \text{inverf}(\text{erfc}(x) - 1) = \text{inverfc}(1 + \text{erf}(x)) = \text{inverfc}(2 - \text{erfc}(x)) = -x$

For any value  $x$ , the system applies the following simplification rules:

- $\text{inverf}(-x) = -\text{inverf}(x)$
- $\text{inverfc}(2 - x) = -\text{inverfc}(x)$
- $\text{erf}(\text{inverf}(x)) = \text{erfc}(\text{inverfc}(x)) = x$
- $\text{erf}(\text{inverfc}(x)) = \text{erfc}(\text{inverf}(x)) = 1 - x$



## Environment Interactions

When called with a floating-point argument, the functions are sensitive to the environment variable DIGITS, which determines the numerical working precision.

## Examples

### Example 1

You can call the inverse of the error function with exact and symbolic arguments:

```
inverf(-1), inverf(0), inverf(1), inverf(x + 1), inverf(1/5), inverf(1/sqrt(2))
```

$$-\infty, 0, \infty, \operatorname{inverf}(x + 1), \operatorname{inverf}\left(\frac{1}{5}\right), \operatorname{inverf}\left(\frac{\sqrt{2}}{2}\right)$$

To approximate exact results with floating-point numbers, use `float`:

```
float(inverf(1/5)), float(inverf(1/sqrt(2)))
```

$$0.1791434546, 0.7437319851$$

Alternatively, use floating-points value as arguments:

```
inverf(0.2), inverf(1/sqrt(2.0))
```

$$0.1791434546, 0.7437319851$$

For floating-point arguments  $x$  from the interval  $[-1, 1]$ , `inverf` returns floating-point values:

```
inverf(-0.5), inverf(0.85)
```

$$-0.4769362762, 1.017902465$$

For floating-point arguments outside of this interval, `inverf` returns symbolic function calls:

```
inverf(-5.3), inverf(10.0)
```

NaN, NaN

## Example 2

diff, float, limit, rewrite, series, and other functions handle expressions involving the inverse of the error function:

```
diff(inverf(x), x)
```

$$\frac{\sqrt{\pi} e^{\text{inverf}(x)^2}}{2}$$

```
float(ln(3 + inverf(1/sqrt(PI))))
```

1.267240357

```
limit(1/inverf(x), x = 0, Right);  
limit(1/inverf(x), x = 0, Left)
```

$\infty$

$-\infty$

```
rewrite(inverfc(x), inverf)
```

$-\text{inverf}(x - 1)$

```
series(inverf(x), x = 0)
```

$$\frac{x \sqrt{\pi}}{2} + \frac{x^3 \pi^{3/2}}{24} + \frac{7 x^5 \pi^{5/2}}{960} + O(x^7)$$

## Parameters

**x**

Arithmetical expression (Symbolic Math Toolbox)

## Return Values

Arithmetical expression

## See Also

### **MuPAD Functions**

`erf` | `erfc` | `erfi` | `inverfc` | `stats::normalQuantile`

## Topics

“Error Functions and Fresnel Functions” (Symbolic Math Toolbox)

# **inverfc**

Inverse of the complementary error function

## **Syntax**

`inverfc(x)`

## **Description**

`inverfc(x) = inverf(1 - x)` computes the inverse of the complementary error function. This function is defined for all complex arguments  $x$ .

The inverse function `inverfc` is singular at the points  $x = 0$  and  $x = 2$ .

The inverses of the error functions return floating-point values only for floating-point arguments that belong to a particular interval. Thus, the inverse of the complementary error function `inverfc(x)` returns floating-point values for real values  $x$  from the interval  $[0, 2]$ . The implemented exact values are: `inverfc(0) = ∞`, `inverfc(1) = 0`, `inverfc(2) = -∞`. For all other arguments, the error functions return symbolic function calls.

MuPAD can simplify expressions that contain error functions and their inverses. For real values  $x$ , the system applies the following simplification rules:

- $\text{inverf}(\text{erf}(x)) = \text{inverf}(1 - \text{erfc}(x)) = \text{inverfc}(1 - \text{erf}(x)) = \text{inverfc}(\text{erfc}(x)) = x$
- $\text{inverf}(-\text{erf}(x)) = \text{inverf}(\text{erfc}(x) - 1) = \text{inverfc}(1 + \text{erf}(x)) = \text{inverfc}(2 - \text{erfc}(x)) = -x$

For any value  $x$ , the system applies the following simplification rules:

- $\text{inverf}(-x) = -\text{inverf}(x)$
- $\text{inverfc}(2 - x) = -\text{inverfc}(x)$
- $\text{erf}(\text{inverf}(x)) = \text{erfc}(\text{inverfc}(x)) = x$

- $\text{erf}(\text{inverfc}(x)) = \text{erfc}(\text{inverf}(x)) = 1 - x$

## Environment Interactions

When called with a floating-point argument, the functions are sensitive to the environment variable DIGITS, which determines the numerical working precision.

## Examples

### Example 1

You can call the inverse of the complementary error function with exact and symbolic arguments:

```
inverfc(0), inverfc(1), inverfc(2), inverfc(15), inverfc(x/5), inverfc(1/5), inverfc(s
```

```
∞, 0, -∞, undefined, inverfc( $\frac{x}{5}$ ), -inverfc( $\frac{9}{5}$ ), inverfc( $\sqrt{2}$ )
```

To approximate exact results with floating-point numbers, use `float`:

```
float(inverfc(1/5)), float(inverfc(sqrt(2)))
```

```
0.9061938024, -0.3853393505
```

Alternatively, use floating-points value as arguments:

```
inverfc(0.2), inverfc(sqrt(2.0))
```

```
0.9061938024, -0.3853393505
```

For floating-point arguments  $x$  from the interval  $[0, 2]$ , `inverfc` returns floating-point values:

```
inverfc(0.5), inverfc(1.25)
```

0.4769362762, -0.225312055

For floating-point arguments outside of this interval, `inverfc` returns symbolic function calls:

```
inverfc(-1.25), inverfc(2.5)
```

NaN, NaN

## Example 2

`diff`, `float`, `limit`, `rewrite`, `series`, and other functions handle expressions involving the inverse of the complementary error function:

```
diff(inverfc(x), x)
```

$$-\frac{\sqrt{\pi} e^{\text{inverfc}(x)^2}}{2}$$

```
float(ln(3 + inverfc(sqrt(PI))))
```

0.7639464073

```
limit(1/inverfc(x), x = 1, Right);  
limit(1/inverfc(x), x = 1, Left)
```

$-\infty$

$\infty$

```
rewrite(inverfc(x), inverf)
```

$-\text{inverf}(x - 1)$

```
series(inverfc(x), x = 1)
```

$$-\frac{\sqrt{\pi}(x-1)}{2} - \frac{\pi^{3/2}(x-1)^3}{24} - \frac{7\pi^{5/2}(x-1)^5}{960} + O((x-1)^7)$$

## Parameters

**x**

Arithmetical expression (Symbolic Math Toolbox)

## Return Values

Arithmetical expression

## See Also

### MuPAD Functions

erf | erfc | erfi | inverf | stats::normalQuantile

## Topics

“Error Functions and Fresnel Functions” (Symbolic Math Toolbox)

## error

Raise a user-specified exception

### Syntax

```
error(message)
```

### Description

`error(message)` aborts the current procedure on page 7-45, returns to the interactive level, and displays the error message `message`.

If the error is not caught via `traperror` by a procedure that has directly or indirectly called the current procedure, control is returned to the interactive level, and the string `message` is printed as an error message.

The printed error message has the form `Error: message [name]`, where `name` is the name of the procedure containing the call to `error`. See the examples.

Errors can be caught by the function `traperror`. If an error occurs while the arguments of `traperror` are evaluated, control is returned to the procedure containing the call to `traperror` and not to the interactive level. No error message is printed. The return value of `traperror` is `1028` when it catches an error raised by `error`; see “Example 2” on page 1-639 (Symbolic Math Toolbox).

The function `error` is useful to raise an error in the type checking part of a user-defined procedure on page 7-45, when this procedure is called with invalid arguments.

### Examples

#### Example 1

If the divisor of the following simple division routine is `0`, then an error is raised:



```
mydivide := proc(n, d) begin
  if iszero(d) then
    error("Division by 0")
  end_if;
  n/d
end_proc;
mydivide(2, 0)
```

Error: Division by 0 [mydivide]

## Example 2

When the error is raised in the following procedure `p`, control is returned to the interactive level immediately. The second call to `print` is never executed. Note that the procedure's name is printed in the error message:

```
p := proc() begin
  print("entering procedure p");
  error("oops");
  print("leaving procedure p")
end_proc;
p()
```

"entering procedure p"

Error: oops [p]

The following procedure `q` calls the procedure `p` and catches any error that is raised within `p`:

```
q := proc() begin
  print("entering procedure q");
  print("caught error: ", traperror(p()));
  print("leaving procedure q")
end_proc;
q()
```

"entering procedure q"

"entering procedure p"

"caught error: ", 1028

"leaving procedure q"

## Parameters

**message**

The error message: a string on page 7-53

## See Also

**MuPAD Functions**

getlasterror | lasterror | traperror | warning

# euler

Euler numbers and polynomials

## Syntax

`euler(n)`

`euler(n, x)`

## Description

`euler(n)` returns the  $n$ -th Euler number.

`euler(n, x)` returns the  $n$ -th Euler polynomial in  $x$ .

The Euler polynomials are defined by the generating function

$$\frac{2 e^{x t}}{e^t + 1} = \sum_{n=0}^{\infty} \frac{\text{euler}(n, x)}{n!} t^n$$

The Euler numbers are defined by `euler(n) = 2^n * euler(n, 1/2)`.

An error occurs if  $n$  is a numerical value not representing a nonnegative integer.

If  $n$  is an integer larger than the value returned by `Pref::autoExpansionLimit()`, then the call `euler(n)` is returned symbolically. Use `expand(euler(n))` to get an explicit numerical result for large integers  $n$ .

If  $n$  contains non-numerical symbolic identifiers, then the call `euler(n)` is returned symbolically. In most cases, the same holds true for calls `euler(n, x)`. Some simplifications are implemented for special numerical values such as  $x = 0$ ,  $x = 1/2$ ,  $x = 1$  etc. for symbolic  $n$ . Cf. "Example 3" on page 1-643 (Symbolic Math Toolbox).

---

**Note** Note that floating-point evaluation for high degree polynomials may be numerically unstable. See "Example 4" on page 1-644 (Symbolic Math Toolbox).

---

The floating-point evaluation on the standard interval  $x \in [0, 1]$  is numerically stable for arbitrary  $n$ .

To use the Euler constant, call `E` or `exp(1)`. To use the Euler-Mascheroni constant, call `EULER`. See “Mathematical Constants Available in MuPAD” (Symbolic Math Toolbox). You can approximate these constants with floating-point numbers by using `float`.

## Environment Interactions

When called with a floating-point value  $x$ , the function is sensitive to the environment variable `DIGITS` which determines the numerical working precision.

## Examples

### Example 1

The first Euler numbers are:

```
euler(n) $ n = 0..11
```

$1, 0, -1, 0, 5, 0, -61, 0, 1385, 0, -50521, 0$

The first Euler polynomials:

```
euler(n, x) $ n = 0..4
```

$1, x - \frac{1}{2}, x^2 - x, x^3 - \frac{3x^2}{2} + \frac{1}{4}, x^4 - 2x^3 + x$

If  $n$  is symbolic, then a symbolic call is returned:

```
euler(n, x), euler(n + 3/2, x), euler(n + 5*I, x)
```

$euler(n, x), euler\left(n + \frac{3}{2}, x\right), euler(n + 5i, x)$

## Example 2

If  $x$  is not an indeterminate, then the evaluation of the Euler polynomial at the point  $x$  is returned:

`euler(50, 1 + I)`

$$-1 + 62090611395916250987641126809722842228171 i$$

`euler(3, 1 - y) = expand(euler(3, 1 - y))`

$$\frac{1}{4} - (y-1)^3 - \frac{3(y-1)^2}{2} = -y^3 + \frac{3y^2}{2} - \frac{1}{4}$$

## Example 3

Certain simplifications occur for some special numerical values of  $x$ , even if  $n$  is symbolic:

`euler(n, 0), euler(n, 1/2), euler(n, 1)`

$$-\frac{2 \operatorname{bernoulli}(n+1) (2^{n+1} - 1)}{n+1}, \frac{\operatorname{euler}(n)}{2^n}, \frac{2 \operatorname{bernoulli}(n+1) (2^{n+1} - 1)}{n+1}$$

Calls with numerical arguments between  $\frac{1}{2}$  and 1 are automatically rewritten in terms of calls with arguments between 0 and  $\frac{1}{2}$ :

`euler(n, 2/3), euler(n, 0.7)`

$$(-1)^n \operatorname{euler}\left(n, \frac{1}{3}\right), (-1)^n \operatorname{euler}(n, 0.3)$$

Calls with negative numerical arguments are automatically rewritten in terms of calls with positive arguments:

`euler(n, -2)`

$$(-1)^{n+1} \text{euler}(n, 2) + 2 (-2)^n$$

`euler(n, -12.345)`

$$2 (-12.345)^n + (-1)^{n+1} \text{euler}(n, 12.345)$$

### Example 4

Float evaluation of high degree polynomials may be numerically unstable:

`exact := euler(50, 1 + I): float(exact);`

$$-1.0 + 6.20906114 \cdot 10^{40} i$$

`euler(50, float(1 + I))`

$$-1.774947368 \cdot 10^{23} + 6.20906114 \cdot 10^{40} i$$

`DIGITS := 40: euler(50, float(1 + I))`

$$-0.9999999981373548507689370896315932124576$$

$$+ 6.2090611395916250987641126809722842228177 \cdot 10^{40} i$$

`delete exact, DIGITS;`

### Example 5

Some system functions such as `diff` or `expand` handle symbolic calls of `euler`:

`diff(euler(n, f(x)), x)`

$$n \text{euler}(n-1, f(x)) \frac{\partial}{\partial x} f(x)$$

`expand(euler(n, x + 2))`

$$\text{euler}(n, x) - 2x^n + 2(x + 1)^n$$

`expand(euler(n, -x))`

$$2(-x)^n - (-1)^n \text{euler}(n, x)$$

`expand(euler(n, 3*x))`

$$3^n \text{euler}(n, x) - 3^n \text{euler}\left(n, x + \frac{1}{3}\right) + 3^n \text{euler}\left(n, x + \frac{2}{3}\right)$$

## Parameters

**n**

An arithmetical expression (Symbolic Math Toolbox) representing a nonnegative integer

**x**

An arithmetical expression (Symbolic Math Toolbox)

## Return Values

Arithmetical expression.

## References

M. Abramowitz and I. Stegun, "Handbook of Mathematical Functions", Dover Publications Inc., New York (1965).

## **See Also**

### **MuPAD Functions**

bernoulli



# eval

Evaluate an object

## Syntax

```
eval(object)
```

## Description

`eval(object)` evaluates its argument `object` by recursively replacing the identifiers occurring in it by their values and executing function calls, and then evaluates the result again.

`eval` serves to request the evaluation of unevaluated or partially evaluated objects. *Evaluation* means that identifiers on page 7-29 are replaced by their values and function calls are executed.

Usually, every system function automatically evaluates its arguments and returns a fully evaluated object, and using `eval` is only necessary in exceptional cases. For example, the functions `map`, `op`, and `subs` may return objects that are not fully evaluated. See “Example 1” on page 1-649 (Symbolic Math Toolbox).

Like most other MuPAD functions, `eval` first evaluates its argument. Then it evaluates the result again. At interactive level, the second evaluation usually has no effect, but this is different within procedures on page 7-45. See “Example 3” on page 1-650 (Symbolic Math Toolbox) and “Example 4” on page 1-651 (Symbolic Math Toolbox).

`eval` is sensitive to the value of the environment variable `LEVEL`, which determines the maximal depth of the recursive process that replaces an identifier on page 7-29 by its value during evaluation. The evaluation of the argument and the subsequent evaluation of the result both take place with substitution depth `LEVEL`. See “Example 3” on page 1-650 (Symbolic Math Toolbox).

If a local variable or a formal parameter, of type `DOM_VAR`, of a procedure occurs in `object`, then it is always replaced by its value when `eval` evaluates its argument, independent of the value of `LEVEL`. At the subsequent second evaluation, the value of the

local variable is evaluated with substitution depth given by `LEVEL`, which usually is 1. Cf. “Example 4” on page 1-651 (Symbolic Math Toolbox).

The behavior of `eval` within a procedure on page 7-45 may sometimes not be what you expect, since the default substitution depth within procedures is 1 and `eval` evaluates with this substitution depth. Use `level` to request a complete evaluation within a procedure; see the corresponding help page for details.

`eval` enforces the evaluation of expressions on page 7-20 of the form `hold(x)`: `eval(hold(x))` is equivalent to `x`. Cf. “Example 2” on page 1-649 (Symbolic Math Toolbox).

`eval` accepts expression sequences on page 1-88 as arguments. See “Example 3” on page 1-650 (Symbolic Math Toolbox). In particular, the call `eval()` returns the empty sequence `null()`.

`eval` does not recursively descend into arrays. Use the call `map(object, eval)` to evaluate the entries of an array. Cf. “Example 5” on page 1-652 (Symbolic Math Toolbox).

`eval` does not recursively descend into tables. Use the call `map(object, eval)` to evaluate the entries of a table.

However, it is not possible to evaluate the indices of a given table. If you want to do this, create a new table with the evaluated operands of the old one. Cf. “Example 6” on page 1-653 (Symbolic Math Toolbox).

Polynomials are not further evaluated by `eval`. Use `evalp` to substitute values for the indeterminates of a polynomial, and use the call `mapcoeffs(object, eval)` to evaluate all coefficients. Cf. “Example 7” on page 1-653 (Symbolic Math Toolbox).

The evaluation of elements of a user-defined domain (Symbolic Math Toolbox) depends on the implementation of the domain. Usually, domain elements remain unevaluated. If the domain has a slot “`evaluate`”, the corresponding slot routine is called with the domain element as argument at each evaluation, and hence it is called twice when `eval` is invoked. Cf. “Example 8” on page 1-654 (Symbolic Math Toolbox).

## Environment Interactions

`eval` is sensitive to the value of the environment variable `LEVEL`, which determines the maximal substitution depth for identifiers.

## Examples

### Example 1

`subs` performs a substitution, but does not evaluate the result:

```
subs(ln(x), x = 1)
```

$\ln(1)$

An explicit call of `eval` is necessary to evaluate the result:

```
eval(subs(ln(x), x = 1))
```

0

`text2expr` does not evaluate its result either:

```
a := c:  
text2expr("a + a"), eval(text2expr("a + a"))
```

$a + a, 2c$

### Example 2

The function `hold` prevents the evaluation of its argument. A later evaluation can be forced with `eval`:

```
hold(1 + 1); eval(%)
```

1 + 1

2

### Example 3

When an object is evaluated, identifiers are replaced by their values recursively. The maximal recursion depth of this process is given by the environment variable LEVEL:

```
delete a0, a1, a2, a3, a4:  
a0 := a1: a1 := a2 + 2: a2 := a3 + a4: a3 := a4^2: a4 := 5:
```

```
LEVEL := 1: a0, a0 + a2;  
LEVEL := 2: a0, a0 + a2;  
LEVEL := 3: a0, a0 + a2;  
LEVEL := 4: a0, a0 + a2;  
LEVEL := 5: a0, a0 + a2;
```

a1, a1 + a3 + a4

a2 + 2, a4<sup>2</sup> + a2 + 7

a3 + a4 + 2, a3 + a4 + 32

a4<sup>2</sup> + 7, a4<sup>2</sup> + 37

32, 62

eval first evaluates its argument and then evaluates the result again. Both evaluations happen with substitution depth given by LEVEL:

```
LEVEL := 1: eval(a0, a0 + a2);  
LEVEL := 2: eval(a0, a0 + a2);  
LEVEL := 3: eval(a0, a0 + a2);
```

a2 + 2, a4<sup>2</sup> + a2 + 7

a4<sup>2</sup> + 7, a4<sup>2</sup> + 37

32, 62

Since the default value of LEVEL is 100, eval usually has no effect at interactive level:

```
delete LEVEL:
a0, eval(a0), a0 + a2, eval(a0 + a2)
```

32, 32, 62, 62

## Example 4

This example shows the difference between the evaluation of identifiers on page 7-29 and local variables on page 7-56. By default, the value of LEVEL is 1 within a procedure, i.e., a global identifier is replaced by its value when evaluated, but there is no further recursive evaluation. This changes when LEVEL is assigned a bigger value inside the procedure:

```
delete a0, a1, a2, a3:
a0 := a1 + a2:  a1 := a2 + a3:  a2 := a3^2 - 1:  a3 := 5:
p := proc()
    save LEVEL;
    begin
        print(a0, eval(a0)):
        LEVEL := 2:
        print(a0, eval(a0)):
    end_proc:
p()
```

$a1 + a2, a3^2 + a3 + a2 - 1$

$a3^2 + a3 + a2 - 1, 53$

In contrast, evaluation of a local variable replaces it by its value, without further evaluation. When eval is applied to an object containing a local variable, then the effect is an evaluation of the value of the local variable with substitution depth LEVEL:

```
q := proc()
    save LEVEL;
```

```
    local x;
  begin
    x := a0:
    print(x, eval(x)):
    LEVEL := 2:
    print(x, eval(x)):
  end_proc:
q()

a1 + a2, a32 + a3 + a2 - 1

a1 + a2, a32 + 28
```

The command `x:=a0` assigns the value of the identifier `a0`, namely the unevaluated expression `a1+a2`, to the local variable `x`, and `x` is replaced by this value every time it is evaluated, independent of the value of `LEVEL`:

## Example 5

In contrast to lists on page 7-41 and sets on page 7-50, evaluation of an array on page 7-2 does not evaluate its entries. Thus `eval` has no effect for arrays either. Use `map` to evaluate all entries of an array:

```
delete a, b:
L := [a, b]: A := array(1..2, L): a := 1: b := 2:
L, A, eval(A), map(A, eval)
```

```
[1, 2], (a b), (a b), (1 2)
```

The call `map(A, gamma)` does not evaluate the entries of the array `A` before applying the function `gamma`. Map the function `gamma@eval` to enforce the evaluation:

```
map(A, gamma), map(A, gamma@eval)
```

```
(Γ(a) Γ(b) ), (1 1)
```

## Example 6

Similarly, evaluation of a table on page 1-2103 does not evaluate its entries, and you can use `map` to achieve this. However, this does not affect the indices:

```
delete a, b:
T := table(a = b): a := 1: b := 2:
T, eval(T), map(T, eval)
```

$$\overline{a|b}, \overline{a|b}, \overline{a|2}$$

If you want a table with evaluated indices as well, create a new table from the evaluated operands of the old table. Using `eval` is necessary here since the operand function `op` does not evaluate the returned operands:

```
op(T), table(eval(op(T)))
```

$$a = b, \overline{1|2}$$

## Example 7

Polynomials are inert when evaluated, and also `eval` has no effect:

```
delete a, x: p := poly(a*x, [x]): a := 2: x := 3:
p, eval(p), map(p, eval)
```

$$\text{poly}(a x, [x]), \text{poly}(a x, [x]), \text{poly}(a x, [x])$$

Use `mapcoeffs` to evaluate all coefficients:

```
mapcoeffs(p, eval)
```

$$\text{poly}(2 x, [x])$$

If you want to substitute a value for the indeterminate `x`, use `evalp`:

```
delete x: evalp(p, x = 3)
```

3 *a*

As you can see, the result of an `evalp` call may contain unevaluated identifiers, and you can evaluate them by an application of `eval`:

```
eval(evalp(p, x = 3))
```

6

## Example 8

The evaluation of an element of a user-defined domains (Symbolic Math Toolbox) depends on the implementation of the domain. Usually, it is not evaluated further:

```
delete a: T := newDomain("T"):
e := new(T, a): a := 1:
e, eval(e), map(e, eval), val(e)
```

*new(T, a), new(T, a), new(T, a), new(T, a)*

If the slot "evaluate" exists, the corresponding slot routine is called for a domain element each time it is evaluated. We implement the routine `T::evaluate`, which simply evaluates all internal operands of its argument, for our domain `T`. The unevaluated domain element can still be accessed via `val`:

```
T::evaluate := x -> new(T, eval(extop(x))):
e, eval(e), map(e, eval), val(e)
```

*new(T, 1), new(T, 1), new(T, 1), new(T, a)*

## Parameters

### object

Any MuPAD object



## Return Values

Evaluated object.

## See Also

### **MuPAD Functions**

LEVEL | MAXDEPTH | MAXLEVEL | context | evalassign | evalp | freeze | hold |  
indexval | level | val

## Topics

“Enforce Evaluation” (Symbolic Math Toolbox)

“Evaluations in Symbolic Computations” (Symbolic Math Toolbox)

“Level of Evaluation” (Symbolic Math Toolbox)

“Actual and Displayed Results of Evaluations” (Symbolic Math Toolbox)

## evalassign

Assignment with evaluation of the left hand side

### Syntax

```
evalassign(x, value, i)
```

```
evalassign(x, value)
```

### Description

`evalassign(x, value, i)` evaluates `x` with substitution depth `i` and assigns `value` to the result of the evaluation.

`evalassign(x, value, i)` evaluates `value`, as usual. Then it evaluates `x` with substitution depth `i`, and finally it assigns the evaluation of `value` to the evaluation of `x`.

The difference between `evalassign` and the assignment operator `:=` is that the latter does not evaluate its left hand side at all.

As usual, the evaluation of `value` takes place with substitution depth given by `LEVEL`. By default, it is 1 within a procedure.

See the help pages of `LEVEL` and `level` for the notion of substitution depth and for details about evaluation.

The third argument is optional. The calls `evalassign(x, value)`, `evalassign(x, value, 0)`, `x := value`, and `_assign(x, value)` are all equivalent.

The result of the evaluation of `x` must be a valid left hand side for an assignment. See the help page of `:=` for details.

The second argument is *not* flattened (Symbolic Math Toolbox). Hence it may also be a sequence. Cf. "Example 2" on page 1-657 (Symbolic Math Toolbox).

## Examples

### Example 1

evalassign can be used in situations such as the following. Suppose that an identifier on page 7-29a has another identifier b as its value, and that we want to assign something to this *value* of a, not to a itself:

```
delete a, b: a := b:  
evalassign(a, 100, 1): level(a, 1), a, b
```

*b, 100, 100*

This would not have worked with the assignment operator :=, which does not evaluate its left hand side:

```
delete a, b: a := b:  
a := 100: level(a, 1), a, b
```

*100, 100, b*

### Example 2

The second argument may also be a sequence:

```
a := b:  
evalassign(a, (3,5), 1):  
b
```

*3, 5*

## Parameters

**x**

An object that evaluates to a valid left hand side of an assignment on page 1-257

**value**

Any MuPAD object

**i**

A nonnegative integer on page 7-31 less than  $2^{31}$

## Return Values

value.

## Algorithms

The function `level` is used for the evaluation of  $x$ . Hence `i` may exceed the value of `LEVEL`.

All special rules for `_assign` apply: see there on further details on indexed assignments, assignments to slots, and the `protect` mechanism.

## See Also

**MuPAD Functions**

`:=` | `LEVEL` | `_assign` | `assign` | `assignElements` | `delete` | `eval` | `level`

# |evalAt

Insert a value (evaluate at a point)

## Syntax

$f \mid x = v$

`evalAt(f, x = v)`

$f \mid (x_1 = v_1, x_2 = v_2, \dots)$

`evalAt(f, x1 = v1, x2 = v2, ...)`

`evalAt(f, x1 = v1, x2 = v2, ...)`

$f \mid [x_1 = v_1, x_2 = v_2, \dots]$

`evalAt(f, [x1 = v1, x2 = v2, ...])`

$f \mid \{x_1 = v_1, x_2 = v_2, \dots\}$

`evalAt(f, {x1 = v1, x2 = v2, ...})`

## Description

`evalAt(f, x = v)` substitutes  $x = v$  in the object  $f$  and evaluates.

The MuPAD statement  $f \mid x = v$  serves as a shortcut for calling `evalAt(f, x = v)`.

`evalAt(f, x = v)` evaluates the object  $f$  at the point  $x = v$ . Essentially, it is the same as `eval ( subs(f, x = v) )`, but limited to free (as opposed to bound) variables.

Several substitutions of indeterminates by values can be done by `evalAt(f, x1 = v1, x2 = v2, ...)`. This is equivalent to `evalAt(... (evalAt(evalAt(f, x1 = v1), x2 = v2), ...), ...)`, i.e.,  $x_1 = v_1$  is substituted in  $f$ , then  $x_2 = v_2$  is substituted in the result etc. E.g., `evalAt(x, x = y, y = 1)` yields 1.

Note that the three (equivalent) calls `evalAt(f, (x1 = v1, x2 = v2, ...))`, `evalAt(f, [x1 = v1, x2 = v2, ...])`, `evalAt(f, {x1 = v1, x2 =`

$v_2, \dots\}$ ) do parallel substitutions, i.e., the substitutions  $x_1 = v_1, x_2 = v_2$  are all performed on  $f$  simultaneously. Consequently, `evalAt(x, [x = y, y = 1])` yields  $y$ , not 1!

The operator `|` provides a shortcut for calling `evalAt`:

The command `f | x = v` is equivalent to calling `evalAt(f, x = v)`.

Similarly, `f | (x1=v1, x2=v2, ...)` is equivalent to `evalAt(f, (x1=v1, x2=v2, ...))`, `f | [x1=v1, x2=v2, ...]` is equivalent to `evalAt(f, [x1=v1, x2=v2, ...])`, `f | {x1=v1, x2=v2, ...}` is equivalent to `evalAt(f, {x1=v1, x2=v2, ...})`.

---

**Note** The sequential substitution `evalAt(f, x1 = v1, x2 = v2, ...)` cannot be done via `f | x1 = v1, x2 = v2, ...`: this produces the sequence `evalAt(f, x1 = v1), x2 = v2, ...`. Use `f | x1 = v1 | x2 = v2 | ...` for sequential substitution. E.g., the statement `x | x = y | y = 1` yields 1.

---

## Examples

### Example 1

Calls to `evalAt` and corresponding statements using the operator `|` are equivalent:

```
evalAt(x^2 + sin(x), x = 1);  
x^2 + sin(x) | x = 1
```

```
sin(1) + 1
```

```
sin(1) + 1
```

We use the operator `|` to evaluate an expression  $f$  representing a function of  $x$  at several points:

```
f := x + exp(x):  
f | x = 3;  
f | x = 5.0;  
f | x = y;
```

$$e^3 + 3$$

$$153.4131591$$

$$y + e^y$$

We create a matrix with symbolic entries and evaluate the matrix with various values for the symbols:

```
A := matrix([[x, sin(PI*x)], [2, y]]);
A | x = a;
A | [x = a, y = b]
```

$$\begin{pmatrix} x & \sin(\pi x) \\ 2 & y \end{pmatrix}$$

$$\begin{pmatrix} a & \sin(\pi a) \\ 2 & y \end{pmatrix}$$

$$\begin{pmatrix} a & \sin(\pi a) \\ 2 & b \end{pmatrix}$$

```
delete f, A;
```

## Example 2

We do several substitutions simultaneously:

```
f := cos(y) + sin(x) + x*y;
f | (x = 1, y = 2);
f | [x = 1, y = 2];
f | {x = 1, y = 2};
```

$$\cos(y) + \sin(x) + x y$$

$\cos(2) + \sin(1) + 2$

$\cos(2) + \sin(1) + 2$

$\cos(2) + \sin(1) + 2$

delete f:

## Parameters

**f**

An arbitrary MuPAD object.

**x, x<sub>1</sub>, x<sub>2</sub>, ...**

indeterminates on page 7-29 or indexed indeterminates on page 1-1017.

**v, v<sub>1</sub>, v<sub>2</sub>, ...**

The values for x, x<sub>1</sub>, x<sub>2</sub>, ...

## Return Values

Copy of the input object f with replaced operands.

## Overloaded By

f



## See Also

### MuPAD Functions

evalp | subs | subsex | subsop

## evalp

Evaluate a polynomial at a point

### Syntax

```
evalp(p, x = v, ...)
```

```
evalp(p, [x = v, ...])
```

```
evalp(f, <vars>, x = v, ...)
```

```
evalp(f, <vars>, [x = v, ...])
```

### Description

`evalp(p, x = v)` evaluates the polynomial `p` in the variable `x` at the point `v`.

An error occurs if `x` is not an indeterminate of `p`. The value `v` may be any object that could also be used as coefficient. The result is an element of the coefficient ring of `p` if `p` is univariate. If `p` is multivariate, the result is a polynomial in the remaining variables.

If several evaluation points are given, the evaluations take place in succession from left to right. Each evaluation follows the rules above.

For a polynomial `p` in the variables `x1, x2, ...`, the syntax `p(v1, v2, ...)` can be used instead of `evalp(p, x1 = v1, x2 = v2, ...)`.

`evalp(f, vars, x = v, ...)` first converts the polynomial expression `f` to a polynomial with the variables given by `vars`. If no variables are given, they are searched for in `f`. See `poly` about details of the conversion. `FAIL` is returned if `f` cannot be converted to a polynomial. A successfully converted polynomial is evaluated as above. The result is converted to an expression.

Horner's rule is used to evaluate the polynomial. The evaluation of variables at the point `0` is most efficient and should take place first. After that, the remaining main variable should be evaluated first.

The result of `evalp` is not evaluated further. One may use `eval` to fully evaluate the result.

Instead of `evalp(p, x1 = v1, x2 = v2, ...)` one may also use the equivalent form `evalp(p, [x1 = v1, x2 = v2, ...])`.

## Examples

### Example 1

`evalp` is used to evaluate the polynomial expression  $x^2 + 2x + 3$  at the point  $x = a + 2$ . The form of the resulting expression reflects the fact that Horner's rule was used:

```
evalp(x^2 + 2*x + 3, x = a + 2)
```

```
(a + 2) (a + 4) + 3
```

### Example 2

`evalp` is used to evaluate a polynomial in the indeterminates  $x$  and  $y$  at the point  $x = 3$ . The result is a polynomial in the remaining indeterminate  $y$ :

```
p := poly(x^2 + x*y + 2, [x, y]): evalp(p, x = 3)
```

```
poly(3 y + 11, [y])
```

```
delete p:
```

### Example 3

Polynomials may be called like functions in order to evaluate all variables:

```
p := poly(x^2 + x*y, [x, y]): evalp(p, x = 3, y = 2) = p(3, 2)
```

```
15 = 15
```

```
delete p:
```

## Example 4

If not all variables are replaced by values, the result is a polynomial in the remaining variables:

```
evalp(poly(x*y*z + x^2 + y^2 + z^2, [x, y, z]), x = 1, y = 1)
```

```
poly(z^2 + z + 2, [z])
```

## Example 5

The result of `evalp` is not evaluated further. We first define a polynomial `p` with coefficient `a` and then change the value of `a`. The change is not reflected by `p`, because polynomials do not evaluate their coefficients implicitly. One must map the function `eval` onto the coefficients in order to enforce evaluation:

```
p := poly(x^2 + a*y + 1, [x,y]): a := 2:  
p, mapcoeffs(p, eval)
```

```
poly(x^2 + a y + 1, [x, y]), poly(x^2 + 2 y + 1, [x, y])
```

If we use `evalp` to evaluate `p` at the point `x = 1`, the result is not fully evaluated. One must use `eval` to get fully evaluated coefficients:

```
r := evalp(p, x = 1):  
r, mapcoeffs(r, eval)
```

```
poly(a y + 2, [y]), poly(2 y + 2, [y])
```

```
delete p, a, r:
```

## Parameters

**p**

A polynomial (Symbolic Math Toolbox) of type `DOM_POLY`

**x**

An indeterminate

**v**

The value for x: an element of the coefficient ring of the polynomial

**f**

A polynomial expression (Symbolic Math Toolbox)

**vars**

A list on page 7-41 of indeterminates of the polynomial: typically, identifiers on page 7-29 or indexed identifiers on page 1-1017

## Return Values

Element of the coefficient ring, or a polynomial, or a polynomial expression, or FAIL

## Overloaded By

f, p

## See Also

**MuPAD Functions**

eval | evalAt | poly

## exp

Exponential function

---

**Note** For the `exp` function in MATLAB®, see `exp`.

---

## Syntax

`exp(x)`

## Description

`exp(x)` represents the value of the exponential function at the point  $x$ .

The exponential function is defined for all complex arguments.

For most exact arguments, an unevaluated function call is returned subject to some simplifications:

- Calls of the form  $e^{q\pi i}$  with integer or rational  $q$  are rewritten such that  $q$  lies in the interval  $[0, 2)$ . Explicit results are returned if the denominator of  $q$  is 1, 2, 3, 4, 5, 6, 8, 10, or 12.
- Further, the following special values are implemented:  $e^0 = 1$ ,  $e^\infty = \infty$ ,  $e^{-\infty} = 0$ .
- A call of the form  $e^{c \ln(y)}$  with an unevaluated  $\ln(y)$  and a constant  $c$  (i.e., of type `Type::Constant`) yields the result  $y^c$ .
- The call  $e^{f(y)}$  yields the result  $\frac{y}{f(y)}$ , if  $f$  is `lambertW`.

Floating point results are computed, when the argument is a floating-point number.

---

**Note** Numerical exceptions may happen, when the absolute value of the real part of a floating-point argument  $x$  is large. If  $\Re(x) < -7.4 \cdot 10^8$ , then `exp(x)` may return the

truncated result  $0.0$  (protection against underflow). If  $\Re(x) > 7.4 \cdot 10^8$ , then  $\exp(x)$  may return the floating-point equivalent `RD_INF` (Symbolic Math Toolbox) of infinity. See “Example 2” on page 1-670 (Symbolic Math Toolbox).

---

For arguments of type `DOM_INTERVAL`, the return value is another interval containing the image set of the exponential function over the input interval. See “Example 4” on page 1-671 (Symbolic Math Toolbox).

The protected identifier `E` is an alias for `exp(1)`.

## Environment Interactions

When called with a floating-point argument, the function is sensitive to the environment variable `DIGITS` which determines the numerical working precision.

## Examples

### Example 1

We demonstrate some calls with exact and symbolic input data:

```
exp(1), exp(2), exp(-3), exp(1/4), exp(1 + I), exp(x^2)
```

$$e, e^2, e^{-3}, e^{\frac{1}{4}}, e^{1+i}, e^{x^2}$$

Floating point values are computed for floating-point arguments:

```
exp(1.23), exp(4.5 + 6.7*I), exp(1.0/10^20), exp(123456.7)
```

$$3.421229536, 82.31014791 + 36.44342846 i, 1.0, 3.660698702 \cdot 10^{53616}$$

Some special symbolic simplifications are implemented:

```
exp(I*PI), exp(x - 22*PI*I), exp(3 + I*PI)
```

$$-1, e^x, -e^3$$

`exp(ln(-2)), exp(ln(x)*PI), exp(lambertW(5))`

$$-2, x^\pi, \frac{5}{W_0(5)}$$

## Example 2

The truncated result `0.0` may be returned for floating-point arguments with negative real parts. This prevents numerical underflow:

`exp(-742261118.6)`

$$1.14996558 \cdot 10^{-322359908}$$

`exp(-744261118.7)`

$$0.0$$

`exp(-742261118.6 + 10.0^10*I), exp(-744261118.7 + 10.0^10*I)`

$$1.004057513 \cdot 10^{-322359908} - 5.606151488 \cdot 10^{-322359909} i, 0.0$$

When internal numerical overflow occurs, the floating-point equivalent `RD_INF` (Symbolic Math Toolbox) of infinity is returned:

`exp(744261117.2)`

$$1.972919601 \cdot 10^{323228496}$$

`exp(744261117.3)`

$$\text{RD\_INF}$$



### Example 3

System functions such as `limit`, `series`, `expand`, `combine` etc. handle expressions involving `exp`:

```
limit(x*exp(-x), x = infinity), series(exp(x/(x + 1)), x = 0)
```

$$0, 1 + x - \frac{x^2}{2} + \frac{x^3}{6} + \frac{x^4}{24} - \frac{19x^5}{120} + O(x^6)$$

```
expand(exp(x + y + (sqrt(2) + 5)*PI*I))
```

$$-e^{\pi\sqrt{2}i} e^x e^y$$

```
combine(%, exp)
```

$$-e^{x+y+\pi\sqrt{2}i}$$

### Example 4

`exp` transforms intervals (of type `DOM_INTERVAL`) to intervals:

```
exp(-1 ... 1)
```

0.3678794411 ... 2.718281829

Note that the MuPAD floating-point numbers cannot be arbitrarily large. In the context of floating-point intervals, all values larger than a machine-dependent constant are regarded as “infinite”:

```
exp(1 ... 1e1000)
```

2.718281828 ... RD\_INF

Finally, we would like to mention that you can also use `exp` on disjunct unions of intervals:

`exp((1 ... PI) union (10 ... 20))`

`2.718281828 ... 23.14069264 ∪ 22026.46579 ... 485165195.5`

## Parameters

**x**

An arithmetical expression (Symbolic Math Toolbox) or a floating-point interval on page 7-33

## Return Values

Arithmetical expression or a floating-point interval

## Overloaded By

**x**

## See Also

### **MuPAD Functions**

`ln` | `log`

# expand

Expand an expression

## Syntax

```
expand(f, options)
```

```
expand(f, g1, g2, ..., options)
```

## Description

`expand(f)` expands the arithmetical expression `f`.

The most important use of `expand` is the application of the distributivity law to rewrite products of sums as sums of products. In this respect, `expand` is the inverse function of `factor`.

The numerator of a fraction is expanded, and then the fraction is rewritten as a sum of fractions with simpler numerators; see “Example 1” on page 1-674 (Symbolic Math Toolbox). In a certain sense, this is the inverse functionality of `normal`. Use `partfrac` for a more powerful way to rewrite a fraction as a sum of simpler fractions.

`expand(f)` applies the following rules when rewriting powers occurring as subexpressions in `f`:

- $x^{a+b} = x^a x^b$ .
- If `b` is an integer, or  $x \geq 0$  or  $y \geq 0$ , then  $(x y)^b = x^b y^b$ .
- If `b` is an integer, then  $(x^a)^b = x^{a b}$ .

Except for the third rule, this behavior of `expand` is the inverse functionality of `combine`. See “Example 2” on page 1-675 (Symbolic Math Toolbox).

`expand` works recursively on the subexpressions of an expression `f`. If `f` is of the container type `array` or `table`, `expand` only returns `f` and does not map on the entries. To expand all entries of one of the containers, use `map`. See “Example 3” on page 1-675 (Symbolic Math Toolbox).

If optional arguments `g1`, `g2`, ... are present, then any subexpression of `f` that is equal to one of these additional arguments is not expanded; see “Example 4” on page 1-676 (Symbolic Math Toolbox). See section “Background” for a description how this works.

Properties (Symbolic Math Toolbox) of identifiers are taken into account (see `assume`). Identifiers without any properties are assumed to be complex. See “Example 9” on page 1-679 (Symbolic Math Toolbox).

`expand` also handles various types of special mathematical functions. It rewrites a single call of a special function with a complicated argument as a sum or a product of several calls of the same function or related functions with simpler arguments. In this respect, `expand` is the inverse function of `combine`.

In particular, `expand` implements the functional equations of the exponential function on page 1-428 (Symbolic Math Toolbox) and the logarithm on page 1-429 (Symbolic Math Toolbox), the gamma function on page 1-429 (Symbolic Math Toolbox) and the polygamma function on page 1-1687, and the addition theorems for the trigonometric functions on page 1-688 (Symbolic Math Toolbox) and the hyperbolic functions on page 1-1945. See “Example 10” on page 1-680 (Symbolic Math Toolbox).

## Environment Interactions

`expand` is sensitive to properties (Symbolic Math Toolbox) of identifiers set via `assume`.

## Examples

### Example 1

`expand` expands products of sums by multiplying out:

```
expand((x + 1)*(y + z)^2)
```

$$2yz + xy^2 + xz^2 + y^2 + z^2 + 2xyz$$

After expansion of the numerator, a fraction is rewritten as a sum of fractions:

```
expand((x + 1)^2*y/(y + z)^2)
```

$$\frac{y}{y^2 + 2 y z + z^2} + \frac{2 x y}{y^2 + 2 y z + z^2} + \frac{x^2 y}{y^2 + 2 y z + z^2}$$

## Example 2

A power with a sum in the exponent is rewritten as a product of powers:

```
expand(x^(y + z + 2))
```

$$x^y x^z x^2$$

## Example 3

expand works in a recursive fashion. In the following example, the power  $(x + y)^{z+2}$  is first expanded into a product of two powers. Then the power  $(x + y)^2$  is expanded into a sum. Finally, the product of the latter sum and the remaining power  $(x + y)^z$  is multiplied out:

```
expand((x + y)^(z + 2))
```

$$x^2 (x + y)^z + y^2 (x + y)^z + 2 x y (x + y)^z$$

Here is another example:

```
expand(2^((x + y)^2))
```

$$2^{x^2} 2^{y^2} 2^{2 x y}$$

expand maps on the entries of lists, sets, and matrices:

```
expand([(a + b)^2, (a - b)^2]);
expand({(a + b)^2, (a - b)^2});
expand(matrix([(a + b)^2, 0],[0, (a - b)^2]))
```

$$[a^2 + 2 a b + b^2, a^2 - 2 a b + b^2]$$

$$\{a^2 - 2ab + b^2, a^2 + 2ab + b^2\}$$

$$\begin{pmatrix} a^2 + 2ab + b^2 & 0 \\ 0 & a^2 - 2ab + b^2 \end{pmatrix}$$

expand does not map on the entries of tables or arrays:

```
expand(table((a + b)^2=(c + 1)^2),
expand(array(1..1, [(a + b)^2])))
```

$$\frac{(a+b)^2}{(c+1)^2}, (a+b)^2$$

Use map in order to expand all entries of a container:

```
map(table((a + b)^2=(c + 1)^2), expand),
map(array(1..1, [(a + b)^2]), expand)
```

$$\frac{(a+b)^2}{2c+c^2+1}, (a^2+2ab+b^2)$$

Note that this call expands only the *entries* in a table, not the keys. In the (rare) case that you want the keys expanded as well, transform the table to a list or set of equations first:

```
T := table((a + b)^2=(c + 1)^2):
table(expand([op(T)]))
```

$$\frac{2ab+a^2+b^2}{2c+c^2+1}$$

## Example 4

If additional arguments are provided, expand performs only a partial expansion. These additional expressions, such as  $x + 1$  in the following example, are not expanded:

```
expand((x + 1)*(y + z))
```

$$y + z + x y + x z$$

```
expand((x + 1)*(y + z), x + 1)
```

$$y(x + 1) + z(x + 1)$$

## Example 5

By default, `expand` works on all subexpressions including trigonometric subexpressions:

```
e := (sin(2*x) + 1)*(1 - cos(2*x)):
expand(e)
```

$$-4 \sin(x) \cos(x)^3 - 2 \cos(x)^2 + 4 \sin(x) \cos(x) + 2$$

To prevent expansion of subexpressions, use the `ArithmeticOnly` option:

```
expand(e, ArithmeticOnly)
```

$$\sin(2 x) - \cos(2 x) - \cos(2 x) \sin(2 x) + 1$$

The option does not prevent expansion of powers and roots:

```
expand((sin(2*x) + 1)^3, ArithmeticOnly)
```

$$\sin(2 x)^3 + 3 \sin(2 x)^2 + 3 \sin(2 x) + 1$$

To keep subexpressions with integer powers unexpanded, use the `MaxExponent` option.

## Example 6

The `IgnoreAnalyticConstraints` option applies a set of purely algebraic simplifications including the equality of sum of logarithms and a logarithm of a product. Using the `IgnoreAnalyticConstraints` option, you get a simpler result, but one that might be incorrect for some of the values of variables:

```
expand(ln(a*b*c*d), IgnoreAnalyticConstraints)
```

$$\ln(a) + \ln(b) + \ln(c) + \ln(d)$$

Without using this option, you get a mathematically correct result:

```
expand(ln(a*b*c*d))
```

$$\ln(a b c d)$$

### Example 7

If the additional `MaxExponent` provided, `expand` performs only a partial expansion. Powers with an integer exponent larger than the given bound, are not expanded:

```
expand((a + b)^3, MaxExponent = 2)
```

$$(a + b)^3$$

If the exponent is smaller or equal the given bound, the power is expanded:

```
expand((a + b)^2, MaxExponent = 2)
```

$$a^2 + 2 a b + b^2$$

### Example 8

The `expand` function can accept several options simultaneously. Suppose you want to expand the following expression:

```
e := (sin(2*x) + 1)*(x + 1)^3
```

$$(\sin(2 x) + 1) (x + 1)^3$$

`expand` without any options works recursively. The function expands all subexpressions including trigonometric functions and powers:



```
expand(e)
```

$$3x + 2 \cos(x) \sin(x) + 3x^2 + x^3 + 6x \cos(x) \sin(x) + 6x^2 \cos(x) \sin(x) + 2x^3 \cos(x) \sin(x) + 1$$

The `ArithmeticOnly` option prevents the expansion of the term  $\sin(2x)$ . The `MaxExponent` option prevents the expansion of  $(x + 1)^3$ :

```
expand(e, ArithmeticOnly);
expand(e, MaxExponent = 2)
```

$$3x + \sin(2x) + 3x \sin(2x) + 3x^2 \sin(2x) + x^3 \sin(2x) + 3x^2 + x^3 + 1$$

$$(x + 1)^3 + 2 \cos(x) \sin(x) (x + 1)^3$$

Combining these options in one call of the `expand` function, you apply both restrictions for the expansion:

```
expand(e, MaxExponent = 2, ArithmeticOnly)
```

$$(x + 1)^3 + \sin(2x) (x + 1)^3$$

## Example 9

The following expansions are not valid for all values  $a$ ,  $b$  from the complex plane. Therefore, MuPAD does not expand these expressions:

```
expand(ln(a^2)), expand(ln(a*b)), expand((a*b)^n)
```

$$\ln(a^2), \ln(ab), (ab)^n$$

The expansions are valid under the assumption that  $a$  is a positive real number:

```
assume(a > 0): expand(ln(a^2)), expand(ln(a*b)), expand((a*b)^n)
```

$$2 \ln(a), \ln(a) + \ln(b), a^n b^n$$

Clear the assumption for further computations:

```
unassume(a):
```

Alternatively, to get the expanded result for the third expression, assume that n is an integer:

```
expand((a*b)^n) assuming n in Z_
```

$$a^n b^n$$

Use the `IgnoreAnalyticConstraints` option to expand these expressions without explicitly specified assumptions:

```
expand(ln(a^2), IgnoreAnalyticConstraints),  
expand(ln(a*b), IgnoreAnalyticConstraints),  
expand((a*b)^n, IgnoreAnalyticConstraints)
```

$$2 \ln(a), \ln(a) + \ln(b), a^n b^n$$

## Example 10

The addition theorems of trigonometry are implemented by "expand"-slots of the trigonometric functions on page 1-688 (Symbolic Math Toolbox) `sin` and `cos`:

```
expand(sin(a + b)), expand(sin(2*a))
```

$$\cos(a) \sin(b) + \cos(b) \sin(a), 2 \cos(a) \sin(a)$$

The same is true for the hyperbolic functions on page 1-1945 `sinh` and `cosh`:

```
expand(cosh(a + b)), expand(cosh(2*a))
```

$$\sinh(a) \sinh(b) + \cosh(a) \cosh(b), 2 \cosh(a)^2 - 1$$

The exponential function on page 1-428 (Symbolic Math Toolbox) with a sum as argument is expanded via `exp(: : expand)`:

```
expand(exp(a + b))
```

$$e^a e^b$$

Here are some more expansion examples for the functions `sum`, `fact`, `abs`, `coth`, `sign`, `binomial`, `beta`, `gamma`, `cot`, `tan`, `exp` and `psi`:

```
sum(f(x) + g(x),x); expand(%)
```

$$\sum_x (f(x) + g(x))$$

$$\left(\sum_x f(x)\right) + \left(\sum_x g(x)\right)$$

```
fact(x + 1); expand(%)
```

$$(x+1)!$$

$$x! (x+1)$$

```
abs(a*b); expand(%)
```

$$|a b|$$

$$|a| |b|$$

```
coth(a + b); expand(%)
```

$$\coth(a + b)$$

$$\frac{\coth(a) \coth(b) + 1}{\coth(a) + \coth(b)}$$

`coth(a*b); expand(%)`

$$\coth(a b)$$

$$\coth(a b)$$

`sign(a*b); expand(%)`

$$\text{sign}(a b)$$

$$\text{sign}(a) \text{sign}(b)$$

`binomial(n, m); expand(%)`

$$\binom{n}{m}$$

$$-\frac{n \Gamma(n)}{m^2 \Gamma(n-m) \Gamma(m) - m n \Gamma(n-m) \Gamma(m)}$$

`beta(n, m); expand(%)`

$$\beta(m, n)$$

$$\frac{\Gamma(m) \Gamma(n)}{\Gamma(m+n)}$$

`gamma(x + 1); expand(%)`

$$\Gamma(x+1)$$

$$x \Gamma(x)$$

`tan(a + b); expand(%)`

$$\tan(a+b)$$

$$\frac{\tan(a) + \tan(b)}{\tan(a) \tan(b) - 1}$$

`cot(a + b); expand(%)`

$$\cot(a+b)$$

$$\frac{\cot(a) \cot(b) - 1}{\cot(a) + \cot(b)}$$

`exp(x + y); expand(%)`

$$e^{x+y}$$

$$e^x e^y$$

`psi(x + 2); expand(%)`

$$\psi(x+2)$$

$$\psi(x) + \frac{1}{x+1} + \frac{1}{x}$$

In contrast to previous versions of MuPAD, `expand` does not rewrite `tan` in terms of `sin` and `cos`:

```
expand(tan(a))
```

```
tan(a)
```

## Example 11

This example illustrates how to extend the functionality of `expand` to user-defined mathematical functions. As an example, we consider the sine function. (Of course, the system function `sin` already has an "expand" slot; see "Example 10" on page 1-680 (Symbolic Math Toolbox).)

We first embed our function into a function environment, which we call `Sin`, in order not to overwrite the system function `sin`. Then we implement the addition theorem  $\sin(x + y) = \sin(x)\cos(y) + \sin(y)\cos(x)$  in the "expand" slot of the function environment, i.e., the slot routine `Sin::expand`:

```
Sin := funcenv(Sin):
Sin::expand := proc(u) // compute expand(Sin(u))
    local x, y;
begin
    // recursively expand the argument u
    u := expand(op(u));

    if type(u) = "_plus" then // u is a sum
        x := op(u, 1); // the first term
        y := u - x;    // the remaining terms

        // apply the addition theorem and
        // expand the result again
        expand(Sin(x)*cos(y) + cos(x)*Sin(y))
    else
        Sin(u)
    end_if
end_proc:
```

Now, if `expand` encounters a subexpression of the form `Sin(u)`, it calls `Sin::expand(u)` to expand `Sin(u)`. The following command first expands the argument `a*(b+c)` via the recursive call in `Sin::expand`, then applies the addition theorem, and finally `expand` itself expands the product of the result with `z`:

```
expand(z*sin(a*(b + c)))
```

$$z \sin(a b) \cos(a c) + z \sin(a c) \cos(a b)$$

The expansion after the application of the addition theorem in `Sin::expand` is necessary to handle the case when `u` is a sum with more than two terms: then `y` is again a sum, and `cos(y)` and `Sin(y)` are expanded recursively:

```
expand(sin(a + b + c))
```

$$\sin(a) \cos(b) \cos(c) + \sin(b) \cos(a) \cos(c) + \sin(c) \cos(a) \cos(b) - \sin(a) \sin(b) \sin(c)$$

## Parameters

`f`, `g1`, `g2`, ...

arithmetical expressions (Symbolic Math Toolbox)

## Options

### `ArithmeticOnly`

Expand arithmetic part of an expression without expanding trigonometric, hyperbolic, logarithmic and special functions.

This option does not prevent expansion of powers and roots. Technically, the option omits overloading the `expand` function for each term of the original expression. See “Example 5” on page 1-677 (Symbolic Math Toolbox).

### `IgnoreAnalyticConstraints`

With this option `expand` applies the following rules when expanding expressions:

- $\ln(a) + \ln(b) = \ln(ab)$  for all values of  $a$  and  $b$ . In particular:

$$(a b)^c = e^{c \ln(a b)} = e^{c (\ln(a) + \ln(b))} = a^c b^c \text{ for all values of } a, b, \text{ and } c$$

- $\ln(a^b) = b \ln(a)$  for all values of  $a$  and  $b$ . In particular:

$$(a^b)^c = e^{b c \ln(a)} = e^{\ln(a)^{b c}} = a^{b c} \text{ for all values of } a, b, \text{ and } c$$

- If  $f$  and  $g$  are standard mathematical functions and  $f(g(x)) = x$  for all small positive numbers,  $f(g(x)) = x$  is assumed to be valid for all complex  $x$ . In Particular:

- $\ln(e^x) = x$
- $\arcsin(\sin(x)) = x$ ,  $\arccos(\cos(x)) = x$ ,  $\arctan(\tan(x)) = x$
- $\operatorname{arcsinh}(\sinh(x)) = x$ ,  $\operatorname{arccosh}(\cosh(x)) = x$ ,  $\operatorname{arctanh}(\tanh(x)) = x$
- $W_k(x e^x) = x$  for all values of  $k$

Using the option can give you simpler results for the expressions for which the default call to `expand` returns complicated results. With this option the function does not guarantee the equality of the initial expression and the result for all symbolic parameters. See “Example 6” on page 1-677 (Symbolic Math Toolbox).

### **MaxExponent**

Option, specified as `MaxExponent = n`

Do not expand powers with integer exponents larger than  $n$ .

If you call `expand` with this option, the function expands does not expand powers with integer exponents larger than  $n$ . See “Example 7” on page 1-678 (Symbolic Math Toolbox).

## **Return Values**

arithmetical expression (Symbolic Math Toolbox).

## **Overloaded By**

f



## Algorithms

With optional arguments  $g_1, g_2, \dots$ , the expansion of certain subexpressions of  $f$  can be prevented. This works as follows: every occurrence of  $g_1, g_2, \dots$  in  $f$  is replaced by an auxiliary variable before the expansion, and afterwards the auxiliary variables are replaced by the original subexpressions.

Users can extend the functionality of `expand` to their own special mathematical functions via overloading (Symbolic Math Toolbox). To this end, embed your function into a function environment on page 7-25 `g` and implement the behavior of `expand` for this function in the "expand" slot of the function environment.

Whenever `expand` encounters a subexpression of the form  $g(u, \dots)$ , it issues the call `g::expand(g(u, \dots))` to the slot routine to expand the subexpression, passing the not yet expanded arguments  $g(u, \dots)$  as arguments. The result of this call is not expanded any further by `expand`. See "Example 11" on page 1-684 (Symbolic Math Toolbox) above.

Similarly, an "expand" slot can be defined for a user-defined library domain (Symbolic Math Toolbox)  $T$ . Whenever `expand` encounters a subexpression  $d$  of domain type (Symbolic Math Toolbox)  $T$ , it issues the call `T::expand(d)` to the slot routine to expand  $d$ . The result of this call is not expanded any further by `expand`. If  $T$  has no "expand" slot, then  $d$  remains unchanged.

## See Also

### MuPAD Functions

`collect` | `combine` | `denom` | `factor` | `normal` | `numer` | `partfrac` | `rationalize` | `rectform` | `rewrite` | `simplify`

### Topics

"Manipulate Expressions" (Symbolic Math Toolbox)

"Choose Simplification Functions" (Symbolic Math Toolbox)

## expose

Display the source code of a procedure or the entries of a domain

### Syntax

`expose(f)`

### Description

`expose(f)` displays the source code of the MuPAD procedure `f` or the entries of the domain `f`.

Usually, procedures on page 7-45 and domains (Symbolic Math Toolbox) are printed in abbreviated form. `expose` serves to display the complete source code of a procedure and all entries of a domain, respectively. However, you cannot use `expose` to look at the source code of kernel functions.

If `f` is a domain (Symbolic Math Toolbox), then `expose` returns a symbolic `newDomain` call. The arguments of the call are equations of the form `index = value`, where `value` equals the value of `f::index`. `expose` is not recursively applied to `f::index`; hence, the source code of domain methods is not displayed.

Although `expose` returns a syntactically valid MuPAD object, this return value is intended for screen output only, and further processing of it is deprecated.

### Examples

#### Example 1

Using `expose`, you can inspect the source code of procedures of the MuPAD library:

```
sin
```

```
sin
```

```

expose(%)

proc(x)  name sin;  local f, y;  option
noDebug; begin  if args(0) = 0 then  error("no arguments given")
  else  ... end_proc

```

## Example 2

When applied to a domain, `expose` shows the entries of that domain:

```

expose(DOM_NULL)

domain DOM_NULL
  new := proc new() ... end;
  new_extelement := proc new_extelement(d) ... end;
  Content := proc DOM_NULL::Content(Out, x) ... end;
end_domain

```

## Example 3

Applying `expose` to other objects is legal but generally useless:

```

expose(3)

3

```

## Parameters

**f**

Any object; typically, a procedure on page 7-45, a function environment on page 7-25, or a domain (Symbolic Math Toolbox)

## Overloaded By

f

## Algorithms

In addition to the usual overloading (Symbolic Math Toolbox) mechanism for domain elements, a domain method overloading `expose` must handle the following case: it will be called with zero arguments when the domain itself is to be exposed.

If `f` is a procedure on page 7-45, then `expose` returns an object of the domain (Symbolic Math Toolbox) `stdlib::Exposed`. The only purpose of this domain is its "print" on page 1-1636 method; manipulating its elements should never be necessary. Therefore it remains undocumented.

## See Also

### MuPAD Functions

`print`

## expr

Convert into an element of a basic domain

### Syntax

`expr(object)`

### Description

`expr(object)` converts `object` into an element of a basic domain, such that all sub-objects are elements of basic domains as well.

`expr` is a type conversion function, for converting an element of a more complex library domain (Symbolic Math Toolbox), such as a polynomial or a matrix on page 7-252, into an element of a basic kernel domain.

`expr` proceeds recursively, such that all sub-objects of the returned object are elements of basic domains, or infinities, or undefined. See “Example 1” on page 1-692 (Symbolic Math Toolbox) and “Example 2” on page 1-692 (Symbolic Math Toolbox).

The two special objects `infinity` and `complexInfinity` are translated into identifiers with the same name by `expr`. Evaluating these identifiers yields the original objects. See “Example 1” on page 1-692 (Symbolic Math Toolbox).

If `object` already belongs to a basic domain (Symbolic Math Toolbox) other than `DOM_POLY`, then `expr` is only applied recursively to the operands of `object`, if any.

If `object` is a polynomial of domain type (Symbolic Math Toolbox)`DOM_POLY`, then `expr` is applied recursively to the coefficients of `object`, and afterwards the result is converted into an identifier on page 7-29, a number (Symbolic Math Toolbox), or an expression on page 7-20. See “Example 1” on page 1-692 (Symbolic Math Toolbox).

If `object` belongs to a library domain (Symbolic Math Toolbox) `T` with an “`expr`” slot, then the corresponding slot routine `T::expr` is called with `object` as argument, and the result is returned.

This can be used to extend the functionality of `expr` to elements of user-defined domains. If the slot routine is unable to perform the conversion, it must return `FAIL`. See “Example 6” on page 1-695 (Symbolic Math Toolbox).

If the domain `T` does not have an “`expr`” slot, then `expr` returns `FAIL`.

The result of `expr` is not evaluated further. Use `eval` to evaluate it. See “Example 4” on page 1-694 (Symbolic Math Toolbox).

## Examples

### Example 1

`expr` converts a polynomial into an expression, an identifier, or a number:

```
expr(poly(x^2 + y, [x])), expr(poly(x)), expr(poly(2, [x]));  
map(%, domtype)
```

$x^2 + y$ ,  $x$ ,  $2$

`DOM_EXPR`, `DOM_IDENT`, `DOM_INT`

`expr` also works with the objects `infinity`, `complexInfinity`, and `undefined`:

```
expr(infinity), expr(complexInfinity), expr(undefined);  
map(%, domtype)
```

$\infty$ , `complexInfinity`, `undefined`

`stdlib::Infinity`, `stdlib::CInfinity`, `stdlib::Undefined`

### Example 2

This example shows that `expr` works recursively on expressions. All subexpressions which are domain elements are converted into expressions. The construction with `hold(_plus)(..)` is necessary since `x + i(1)` would evaluate to `FAIL`:

```
i := Dom::IntegerMod(7);
hold(_plus)(x, i(1)); expr(%)
```

$$x + (1 \bmod 7)$$

$$x + 1$$

### Example 3

The function `series` returns an element of the domain `Series::Puisseux`, which is not a basic domain:

```
s := series(sin(x), x);
domtype(s)
```

$$x - \frac{x^3}{6} + \frac{x^5}{120} + O(x^7)$$

`Series::Puisseux`

Use `expr` to convert the result into an element of domain type `DOM_EXPR`:

```
e := expr(s); domtype(e)
```

$$\frac{x^5}{120} - \frac{x^3}{6} + x$$

`DOM_EXPR`

Note that the information about the order term is lost after the conversion.

### Example 4

`expr` does not evaluate its result. In this example the polynomial `p` has a parameter `a` and the global variable `a` has a value. `expr` applied on the polynomial `p` returns an expression containing `a`. If you want to insert the value of `a` use the function `eval`:

```
p := poly(a*x, [x]); a := 2; expr(p); eval(%)
```

$ax$

$2x$

### Example 5

`A` is an element of type `Dom::Matrix(Dom::Integer)`:

```
A := Dom::Matrix(Dom::Integer)([[1, 2], [3, 2]]);  
domtype(A)
```

$\begin{pmatrix} 1 & 2 \\ 3 & 2 \end{pmatrix}$

`Dom::Matrix(Dom::Integer)`

In this case, `expr` converts `A` into an element of type `DOM_ARRAY`:

```
a := expr(A); domtype(a)
```

$\begin{pmatrix} 1 & 2 \\ 3 & 2 \end{pmatrix}$

`DOM_ARRAY`

However, it is not guaranteed that the result is of type `DOM_ARRAY` in future versions of MuPAD as well. For example, the internal representation of matrices might change in the future. Use `coerce` to request the conversion into a particular data type:



```
coerce(A, DOM_ARRAY)
```

$$\begin{pmatrix} 1 & 2 \\ 3 & 2 \end{pmatrix}$$

A nested list is an alternative representation for a matrix:

```
coerce(A, DOM_LIST)
```

```
[[1, 2], [3, 2]]
```

## Example 6

If a sub-object belongs to a domain (Symbolic Math Toolbox) without an "expr" slot, then expr returns FAIL:

```
T := newDomain("T");
d := new(T, 1, 2);
expr(d)
```

```
new(T, 1, 2)
```

```
FAIL
```

You can extend the functionality of expr to your own domains. We demonstrate this for the domain T by implementing an "expr" slot, which returns a list with the internal operands of its argument:

```
T::expr := x -> [extop(x)]:
```

If now expr encounters a sub-object of type T during the recursive process, it calls the slot routine T::expr with the sub-object as argument:

```
expr(d), expr([d, 3])
```

```
[1, 2], [[1, 2], 3]
```

## **Parameters**

**object**

An arbitrary object

## **Return Values**

Element of a basic domain (Symbolic Math Toolbox).

## **Overloaded By**

object

## **See Also**

### **MuPAD Functions**

coerce | domtype | eval | testtype | type

# expr2text

Convert objects into character strings

## Syntax

```
expr2text(object)
```

## Description

`expr2text(object)` converts `object` into a character string on page 7-53. The result usually corresponds to the screen output of `object` when `PRETTYPRINT` is set to `FALSE`.

If the function is called without arguments, then an empty character string is created. If more than one argument is given, the arguments are interpreted as an expression sequence on page 1-88 and are converted into a single character string.

Like most other MuPAD function, `expr2text` evaluates its arguments before the conversion.

If strings on page 7-53 occur in `object`, they will be quoted in the result.

## Examples

### Example 1

Expressions on page 7-20 are converted into character strings:

```
expr2text(a + b)
```

```
"a + b"
```

`expr2text` quotes strings on page 7-53. Note that the quotation marks are preceded by a backslash when they are printed on the screen:

```
expr2text(["text", 2])
```

```
"["text", 2]"
```

## Example 2

If more than one argument is given, the arguments are treated as a single expression sequence:

```
expr2text(a, b, c)
```

```
"a, b, c"
```

If no argument is given, an empty string is generated:

```
expr2text()
```

```
""
```

## Example 3

`expr2text` evaluates its arguments:

```
a := b: c := d: expr2text(a, c)
```

```
"b, d"
```

Use `hold` to prevent evaluation:

```
expr2text(hold(a, c));  
delete a, c:
```

```
"a, c"
```

Here is another example:

```
expr2text((a := b; c := d));
delete a, c;
```

```
"d"
```

```
e := expr2text(hold((a := b; c := d)))
```

```
"(a := b; c := d)"
```

The last string contains a newline character “\n”. Use `print` with option `Unquoted` to expand this into a new line:

```
print(Unquoted, e):
```

```
(a := b;
c := d)
```

## Example 4

`expr2text` is overloadable. It uses a default output for elements of a domain (Symbolic Math Toolbox) if the domain has neither a `"print"` slot on page 1-1980 nor an `"expr2text"` slot on page 1-1980:

```
T := newDomain("T"): e := new(T, 1):
e;
print(e):
expr2text(e)
```

```
new(T, 1)
```

```
new(T, 1)
```

```
"new(T, 1)"
```

If a `"print"` slot exists, it will be called by `expr2text` to generate the output:

```
T::print := proc(x) begin
  _concat("foo: ", expr2text(extop(x)))
end_proc:
e;
print(e):
expr2text(e)
```

foo: 1

foo: 1

"foo: 1"

If you want `expr2text` to generate an output differing from the usual output generated by `print`, you can supply an "expr2text" method:

```
T::expr2text := proc(x) begin
  _concat("bar: ", expr2text(extop(x)))
end_proc:
e;
print(e):
expr2text(e)
```

foo: 1

foo: 1

"bar: 1"

## Parameters

### object

Any MuPAD object

## Return Values

string.

## Overloaded By

object

## Algorithms

When processing a domain element  $e$ , `expr2text` first tries to call the "expr2text" method of the corresponding domain  $T$ . If it exists,  $T::\text{expr2text}(e)$  is called and the result is returned. If no "expr2text" method exists, `expr2text` tries to call the "print" method in the same way. If no "print" method exists either, `expr2text` will generate a default output. Cf. "Example 4" on page 1-699 (Symbolic Math Toolbox).

An "expr2text" method or a "print" method may return an arbitrary MuPAD object, which will be processed recursively by `expr2text`.

---

**Note** The returned object must not contain the domain element  $e$  as a sub-object. Otherwise, the MuPAD kernel runs into infinite recursion and emits an error message.

---

For expressions on page 7-20, the result returned by `expr2text` always coincides with the output produced by `print`. If the 0th operand of the expression is a function environment on page 7-25, the result of `expr2text` is computed by the second operand of the function environment.

## See Also

### MuPAD Functions

`coerce` | `fprint` | `int2text` | `print` | `tbl2text` | `text2expr` | `text2int` | `text2list` | `text2tbl`

## extnops

Number of operands of the internal representation a domain element

### Syntax

```
extnops(object)
```

### Description

`extnops(object)` returns the number of operands of the object's internal representation.

For objects of a basic data type such as expressions on page 7-20, sets on page 7-50, lists on page 7-41, tables on page 1-2103, arrays on page 7-2, hfarrays on page 7-27 etc., `extnops` yields the same result as the function `nops`. The only difference to the function `nops` is that `extnops` cannot be overloaded by domains implemented in the MuPAD language.

Internally, a domain element may consist of an arbitrary number of data objects; `extnops` returns the actual number of *internal* operands. Since every domain should provide interface methods, `extnops` should only be used from inside these methods. "From the outside", the function `nops` should be used.

### Examples

#### Example 1

`extnops` returns the number of entries of a domain element:

```
d := newDomain("demo"): e := new(d, 1, 2, 3, 4): extnops(e)
```

```
4
```

```
delete d, e:
```



## Example 2

For kernel domains, `extnops` is equivalent to `nops`:

```
extnops([1, 2, 3, 4]), nops([1, 2, 3, 4])
```

```
4, 4
```

## Example 3

We define a domain of lists. Its internal representation is a single object (a list of kernel type `DOM_LIST`):

```
myList := newDomain("lists"):
myList::new := proc(l : DOM_LIST) begin new(myList, l) end_proc:
```

We want the functionality of `nops` for this domain to be the same as for the kernel type `DOM_LIST`. To achieve this, we overload the function `nops`. The internal list is accessed via `extop(l, 1)`:

```
myList::nops := l -> nops(extop(l, 1)):
```

We create an element of this domain:

```
mylist := myList([1, 2, 3])
```

```
new(lists, [1, 2, 3])
```

Since `nops` was overloaded, `extnops` provides the only way of determining the number of operands of the internal representation of `mylist`. In contrast to `nops`, `extnops` always returns 1, because the internal representation consists of exactly one list:

```
nops(mylist), extnops(mylist)
```

```
3, 1
```

```
delete myList, mylist:
```

## **Parameters**

### **object**

An arbitrary MuPAD object

## **Return Values**

Nonnegative integer.

## **See Also**

### **MuPAD Domains**

DOM\_DOMAIN

### **MuPAD Functions**

extop | extsubsop | new | nops | op | subsop

# extop

Internal operands of a domain element

## Syntax

```
extop(object)
```

```
extop(object, i)
```

```
extop(object, i .. j)
```

## Description

`extop(object)` returns all operands of the domain element `object`.

`extop(object, i)` returns the *i*-th operand.

`extop(object, i .. j)` returns the *i*-th to *j*-th operand.

For objects of a basic data type such as expressions on page 7-20, sets on page 7-50, lists on page 7-41, tables on page 1-2103, arrays on page 7-2, hfarrays on page 7-2 etc., `extop` yields the same operands as the function `op`. See the corresponding documentation for details on operands. The main difference to the function `op` is that `extop` cannot be overloaded. Therefore, it guarantees direct access to the operands of the *internal representation* of elements of a library domain. Typically, `extop` is used in the implementation of the "op" method of a library domain that overloads the system's `op` function.

A domain element consists of a reference to the corresponding domain (Symbolic Math Toolbox) and a sequence of values representing its contents. The function `extop` allows access to the domain and the operands of this internal data sequence.

`extop(object)` returns a sequence on page 1-88 of all internal operands except the 0-th one. This call is equivalent to `extop(object, 1..extnops(object))`.

`extop(object, i)` returns the *i*-th internal operand. In particular, the domain of the `object` is returned by `extop(object, 0)` if `object` is an element of a library domain. If

object is an element of a kernel domain, the call `extop(object, 0)` is equivalent to `op(object, 0)`.

`extop(object, i..j)` returns the *i*-th to *j*-th internal operands of `object` as an expression sequence on page 1-88; *i* and *j* must be nonnegative integers with *i* smaller or equal to *j*. This sequence is equivalent to `extop(object, k) $k = i..j`.

`extop` returns `FAIL` if a specified operand does not exist. Cf. “Example 4” on page 1-708 (Symbolic Math Toolbox).

The operands of an expression sequence on page 1-88 are its elements. Note that such sequences are not flattened (Symbolic Math Toolbox) by `extop`.

## Examples

### Example 1

We create a new domain `d` and use the function `new` to create an element of this type. Its internal data representation is the sequence of arguments passed to `new`:

```
d := newDomain("demo"): e := new(d, 1, 2, 3): extop(e)
```

```
1, 2, 3
```

Individual operands can be selected:

```
extop(e, 2)
```

```
2
```

Ranges of operands can be selected:

```
extop(e, 1..2)
```

```
1, 2
```

The 0-th operand of a domain element is its domain:

```
extop(e, 0)
```

```
demo
```

```
delete d, e:
```

## Example 2

First, a new domain `d` is defined via `newDomain`. The "new" method serves for creating elements of this type. The internal representation of the domain is a sequence of all arguments of this "new" method:

```
d := newDomain("d"): d::new := () -> new(dom, args()):
```

The system's `op` function is overloaded by the following "op" method of this domain. It is to return the elements of a sorted copy of the internal data sequence. In the implementation of the "op" method, the function `extop` is used to access the internal data:

```
d::op := proc(x, i = null())
    local internalData;
    begin internalData := extop(x);
           op(sort([internalData]), i)
    end_proc:
```

Due to this overloading, `op` returns different operands than `extop`:

```
e := d(3, 7, 1): op(e); extop(e)
```

```
1, 3, 7
```

```
3, 7, 1
```

```
delete d, e:
```

## Example 3

For kernel data types such as sets, lists etc., `extop` always returns the same operands as `op`:

```
extop([a, b, c]) = op([a, b, c])
```

```
(a, b, c) = (a, b, c)
```

Expressions are of kernel data type `DOM_EXPR`, thus `extop(sin(x), 0)` is equivalent to `op(sin(x), 0)`:

```
domtype(sin(x)), extop(sin(x), 0) = op(sin(x), 0)
```

```
DOM_EXPR, sin = sin
```

Expression sequences on page 1-88 are not flattened (Symbolic Math Toolbox):

```
extop((1, 2, 3), 0), extop((1, 2, 3))
```

```
_exprseq, 1, 2, 3
```

## Example 4

Non-existing operands are returned as `FAIL`:

```
extop([1, 2], 4), extop([1, 2], 1..4)
```

```
FAIL, FAIL
```

## Parameters

### object

An arbitrary MuPAD object

### i, j

Nonnegative integers

## Return Values

sequence on page 1-88 of operands or the specified operand. FAIL is returned if no corresponding operand exists.

## See Also

### **MuPAD Domains**

DOM\_DOMAIN

### **MuPAD Functions**

extnops | extsubsop | new | nops | op | subsop

## extsubsop

Substitute operands of a domain element

### Syntax

```
extsubsop(d, i1 = new1, i2 = new2, ...)
```

### Description

`extsubsop(d, i = new)` returns a copy of the domain element `d` with the `i`-th operand of the internal representation replaced by `new`.

Internally, a domain element may consist of an arbitrary number of objects. `extsubsop` replaces one or more of these objects, without checking whether the substitution is meaningful.

---

**Note** The operands of elements of domains of the MuPAD library must meet certain (undocumented) conditions; use `extsubsop` only for your own domains. It is good programming style to use `extsubsop` only inside low-level domain methods.

---

`extsubsop` returns a modified copy of the object, but does not change the object itself.

The numbering of operands is the same as the one used by `extop`.

If the 0-th operand is to be replaced, the corresponding new value must be a domain of type `DOM_DOMAIN`; `extsubsop` then replaces the domain of `d` by this new domain.

When trying to replace the `i`-th operand with `i` exceeding the actual number of operands, `extsubsop` first increases the number of operands by appending as many `NIL`'s as necessary and then performs the substitution. Cf. "Example 3" on page 1-712 (Symbolic Math Toolbox).

When the `i`-th operand is replaced by an expression sequence of `k` elements, each of these elements becomes an individual operand of the result, indexed from `i` to `i+k-1`. The remaining operands of `d` are shifted to the right accordingly. This new numbering is



already in effect for the remaining substitutions in the same call to `extsubsop`. Cf. “Example 4” on page 1-712 (Symbolic Math Toolbox).

The void object `null()` becomes an operand of the result when it is substituted into an object.

After performing the substitution, `extsubsop` does not evaluate the result once more. Cf. “Example 5” on page 1-712 (Symbolic Math Toolbox).

In contrast to the function `subsop`, `extsubsop` cannot be overloaded.

Like `extop` and `extnops`, `extsubsop` can be applied to objects of a kernel domain. In this case `extsubsop` behaves like `subsop`.

## Examples

### Example 1

We create a domain element and then replace its first operand:

```
d := newDomain("1st"): e := new(d, 1, 2, 3): extsubsop(e, 1 = 5)
new(1st, 5, 2, 3)
```

This does not change the value of `e`:

```
e
new(1st, 1, 2, 3)
```

```
delete d, e:
```

### Example 2

The domain type of an element can be changed by replacing its 0-th operand:

```
d := newDomain("some_domain"): e := new(d, 2):
extsubsop(e, 0 = Dom::IntegerMod(5))
```

```
2 mod 5
```

```
delete d, e:
```

### Example 3

We substitute the sixth operand of a domain element that has less than six operands. In such cases, an appropriate number of NIL's is inserted:

```
d := newDomain("example"): e := new(d, 1, 2, 3, 4):  
extsubsop(e, 6 = 8)
```

```
new(example, 1, 2, 3, 4, NIL, 8)
```

```
delete d, e:
```

### Example 4

We substitute the first operand of a domain element *e* by a sequence with three elements. These become the first three operands of the result; the second operand of *e* becomes the fourth operand of the result, and so on. This new numbering is already in effect when the second substitution is carried out:

```
d := newDomain("example"): e := new(d, 1, 2, 3, 4):  
extsubsop(e, 1 = (11, 13, 17), 2 = (29, 99))
```

```
new(example, 11, 29, 99, 17, 2, 3, 4)
```

```
delete d, e:
```

### Example 5

We define a domain with its own evaluation method. This method prints out its argument such that we can see whether it is called. Then we define an element of our domain.

```
d := newDomain("anotherExample"):  
d::evaluate := x -> (print("Argument:", x); x):  
e := new(d, 3)
```

```
new(anotherExample, 3)
```

We can now watch all evaluations that happen: `extsubsop` evaluates its arguments, performs the desired substitution, but does not evaluate the result of the substitution:

```
extsubsop(e, 1 = 0)
```

```
"Argument:", new(anotherExample, 3)
```

```
new(anotherExample, 0)
```

```
delete d, e:
```

## Example 6

`extsubsop` applied to an object from a kernel type yields the same result as `subsop`:

```
extsubsop([1,2,3], 2=4), subsop([1,2,3], 2=4)
```

```
[1, 4, 3], [1, 4, 3]
```

## Parameters

**d**

Arbitrary MuPAD object

**i1, i2, ...**

Nonnegative integers

**new1, new2, ...**

Arbitrary MuPAD objects

## **Return Values**

Input object with replaced operands.

## **See Also**

### **MuPAD Domains**

DOM\_DOMAIN

### **MuPAD Functions**

extnops | extop | new | nops | op | subs | subsex | subsop

# !fact

Factorial function

## Syntax

`n !`

`fact(n)`

## Description

`fact(n)` represents the factorial  $n! = 1 \cdot 2 \cdot 3 \dots$  of an integer.

The short hand call `n!` is equivalent to `fact(n)`.

If `n` is a nonnegative integer smaller than the value returned by `Pref::autoExpansionLimit()`, then an integer is returned. If `n` is a numerical value that is not an integer, then an error occurs. If `n` is a symbolic expression, then a symbolic call of `fact` is returned.

Use `expand(n!)` to compute an explicit result for large integers `n` equal to or larger than `Pref::autoExpansionLimit()`.

The `gamma` function generalizes the factorial function to arbitrary complex arguments. It satisfies  $\text{gamma}(n+1) = n!$  for nonnegative integers `n`. Expressions involving symbolic `fact` calls can be rewritten by `rewrite(expression, gamma)`. Cf. "Example 3" on page 1-716 (Symbolic Math Toolbox).

The operator `!` can also be used in prefix notation with an entirely different meaning: `!command` is equivalent to `system("command")`.

## Examples

### Example 1

Integer numbers are produced if the argument is a nonnegative integer:

```
fact(0), fact(5), fact(2^5)
```

```
1, 120, 26313083693369353016721801216000000
```

A symbolic call is returned if the argument is a symbolic expression:

```
fact(n), fact(n - sin(x)), fact(3.0*n + I)
```

```
n!, (n - sin(x))!, (3.0 n + i)!
```

The calls `fact(n)` and `n!` are equivalent:

```
5! = fact(5), fact(n^2 + 3)
```

```
120 = 120, (n^2 + 3)!
```

### Example 2

Use `gamma(float(n+1))` rather than `float(fact(n))` for floating-point approximations of large factorials. This avoids the costs of computing large integer numbers:

```
float(fact(2^13)) = gamma(float(2^13 + 1))
```

```
1.275885799 1028503 = 1.275885799 1028503
```

### Example 3

The functions `expand`, `limit`, `rewrite` and `series` handle expressions involving `fact`:

```
expand(fact(n^2 + 4))
```

$$(n^2)! (n^2 + 1) (n^2 + 2) (n^2 + 3) (n^2 + 4)$$

```
limit(fact(n)/exp(n), n = infinity)
```

$$\infty$$

```
rewrite(fact(2*n^2 + 1)/fact(n - 1), gamma)
```

$$\frac{\Gamma(2n^2 + 2)}{\Gamma(n)}$$

The Stirling formula is obtained as an asymptotic series:

```
series(fact(n), n = infinity, 3)
```

$$\frac{\sqrt{2} \sqrt{n} \sqrt{\pi} e^{-n}}{\left(\frac{1}{n}\right)^n} + \frac{\sqrt{2} \sqrt{\pi} e^{-n}}{12 \sqrt{n} \left(\frac{1}{n}\right)^n} + O\left(\frac{e^{-n}}{n^{3/2} \left(\frac{1}{n}\right)^n}\right)$$

## Parameters

**n**

An arithmetical expression (Symbolic Math Toolbox) representing a nonnegative integer

## Return Values

Arithmetical expression.

## Overloaded By

n

## See Also

### MuPAD Functions

beta | binomial | gamma | igamma | pochhammer | psi



# !!fact2

Double factorial function

## Syntax

$n !!$   
`fact2(n)`

## Description

`fact2(n)` represents the double factorial of an integer. The double factorial is defined as  $n!! = 2 \cdot 4 \cdot \dots \cdot n$  for even positive integers and  $n!! = 1 \cdot 3 \cdot \dots \cdot n$  for odd positive integers.

The short hand call  $n !!$  is equivalent to `fact2(n)`.

$0 !!$  and  $(-1) !!$  both return 1.

If  $n$  is an integer greater or equal to -1 and smaller than the value given by `Pref::autoExpansionLimit()`, then an integer is returned. If  $n$  is an integer smaller than -1 or a non-integer numerical value then an error occurs. If  $n$  is a symbolic expression, then a symbolic call of `fact2` is returned.

Use `expand(n!!)` to compute an explicit result for large integers  $n$  equal to or larger than `Pref::autoExpansionLimit()`.

Expressions involving symbolic calls of `fact2` can be rewritten in terms of the `gamma` function by `rewrite(expression, gamma)`. Cf. "Example 2" on page 1-720 (Symbolic Math Toolbox).

Note that the double factorial  $n !!$  does *not* equal the iterated factorial  $(n!) !$ .

## Examples

### Example 1

Integer numbers are produced if the argument is an integer greater than or equal to - 1:

```
fact2(-1), fact2(0), fact2(5), fact2(16)
```

```
1, 1, 15, 10321920
```

A symbolic call is returned if the argument is a symbolic expression:

```
fact2(n), fact2(4.7*I*n)
```

```
n!!, (4.7 n i)!!
```

The calls `fact2(n)` and `n!!` are equivalent:

```
5!! = fact2(5), fact2(n^2 + 3)
```

```
15 = 15, (n^2 + 3)!!
```

### Example 2

The function `rewrite` can be used to rewrite expressions involving `fact2` in terms of the gamma function. In most cases, `Simplify` has to be used to obtain a simple result:

```
rewrite(n!!, gamma)
```

$$2^{\frac{n}{2}} - \frac{(-1)^n}{4} + \frac{1}{4} \pi \frac{(-1)^n}{4} - \frac{1}{4} \Gamma\left(\frac{n}{2} + 1\right)$$

```
rewrite(fact2(2*n)/fact2(2*n - 1), gamma)
```

$$\frac{2^{\frac{(-1)^{2n-1}}{4} - n + \frac{1}{4}} 2^{n - \frac{(-1)^{2n}}{4} + \frac{1}{4}} \pi^{\frac{(-1)^{2n}}{4} - \frac{1}{4}} \frac{1}{\pi^{\frac{1}{4}}} \frac{(-1)^{2n-1}}{4}}{\Gamma(n + \frac{1}{2})} \Gamma(n + 1)$$

```
assume(n, Type::Integer): Simplify(%2)
```

$$\frac{2^{2n} n (n-1)!^2}{2 \Gamma(2n)}$$

### Example 3

For efficiency, the double factorial should be rewritten in terms of `gamma` if a floating-point evaluation for large arguments is desired. The following call produces a huge exact integer that is finally converted to a float:

```
float(fact2(2^17))
```

1.03441219 10<sup>306922</sup>

The following call is much faster because no exact intermediate result is computed:

```
float(subs(rewrite(fact2(n), gamma), n = 2^17))
```

1.03441219 10<sup>306922</sup>

## Parameters

**n**

An arithmetical expression (Symbolic Math Toolbox) representing an integer greater than or equal to - 1.

## **Return Values**

Arithmetical expression.

## **Overloaded By**

$n$

## **See Also**

### **MuPAD Functions**

`beta` | `binomial` | `fact` | `gamma` | `igamma` | `psi`

# factor

Factor a polynomial into irreducible polynomials

## Syntax

```
factor(f, <Adjoin = adjoin>, <MaxDegree = n>)
```

```
factor(f, F | Domain = F | Full)
```

## Description

`factor(f)` computes a factorization  $f = u f_1^{e_1} \dots f_r^{e_r}$  of the polynomial  $f$ , where  $u$  is the content of  $f$ ,  $f_1, \dots, f_r$  are the distinct primitive irreducible factors of  $f$ , and  $e_1, \dots, e_r$  are positive integers.

`factor` rewrites its argument as a product of as many terms as possible. In a certain sense, it is the complementary function of `expand`, which rewrites its argument as a sum of as many terms as possible.

If  $f$  is a polynomial (Symbolic Math Toolbox) whose coefficient ring is not `Expr`, then  $f$  is factored over its coefficient ring. See “Example 10” on page 1-731 (Symbolic Math Toolbox).

If  $f$  is a polynomial (Symbolic Math Toolbox) with coefficient ring `Expr`, then  $f$  is factored over the smallest ring containing the coefficients. Mathematically, this *implied coefficient ring* always contains the ring  $\mathbb{Z}$  of integers. See “Example 4” on page 1-728 (Symbolic Math Toolbox). If the coefficient ring  $R$  of  $f$  is not `Expr`, then we say that the implied coefficient ring is  $R$ . Elements of the implied coefficient ring are considered to be constants and are not factored any further. In particular, the content  $u$  is an element of the implied coefficient ring.

With the option `Adjoin`, the elements of `adjoin` are also adjoined to the coefficient ring.

If the second argument `F` or, alternatively, `Domain = F` is given, then  $f$  is factored over the real numbers  $\mathbb{R}$  or the complex numbers  $\mathbb{C}$ . Factorization over  $\mathbb{R}$  or  $\mathbb{C}$  is performed using numerical calculations and the results will contain floating-point numbers. See “Example 5” on page 1-729 (Symbolic Math Toolbox).

If  $f$  is an arithmetical expression (Symbolic Math Toolbox) but not a number (Symbolic Math Toolbox), it is considered as a rational expression. Non-rational subexpressions such as  $\sin(x)$ ,  $\exp(1)$ ,  $x^{(1/3)}$  etc., but not constant algebraic subexpressions such as  $I$  and  $(\sqrt{2}+1)^3$ , are replaced by auxiliary variables before factoring. Algebraic dependencies of the subexpressions, such as the equation  $\cos(x)^2 = 1 - \sin(x)^2$ , are not necessarily taken into account. See “Example 7” on page 1-730 (Symbolic Math Toolbox).

The resulting expression is then written as a quotient of two polynomial expressions (Symbolic Math Toolbox) in the original and the auxiliary indeterminates. The numerator and the denominator are converted into polynomials (Symbolic Math Toolbox) with coefficient ring `Expr` via `poly`, and the implied coefficient ring is the smallest ring containing the coefficients of the numerator polynomial and the denominator polynomial. Usually, this is the ring of integers. Then both polynomials are factored over the implied coefficient ring, and the multiplicities  $e_i$  corresponding to factors of the denominator are negative integers; see “Example 3” on page 1-728 (Symbolic Math Toolbox). After the factorization, the auxiliary variables are replaced by the original subexpressions. See “Example 6” on page 1-730 (Symbolic Math Toolbox).

If  $f$  is an integer on page 7-31, then it is decomposed into a product of primes, and the result is the same as for `ifactor`. If  $f$  is a rational number on page 7-48, then both the numerator and the denominator are decomposed into a product of primes. In this case, the multiplicities  $e_i$  corresponding to factors of the denominator are negative integers. See “Example 2” on page 1-727 (Symbolic Math Toolbox).

If  $f$  is a floating point number on page 7-23 or a complex number on page 7-84, then `factor` returns a factorization with the single factor  $f$ .

The result of `factor` is an object of the domain type `Factored`. Let  $g := \text{factor}(f)$  be such an object.

It is represented internally by the list on page 7-41  $[u, f_1, e_1, \dots, f_r, e_r]$  of odd length  $2r + 1$ . Here,  $f_1$  through  $f_r$  are of the same type as the input (either polynomials or expressions);  $e_1$  through  $e_r$  are integers; and  $u$  is an arithmetical expression.

One may extract the content  $u$  and the terms  $f_i^{e_i}$  by the ordinary index operator `[ ]`, i.e.,  $g[1] = f_1^{e_1}$ ,  $g[2] = e_1^{e_2}$ , ... if  $u = 1$  and  $g[1] = u$ ,  $g[2] = f_1^{e_1}$ ,  $g[3] = e_1^{e_2}$ , ..., respectively, if  $u \neq 1$ .

The call `Factored::factors(g)` yields the list  $[f_1, f_2, \dots]$  of factors, the call `Factored::exponents(g)` returns the list  $[e_1, e_2, \dots]$  of exponents.

The call `coerce(g, DOM_LIST)` returns the internal representation of a factored object, i.e., the list `[u, f1, e1, f2, e2, ...]`.

Note that the result of `factor` is printed as an expression, and it is implicitly converted into an expression whenever it is processed further by other MuPAD functions. As an example, the result of `q:=factor(x^2+2*x+1)` is printed as  $(x+1)^2$ , which is an expression on page 7-20 of type `"_power"`.

See “Example 1” on page 1-725 (Symbolic Math Toolbox) for illustrations, and the help page of `Factored` for details.

If `f` is not a number, then each of the polynomials  $p_1, \dots, p_r$  is primitive, i.e., the greatest common divisor of its coefficients (see `content` and `gcd`) over the implied coefficient ring (see above for a definition) is one.

Currently, factoring polynomials is possible over the following implied coefficient rings: integers, real numbers, complex numbers and rational numbers, finite fields—represented by `IntMod(n)` or `Dom::IntegerMod(n)` for a prime number `n`, or by a `Dom::GaloisField`—, and rings obtained from these basic rings by taking polynomial rings (see `Dom::DistributedPolynomial`, `Dom::MultivariatePolynomial`, `Dom::Polynomial`, and `Dom::UnivariatePolynomial`), fields of fractions (see `Dom::Fraction`), and algebraic extensions (see `Dom::AlgebraicExtension`).

If the input `f` is an arithmetical expression (Symbolic Math Toolbox) that is not a number (Symbolic Math Toolbox), all occurring floating-point numbers are replaced by continued fraction approximations. The result is sensitive to the environment variable `DIGITS`, see `numeric::rationalize` for details.

## Examples

### Example 1

To factor the polynomial  $x^3 + x$ , enter:

```
g := factor(x^3+x)
```

$$x(x^2 + 1)$$

Usually, expressions are factored over the ring of integers, and factors with non-integral coefficients, such as  $x - I$  in the example above, are not considered.

One can access the internal representation of this factorization with the ordinary index operator:

```
g[1], g[2]
```

```
x, x2 + 1
```

The internal representation of `g`, as described above, is given by the following command:

```
coerce(g, DOM_LIST)
```

```
[1, x, 1, x2 + 1, 1]
```

The result of the factorization is an object of domain type `Factored`:

```
domtype(g)
```

```
Factored
```

Some of the functionality of this domain is described in what follows.

One may extract the factors and exponents of the factorization also in the following way:

```
Factored::factors(g), Factored::exponents(g)
```

```
[x, x2 + 1], [1, 1]
```

One can ask for the type of factorization:

```
Factored::getType(g)
```

```
"irreducible"
```

This output means that all  $f_i$  are irreducible. Other possible types are "squarefree" (see `polylib::sqrfree`) or "unknown".



One may multiply factored objects, which preserves the factored form:

```
g2 := factor(x^2 + 2*x + 1)
```

$$(x+1)^2$$

```
g * g2
```

$$x(x^2+1)(x+1)^2$$

It is important to note that one can apply (almost) any function working with arithmetical expressions to an object of type `Factored`. However, the result is then usually not of domain type `Factored`:

```
expand(g);
domtype(%)
```

$$x^3+x$$

`DOM_EXPR`

For a detailed description of these objects, please refer to the help page of the domain `Factored`.

## Example 2

`factor` splits an integer into a product of prime factors:

```
factor(8)
```

$$2^3$$

For rational numbers, both the numerator and the denominator are factored:

```
factor(10/33)
```

$$2^5 3^{-1} 11^{-1}$$

Note that, in contrast, constant polynomials are *not* factored:

```
factor(poly(8, [x]))
```

8

### Example 3

Factors of the denominator are indicated by negative multiplicities:

```
factor((z^2 - 1)/z^2)
```

$$\frac{(z-1)(z+1)}{z^2}$$

```
Factored::factors(%), Factored::exponents(%)
```

$[z-1, z+1, z], [1, 1, -2]$

### Example 4

If some coefficients are irrational but algebraic, the factorization takes place over the smallest field extension of the rationals that contains all of them. Hence,  $x^2+1$  is considered irreducible while its  $\mathbb{I}$ -fold is considered reducible:

```
factor(x^2 + 1), factor(I*x^2 + I)
```

$$x^2 + 1, i(x-i)(x+i)$$

MuPAD does not automatically factor over the field of algebraic numbers; only the coefficients of the input are adjoined to the rationals:

```
factor(sqrt(2)*x^4 - sqrt(2)*x^2 - sqrt(2)*2)
```

$$\sqrt{2} (x + \sqrt{2}) (x - \sqrt{2}) (x^2 + 1)$$

```
factor(I*x^4 - I*x^2 - I*2)
```

$$i (x - i) (x + i) (x^2 - 2)$$

```
factor(sqrt(2)*I*x^4 - sqrt(2)*I*x^2 - sqrt(2)*I*2)
```

$$(\sqrt{2} i) (x + \sqrt{2}) (x + i) (x - i) (x - \sqrt{2})$$

## Example 5

With the option *Adjoin*, additional elements can be adjoined to the implied coefficient ring:

```
factor(x^2 + 1, Adjoin = [I])
```

$$(x - i) (x + i)$$

```
factor(x^2-2, Adjoin = {sqrt(2)} )
```

$$(x - \sqrt{2}) (x + \sqrt{2})$$

With the option *Full*, a complete factorization into linear factors can be computed.

```
factor(x^2-2, Full)
```

$$(x - \sqrt{2}) (x + \sqrt{2})$$

If the argument *R\_* or *C\_* is given, factorization is done over the real or complex numbers using numeric calculations:

```
factor(x^2-2, R_ )
```

$$(x - 1.414213562) (x + 1.414213562)$$

```
factor(x^2 + 1, C_)
```

$$(x + 1.0 i) (x - 1.0 i)$$

## Example 6

Transcendental objects are treated as indeterminates:

```
delete x:  
factor(7*(cos(x)^2 - 1)*sin(1)^3)
```

$$7 \sin(1)^3 (\cos(x) - 1) (\cos(x) + 1)$$

```
Factored::factors(%), Factored::exponents(%)
```

$$[\sin(1), \cos(x) - 1, \cos(x) + 1], [3, 1, 1]$$

## Example 7

factor regards transcendental subexpressions as algebraically independent of each other. Sometimes, the dependence is recognized:

```
factor(x + 2*sqrt(x) + 1)
```

$$(\sqrt{x} + 1)^2$$

In many cases, however, the algebraic dependence is not recognized:

```
factor(x^2 + (2^y*3^y + 6^y)* x + (6^y)^2)
```

$$6^{2y} + 6^y x + x^2 + 2^y 3^y x$$

## Example 8

`factor` replaces floating-point numbers by continued fraction approximations, factors the resulting polynomial, and finally applies `float` to the coefficients of the factors:

```
factor(x^2 + 2.0*x - 8.0)
```

$$1.0 (x + 4.0) (x - 2.0)$$

## Example 9

`factor` with the option `Full` can use `RootOf` to symbolically represent the roots of a polynomial:

```
factor(x^5 + x^2 + 1, Full)
```

$$(x - \text{RootOf}(z^5 + z^2 + 1, z, 1)) (x - \text{RootOf}(z^5 + z^2 + 1, z, 2)) \\ (x - \text{RootOf}(z^5 + z^2 + 1, z, 3)) (x - \text{RootOf}(z^5 + z^2 + 1, z, 4)) \\ (x - \text{RootOf}(z^5 + z^2 + 1, z, 5))$$

## Example 10

Polynomials with a coefficient ring other than `Expr` are factored over their coefficient ring. We factor the following polynomial modulo 17:

```
R := Dom::IntegerMod(17): f:= poly(x^3 + x + 1, R):
factor(f)
```

$$\text{poly}(x + 6, [x], \text{Dom}::\text{IntegerMod}(17)) \text{poly}(x^2 + 11x + 3, [x], \text{Dom}::\text{IntegerMod}(17))$$

For every `p`, the expression `IntMod(p)` may be used instead of `Dom::IntegerMod(p)`:

```
R := IntMod(17): f:= poly(x^3 + x + 1, R):
factor(f)
```

```
poly(x + 6, [x], IntMod(17)) poly(x^2 - 6 x + 3, [x], IntMod(17))
```

## Example 11

More complex domains are allowed as coefficient rings, provided they can be obtained from the rational numbers or from a finite field by iterated construction of algebraic extensions, polynomial rings, and fields of fractions. In the following example, we factor the univariate polynomial  $u^2 - x^3$  in  $u$  over the coefficient field  $F = \mathbb{Q}(x, \sqrt{x})$ :

```
Q := Dom::Rational:
Qx := Dom::Fraction(Dom::DistributedPolynomial([x], Q)):
F := Dom::AlgebraicExtension(Qx, poly(z^2 - x, [z])):
f := poly(u^2 - x^3, [u], F)
```

```
poly(u^2
-x^3, [u], Dom::AlgebraicExtension(Dom::Fraction(Dom::DistributedPolynomial([x],
Dom::Rational, LexOrder)), -x + z^2 = 0, z))
```

```
factor(f)
```

```
poly(u + x
z, [u], Dom::AlgebraicExtension(Dom::Fraction(Dom::DistributedPolynomial([x],
Dom::Rational, LexOrder)), -x + z^2 = 0, z)) poly(u - x
z, [u], Dom::AlgebraicExtension(Dom::Fraction(Dom::DistributedPolynomial([x],
Dom::Rational, LexOrder)), -x + z^2 = 0, z))
```

## Parameters

**f**

A polynomial (Symbolic Math Toolbox) or an arithmetical expression (Symbolic Math Toolbox)

**F**

R\_ or C\_

## Options

### MaxDegree

Option, specified as `MaxDegree = n`

Only algebraic numbers of a maximum degree  $n$  will be adjoined to the rational numbers. If not specified, all coefficients up to degree 2 are adjoined.  $n$  must be a positive integer.

### Adjoin

Option, specified as `Adjoin = adjoin`

In addition to the coefficients of  $f$ , the elements of `adjoin` are adjoined to the rational numbers. Elements of algebraic degree larger than the value of the option `MaxDegree` are not adjoined. `adjoin` must be a set or list.

### Domain

Option, specified as `Domain = F`

Compute a numerical factorization over  $\mathbb{R}$  or  $\mathbb{C}$ , respectively.

### Full

Compute the full factorization of  $f$  into linear factors. This option has no effect on multivariate polynomials.

## Return Values

Object of the domain type Factored.

## Overloaded By

f

## Algorithms

The factoring algorithms are collected in a separate library domain `facLib`; it should not be necessary to call these routines directly.

The implemented algorithms include Cantor-Zassenhaus (over finite fields) and Hensel lifting (over the rational numbers and in the multivariate case).

## See Also

### MuPAD Functions

Factored | collect | content | denom | div | divide | expand | gcd | icontent | ifactor | igcd | ilcm | indets | irreducible | isprime | lcm | normal | numer | partfrac | polylib::decompose | polylib::divisors | polylib::primpart | polylib::sqrfree | rationalize | simplify

### Topics

“Manipulate Expressions” (Symbolic Math Toolbox)

“Choose Simplification Functions” (Symbolic Math Toolbox)



# factorout

Factor out a given expression

## Syntax

```
factorout(x, f, <list>)
```

## Description

`factorout(x, f)` factors out a given expression  $f$  from the expression  $x$ .

The result is a product of the form  $f \left(\frac{x}{f}\right)$ .

If the optional parameter *list* is set to `TRUE`, a list of the factors is returned. See “Example 2” on page 1-736 (Symbolic Math Toolbox)

## Examples

### Example 1

```
factorout(2*x+4, 2)
```

$2 (x + 2)$

```
factorout(a+a*2, a)
```

$3 a$

```
factorout(a+a*3, 2)
```

$2 (2 a)$

```
factorout(a*b + b*c, b)
```

$$b (a + c)$$

```
factorout(a*sin(b) + c*sin(b), sin(b))
```

$$\sin(b) (a + c)$$

```
factorout(sqrt(50)*x^2+5*x-sqrt(10)*x-sqrt(10), sqrt(5))
```

$$\sqrt{5} (\sqrt{10} x^2 + (\sqrt{5} - \sqrt{2}) x - \sqrt{2})$$

```
factorout((a*b + b*c)/(d*c+c), b/c)
```

$$\frac{b}{c} \frac{a+c}{d+1}$$

## Example 2

With the optional parameter 'list' set to true, a list of all factors is returned:

```
factorout(a*b + b*c, b, TRUE)
```

$$[b, a + c]$$

## Parameters

**x**

An expression.

**f**

The expression to be factored out.

**list**

A boolean value. If list is TRUE, then a list is returned. By default, an expression is returned.

**Return Values**

Expression or a list.

# FAIL

Indicate a failed computation

## Syntax

FAIL

## Description

FAIL is a keyword of the MuPAD language. Many functions of the library use the return value FAIL to indicate failed computations or non-existing elements.

FAIL is the only element of the domain (Symbolic Math Toolbox) `DOM_FAIL`.

FAIL is used as the return value for computations that failed. Also, requesting non-existing slots on page 1-1980 of domains (Symbolic Math Toolbox) or function environments on page 1-1642 (Symbolic Math Toolbox) yields FAIL. Due to this behavior, library functions can try computations without provoking errors.

A function should return FAIL or an error if at least one of its inputs is FAIL.

## Examples

### Example 1

The following attempt to convert `sqrt(3)` to an integer of a residue class ring must fail:

```
poly(sqrt(3)*x, [x], Dom::IntegerMod(3))
```

```
FAIL
```

The following matrix is not invertible. You can try to invert it without producing an error:

```
A := matrix([[1, 1], [1, 1]]): 1/A
```

FAIL

The "inverse" slot of a function environment yields the inverse of the function. The inverse of the sine on page 1-688 (Symbolic Math Toolbox) function is implemented, but MuPAD does not know the inverse of the dilogarithm on page 1-544 function:

```
sin::inverse, dilog::inverse
```

"arcsin", FAIL

```
delete A:
```

## Example 2

Most functions return FAIL or an error on input of FAIL:

```
poly(FAIL)
```

FAIL

```
sin(FAIL)
```

```
Error: Arithmetical expression expected. [sin]
```

## Example 3

FAIL evaluates to itself:

```
FAIL, eval(FAIL), level(FAIL, 5)
```

FAIL, FAIL, FAIL

## **See Also**

**MuPAD Functions**  
NIL | error | null

# fclose

Close a file

## Syntax

```
fclose(n)
```

## Description

`fclose(n)` closes the file specified by the file descriptor `n`.

The file must have been opened with `fopen`. The call to `fopen` yields the file descriptor `n` representing the file.

Only a limited number of file descriptors is available. The user should use `fclose` to close a file which is no longer needed because this releases the file descriptor. The exact number of file descriptors available depends on the used operating system.

## Examples

### Example 1

We open a file `test` for writing. This yields the file descriptor `n`:

```
fid := fopen(TempFile, Write, Text):  
file := fname(fid):  
n := fopen(file, Write):
```

We close the file:

```
fclose(n):  
delete n:
```

## Parameters

**n**

A file descriptor returned by `fopen`: a positive integer

## Return Values

Void object of type `DOM_NULL`.

## See Also

### MuPAD Functions

`FILEPATH` | `READPATH` | `WRITEPATH` | `finput` | `fname` | `fopen` | `fprint` | `fread` | `ftextinput` | `import::readbitmap` | `import::readdata` | `pathname` | `print` | `protocol` | `read` | `readbytes` | `write` | `writebytes`



# FILEPATH

Pathname of a file that is currently loaded

## Description

FILEPATH is a variable containing the path of a currently read file.

Possible values: String

The variable FILEPATH represents the pathname of a file. It only has a value while reading a file via `read` or `fread` and corresponds to the path specified in `read` or `fread`. It can only be accessed from inside the file that is currently read. Using this variable, the read file can access its own pathname and read other files via absolute pathnames, even if it only knows their relative locations with respect to itself.

The value of FILEPATH is a string containing the operating system dependent path to the file that is currently read. The path string terminates with a path separator and, under Windows®, starts with the name of the current volume if this was specified in the `read/fread` command. Cf. “Example 1” on page 1-743 (Symbolic Math Toolbox).

## Examples

### Example 1

Assume that the file `C:\TEMP\file.mu` contains the following lines of code. It queries its own location via FILEPATH (= `C:\TEMP`) and reads two files installed relative to the location of `file.mu` via their absolute pathnames `C:\TEMP\SubFolder\file1.mu` and `C:\TEMP\SubFolder\file2.mu`, respectively:

```
print(Unquoted, "FILEPATH" = FILEPATH):  
read(FILEPATH.pathname("SubFolder")."file1.mu"):  
read(FILEPATH.pathname("SubFolder")."file2.mu"):
```

When reading the file `file.mu`, the part `C:\TEMP\` of the specified path is accessed by `file.mu` via FILEPATH. It finds the files `file1.mu` and `file2.mu` if they were installed correctly relative to the path of `file.mu`:

```
read("C:".pathname(Root, "TEMP"), "file.mu")
```

```
FILEPATH = C:\TEMP\
```

It is good programming style to use platform independent path strings. For this reason, we used the function `pathname` rather than a mere string concatenation to append appropriate path delimiters.

## See Also

### MuPAD Functions

READPATH | `fclose` | `fopen` | `fread` | `pathname` | `read`

# finput

Read objects from file

## Syntax

```
finput(filename | n, <Encoding = "encodingValue">)
```

```
finput(filename | n, <Encoding = "encodingValue">, x1, x2, ...)
```

## Description

`finput(filename, x)` reads a MuPAD object from a file and assigns it to the identifier `x`.

`finput(n, x)` reads from the file associated with the file descriptor `n`.

`finput` can read MuPAD binary files as well as ASCII text files. `finput` recognizes the format of the file automatically.

`finput(..., Encoding = "encodingValue", ...)` uses the specified encoding. For supported encodings, see “Options” on page 1-750 (Symbolic Math Toolbox). You can use this option with any of the previously specified syntaxes.

Binary files may be created via `fprint` or `write`. Text files can also be created in a MuPAD session via these functions (using the `Text` option; see the corresponding help pages for details). Alternatively, text files can be created and edited directly using your favorite text editor. The file must consist of syntactically correct MuPAD objects or statements, separated by semicolons or colons. An object may extend over more than one line.

`finput(filename)` reads the first object in the file and returns it to the MuPAD session.

`finput(filename, x1, x2, ...)` reads the contents of a file object by object. The  $i$ -th object is assigned to the identifier  $x_i$ . The identifiers are not evaluated while executing `finput`; previously assigned values are overwritten. The objects are not evaluated. Evaluation can be enforced with the function `eval`. Cf. “Example 2” on page 1-747 (Symbolic Math Toolbox).

Instead of a file name, also a file descriptor `n` of a file opened via `fopen` can be used. The functionality is as described above. However, there is one difference: With a file name, the file is closed automatically after the data were read. A subsequent call to `finput` starts at the beginning of the file. With a file descriptor, the file remains open (use `fclose` to close the file). The next time data are read from this file, the reading continues at the current position. Consequently, a file descriptor should be used if the individual objects in the file are to be read via several subsequent calls of `finput`. Cf. “Example 3” on page 1-748 (Symbolic Math Toolbox).

Files in `gzip` compressed format with a filename ending in “.gz” are automatically and transparently decompressed while reading.

If the number of identifiers specified in the `finput` call is larger than the number of objects in the file, the additional identifiers are assigned the value `null()`.

`finput` interprets the file name as a pathname relative to the “working folder.”

Note that the meaning of “working folder” depends on the operating system. On Windows systems and on Mac OS X systems, the “working folder” is the folder where MATLAB is installed. On UNIX systems, it is the current working folder in which MATLAB was started. When started from a menu or desktop item, this is typically the user's home folder.

Also absolute path names are processed by `finput`.

Expression sequences on page 1-88 are not flattened (Symbolic Math Toolbox) by `finput` and cannot be used to pass several identifiers to `finput`. Cf. “Example 4” on page 1-749 (Symbolic Math Toolbox).

## Examples

### Example 1

Create a new file in the system's temporary folder. The name of the temporary folder varies for different platforms. The `fopen` command with the `TempFile` option creates a file in any system's temporary folder (if such folder exists):

```
fid := fopen(TempFile, Write, Text):
```

Write the numbers 11, 22, 33 and 44 into a file:

```
fprint(fid, 11, 22, 33, 44):
```

Use `fname` to return the name of the temporary file you created:

```
file := fname(fid):
```

Read this file with `finput`:

```
finput(file, x1, x2, x3, x4)
```

```
44
```

```
x1, x2, x3, x4
```

```
11, 22, 33, 44
```

If you try to read more objects than stored in the file, `finput` returns the void object of type `DOM_NULL`:

```
finput(file, x1, x2, x3, x4, x5); domtype(%)
```

```
DOM_NULL
```

```
delete x1, x2, x3, x4, x5:
```

## Example 2

Objects read from a file are not evaluated:

```
fid := fopen(TempFile, Write, Text):  
file := fname(fid):  
fprint(file, x1):  
x1 := 23:  
finput(file)
```

```
x1
```

```
eval(%)
```

23

```
delete x1:
```

### Example 3

Read some data from a file using several calls of `finput`. You have to use a file descriptor for reading from the file. The file is opened for reading with `fopen`:

```
fid := fopen(TempFile, Write, Text):  
fprintf(fid, 11, 22, 33, 44):  
file := fname(fid):  
n := fopen(file):
```

The file descriptor returned by `fopen` can be passed to `finput` for reading the data:

```
finput(n, x1, x2): x1, x2
```

11, 22

```
finput(n, x3, x4):  
x3, x4
```

33, 44

Close the file and delete the identifiers:

```
fclose(n):  
delete n, x1, x2, x3, x4:
```

Alternatively, the contents of a file can be read into a MuPAD session in the following way:

```
n := fopen(file):  
for i from 1 to 4 do  
  x.i := finput(n)  
end_for:  
x1, x2, x3, x4
```

11, 22, 33, 44

```
fclose(n):
delete n, i, x1, x2, x3, x4:
```

## Example 4

Expression sequences on page 1-88 are not flattened (Symbolic Math Toolbox) by `finput` and cannot be used to pass identifiers to `finput`:

```
fid := fopen(TempFile, Write, Text):
fprintf(fid, 11, 22, 33):
file := fname(fid):
finput(file, (x1, x2), x3)
```

Error: Invalid argument. [finput]

The following call does not lead to an error because the identifier `x12` is not evaluated. Consequently, only one object is read from the file and assigned to `x12`:

```
x12 := x1, x2:
finput(file, x12):
x1, x2, x12
```

`x1, x2, 11`

```
delete x1, x2, x12:
```

## Example 5

To specify the encoding to write data, use `Encoding`. The `Encoding` option applies only to text files that are opened using a file name and not a file descriptor. Create a temporary file and store the values "abcäöü", 11 and 22 in the encoding "UTF-8":

```
fprintf(Text, Encoding="UTF-8", "finput_test", "abcäöü", 11, 22):
```

Specify the encoding to read the stored values correctly:

```
finput("finput_test", Encoding="UTF-8", x1, x2, x3):
x1, x2, x3
```

"abcäöü", 11, 22

If you do not specify an encoding, the default system encoding is used. Thus, your output might vary from that shown next. Characters unrecognized by the default system encoding are replaced by the default substitution character for that encoding:

```
finput("finput_test", x1, x2, x3):  
x1, x2, x3
```

```
"abc?????", 11, 22
```

## Parameters

### filename

The name of a file: a character string on page 7-53

### n

A file descriptor provided by `fopen`: a positive integer

### x<sub>1</sub>, x<sub>2</sub>, ...

identifiers on page 7-29

## Options

### Encoding

This option lets you specify the character encoding to use. The allowed encodings are:

"Big5"	"ISO-8859-1"	"windows-932"
"EUC-JP"	"ISO-8859-2"	"windows-936"
"GBK"	"ISO-8859-3"	"windows-949"
"KSC_5601"	"ISO-8859-4"	"windows-950"
"Macintosh"	"ISO-8859-9"	"windows-1250"
"Shift_JIS"	"ISO-8859-13"	"windows-1251"



"US-ASCII"	"ISO-8859-15"	"windows-1252"
"UTF-8"		"windows-1253"
		"windows-1254"
		"windows-1257"

The default encoding is system dependent. If you specify the encoding incorrectly, characters might read incorrectly. Characters unrecognized by the encoding are replaced by the default substitution character for the specified encoding.

Encodings not listed here can be specified but might not produce correct results.

## Return Values

Last object that was read from the file.

## See Also

### MuPAD Functions

READPATH | WRITEPATH | fclose | fname | fopen | fprintf | fread | ftextinput |  
input | pathname | print | protocol | read | textinput | write

# float

Convert to a floating-point number

## Syntax

`float(object)`

`float(object, n)`

## Description

`float(object)` converts the object or numerical subexpressions of the object to floating-point numbers.

`float` converts numbers and numerical expressions (Symbolic Math Toolbox) such as `sqrt(sin(2))` or `sqrt(3) + sin(PI/17)*I` to real or complex floating-point numbers of type `DOM_FLOAT` or `DOM_COMPLEX`, respectively. If symbolic objects other than the special constants `CATALAN` (Symbolic Math Toolbox), `E` (Symbolic Math Toolbox), `EULER` (Symbolic Math Toolbox), and `PI` (Symbolic Math Toolbox) are present, only *numerical* subexpressions are converted to floats. In particular, identifiers and indexed identifiers are returned unchanged by `float`. Cf. “Example 1” on page 1-754 (Symbolic Math Toolbox).

A `float` call is mapped recursively to the operands of an expression. When numbers (or constants such as `PI` (Symbolic Math Toolbox)) are found, they are converted to floating-point approximations. The number of significant decimal digits is given by the environment variable `DIGITS`; the default value is 10. The converted operands are combined by arithmetical operations or function calls according to the structure of the expression. E.g., a call such as `float(PI - 314/100)` may be regarded as a sequence of numerical operations:

```
t1 := float(PI); t2 := float(314/100); result := t1 - t2
```

Consequently, `float` evaluation via `float` may be subject to error propagation. Cf. “Example 2” on page 1-755 (Symbolic Math Toolbox).

The second argument `n` in `float(object, n)` temporarily overwrites the current setting for `DIGITS`. See “Example 3” on page 1-755 (Symbolic Math Toolbox).

`float` is automatically mapped to the elements of sets on page 7-50 and lists on page 7-41. However, it is not automatically mapped to the entries of arrays on page 7-2, `hfarrays` on page 7-2, tables on page 1-2103, and operands of function calls. Use `map(object, float)` for a fast floating-point conversion of all entries of an array or a table. Use `mapcoeffs(p, float)` to convert the coefficients of a polynomial (Symbolic Math Toolbox) `p` of type `DOM_POLY`. To control the behavior of `float` on a function call, use a function environment on page 1-1642 (Symbolic Math Toolbox) providing a “float” slot. Cf. “Example 4” on page 1-756 (Symbolic Math Toolbox) and “Example 5” on page 1-757 (Symbolic Math Toolbox).

The preferences `Pref::floatFormat` and `Pref::trailingZeroes` can be used to modify the screen output of floating-point numbers.

Rational approximations of floating-point numbers may be computed by the function `numeric::rationalize`.

MuPAD special functions such as `sin`, `exp`, `besselJ` etc. are implemented as function environments on page 1-1642 (Symbolic Math Toolbox). Via overloading (Symbolic Math Toolbox), the “float” attribute (slot on page 1-1980) of a function environment `f`, say, is called for the float evaluation of symbolic calls `f(x1, x2, ...)` contained in an expression.

The user may extend the functionality of the system function `float` to his own functions. For this, the function `f` to be processed must be declared as a function environment via `funcenv`. A “float” attribute must be written, which is called by the system function `float` in the form `f::float(x1, x2, ...)` whenever a symbolic call `f(x1, x2, ...)` inside an expression is found. The arguments passed to `f::float` are not converted to floats, neither is the return value of the slot subject to any further float evaluation. Thus, the float conversion of symbolic functions calls of `f` is entirely determined by the slot routine. Cf. “Example 5” on page 1-757 (Symbolic Math Toolbox).

Also a domain (Symbolic Math Toolbox) `d`, say, written in the MuPAD language, can overload `float` to define the float evaluation of its elements. A slot on page 1-1980 `d::float` must be implemented. If an element `x`, say, of this domain is subject to a float evaluation, the slot is called in the form `d::float(x)`. As for function environments, neither `x` nor the return value of the slot are subject to any further float evaluation.

If a domain does not have a “float” slot, the system function `float` returns its elements unchanged.

Note that MuPAD floating-point numbers are restricted in size. On 32 bit architectures, an overflow/underflow occurs if numbers of absolute size larger/smaller than about

$10.0^{\pm 2525222}$  are encountered. On 64 bit architectures, the limits are about  $10.0^{\pm 42366205509363}$ .

See the documentation for DIGITS for further information.

## Environment Interactions

The function is sensitive to the environment variable DIGITS which determines the numerical working precision.

## Examples

### Example 1

We convert some numbers and numerical expressions to floats:

```
float(17), float(PI/7 + I/4), float(4^(1/3) + sin(7))
```

```
17.0, 0.4487989505 + 0.25 i, 2.244387651
```

float is sensitive to DIGITS:

```
DIGITS := 20:  
float(17), float(PI/7 + I/4), float(4^(1/3) + sin(7))
```

```
17.0, 0.44879895051282760549 + 0.25 i, 2.2443876506869885651
```

Symbolic objects such as identifiers are returned unchanged:

```
DIGITS := 10: float(2*x + sin(3))
```

```
2.0 x + 0.1411200081
```

## Example 2

We illustrate error propagation in numerical computations. The following rational number approximates  $\exp(2)$  to 17 decimal digits:

```
r := 738905609893065023/100000000000000000:
```

The following `float` call converts `exp(2)` and `r` to floating-point approximations. The approximation errors propagate and are amplified in the following numerical expression:

```
DIGITS := 10: float(10^20*(r - exp(2)))
```

0.0

None of the digits in this result is correct! To obtain a better result, use the second argument in `float` to increase the number of digits for this particular function call:

```
float(10^20*(r - exp(2)), 20)
```

276.9572539

For further calculations, free the variable `r`:

```
delete r:
```

## Example 3

The second argument in `float` lets you temporarily overwrite the current setting for the number of significant decimal digits. For example, compute the following expression with 10 and 30 significant decimal digits. To display floating-point numbers with the number of digits that MuPAD used to compute them, set the value of `Pref::outputDigits` to `InternalPrecision`:

```
Pref::outputDigits(InternalPrecision):
```

Compute the following expression with the default value of `DIGITS = 10`:

```
x := 10^8:
float(sqrt(x^2 + 1) - x)
```

0.000000004889443517

Compute the same expression with 30 significant decimal digits:

```
float(sqrt(x^2 + 1) - x, 30)
```

```
0.00000000499999999999999987500063818977
```

After evaluating `float`, MuPAD restores the value of `DIGITS`:

```
DIGITS
```

```
10
```

For further calculations, restore the output precision and free the variable `x`:

```
Pref::outputDigits(UseDigits):  
delete x
```

## Example 4

`float` is mapped to the elements of sets on page 7-50 and lists on page 7-41:

```
float([PI, 1/7, [1/4, 2], {sin(1), 7/2}])
```

```
[3.141592654, 0.1428571429, [0.25, 2.0], {0.8414709848, 3.5}]
```

For tables on page 1-2103 and arrays on page 7-2, the function `map` must be used to forward `float` to the entries:

```
T := table("a" = 4/3, 3 = PI):  
float(T), map(T, float)
```

3	$\pi$ ,	3	3.141592654
"a"	$\frac{4}{3}$	"a"	1.333333333

```
A := array(1..2, [1/7, PI]):  
float(A), map(A, float)
```

$$\left(\frac{1}{7}\pi\right), (0.1428571429 \ 3.141592654)$$

Matrix domains overload the function `float`. In contrast to arrays, `float` works directly on a matrix on page 1-2045 (Symbolic Math Toolbox):

```
float(matrix(A))
```

$$\begin{pmatrix} 0.1428571429 \\ 3.141592654 \end{pmatrix}$$

Use `mapcoeffs` to apply `float` to the coefficients of a polynomial generated by `poly`:

```
p := poly(9/4*x^2 + PI, [x]): float(p), mapcoeffs(p, float)
```

$$\text{poly}\left(\frac{9}{4}x^2 + \pi, [x]\right), \text{poly}(2.25x^2 + 3.141592654, [x])$$

```
delete A, T, p:
```

## Example 5

We demonstrate overloading of `float` by a function environment. The following function `Sin` is to represent the sine function. In contrast to the `sin` function in MuPAD, `Sin` measures its argument in degrees rather than in radians (i.e.,  $\text{Sin}(x) = \sin(\text{PI}/180*x)$ ). The only functionality of `Sin` is to produce floating point values if the argument is a real float. For all other kinds of arguments, a symbolic function call is to be returned:

```
Sin := proc(x)
begin
  if domtype(x) = DOM_FLOAT then
    return(Sin::float(x));
  else return(procname(args()))
  end_if;
end_proc:
```

The function is turned into a function environment via `funcenv`:

```
Sin := funcenv(Sin):
```

Finally, the "float" attribute is implemented. If the argument can be converted to a real floating-point number, a floating-point result is produced. In all other cases, a symbolic call of Sin is returned:

```
Sin::float := proc(x)
begin
  x := float(x);
  if domtype(x) = DOM_FLOAT then
    return(float(sin(PI/180*x)));
  else return(Sin(x))
  end_if;
end_proc;
```

Now, float evaluation of arbitrary expressions involving Sin is possible:

```
Sin(x), Sin(x + 0.3), Sin(120)
```

```
Sin(x), Sin(x + 0.3), Sin(120)
```

```
Sin(120.0), float(Sin(120)), float(Sin(x + 120))
```

```
0.8660254038, 0.8660254038, Sin(x + 120.0)
```

```
float(sqrt(2) + Sin(120 + sqrt(3)))
```

```
2.264730594
```

```
delete Sin;
```

## Parameters

### object

Any MuPAD object

### n

An integer greater than 1



## Return Values

Floating point number of type `DOM_FLOAT` or `DOM_COMPLEX`, or the input object with exact numbers replaced by floating-point numbers.

## Overloaded By

object

## See Also

### **MuPAD Functions**

`DIGITS` | `Pref::floatFormat` | `Pref::outputDigits` | `Pref::trailingZeroes` | `isolate`

## fname

Get a file's name

### Syntax

```
fname(n)
```

### Description

`fname(n)` returns the name of the file specified by the file descriptor `n`.

The file must have been opened with `fopen`. The call to `fopen` yields the file descriptor `n` representing the file.

The special file descriptor `0` represents no file but output to the user interface instead; `fname(0)` returns `NIL`.

### Examples

#### Example 1

We open a temporary file for writing. This yields the file descriptor `n`:

```
n := fopen(TempFile);
```

```
16
```

We get the file's name. Note that the name depends on the operating system:

```
fname(n);
```

```
"/tmp/mtxM9fPT"
```

## Parameters

**n**

A file descriptor returned by `fopen`: a positive integer

## Return Values

the name of the file: a character string of type `DOM_STRING`, or `NIL`.

## See Also

### **MuPAD Functions**

`fclose` | `finput` | `fopen` | `fprint` | `fread` | `ftextinput`

# fopen

Open file

## Syntax

```
fopen(filename | TempFile, <Read | Write | Append>, <Bin | Text | Raw>, <Encoding = "e
```

## Description

`fopen(filename, format)` opens an existing file for reading in the specified format. An error is raised if no file with the specified name is found or the format of the file does not coincide with the specified format. If the file is in `gzip`-compressed format and its name ends in `".gz"`, it will be transparently uncompressed upon reading.

`fopen(filename)` opens an existing file for reading. The file must hold data in text or MuPAD binary format (optionally compressed), `fopen` automatically identifies the file format in this case. The file must not be used as raw file.

`fopen(filename, mode, format)` opens the file for writing in the specified format if the mode is given as `Read` or `Append`. If no file with the specified name exists, a new file is created. If the filename ends in `".gz"`, all data written to the file will be transparently compressed in `gzip` compatible format.

`fopen(TempFile, format)` creates and opens a temporary file for writing in the specified format. The option `Read` and `Append` are not allowed in this case. If no format is given, `Bin` is used. Use `fname` to query the actual name and location of the temporary file. Cf. "Example 3" on page 1-765 (Symbolic Math Toolbox).

`fopen(..., Encoding = "encodingValue")` uses the specified encoding. For supported encodings, see "Options" on page 1-766 (Symbolic Math Toolbox). You can use this option with the previously specified syntaxes for text files.

In write mode (using one of the options `Write` or `Append`), the environment variable `WRITEPATH` is considered if no temporary file is created. If it has a value, a new file is created (or an existing file is searched for) in the corresponding folder. Otherwise, it is created/searched for in the "working folder."

Note that the meaning of “working folder” depends on the operating system. On Windows systems and on Mac OS X systems, the “working folder” is the folder where MATLAB is installed. On UNIX systems, it is the current working folder in which MATLAB was started. When started from a menu or desktop item, this is typically the user's home folder.

---

**Note** In read mode, `fopen` does not search for files in the folders given by the library path.

---

A temporary file is created in a special folder. This folder and the name of the file are system dependent.

Also absolute path names are processed by `fopen`.

The file descriptor returned by `fopen` can be used by various functions such as `fname`, `fclose`, `fread`, `fprint`, `read`, `write` etc.

A file opened by `fopen` should be closed by `fclose` after use. This holds also for temporary files.

`fopen` accepts its arguments in any order, not only in the order used above.

## Environment Interactions

The function is sensitive to the environment variable `WRITEPATH` when creating files that are not temporary (temporary files are created via `TempFile`). If `WRITEPATH` has a value, in write mode (using the options `Write` or `Append`), the file is created in the corresponding folder. Otherwise, the file is created in the “working folder.” A temporary file is created in a special folder.

When using `Write` or `Append`, `fopen` creates a new file if no file under the given name exists.

## Examples

### Example 1

Open the file `test` for writing. With the option `Write`, it is not necessary that the file `test` exists. By default, the file is opened as a binary file:

```
fid := fopen("test", Write):
```

Write a string to the file and close it:

```
fprint(fid, "a string"):
fclose(fid):
```

Append another string to the file:

```
fid := fopen("test", Append):
fprint(fid, "another string"):
fclose(fid):
```

The binary file cannot be opened as a text file for appending data:

```
fid := fopen("test", Append, Text)
```

**FAIL**

However, it may be opened as a text file with the option `Write`. The existing binary file is overwritten with a text file:

```
fid := fopen("test", Write, Text):
fclose(fid):
delete fid:
```

### Example 2

`fopen` fails to open non-existing files for reading. Here, assume the file “xyz” does not exist:

```
n := fopen("xyz")
```

**FAIL**

Assume the file “test” created in “Example 1” on page 1-764 (Symbolic Math Toolbox) exists. It can be opened for reading successfully:

```
n := fopen("test")
```

```
136
```

```
fclose(n):  
delete n:
```

### Example 3

Open a temporary file, write 10 binary data bytes into it and close it. `fname` is used to query the name of the file:

```
fd := fopen(TempFile, Raw):  
writebytes(fd, [i $ i=1..10]):  
fn := fname(fd):  
fclose(fd):  
fn
```

```
"/tmp/mupad.7aYAp4"
```

Re-open the file and read the data:

```
fd := fopen(fn, Read, Raw):  
readbytes(fd);
```

```
[1, 2, 3, 4, 5, 6, 7, 8, 9, 10]
```

```
fclose(fd):  
delete fd, fn:
```

### Example 4

To specify the encoding to read and write data, use `Encoding`. The `Encoding` option applies only to text files that are opened using a file name and not a file descriptor. Create a temporary file and write the string “abcäöü” in the encoding “UTF-8”:

```
fid := fopen(TempFile, Text, Write, Encoding="UTF-8");
file := fname(fid);
fprintf(Unquoted, fid, "abcäöü");
fclose(fid);
```

Use `ftextinput` to read the data with the specified encoding:

```
ftextinput(file, Encoding="UTF-8")
```

`"abcäöü"`

If you do not specify an encoding, the default system encoding is used. Thus, your output might vary from that shown next. Characters unrecognized by the default system encoding are replaced by the default substitution character for that encoding:

```
fid := fopen(TempFile, Text, Write):
file := fname(fid):
fprintf(Unquoted, fid, "abcäöü"):
fclose(fid):
ftextinput(file)
```

`"abc"`

## Parameters

### **filename**

The name of a file: a character string (Symbolic Math Toolbox) or the flag `TempFile`

## Options

### **TempFile**

`fopen` creates a temporary file in the systems “temp” folder. The name of this file can be queried using `fname`.

### **Append, Read, Write**

With `Read`, the file is opened for reading; with `Write` or `Append`, it is opened for writing. If a file opened for writing does not yet exist, it is created. With `Write`, existing files are



overwritten. With `Append`, new data may be appended to an existing file. Note that in the `Append` mode, the specified format must coincide with the format of the existing file; otherwise, the file cannot be opened and `fopen` returns `FAIL`. If the flag `TempFile` is given, the default mode is `Write`. Otherwise, the default mode is `Read`.

### Bin, Raw, Text

With `Bin`, the data is stored in MuPAD internal binary format. With `Text`, the data may be strings or MuPAD objects stored as text. Newlines are handled according to the conventions of the operating system at hand. With `Raw`, the data is interpreted as binary machine numbers. See the functions `readbytes` and `writebytes`.

If the mode is `Read` or `Append`, the default is the format of the data in the existing file. If the mode is `Write`, the default is `Bin`.

### Encoding

This option lets you specify the character encoding to use. The allowed encodings are:

"Big5"	"ISO-8859-1"	"windows-932"
"EUC-JP"	"ISO-8859-2"	"windows-936"
"GBK"	"ISO-8859-3"	"windows-949"
"KSC_5601"	"ISO-8859-4"	"windows-950"
"Macintosh"	"ISO-8859-9"	"windows-1250"
"Shift_JIS"	"ISO-8859-13"	"windows-1251"
"US-ASCII"	"ISO-8859-15"	"windows-1252"
"UTF-8"		"windows-1253"
		"windows-1254"
		"windows-1257"

The default encoding is system dependent. If you specify the encoding incorrectly, characters might read incorrectly. Characters unrecognized by the encoding are replaced by the default substitution character for the specified encoding.

Encodings not listed here can be specified but might not produce correct results.

## Return Values

a positive integer: the file descriptor. FAIL is returned if the file cannot be opened.

## See Also

### MuPAD Functions

FILEPATH | READPATH | WRITEPATH | fclose | finput | fname | fprint | fread |  
ftextinput | import::readbitmap | import::readdata | pathname | print |  
protocol | read | readbytes | write | writebytes

# forfromtostepend\_for\_for\_indownto\_for\_downto

For loop

---

**Note** To use the for loop in MATLAB®, see for.

---

## Syntax

```
for i from start to stop do
    body
end_for
```

```
for i from start to stop step stepwidth do
    body
end_for
```

```
_for(i, start, stop, stepwidth, body)
```

```
for i from start downto stop do
    body
end_for
```

```
for i from start downto stop step stepwidth do
    body
end_for
```

```
_for_down(i, start, stop, stepwidth, body)
```

```
for x in object do
    body
end_for
```

```
_for_in(x, object, body)
```

## Description

for - end\_for is a repetition statement providing a loop for automatic iteration over a range of numbers or objects.

When entering an incrementing loop

```
for i from start to stop step stepwidth do body end_for,
```

the assignment `i := start` is made. The body is executed with this value of `i` (the body may reassign a new value to `i`). After all statements inside the body are executed, the loop returns to the beginning of the body, increments `i := i + stepwidth` and checks the stopping criterion `i > stop`. If `FALSE`, the body is executed again with the new value of `i`. If `TRUE`, the loop is terminated immediately without executing the body again.

The decrementing loop

```
for i from start downto stop step stepwidth do body end_for
```

implements a corresponding behavior. The only difference is that upon return to the beginning of the body, the loop variable is decremented by `i := i - stepwidth` before the stopping criterion `i < stop` is checked.

The loop `for x in object do body end_for` iterates `x` over all operands on page 1-1493 of the object. This loop is equivalent to

```
for i from 1 to nops(object) do
  x := op(object, i);      body      end_for
```

Typically, `object` may be a list on page 7-41, an expression sequence on page 1-88, an array on page 7-2 or an `hfarray` on page 7-27. Note that other container objects such as finite sets on page 7-50 or tables on page 1-2103 do not have a natural internal ordering, i.e., care must be taken, if the loop expects a certain ordering of the iterative steps.

The body of a loop may consist of any number of statements which must be separated either by a colon `:` or a semicolon `;`. The last evaluated result inside the body is printed on the screen as the return value of the loop. Use `print` inside the loop to see intermediate results.

The loop variable `i`, respectively `x`, may have a value before the loop starts. After the loop is terminated, it has the value that was assigned in the last step of the loop. Typically, in an incrementing or decrementing loop with integer values of `start`, `stop`, and `stepwidth`, this is `i = stop` plus or minus `stepwidth`.

The arguments `start`, `stop`, `stepwidth`, and `object` are evaluated only once at the beginning of the loop and not after every iteration. E.g., if `object` is changed in a step of the loop, `x` still runs through all operands of the original object.

Loops can be exited prematurely using the `break` statement. Steps of a loop can be skipped using the `next` statement. Cf. “Example 2” on page 1-773 (Symbolic Math Toolbox).

The keyword `end_for` may be replaced by the keyword `end`. Cf. “Example 3” on page 1-774 (Symbolic Math Toolbox).

Instead of the the imperative loop statements, the equivalent calls of the functions `_for`, `_for_down`, or `_for_in` may be used. Cf. “Example 4” on page 1-774 (Symbolic Math Toolbox).

The `$`-operator is often a more elegant notation for `for`-loops.

`_for`, `_for_down` and `_for_in` are functions of the system kernel.

## Examples

### Example 1

The body of the following loop consists of several statements. The value of the loop variable `i` is overwritten when the loop is entered:

```
i := 20;
for i from 1 to 3 do
    a := i;
    b := i^2;
    print(a, b)
end_for:
```

1, 1

2, 4

3, 9

The loop variable now has the value that satisfied the stopping criterion  $i > 3$ :

```
i
4
```

The iteration range is not restricted to integers:

```
for i from 2.2 downto 1 step 0.5 do
  print(i)
end_for:
```

```
2.2
```

```
1.7
```

```
1.2
```

The following loop sums up all elements in a list. The return value of the loop is the final sum. It can be assigned to a variable:

```
s := 0: S := for x in [c, 1, d, 2] do s := s + x end_for
```

```
c+d+3
```

Note that for sets on page 7-50, the internal ordering is not necessarily the same as printed on the screen:

```
S := {c, d, 1}
```

```
{1, c, d}
```

```
for x in S do print(x) end_for:
```

```
c
```

*d*

*1*

```
delete a, b, i, s, S, x:
```

## Example 2

Loops can be exited prematurely using the `break` statement:

```
for i from 1 to 3 do
  print(i);
  if i = 2 then break end_if
end_for:
```

*1*

*2*

With the `next` statement, the execution of commands in a step can be skipped. The evaluation continues at the beginning of the body with the incremented value of the loop variable:

```
a := 0;
for i from 1 to 3 do
  a := a + 1;
  if i = 2 then next end_if;
  print(i, a)
end_for:
```

*1, 1*

*3, 3*

```
delete i, a:
```

### Example 3

Loops can be closed with the keyword `end` instead of `end_for`. The parser recognizes the scope of `end` statements automatically.

```
s := 0;
for i from 1 to 3 do
  for j from 1 to 3 do
    s := i + j;
    if i + j > 4 then
      break;
    end
  end
end
end
```

5

```
delete s, i, j;
```

### Example 4

This example demonstrates the correspondence between the functional and the imperative form of `for` loops:

```
hold(
  _for(i, start, stop, stepwidth, (statement1; statement2))
)
```

```
for i from start to stop step stepwidth do
  statement1;
  statement2
end_for
```

The optional `step` clause is omitted by specifying the value `NIL` for the step width:

```
hold(
  _for_down(i, 10, 1, NIL, (x := i^2; x := x - 1))
)
```

```
for i from 10 downto 1 do
  x := i^2;
```



```
x := x - 1
end_for

hold(
  _for_in(x, object, body)
)

for x in object do
  body
end_for
```

## Parameters

### **i, x**

The loop variable: an identifier on page 7-29 or a local variable (DOM\_VAR) of a procedure on page 1-1654

### **start**

The starting value for **i**: a real number. This may be an integer on page 7-31, a rational number on page 7-48, or a floating point number on page 7-23.

### **stop**

The stopping value for **i**: a real number. This may be an integer on page 7-31, a rational number on page 7-48, or a floating point number on page 7-23.

### **stepwidth**

The step width: a positive real number. This may be an integer on page 7-31, a rational number on page 7-48, or a floating-point number on page 7-23. The default value is 1.

### **object**

An arbitrary MuPAD object

### **body**

The body of the loop: an arbitrary sequence of statements

## Return Values

Value of the last command executed in the body of the loop. If no command was executed, the value NIL is returned. If the iteration range is empty, the void object of type DOM\_NULL is returned.

## See Also

### MuPAD Functions

\$ | break | next | repeat | while

## Topics

“Loops” (Symbolic Math Toolbox)

# forceGarbageCollection

Force a garbage collection

## Syntax

```
forceGarbageCollection()
```

## Description

`forceGarbageCollection()` forces a garbage collection to be performed. This function serves a highly technical purpose. Usually, there should be no need for a user to call this function.

Each time the interactive level is reached, the garbage collection routine is called. A heuristic algorithm decides whether a garbage collection is really performed. After a call to `forceGarbageCollection`, a garbage collection will be forced on the next call of the garbage collection routine.

---

**Note** `forceGarbageCollection` does not cause an immediate garbage collection; it is only executed on returning to the interactive level. Therefore, it cannot be used in procedures to release memory during a longer computation.

---

## Examples

### Example 1

When the interactive level is reached, a garbage collection is performed:

```
forceGarbageCollection()
```

## **Return Values**

Void object of type DOM\_NULL.

## **See Also**

### **MuPAD Functions**

bytes

# forget

Clear the remember table of a procedure

## Syntax

```
forget(f)
```

## Description

`forget(f)` clears the remember table of a procedure `f`. The `forget` function clears only remember tables created by the option `remember` on page 1-1654.

The `forget` function clears only remember tables created by the option `remember` on page 1-1654. The function does not affect the remember tables created by `prog::remember`.

Do not call the `forget` function for predefined MuPAD functions. Many predefined MuPAD functions have special values stored in their remember tables. The `forget` function does not throw an error when you call it for a predefined MuPAD function.

The `forget` function does not work recursively. If an inner procedure in a nested procedure uses the option `remember` on page 1-1654, the `forget` function does not clear the remember table created for the inner procedure.

## Examples

### Example 1

If you use the option `remember` on page 1-1654 in a procedure, MuPAD stores all input arguments you used in the procedure calls as indices of the remember table, and the corresponding results as values of these entries. For example, create the following procedure `f` as a wrapper for the MuPAD `sign` function. Use the option `remember` on page 1-1654 to enable the remember mechanism for the procedure `f`:

```
f := proc(x)
option remember;
begin
    sign(x)
end:
```

Now compute the `sign` function for the values -1, 0, and 1:

```
f(-1), f(0), f(1)
```

$-1, 0, 1$

You can define a different value for `sign(0)`. First use the `unprotect` function to be able to overwrite the value of `sign`. Then assign the new value to `sign(0)`:

```
unprotect(sign):
sign(0) := 1/2:
```

Although you specified the new value for `sign(0)`, MuPAD does not recalculate the result of the function call `f(0)`. Instead, the system returns the result stored in the remember table:

```
f(0)
```

$0$

To clear a remember table created by the option `remember`, use the `forget` function:

```
forget(f):
f(0)
```

$\frac{1}{2}$

If you assign a value to a function call, calling the `forget` function also clears that value:

```
f(2) := 1/3:
f(2)
```

$\frac{1}{3}$

```
forget(f):  
f(2)
```

1

For further computations, restore the `sign` function to its default definition. Use the `protect` function with the `ProtectLevelError` option to prevent further changes to `sign`. Also, delete the procedure `f`:

```
sign(0) := 0:  
protect(sign, ProtectLevelError):  
delete f
```

## Parameters

**f**

A procedure or function environment

## Return Values

Void object of domain type `DOM_NULL`

## See Also

### MuPAD Functions

`proc` | `prog` :: `remember`

## Topics

“Clear Remember Tables” (Symbolic Math Toolbox)

# fourier

Fourier transform

## Syntax

`fourier(f, t, w)`

## Description

`fourier(f, t, w)` computes the Fourier transform of the expression  $f = f(t)$  with respect to the variable  $t$  at the point  $w$  and is defined as follows:

$$F(w) = c \int_{-\infty}^{\infty} f(t) e^{i s w t} dt$$

$c$  and  $s$  are parameters of the Fourier transform. By default,  $c = 1$  and  $s = -1$ .

To change the parameters  $c$  and  $s$  of the Fourier transform, use `Pref::fourierParameters`. See “Example 3” on page 1-784 (Symbolic Math

Toolbox). Common choices for the parameter  $c$  are  $1$ ,  $\frac{1}{2\pi}$ , or  $\frac{1}{\sqrt{2\pi}}$ . Common choices for the parameter  $s$  are  $-1$ ,  $1$ ,  $-2\pi$ , or  $2\pi$ .

If `fourier` cannot find an explicit representation of the transform, it returns an unevaluated function call. See “Example 4” on page 1-784 (Symbolic Math Toolbox).

If  $f$  is a matrix, `fourier` applies the Fourier transform to all components of the matrix.

To compute the inverse Fourier transform, use `ifourier`.

To compute the discrete Fourier transform, use `numeric::fft`.



## Environment Interactions

Results returned by `fourier` depend on the current `Pref::fourierParameters` settings.

## Examples

### Example 1

Compute the Fourier transform of this expression with respect to the variable `t`:

```
fourier(exp(-t^2), t, w)
```

$$\sqrt{\pi} e^{-\frac{w^2}{4}}$$

### Example 2

Compute the Fourier transform of this expression with respect to the variable `t` for positive values of the parameter `w0`:

```
assume(w_0 > 0):
F := fourier(t*exp(-w_0^2*t^2), t, w)
```

$$-\frac{w \sqrt{\pi} e^{-\frac{w^2}{4 w_0^2}} i}{2 w_0^3}$$

Evaluate the Fourier transform of the expression at the points  $w = 2 w_0$  and  $w = 5$ . You can evaluate the resulting expression `F` using `|` (or its functional form `evalAt`):

```
F | w = 2*w_0
```

$$-\frac{\sqrt{\pi} e^{-1} i}{w_0^2}$$

Also, you can evaluate the Fourier transform at a particular point directly:

```
fourier(t*exp(-w_0^2*t^2), t, 5)
```

$$-\frac{5\sqrt{\pi}e^{-\frac{25}{4w_0^2}}}{2w_0^3}i$$

### Example 3

The default parameters of the Fourier transform are  $c = 1$  and  $s = -1$ .

```
fourier(t*exp(-t^2), t, w)
```

$$-\frac{w\sqrt{\pi}e^{-\frac{w^2}{4}}}{2}i$$

To change these parameters, use `Pref::fourierParameters` before calling `fourier`:

```
Pref::fourierParameters(1, 1):
```

Evaluate the transform of the same expression with the new parameters:

```
fourier(t*exp(-t^2), t, w)
```

$$\frac{w\sqrt{\pi}e^{-\frac{w^2}{4}}}{2}i$$

For further computations, restore the default values of the Fourier transform parameters:

```
Pref::fourierParameters(NIL):
```

### Example 4

If `fourier` cannot find an explicit representation of the transform, it returns an unevaluated call:

```
fourier(besselJ(1, 1/(1 + t^2)), t, w)
```

$$\text{fourier}\left(J_1\left(\frac{1}{t^2+1}\right), t, w\right)$$

ifourier returns the original expression:

```
ifourier(%, w, t)
```

$$J_1\left(\frac{1}{t^2+1}\right)$$

## Example 5

Compute the following Fourier transforms that involve the Dirac and the Heaviside functions:

```
fourier(t^3, t, w)
```

$$-2\pi\delta'''(w)i$$

```
fourier(heaviside(t - t_0), t, w)
```

$$e^{-t_0 w i} \left( \pi \delta(w) - \frac{i}{w} \right)$$

## Example 6

The Fourier transform of a function is related to the Fourier transform of its derivative:

```
fourier(diff(f(t), t), t, w)
```

$$w \text{fourier}(f(t), t, w) i$$

## Parameters

**f**

Arithmetical expression or unevaluated function call of type `fourier`. If the first argument is a matrix, the result is returned as a matrix.

**t**

Identifier on page 7-29 or indexed identifier on page 1-1017 representing the transformation variable

**w**

Arithmetical expression representing the evaluation point

## Return Values

Arithmetical expression or matrix of such expressions

## Overloaded By

f

## Algorithms

F. Oberhettinger, "Tables of Fourier Transforms and Fourier Transforms of Distributions", Springer, 1990.

## See Also

### MuPAD Functions

`Pref::fourierParameters` | `fourier::addpattern` | `ifourier` | `ifourier::addpattern` | `numeric::fft` | `numeric::invfft`

## **Topics**

“Integral Transforms” (Symbolic Math Toolbox)

## fourier::addpattern

Add patterns for the Fourier transform

### Syntax

```
fourier::addpattern(pat, t, w, res, <vars, <conds>>)
```

### Description

`fourier::addpattern(pat, t, w, res)` teaches `fourier` to return `res` for the expression `pat`.

The `fourier` function uses a set of patterns for computing Fourier transforms. You can extend the set by adding your own patterns. To add a new pattern to the pattern matcher, use `fourier::addpattern`. MuPAD does not save custom patterns permanently. The new patterns are available in the *current* MuPAD session only.

After the call `fourier::addpattern(pat, t, w, res)`, the `fourier` function returns `res` for the expression `pat`. Note that the Fourier transform is defined as

$c \int_{-\infty}^{\infty} \text{pat} e^{i w t} dt$ , where `c` and `s` are the parameters specified by `fourierParameters`. If you add a new pattern, and then change the Fourier transform parameters, the result returned by `fourier(pat, t, w)` will also change. See “Example 2” on page 1-790 (Symbolic Math Toolbox).

Variable names that you use when calling `fourier::addpattern` can differ from the names that you use when calling `fourier`. See “Example 3” on page 1-790 (Symbolic Math Toolbox).

You can include a list of free parameters and a list of conditions on these parameters. These conditions and the result are protected from premature evaluation. This means that you can use `not iszero(a^2 - b)` instead of `hold( _not @ iszero )(a^2 - b)`.

The following conditions treat assumptions on identifiers differently:

- $a^2 - b < 0$  takes into account assumptions on identifiers.
- `not iszero(a^2 - b)` disregards assumptions on identifiers.

See “Example 4” on page 1-791 (Symbolic Math Toolbox) and “Example 5” on page 1-791 (Symbolic Math Toolbox).

## Environment Interactions

The Fourier pair (`pat`, `res`) holds only for the current values of the Fourier transform parameters specified by `Pref::fourierParameters`.

Calling `fourier::addpattern` can change the expressions returned by future calls to `fourier` and `ifourier` in the current MuPAD session.

## Examples

### Example 1

Compute the Fourier transform of the function `foo`. By default, MuPAD does not have a pattern for this function:

```
fourier(foo(t), t, w)
```

```
fourier(foo(t), t, w)
```

Add a pattern for the Fourier transform of `foo` using `fourier::addpattern`:

```
fourier::addpattern(foo(t), t, w, bar(w)):
```

Now `fourier` returns the Fourier transform of `foo`:

```
fourier(foo(t), t, w)
```

```
bar(w)
```

After you add a new transform pattern, MuPAD can use that pattern indirectly:

```
fourier(t^3 + a*foo(2*t - 4), t, w)
```

$$-2 \pi \delta'''(w) i + \frac{a \operatorname{bar}\left(\frac{w}{2}\right) e^{-2 w i}}{2}$$

## Example 2

Add this new Fourier transform pattern for the function `foo`:

```
fourier::addpattern(foo(t), t, w, bar(w)):
fourier(foo(t), t, w)
```

`bar(w)`

Now change the Fourier transform parameters using `Pref::fourierParameters`:

```
Pref::fourierParameters(a, b):
```

Evaluate the transform with the new parameters:

```
fourier(foo(t), t, w)
```

`a bar(-b w)`

For further computations, restore the default values of the Fourier transform parameters:

```
Pref::fourierParameters(NIL):
```

## Example 3

Define the Fourier transform of `foo(x)` using the variables `x` and `y` as parameters:

```
fourier::addpattern(foo(x), x, y, bar(y)):
```

The `fourier` function recognizes the added pattern even if you use other variables as parameters:

```
fourier(foo(t), t, w)
```



$$\text{bar}(w)$$

### Example 4

Use assumptions when adding the following pattern for the Fourier transform:

```
fourier::addpattern(foo(x, t), t, w, bar(x, w), [x], [abs(x) < 1]):
fourier(foo(x, t), t, w) assuming -1 < x < 1
```

$$\text{bar}(x, w)$$

If  $|x| \geq 1$ , you cannot apply this pattern:

```
fourier(foo(x, t), t, w) assuming x > 1
```

$$\text{fourier}(\text{foo}(x, t), t, w)$$

If MuPAD cannot determine whether the conditions are satisfied, it returns a *piecewise* object:

```
fourier(foo(x, t), t, w)
```

$$\{ \text{bar}(x, w) \text{ if } |x| < 1$$

### Example 5

Add this pattern for the Fourier transform of  $f$ :

```
fourier::addpattern(f(a, t), t, w, g(a, w)/a):
fourier(f(a, T), T, W)
```

$$\frac{g(a, W)}{a}$$

This pattern holds only when the first argument of  $f$  is the symbolic parameter  $a$ . If you use any other value of this parameter, `fourier` ignores the pattern:

```
fourier(f(b, T), T, W);  
fourier(f(2, T), T, W)
```

$\text{fourier}(f(b, T), T, W)$

$\text{fourier}(f(2, T), T, W)$

To use the pattern for arbitrary values of the parameter, declare the parameter  $a$  as an additional pattern variable:

```
fourier::addpattern(f(a, t), t, w, g(a, w)/a, [a]):
```

Now `fourier` applies the specified pattern for an arbitrary value of  $a$ :

```
fourier(f(2, T), T, W)
```

$\frac{g(2, W)}{2}$

```
fourier(f(a^2 + 1, T), T, W)
```

$\frac{g(a^2 + 1, W)}{a^2 + 1}$

Note that the resulting expression  $g(a, w)/a$  defining the Fourier transform of  $f(a, t)$  implicitly assumes that the value of  $a$  is not zero. A strict definition of the pattern is:

```
fourier::addpattern(f(a, t), t, w, g(a, w)/a, [a], [a <> 0]):
```

For this particular pattern, you can omit specifying the assumption  $a \neq 0$  explicitly. If  $a = 0$ , MuPAD throws an internal “Division by zero.” error and ignores the pattern:

```
fourier(f(0, T), T, W)
```

$\text{fourier}(f(0, T), T, W)$

## Parameters

### **pat**

Arithmetical expression (Symbolic Math Toolbox) in the variable **t** representing the pattern to match

### **t**

Identifier on page 7-29 or indexed identifier on page 1-1017 used as a variable in the pattern

### **w**

Identifier on page 7-29 or indexed identifier on page 1-1017 used as a variable in the result

### **res**

Arithmetical expression in the variable **w** representing the pattern for the result of the transform

### **vars**

List of identifiers on page 7-29 or indexed identifiers on page 1-1017 used as “pattern variables” (placeholders in **pat** and **res**). You can use pattern variables as placeholders for almost any MuPAD expressions not containing **t** or **w**. You can restrict them by conditions given in the optional parameter **conds**.

### **conds**

List of conditions on the pattern variables

## Return Values

Object of type `DOM_NULL`

## See Also

### MuPAD Functions

`fourier` | `ifourier` | `ifourier::addpattern`

### Topics

“Use Custom Patterns for Transforms” (Symbolic Math Toolbox)

# fprintf

Write data to file

## Syntax

```
fprintf(<Unquoted | NoNL>, <Bin | Text>, <Encoding = "encodingValue">, filename, <object>
```

```
fprintf(<Unquoted | NoNL>, <Encoding = "encodingValue">, n, <object1, object2, ...>
```

## Description

`fprintf(f, objects)` writes MuPAD objects to the file `f`. The objects are evaluated, the results are stored in the file. These data can be read into another MuPAD session via the functions `finput` and `ftextinput`, respectively.

`fprintf(Encoding = "encodingValue", f, objects)` uses the specified encoding. For supported encodings, see “Options” on page 1-800 (Symbolic Math Toolbox).

The file may be specified directly by its name. In this case, `fprintf` creates a new file or overwrites an existing file. `fprintf` opens and closes the file automatically.

If `WRITEPATH` does not have a value, `fprintf` interprets the file name as a path name relative to the “working folder.”

Note that the meaning of “working folder” depends on the operating system. On Windows systems and on Mac OS X systems, the “working folder” is the folder where MATLAB is installed. On UNIX systems, it is the current working folder in which MATLAB was started; when started from a menu or desktop item, this is typically the user's home folder.

Also absolute path names are processed by `fprintf`.

If the filename given ends in “.gz”, MuPAD automatically writes a compressed file in `gzip` format. These files are transparently uncompressed when read in again by MuPAD. The `gzip` format is supported by many other programs as well. See “Example 5” on page 1-799 (Symbolic Math Toolbox).

Instead of a file name, also a file descriptor of a file opened via `fopen` can be used. See “Example 2” on page 1-797 (Symbolic Math Toolbox). In this case, the data written by `fprint` are appended to the corresponding file. The file is not closed automatically by `fprint` and must be closed by a subsequent call to `fclose`.

Note that `fopen(filename)` opens the file in read-only mode. A subsequent `fprint` command to this file causes an error. Use the `Write` or `Append` option of `fopen` to open the file for writing.

---

**Note** The file descriptor `0` represents the screen. See “Example 4” on page 1-798 (Symbolic Math Toolbox).

---

Text output occurs without the Pretty-Printer on page 1-1632. A call to `fprint` writes all specified objects into a single line of the text file. A newline character is appended to this line, unless the option `NoNL` is used. By default, the written objects are separated by colons without any further white space. The resulting text data consists of syntactically correct MuPAD code and can be read again using `finput`. With the options `Unquoted` and `NoNL`, neither white space no colons are inserted to separate the objects. The resulting text data cannot be read again using `finput`. See “Example 3” on page 1-797 (Symbolic Math Toolbox).

## Environment Interactions

The function is sensitive to the environment variable `WRITEPATH`. If this variable has a value, the file is created in the corresponding folder. Otherwise, the file is created in the “working folder”.

## Examples

### Example 1

Write some data to the file “test”. By default, this file is created as a binary file:

```
fid := fopen(TempFile, Write, Text):  
d := 5:  
fprint(fid, d, d*3):
```

```
file := fname(fid):  
fclose(fid)
```

The file is read into the MuPAD session:

```
finput(file, e, f): d, e, f;
```

```
5, 5, 15
```

```
delete d, e, f:
```

## Example 2

Use a file descriptor to access the file `test`. Several calls to `fprint` append data to the file:

```
n := fopen(file, Write):  
fprint(n, (d := 5), d*3):  
fprint(n, "more data"):
```

Using a file descriptor, call `fclose` to close the file:

```
fclose(n):
```

The file is read into the MuPAD session, assigning the stored values to the identifiers `e`, `f`, and `g`:

```
finput(file, e, f, g ): e, f, g;
```

```
5, 15, "more data"
```

```
delete n, d, e, f, g:
```

## Example 3

With the option `Unquoted`, character strings are written without quotation marks:

```
fid1 := fopen(TempFile):  
fid2 := fopen(TempFile):  
file1 := fname(fid1):  
file2 := fname(fid2):
```

```
fprint(Text, file1, "Hello World!", MuPAD + 1):  
fprint(Unquoted, Text, file2, "Hello World!", MuPAD + 1):
```

Creates temporary files have the following content:

```
"Hello World!":MuPAD + 1:
```

```
Hello World!MuPAD + 1
```

Use `finput` or `ftextinput` to read the data from the file:

```
finput(file1, a, b):  
a, b;
```

```
"Hello World!", MuPAD + 1
```

```
ftextinput(file2, c): c
```

```
"Hello World!MuPAD + 1"
```

```
delete a, b, c;
```

## Example 4

Typically, the `print` function serves for displaying objects on screen. If the object produces a line that is longer than the `TEXTWIDTH` setting, `print` breaks that line into shorter lines and inserts the line continuation characters. To avoid inserting line continuation characters, display long objects on screen by using the `fprint` function with the file descriptor 0. For example, convert the following expression to a TeX formatted string. When you use the `print` function, the resulting string contains the line continuation character (`\`):

```
print(Unquoted, generate::TeX(diff(1/ln(1/x), x$4)))
```

```
\frac{22}{x^4, {\ln\left(\frac{1}{x}\right)}^3}-\frac{6}{x^4, {\ln\left(\frac{1}{x}\right)}^2}-\frac{36}{x^4, {\ln\left(\frac{1}{x}\right)}^4}+\frac{ac{24}}{x^4, {\ln\left(\frac{1}{x}\right)}^5}
```



If you want to use the generated string in TeX, you must remove these additional characters. Also, you can generate the string without these characters by using the `fprint` function:

```
fprint(Unquoted, 0, generate::TeX(diff(1/ln(1/x), x$4)))
```

```
\frac{22}{x^4}, {\ln\left(\frac{1}{x}\right)}^3 - \frac{6}{x^4}, {\ln\left(\frac{1}{x}\right)}
```

Another way to avoid line continuation characters is to increase the `TEXTWIDTH` setting:

```
defaultWidth := TEXTWIDTH:
TEXTWIDTH := 250:
print(Unquoted, generate::TeX(diff(1/ln(1/x), x$4)));
TEXTWIDTH := defaultWidth:
```

```
\frac{22}{x^4}, {\ln\left(\frac{1}{x}\right)}^3 - \frac{6}{x^4}, {\ln\left(\frac{1}{x}\right)}
```

## Example 5

When writing to a file with a name ending in “.gz”, MuPAD creates a compressed file automatically. On a UNIX system, the `file` command can be used to verify this:

```
fprint(Text, "test.gz", "test");
system("file test.gz");
```

```
test.gz: gzip compressed data, from Unix
```

Reading the file from MuPAD does not show a difference, because gzip-compressed files are automatically uncompressed in memory by MuPAD:

```
ftextinput("test.gz")
```

```
""test"":"
```

## Example 6

To specify the encoding to write data, use `Encoding`. The `Encoding` option applies only to text files that are opened using a file name and not a file descriptor. Create a file and write the string “abcäöü” in the encoding “UTF-8”:

```
fprint(Unquoted, Text, Encoding="UTF-8", "fprint_test", "abcäöü");
```

Use `ftextinput` to read the data with the specified encoding:

```
ftextinput("fprint_test", Encoding="UTF-8")
```

```
"abcäöü"
```

If you do not specify an encoding, the default system encoding is used. Thus, your output might vary from that shown next. Characters unrecognized by the default system encoding are replaced by the default substitution character for that encoding:

```
fprint(Unquoted, Text, "fprint_test", "abcäöü");  
ftextinput("fprint_test")
```

```
"abc"
```

## Parameters

### **filename**

The name of a file: a character string on page 7-53

### **object<sub>1</sub>, object<sub>2</sub>, ...**

Arbitrary MuPAD objects

### **n**

A file descriptor provided by `fopen`: a nonnegative integer

## Options

### **Unquoted**

With this option, character strings on page 7-53 are displayed without quotation marks. Moreover, the control characters `'\n'` (or `'\r\n'` in Windows), `'\t'`, and `'\\'` in strings are expanded into a new line, a tabulator skip, and a single backslash `\`,

respectively. Furthermore, no colons are inserted between the objects. A newline character is appended to the line written by `fprint`.

This option is relevant for text files only. It is useful for writing user-formatted text files. Data written with this option cannot be read again via `finput`.

### **NoNL**

This option has the same functionality as `Unquoted`, with the only difference that no newline character is appended to the line written by `fprint`.

### **Bin, Text**

With `Bin`, the data is stored in MuPAD binary format. With `Text`, standard ASCII format is used. The default is `Bin`.

### **Encoding**

This option lets you specify the character encoding to use. The allowed encodings are:

"Big5"	"ISO-8859-1"	"windows-932"
"EUC-JP"	"ISO-8859-2"	"windows-936"
"GBK"	"ISO-8859-3"	"windows-949"
"KSC_5601"	"ISO-8859-4"	"windows-950"
"Macintosh"	"ISO-8859-9"	"windows-1250"
"Shift_JIS"	"ISO-8859-13"	"windows-1251"
"US-ASCII"	"ISO-8859-15"	"windows-1252"
"UTF-8"		"windows-1253"
		"windows-1254"
		"windows-1257"

The default encoding is system dependent. If you specify the encoding incorrectly, characters might read incorrectly. Characters unrecognized by the encoding are replaced by the default substitution character for the specified encoding.

Encodings not listed here can be specified but might not produce correct results.

## Return Values

Void object of type DOM\_NULL.

## See Also

### MuPAD Functions

READPATH | WRITEPATH | doprint | expr2text | fclose | finput | fname | fopen |  
fread | ftextinput | import::readbitmap | import::readdata | pathname |  
print | protocol | read | write

# frac

Fractional part of a number

## Syntax

`frac(x)`

## Description

`frac(x)` represents the “fractional part”  $x - \text{floor}(x)$  of the number  $x$ .

For complex arguments, `frac` is applied separately to the real and imaginary part.

For real numbers, the value  $x - \text{floor}(x)$  represented by `frac(x)` is a number from the interval  $[0, 1)$ . For positive arguments, you may think of `frac` as truncating all digits before the decimal point.

For integer arguments,  $0$  is returned. For rational arguments, a rational number is returned. For arguments that contain symbolic identifiers, symbolic function calls are returned. For floating-point arguments or non-rational exact expressions, floating-point values are returned.

---

**Note** If the argument is a floating-point number of absolute value larger than  $10^{\text{DIGITS}}$ , then the result is affected by internal non-significant digits! Cf. “Example 2” on page 1-805 (Symbolic Math Toolbox).

---

---

**Note** Exact numerical data that are neither integers nor rational numbers are approximated by floating-point numbers. For such arguments, the result depends on the present value of `DIGITS`! Cf. “Example 3” on page 1-805 (Symbolic Math Toolbox).

---

## Environment Interactions

The function is sensitive to the environment variable DIGITS which determines the numerical working precision.

## Examples

### Example 1

We demonstrate the fractional part of real and complex numbers:

```
frac(1234), frac(123/4), frac(1.234)
```

$0, \frac{3}{4}, 0.234$

```
frac(-1234), frac(-123/4), frac(-1.234)
```

$0, \frac{1}{4}, 0.766$

```
frac(3/2 + 7/4*I), frac(4/3 + 1.234*I)
```

$\frac{1}{2} + \frac{3}{4}i, 0.3333333333 + 0.234i$

The fractional part of a symbolic numerical expression is returned as a floating-point value:

```
frac(exp(123)), frac(3/4*sin(1) + I*tan(3))
```

$0.7502040793, 0.6311032386 + 0.8574534569i$

Expressions with symbolic identifiers produce symbolic function calls:

```
frac(x), frac(sin(1) + x^2), frac(exp(-x))
```



Note that the exact value of this number is  $\frac{1}{3}$ . Floating-point evaluation can be subject to severe cancellation:

```
DIGITS := 24: frac(x)
```

```
0.765625
```

The floating-point result is more accurate when a higher precision used:

```
DIGITS := 30: frac(x)
```

```
0.3333336412906646728515625
```

```
delete x, DIGITS:
```

## Parameters

**x**

An arithmetical expression (Symbolic Math Toolbox)

## Return Values

Arithmetical expression.

## Overloaded By

**x**

## See Also

**MuPAD Functions**

floor



# frandom

Generate random floating-point numbers

## Syntax

```
frandom()
```

```
frandom(seed)
```

## Description

`frandom()` returns a pseudo-random floating point number from the interval `[0.0, 1.0)`.

`frandom(seed)` returns a generator of pseudo-random floating-point numbers from the interval `[0.0, 1.0)`.

The calls `frandom()` produce uniformly distributed floating-point numbers from the interval `[0.0, 1.0)`.

`r := frandom(seed)` produces a random number generator `r`. Subsequent calls `r()` return uniformly distributed floating-point numbers from the interval `[0.0, 1.0)`.

Different generators created with the same integer seed generate the same sequences of numbers. See “Example 3” on page 1-809 (Symbolic Math Toolbox) and “Example 4” on page 1-810 (Symbolic Math Toolbox).

Generators created with `currentTime` use the time (in milliseconds) at their creation as their seed values. Generators created shortly after one another may thus return the same numbers.

Generators created in separate calls to `frandom` do not influence one another.

As for all functions returning floating point numbers on page 7-23, `frandom` reacts to `DIGITS` and returns numbers with the precision set by this variable.

Each time MuPAD is started or re-initialized with the `reset` function, random generators not using `currentTime` produce the same sequence of numbers.

`frandom` is the recommended function for generating uniform random floating-point numbers. It is much faster than the function `random` which produces uniform integer numbers.

---

**Note** In contrast to `random`, `frandom` does not react to the environment variable `SEED`.

---

The function `stats::uniformRandom` allows to produce uniformly distributed floating-point numbers on arbitrary finite intervals. The `stats` (Symbolic Math Toolbox) library also provides random generators with various other distributions.

## Environment Interactions

`frandom` and the procedures returned by `frandom` are sensitive to the environment variable `DIGITS` which determines the numerical working precision.

`frandom` changes its internal state when generating a number and will thus produce a different number on the next call.

## Examples

### Example 1

The following call produces a sequence of pseudo-random numbers. Note that an index variable `i` must be used in the construction of the sequence. A call such as `frandom()` `$8` would produce 8 copies of the same random value:

```
frandom() $ i = 1..8
```

```
0.2703581656, 0.8310371787, 0.153156516, 0.9948127808, 0.2662729021, 0.1801642277,  
0.452083055, 0.6787819563
```

## Example 2

frandom reacts to DIGITS, producing numbers which are equally random in the later digits as in the beginning ones:

```
DIGITS := 200: frandom(), frandom()
```

```
0.35498492614062364307860547970996890040547017454106048832367331188029835842\  
27029727411896836702858650814631791808332062056930317481739099669179608637\  
41983372438295957637072221133042671258687811047868160.68185881324271781264\  
13695516220558017777650094725776810670342423655782682739382577269197633858\  
28136732071838674370991881544393470550284198189826692626896977688203057551\  
87767262954763679738221015322211
```

```
delete DIGITS:
```

## Example 3

frandom(seed), for some integer value of seed, returns a generator of floating-point numbers. For different generators created with the same seed, the sequences of numbers will be identical (apart from the digits cut off when producing numbers at lower settings of DIGITS):

```
r1 := frandom(42):  
r2 := frandom(42):  
r3 := frandom(42):  
r1() $ i=1..4;  
r2() $ i=1..4;  
DIGITS := 20:  
r3() $ i=1..4;
```

```
0.9239565296, 0.7847883691, 0.1939738073, 0.8908726445
```

```
0.9239565296, 0.7847883691, 0.1939738073, 0.8908726445
```

```
0.92395652959956197579, 0.78478836910657330549, 0.19397380730447780085,  
0.89087264450316274217
```

```
delete r1, r2, r3, DIGITS:
```

## Example 4

Usually, `frandom` is used to generate experimental input or “random” examples. In these cases, reproducibility is a good thing. However, on occasion a “more random” sequence is desirable. The usual way to get a random seed in a program is to use the current system time, which can be done by using `CurrentTime` as the value of `seed`:

```
r := frandom(CurrentTime):
```

```
r(), r(), r(), r()
```

```
0.794272125, 0.9179931363, 0.2210726413, 0.7790319119
```

## Parameters

### **seed**

An initialization value for the generator: an integer or the option `CurrentTime`

## Return Values

`frandom()` returns a floating point number on page 7-23; `frandom(seed)` returns a procedure on page 1-1654 (a pseudo-random number generator).

## Algorithms

`frandom` uses a linear congruence generator to directly manipulate the internal representation of a `DOM_FLOAT`.

## See Also

### MuPAD Functions

random | stats::uniformRandom

## fread

Read and execute file

### Syntax

```
fread(filename | n, <Quiet>, <Plain>, <Encoding = "encodingValue">)
```

### Description

`fread(file)` reads and executes a MuPAD file.

`fread(filename)` reads the file and evaluates each MuPAD statement in the file. If the filename ends in “.gz” and the file is in gzip-compressed format, it will be transparently uncompressed upon reading. `fread` automatically opens the file, performs the read operation, and closes the file.

`fread(..., Encoding = "encodingValue")` uses the specified encoding. For supported encodings, see “Options” on page 1-816 (Symbolic Math Toolbox). You can use this option with the previously specified syntaxes.

`fread` is similar to `read`. The only difference is that `fread` does not search for files in the folders given by `READPATH` and by the library path; `fread` only searches for the file relative to the “working folder.”

Note that the meaning of “working folder” depends on the operating system. On Windows systems and on Mac OS X systems, the “working folder” is the folder where MATLAB is installed. On UNIX systems, it is the current working folder in which MATLAB was started. When started from a menu or desktop item, this is typically the user's home folder.

Also absolute path names are processed by `fread`.

`fread` can read MuPAD binary files (created via `fprint` or `write`) as well as ASCII text files. `fread` recognizes the format of the file automatically.

Instead of a file name, a file descriptor of a file opened via `fopen` can also be used. See “Example 3” on page 1-815 (Symbolic Math Toolbox). When a file descriptor is used,

fread does not automatically open and close the file. fclose must be used to close the file.

When a file is read with fread, the variable FILEPATH contains the path of the file.

## Examples

### Example 1

Create a new file in the system's temporary folder. The name of the temporary folder varies for different platforms. The fopen command with the TempFile option creates a file in any system's temporary folder (if such folder exists):

```
fid := fopen(TempFile, Write, Text):  
fprintf(Unquoted, fid, "a := 3; b := 5; a + b;");
```

Use fname to return the name of the temporary file you created. Use fclose to close the file:

```
file := fname(fid):  
fclose(fid)
```

When reading the file, MuPAD executes the statements. Each produces a print output. The second 8 below is the return value of fread:

```
delete a, b:  
fread(file);
```

3

5

8

8

Now, the variables a and b have the values assigned inside the file:

```
a, b
```

```
3, 5
```

With the option `Quiet`, only the return value of `fread` is printed:

```
delete a, b:  
fread(file, Quiet)
```

```
8
```

```
delete a, b:
```

## Example 2

The next example demonstrates the option `Plain`. First, an appropriate input file is created:

```
fid := fopen(TempFile, Write, Text):  
fprintf(Unquoted, fid,  
        "f := proc(x) begin x^2 end_proc:",  
        "a := f(3): b := f(4):"):  
file := fname(fid):  
fclose(fid)
```

Define an `alias` for `f`:

```
alias(f = "some text"):
```

An error occurs if you try to read the file without the option `Plain`. In the parser context of the MuPAD session, the alias replaces `f` by the corresponding string in the assignment `f := ...`. However, strings cannot be assigned a value:

```
fread(file)
```

```
Error: Invalid left-hand side. [_assign]  
Reading File: /tmp/mupad.351omQ
```

With the option `Plain`, no such error arises: the alias for `f` is ignored by `fread`:



```
fread(file, Plain):
a, b
```

9, 16

```
unalias(f):
delete f, a, b:
```

### Example 3

You use `write` to save the value of the identifier `a` in a temporary file:

```
a := PI + 1:
fid := fopen(TempFile, Write, Text):
file := fname(fid):
write(file, a):
delete a:
```

This file is opened for reading with `fopen`:

```
n := fopen(file):
```

The file descriptor returned by `fopen` can be passed to `fread`. Reading the file restores the value of `a`:

```
fread(n):
a
```

$\pi + 1$

```
fclose(n):
delete a:
```

### Example 4

To specify the encoding for reading data, use `Encoding`. The `Encoding` option applies only to text files that are opened using a file name and not a file descriptor. Open a temporary file and write the statement `str := "abcäöü"` in the encoding "UTF-8":

```
fprint(Unquoted, Text, Encoding="UTF-8",  
      "fread_test",  
      "str := \"abcäöü\"")
```

Specify the encoding to read the file. `fread` executes the statement:

```
fread("fread_test", Encoding="UTF-8"):
```

```
"abcäöü"
```

If you do not specify an encoding, the default system encoding is used. Thus, your output might vary from that shown next. Characters unrecognized by the default system encoding are replaced by the default substitution character for that encoding:

```
fread("fread_test"):
```

```
"abc?????"
```

## Parameters

### **filename**

The name of a file: a character string on page 7-53

### **n**

A file descriptor provided by `fopen`: a positive integer

## Options

### **Plain**

Makes `fread` use its own parser context

With this option, the file is read in a new parser context. This means that the history, as returned by the command `history`, is not modified by the statements in the file. Further, abbreviations set outside the file via `alias` or user-defined operators on page 1-1505 are

ignored during the execution of the file. This option is useful for reading initialization files in a clean environment.

### Quiet

Suppresses output during execution of `fread`

With this option, output is suppressed while reading and executing the file. However, warnings and error messages as well as the output of `print` commands are still visible.

### Encoding

This option lets you specify the character encoding to use. The allowed encodings are:

"Big5"	"ISO-8859-1"	"windows-932"
"EUC-JP"	"ISO-8859-2"	"windows-936"
"GBK"	"ISO-8859-3"	"windows-949"
"KSC_5601"	"ISO-8859-4"	"windows-950"
"Macintosh"	"ISO-8859-9"	"windows-1250"
"Shift_JIS"	"ISO-8859-13"	"windows-1251"
"US-ASCII"	"ISO-8859-15"	"windows-1252"
"UTF-8"		"windows-1253"
		"windows-1254"
		"windows-1257"

The default encoding is system dependent. If you specify the encoding incorrectly, characters might read incorrectly. Characters unrecognized by the encoding are replaced by the default substitution character for the specified encoding.

Encodings not listed here can be specified but might not produce correct results.

## Return Values

Return value of the last statement of the file.

## See Also

### **MuPAD Functions**

FILEPATH | READPATH | WRITEPATH | fclose | finput | fname | fopen | fprintf |  
ftextinput | import::readbitmap | import::readdata | input | pathname |  
print | protocol | read | textinput | write

# freeIndets

Free indeterminates of an expression

## Syntax

```
freeIndets(object, <All>)
```

## Description

`freeIndets(object)` returns the free indeterminates of `object` as a set on page 7-50.

An identifier occurring in `object` is free if it cannot be replaced by another identifier without changing the mathematical meaning of `object`.

By default, `freeIndets` does not return free identifiers that occur only in the 0th operand of subexpressions of `object`.

The special identifiers `PI`, `EULER`, `CATALAN` are not free indeterminates. See “Example 1” on page 1-819 (Symbolic Math Toolbox).

If `object` is a polynomial on page 1-1601, a function environment on page 7-25, a procedure on page 7-45, or a built-in kernel function on page 7-18, then `freeIndets` returns the empty set. See “Example 3” on page 1-820 (Symbolic Math Toolbox).

## Examples

### Example 1

Find free identifiers in the following image set. In this set, `PI` is a mathematical constant; therefore, it is not a free identifier. The operand `f` is a 0th operand. The variable `k` is not a free identifier because you can replace it by any other letter like `m` or `n` without changing the mathematical meaning. Therefore, only `u` is a free identifier:

```
e := Dom::ImageSet(k*f(u)+PI, k, Z_)
```

$$\{\pi + k f(u) \mid k \in \mathbb{Z}\}$$

```
freeIndets(e)
```

$$\{u\}$$

To find all identifiers in the same image set, use `indets`:

```
indets(e)
```

$$\{k, u, \pi\}$$

## Example 2

Use the `All` option to return free identifiers including the 0th operands of subexpressions. For example, compare the sets of free identifiers returned by `freeIndets` with the `All` option and without this option:

```
e := Dom::ImageSet(k*f(u)+PI, k, Z_):  
freeIndets(e, All);  
freeIndets(e)
```

$$\{\_mult, \_plus, f, u\}$$
$$\{u\}$$

## Example 3

`freeIndets` assumes that polynomials and functions do not have free indeterminates:

```
delete x, y:  
freeIndets(poly(x*y, [x, y])),  
freeIndets(sin),  
freeIndets(x -> x^2+1)
```

$\emptyset, \emptyset, \emptyset$ 

## Parameters

### **object**

An arbitrary object

## Options

### **ALL**

Do not exclude free identifiers that occur in the 0th operand of subexpressions of object.

With this option, `freeIndets` does not exclude the 0th operand. If the 0th operand of a subexpression is an indeterminate, such as `sin`, the `freeIndets` function includes this operand in the result. See “Example 2” on page 1-820 (Symbolic Math Toolbox).

## Return Values

set on page 7-50 of identifiers on page 7-29.

## Overloaded By

object

## Algorithms

If `object` is an element of a library domain (Symbolic Math Toolbox) `T` that has a slot “`freeIndets`”, then MuPAD calls the slot routine `T::freeIndets` with `object` as an argument. You can use this approach to extend the functionality of `freeIndets` to user-

defined domains. If no such slot exists, then `freeIndets` regards all identifiers occurring in elements of that domain as free, with the exception of mathematical constants.

## See Also

### **MuPAD Functions**

`Type::Indeterminate` | `domtype` | `indets` | `op` | `type`



# freeze

Create an inactive copy of a function

## Syntax

```
freeze(f)
```

## Description

`freeze(f)` creates an inactive copy of the function `f`.

`ff := freeze(f)` returns a function that is an “inactive” copy of the argument `f`. This means:

- 1 `ff` only evaluates its arguments, but does not compute anything else,
- 2 `ff` is printed on page 1-1636 in the same way as `f`,
- 3 symbolic `ff` calls have the same type on page 1-2189 as symbolic `f` calls,
- 4 if `f` is a function environment on page 7-25, then `ff` has all the slots on page 1-1980 of `f`.

`ff` evaluates its incoming parameters even if the function `f` has the procedure option on page 1-2014 (Symbolic Math Toolbox) `hold`.

Use `freeze` when you want to perform many operations with `f` that require `f` only in its symbolic form, but `f` need not be executed.

Neither `eval` nor `level` can enforce the evaluation of an inactive function. See “Example 2” on page 1-824 (Symbolic Math Toolbox).

## Examples

### Example 1

Create an inactive form of the function environment `int`:

```
_int := freeze(int): F := _int(x*exp(x^2), x = 0..1)
```

$$\int_0^1 x e^{x^2} dx$$

The inactive form of `int` keeps all information that is known about the function `int`, for example, the output, the type, and the `float` slot for floating-point evaluation:

```
F, type(F), float(F)
```

$$\int_0^1 x e^{x^2} dx, \text{"int"}, 0.8591409142$$

The original function environment `int` is not modified by `freeze`:

```
int(x*exp(x^2), x = 0..1)
```

$$\frac{e}{2} - \frac{1}{2}$$

Use `unfreeze` to reactivate the inactive function `_int` and evaluate the result:

```
unfreeze(F), unfreeze(F + 1/2)
```

$$\frac{e}{2} - \frac{1}{2}, \frac{e}{2}$$

## Example 2

This example shows the difference between `hold` and `freeze`. The result of the command `S := hold(sum)(...)` does not contain an inactive version of `sum`, but the unevaluated identifier on page 7-29 `sum`:

```
S := hold(sum)(1/n^2, n = 1..infinity)
```

$$\sum_{n=1}^{\infty} \frac{1}{n^2}$$

The next time S is evaluated, the identifier sum is replaced by its value, the function environment on page 7-25sum, and the procedure computing the value of the infinite sum is invoked:

S

$$\frac{\pi^2}{6}$$

In contrast, evaluation of the result of freeze does not lead to an evaluation of the inactive function:

`S := freeze(sum)(1/n^2, n = 1..infinity)`

$$\sum_{n=1}^{\infty} \frac{1}{n^2}$$

S

$$\sum_{n=1}^{\infty} \frac{1}{n^2}$$

An inactive function does not react to eval:

`eval(S)`

$$\sum_{n=1}^{\infty} \frac{1}{n^2}$$

The only way to undo a freeze is to use unfreeze, which reactivates the inactive function in S and then evaluates the result:

`unfreeze(S)`

$$\frac{\pi^2}{6}$$

### Example 3

`freeze(f)` does not change the object `f`, but returns a copy of `f` in an inactive form. This means that computations with the inactive version of `f` can contain the original function `f`.

For example, if you create an inactive version of the sine function on page 1-688 (Symbolic Math Toolbox):

```
Sin := freeze(sin):
```

and expand the term `Sin(x+y)`, then the result is expressed in terms of the original sine function `sin`:

```
expand(Sin(x + y))
```

$$\cos(x) \sin(y) + \cos(y) \sin(x)$$

## Parameters

`f`

A procedure on page 7-45 or a function environment on page 7-25

## Return Values

An object of the same type as `f`.

## See Also

### **MuPAD Functions**

MAXDEPTH | eval | hold | unfreeze

# unfreeze

Create an active copy of a frozen function

## Syntax

```
unfreeze(object)
```

## Description

`unfreeze(object)` reactivates all inactive functions occurring in `object`, proceeding recursively along the structure of `object`, and then evaluates the result.

`unfreeze` uses `misc::maprec` to proceed recursively along the structure of `object`. This means that for basic domains (Symbolic Math Toolbox) such as arrays on page 7-2, tables on page 1-2103, lists on page 7-41, or polynomials on page 1-1601, the function `unfreeze` is applied to each operand of `object`.

If `object` is an element of a library domain (Symbolic Math Toolbox), then the behavior of `unfreeze` is specified by the method `maprec` that overloads the function `misc::maprec`. If this method does not exist, then `unfreeze` has no effect on `object`. See “Example 2” on page 1-829 (Symbolic Math Toolbox).

`unfreeze` does not operate on the body of procedures. Therefore, it is recommended not to embed inactive functions inside procedures.

## Examples

### Example 1

Create an inactive form of the function environment `int`:

```
_int := freeze(int): F := _int(x*exp(x^2), x = 0..1)
```

$$\int_0^1 x e^{x^2} dx$$

The inactive form of `int` keeps every information that is known about the function `int`, for example, the output, the type, and the "float" slot for floating-point evaluation:

`F, type(F), float(F)`

$$\int_0^1 x e^{x^2} dx, \text{"int"}, 0.8591409142$$

The original function environment `int` is not modified by `freeze`:

`int(x*exp(x^2), x = 0..1)`

$$\frac{e}{2} - \frac{1}{2}$$

Use `unfreeze` to reactivate the inactive function `_int` and evaluate the result:

`unfreeze(F), unfreeze(F + 1/2)`

$$\frac{e}{2} - \frac{1}{2}, \frac{e}{2}$$

## Example 2

The function `unfreeze` uses `misc::maprec` to operate recursively along the structure of object. For example, if `object` is an array containing inactive functions, such as:

```
a := array(1..2,
  [freeze(int)(sin(x), x = 0..2*PI), freeze(sum)(k^2, k = 1..n)]
)
```

$$\left( \int_0^{2\pi} \sin(x) dx \sum_{k=1}^n k^2 \right)$$

then `unfreeze(a)` operates on the operands of `a`:

`unfreeze(a)`

$$\left( 0 \frac{n(2n+1)(n+1)}{6} \right)$$

This means that for library domains, the effect of `unfreeze` is specified by the method `maprec`. If the domain does not implement this method, then `unfreeze` does not operate on the objects of this domain. For example, create a domain and an object containing an inactive function as its operand:

```
dummy := newDomain("dummy"):
o := new(dummy, freeze(int)(sin(x), x = 0..2*PI))
```

$$\text{new} \left( \text{dummy}, \int_0^{2\pi} \sin(x) \, dx \right)$$

The function `unfreeze` applied to the object `o` has no effect:

`unfreeze(o)`

$$\text{new} \left( \text{dummy}, \int_0^{2\pi} \sin(x) \, dx \right)$$

If you overload the function `misc::maprec` in order to operate on the first operand of objects of the domain `dummy`, then `unfreeze` operates on `o` as expected:

```
dummy::maprec :=
  x -> extsubsop(x,
    1 = misc::maprec(extop(x,1), args(2..args(0)))
  ):
unfreeze(o)

new(dummy, 0)
```



## Parameters

**object**

Any MuPAD object

## Return Values

Evaluated version of `object` after reactivating all inactive functions in it.

## See Also

**MuPAD Functions**

`MAXDEPTH` | `eval` | `freeze` | `hold`

## fresnelC

The Fresnel cosine integral function

### Syntax

fresnelC(z)

### Description

$$\text{fresnelC}(z) = \int_0^z \cos\left(\frac{\pi t^2}{2}\right) dt .$$

The function  $C = \text{fresnelC}$  is analytic throughout the complex plane. It satisfies  $\text{fresnelC}(-z) = -\text{fresnelC}(z)$ ,  $\text{fresnelC}(\text{conjugate}(z)) = \text{conjugate}(\text{fresnelC}(z))$ ,  $\text{fresnelC}(I*z) = I*\text{fresnelC}(z)$  for all complex values of  $z$ .

$\text{fresnelC}(z)$  returns special values for  $z = 0$ ,  $z = \pm\infty$ , and  $z = \pm i\infty$ . Symbolic function calls are returned for all other symbolic values of  $z$ . In a MuPAD notebook

$\text{fresnelC}(z)$  appears in a typeset notation as  $C(z)$ .

For floating-point arguments,  $\text{fresnelC}$  returns floating-point values.

`simplify` and `Simplify`,  $\text{fresnelC}$  uses the reflection rule  $\text{fresnelC}(-z) = -\text{fresnelC}(z)$  to create a “normal form” of symbolic function calls. See “Example 3” on page 1-834 (Symbolic Math Toolbox).

### Environment Interactions

When called with floating-point arguments, these functions are sensitive to the environment variable `DIGITS` which determines the numerical working precision.

## Examples

### Example 1

Call the Fresnel cosine integral function with various arguments:

```
fresnelC(0),
fresnelC(1),
fresnelC(PI + I),
fresnelC(z),
fresnelC(infinity)
```

0, C(1), C( $\pi + i$ ), C(z),  $\frac{1}{2}$

For floating-point arguments, fresnelC returns floating-point values:

```
fresnelC(1.0),
fresnelC(float(PI)),
fresnelC(-3.45 + 0.75*I)
```

0.7798934004, 0.5236985437, 115.1165183 + 102.1764651 i

### Example 2

diff, float, limit, series, and other functions handle expressions involving the Fresnel cosine integral function:

```
diff(fresnelC(x), x)
```

$$\cos\left(\frac{\pi x^2}{2}\right)$$

```
float(fresnelC(PI))
```

0.5236985437

```
limit(fresnelC(x), x = infinity)
```

$$\frac{1}{2}$$

```
series(fresnelC(x), x = 0)
```

$$x - \frac{x^5 \pi^2}{40} + O(x^7)$$

### Example 3

`simplify` uses the reflection rule  $\text{fresnelC}(-z) = -\text{fresnelC}(z)$  to create a “normal form” of symbolic function calls:

```
simplify(fresnelC(1 - x)),  
Simplify(fresnelC(x - 1))
```

$$-C(x - 1), C(x - 1)$$

## Parameters

**z**

An arithmetical expression (Symbolic Math Toolbox)

## Return Values

Arithmetical expression.

## Overloaded By

**z**

## See Also

### MuPAD Functions

fresnelS

# fresnelS

The Fresnel sine integral function

## Syntax

fresnelS(z)

## Description

$$\text{fresnelS}(z) = \int_0^z \sin\left(\frac{\pi t^2}{2}\right) dt.$$

The function  $S = \text{fresnelS}$  is analytic throughout the complex plane. It satisfies  $\text{fresnelS}(-z) = -\text{fresnelS}(z)$ ,  $\text{fresnelS}(\text{conjugate}(z)) = \text{conjugate}(\text{fresnelS}(z))$ ,  $\text{fresnelS}(I*z) = -I*\text{fresnelS}(z)$  for all complex values of  $z$ .

$\text{fresnelS}(z)$  returns special values for  $z = 0$ ,  $z = \pm\infty$ , and  $z = \pm i\infty$ . Symbolic function calls are returned for all other symbolic values of  $z$ . In a MuPAD notebook

$\text{fresnelC}(z)$  appears in a typeset notation as  $S(z)$ .

For floating-point arguments,  $\text{fresnelS}$  returns floating-point values.

`simplify` and `Simplify`,  $\text{fresnelS}$  uses the reflection rule  $\text{fresnelS}(-z) = -\text{fresnelS}(z)$  to create a “normal form” of symbolic function calls. See “Example 3” on page 1-838 (Symbolic Math Toolbox).

## Environment Interactions

When called with floating-point arguments, these functions are sensitive to the environment variable `DIGITS` which determines the numerical working precision.

## Examples

### Example 1

Call the Fresnel sine integral function with various arguments:

```
fresnelS(0),  
fresnelS(1),  
fresnelS(PI + I),  
fresnelS(z),  
fresnelS(infinity)
```

$0, S(1), S(\pi + i), S(z), \frac{1}{2}$

For floating-point arguments, fresnelS returns floating-point values:

```
fresnelS(1.0),  
fresnelS(float(PI)),  
fresnelS(-3.45 + 0.75*I)
```

$0.4382591474, 0.5982490781, 101.6764728 - 115.6164932 i$

### Example 2

diff, float, limit, series, and other functions handle expressions involving the Fresnel sine integral function:

```
diff(fresnelS(x), x)
```

$\sin\left(\frac{\pi x^2}{2}\right)$

```
float(fresnelS(-100))
```

$-0.4968169011$

```
limit(fresnelS(x), x = -infinity)
```

$$-\frac{1}{2}$$

```
series(fresnelS(x), x = infinity, 4)
```

$$\frac{1}{2} - \frac{\cos\left(\frac{\pi x^2}{2}\right)}{\pi x} - \frac{\sin\left(\frac{\pi x^2}{2}\right)}{x^3 \pi^2} + O\left(\frac{1}{x^4}\right)$$

### Example 3

simplify use the reflection rule  $\text{fresnelS}(-z) = -\text{fresnelS}(z)$  to create a “normal form” of symbolic function calls:

```
simplify(3*fresnelS(z) + 2*fresnelS(-z))
```

$$S(z)$$

## Parameters

**z**

An arithmetical expression (Symbolic Math Toolbox)

## Return Values

Arithmetical expression.

## Overloaded By

**z**



## See Also

### MuPAD Functions

fresnelC

# **ftextinput**

Read text file

## **Syntax**

```
ftextinput(filename | n, <Encoding = "encodingValue">)
```

```
ftextinput(filename | n, x1, x2, ..., <Encoding = "encodingValue">)
```

## **Description**

`ftextinput(file, x)` reads a line from a text file, interprets the line as a string and assigns this string to the identifier `x`.

`ftextinput(filename)` reads the first line of the text file and returns it as a string to the MuPAD session. If the file is in `gzip`-compressed format and its name ends in `".gz"`, it will be transparently uncompressed upon reading.

`ftextinput(filename, x1, x2, ...)` reads the file line by line. The  $i$ -th line is converted to a character string and assigned to the identifier  $x_i$ . The identifiers are not evaluated while executing `ftextinput`; previously assigned values are overwritten.

`fread(..., Encoding = "encodingValue")` uses the specified encoding. For the supported encodings, see "Options" on page 1-844 (Symbolic Math Toolbox). You can use this option with any of the previously specified syntaxes.

Instead of a file name, also a file descriptor `n` of a file opened via `fopen` can be used. The functionality is as described above. However, there is one difference: With a file name, `ftextinput` automatically opens the file, performs the operation, and closes the file. A subsequent call to `ftextinput` starts at the beginning of the file. With a file descriptor, the file remains open (use `fclose` to close the file). The next time data are read from this file, the reading continues at the current position. Consequently, a file descriptor should be used, if the individual lines in the file are to be read via several subsequent calls of `ftextinput`. Cf. "Example 2" on page 1-842 (Symbolic Math Toolbox).

If the number of identifiers specified in the `ftextinput` call is larger than the number of lines in the file, the exceeding identifiers are not assigned any values. In such a case, `ftextinput` returns the void object of type `DOM_NULL`.

`ftextinput` interprets the file name as a pathname relative to the “working directory.”

Note that the meaning of “working directory” depends on the operating system. On Windows systems and on Mac OS X systems, the “working directory” is the folder where MATLAB is installed. On UNIX systems, it is the current working directory in which MATLAB was started. When started from a menu or desktop item, this is typically the user's home directory.

Also absolute path names are processed by `ftextinput`.

Expression sequences on page 1-88 are not flattened (Symbolic Math Toolbox) by `ftextinput` and cannot be used to pass several identifiers to `ftextinput`. Cf. “Example 3” on page 1-843 (Symbolic Math Toolbox).

## Examples

### Example 1

Use `fprint` to create a text file with three lines:

```
fid := fopen(TempFile, Write, Text);
fprint(Unquoted, fid, "x + 1\n2nd line\n3rd line");
file := fname(fid);
```

Read the first two lines of the file and assign the corresponding strings to the identifiers `x1` and `x2`:

```
ftextinput(file, x1, x2);
x1, x2
```

```
"x + 1", "2nd line"
```

If you try to read beyond the last line of the file, `ftextinput` returns the void object of type `DOM_NULL`:

```
ftextinput(file, x1, x2, x3, x4); domtype(%)
```

```
DOM_NULL
```

```
x1, x2, x3, x4
```

```
"x + 1", "2nd line", "3rd line", x4
```

```
delete x1, x2, x3:
```

## Example 2

Read some lines from a file using several calls of `ftextinput`. You have to use a file descriptor for reading from the file. The file is opened for reading with `fopen`:

```
fid := fopen(TempFile, Write, Text):  
fprintf(Unquoted, fid,  
        "x + 1\nx + 2\n3rd line\n4th line"):  
file := fname(fid):  
n := fopen(file):
```

The file descriptor returned by `fopen` can be passed to `ftextinput` for reading the data:

```
ftextinput(n, x1, x2):  
x1, x2
```

```
"x + 1", "x + 2"
```

```
ftextinput(n, x3, x4):  
x3, x4
```

```
"3rd line", "4th line"
```

Finally, close the file and delete the identifiers:

```
fclose(n):  
delete n, x1, x2, x3, x4:
```

Alternatively, the contents of a file can be read into a MuPAD session in the following way:

```
n := fopen(file):
for i from 1 to 4 do
    x.i := ftextinput(n)
end_for:
x1, x2, x3, x4
```

```
"x + 1", "x + 2", "3rd line", "4th line"
```

```
fclose(n):
delete n, i, x1, x2, x3, x4:
```

### Example 3

Expression sequences on page 1-88 are not flattened (Symbolic Math Toolbox) by `ftextinput` and cannot be used to pass identifiers to `ftextinput`:

```
fid := fopen(TempFile, Write, Text):
fprintf(Unquoted, fid, "1st line\n2nd line\n3rd line"):
file := fname(fid):
ftextinput(file, (x1, x2), x3)
```

```
Error: Invalid argument. [ftextinput]
```

The following call does not lead to an error because the identifier `x12` is not evaluated. Consequently, only one line is read from the file and assigned to `x12`:

```
x12 := x1, x2:
ftextinput(file, x12):
x1, x2, x12
```

```
x1, x2, "1st line"
```

```
delete x12:
```

### Example 4

To specify the encoding for reading data, use `Encoding`. The `Encoding` option applies only to text files that are opened using a file name and not a file descriptor. Open a temporary file and write the string "abcäöü" in the encoding "UTF-8":

```
fprint(Unquoted, Text, Encoding = "UTF-8",  
      "ftextinput_test",  
      "abcäöü"):
```

Specify the encoding to read the file correctly:

```
ftextinput("ftextinput_test", Encoding="UTF-8")
```

```
"abcäöü"
```

If you do not specify an encoding, the default system encoding is used. Thus, your output might vary from that shown next. Characters unrecognized by the default system encoding are replaced by the default substitution character for that encoding:

```
ftextinput("ftextinput_test")
```

```
"abc?????"
```

## Parameters

### filename

The name of a file: a character string on page 7-53

### n

A file descriptor provided by `fopen`: a positive integer

### x<sub>1</sub>, x<sub>2</sub>, ...

identifiers on page 7-29

## Options

### Encoding

This option lets you specify the character encoding to use. The allowed encodings are:

"Big5"	"ISO-8859-1"	"windows-932"
"EUC-JP"	"ISO-8859-2"	"windows-936"
"GBK"	"ISO-8859-3"	"windows-949"
"KSC_5601"	"ISO-8859-4"	"windows-950"
"Macintosh"	"ISO-8859-9"	"windows-1250"
"Shift_JIS"	"ISO-8859-13"	"windows-1251"
"US-ASCII"	"ISO-8859-15"	"windows-1252"
"UTF-8"		"windows-1253"
		"windows-1254"
		"windows-1257"

The default encoding is system dependent. If you specify the encoding incorrectly, characters might read incorrectly. Characters unrecognized by the encoding are replaced by the default substitution character for the specified encoding.

Encodings not listed here can be specified but might not produce correct results.

## Return Values

Last line that was read from the file: a character string or null().

## See Also

### MuPAD Functions

READPATH | WRITEPATH | fclose | finput | fname | fopen | fprintf | fread |  
import::readbitmap | import::readdata | input | pathname | print | protocol |  
read | textinput | write

## funcenv

Create a function environment

### Syntax

```
funcenv(f1, <f2>, <slotTable>)
```

### Description

`funcenv(f)` creates a function environment from `f`.

`funcenv` serves for generating a function environment of domain type `DOM_FUNC_ENV`.

From a user's point of view, function environments are similar to procedures and can be called like any MuPAD function.

However, in contrast to simple procedures, a function environment allows a tight integration into the MuPAD system. In particular, standard system functions such as `diff`, `expand`, `float` etc. can be told how to act on symbolic function calls to a function environment.

For this, a function environment stores special function attributes (slots on page 1-1980) in an internal table. Whenever an overloadable system function such as `diff`, `expand`, `float` encounters an object of type `DOM_FUNC_ENV`, it searches the function environment for a corresponding slot. If found, it calls the corresponding slot and returns the value produced by the slot.

Slots can be incorporated into the function environment by creating a table `slotTable` and passing this to `funcenv`, when the function environment is created. Alternatively, the function `slot` can be used to add further slots to an existing function environment.

See “Example 1” on page 1-847 (Symbolic Math Toolbox) below for further information.

The first argument `f1` of `funcenv` determines the evaluation of function calls. With `f := funcenv(f1)`, the call `f(x)` returns the result `f1(x)`. Note that calls of the form `f := funcenv(f)` are possible (and, in fact, typical). This call embeds the procedure `f` into a



function environment of the same name. The original procedure `f` is stored internally in the function environment `f`. After this call, further function attributes can be attached to `f` via the `slot` function.

The second argument `f2` of `funcenv` determines the screen output of symbolic function calls. Consider `f := funcenv(f1, f2)`. If the call `f(x)` returns a symbolic function call `f(x)` with 0-th operand `f`, then `f2` is called: the return value of `f2(f(x))` is used as the screen output of `f(x)`.

---

**Note** Beware: `f2(f(x))` should not produce a result containing a further symbolic call of `f`, because this will lead to an infinite recursion, causing an error message.

---

The third argument `slotTable` of `funcenv` is a table on page 1-2103 containing function attributes (slots on page 1-1980). The table has to use strings as indices to address system functions. E.g.,

```
slotTable := table("diff" = mydiff, "float" = myfloat):      f
:= funcenv(f1, f2, slotTable):
```

attaches the slot functions `mydiff` and `myfloat` to `f`. They are called by the system functions `diff` and `float`, respectively, whenever they encounter a symbolic expression `f(x)` with 0-th operand `f`. The internal slot table can be changed or filled with additional function attributes via the function `slot`.

If the first argument `f1` of `funcenv` is itself a function environment, then the return value is a physical copy of `f1`.

The documentation of `float`, `print`, and `slot` provides further examples involving function environments.

## Examples

### Example 1

We want to introduce a function `f` that represents a solution of the differential equation

$f'(x) = x + \sin(x) f(x)$ . First, we define a function `f`, which returns any call `f(x)` symbolically:

```
f := proc(x) begin procname(args()) end_proc: f(x), f(3 + y)
```

$f(x), f(y+3)$

Because of the differential equation  $f'(x) = x + \sin(x) f(x)$ , derivatives of  $f$  can be rewritten in terms of  $f$ . How can we tell the MuPAD system to differentiate symbolic functions calls such as  $f(x)$  accordingly? For this, we first have to embed the procedure  $f$  into a function environment:

```
f := funcenv(f):
```

The function environment behaves like the original procedure:

```
f(x), f(3 + y)
```

$f(x), f(y+3)$

System functions such as `diff` still treat symbolic calls of  $f$  as calls to unknown functions:

```
diff(f(x + 3), x)
```

$f'(x+3)$

However, as a function environment,  $f$  can receive attributes that overload the system functions. The following `slot` call attaches a dummy "diff" attribute to  $f$ :

```
f::diff := mydiff: diff(2*f(x^2) + x, x)
```

$2 \text{mydiff}(f(x^2), x) + 1$

We attach a more meaningful "diff" attribute to  $f$  that is based on

$f'(x) = x + \sin(x) f(x)$ . Note that arbitrary calls `diff(f(y), x1, x2, ...)` have to be handled by this slot:

```
fdiff := proc(fcall) local y; begin
  y:= op(fcall, 1);
  (y + sin(y)*f(y))*diff(y, args(2..args(0)))
end_proc;
```

```
end_proc:
f := slot(f, "diff", fdiff):
```

Now, as far as differentiation is concerned, the function `f` is fully integrated into MuPAD:

```
diff(f(x), x), diff(f(x), x, x)
```

$$x + f(x) \sin(x), \cos(x) f'(x) + \sin(x) (x + f(x) \sin(x)) + 1$$

```
diff(sin(x)*f(x^2), x)
```

$$f'(x^2) \cos(x) + 2 x \sin(x) (x^2 + f(x^2) \sin(x^2))$$

Since Taylor expansion around finite points only needs to evaluate derivatives, also Taylor expansions of `f` can be computed:

```
taylor(f(x^2), x = 0, 9)
```

$$f(0) + x^4 \left( \frac{f'(0)}{2} + \frac{1}{2} \right) + x^8 \left( \frac{f'(0)}{12} + \frac{1}{8} \right) + O(x^9)$$

```
delete f, fdiff:
```

## Example 2

Suppose that you have defined a function `f` that may return itself symbolically, and you want such symbolic expressions of the form `f(x, ...)` to be printed in a special way. To this end, embed your procedure on page 7-45f in a function environment on page 7-25 and supply an output procedure as second argument to the corresponding `funcenv` call. Whenever an expression of the form `f(x, ...)` is to be printed, the output procedure will be called with the arguments `x, ...` of the expression:

```
f := funcenv(f,
  proc(x) begin
    if nops(x) = 2 then
      "f does strange things with its arguments ".
      expr2text(op(x, 1))." and ".expr2text(op(x,2))
    else
      FAIL
```

```
        end
    end):
delete a, b:
print(f(a, b)/2):
print(f(a, b, c)/2):
```

f does strange things with its arguments a and b  
2

$f(a, b, c)$   
2

```
delete f:
```

## Parameters

### f1

An arbitrary MuPAD object. Typically, a procedure on page 1-1654. It handles the evaluation of a function call to the function environment.

### f2

A procedure handling the screen output of symbolic function calls

### slotTable

A table of function attributes (slots on page 1-1980)

## Return Values

Function environment of type DOM\_FUNC\_ENV.

## Algorithms

Mathematical functions such as `exp`, `ln` etc. or `abs`, `Re`, `Im` etc. are implemented as function environments.

## See Also

### MuPAD Functions

`slot`

## Topics

“Integrate Custom Functions into MuPAD” (Symbolic Math Toolbox)

# funm

General matrix function

## Syntax

`funm(A, f)`

## Description

`funm(A, f)` computes the function  $f(A)$  for the square matrix  $A$ . For details, see “Algorithms” on page 1-856 (Symbolic Math Toolbox).

## Examples

### Example 1

Find a matrix  $B$ , such that  $B^3 = A$ , where  $A$  is the 3-by-3 identity matrix.

To solve  $B^3 = A$ , compute the cube root of the matrix  $A$  using the `funm` function. Create the function that computes the cube root of its argument, and use it as the second argument for `funm`. The cube root of an identity matrix is the identity matrix itself.

```
A := matrix::identity(3):  
f := x -> surd(x, 3)
```

$$x \rightarrow \sqrt[3]{x}$$

```
funm(A, f)
```

$$\begin{pmatrix} 1 & 0 & 0 \\ 0 & 1 & 0 \\ 0 & 0 & 1 \end{pmatrix}$$

Replace one of the 0 elements of matrix A with 1 and compute the matrix cube root again.

```
A[1, 2] := 1:
A
```

$$\begin{pmatrix} 1 & 1 & 0 \\ 0 & 1 & 0 \\ 0 & 0 & 1 \end{pmatrix}$$

```
funm(A, f)
```

$$\begin{pmatrix} 1 & \frac{1}{3} & 0 \\ 0 & 1 & 0 \\ 0 & 0 & 1 \end{pmatrix}$$

Now, compute the cube root of the upper triangular matrix.

```
A[1..2, 3] := [1, 1]:
A
```

$$\begin{pmatrix} 1 & 1 & 1 \\ 0 & 1 & 1 \\ 0 & 0 & 1 \end{pmatrix}$$

```
B := funm(A, f)
```

$$\begin{pmatrix} 1 & \frac{1}{3} & \frac{2}{9} \\ 0 & 1 & \frac{1}{3} \\ 0 & 0 & 1 \end{pmatrix}$$

Verify that  $B^3 = A$ .

```
B^3 = A
```

$$\begin{pmatrix} 1 & 1 & 1 \\ 0 & 1 & 1 \\ 0 & 0 & 1 \end{pmatrix} = \begin{pmatrix} 1 & 1 & 1 \\ 0 & 1 & 1 \\ 0 & 0 & 1 \end{pmatrix}$$

## Example 2

Find the matrix Lambert W function.

Create the 3-by-3 Pascal matrix A.

```
A := linalg::pascal(3)
```

$$\begin{pmatrix} 1 & 1 & 1 \\ 1 & 2 & 3 \\ 1 & 3 & 6 \end{pmatrix}$$

To find the Lambert W function ( $W_0$  branch) in a matrix sense, call `funm` using `lambertW` as its second argument. Approximate the result with floating-point numbers by using `float`.

```
W0 := funm(float(A), lambertW)
```

$$\begin{pmatrix} 0.4715911292 & 0.2869500057 & 0.09584568317 \\ 0.2869500057 & 0.5196607317 & 0.5264174526 \\ 0.09584568317 & 0.5264174526 & 1.285252109 \end{pmatrix}$$

Verify that this result is a solution of the matrix equation  $A = W_0 \cdot e^{W_0}$  within the current floating-point accuracy.

```
A = W0*exp(W0)
```

$$\begin{pmatrix} 1 & 1 & 1 \\ 1 & 2 & 3 \\ 1 & 3 & 6 \end{pmatrix} = \begin{pmatrix} 1.0 & 1.0 & 1.0 \\ 1.0 & 2.0 & 3.0 \\ 1.0 & 3.0 & 6.0 \end{pmatrix}$$

Now, find the  $W_{-1}$  branch of the Lambert W function for the matrix A. Create the function `f` representing the branch  $W_{-1}$  of the Lambert W function.

```
f := x -> lambertW(-1, x)
```

$$x \rightarrow W_{-1}(x)$$

Call `funm` using `f` as its second argument. Approximate the result with floating-point numbers by using `float`.



```
Wm1 := funm(float(A), f)
```

```
[[ -2.116372833 - 4.266440523 i, 1.130732372 - 0.2199437576 i,
  -0.03418665371 - 0.002454497511 i],
 [ 1.130732372 - 0.2199437576 i, -2.441789243 - 4.214522706 i,
  1.353588821 - 0.2792250676 i],
 [-0.03418665371 - 0.002454497511 i, 1.353588821 - 0.2792250676 i,
  -0.248697806 - 4.659319216 i]]
```

Verify that this result is a solution of the matrix equation  $A = Wm1 \cdot e^{Wm1}$  within the current floating-point accuracy.

```
A = Wm1*exp(Wm1)
```

$$\begin{pmatrix} 1 & 1 & 1 \\ 1 & 2 & 3 \\ 1 & 3 & 6 \end{pmatrix} =$$

$$\begin{pmatrix} 1.0 + 7.047314121 \cdot 10^{-15} i & 1.0 + 1.498801083 \cdot 10^{-14} i & 1.0 + 8.043587497 \cdot 10^{-15} i \\ 1.0 - 1.297139479 \cdot 10^{-14} i & 2.0 - 1.911058117 \cdot 10^{-14} i & 3.0 - 6.004224895 \cdot 10^{-14} i \\ 1.0 + 1.157957736 \cdot 10^{-14} i & 3.0 + 3.354571666 \cdot 10^{-14} i & 6.0 + 1.19262239 \cdot 10^{-14} i \end{pmatrix}$$

## Parameters

**A**

A square array on page 7-2, harray on page 7-27, or matrix on page 1-2045 (Symbolic Math Toolbox).

**f**

A function (Symbolic Math Toolbox).

## Return Values

An array on page 7-2, harray on page 7-27, or matrix on page 1-2045 (Symbolic Math Toolbox).

## Algorithms

Suppose  $f(x)$ , where  $x$  is a scalar, has a Taylor series expansion. Then the matrix function  $f(A)$ , where  $A$  is a matrix, is defined by the Taylor series of  $f(A)$ , with addition and multiplication performed in the matrix sense.

If  $A$  can be represented as  $A = P \cdot D \cdot P^{-1}$ , where  $D$  is a diagonal matrix, such that

$$D = \begin{pmatrix} d_1 & \dots & 0 \\ \cdot & \cdot & \cdot \\ \cdot & \cdot & \cdot \\ \cdot & \cdot & \cdot \\ 0 & \dots & d_n \end{pmatrix}$$

then the matrix function  $f(A)$  can be computed as follows:

$$f(A) = P \begin{pmatrix} f(d_1) & \dots & 0 \\ \cdot & \cdot & \cdot \\ \cdot & \cdot & \cdot \\ \cdot & \cdot & \cdot \\ 0 & \dots & f(d_n) \end{pmatrix} P^{-1}$$

Nondiagonalizable matrices can be represented as  $A = P \cdot J \cdot P^{-1}$ , where  $J$  is a Jordan form of the matrix  $A$ . (For details, see `linalg::jordanForm`.) Then, the matrix function  $f(A)$  can be computed by using the following definition on each Jordan block:

$$f \left( \begin{pmatrix} \lambda & 1 & 0 & \dots & \dots & 0 \\ 0 & \lambda & 1 & & & \vdots \\ 0 & 0 & \lambda & & & \vdots \\ \vdots & & & \ddots & & \vdots \\ \vdots & & & & \lambda & 1 & 0 \\ \vdots & & & & 0 & \lambda & 1 \\ 0 & \dots & \dots & 0 & 0 & \lambda \end{pmatrix} \right) = \begin{pmatrix} \frac{f(\lambda)}{0!} & \frac{f'(\lambda)}{1!} & \frac{f''(\lambda)}{2!} & \dots & \dots & \dots & \frac{f^{(n)}(\lambda)}{n!} \\ 0 & \frac{f(\lambda)}{0!} & \frac{f'(\lambda)}{1!} & \dots & \dots & \dots & \frac{f^{(n-1)}(\lambda)}{(n-1)!} \\ 0 & 0 & \frac{f(\lambda)}{0!} & & & & \vdots \\ \vdots & & & \ddots & & & \vdots \\ \vdots & & & & \ddots & & \vdots \\ \vdots & & & & & \frac{f(\lambda)}{0!} & \frac{f'(\lambda)}{1!} & \frac{f''(\lambda)}{2!} \\ \vdots & & & & & 0 & \frac{f(\lambda)}{0!} & \frac{f'(\lambda)}{1!} \\ 0 & \dots & \dots & \dots & 0 & 0 & \frac{f(\lambda)}{0!} \end{pmatrix}$$

## See Also

### MuPAD Functions

exp | linalg::jordanForm | linalg::sqrtMatrix | map | numeric::expMatrix |  
numeric::fMatrix

## gamma

Gamma function

### Syntax

`gamma(x)`

`gamma(iv)`

### Description

`gamma(x)` represents the gamma function  $\Gamma(x) = \int_0^{\infty} e^{-t} t^{x-1} dt$ .

The gamma function is defined for all complex arguments apart from the singular points 0, -1, -2, ....

The gamma function is related to the factorial function: `gamma(x) = fact(x - 1) = (x - 1)!` for all positive integers  $x$ .

If  $x$  is a floating-point value, then `gamma` returns a floating-point value. If  $x$  is a floating-point interval, `gamma` returns a floating-point interval. If  $x$  is a positive integer not larger than the value given by `Pref::autoExpansionLimit()`, then an integer is returned. (Use `expand(gamma(x))` to get an integer value for larger integers  $x$ .) If  $x$  is a rational number of domain type `DOM_RAT` not larger than the value given by `Pref::autoExpansionLimit()`, then the functional relation  $\Gamma(x + 1) = x\Gamma(x)$  is applied to “normalize” the result. (Again, use `expand(gamma(x))` to enforce this normalization for larger rational numbers  $x$ .) The functional relation

$$\Gamma(x) \Gamma(1-x) = \frac{\pi}{\sin(\pi x)}$$

is applied if  $x < \frac{1}{2}$  is a rational number of domain type `DOM_RAT` that is an integer multiple of  $\frac{1}{2}$  or  $\frac{1}{4}$ . The call `gamma(1/2)` yields `sqrt(PI)`. The call `gamma(infinity)` yields `infinity`. For all other arguments, a symbolic function call is returned.

The floating-point attribute of gamma is a kernel function, that is, floating-point evaluation is fast.

The `expand` attribute rewrites `gamma(x)` by using the functional equation  $\Gamma(x + 1) = x \Gamma(x)$ , the reflection formula

$$\Gamma(-x) = -\frac{\pi}{x \sin(\pi x) \Gamma(x)},$$

and the Gauss multiplication formula for  $\Gamma(kx)$  when  $k$  is a positive integer. See “Example 3” on page 1-860 (Symbolic Math Toolbox). For numerical  $x$ , the functional equation is used to shift the argument to the range  $0 < x < 1$ .

The functional equations for gamma lead to various identities for `lgamma` which can be applied via `expand`. See “Example 3” on page 1-860 (Symbolic Math Toolbox).

The logarithmic derivative of gamma is implemented by the digamma function `psi`.

## Environment Interactions

When called with a floating-point argument, the function is sensitive to the environment variable `DIGITS` which determines the numerical working precision.

## Examples

### Example 1

Call `gamma` with exact and symbolic input data:

```
gamma(15),
gamma(3/2),
gamma(-3/2),
gamma(sqrt(2)),
gamma(x + 1)
```

$$87178291200, \frac{\sqrt{\pi}}{2}, \frac{4\sqrt{\pi}}{3}, \Gamma(\sqrt{2}), \Gamma(x+1)$$

Call `gamma` with floating-point arguments:

```
gamma(11.5),  
gamma(2.0 + 10.0*I)
```

```
11899423.08, -0.00001089258677 + 0.00000504737724 i
```

## Example 2

`gamma` is singular for nonpositive integers:

```
gamma(0)
```

```
Error: Singularity. [gamma]
```

## Example 3

`diff`, `expand`, `float`, `limit`, and `series` handle expressions involving `gamma`:

```
diff(gamma(x^2 + 1), x)
```

```
2 x Γ(x2 + 1) ψ(x2 + 1)
```

```
float(ln(3 + gamma(sqrt(PI))))
```

```
1.367203476
```

```
expand(gamma(x + 2))
```

```
x Γ(x) (x + 1)
```

```
expand(gamma(2*x))
```

```

$$\frac{2^{2x} \Gamma(x + \frac{1}{2}) \Gamma(x)}{2 \sqrt{\pi}}$$

```

```
expand(gamma(2*x - 1))
```

$$\frac{2^{2x} \Gamma(x + \frac{1}{2}) \Gamma(x)}{2 \sqrt{\pi} (2x - 1)}$$

```
limit(1/gamma(x), x = infinity)
```

0

```
limit(gamma(x - 4)/gamma(x - 10), x = 0)
```

151200

```
series(gamma(x), x = 0, 3)
```

$$\frac{1}{x} - \text{EULER} + x \left( \frac{\text{EULER}^2}{2} + \frac{\pi^2}{12} \right) + O(x^2)$$

The Stirling formula is obtained as an asymptotic series:

```
series(gamma(x), x = infinity, 4)
```

$$\frac{\sigma_1}{\sqrt{x} \left(\frac{1}{x}\right)^x} + \frac{\sigma_1}{12 x^{3/2} \left(\frac{1}{x}\right)^x} + \frac{\sigma_1}{288 x^{5/2} \left(\frac{1}{x}\right)^x} + O\left(\frac{e^{-x}}{x^{7/2} \left(\frac{1}{x}\right)^x}\right)$$

where

$$\sigma_1 = \sqrt{2} \sqrt{\pi} e^{-x}$$

## Example 4

The logarithm function  $\ln$  has a branch cut along the negative real semi axis, where the values jump by  $2\pi i$  when crossing the cut. In the following plot of the imaginary part of

the logarithm of the gamma function the lines in the complex  $z$  plane with  $\Im(\Gamma(z)) = 0$  and  $\Re(\Gamma(z)) \leq 0$  are clearly visible as discontinuities:

```
plotfunc3d(Im(ln(gamma(x + I*y))), x = -10 .. 10, y = -10 .. 10,
           Submesh = [2, 2], CameraDirection = [0, -1, 1000]):
```

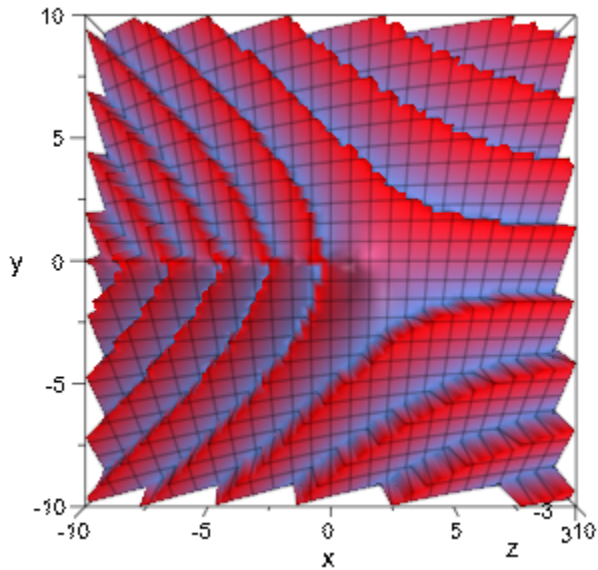

The function  $\ln\Gamma(z)$ , however, adds suitable integer multiples of  $2\pi i$  to  $\ln(\Gamma(z))$  making the function analytic throughout the complex plane with a branch cut along the negative real semi axis:

```
plotfunc3d(Im(lnGamma(x + I*y)), x = -10 .. 10, y = -10 .. 10,
           Submesh = [2, 2], CameraDirection = [0, -1, 1000]):
```



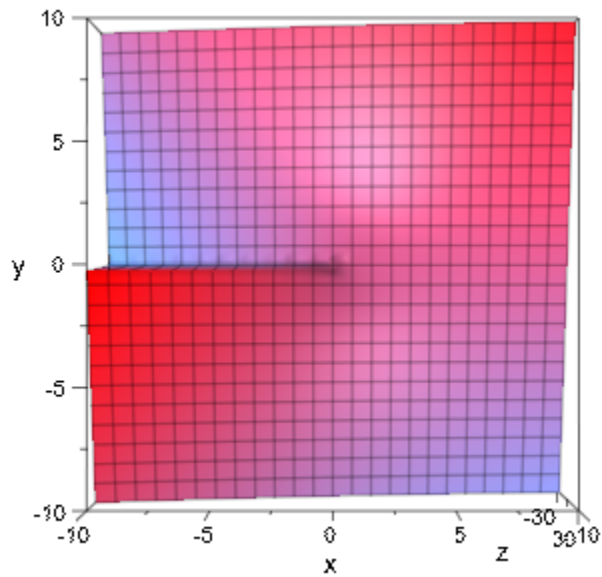

## Parameters

**x**

An arithmetical expression (Symbolic Math Toolbox)

**iv**

A floating-point interval on page 7-33

## Return Values

Arithmetical expression or a floating-point interval.

## Overloaded By

x

## See Also

### MuPAD Functions

beta | binomial | fact | harmonic | igamma | lngamma | pochhammer | psi

# lngamma

Logarithmic gamma function

## Syntax

lngamma(x)

## Description

lngamma(x) represents the logarithmic gamma function  $\ln\Gamma(x) = \ln(\Gamma(x))$  for positive real x.

The logarithmic gamma function is defined for all complex arguments apart from the singular points 0, -1, -2, ....

Along the positive real semi axis, the logarithmic gamma function  $\ln\Gamma(x)$  coincides with the logarithm  $\ln(\Gamma(x))$  of the gamma function. For negative or general complex arguments x,  $\ln\Gamma(x) = \ln(\Gamma(x)) + f(x) 2 \pi i$  with some integer-valued function f(x). The integer multiples of  $2 \pi i$  are chosen so that *lngamma* is analytic throughout the complex plane with a branch cut along the negative real semi axes. See "Example 4" on page 1-868 (Symbolic Math Toolbox). For negative real x, the value  $\ln\Gamma(x)$  coincides with the limit "from above".

If the argument x is a floating-point value, then lngamma(x) returns a floating-point value. For other values of x, the call lngamma(x) returns ln(gamma(x)) if x is a positive real number and gamma(x) is not returned as a symbolic call. For negative or complex values x, lngamma returns a symbolic call lngamma(x).

The functional equations for gamma lead to various identities for lngamma which can be applied via expand. See "Example 3" on page 1-867 (Symbolic Math Toolbox).

The logarithmic derivative of gamma is implemented by the digamma function psi.

## Environment Interactions

When called with a floating-point argument, the function is sensitive to the environment variable DIGITS which determines the numerical working precision.

## Examples

### Example 1

Call `lngamma` with exact and symbolic input data:

```
lngamma(15),  
lngamma(3/2),  
lngamma(-3/2),  
lngamma(sqrt(2)),  
lngamma(x + 1)
```

$\ln(87178291200)$ ,  $\ln\left(\frac{\sqrt{\pi}}{2}\right)$ ,  $\ln\Gamma\left(-\frac{3}{2}\right)$ ,  $\ln\Gamma(\sqrt{2})$ ,  $\ln\Gamma(x + 1)$

Call `lngamma` with floating-point arguments:

```
lngamma(11.5),  
lngamma(2.0 + 10.0*I)
```

16.29200048, -11.33017193 + 15.27404065 i

### Example 2

`lngamma` is singular for nonpositive integers:

```
lngamma(-2)
```

Error: Singularity. [lngamma]

### Example 3

diff, expand, float, limit, and series handle expressions involving lgamma:

```
diff(lgamma(x^2 + 1), x)
```

$$2 x \psi(x^2 + 1)$$

```
float(ln(3 + lgamma(sqrt(PI))))
```

$$1.072044865$$

```
expand(lgamma(x + 2))
```

$$\ln(x + 1) + \ln(x) + \ln\Gamma(x)$$

```
expand(lgamma(2*x))
```

$$\ln\Gamma\left(x + \frac{1}{2}\right) - \ln(2) - \frac{\ln(\pi)}{2} + \ln\Gamma(x) + 2 x \ln(2)$$

```
expand(lgamma(2*x - 1))
```

$$\ln\Gamma\left(x + \frac{1}{2}\right) - \ln(2) - \ln(2 x - 1) - \frac{\ln(\pi)}{2} + \ln\Gamma(x) + 2 x \ln(2)$$

```
limit(1/lgamma(x), x = infinity)
```

$$0$$

```
limit(lgamma(x - 4) - lgamma(x - 10), x = 0)
```

$$\ln(151200) + 6 \pi i$$

```
series(lgamma(x), x = 0, 3)
```

$$-\ln(x) - \text{EULER} x + \frac{x^2 \pi^2}{12} + O(x^3)$$

The Stirling formula is obtained as an asymptotic series:

```
series(lgamma(x), x = infinity, 4)
```

$$x (\ln(x) - 1) + \frac{\ln(2)}{2} + \frac{\ln(\pi)}{2} - \frac{\ln(x)}{2} + \frac{1}{12x} + O\left(\frac{1}{x^3}\right)$$

### Example 4

The logarithm function  $\ln$  has a branch cut along the negative real semi axis, where the values jump by  $2\pi i$  when crossing the cut. In the following plot of the imaginary part of the logarithm of the gamma function the lines in the complex  $z$  plane with  $\Im(\Gamma(z)) = 0$  and  $\Re(\Gamma(z)) \leq 0$  are clearly visible as discontinuities:

```
plotfunc3d(Im(ln(gamma(x + I*y))), x = -10 .. 10, y = -10 .. 10,  
           Submesh = [2, 2], CameraDirection = [0, -1, 1000]):
```

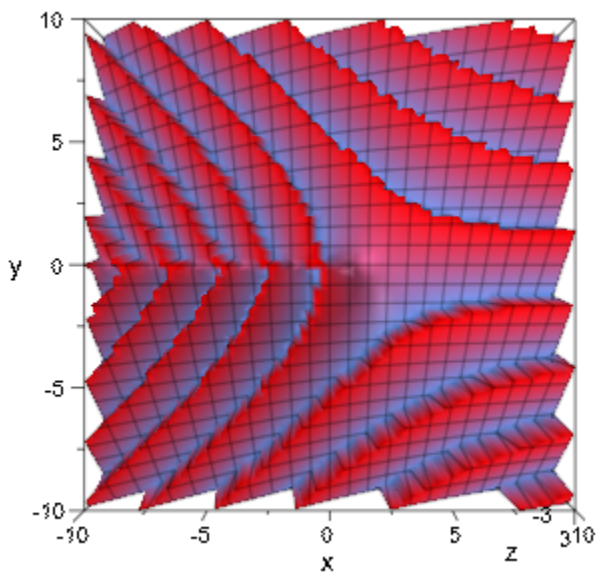

The function  $\ln\gamma(z)$ , however, adds suitable integer multiples of  $2\pi i$  to  $\ln(\gamma(z))$  making the function analytic throughout the complex plane with a branch cut along the negative real semi axis:

```
plotfunc3d(Im(lngamma(x + I*y)), x = -10 .. 10, y = -10 .. 10,
           Submesh = [2, 2], CameraDirection = [0, -1, 1000]):
```

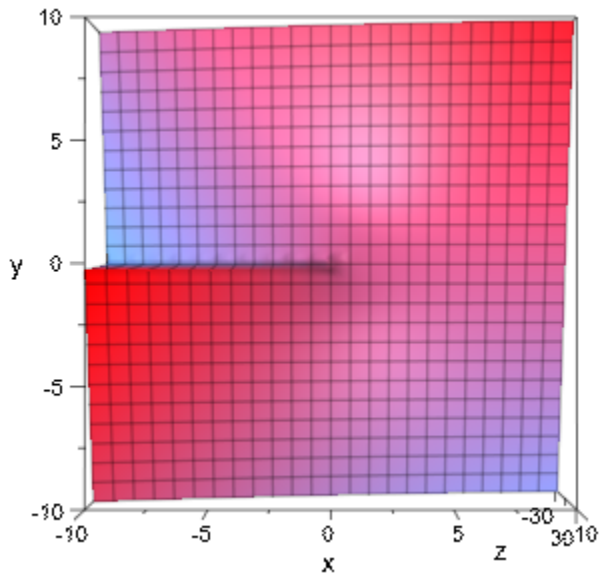

## Parameters

**x**

An arithmetical expression (Symbolic Math Toolbox)

## Return Values

Arithmetical expression or a floating-point interval.

## Overloaded By

**x**



## See Also

### MuPAD Functions

beta | binomial | fact | gamma | harmonic | igamma | pochhammer | psi

## gcd

Greatest common divisor of polynomials

### Syntax

`gcd(p, q, ...)`

`gcd(f, g, ...)`

### Description

`gcd(p, q, ...)` returns the greatest common divisor of the polynomials  $p, q, \dots$ . The coefficient ring on page 1-1601 of the polynomials may either be the integers or the rational numbers, `Expr`, a residue class ring `IntMod(n)` with a prime number  $n$ , or a domain (Symbolic Math Toolbox).

All polynomials must have the same indeterminates and the same coefficient ring.

Polynomial expressions are converted to polynomials. See `poly` for details.

The return value is of the same type as the input polynomials, i.e., either a polynomial of type `DOM_POLY` or a polynomial expression.

`gcd` returns 0 if all arguments are 0, or if no argument is given. If at least one of the arguments is -1 or 1, then `gcd` returns 1.

Use `igcd` if all arguments are known to be integers, since it is much faster than `gcd`.

### Examples

#### Example 1

The greatest common divisor of two polynomial expressions can be computed as follows:

```
gcd(6*x^3 + 9*x^2*y^2, 2*x + 2*x*y + 3*y^2 + 3*y^3)
```

$$3y^2 + 2x$$

```
f := (x - sqrt(2))*(x^2 + sqrt(3)*x-1):
g := (x - sqrt(2))*(x - sqrt(3)):
gcd(f, g)
```

$$x - \sqrt{2}$$

One may also choose polynomials as arguments:

```
p := poly(2*x^2 - 4*x*y - 2*x + 4*y, [x, y], IntMod(17)):
q := poly(x^2*y - 2*x*y^2, [x, y], IntMod(17)):
gcd(p, q)
```

$$\text{poly}(x - 2y, [x, y], \text{IntMod}(17))$$

```
delete f, g, p, q:
```

## Parameters

**p, q, ...**

polynomials (Symbolic Math Toolbox) of type DOM\_POLY

**f, g, ...**

polynomial expressions (Symbolic Math Toolbox)

## Return Values

Polynomial or a polynomial expression.

## Overloaded By

f, g, p, q

## Algorithms

If the arguments are polynomials with coefficients from a domain, then the domain must have the methods "gcd" and "\_divide". The method "gcd" must return the greatest common divisor of any number of domain elements. The method "\_divide" must divide two domain elements. If domain elements cannot be divided, this method must return FAIL.

## See Also

### MuPAD Functions

content | div | divide | factor | gcdex | icontent | ifactor | igcd | igcdex |  
ilcm | lcm | mod | poly

# gcdex

Extended Euclidean algorithm for polynomials

## Syntax

```
gcdex(p, q, <x>)
```

```
gcdex(f, g, x)
```

## Description

`gcdex(p, q, x)` regards  $p$  and  $q$  as univariate polynomials in  $x$  and returns their greatest common divisor as a linear combination of  $p$  and  $q$ .

`gcdex(p, q, x)` returns a sequence  $g, s, t$  with three elements, where the polynomial  $g$  is the greatest common divisor of  $p$  and  $q$ . The polynomials  $s$  and  $t$  satisfy  $g = s p + t q$  and  $\deg(s) < \deg(q)$ ,  $\deg(t) < \deg(p)$ . These data are computed by the extended Euclidean algorithm.

`gcdex` only processes univariate polynomials:

- If the indeterminate  $x$  is specified, the input polynomials are regarded as univariate polynomials in  $x$ .
- If no indeterminate is specified, the indeterminate of the polynomials is searched for internally. An error occurs if more than one indeterminate is found.

Note that  $x$  must be specified if polynomial expressions are used on input.

Polynomial expressions are converted to polynomials. See `poly` for details. `FAIL` is returned if an argument cannot be converted to a polynomial.

The returned polynomials are polynomial expressions if the input consists of polynomial expressions. Otherwise, polynomials of type `DOM_POLY` are returned.

The coefficient ring of the polynomials must provide the method `"_divide"`. This method must return `FAIL` if domain elements cannot be divided.

**Note** If the coefficient domain of the polynomial is not a field, then it may not be possible to represent a greatest common divisor as a linear combination of the input polynomials. In such a case, an error is raised.

---

## Examples

### Example 1

The greatest common divisor of two univariate polynomials in extended form can be computed as follows:

```
gcdex(poly(x^3 + 1), poly(x^2 + 2*x + 1))
```

$$\text{poly}(x + 1, [x]), \text{poly}\left(\frac{1}{3}, [x]\right), \text{poly}\left(-\frac{x}{3} + \frac{2}{3}, [x]\right)$$

For multivariate polynomials, an indeterminate must be specified:

```
gcdex(poly(x^2*y), poly(x + y), x)
```

$$\text{poly}(1, [x]), \text{poly}\left(\frac{1}{y^3}, [x]\right), \text{poly}\left(\left(-\frac{1}{y^2}\right)x + \frac{1}{y}, [x]\right)$$

```
gcdex(poly(x^2*y), poly(x + y), y)
```

$$\text{poly}(1, [y]), \text{poly}\left(-\frac{1}{x^3}, [y]\right), \text{poly}\left(\frac{1}{x}, [y]\right)$$

```
gcdex(x^3 + a, x^2 + 1, x)
```

$$1, \frac{a}{a^2 + 1} + \frac{x}{a^2 + 1}, \frac{1}{a^2 + 1} - \frac{x^2}{a^2 + 1} - \frac{a x}{a^2 + 1}$$

## Parameters

**p, q**

polynomials (Symbolic Math Toolbox) of type DOM\_POLY

**f, g**

polynomial expressions (Symbolic Math Toolbox)

**x**

An indeterminate: an identifier on page 7-29 or an indexed on page 1-1017 identifier

## Return Values

Sequence of three polynomials, or a sequence of three polynomial expressions, or FAIL.

## Overloaded By

p, q

## See Also

### MuPAD Functions

div | divide | factor | gcd | ifactor | igcd | igcdex | ilcm | lcm | mod | poly

## genident

Create an unused identifier

### Syntax

```
genident()
```

```
genident(S)
```

### Description

`genident()` creates an identifier not used before in the current session.

`genident()` creates an identifier on page 7-29 with a name of the form  $X_i$ , where  $i$  is a positive integer. It is guaranteed that the returned identifier has not been used before in the current MuPAD session.

If a string on page 7-53S is given as argument, then `genident` returns an identifier with a name of the form  $S_i$ , where  $i$  is a positive integer.

The returned identifier does not have a value.

### Examples

#### Example 1

We create three new identifiers. The second identifier has a different prefix:

```
genident(), genident("Y"), genident()
```

$X_1, Y_1, X_2$

In the next example, we assign a value to the identifier  $X_4$ . Then the next two calls to `genident` skip the name  $X_4$ :



```
X4 := 5:  
genident(), genident()
```

X3, X5

## Parameters

S

A character string on page 7-53

## Return Values

identifier on page 7-29.

## See Also

**MuPAD Functions**

delete | hold

## genpoly

Create a polynomial using b-adic expansion

### Syntax

`genpoly(n, b, x)`

### Description

`genpoly(n, b, x)` creates a polynomial on page 1-1601 `p` in the variable `x` from the b-adic expansion of `n`, such that  $p(b) = n$ . The integer coefficients of the resulting

polynomial are greater than  $-\frac{b}{2}$  and less than or equal to  $\frac{b}{2}$ .

The *b*-adic expansion of an integer *n* is defined by  $n = \sum_{i=0}^m c_i b^i$ , such that the  $c_i$  are symmetric remainders modulo *b*, i.e.,  $-\frac{b}{2} < c_i \leq \frac{b}{2}$  for all *i* (see `mods`). From this

expansion the polynomial  $p = \sum_{i=0}^m c_i x^i$  is created. The polynomial is defined over the coefficient ring `Expr`.

If the first argument of `genpoly` is a (multivariate) polynomial on page 1-1601, then it must be defined over the coefficient ring `Expr` and must have only integer coefficients. The third argument `x` must not be a variable of the polynomial. In this case each integer coefficient is converted into a polynomial in `x` as described above. The result is a polynomial in the variable `x`, followed by the variables of the given polynomial. (`x` is the main variable of the returned polynomial.)

The first argument `n` may also be a polynomial expression (Symbolic Math Toolbox). In this case, it is converted into a polynomial using `poly`, then `genpoly` is applied as described above, and the result is again converted into a polynomial expression.

If the first argument is an integer or a polynomial, then the result is a polynomial of domain type `DOM_POLY`; otherwise it is a polynomial expression.

## Examples

### Example 1

We create a polynomial  $p$  in the indeterminate  $x$  such that  $p(7) = 15$ . The coefficients of  $p$  are between  $-3$  and  $3$ :

```
p := genpoly(15, 7, x)
```

```
poly(2 x + 1, [x])
```

```
p(7)
```

```
15
```

Here is an example with a polynomial expression as input:

```
p := genpoly(15*y^2 - 6*y + 3*z, 7, x)
```

```
y + 3 z - x y + 2 x y^2 + y^2
```

The return value has the same type as the first argument:

```
p := genpoly(poly(15*y^2 + 8*z, [y, z]), 7, x)
```

```
poly(2 x y^2 + x z + y^2 + z, [x, y, z])
```

We check the result:

```
p(7, y, z)
```

```
15 y^2 + 8 z
```

## Parameters

**n**

An integer on page 7-31, a polynomial on page 1-1601 of type DOM\_POLY, or a polynomial expression (Symbolic Math Toolbox)

**b**

An integer on page 7-31 greater than 1

**x**

The indeterminate: an identifier on page 7-29

## Return Values

polynomial on page 1-1601 if the first argument is a polynomial or an integer. Otherwise, a polynomial expression (Symbolic Math Toolbox).

## See Also

### MuPAD Functions

genident | indets | int2text | interpolate | mods | numlib::g\_adic | poly | text2int

# getlasterror

Retrieve the last error number and text

## Syntax

```
getlasterror()
```

## Description

`getlasterror()` returns the last error that occurred in the current MuPAD session, as a list of the error number and the error string.

After an error has occurred (whether visible or caught by `traperror`), `getlasterror` will return both the error number (as returned by `traperror`) and the error string.

In a MuPAD session where no errors occurred, `getlasterror` returns the list `[0, ""]`. This is also true after a call to `reset()`.

---

**Note** Note that the MuPAD library uses `traperror` itself and that `getlasterror()` may return errors that have been caught and properly handled by the library already. You should not use `getlasterror` to detect errors, use the return value of `traperror` instead!

---

## Examples

### Example 1

In a fresh session, `getlasterror` returns a list indicating “no errors yet”:

```
getlasterror()
```

```
[0, ""]
```

After an error has been thrown, `getlasterror` returns the corresponding number and string:

```
ln(0)
```

```
Error: Singularity. [ln]
```

```
getlasterror()
```

```
[1028, "Error: Singularity. [ln]"]
```

This includes errors not displayed because of `traperror`:

```
traperror(solve(a, b, c))
```

```
1126
```

```
getlasterror()
```

```
[1126, "Error: Invalid argument number 3. Evaluating: solvelib::getOptions"]
```

## Return Values

List of an integer and a string

## See Also

### MuPAD Functions

`error` | `lasterror` | `traperror`

# getpid

Process ID of the running kernel

## Syntax

```
getpid()
```

## Description

getpid() returns the process ID of the running MuPAD kernel.

The process ID may be useful for generating names for temporary files by appending it to a file basename.

## Examples

### Example 1

Querying the process ID of the running kernel may produce a result like this:

```
getpid()
```

```
16184
```

## Return Values

Nonnegative integer.

## See Also

### **MuPAD Functions**

sysname | system



# getprop

Query properties of expressions

## Syntax

```
getprop(f)
```

```
getprop()
```

## Description

`getprop(f)` returns a set containing all possible values of the expression  $f$ .

The property mechanism (Symbolic Math Toolbox) helps to simplify expressions involving identifiers that carry “mathematical assumptions”. The function `assume` allows to set basic assumptions such as 'x is a real number' or 'x is an odd integer', say. Arithmetical expressions involving  $x$  may inherit such properties. E.g., '1 +  $x^2$  is positive' if 'x is a real number'.

`getprop(f)` examines the assumptions of all identifiers on page 7-29 in the expression  $f$  and derives a superset of all values of  $f$ .

Only basic mathematical properties can be represented with the available properties. Therefore, `getprop` performs certain simplifications during the derivation of a property for an expression. Thus it may happen that `getprop` derives a too large set.

`getprop` only shows a mathematical (super-)set of all possible values in respect to the assumptions. The command `property::showprops` displays a list of all valid assumptions for a special identifier.

## Examples

### Example 1

If  $x$  is a real number, then  $x^2 + 1$  must be positive:

```
assume(x, Type::Real):  
getprop(x^2 + 1)
```

$[1, \infty)$

If  $x$  represents a number in the interval  $[1, \text{infinity}[$ , the expression  $1 - x$  has the following property:

```
assume(x, Type::Interval([1], infinity)):  
getprop(1 - x)
```

$(-\infty, 0]$

```
unassume(x):
```

## Example 2

An expression returns the superset  $C_*$  or a set if it is constant, or if no properties are attached to the identifiers involved:

```
getprop(x), getprop(x + 2*y), getprop(sin(3))
```

$C, C, \{\sin(3)\}$

## Example 3

The functions `abs`, `Re`, and `Im` have a “minimal property”: they produce real values. In fact, `abs` produces nonnegative real values:

```
delete x:  
getprop(abs(x)), getprop(Re(x)), getprop(Im(x))
```

$[0, \infty), \mathbb{R}, \mathbb{R}$

## Parameters

**f**

An arithmetical expression (Symbolic Math Toolbox)

## Return Values

`getprop(f)` returns a (super-)set containig all possible values of the expression `f`.

## See Also

### **MuPAD Functions**

`Type::Property` | `assume` | `is` | `property::hasprop` | `property::showprops` | `unassume`

# gradient

Vector gradient

## Syntax

```
gradient(f, x)
```

```
gradient(f, x, ogCoord, <c>)
```

## Description

`gradient(f, x)` computes the vector gradient of the scalar function  $f(\vec{x})$  with respect

to  $\vec{x}$  in Cartesian coordinates. This is the vector  $\text{grad}(f) = \left( \frac{\partial}{\partial x_1} f, \dots, \frac{\partial}{\partial x_n} f \right)$ .

`ogCoord` can be the name of a three-dimensional orthogonal coordinate system predefined in the table `linalg::ogCoordTab`. See “Example 2” on page 1-891 (Symbolic Math Toolbox).

Alternatively, `ogCoord` can be a list of vector of algebraic expressions representing the scale factors of the coordinate system. See example “Example 3” on page 1-891 (Symbolic Math Toolbox). For details, see the description of the `Scales` option on the `linalg::ogCoordTab` page.

## Examples

### Example 1

Compute the vector gradient of the scalar function  $f(x, y) = x^2 + y$  in Cartesian coordinates:

```
delete x, y;  
gradient(x^2 + y, [x, y])
```

$$\begin{pmatrix} 2x \\ 1 \end{pmatrix}$$

### Example 2

Compute the gradient of the function  $f(r, \phi, z) = r \cos(\phi) z$  ( $0 \leq \phi < 2\pi$ ) in cylindrical coordinates:

```
delete r, z, phi:
gradient(r*cos(phi)*z, [r, phi, z], Cylindrical)
```

$$\begin{pmatrix} z \cos(\phi) \\ -z \sin(\phi) \\ r \cos(\phi) \end{pmatrix}$$

### Example 3

Compute the gradient of the function  $f(r, \phi, \theta) = r \sin(\phi) \cos(\theta)$  in spherical coordinates given by

$$\vec{x} = \begin{pmatrix} x \\ y \\ z \end{pmatrix} = \begin{pmatrix} r \sin(\theta) \cos(\phi) \\ r \sin(\theta) \sin(\phi) \\ r \cos(\theta) \end{pmatrix}$$

with  $0 \leq \theta \leq \pi$ ,  $0 \leq \phi < 2\pi$ .

The vectors

$$\vec{e}_r = \frac{\frac{\partial}{\partial r} \vec{x}}{\left| \frac{\partial}{\partial r} \vec{x} \right|} = \begin{pmatrix} \sin(\theta) \cos(\phi) \\ \sin(\theta) \sin(\phi) \\ \cos(\theta) \end{pmatrix}, \quad \vec{e}_\theta = \frac{\frac{\partial}{\partial \theta} \vec{x}}{\left| \frac{\partial}{\partial \theta} \vec{x} \right|} = \begin{pmatrix} \cos(\theta) \cos(\phi) \\ \cos(\theta) \sin(\phi) \\ -\sin(\theta) \end{pmatrix},$$

$$\vec{e}_\phi = \frac{\frac{\partial}{\partial \phi} \vec{x}}{\left| \frac{\partial}{\partial \phi} \vec{x} \right|} = \begin{pmatrix} -\sin(\phi) \\ \cos(\phi) \\ 0 \end{pmatrix}$$

form an orthogonal system in spherical coordinates.

The scaling factors of the corresponding coordinate transformation (see

`linalg::ogCoordTab`) are:  $g_1 = |\vec{e}_r| = 1$ ,  $g_2 = |\vec{e}_\theta| = r$ ,  $g_3 = |\vec{e}_\phi| = r \sin(\theta)$ , which we use in the following example to compute the gradient of the function  $f$  in spherical coordinates:

```
delete r, Theta, phi:
gradient(r*sin(phi)*cos(Theta), [r, Theta, phi],
        [1, r, r*sin(Theta)])
```

$$\begin{pmatrix} \cos(\text{Theta}) \sin(\text{phi}) \\ -\sin(\text{Theta}) \sin(\text{phi}) \\ \frac{\cos(\text{Theta}) \cos(\text{phi})}{\sin(\text{Theta})} \end{pmatrix}$$

The spherical coordinates are already defined in `linalg::ogCoordTab`. The last result can also be achieved with the input `gradient(r*sin(phi)*cos(Theta), [r, Theta, phi], Spherical)`:

```
gradient(r*sin(phi)*cos(Theta),
        [r, Theta, phi],
        Spherical)
```

$$\begin{pmatrix} \cos(\text{Theta}) \sin(\text{phi}) \\ -\sin(\text{Theta}) \sin(\text{phi}) \\ \frac{\cos(\text{Theta}) \cos(\text{phi})}{\sin(\text{Theta})} \end{pmatrix}$$

## Parameters

**f**

An arithmetical expression in the variables given in **x**

**x**

A list of (indexed) identifiers

**ogCoord**

The name of a 3 dimensional orthogonal coordinate system predefined in the table `linalg::ogCoordTab`, or a list of algebraic expressions representing the scale factors of an orthogonal coordinate system.

**c**

The parameter of the coordinate systems `EllipticCylindrical` on page 15-167 and `Torus` on page 15-167, respectively: an arithmetical expression (Symbolic Math Toolbox). The default value is `c = 1`.

## Return Values

Column vector of the domain `Dom::Matrix()`.

## See Also

### **MuPAD Functions**

`curl` | `divergence` | `laplacian` | `linalg::ogCoordTab` | `potential` |  
`vectorPotential`



## ground

Ground term (constant coefficient) of a polynomial

### Syntax

`ground(p)`

`ground(f)`

`ground(f, vars)`

### Description

`ground(p)` returns the constant coefficient  $p(0, 0, \dots)$  of the polynomial  $p$ .

The first argument can either be a polynomial expression, or a polynomial generated by `poly`, or an element of some polynomial domain overloading `ground`.

If the first argument  $f$  is not element of a polynomial domain, then `ground` converts the expression to a polynomial via `poly(f)`. If a list of indeterminates is specified, then the polynomial `poly(f, vars)` is considered.

The constant coefficient is returned as an arithmetical expression (Symbolic Math Toolbox).

The result of `ground` is not fully evaluated. Evaluation can be enforced by the function `eval`. Cf. "Example 2" on page 1-896 (Symbolic Math Toolbox).

`ground` returns `FAIL` if  $f$  cannot be converted to a polynomial in the specified indeterminates. Cf. "Example 3" on page 1-897 (Symbolic Math Toolbox).

## Examples

### Example 1

We demonstrate how the indeterminates influence the result:

```
f := 2*x^2 + 3*y + 1:  
ground(f), ground(f, [x]), ground(f, [y]),  
ground(poly(f)), ground(poly(f, [x])), ground(poly(f, [y]))
```

$1, 3 y + 1, 2 x^2 + 1, 1, 3 y + 1, 2 x^2 + 1$

The result is the evaluation at the origin:

```
subs(f, x = 0, y = 0), subs(f, x = 0), subs(f, y = 0)
```

$1, 3 y + 1, 2 x^2 + 1$

Note the difference between `ground` and `tcoeff`:

```
g := 2*x^2 + 3*y:  
ground(g), ground(g, [x]);  
tcoeff(g), tcoeff(g, [x]);
```

$0, 3 y$

$3, 3 y$

```
delete f, g:
```

### Example 2

The result of `ground` is not fully evaluated:

```
p := poly(27*x^2 + a, [x]): a := 5:  
ground(p), eval(ground(p))
```

`a, 5`

`delete p, a:`

### Example 3

The following expression is syntactically not a polynomial expression, and `ground` returns FAIL:

`f := (x^2 - 1)/(x - 1): ground(f)`

FAIL

After cancellation via `normal`, `ground` can compute the constant coefficient:

`ground(normal(f))`

1

`delete f:`

## Parameters

**p**

A polynomial (Symbolic Math Toolbox) of type `DOM_POLY`

**f**

A polynomial expression (Symbolic Math Toolbox)

**vars**

A list on page 7-41 of indeterminates of the polynomial: typically, identifiers on page 7-29 or indexed identifiers on page 1-1017

## Return Values

Element of the coefficient ring of  $p$ , an arithmetical expression (Symbolic Math Toolbox), or FAIL.

## Overloaded By

$f$ ,  $p$

## See Also

### MuPAD Functions

`coeff` | `collect` | `degree` | `degreevec` | `lcoeff` | `ldegree` | `lmonomial` | `lterm` | `monomials` | `nterms` | `nthcoeff` | `nthmonomial` | `nthterm` | `poly` | `poly2list` | `tcoeff`

# harmonic

Harmonic function

## Syntax

`harmonic(x)`

## Description

`harmonic(x) =  $\psi(x+1) + \text{EULER}$`  represents the harmonic function.

The harmonic function is defined for all complex arguments  $x$  apart from the singular points  $-1, -2, \dots$  (first order poles).

For positive integers  $x$  not larger than the value `Pref::autoExpansionLimit()`, the

harmonic function produces the harmonic number  $\text{harmonic}(x) = \sum_{k=1}^x \frac{1}{k}$ . Use `expand(harmonic(x))` to compute an explicit result for integers  $x$  larger than `Pref::autoExpansionLimit()`.

If  $x$  is a floating-point value, then a floating point value is returned.

Simplifications are implemented for rational numbers  $x$  with  $|x| \leq \text{Pref::autoExpansionLimit}$ . In particular, if  $x = \text{numer}(x)/k$  with denominators  $k = 1, 2, 3, 4,$  or  $6$ , then an explicit result is computed and returned. For other rational numbers

the functional equation  $\text{harmonic}(x+1) = \text{harmonic}(x) + \frac{1}{x}$  is used to obtain a result with an argument  $x$  from the interval  $(0, 1]$ .

For rational numbers  $x$  with  $|x| > \text{Pref::autoExpansionLimit}$ , these simplifications can be enforced via `expand`.

Some explicit formulas are implemented including

$$\text{harmonic}(0) = 0, \text{harmonic}\left(\frac{1}{2}\right) = 2 - 2 \ln(2)$$

$$\begin{aligned}\text{harmonic}\left(\frac{1}{3}\right) &= 3 - \frac{3 \ln(3)}{2} - \frac{\sqrt{3}}{6} \pi, & \text{harmonic}\left(\frac{2}{3}\right) &= \frac{3}{2} - \frac{3 \ln(3)}{2} + \frac{\sqrt{3}}{6} \pi, \\ \text{harmonic}\left(\frac{1}{4}\right) &= 4 - 3 \ln(2) - \frac{\pi}{2}, & \text{harmonic}\left(\frac{3}{4}\right) &= \frac{4}{3} - 3 \ln(2) + \frac{\pi}{2}, \\ \text{harmonic}\left(\frac{1}{6}\right) &= 6 - 2 \ln(2) - \frac{3 \ln(3)}{2} - \frac{\sqrt{3}}{2} \pi, & \text{harmonic}\left(\frac{5}{6}\right) &= \frac{6}{5} - 2 \ln(2) - \frac{3 \ln(3)}{2} + \frac{\sqrt{3}}{2} \pi, \\ \text{harmonic}(1) &= 1.\end{aligned}$$

The special value  $\text{harmonic}(\infty) = \infty$  is implemented.

For all other arguments, a symbolic function call of `harmonic` is returned.

The `expand` attribute uses the functional equation  $\text{harmonic}(x+1) = \text{harmonic}(x) + \frac{1}{x}$ , the reflection rule  $\text{harmonic}(-x) = \text{harmonic}(x) - \frac{1}{x} + \pi \cot(\pi x)$  and the Gauß multiplication formula for  $\text{harmonic}(kx)$  with some integer  $k$  to rewrite  $\text{harmonic}(x)$ . See “Example 3” on page 1-901 (Symbolic Math Toolbox) and “Example 4” on page 1-902 (Symbolic Math Toolbox).

## Environment Interactions

When called with a floating-point value  $x$ , the function is sensitive to the environment variable `DIGITS` which determines the numerical working precision.

## Examples

### Example 1

We demonstrate some calls with exact and symbolic input data:

`harmonic(3)`, `harmonic(10)`, `harmonic(3/2)`, `harmonic(25/7)`

$$\frac{11}{6}, \frac{7381}{2520}, \frac{8}{3} - 2 \ln(2), \text{harmonic}\left(\frac{4}{7}\right) + \frac{6461}{4950}$$

```
harmonic(x + sqrt(2)), harmonic(infinity)
```

$$\text{harmonic}(x + \sqrt{2}), \infty$$

Floating point values are computed for floating-point arguments:

```
harmonic(-5.2), harmonic(27.0), harmonic(2.0 + 3.0*I)
```

$$6.450681124, 3.891456753, 1.939042529 + 0.8733604498 i$$

## Example 2

harmonic is singular for negative integers:

```
harmonic(-2)
```

Error: Singularity. [harmonic]

## Example 3

For positive integers and rational numbers  $x$  with denominators 2, 3, 4 and 6, respectively, the result is expressed in terms of PI (Symbolic Math Toolbox) and  $\ln$ , if  $|x| < 500$ :

```
harmonic(-5/2)
```

$$\frac{8}{3} - 2 \ln(2)$$

```
harmonic(13/3)
```

$$\frac{8571}{1820} - \frac{\pi \sqrt{3}}{6} - \frac{3 \ln(3)}{2}$$

```
harmonic(101/6)
```

$$\frac{\pi \sqrt{3}}{2} - \frac{3 \ln(3)}{2} - 2 \ln(2) + \frac{257690034865853321191998}{68836669705906834284553}$$

For larger arguments, the `expand` attribute can be used to obtain such expressions:

```
harmonic(1001)
```

```
harmonic(1001)
```

```
expand(%)
```

```
5337003...5042517 / 7128865...3520000
```

## Example 4

The functions `diff`, `expand`, `float`, `limit`, and `series` handle expressions involving `harmonic`:

```
diff(harmonic(x^2 + 1), x), float(ln(3 + harmonic(sqrt(PI))))
```

```
2 x ψ'(x2 + 2), 1.482943321
```

```
expand(harmonic(2*x + 3))
```

```

$$\frac{\text{harmonic}(x + \frac{1}{2})}{2} + \ln(2) + \frac{\text{harmonic}(x)}{2} - \frac{1}{2(x + \frac{1}{2})} + \frac{1}{2x+1} + \frac{1}{2x+2} + \frac{1}{2x+3}$$

```

```
limit((x + 1)*harmonic(x), x = -1), limit(harmonic(x), x = infinity)
```

```
-1, ∞
```

```
series(harmonic(x), x = 0)
```

```

$$\frac{x \pi^2}{6} - x^2 \zeta(3) + \frac{x^3 \pi^4}{90} - x^4 \zeta(5) + \frac{x^5 \pi^6}{945} - x^6 \zeta(7) + O(x^7)$$

```

```
series(harmonic(x), x = infinity, 3)
```



$$\text{EULER} + \ln(x) + \frac{1}{2x} - \frac{1}{12x^2} + O\left(\frac{1}{x^3}\right)$$

## Parameters

**x**

An arithmetical expression (Symbolic Math Toolbox)

## Return Values

Arithmetical expression.

## Overloaded By

**x**

## See Also

### **MuPAD Functions**

beta | binomial | fact | gamma | lngamma | zeta

## has

Check if an object occurs in another object

### Syntax

```
has(object1, object2)
```

```
has(object1, l)
```

### Description

`has(object1, object2)` checks, whether `object2` occurs syntactically in `object1`.

`has` is a fast test for the existence of sub-objects or subexpressions. It works syntactically, i.e., mathematically equivalent objects are considered to be equal only if they are syntactically identical. See “Example 2” on page 1-906 (Symbolic Math Toolbox).

If `object1` is an expression on page 7-20, then `has(object1, object2)` tests whether `object1` contains `object2` as a subexpression. Only complete subexpressions and objects occurring in the 0th operand of a subexpression are found (see “Example 1” on page 1-905 (Symbolic Math Toolbox)).

If `object1` is a container, then `has` checks whether `object2` occurs in an entry of `object1`. See “Example 5” on page 1-907 (Symbolic Math Toolbox).

In this context, a floating-point interval on page 7-33 is considered a container for (an infinite number of) complex numbers and `has` checks whether a given number is *inside* the interval. See “Example 4” on page 1-907 (Symbolic Math Toolbox).

If the second argument is a list on page 7-41 or a set on page 7-50 `l`, then `has` returns TRUE if at least one of the elements in `l` occurs in `object1` (see “Example 3” on page 1-906 (Symbolic Math Toolbox)). In particular, if `l` is the empty list or the empty set, then the return value is FALSE.

If `object1` is an element of a domain (Symbolic Math Toolbox) with a “has” slot, then the slot routine is called with the same arguments, and its result is returned. If the

domain does not have such a slot, then `FALSE` will be returned. See “Example 7” on page 1-908 (Symbolic Math Toolbox).

If `has` is called with a list or set as second argument, then the “has” slot of the domain of `object1` is called for each object of the list or the set. When the first object is found that occurs in `object1`, the evaluation is terminated and `TRUE` is returned. If none of the objects occurs in `object1`, `FALSE` will be returned.

## Examples

### Example 1

The given expression has `x` as an operand:

```
has(x + y + z, x)
```

`TRUE`

Note that `x + y` is not a complete subexpression. Only `x`, `y`, `z` and `x + y + z` are complete subexpressions:

```
has(x + y + z, x + y)
```

`FALSE`

However, `has` also finds objects in the 0th operand of a subexpression:

```
has(x + sin(x), sin)
```

`TRUE`

Every object occurs in itself:

```
has(x, x)
```

`TRUE`

## Example 2

`has` works in a purely syntactical fashion. Although the two expressions  $y*(x + 1)$  and  $y*x + y$  are mathematically equivalent, they differ syntactically:

```
has(sin(y*(x + 1)), y*x + y),  
has(sin(y*(x + 1)), y*(x + 1))
```

FALSE, TRUE

Complex numbers on page 7-84 are not regarded as atomic objects:

```
has(2 + 5*I, 2), has(2 + 5*I, 5), has(2 + 5*I, I)
```

TRUE, TRUE, TRUE

In contrast, rational numbers on page 7-48 are considered to be atomic:

```
has(2/3*x, 2), has(2/3*x, 3), has(2/3*x, 2/3)
```

FALSE, FALSE, TRUE

## Example 3

If the second argument is a list or a set, `has` checks whether one of the entries occurs in the first argument:

```
has((x + y)*z, [x, t])
```

TRUE

0th operands of subexpressions are checked as well:

```
has((a + b)*c, {_plus, _mult})
```

TRUE

## Example 4

On floating-point intervals on page 7-33, `has` performs a containment check, not just testing the borders:

```
has(1...3, 1)
```

```
TRUE
```

```
has(1...3, 2.7182), has(1...3, exp(1)), has(1...3, PI)
```

```
TRUE, TRUE, FALSE
```

```
has(1...(3+I), [2, ln(3)])
```

```
TRUE
```

## Example 5

`has` works for lists on page 7-41, sets on page 7-50, tables on page 1-2103, arrays on page 7-2, and `hfarrays` on page 7-27:

```
has([sin(f(a) + 2), cos(x), 3], {f, g})
```

```
TRUE
```

```
has({a, b, c, d, e}, {a, z})
```

```
TRUE
```

```
has(array(1..2, 1..2, [[1, 2], [3, 4]]), 2)
```

```
TRUE
```

For an array `A`, the command `has(A, NIL)` checks whether the array has any uninitialized entries:

```
has(array(1..2, 1 = x), NIL),  
has(array(1..2, [2, 3]), NIL)
```

TRUE, FALSE

For tables, `has` checks indices, entries, as well as the internal operands of a table, given by equations of the form `index=entry`:

```
T := table(a = 1, b = 2, c = 3):  
has(T, a), has(T, 2), has(T, b = 2)
```

TRUE, TRUE, TRUE

### Example 6

`has` works syntactically. Although the variable `x` does not occur mathematically in the constant polynomial `p` in the following example, the identifier `x` occurs syntactically in `p`, namely, in the second operand:

```
delete x: p := poly(1, [x]):  
has(p, x)
```

TRUE

### Example 7

The second argument may be an arbitrary MuPAD object, even from a user-defined domain (Symbolic Math Toolbox):

```
T := newDomain("T"):  
e := new(T, 1, 2);  
f := [e, 3];
```

`new(T, 1, 2)`

`[new(T, 1, 2), 3]`

```
has(f, e), has(f, new(T, 1))
```

TRUE, FALSE

If the first argument of `has` belongs to a domain (Symbolic Math Toolbox) without a "has" slot, then `has` always returns FALSE:

```
has(e, 1)
```

FALSE

Users can overload (Symbolic Math Toolbox)`has` for their own domains (Symbolic Math Toolbox). For illustration, we supply the domain `T` with a "has" slot, which puts the internal operands of its first argument in a list and calls `has` for the list:

```
T::has := (object1, object2) -> has([extop(object1)], object2):
```

If we now call `has` with the object `e` of domain type `T`, the slot routine `T::has` is invoked:

```
has(e, 1), has(e, 3)
```

TRUE, FALSE

The slot routine is also called if an object of domain type `T` occurs syntactically in the first argument:

```
has(f, 1), has(f, 3)
```

TRUE, TRUE

## Parameters

**object1, object2**

Arbitrary MuPAD objects

**l**

A list on page 7-41 or a set on page 7-50

## **Return Values**

Either TRUE or FALSE

## **Overloaded By**

object1

## **See Also**

### **MuPAD Functions**

`_in` | `_index` | `contains` | `hastype` | `op` | `subs` | `subsex`



# hastype

Test if an object of a specified type occurs in another object

## Syntax

```
hastype(object, T, <inspect>)
```

## Description

`hastype(object, T)` tests if an object of type `T` occurs syntactically in `object`.

`hastype(object, T)` tests if a sub-object `s` of type `T` occurs in `object`, i.e., such that `testtype(s, T)` returns `TRUE`.

The type specifier `T` may be either a domain type (Symbolic Math Toolbox) such as `DOM_INT`, `DOM_EXPR` etc., a string on page 7-53 as returned by the function `type`, or a Type (Symbolic Math Toolbox) object. The latter are probably the most useful predefined values for the argument `T`.

If `T` is not a valid type specifier, then `hastype` returns `FALSE`.

See “Example 1” on page 1-912 (Symbolic Math Toolbox).

If `object` is an expression on page 7-20, then `hastype(object, T)` tests whether `object` contains a subexpression of type `T`; see “Example 1” on page 1-912 (Symbolic Math Toolbox).

If `object` is a container, then `hastype` checks whether a sub-object of type `T` occurs in an entry of `object`; see “Example 4” on page 1-914 (Symbolic Math Toolbox).

If the second argument is a list on page 7-41 or a set on page 7-50, `hastype` checks whether a sub-object of one of the types in `T` occurs in `object`. See “Example 1” on page 1-912 (Symbolic Math Toolbox).

`hastype` works in a recursive fashion and descends into the following objects: expressions on page 7-20, arrays on page 7-2, `hfarrays` on page 7-27, lists on

page 7-41, sets on page 7-50, and tables on page 1-2103. See “Example 4” on page 1-914 (Symbolic Math Toolbox). `hastype` does not step into the other basic domains (Symbolic Math Toolbox), such as rational numbers on page 7-48, complex numbers on page 7-84, polynomials on page 1-1601, or procedures on page 7-45. See “Example 2” on page 1-913 (Symbolic Math Toolbox).

If the third argument `inspect` is present, then `hastype` also steps recursively into sub-objects of the domain types (Symbolic Math Toolbox) given in `inspect`. See “Example 2” on page 1-913 (Symbolic Math Toolbox).

---

**Note** `hastype` looks only for sub-objects that are syntactically of type `T`. Properties (Symbolic Math Toolbox) of identifiers set via `assume` are not taken into account; see “Example 4” on page 1-914 (Symbolic Math Toolbox).

---

## Examples

### Example 1

In this example, we first test if a given expression has a subexpression of type `DOM_FLOAT`:

```
hastype(1.0 + x, DOM_FLOAT)
```

```
TRUE
```

```
hastype(1 + x, DOM_FLOAT)
```

```
FALSE
```

We may also test if an expressions contains a subexpression of one of the two types `DOM_FLOAT` or `DOM_INT`:

```
hastype(1.0 + x, {DOM_FLOAT, DOM_INT})
```

```
TRUE
```

While the first of following two tests returns FALSE, since `tan` is not a valid type specifier, the second test yields TRUE, since the given expression contains a subexpression of type "tan":

```
hastype(sin(tan(x) + 1/exp(1 - x)), tan),
hastype(sin(tan(x) + 1/exp(1 - x)), "tan")
```

FALSE, TRUE

You can also use type specifiers from the Type (Symbolic Math Toolbox) library:

```
hastype([-1, 10, -5, 2*I], Type::PosInt)
```

TRUE

## Example 2

We demonstrate the use of the optional third argument. We want to check if a procedure on page 7-45 contains a subexpression of type "float". By default, `hastype` does not descend recursively into a procedure:

```
f := x -> float(x) + 3.0:
hastype(f, "float")
```

FALSE

You can use the third argument to request the inspection of procedures explicitly:

```
hastype(f, "float", {DOM_PROC})
```

TRUE

Also, by default, `hastype` does not descend recursively into the basic domains `DOM_COMPLEX` and `DOM_RAT`:

```
hastype(1 + I, DOM_INT), hastype(2/3, DOM_INT)
```

FALSE, FALSE

In order to inspect these data types, one has to use the third argument:

```
hastype(1 + I, DOM_INT, {DOM_COMPLEX}),  
hastype(2/3, DOM_INT, {DOM_RAT})
```

TRUE, TRUE

### Example 3

Since matrices possess a slot `enableMaprec`, `hastype` automatically inspects their entries.

```
A := matrix([[1, 1], [1, 0]]):  
hastype(A, DOM_INT)
```

TRUE

It is also possible to inspect elements of other domains using the third argument. As an example let us define a permutation and ask for a subexpression of type integer:

```
G:= Dom::SymmetricGroup(4):  
perm:= G([2,4, 3, 1]):  
hastype(perm, DOM_INT), hastype(perm, DOM_INT, {G})
```

FALSE, TRUE

### Example 4

We demonstrate how `hastype` effects on container objects. Let us first stress tables:

```
hastype(table(1 = a), DOM_INT), hastype(table(a = 1), DOM_INT)
```

FALSE, TRUE

As shown, `hastype` does not inspect the indices of a table, but checks recursively whether a sub-object of a given type occurs in an entry. This is also true for arrays, `hfarrays`, lists and sets:

```
hastype(array(1..4, [1, 2, 3, 4]), DOM_INT),  
hastype(hfarray(1..3, [1.0, 2.0, 3.0*I]), DOM_COMPLEX),  
hastype([1, 2, 3, 4], DOM_INT),  
hastype({1, 2, 3, 4}, DOM_INT),  
hastype([a, [1]], b, c), DOM_INT)
```

TRUE, TRUE, TRUE, TRUE, TRUE

hastype can only work syntactically, i.e. properties are not taken into account:

```
assume(a, Type::Integer):  
hastype([a, b], Type::Integer), hastype([a, b], DOM_INT)
```

FALSE, FALSE

delete a:

## Parameters

### **object**

An arbitrary MuPAD object

### **T**

A type specifier, or a set on page 7-50 or a list on page 7-41 of type specifiers

### **inspect**

A set on page 7-50 of domain types (Symbolic Math Toolbox)

## Return Values

Either TRUE or FALSE.

## Overloaded By

object

## See Also

### MuPAD Functions

domtype | has | misc::maprec | testtype | type

# heaviside

The Heaviside step function

## Syntax

`heaviside(x)`

## Description

`heaviside(x)` represents the Heaviside step function.

If the argument represents a positive real number, then 1 is returned. If the argument represents a negative real number, then 0 is returned. If the argument is zero,  $\frac{1}{2}$  is returned. If the argument is a complex number of domain type `DOM_COMPLEX`, then undefined is returned. For all other arguments, an unevaluated function call is returned.

The derivative of `heaviside` is the delta distribution `dirac`.

To change the value of `heaviside` at the origin, use `Pref::heavisideAtOrigin`. See “Example 4” on page 1-919 (Symbolic Math Toolbox). Common choices for this value are 0, 1, and 1/2.

## Examples

### Example 1

`heaviside` returns 1 or 0 for arguments representing positive or negative real numbers, respectively:

```
heaviside(-3), heaviside(-sqrt(3)), heaviside(-2.1),  
heaviside(PI - exp(1)), heaviside(sqrt(3))
```

```
0, 0, 0.0, 1, 1
```

heaviside returns  $\frac{1}{2}$  if the argument is zero:

```
heaviside(0), heaviside(0.0)
```

```
 $\frac{1}{2}$ , 0.5
```

Arguments of domain type DOM\_COMPLEX yield undefined:

```
heaviside(1 + I), heaviside(2/3 + 7*I), heaviside(0.1*I)
```

```
undefined, undefined, undefined
```

An unevaluated call is returned for other arguments:

```
heaviside(x), heaviside(ln(-5)), heaviside(x + I)
```

```
heaviside(x), undefined, heaviside(x + i)
```

## Example 2

heaviside reacts to assumptions set by assume:

```
assume(x > 0): heaviside(x)
```

```
1
```

```
unassume(x):
```

## Example 3

The derivative of heaviside is the delta distribution dirac:

```
diff(heaviside(x - 4), x)
```

```
 $\delta(x - 4)$ 
```



The integrator `int` handles `heaviside`:

```
int(exp(-x)*heaviside(x), x = -infinity..infinity)
```

1

We do not recommend to use `heaviside` in numerical integration. It is much more efficient to split the quadrature into pieces, each of which having a smooth integrand:

```
DIGITS := 3: numeric::int(exp(-x)*heaviside(x^2 - 2), x=-3..10)
```

16.2

```
numeric::int(exp(-x), x = -3..-2^(1/2)) +
numeric::int(exp(-x), x = 2^(1/2)..10)
```

16.2

```
delete DIGITS:
```

## Example 4

`heaviside` assumes that the value of the Heaviside function at the origin is  $1/2$ .

```
heaviside(0)
```

$\frac{1}{2}$

Other common values for the Heaviside function at the origin are  $0$  and  $1$ . To change the value of `heaviside` at the origin, use `Pref::heavisideAtOrigin`. Store the previous value, so that you can restore it later.

```
oldval := Pref::heavisideAtOrigin(1):
```

Check the new value of `heaviside` at  $0$ .

```
heaviside(0)
```

## 1

Restore the previous value of `heavisideAtOrigin` using `oldval`.

```
Pref::heavisideAtOrigin(oldval):
```

Also, you can restore the default value of `heavisideAtOrigin` by specifying the input as `NIL`.

```
Pref::heavisideAtOrigin(NIL):
```

## Parameters

**x**

An arithmetical expression (Symbolic Math Toolbox)

## Return Values

Arithmetical expression.

## Overloaded By

x

## See Also

### MuPAD Functions

`Pref::heavisideAtOrigin` | `dirac`

## ?help

Display a help page

## Syntax

?word

help("word")

## Description

help("word") or ?word displays a help page with information about the keyword word.

When you use help("word") interactively, you can use ?word as a shortcut. The ? command is not a MuPAD function. You cannot use ? in expressions or in files. Do not enclose word in quotation marks, and do not terminate it with a semicolon.

## Parameters

**word**

Any keyword

## Return Values

Void object null() of type DOM\_NULL.

## See Also

**MuPAD Functions**

info

## hessian

Hessian matrix of a scalar function

### Syntax

```
hessian(f, x)
```

### Description

`hessian(f, x)` computes the Hesse matrix (the Hessian) of the scalar function  $f(\vec{x})$  in Cartesian coordinates, i.e., the square matrix of second partial derivatives of  $f(\vec{x})$ .

### Examples

#### Example 1

The Hessian of the function  $f(x, y, z) = xy + 2xz$  is the following matrix:

```
delete x, y, z:  
hessian(x*y + 2*z*x, [x, y, z])
```

$$\begin{pmatrix} 0 & 1 & 2 \\ 1 & 0 & 0 \\ 2 & 0 & 0 \end{pmatrix}$$

### Parameters

**f**

An arithmetical expression (the scalar function)

**x**

A list of (indexed) identifiers

## Return Values

Matrix of the domain Dom::Matrix().

## Algorithms

For a function  $f: X \rightarrow \mathbb{R}$ ,  $X$  a subset of  $\mathbb{R}^p$ , the  $p \times p$  matrix

$$H_f(\vec{x}) = \begin{pmatrix} \frac{\partial^2}{\partial x_1^2} f & \frac{\partial}{\partial x_1} \frac{\partial}{\partial x_2} f & \dots & \frac{\partial}{\partial x_1} \frac{\partial}{\partial x_p} f \\ \frac{\partial}{\partial x_2} \frac{\partial}{\partial x_1} f & \frac{\partial^2}{\partial x_2^2} f & \dots & \frac{\partial}{\partial x_2} \frac{\partial}{\partial x_p} f \\ \vdots & \vdots & \ddots & \vdots \\ \frac{\partial}{\partial x_p} \frac{\partial}{\partial x_1} f & \frac{\partial}{\partial x_p} \frac{\partial}{\partial x_2} f & \dots & \frac{\partial^2}{\partial x_p^2} f \end{pmatrix}$$

is called the *Hesse matrix* of  $f$ .

## See Also

### MuPAD Functions

diff | gradient | jacobian

# HISTORY

Maximal number of elements in the history table

## Description

The environment variable `HISTORY` determines the maximal number of entries of the history table at interactive level.

Possible values: Nonnegative integer on page 7-31 smaller than  $2^{31}$ .

The commands that are entered interactively in a MuPAD session, executed in a procedure on page 7-45, or read from a file, as well as the resulting MuPAD outputs are stored in an internal data structure, the history table. Only the most recent entries are kept in memory.

Entries of the history table can be accessed via `history` or `last`.

The default value of `HISTORY` is 20; `HISTORY` has this value after starting or resetting the system via `reset`. Also the command `delete HISTORY` restores the default value.

Within a procedure on page 7-45, the maximal number of entries in the local history table of the procedure is always 3, independent of the value of `HISTORY`.

## Examples

### Example 1

In the following example, we set the value of `HISTORY` to 2. Afterwards, only the two most recent inputs and outputs are stored in the history table at interactive level:

```
HISTORY := 2:  
a := 1: b := 2: max(a, b):  
history(history() - 1), history(history())
```

```
[b := 2, 2], [max(a, b), 2]
```

The attempt to access the third last entry in the history table leads to an error:

```
history(history() - 2)
```

```
Error: Invalid argument. [history]
```

We use `delete` to restore the default value of HISTORY:

```
delete HISTORY: HISTORY
```

20

## See Also

### MuPAD Functions

history | last

## history

Access an entry of the history table

### Syntax

`history(n)`

`history()`

### Description

`history(n)` returns the *n*th entry of the history table.

`history()` returns the index of the most recent entry in the history table.

The commands that are entered interactively in a MuPAD session, executed in a procedure on page 7-45, or read from a file, as well as the resulting MuPAD outputs are stored in an internal data structure, the history table. `history()` returns the index of the most recent entry in the history table. At interactive level, this is the number of commands that have been entered since the start of the session or the last restart on page 1-1796.

`history(n)` returns the *n*th entry in the history table in form of a list with two elements. The first element of this list is a MuPAD command, and the second element is the result of this command returned by MuPAD. The order of the entries in the history table is such that larger indices correspond to more recent entries.

The command `last` accesses the result entries from the history table. The call `last(n)` is equivalent to `history ( history() - n + 1) [2]` at interactive level.

The environment variable `HISTORY` determines the maximal number of history entries that are stored at interactive level. The default value is 20. Only the most recent entries are kept in memory. Thus valid arguments for `history` are all integers between `history() - HISTORY + 1` and `history()`. All other integers lead to an error message.



The result returned by `history` is not evaluated again (see example `history-eval` on page 1-928 (Symbolic Math Toolbox)). Use the function `eval` to force a subsequent evaluation.

Commands and their results are stored in the history table even if the output is suppressed by a colon. See “Example 1” on page 1-927 (Symbolic Math Toolbox).

Compound statements, such as `for`, `repeat`, and `while` loops, `if` and `case` branching instructions, and procedure definitions via `proc` are stored in the history table as a whole at interactive level. See the help page of `last` for examples.

Commands appearing on the same input line lead to separate entries in the history table if they are separated by a colon or a semicolon. In contrast, a statement sequence on page 1-95 is regarded as a single command (see “Example 3” on page 1-929 (Symbolic Math Toolbox)).

Commands that are read from a file via `fread` or `read` are stored in the history table, and at last the `fread` or `read` command is stored in the history table (because the `fread` or `read` command is finished foremost after reading the file). However, if the option `Plain` is used, then a separate history table is in effect within the file, and the commands from the file do not appear in the history table of the enclosing context.

Note that every call of `history` modifies the history table and possibly erases the earliest history entry.

Every procedure on page 7-45 has its own local history table. However, the entries of this table cannot be accessed via `history` (see `last`). The command `history` always refers to the history table at interactive level.

## Examples

### Example 1

The index of the most recent entry in the history table increases by one for each entered command, also by `history()`. Note that every command is stored in the history table, whether its output is suppressed by a colon or not:

```
history(); sqrt(1764); history(): history()
```

```
3 42 6
```

`history ( history() )` returns a list with two elements. The first element is the last command, and the second element is the result returned by MuPAD, which is equal to `last(1)` or `%`:

```
int(2*x*exp(x^2), x);  
history(history()), last(1)
```

$e^{x^2}$

$\left[ \int 2 x e^{x^2} dx, e^{x^2} \right], e^{x^2}$

The following command returns the next to last command and its result:

```
history(history() - 1)
```

$\left[ \int 2 x e^{x^2} dx, e^{x^2} \right]$

A restart on page 1-1796 cleans up the history table:

```
reset():  
history()
```

4

The output of the command `history()` above depends on the number of commands in your MuPAD startup file `userinit.mu`.

## Example 2

First a should be 0:

```
a := 0:  
a
```

0

Now 1 is assigned to a:

```
a := 1:
a
```

```
1
```

The command `history ( history() -2)` refers to the command a after assigning 0 to a, the return value of `history` is not the new value of a, because the result returned by `history` is not evaluated on page 1-242 (Symbolic Math Toolbox) again:

```
history(history() - 2)
```

```
[a, 0]
```

### Example 3

The following commands create two entries in the history table. The command `history ( history() -1)` returns only the last command `b:=a`, not both commands:

```
a := 0: b := a:
history(history() - 1)
```

```
[a :=0, 0]
```

If the commands are entered as a statement sequence on page 1-95 (enclosed in ( )), they create one entry. `history ( history() )` picks out the last command, that is, the statement sequence:

```
(a := 0; b := a;):
history(history())
```

```
[(a := 0;
b := a), 0]
```

The last input

```
type(op(%, 1))
```

"\_stmtseq"

## Parameters

**n**

A positive integer on page 7-31

## Return Values

`history(n)` returns a list on page 7-41 with two elements, and `history()` returns a nonnegative integer on page 7-31.

## See Also

### **MuPAD Functions**

HISTORY | `fread` | `last` | `read`

# hold

Delay evaluation

## Syntax

`hold(object)`

## Description

`hold(object)` prevents the evaluation of `object`.

When a MuPAD object is entered interactively, then the system evaluates it and returns the evaluated result. When a MuPAD object is passed as an argument to a procedure on page 7-45, then the procedure usually evaluates the argument before processing it. *Evaluation* means that identifiers on page 7-29 are replaced by their values and function calls are executed. `hold` is intended to prevent such an evaluation when it is undesirable.

A typical application of `hold` is when a function that can only process numerical arguments, but not symbolical ones, is to be used as an expression. See “Example 6” on page 1-936 (Symbolic Math Toolbox).

Another possible reason for using `hold` is efficiency. For example, if a function call  $f(x, y)$  with symbolic arguments is passed as argument to another function, but is known to return itself symbolically, then the possibly costly evaluation of the “inner” function call can be avoided by passing the expression `hold(f)(x, y)` as argument to the “outer” function instead. Then the arguments  $x, y$  are evaluated, but the call to  $f$  is not executed. See examples “Example 1” on page 1-932 (Symbolic Math Toolbox) and “Example 7” on page 1-937 (Symbolic Math Toolbox).

Since using `hold` may lead to strange effects, it is recommended to use it only when absolutely necessary.

`hold` only delays the evaluation of an object, but cannot completely prevent it on the long run; see “Example 5” on page 1-935 (Symbolic Math Toolbox).

You can use `freeze` to completely prevent the evaluation of a procedure on page 7-45 or a function environment on page 7-25.

A MuPAD procedure on page 7-45 can be declared with the option `hold` on page 1-2014 (Symbolic Math Toolbox). This has the effect that arguments are passed to the procedure unevaluatedly. See the help page of `proc` for details.

The functions `eval` or `level` can be used to force a subsequent evaluation of an unevaluated object (see example “Example 2” on page 1-934 (Symbolic Math Toolbox)). In procedures with option `hold`, use `context` instead.

## Examples

### Example 1

In the following two examples, the evaluation of a MuPAD expression is prevented using `hold`:

```
x := 2:  
hold(3*0 - 1 + 2^2 + x)
```

$3 \cdot 0 - 1 + 2^2 + x$

```
hold(error("not really an error"))
```

`error("not really an error")`

Without `hold`, the results would be as follows:

```
x := 2:  
3*0 - 1 + 2^2 + x
```

5

```
error("not really an error")
```

```
Error: not really an error
```

The following command prevents the evaluation of the operation `_plus`, but not the evaluation of the operands:

```
hold(_plus)(3*0, -1, 2^2, x)
```

$$0 - 1 + 4 + 2$$

Note that in the preceding example, the arguments of the function call are evaluated, because `hold` is applied only to the function `_plus`. In the following example, the argument of the function call is evaluated, despite that fact that `f` has the option `hold` on page 1-2014 (Symbolic Math Toolbox):

```
f := proc(a)
    option hold;
    begin
        return(a + 1)
    end_proc;
x := 2;
hold(f)(x)
```

$$f(2)$$

This happens for the following reason. When `f` is evaluated, the option `hold` prevents the evaluation of the argument `x` of `f` (see the next example). However, if the evaluation of `f` is prevented by `hold`, then the option `hold` has no effect, and MuPAD evaluates the operands, but not the function call.

The following example shows the expected behavior:

```
f(x), hold(f(x))
```

$$x + 1, f(x)$$

The function `eval` undoes the effect of `hold`. Note that it yields quite different results, depending on how it is applied:

```
eval(f(x)), eval(hold(f)(x)), eval(hold(f(x))), eval(hold(f))(x))
```

$$3, 3, x + 1, x + 1$$

## Example 2

Several `hold` calls can be nested to prevent subsequent evaluations:

```
x := 2;  
hold(x), hold(hold(x))
```

```
x, hold(x)
```

The result of `hold ( hold(x) )` is the unevaluated operand of the outer call of `hold`, that is, `hold(x)`. Applying `eval` evaluates the result `hold(x)` and yields the unevaluated identifier `x`:

```
eval(%)
```

```
2, x
```

Another application of `eval` yields the value of `x`:

```
eval(%)
```

```
2, 2
```

```
delete x, f:
```

## Example 3

The following command prevents the evaluation of the operation `_plus`, replaces it by the operation `_mult`, and then evaluates the result:

```
eval(subsop(hold(_plus)(2, 3), 0 = _mult))
```

```
6
```

## Example 4

The function `domtype` evaluates its arguments:



```
x := 0:
domtype(x), domtype(sin), domtype(x + 2)
```

DOM\_INT, DOM\_FUNC\_ENV, DOM\_INT

Using `hold`, the domain type of the unevaluated objects can be determined: `x` and `sin` are identifiers, and `x + 2` is an expression:

```
domtype(hold(x)), domtype(hold(sin)), domtype(hold(x + 2))
```

DOM\_IDENT, DOM\_IDENT, DOM\_EXPR

## Example 5

`hold` prevents only one evaluation of an object, but it does not prevent evaluation at a later time. Thus using `hold` to obtain a symbol without a value is usually not a good idea:

```
x := 2:
y := hold(x);
y
```

`x`

`2`

In this example, deleting on page 1-499 the value of the identifier `x` makes it a symbol, and using `hold` is not necessary:

```
delete x:
y := x;
y
```

`x`

`x`

However, the best way to obtain a new symbol without a value is to use `genident`:

```
y := genident("z");  
y
```

```
z1
```

```
z1
```

```
delete y:
```

## Example 6

Consider the piecewise defined function  $f(x)$  that is identically zero on the negative real axis and equal to  $e^{-x}$  on the positive real axis:

```
f := x -> if x < 0 then 0 else exp(-x) end_if:
```

This function cannot be called with a symbolic argument, because the condition  $x < 0$  cannot be decided:

```
f(x)
```

```
Error: Unable to evaluate to Boolean. [_less]  
Evaluating: f
```

We wish to integrate  $f$  numerically. However, the numerical integrator on page 19-136 expects the function as an expression:

```
numeric::int(f(x), x = -2..2)
```

```
Error: Unable to evaluate to Boolean. [_less]  
Evaluating: f
```

The solution is to suppress premature evaluation of  $f$  when passing the function with a symbolic argument. Inside the numerical integrator, numerical values are substituted for  $x$  before the function is called and evaluated:

```
numeric::int(hold(f)(x), x = -2..2)
```

0.8646647168

**Example 7**

The function `int` is unable to compute a closed form of the following integral and returns a symbolic `int` call:

```
int(sqrt(x)*sqrt(sqrt(x) + 1), x)
```

$$\int \sqrt{x} \sqrt{\sqrt{x} + 1} dx$$

After the change of variables on page 14-6  $\sqrt{x}=t$ , a closed form can be computed:

```
t := time();
f := intlib::changevar(int(sqrt(x)*sqrt(sqrt(x) + 1), x), sqrt(x) = y);
time() - t;
eval(f)
```

$$\int \frac{y \sqrt{y+1}}{\sqrt{-y^2+1}} dy$$

9210

$$-\frac{2(y+2)\sqrt{-y^2+1}}{3\sqrt{y+1}}$$

$$\int 2y^2 \sqrt{y+1} dy$$

$$-\frac{4(y+1)^{3/2}(42y-15(y+1)^2+7)}{105}$$

Measuring computing times with `time` shows: Most of the time in the call to `intlib::changevar` is spent in re-evaluating the argument. This can be prevented by using `hold`:

```
t := time();
f := intlib::changevar(hold(int)(sqrt(x)*sqrt(sqrt(x) + 1), x),
                      sqrt(x) = y);
time() - t;
```

$$\int \frac{y \sqrt{y+1}}{\sqrt{-y^2+1}} dy$$

20

## Parameters

### object

Any MuPAD object

## Return Values

Unevaluated object.

## See Also

### MuPAD Functions

`context` | `delete` | `eval` | `freeze` | `genident` | `indexval` | `level` | `proc` | `val`

## **Topics**

“Prevent Evaluation” (Symbolic Math Toolbox)

## **...hull**

Convert to a floating-point interval

### **Syntax**

```
l ... r  
hull(object)
```

### **Description**

`hull(object)` returns a floating-point interval on page 7-33 enclosing `object`.

`l ... r` is equivalent to `hull(l, r)`.

`hull` converts numerical and interval expressions to numerical intervals of type `DOM_INTERVAL`. It accepts lists and sets of numerical expressions or intervals as well as numerical expressions, intervals, and set-theoretic functions of intervals and sets.

Infinities are displayed using `RD_INF` for infinity and `RD_NINF` for -infinity.

`hull` is mapped recursively to the operands of any expression given—but for subexpressions, lists and sets are not accepted. Identifiers are replaced by intervals, respecting a certain subset of properties (Symbolic Math Toolbox). Cf. “Example 3” on page 1-942 (Symbolic Math Toolbox). Likewise, function calls and domain elements not overloading `hull` are converted to the interval representing the complex plane.

The output of floating-point intervals is influenced by the same parameters as the output of floating-point numbers:

`DIGITS`, `Pref::floatFormat`, and `Pref::trailingZeroes`.

### **Environment Interactions**

The function is sensitive to the environment variable `DIGITS` which determines the numerical working precision.

Each sub-object of `object` can be evaluated multiple times and must not have any side-effects.

## Examples

### Example 1

`hull` returns an interval enclosing its arguments. You can also use the operator `...` instead of the function call:

```
hull(0, PI) = 0 ... PI
```

```
0.0 ... 3.141592654 = 0.0 ... 3.141592654
```

Infinities are displayed using `RD_NINF` for  $-\infty$  and `RD_INF` for *infinity*:

```
hull(-infinity, 9/7), hull({1/4, 9/7, infinity})
```

```
RD_NINF ... 1.285714286, 0.25 ... RD_INF
```

Please note that any number whose absolute value is larger than MuPAD can store in a float is considered infinite:

```
hull(0, 1e100000000)^4
```

```
0.0 ... RD_INF
```

### Example 2

Inversion of intervals may lead to unions of intervals. If these are not required, you may use `hull` to unify them:

```
1/(-1 ... 1); hull(%)
```

```
RD_NINF ... -1.0 ∪ 1.0 ... RD_INF
```

$RD\_NINF \dots RD\_INF$

### Example 3

The application of `hull` to an identifier without a value returns an interval representing the complex plane:

```
delete x: hull(x)
```

$RD\_NINF \dots RD\_INF + RD\_NINF \dots RD\_INF i$

Certain properties are respected during this conversion:

```
assume(x > 0): hull(x);  
delete x:
```

$0.0 \dots RD\_INF$

This way, you can enclose the values of an expression:

```
hull(sin(abs(x)))
```

$-1.0 \dots 1.0$

Calls to “unknown” functions are regarded as potentially returning the complex plane:

```
hull(f(x))
```

$RD\_NINF \dots RD\_INF + RD\_NINF \dots RD\_INF i$

## Parameters

**`l`, `r`, `object`**

Arbitrary MuPAD objects



## Return Values

floating-point interval on page 7-33, the empty set on page 7-50, or FAIL.

## Overloaded By

object

## See Also

### **MuPAD Domains**

`Dom::FloatIV`

### **MuPAD Functions**

`DIGITS` | `Pref::floatFormat` | `Pref::trailingZeroes` | `float` | `interval`

# hypergeom

Hypergeometric functions

## Syntax

hypergeom([a<sub>1</sub>, a<sub>2</sub>, ...], [b<sub>1</sub>, b<sub>2</sub>, ...], z)

## Description

hypergeom([a<sub>1</sub>, a<sub>2</sub>, ...], [b<sub>1</sub>, b<sub>2</sub>, ...], z) represents the hypergeometric function.

The hypergeometric function is defined for complex arguments  $a_i$ ,  $b_j$ , and  $z$ .

With  $a = [a_1, a_2, \dots, a_p]$  and  $b = [b_1, b_2, \dots, b_q]$ , the hypergeometric function of order  $p$ ,  $q$  is defined as

$${}_pF_q(a; b; z) = \sum_{k=0}^{\infty} \frac{(a_1)_k (a_2)_k \cdots (a_p)_k}{(b_1)_k (b_2)_k \cdots (b_q)_k} \frac{z^k}{k!},$$

where  $(c)_k = c(c+1)\dots(c+k-1)$ ,  $(c)_0 = 1$  is the usual Pochhammer symbol. The quantities  $a$  and  $b$  are called ‘the lists for the upper and lower parameters,’ respectively.

A floating-point value is returned if at least one of the arguments is a floating-point number and all other arguments can be converted to floating-point numbers.

For most exact arguments, the hypergeometric function returns a symbolic function call. If an upper parameter coincides with a lower parameter, these values cancel and are removed from the parameter lists.

The following special values are implemented:

- ${}_pF_p(a; a; z) = {}_0F_0(; ; z) = e^z$

- ${}_pF_q(\alpha; b; z) = 1$  if the list of upper parameters  $\alpha$  contains more zeroes than the list of lower parameters  $b$ .
- ${}_pF_q(\alpha; b; 0) = 1$ .

If, after cancellation of identical parameters, the upper parameters contain a negative integer larger than the largest negative integer in the lower parameters, then  ${}_pF_q(\alpha; b; z)$  is a polynomial in  $z$ . If all upper and lower parameters as well as the argument  $z$  do not contain any symbolic identifiers, a corresponding explicit result is returned. If the parameters or  $z$  contain symbols, expansion to the polynomial representation is available via `simplify`. Cf. "Example 2" on page 1-946 (Symbolic Math Toolbox).

Also empty lists  $a = []$  or  $b = []$  may be passed to `hypergeom`. The corresponding functions are:

$${}_0F_q(; b; z) = \sum_{k=0}^{\infty} \frac{1}{(b_1)_k (b_2)_k \cdots (b_q)_k} \frac{z^k}{k!}$$

$${}_pF_0(\alpha; ; z) = \sum_{k=0}^{\infty} (a_1)_k (a_2)_k \cdots (a_p)_k \frac{z^k}{k!}$$

$${}_0F_0(; ; z) = \sum_{k=0}^{\infty} \frac{z^k}{k!} = e^z$$

## Environment Interactions

When called with floating-point arguments, these functions are sensitive to the environment variable `DIGITS` which determines the numerical working precision.

## Examples

### Example 1

Symbolic calls are returned for exact or symbolic arguments:

```
hypergeom([], [2], x),  
hypergeom([1], [2, 3], PI),  
hypergeom([1, 1/2], [1/3], x + 3*I)
```

$${}_0F_1(\text{Null}; 2; x), {}_1F_2(1; 2, 3; \pi), {}_2F_1\left(\frac{1}{2}, 1; \frac{1}{3}; x + 3i\right)$$

Floating point values are returned for floating-point arguments:

```
hypergeom([], [2], 3.0),  
hypergeom([1], [2.0], PI),  
hypergeom([PI], [2, 3], 4.0),  
hypergeom([1, 2], [3, 4, 5, 6], 1.0*I),  
hypergeom([1 + I], [1/(2 + I)], 1.0*I)
```

$$3.468649619, 7.047601352, 5.152314068, 0.9999801588 + 0.005555508314i, \\ -0.7438410785 - 0.5956994573i$$

### Example 2

${}_0F_0(; ; z)$  is equal to  $e^z$ :

```
hypergeom([], [], z)
```

$$e^z$$

Because identical values in  $a$  and  $b$  cancel, the same is true for  ${}_pF_p(a; a; z)$ :

```
hypergeom([a, b], [a, b], z)
```

$$e^z$$

Any hypergeometric function, evaluated at 0, has the value 1:

```
hypergeom([a, b], [c, d, e], 0)
```

1

If, after cancelling identical parameters, the list of upper parameters contains a zero, the resulting hypergeometric function is constant with the value 1:

```
hypergeom([0, 0, 2, 3], [a, 0, 4], z)
```

1

If, after cancelling identical parameters, the upper parameters contain a negative integer larger than the largest negative integer in the lower parameters, the hypergeometric function is a polynomial. If all parameters as well as the argument z are numerical, a corresponding explicit value is returned:

```
hypergeom([-4, -2, 3], [-3, 1, 4], PI*sqrt(2))
```

$$\frac{6 \pi^2}{5} - 2 \pi \sqrt{2} + 1$$

For symbolic parameters or symbolic z, the polynomial representation may be obtained via `simplify` or `Simplify`:

```
hypergeom([-40, -5], [1, 4], z) =  
simplify(hypergeom([-40, -5], [1, 4], z))
```

$${}_2F_2(-40, -5; 1, 4; z) = \frac{27417 z^5}{280} + \frac{45695 z^4}{84} + \frac{2470 z^3}{3} + 390 z^2 + 50 z + 1$$

```
hypergeom([-3, a], [b], z) =  
Simplify(hypergeom([-3, a], [b], z))
```

$${}_2F_1(-3, a; b; z) = \frac{3 a z^2 (2 a + 2)}{2 b (b + 1)} - \frac{3 a z}{b} - \frac{a z^3 (2 a + 2) (a + 2)}{2 b (b + 1) (b + 2)} + 1$$

If the largest negative integer in the list of lower parameters is larger than the largest negative integer in the list of upper parameters, the corresponding hypergeometric function is not defined (because its definition involves a division by zero):

```
hypergeom([-40, -5, 3], [-3, 1, 4], z)
```

```
Error: Invalid arguments. [hypergeom]
```

### Example 3

The functions `float`, `diff`, and `series` handle expressions involving the hypergeometric functions:

```
float(ln(3 + hypergeom([17], [exp(1), ln(5)], sqrt(PI))))
```

```
3.488880173
```

```
diff(hypergeom([a, b], [c, d], x), x)
```

$$\frac{a b {}_2F_2(a+1, b+1; c+1, d+1; x)}{c d}$$

Note that differentiation of a hypergeometric function w.r.t. one of its upper or lower parameters does not, in general, lead to hypergeometric functions. Certain peculiar cases are an exception:

```
diff(hypergeom([a + 1, b], [a + 2], x), a)
```

$$\frac{b x {}_3F_2(a+2, a+2, b+1; a+3, a+3; x)}{(a+2)^2}$$

```
series(hypergeom([1, 2], [3], x), x)
```

$$1 + \frac{2x}{3} + \frac{x^2}{2} + \frac{2x^3}{5} + \frac{x^4}{3} + \frac{2x^5}{7} + O(x^6)$$

Expansions about *infinity* are possible:

```
series(hypergeom([1/2], [1/3], x), x = infinity, 3)
```

$$\frac{2\sqrt{3}x^{1/6}\sqrt{\pi}e^x}{3\Gamma(\frac{2}{3})} - \frac{\sqrt{3}\sqrt{\pi}e^x}{18x^{5/6}\Gamma(\frac{2}{3})} - \frac{5\sqrt{3}\sqrt{\pi}e^x}{144x^{11/6}\Gamma(\frac{2}{3})} + O\left(\frac{e^x}{x^{17/6}}\right)$$

However, there are very few (if any) complete expansions for hypergeometric functions about any of its upper or lower parameters.

### Example 4

Often, at particular choices of parameters, the hypergeometric function reduces to simpler special functions. For example, in the case of  ${}_1F_1$ , also known as the standard confluent hypergeometric function, the hypergeometric function can be reduced to a Bessel function if its (single) lower parameter is exactly twice its (single) upper parameter. This is verified numerically below:

```
v:= 1.0 + I: z:= float(PI):
hypergeom([v + 1/2], [2*v + 1], 2*I*z) =
(gamma(1 + v)*exp(I*z)*((z/2)^(-v))*besselJ(v, z))

-0.2766083174 - 0.2537119431 i = -0.2766083174 - 0.2537119431 i
```

```
delete v, z:
```

In the following example,  ${}_2F_1$ , which is known as the Gauss hypergeometric function, can be reduced into a simple elementary function involving logarithms when the parameters are [1, 1], [2], as verified numerically below:

```
eq := hypergeom([1, 1], [2], z) = -ln(1 - z)/z:
float(subs(eq, z = 1/3)), float(subs(eq, z = 1/2))

1.216395324 = 1.216395324, 1.386294361 = 1.386294361
```

```
delete eq:
```

## Example 5

The interval  $[1, \infty)$  is a branch cut for the hypergeometric function; the sign of the imaginary part changes when crossing the cut. The branch cut belongs to the lower branch:

```
eq := hypergeom([1, 1], [2], z) = -ln(1 - z)/z:  
float(subs(eq, z = 2 + I*10^(-DIGITS)))
```

$$7.853981634 \cdot 10^{-11} + 1.570796327 i = 7.853981634 \cdot 10^{-11} + 1.570796327 i$$

```
float(subs(eq, z = 2 - I*10^(-DIGITS)))
```

$$7.853981634 \cdot 10^{-11} - 1.570796327 i = 7.853981634 \cdot 10^{-11} - 1.570796327 i$$

```
float(subs(eq, z = 2))
```

$$-1.570796327 i = -1.570796327 i$$

## Parameters

$a_1, a_2, \dots$

The ‘upper parameters’: arithmetical expressions (Symbolic Math Toolbox)

$b_1, b_2, \dots$

The ‘lower parameters’: arithmetical expressions (Symbolic Math Toolbox)

$z$

The ‘argument’: an arithmetical expression (Symbolic Math Toolbox)

## Return Values

Arithmetical expression.



## Overloaded By

$z$

## Algorithms

When no  $b_j$  in the list  $b$  lies in the set  $\{0, -1, -2, \dots\}$ , the series

$${}_pF_q(\alpha; b; z) = \sum_{k=0}^{\infty} \frac{(a_1)_k (a_2)_k \cdots (a_p)_k}{(b_1)_k (b_2)_k \cdots (b_q)_k} \frac{z^k}{k!}$$

converges if one of the following conditions hold:

- 1  $p \leq q, |z| < \infty$ ;
- 2  $p = q + 1, |z| < 1$ ;
- 3  $p = q + 1, |z| = 1, \Re(\psi_q) > 0$ ;
- 4  $p = q + 1, |z| = 1, z \neq 1, -1 < \Re(\psi_q) \leq 0$ ;
- 5  $a$  contains a zero or a negative integer;

where  $\psi_q = \left(\sum_{k=1}^q b_k\right) - \left(\sum_{i=1}^{q+1} a_i\right)$ . The series diverges in the remaining cases. If one of the parameters in  $a$  is equal to zero or a negative integer, then the series terminates, turning into what is called a hypergeometric polynomial.

The generalized hypergeometric function of order  $(p, q)$  is given by the series definition in the region of convergence, while for  $p = q + 1, |z| \geq 1$ , it is defined as an analytic continuation of this series.

The function  ${}_pF_q(\alpha; b; z)$  is symmetric w.r.t. the parameters, i.e., it does not depend on the order of the arrangement  $a_1, a_2, \dots$  in  $a$  or  $b_1, b_2, \dots$  in  $b$ .

As mentioned above, if some upper parameter is equal to  $n = 0, -1, -2, \dots$ , the function turns into a polynomial of degree  $n$ . If we relax the condition stated above for the lower parameters  $b$  and there is some lower parameter equal to  $m = 0, -1, -2, \dots$ , the function

${}_pF_q(\alpha; b; z)$  also reduces to a polynomial in  $z$  provided  $n > m$ . It is undefined if  $m > n$  or if no upper parameter is a nonpositive integer (resulting in division by zero in one of the series coefficients). The case  $m = n$  is handled by the following rule.

If for  $r$  values of the upper parameters, there are  $r$  values of the lower parameters equal to them (i.e.,  $a = [a_1, \dots, a_{p-r}, c_1, \dots, c_r]$ ,  $b = [b_1, \dots, b_{q-r}, c_1, \dots, c_r]$ ), then the order  $(p, q)$  of the function  ${}_pF_q(\alpha; b; z)$  is reduced to  $(p - r, q - r)$ :

$${}_pF_q\left(a_1, \dots, a_{p-r}, c_1, \dots, c_r; b_1, \dots, b_{q-r}, c_1, \dots, c_r; z\right) = {}_{p-r}F_{q-r}\left(a_1, \dots, a_{p-r}; b_1, \dots, b_{q-r}; z\right).$$

The above rule applies even if any of the  $c_i$  happens to be zero or a negative integer (for details, see Luke in the list of references, p. 42).

$U(z) = {}_pF_q(\alpha; b; z)$  satisfies a differential equation in  $z$ :

$$[\delta(\delta + b - 1) - z(\delta + a)] U(z) = 0, \delta = z \frac{\partial}{\partial z}$$

where  $(\delta + a)$  and  $(\delta + b)$  stand for  $\prod_{i=1}^p (\delta + a_i)$  and  $\prod_{i=1}^q (\delta + b_i)$ , respectively. Thus, the order of this differential equation is  $\max(p, q + 1)$  and the hypergeometric function is only one of its solutions. If  $p < q + 1$ , this differential equation has a regular singularity at  $z = 0$  and an irregular singularity at  $z = \infty$ . If  $p = q + 1$ , the points  $z = 0$ ,  $z = 1$ , and  $z = \infty$  are regular singularities, thus explaining the convergence properties of the hypergeometric series.

The analytic continuation for  $p = q + 1$ ,  $|z| \geq 1$ , is defined by selecting the principal

branch of this continuation (also denoted as  ${}_pF_q(\alpha; b; z)$ ) satisfying the condition  $|\arg(1 - z)| < \pi$ , the cut along  $[1, \infty)$  is drawn in the complex  $z$ -plane. In particular, the analytic continuation can be obtained by means of an integral representation (for details, see Prudnikov *et al.* in the references) or by the Meijer G function.

## References

- [1] Luke, Y.L. "The Special Functions and Their Approximations", Vol. 1, Academic Press, New York, 1969.
- [2] Prudnikov, A.P., Yu.A. Brychkov, and O.I. Marichev, "Integrals and Series", Vol. 3: More Special Functions, Gordon and Breach, 1990.
- [3] Abramowitz, M. and I.A. Stegun, "Handbook of Mathematical Functions", Dover Publications, New York, 9th printing, 1970.

# **icontent**

Content of a polynomial with rational coefficients

## **Syntax**

`icontent(p)`

## **Description**

`icontent(p)` calculates the content of a polynomial (Symbolic Math Toolbox) or polynomial expression (Symbolic Math Toolbox) with integer or rational coefficients, i.e., the greatest common divisor of the coefficients, such that  $p / \text{icontent}(p)$  has integral coefficients whose greatest common divisor is 1. In particular, if  $p$  is itself an integer or a rational number, then `icontent` returns `abs(p)` (see “Example 1” on page 1-955 (Symbolic Math Toolbox)).

If  $p$  is a polynomial (Symbolic Math Toolbox) or polynomial expression (Symbolic Math Toolbox) with integer coefficients, then the content is the greatest common divisor of the coefficients. If  $p$  is a polynomial or polynomial expression with rational coefficients, then the content is the greatest common divisor of the numerators of the coefficients divided by the least common multiple of the denominators (see “Example 2” on page 1-955 (Symbolic Math Toolbox)).

If  $p$  is a polynomial expression (Symbolic Math Toolbox), then it is first converted into a polynomial of domain type `DOM_POLY` using `poly`. If this conversion is not possible, then `icontent` returns `FAIL`.

`icontent` returns an error message if not all coefficients of  $p$  are integers or rational numbers.

## Examples

### Example 1

The first argument can be a polynomial or a polynomial expression. The following two calls of `icontent` are equivalent:

```
p := 6*x*y - 9*y^2 + 21:
icontent(poly(p)), icontent(p)
```

3, 3

The result of `icontent` is always nonnegative:

```
icontent(2*x - 4), icontent(-2*x + 4)
```

2, 2

The content of a constant polynomial is its absolute value:

```
icontent(0), icontent(-2), icontent(poly(-2, [x]))
```

0, 2, 2

### Example 2

The content of a polynomial with rational coefficients is a rational number in general:

```
q := 6/7*x*y - 9/4*y + 12:
icontent(poly(q)), icontent(q)
```

$\frac{3}{28}$ ,  $\frac{3}{28}$

The polynomial divided by its content has integral coefficients whose greatest common divisor is 1:

```
q/icontent(q)
```

$8x^2y - 21xy + 112$

`icontent(%)`

1

## Parameters

**p**

A polynomial (Symbolic Math Toolbox) or polynomial expression (Symbolic Math Toolbox) with integer on page 7-31 or rational number on page 7-48 coefficients

## Return Values

Nonnegative integer on page 7-31 or rational number on page 7-48, or FAIL

## See Also

### MuPAD Functions

`coeff` | `content` | `factor` | `gcd` | `ifactor` | `igcd` | `ilcm` | `lcm` | `poly` | `polylib::primpart`

# id

Identity map

## Syntax

```
id(x)
```

```
id(x1, x2, ...)
```

## Description

`id(x)` evaluates and returns `x`; `id(x1, x2, ...)` returns the evaluated arguments as an expression sequence on page 1-88; `id()` returns the void object `null()`.

## Examples

### Example 1

`id` returns the evaluated arguments:

```
a := 2: id(a + 2)
```

```
4
```

```
id(a, b, 4 + 2)
```

```
2, b, 6
```

`id()` returns `null()`:

```
domtype(id())
```

```
DOM_NULL
```

delete a:

## Example 2

id is useful when working with functional expressions:

```
f := 3*id + sin + 5*id^2 + exp@(-id^2):  
f(x)
```

$$3x + e^{-x^2} + \sin(x) + 5x^2$$

```
f'(x)
```

$$10x + \cos(x) - 2xe^{-x^2} + 3$$

delete f:

## Parameters

x, x1, x2, ...

Arbitrary MuPAD objects

## Return Values

Sequence of the input parameters.



# ifthenlifelseend\_if\_if

If-statement (conditional branch in a program)

---

**Note** For the if statement in MATLAB®, see `if`.

---

## Syntax

```
if condition1
then casetrue1
    elif condition2 then casetrue2
    elif condition3 then casetrue3
    ...
    else casefalse
end_if

_if(condition1, casetrue1, casefalse)
```

## Description

`if-then-else-end_if` allows conditional branching in a program.

If the Boolean expression `condition1` can be evaluated to `TRUE`, the branch `casetrue1` is executed and its result is returned. Otherwise, if `condition2` evaluates to `TRUE`, the branch `casetrue2` is executed and its result is returned etc. If all of the conditions evaluate to `FALSE`, the branch `casefalse` is executed and its result is returned.

All conditions that are evaluated during the execution of the `if` statement must be reducible to either `TRUE` or `FALSE`. Conditions may be given by equations on page 1-19 or inequalities on page 1-30, combined with the logical operators `and`, `or`, `not`. There is no need to enforce Boolean evaluation of equations and inequalities via `bool`. Implicitly, the `if` statement enforces “lazy” Boolean evaluation via the functions `_lazy_and` or `_lazy_or`, respectively. A condition leads to a runtime error if it cannot be evaluated to `TRUE` or `FALSE` by these functions. Cf. “Example 3” on page 1-962 (Symbolic Math Toolbox).

The keyword `end_if` may be replaced by the keyword `end`.

The statement `if condition then casetrue else casefalse end_if` is equivalent to the function call `_if(condition, casetrue, casefalse)`.

## Examples

### Example 1

The `if` statement operates as demonstrated below:

```
if TRUE then YES else NO end_if,  
if FALSE then YES else NO end_if
```

YES, NO

The `else` branch is optional:

```
if FALSE then YES end_if  
  
if FALSE  
  then if TRUE  
        then NO_YES  
        else NO_NO  
        end_if  
  else if FALSE  
        then YES_NO  
        else YES_YES  
        end_if  
end_if
```

YES, YES

Typically, the Boolean conditions are given by equations, inequalities or Boolean constants produced by system functions such as `isprime`:

```
for i from 100 to 600 do  
  if 105 < i and i^2 <= 17000 and isprime(i) then  
    print(expr2text(i)." is a prime")  
  end_if;  
  if i < 128 then  
    if isprime(2^i - 1) then
```

```
        print("2^".expr2text(i)." - 1 is a prime")
    end_if
end_if
end_for:
```

"107 is a prime"

"2^107 - 1 is a prime"

"109 is a prime"

"113 is a prime"

"127 is a prime"

"2^127 - 1 is a prime"

## Example 2

Instead of using nested `if-then-else` statements, the `elif` statement can make the source code more readable. However, internally the parser converts such statements into equivalent `if-then-else` statements:

```
hold(if FALSE then NO elif TRUE then YES_YES else YES_NO end_if)
```

```
if FALSE then
  NO
else
  if TRUE then
    YES_YES
  else
    YES_NO
  end_if
end_if
```

### Example 3

If the condition cannot be evaluated to either TRUE or FALSE, then a runtime error is raised. In the following call, `is(x > 0)` produces UNKNOWN if no corresponding properties (Symbolic Math Toolbox) was attached to `x` via `assume`:

```
if is(x > 0) then
    1
else
    2
end_if
```

Error: Unable to evaluate to Boolean. [if]

Note that Boolean conditions using `<`, `<=`, `>`, `>=` may fail if they involve symbolic expressions:

```
if 1 < sqrt(2) then print("1 < sqrt(2)"); end_if
```

"1 < sqrt(2)"

```
if 10812186006/7645370045 < sqrt(2)
    then print("10812186006/7645370045 < sqrt(2)");
end_if
```

"10812186006/7645370045 < sqrt(2)"

```
if is(10812186006/7645370045 < sqrt(2)) = TRUE
    then print("10812186006/7645370045 < sqrt(2)");
end_if
```

"10812186006/7645370045 < sqrt(2)"

### Example 4

This example demonstrates the correspondence between the functional and the imperative use of the `if` statement:

```
condition := 1 > 0: _if(condition, casetrue, casefalse)
```

`casetrue`

```
condition := 1 > 2: _if(condition, casetrue, casefalse)
```

`casefalse`

`delete condition:`

## Parameters

`condition1, condition2, ...`

Boolean expressions

`casetrue1, casetrue2, casefalse, ...`

Arbitrary sequences of statements

## Return Values

Result of the last command executed inside the `if` statement. The empty sequence, `null()` is returned if no command was executed.

## See Also

### MuPAD Functions

`case` | `piecewise`

## Topics

“Conditional Control” (Symbolic Math Toolbox)

# ifactor

Factor an integer into primes

## Syntax

```
ifactor(n, <UsePrimeTab>)
```

```
ifactor(<PrimeLimit>)
```

## Description

`ifactor(n)` computes the prime factorization  $n = s p_1^{e_1} \dots p_r^{e_r}$  of the integer  $n$ , where  $s$  is the sign of  $n$ ,  $p_1, \dots, p_r$  are the distinct positive prime divisors of  $n$ , and  $e_1, \dots, e_r$  are positive integers.

The result of `ifactor` is an object of domain type `Factored`. Let `f := ifactor(n)` be such an object. Internally, it is represented by the list on page 7-41 `[s, p1, e1, ..., pr, er]` of odd length  $2r + 1$ , where  $r$  is the number of distinct prime divisors of  $n$ . The  $p_i$  are not necessarily sorted by magnitude.

You may extract the sign  $s$  and the terms  $p_i^{e_i}$  by means of the index operator `[ ]`, i.e., `f[1] = p1^e1`, `f[2] = p2^e2`, ... for positive  $n$  and `f[1] = s`, `f[2] = p1^e1`, `f[3] = p2^e2`, ... for negative  $n$ .

The call `Factored::factors(f)` yields a list of the factors `[p1, p2, ...]`, while `Factored::exponents(f)` returns a list of the exponents `[e1, e2, ...]` with  $1 \leq i \leq r$ .

The factorization of 0, 1, and - 1 yields the single factor 0, 1, and - 1, respectively. In these cases, the internal representation is the list `[0]`, `[1]`, and `[-1]`, respectively.

The call `coerce(f, DOM_LIST)` returns the internal representation of a factored object, i.e., the list `[s, p1, e1, p2, e2, ...]`.

Note that the result of `ifactor` is printed as an expression, and it is implicitly converted into an expression whenever it is processed further by other MuPAD functions. For

example, the result of `ifactor(12)` is printed as  $2^2 \cdot 3$ , which is an expression on page 7-20 of type `"_mult"`.

See “Example 1” on page 1-965 (Symbolic Math Toolbox) for illustrations, and the help page of `Factored` for more details.

If you do not need the prime factorization of  $n$ , but only want to know whether it is composite or prime, use `isprime` instead, which is much faster.

`ifactor` returns an error when the argument is a number but not an integer on page 7-31. A symbolic `ifactor` call is returned if the argument is not a number (Symbolic Math Toolbox).

## Examples

### Example 1

To get the prime factorization of 120, enter:

```
f := ifactor(120)
```

$$2^3 \cdot 3 \cdot 5$$

You can access the terms of this factorization using the index operator:

```
f[1], f[2], f[3]
```

$$2^3, 3, 5$$

The internal representation of `f`, namely the list as described above, is returned by the following command:

```
coerce(f, DOM_LIST)
```

$$[1, 2, 3, 3, 1, 5, 1]$$

The result of `ifactor` is an object of domain type `Factored`:

```
domtype(f)
```

```
Factored
```

This domain implements some features for handling such objects. Some of them are described below.

You may extract the factors and exponents of the factorization also in the following way:

```
Factored::factors(f), Factored::exponents(f)
```

```
[2, 3, 5], [3, 1, 1]
```

You can ask for the type of the factorization:

```
Factored::getType(f)
```

```
"irreducible"
```

This output means that all factors  $p_i$  are prime. Other possible types are "square free" (see `polylib::sqrfree`) or "unknown".

Multiplying factored objects preserves the factored form:

```
f2 := ifactor(12)
```

```
22 3
```

```
f*f2
```

```
25 32 5
```

It is important to note that you can apply nearly any function operating on arithmetical expressions to an object of domain type `Factored`. The result is usually not of this domain type:

```
expand(f);  
domtype(%)
```



---

120

DOM\_INT

For a detailed description of these objects, please refer to the help page of the domain Factored.

## Example 2

The factorizations of 0, 1, and -1 each have exactly one factor:

```
ifactor(0), ifactor(1), ifactor(-1)
```

0, 1, -1

```
map(%, coerce, DOM_LIST)
```

[0], [1], [-1]

The internal representation of the factorization of a prime number  $p$  is the list  $[1, p, 1]$ :

```
coerce(ifactor(5), DOM_LIST)
```

[1, 5, 1]

## Example 3

The bound on the prime number table is:

```
ifactor(PrimeLimit)
```

1000000

We assign a large prime number to  $p$ :

```
p := nextprime(10^10);  
q := nextprime(10^12)
```

```
10000000019
```

```
1000000000039
```

Completely factoring the 36 digit number  $6 \cdot p^3$  takes some time; the second output line shows the time in seconds:

```
t := time():  
f := ifactor(p^3*q^4);  
(time() - t)/1000.0  
10000000019^3*1000000000039^4
```

```
2.5
```

```
Factored::getType(f)
```

```
"irreducible"
```

```
delete f
```

Extracting only the prime factors in the prime table is much faster, but it does not yield the complete factorization; the factor  $p^3$  remains undecomposed:

```
t := time():  
f := ifactor(p^3*q^4, UsePrimeTab);  
(time() - t)/1000.0  
1000000005856000011728326008600735477170193366706178119695352530650045867891819
```

```
0.015625
```

```
Factored::getType(f)
```

```
"unknown"
```

```
delete f
```

## Parameters

**n**

An arithmetical expression (Symbolic Math Toolbox) representing an integer

## Options

### **UsePrimeTab**

Internally, MuPAD has stored a pre-computed table of all prime numbers up to a certain bound. `ifactor(n, UsePrimeTab)` looks only for prime factors that are stored in this internal prime number table, extracts them from `n`, and returns the undecomposed product of all other prime factors as a single factor. This is usually much faster than without the option `UsePrimeTab`, but it does not necessarily yield the complete prime factorization of `n`. See “Example 2” on page 1-967 (Symbolic Math Toolbox).

### **PrimeLimit**

`ifactor(PrimeLimit)` returns an integer, namely a bound on the size of prime numbers in the internal prime number table. The table contains all primes below this bound. The default values are: 1000000 on UNIX systems and 300000 on Mac OS platforms and Windows platforms.

The size of this table can be changed via the MuPAD command line flag `-L`.

## Return Values

Object of domain type `Factored`, or a symbolic `ifactor` call.

## Algorithms

`ifactor` uses the elliptic curve method.

`ifactor` is an interface to the kernel function `stdlib::ifactor`. It calls `stdlib::ifactor` with the given arguments and convert its result, which is the list `[s,`

$p_1, e_1, \dots, p_r, e_r]$  as described above, into an object of the domain type Factored.

You may directly call the kernel function `stdlib::ifactor` inside your routines, in order to avoid this conversion and to decrease the running time.

## See Also

### MuPAD Functions

Factored | content | factor | icontent | igcd | ilcm | isprime | ithprime | nextprime | numlib::divisors | numlib::primedivisors | prevprime

# ifourier

Inverse Fourier transform

## Syntax

`ifourier(F, w, t)`

## Description

`ifourier(F, w, t)` computes the inverse Fourier transform of the expression  $F = F(w)$  with respect to the variable  $w$  at the point  $t$ .

The inverse Fourier transform of the expression  $F = F(w)$  with respect to the variable  $w$  at the point  $t$  is defined as follows:

$$f(t) = \frac{|s|}{2\pi c} \int_{-\infty}^{\infty} F(w) e^{-iswt} dw$$

$c$  and  $s$  are parameters of the Fourier transform. By default,  $c = 1$  and  $s = -1$ .

To change the parameters  $c$  and  $s$  of the Fourier transform, use `Pref::fourierParameters`. See “Example 3” on page 1-973 (Symbolic Math

Toolbox). Common choices for the parameter  $c$  are  $1$ ,  $\frac{1}{2\pi}$ , or  $\frac{1}{\sqrt{2\pi}}$ . Common choices for the parameter  $s$  are  $-1$ ,  $1$ ,  $-2\pi$ , or  $2\pi$ .

If  $F$  is a matrix, `ifourier` applies the inverse Fourier transform to all components of the matrix.

MuPAD computes `ifourier(F, w, t)` as

$$\frac{|s|}{2\pi c^2} \text{fourier}(F(w), w, -t)$$

If `ifourier` cannot find an explicit representation of the inverse Fourier transform, it returns results in terms of the direct Fourier transform. See “Example 4” on page 1-974 (Symbolic Math Toolbox).

To compute the direct Fourier transform, use `fourier`.

To compute the inverse discrete Fourier transform, use `numeric::invfft`.

## Environment Interactions

Results returned by `ifourier` depend on the current `Pref::fourierParameters` settings.

## Examples

### Example 1

Compute the inverse Fourier transform of this expression with respect to the variable `w`:

```
ifourier(sqrt(PI)*exp(-w^2/4), w, t)
```

$$e^{-t^2}$$

### Example 2

Compute the inverse Fourier transform of this expression with respect to the variable `w` for positive values of the parameter `t0`:

```
assume(t_0 > 0):  
f := ifourier(-(PI^(1/2))*w*exp(-w^2*t_0^2/4)*I)*t_0^3/2, w, t)
```

$$t e^{-\frac{t^2}{t_0^2}}$$

Evaluate the inverse Fourier transform of the expression at the points  $t = -2t_0$  and  $t = 1$ . You can evaluate the resulting expression `f` using `|` (or its functional form `evalAt`):

```
f | t = -2*t_0
```

$$-2 t_0 e^{-4}$$

Also, you can evaluate the inverse Fourier transform at a particular point directly:

```
ifourier(-(PI^(1/2))*w*exp(-w^2*t_0^2/4)*I)*t_0^3/2, w, 1)
```

$$e^{-\frac{1}{2}}$$

### Example 3

The default parameters of the Fourier and inverse Fourier transforms are  $c = 1$  and  $s = -1$ :

```
ifourier(-(sqrt(PI)*w*exp(-w^2/4)*I)/2, w, t)
```

$$t e^{-t^2}$$

To change these parameters, use `Pref::fourierParameters` before calling `ifourier`:

```
Pref::fourierParameters(1, 1):
```

Evaluate the transform of the same expression with the new parameters:

```
ifourier(-(sqrt(PI)*w*exp(-w^2/4)*I)/2, w, t)
```

$$-t e^{-t^2}$$

For further computations, restore the default values of the Fourier transform parameters:

```
Pref::fourierParameters(NIL):
```

## Example 4

If `ifourier` cannot find an explicit representation of the transform, it returns results in terms of the direct Fourier transform:

```
ifourier(exp(-w^4), w, t)
```

$$\frac{\text{fourier}\left(e^{-w^4}, w, -t\right)}{2\pi}$$

## Example 5

Compute the following inverse Fourier transforms that involve the Dirac and the Heaviside functions:

```
ifourier(dirac(w), w, t)
```

$$\frac{1}{2\pi}$$

```
ifourier(heaviside(w + 5), w, t)
```

$$\frac{e^{-5ti}(\pi\delta(t) + \frac{i}{t})}{2\pi}$$

## Parameters

### F

Arithmetical expression or matrix on page 1-2045 (Symbolic Math Toolbox) of such expressions

### w

Identifier on page 7-29 or indexed identifier on page 1-1017 representing the transformation variable



**t**

Arithmetical expression representing the evaluation point

## Return Values

Arithmetical expression or an expression containing an unevaluated function call of type `fourier`. If the first argument is a matrix, then the result is returned as a matrix.

## Overloaded By

F

## References

F. Oberhettinger, “Tables of Fourier Transforms and Fourier Transforms of Distributions”, Springer, 1990.

## See Also

### MuPAD Functions

`Pref::fourierParameters` | `fourier` | `fourier::addpattern` | `ifourier::addpattern` | `numeric::fft` | `numeric::invfft`

## Topics

“Integral Transforms” (Symbolic Math Toolbox)

## ifourier::addpattern

Add patterns for the inverse Fourier transform

### Syntax

`ifourier::addpattern(pat, w, t, res, <vars, <conds>>)`

### Description

`ifourier::addpattern(pat, w, t, res)` teaches `ifourier` to return `res` for the expression `pat`.

The `ifourier` function uses a set of patterns for computing inverse Fourier transforms. You can extend the set by adding your own patterns. To add a new pattern to the pattern matcher, use `ifourier::addpattern`. MuPAD does not save custom patterns permanently. The new patterns are available in the *current* MuPAD session only.

After the call `ifourier::addpattern(pat, w, t, res)`, the `ifourier` function returns `res` for the expression `pat`. Note that the inverse Fourier transform is defined as

$\frac{1}{2\pi} \int_{-\infty}^{\infty} F e^{-i s w t} d w$ , where `c` and `s` are the parameters specified by `FourierParameters`. If you add a new pattern, and then change the Fourier transform parameters, the result returned by `ifourier(pat, w, t)` will also change. See “Example 2” on page 1-978 (Symbolic Math Toolbox).

Variable names that you use when calling `ifourier::addpattern` can differ from the names that you use when calling `ifourier`. See “Example 3” on page 1-978 (Symbolic Math Toolbox).

You can include a list of free parameters and a list of conditions on these parameters. These conditions and the result are protected from premature evaluation. That means you can use `not iszero(a^2-b)` instead of `hold( _not @ iszero )(a^2-b)`.

The following conditions treat assumptions on identifiers differently:

- $a^2 - b <> 0$  takes into account assumptions on identifiers.
- `not iszero(a^2 - b)` disregards assumptions on identifiers.

See “Example 4” on page 1-979 (Symbolic Math Toolbox) and “Example 5” on page 1-979 (Symbolic Math Toolbox).

## Environment Interactions

The Fourier pair (`pat`, `res`) holds only for the current values of the Fourier transform parameters specified by `Pref::fourierParameters`.

Calling `ifourier::addpattern` can change the expressions returned by future calls to `fourier` and `ifourier` in the current MuPAD session.

## Examples

### Example 1

Compute the inverse Fourier transform of the function `bar`. By default, MuPAD does not have a pattern for this function:

```
ifourier(bar(w), w, t)
```

$$\frac{\text{fourier}(\text{bar}(w), w, -t)}{2\pi}$$

Add a pattern for the inverse Fourier transform of `bar` using `ifourier::addpattern`:

```
ifourier::addpattern(bar(w), w, t, foo(t)):
```

Now `ifourier` returns the Fourier transform of `bar`:

```
ifourier(bar(w), w, t)
```

$$\text{foo}(t)$$

After you add a new transform pattern, MuPAD can use that pattern indirectly:

```
ifourier(exp(-a*I*s)*bar(2*s + 10), s, t)
```

$$\frac{\text{foo}\left(\frac{t-a}{2}\right) e^{5 a i-5 t i}}{2}$$

## Example 2

Add this pattern for the inverse Fourier transform of the function `bar`:

```
ifourier::addpattern(bar(w), w, t, foo(t)):
ifourier(bar(w), w, t)
```

`foo(t)`

Now change the Fourier transform parameters using `Pref::fourierParameters`:

```
Pref::fourierParameters(a, b):
```

Evaluate the transform with the new parameters:

```
ifourier(bar(w), w, t)
```

$$\frac{\text{foo}(-b t) |b|}{a}$$

For further computations, restore the default values of the Fourier transform parameters:

```
Pref::fourierParameters(NIL):
```

## Example 3

Define the inverse Fourier transform of `bar(y)` using variables `y` and `x` as parameters:

```
ifourier::addpattern(bar(y), y, x, foo(x)):
```

The `ifourier` function recognizes the added pattern even if you use other variables as parameters:

```
ifourier(bar(w), w, t)
```

$$\text{foo}(t)$$

## Example 4

Use assumptions when adding the following pattern for the inverse Fourier transform:

```
ifourier::addpattern(bar(x, w), w, t, foo(x, t), [x], [abs(x) < 1]):
ifourier(bar(x, w), w, t) assuming abs(x) < 1/2
```

$$\text{foo}(x, t)$$

If  $|x| \geq 1$ , you cannot apply these patterns:

```
ifourier(bar(x, w), w, t) assuming x < -1
```

$$\frac{\text{fourier}(\text{bar}(x, w), w, -t)}{2 \pi}$$

If MuPAD cannot determine whether the conditions are satisfied, it returns a `piecewise` object:

```
ifourier(bar(x, w), w, t)
```

$$\{ \text{foo}(x, t) \text{ if } |x| < 1$$

## Example 5

Add this pattern for the inverse Fourier transform of `g`:

```
ifourier::addpattern(g(a, w), w, t, f(a, t)/a):
ifourier(g(a, W), W, T)
```

$$\frac{f(a, T)}{a}$$

This pattern holds only when the first argument of `g` is the symbolic parameter `a`. If you use any other value of this parameter, `ifourier` ignores the pattern:

```
ifourier(g(b, W), W, T);
ifourier(g(2, W), W, T)
```

$$\frac{\text{fourier}(g(b, W), W, -T)}{2 \pi}$$

$$\frac{\text{fourier}(g(2, W), W, -T)}{2 \pi}$$

To use the pattern for arbitrary values of the parameter, declare the parameter *a* as an additional pattern variable:

```
ifourier::addpattern(g(a, w), w, t, f(a, t)/a, [a]):
```

Now `ifourier` applies the specified pattern for an arbitrary value of *a*:

```
ifourier(g(2, W), W, T)
```

$$\frac{f(2, T)}{2}$$

```
ifourier(g(a^2 + 1, W), W, T)
```

$$\frac{f(a^2 + 1, T)}{a^2 + 1}$$

Note that the resulting expression  $f(a, t)/a$  defining the Fourier transform of  $g(a, w)$  implicitly assumes that the value of *a* is not zero. A strict definition of the pattern is:

```
ifourier::addpattern(g(a, w), w, t, f(a, t)/a, [a], [a <> 0]):
```

For this particular pattern, you can omit specifying the assumption  $a \neq 0$  explicitly. If  $a = 0$ , MuPAD throws an internal “Division by zero.” error and ignores the pattern:

```
ifourier(f(0, W), W, T)
```

$$\frac{\text{fourier}(f(0, W), W, -T)}{2 \pi}$$

## Parameters

### **pat**

Arithmetical expression (Symbolic Math Toolbox) in the variable `w` representing the pattern to match

### **w**

Identifier on page 7-29 or indexed identifier on page 1-1017 used as a variable in the pattern

### **t**

Identifier on page 7-29 or indexed identifier on page 1-1017 used as a variable in the result

### **res**

Arithmetical expression in the variable `t` representing a pattern for the result

### **vars**

List of identifiers on page 7-29 or indexed identifiers on page 1-1017 used as “pattern variables” (placeholders in `pat` and `res`). You can use pattern variables as placeholders for almost arbitrary MuPAD expressions not containing `w` or `t`. You can restrict them by conditions given in the optional parameter `conds`.

### **conds**

List of conditions on the pattern variables

## Return Values

Object of type `DOM_NULL`

## See Also

### **MuPAD Functions**

`fourier` | `fourier::addpattern` | `ifourier`

## **Topics**

“Use Custom Patterns for Transforms” (Symbolic Math Toolbox)



# igamma

Incomplete gamma function

## Syntax

igamma(a, x)

## Description

igamma(a, x) returns the upper incomplete gamma function  $\int_x^{\infty} e^{-t} t^{a-1} dt$ .

---

**Note** The MATLAB `gammainc` function returns the regularized lower incomplete gamma function: `igamma(a, x) = gamma(a)(1 - gammainc(x, a))`. See the `gamma` and `gammainc` function reference pages in the MATLAB documentation.

---

To find the lower incomplete gamma function for arguments `a` and `x`, subtract `igamma(a, x)` from `gamma(a)`.

A floating-point value is returned if at least one of the arguments is a floating-point value and both values are numerical. Otherwise, symbolic calls of `igamma` and/or other special functions may be returned.

The following simplifications and rewriting rules are implemented:  $\Gamma(a, 0) = \Gamma(a)$ ,

$$\Gamma(0, x) = \text{Ei}(x), \Gamma\left(\frac{1}{2}, x\right) = \sqrt{\pi} \operatorname{erfc}(\sqrt{x}), \Gamma(1, x) = e^{-x}.$$

For real numerical values of `a` of Type: `:Real` satisfying  $|a| \leq \text{Pref}::\text{autoExpansionLimit}()$ , the functional relation

$$\Gamma(a, x) = x^{(a-1)} e^{-x} + (a-1) \Gamma(a-1, x)$$

is used recursively to shift the first argument to the interval  $0 \leq a \leq 1$ . Thus rewriting in terms of `Ei`, `erfc`, and `exp` occurs if `a` is an integer multiple of  $\frac{1}{2}$ . Cf. “Example 1” on

page 1-984 (Symbolic Math Toolbox). Use `expand` if these transformations are also desired for  $|a| > \text{Pref}::\text{autoExpansionLimit}()$ .

The special value `igamma(a, infinity) = 0` for  $a \neq \infty$  is implemented.

## Environment Interactions

When called with a floating-point argument, the function is sensitive to the environment variable `DIGITS` which determines the numerical working precision.

## Examples

### Example 1

We demonstrate some calls with exact and symbolic input data:

```
igamma(2, 3), igamma(1/7, x), igamma(sqrt(2), 3)
```

$$4 e^{-3}, \Gamma\left(\frac{1}{7}, x\right), \Gamma(\sqrt{2}, 3)$$

```
igamma(a, 4), igamma(1 + I, x^2 + 1), igamma(a, infinity)
```

$$\Gamma(a, 4), \Gamma(1 + i, x^2 + 1), 0$$

If the first argument  $a$  is a real numerical value with  $|a| \leq \text{Pref}::\text{autoExpansionLimit}()$ , the functional relations are used recursively until `igamma` is called with a first argument from the the interval  $0 \leq a \leq 1$ :

```
igamma(-1/10, 1), igamma(7/4, 1)
```

$$10 e^{-1} - 10 \Gamma\left(\frac{9}{10}, 1\right), e^{-1} + \frac{3 \Gamma\left(\frac{3}{4}, 1\right)}{4}$$

If the first argument is an integer multiple of  $\frac{1}{2}$ , then complete rewriting in terms of Ei, erfc, and exp occurs:

`igamma(-3, x), igamma(-5/2, x), igamma(8, x), igamma(13/2, 4)`

$$e^{-x} \left( \frac{1}{6x} - \frac{1}{6x^2} + \frac{1}{3x^3} \right) - \frac{\text{Ei}(1, x)}{6}, e^{-x} \left( \frac{8}{15\sqrt{x}} - \frac{4}{15x^{3/2}} + \frac{2}{5x^{5/2}} \right) - \frac{8\sqrt{\pi} \operatorname{erfc}(\sqrt{x})}{15},$$

$$e^{-x} (x^7 + 7x^6 + 42x^5 + 210x^4 + 840x^3 + 2520x^2 + 5040x + 5040),$$

$$\frac{210979 e^{-4}}{16} + \frac{10395 \sqrt{\pi} \operatorname{erfc}(2)}{64}$$

Floating point values are computed for floating-point arguments:

`igamma(0.1, 4.0), igamma(7, 0.5), igamma(100, 100.0)`

0.004420083058, 719.9992783, 4.542198121 10<sup>155</sup>

## Example 2

The functional relation between `igamma` with different first arguments is used to “normalize” the returned expressions:

`igamma(-8, x), igamma(7/3, x)`

$$\frac{\text{Ei}(1, x)}{40320} - e^{-x} \left( \frac{1}{40320x} - \frac{1}{40320x^2} + \frac{1}{20160x^3} - \frac{1}{6720x^4} + \frac{1}{1680x^5} - \frac{1}{336x^6} + \frac{1}{56x^7} \right.$$

$$\left. - \frac{1}{8x^8} \right), e^{-x} \left( \frac{4x^{1/3}}{3} + x^{4/3} \right) + \frac{4\Gamma(\frac{1}{3}, x)}{9}$$

## Parameters

**a, x**

arithmetical expressions (Symbolic Math Toolbox)

## Return Values

Arithmetical expression.

## Overloaded By

**a, x**

## See Also

### **MuPAD Functions**

[Ei](#) | [erfc](#) | [exp](#) | [fact](#) | [gamma](#) | [int](#)

# igcd

Greatest common divisor of integers and complex numbers with integer real and imaginary parts

## Syntax

```
igcd(i1, i2, ...)
```

## Description

`igcd(i1, i2, ...)` computes the greatest common divisor of the integers  $i_1, i_2, \dots$

`igcd` computes the greatest common nonnegative divisor of a sequence of integers on page 7-31. If an argument of `igcd` is a single integer number, the function returns the absolute value of that argument.

`igcd` also computes the greatest common divisor of a sequence of complex numbers of the domain `DOM_COMPLEX`. Both the real and the imaginary parts of all complex numbers in a sequence must be integers on page 7-31. The greatest common divisor is a complex number with a positive real part and a nonnegative imaginary part.

If all arguments are  $0$ , `igcd` returns  $0$ .

If there are no arguments, `igcd` also returns  $0$ .

If one argument is a number (Symbolic Math Toolbox), but is neither an integer on page 7-31 nor a complex number with integer real and imaginary parts, then `igcd` returns an error message.

If at least one of the arguments is  $1$  or  $-1$ , `igcd` returns  $1$ . Otherwise, if one argument is not a number (Symbolic Math Toolbox), the `igcd` function returns a symbolic `igcd` call.

## Examples

### Example 1

Compute the greatest common divisor of the following integers:

```
igcd(-10, 6), igcd(6, 10, 15)
```

```
2, 1
```

```
a := 4420, 128, 8984, 488:  
igcd(a), igcd(a, 64)
```

```
4, 4
```

### Example 2

Compute the greatest common divisor of the following complex numbers:

```
igcd(-10*I, 6), igcd(10 - 5*I, 20 - 10*I, 30 - 15*I)
```

```
2, 5 + 10 i
```

### Example 3

The following example shows some special cases:

```
igcd(), igcd(0), igcd(1), igcd(-1), igcd(2)
```

```
0, 0, 1, 1, 2
```

### Example 4

If one argument is not a number, then the result is a symbolic `igcd` call. However, if at least one of the arguments is 1 or -1, the greatest common divisor is always 1:

```
delete x:  
igcd(a, x), igcd(1, x), igcd(-1, x)
```

```
igcd(4420, 128, 8984, 488, x), 1, 1
```

```
type(igcd(a, x))
```

```
"igcd"
```

## Parameters

**i1, i2, ...**

arithmetical expressions (Symbolic Math Toolbox) representing integers or arithmetical expressions (Symbolic Math Toolbox) representing complex numbers of the domain `DOM_COMPLEX`, of which both the real part and the imaginary part are integers.

## Return Values

Nonnegative integer on page 7-31, a complex number both the real and imaginary parts of which are integers, or a symbolic `igcd` call.

## See Also

### MuPAD Functions

`content` | `div` | `divide` | `factor` | `gcd` | `gcdex` | `icontent` | `ifactor` | `igcdex` | `ilcm` | `lcm` | `mod`

## igcdex

Extended Euclidean algorithm for two integers

### Syntax

`igcdex(x, y)`

### Description

`igcdex(x, y)` computes the nonnegative greatest common divisor  $g$  of the integers  $x$  and  $y$  and integers  $s$  and  $t$  such that  $g = sx + ty$ .

`igcdex(x, y)` returns an expression sequence  $g, s, t$  with three elements, where  $g$  is the nonnegative greatest common divisor of  $x$  and  $y$  and  $s, t$  are integers such that  $g = sx + ty$ . These data are computed by the extended Euclidean algorithm for integers.

`igcdex(0, 0)` returns the sequence  $0, 1, 0$ . If  $x$  is non-zero, then `igcdex(0, x)` and `igcdex(x, 0)` return  $\text{abs}(x), 0, \text{sign}(x)$  and  $\text{abs}(x), \text{sign}(x), 0$ , respectively.

If both  $x$  and  $y$  are non-zero integers, then the numbers  $s, t$  satisfy the inequalities

$$|s| < \left| \frac{y}{g} \right| \text{ and } |t| < \left| \frac{x}{g} \right|.$$

If one of the arguments is a number but not an integer on page 7-31, then `igcdex` returns an error message. If some argument is not a number (Symbolic Math Toolbox), then `igcdex` returns a symbolic `igcdex` call.

The function `numlib::igcdmult` is an extension of `igcdex` for more than two arguments.

## Examples

### Example 1

We compute the greatest common divisor of some integers:



```
igcdex(-10, 6)
```

```
2, 1, 2
```

```
igcdex(3839882200, 654365735423132432848652680)
```

```
109710920, -681651885490791809, 4
```

The returned numbers satisfy the described equation:

```
[g, s, t] := [igcdex(9, 15)];  
g = s*9 + t*15
```

```
[3, 2, -1]
```

```
3 = 3
```

If one argument is not a number, the result is the a symbolic `igcdex` call:

```
delete x;  
igcdex(4, x)
```

```
igcdex(4, x)
```

## Parameters

**x, y**

arithmetical expressions (Symbolic Math Toolbox) representing integers

## Return Values

Sequence of three integers on page 7-31, or a symbolic `igcdex` call.

## See Also

### **MuPAD Functions**

`div` | `divide` | `factor` | `gcd` | `gcdex` | `ifactor` | `igcd` | `ilcm` | `lcm` | `mod` |  
`numlib::igcdmult`

# ilaplace

Inverse Laplace transform

## Syntax

`ilaplace(F, s, t)`

## Description

`ilaplace(F, s, t)` computes the inverse Laplace transform of the expression  $F = F(s)$  with respect to the variable  $s$  at the point  $t$ .

The inverse Laplace transform can be defined by a contour integral in the complex plane:

$$f(t) = \frac{1}{2\pi i} \int_{c-i\infty}^{c+i\infty} F(s) e^{st} ds$$

where  $c$  is a suitable complex number.

If `ilaplace` cannot find an explicit representation of the transform, it returns an unevaluated function call. See “Example 3” on page 1-995 (Symbolic Math Toolbox).

If  $F$  is a matrix, `ilaplace` applies the inverse Laplace transform to all components of the matrix.

To compute the direct Laplace transform, use `laplace`.

## Examples

### Example 1

Compute the inverse Laplace transforms of these expressions with respect to the variable  $s$ :

```
ilaplace(1/(a + s), s, t)
```

$$e^{-a t}$$

```
ilaplace(1/(s^3 + s^5), s, t)
```

$$\cos(t) + \frac{t^2}{2} - 1$$

```
ilaplace(exp(-2*s)/(s^2 + 1) + s/(s^3 + 1), s, t)
```

$$\text{heaviside}(t - 2) \sin(t - 2) - \frac{e^{-t}}{3} + \frac{e^{\frac{t}{2}} \left( \cos\left(\frac{\sqrt{3} t}{2}\right) + \sqrt{3} \sin\left(\frac{\sqrt{3} t}{2}\right) \right)}{3}$$

### Example 2

Compute the inverse Laplace transform of this expression with respect to the variable  $s$ :

```
f := ilaplace(1/(1 + s)^2, s, t)
```

$$t e^{-t}$$

Evaluate the inverse Laplace transform of the expression at the points  $t = -2 t_0$  and  $t = 1$ . You can evaluate the resulting expression  $f$  using `|` (or its functional form `evalAt`):

```
f | t = -2*t_0
```

$$-2 t_0 e^{2 t_0}$$

Also, you can evaluate the inverse Laplace transform at a particular point directly:

```
ilaplace(1/(1 + s)^2, s, 1)
```

$$e^{-1}$$

### Example 3

If `laplace` cannot find an explicit representation of the transform, it returns an unevaluated call:

```
ilaplace(1/(1 + sqrt(t)), t, s)
```

$$\text{ilaplace}\left(\frac{1}{\sqrt{t}+1}, t, s\right)$$

`laplace` returns the original expression:

```
laplace(%, s, t)
```

$$\frac{1}{\sqrt{t}+1}$$

### Example 4

Compute this inverse Laplace transform. The result is the Dirac function:

```
ilaplace(1, s, t)
```

$$\delta(t)$$

## Parameters

### **F**

Arithmetical expression or matrix on page 1-2045 (Symbolic Math Toolbox) of such expressions

### **s**

Identifier on page 7-29 or indexed identifier on page 1-1017 representing the transformation variable

### **t**

Arithmetical expression representing the evaluation point

## Return Values

Arithmetical expression or unevaluated function call of type `ilaplace`. If the first argument is a matrix, then the result is returned as a matrix.

## Overloaded By

### **F**

## See Also

### **MuPAD Functions**

`ilaplace::addpattern` | `laplace` | `laplace::addpattern`

## Topics

“Integral Transforms” (Symbolic Math Toolbox)

# ilaplace::addpattern

Add patterns for the inverse Laplace transform

## Syntax

```
ilaplace::addpattern(pat, s, t, res, <vars, <conds>>)
```

## Description

`ilaplace::addpattern(pat, s, t, res)` teaches `ilaplace` to return  $ilaplace(pat, s, t) = res$ .

The `ilaplace` function uses a set of patterns for computing inverse Laplace transforms. You can extend the set by adding your own patterns. To add a new pattern to the pattern matcher, use `ilaplace::addpattern`. MuPAD does not save custom patterns permanently. The new patterns are available in the *current* MuPAD session only.

Variable names that you use when calling `ilaplace::addpattern` can differ from the names that you use when calling `ilaplace`. See “Example 2” on page 1-998 (Symbolic Math Toolbox).

You can include a list of free parameters and a list of conditions on these parameters. These conditions and the result are protected from premature evaluation. This means that you can use `not iszero(a^2 - b)` instead of `hold( _not @ iszero )(a^2 - b)`.

The following conditions treat assumptions on identifiers differently:

- `a^2 - b <> 0` takes into account assumptions on identifiers.
- `not iszero(a^2 - b)` disregards assumptions on identifiers.

See “Example 4” on page 1-1000 (Symbolic Math Toolbox).

## Environment Interactions

Calling `ilaplace::addpattern` changes the expressions returned by future calls to `ilaplace`.

## Examples

### Example 1

Compute the inverse Laplace transform of the function `bar`. By default, MuPAD does not have a pattern for this function:

```
ilaplace(bar(s), s, t)
```

```
ilaplace(bar(s), s, t)
```

Add a pattern for the inverse Laplace transform of `bar` using `ilaplace::addpattern`:

```
ilaplace::addpattern(bar(s), s, t, foo(t)):
```

Now `ilaplace` returns the inverse Laplace transform of `bar`:

```
ilaplace(bar(s), s, t)
```

```
foo(t)
```

After you add a new transform pattern, MuPAD can use that pattern indirectly:

```
ilaplace(exp(-s)*bar(s), s, t)
```

```
foo(t - 1) heaviside(t - 1)
```

### Example 2

Define the inverse Laplace transform of `bar(y)` using the variables `x` and `y` as parameters:



```
ilaplace::addpattern(bar(y), y, x, foo(x)):
```

The `ilaplace` function recognizes the added pattern even if you use other variables as parameters:

```
ilaplace(bar(s), s, t)
```

```
foo(t)
```

### Example 3

Add this pattern for the inverse Laplace transform of F:

```
ilaplace::addpattern(F(c, S)*G(c, S), S, T, T/(T^4 + 4*c^4)):
ilaplace(F(c, s)*G(c, s), s, t)
```

$$\frac{t}{4c^4 + t^4}$$

This pattern holds only when the first argument of F is the symbolic parameter c. If you use any other value of this parameter, `ilaplace` ignores the pattern:

```
ilaplace(F(A, s)*G(A, s), s, t)
```

```
ilaplace(F(A, s) G(A, s), s, t)
```

To use the pattern for arbitrary values of the parameter, declare the parameter c as an additional pattern variable:

```
ilaplace::addpattern(F(c, S)*G(c, S), S, T, T/(T^4 + 4*c^4), [c]):
```

Now `ilaplace` applies the specified pattern for an arbitrary value of c:

```
ilaplace(F(C, s)*G(C, s), s, t)
```

$$\frac{t}{4C^4 + t^4}$$

You also can declare several parameters as pattern variables. For example, this pattern has two pattern variables, a and b:

```
ilaplace::addpattern(f(a*y + b), y, x, g(x/a - b), [a, b]):
ilaplace(f(2*s + B), s, t)
```

$$g\left(\frac{t}{2} - B\right)$$

### Example 4

Use assumptions when adding this pattern for the inverse Laplace transform:

```
ilaplace::addpattern(BAR(x*s), s, t, sin(1/(x - 1/2))*FOO(t),
                    [x], [abs(x) < 1]):
ilaplace(BAR(x*s), s, t) assuming -1 < x < 1
```

$$\sin\left(\frac{1}{x - \frac{1}{2}}\right) \text{FOO}(t)$$

If  $|x| \geq 1$ , you cannot apply this pattern:

```
ilaplace(BAR(x*s), s, t) assuming x >= 1
```

$$\text{ilaplace}(\text{BAR}(s x), s, t)$$

If MuPAD cannot determine whether the conditions are satisfied, it returns a `piecewise` object:

```
ilaplace(BAR(x*s), s, t)
```

$$\left\{ \sin\left(\frac{1}{x - \frac{1}{2}}\right) \text{FOO}(t) \text{ if } |x| < 1 \right.$$

Note that the resulting expression defining the inverse Laplace transform of  $\text{BAR}(x*s)$  implicitly assumes that the value of  $x$  is not  $1/2$ . A strict definition of the pattern is:

```
ilaplace::addpattern(BAR(x*t), s, t, sin(1/(x - 1/2))*FOO(t),
                    [x], [abs(x) < 1, x <> 1/2]):
```

If either the conditions are not satisfied or substituting the values into the result gives an error, `ilaplace` ignores the pattern. For this particular pattern, you can omit specifying the assumption  $x \neq 1/2$ . If  $x = 1/2$ , MuPAD throws an internal “Division by zero.” error and ignores the pattern:

```
ilaplace(BAR(s/2), s, t)
```

```
ilaplace(BAR( $\frac{s}{2}$ ), s, t)
```

## Parameters

### **pat**

Arithmetical expression (Symbolic Math Toolbox) in the variable `s` representing the pattern to match.

### **s**

Identifier on page 7-29 or indexed identifier used as a variable in the pattern on page 1-1017

### **t**

Identifier on page 7-29 or indexed identifier on page 1-1017 used as a variable in the result

### **res**

Arithmetical expression in the variable `t` representing a pattern for the result

### **vars**

List of identifiers on page 7-29 or indexed identifiers on page 1-1017 used as “pattern variables” (placeholders in `pat` and `res`). You can use pattern variables as placeholders for almost arbitrary MuPAD expressions not containing `s` or `t`. You can restrict them by conditions given in the optional parameter `conds`.

### **conds**

List of conditions on the pattern variables

## **Return Values**

Object of type `DOM_NULL`

## **See Also**

### **MuPAD Functions**

`ilaplace` | `laplace` | `laplace::addpattern`

## **Topics**

“Use Custom Patterns for Transforms” (Symbolic Math Toolbox)

# ilcm

Least common multiple of integers

## Syntax

```
ilcm(i1, i2, ...)
```

## Description

`ilcm(i1, i2, ...)` computes the least common multiple of the integers  $i_1, i_2, \dots$

`ilcm` computes the least common nonnegative multiple of a sequence of integers on page 7-31. `ilcm` with a single numeric argument returns its absolute value. `ilcm` returns 1 when all arguments are 1 or -1 or no argument is given.

`ilcm` returns an error message when one of the arguments is a number but not an integer on page 7-31. If at least one of the arguments is 0, then `ilcm` returns 0. Otherwise, if one argument is not a number (Symbolic Math Toolbox), then a symbolic `ilcm` call is returned.

## Examples

### Example 1

We compute the least common multiple of some integers:

```
ilcm(-10, 6), ilcm(6, 10, 15)
```

```
30, 30
```

```
a := 4420, 128, 8984, 488:  
ilcm(a), ilcm(a, 64)
```

9689064320, 9689064320

The next example shows some special cases:

`ilcm()`, `ilcm(0)`, `ilcm(1)`, `ilcm(-1)`, `ilcm(2)`

1, 0, 1, 1, 2

If one argument is not a number, then the result is a symbolic `ilcm` call, except in some special cases:

delete x:  
`ilcm(a, x)`, `ilcm(0, x)`

`ilcm(4420, 128, 8984, 488, x)`, 0

`type(ilcm(a, x))`

"ilcm"

## Parameters

`i1i2, ...`

arithmetical expressions (Symbolic Math Toolbox) representing integers

## Return Values

Nonnegative integer on page 7-31, or a symbolic `ilcm` call.

## See Also

### MuPAD Functions

[content](#) | [factor](#) | [gcd](#) | [gcdex](#) | [icontent](#) | [ifactor](#) | [igcd](#) | [igcdex](#) | [lcm](#)

## **in\_in**

Membership

### **Syntax**

```
x in set
```

```
_in(x, set)
```

```
for y in object do body end_for
```

```
f(y) $ y in object
```

### **Description**

`x in set` is the MuPAD notation for the statement “`x` is a member of `set`.”

In conjunction with one of the keywords `for` or `$`, the meaning changes to “iterate over all operands on page 1-1493 of the object”. See `for` and `$` for details. Cf. “Example 6” on page 1-1009 (Symbolic Math Toolbox).

Apart from the usage with `for` and `$`, the statement `x in object` is equivalent to the function call `_in(x, object)`.

`x in set` is just evaluated to itself. `expand(x in set)` tries to return an equivalent expression without using the operator `in`, as described in the following paragraphs.

For sets of type `DOM_SET`, set unions on page 1-1081, differences on page 1-1078 and intersections on page 1-1074, `x in set` is expanded to an equivalent Boolean expression of equations and expressions involving `in`. Cf. “Example 1” on page 1-1007 (Symbolic Math Toolbox).

If `set` is a solution set of a single equation in one unknown, given by a symbolic call to `solve`, expanding `in` returns a Boolean condition that is equivalent to `x` being a solution. Cf. “Example 2” on page 1-1008 (Symbolic Math Toolbox).



If `set` is a `RootOf` expression, expanding `in` returns a Boolean condition that is equivalent to `x` being a root of the corresponding equation. Cf. “Example 3” on page 1-1008 (Symbolic Math Toolbox).

The function `bool` and every function that uses boolean evaluation can also handle many logical expressions involving `in`. Cf. “Example 4” on page 1-1009 (Symbolic Math Toolbox).

The function `is` handles various logical statements involving `in`, including a variety of types for the parameter `set` which are not handled by `in` itself. Cf. “Example 5” on page 1-1009 (Symbolic Math Toolbox) for a few typical cases.

Apart from the usual overloading (Symbolic Math Toolbox) mechanism by the first argument of an `in` call, `in` can be overloaded by its second argument, too. This argument must define the slot on page 1-1980 “set2expr” for this purpose. The slot will be called with the arguments `set`, `x`.

## Examples

### Example 1

`x in {1, 2, 3}` is expanded into an equivalent statement involving `=` and `or`:

```
expand(x in {1, 2, 3})
```

$$x = 1 \vee x = 2 \vee x = 3$$

The same happens if you replace `x` by a number, because Boolean expressions are only evaluated inside certain functions such as `bool` or `is`:

```
expand(1 in {1, 2, 3}), bool(1 in {1, 2, 3}), is(1 in {1, 2, 3})
```

$$1 = 1 \vee 1 = 2 \vee 1 = 3, \text{TRUE}, \text{TRUE}$$

If only some part of the expression can be simplified this way, the returned expression can contain unevaluated calls to `in`:

```
expand(x in {1, 2, 3} union A)
```

$$x \in A \vee x=1 \vee x=2 \vee x=3$$

## Example 2

For symbolic calls to `solve` representing the solution set of a single equation in one unknown, `in` can be used to check whether a particular value lies in the solution set:

```
solve(cos(x) + x = cos(2) + 2, x);  
expand(2 in %), bool(2 in %)
```

$$\text{solve}(x + \cos(x) = \cos(2) + 2, x)$$

$$\cos(2) + 2 = \cos(2) + 2, \text{ TRUE}$$

## Example 3

`in` can be used to check whether a value is a member of the solution set represented by a `RootOf` expression:

```
r := RootOf(x^2 - 1, x);  
expand(1 in r), bool(1 in r), expand(2 in r), bool(2 in r)
```

$$\text{RootOf}(x^2 - 1, x)$$

$$0 = 0, \text{ TRUE}, 3 = 0, \text{ FALSE}$$

```
expand((y - 1) in RootOf(x^2 - 1 - y^2 + 2*y, x))
```

$$2y + (y - 1)^2 - y^2 - 1 = 0$$

```
expand(%)
```

$$0 = 0$$

```
delete r:
```

## Example 4

Expressions with operator `in` are boolean expressions: they can be used like equations or inequalities.

```
if 2 in {2, 3, 5} then "ok" end
```

```
"ok"
```

## Example 5

The MuPAD function `is` can investigate membership of objects in infinite sets. It respects properties on page 1-265 of identifiers:

```
is(123 in Q_), is(2/3 in Q_)
```

```
TRUE, TRUE
```

## Example 6

In conjunction with `for` and `$`, `y in object` iterates `y` over all operands of the object:

```
for y in [1, 2] do
  print(y)
end_for:
```

```
1
```

```
2
```

```
y^2 + 1 $ y in a + b*c + d^2
```

```
 $a^2 + 1, b^2 c^2 + 1, d^4 + 1$ 
```

`delete y:`

## Parameters

**x**

An arbitrary MuPAD object

**set**

A set or an object of set-like type

**y**

An identifier or a local variable (DOM\_VAR) of a procedure

**object, f(y)**

Arbitrary MuPAD objects

## Return Values

`x in set` just returns the input.

## Overloaded By

`set, x`

## See Also

### MuPAD Functions

`_seqin` | `bool` | `contains` | `for` | `has` | `is`

# indets

Indeterminates of an expression

## Syntax

```
indets(object)
```

```
indets(object, <All>)
```

```
indets(object, <PolyExpr>)
```

```
indets(object, <RatExpr>)
```

## Description

`indets(object)` returns the indeterminates contained in `object`.

`indets(object)` returns the indeterminates of `object` as a set on page 7-50, i.e., the identifiers on page 7-29 without a value that occur in `object`, with the exception of those identifiers occurring in the 0th operand of a subexpression of `object` (see “Example 1” on page 1-1012 (Symbolic Math Toolbox)).

`indets` regards the special identifiers `PI`, `EULER`, `CATALAN` as indeterminates, although they represent constant real numbers. If you want to exclude these special identifiers, use `indets(object) minus Type::ConstantIdents` (see example “Example 1” on page 1-1012 (Symbolic Math Toolbox)).

If `object` is a polynomial on page 1-1601, a function environment on page 7-25, a procedure on page 7-45, or a built-in kernel on page 7-18function on page 7-18, then `indets` returns the empty set. See “Example 2” on page 1-1013 (Symbolic Math Toolbox).

## Examples

### Example 1

Consider the following expression:

```
delete g, h, u, v, x, y, z:  
e := 1/(x[u] + g^h) - f(1/3) + (sin(y) + 1)^2*PI^3 + z^(-3)*v^(1/2)
```

$$\frac{\sqrt{v}}{z^3} - f\left(\frac{1}{3}\right) + \frac{1}{g^h + x_u} + \pi^3 (\sin(y) + 1)^2$$

```
indets(e)
```

```
{g, h, u, v, x, y, z, pi}
```

Note that the returned set contains  $x$  and  $u$  and not, as one might expect,  $x[u]$ , since internally  $x[u]$  is converted into the functional form `_index(x, u)`. Moreover, the identifier  $f$  is not considered an indeterminate, since it is the 0th operand of the subexpression  $f(1/3)$ .

Although  $\text{PI}$  mathematically represents a constant, it is considered an indeterminate by `indets`. Use `Type::ConstantIdents` to circumvent this:

```
indets(e) minus Type::ConstantIdents
```

```
{g, h, u, v, x, y, z}
```

The result of `indets` is substantially different if one of the two options `RatExpr` or `PolyExpr` is specified:

```
indets(e, RatExpr)
```

```
{z, pi, sin(y), g^h, x_u, sqrt(v)}
```

Indeed,  $e$  is a rational expression in the “indeterminates”  $z$ ,  $\text{PI}$ ,  $\sin(y)$ ,  $g^h$ ,  $x[u]$ ,  $v^{(1/2)}$ :  $e$  is built from these atoms and the constant expression  $f(1/3)$  by

using only the rational operations  $+$ ,  $-$ ,  $*$ ,  $/$ , and  $^$  with integer exponents. Similarly,  $e$  is built from  $\pi$ ,  $\sin(y)$ ,  $z^{-3}$ ,  $1/(g^h+x[u])$ ,  $v^{1/2}$  and the constant expression  $f(1/3)$  using only the polynomial operations  $+$ ,  $-$ ,  $*$ , and  $^$  with nonnegative integer exponents:

```
indets(e, PolyExpr)
```

$$\left\{ \pi, \sin(y), \frac{1}{g^h + x_u}, \sqrt{v}, \frac{1}{z^3} \right\}$$

## Example 2

`indets` also works for various other data types. Polynomials and functions are considered to have no indeterminates:

```
delete x, y:
indets(poly(x*y, [x, y])), indets(sin), indets(x -> x^2+1)
```

$$\emptyset, \emptyset, \emptyset$$

For container objects, `indets` returns the union of the indeterminates of all entries:

```
indets([x, exp(y)], indets([x, exp(y)], PolyExpr)
```

$$\{x, y\}, \{x, e^y\}$$

For tables, only the indeterminates of the entries are returned; indeterminates in the indices are ignored:

```
indets(table(x = 1 + sin(y), 2 = PI))
```

$$\{y, \pi\}$$

## Example 3

In the previous examples we saw that the 0th operand of a subexpression is not used for finding indeterminates. With the option `All` this is changed:

```
delete x: e := sin(x):  
indets(e, All)
```

```
{sin, x}
```

A more complex example:

```
delete g, h, u, v, y, z:  
e := 1/(x[u] + g^h) - f(1/3) + (sin(y) + 1)^2*PI^3 + z^(-3)*v^(1/2)
```

$$\frac{\sqrt{v}}{z^3} - f\left(\frac{1}{3}\right) + \frac{1}{g^h + x_u} + \pi^3 (\sin(y) + 1)^2$$

```
indets(e, All)
```

```
{_index, _mult, _plus, _power, f, g, h, sin, u, v, x, y, z, pi}
```

```
delete e:
```

## Parameters

### object

An arbitrary object

## Options

### All

Identifiers occurring in the  $\theta$ th operand of a subexpression of `object` are also included in the result.

With this option, the  $\theta$ th operand of a subexpression is not excluded from the search for indeterminates of `object`. So if the  $\theta$ th operand of a subexpression is an indeterminate e.g. like `sin` it is included in the result, Cf. “Example 3” on page 1-1013 (Symbolic Math Toolbox).



## **PolyExpr**

Return a set on page 7-50 of arithmetical expressions (Symbolic Math Toolbox) such that `object` is a polynomial expression (Symbolic Math Toolbox) in the returned expressions

With this option, `object` is considered as a polynomial expression (Symbolic Math Toolbox). Non-polynomial subexpressions, such as `sin(x)`, `x^(1/3)`, `1/(x+1)`, or `f(a, b)`, are considered as indeterminates and are included in the returned set. However, subexpressions such as `f(2, 3)` are considered as constants even when the identifier `f` has no value. The philosophy behind this is that the expression is constant because the operands are constant (see “Example 1” on page 1-1012 (Symbolic Math Toolbox)).

If `object` is an array on page 7-2, a list on page 7-41, a set on page 7-50, or a table on page 1-2103, then `indets` returns a set of arithmetical expressions such that each entry of `object` is a polynomial expression in these expressions. See “Example 2” on page 1-1013 (Symbolic Math Toolbox).

## **RatExpr**

Return a set on page 7-50 of arithmetical expressions (Symbolic Math Toolbox) such that `object` is a rational expression (Symbolic Math Toolbox) in the returned expressions

With this option, `object` is considered as a rational expression (Symbolic Math Toolbox). Similar to `PolyExpr`, non-rational subexpressions are considered as indeterminates (see “Example 1” on page 1-1012 (Symbolic Math Toolbox)).

## **Return Values**

set on page 7-50 of arithmetical expressions (Symbolic Math Toolbox).

## **Overloaded By**

`object`

## **Algorithms**

If `object` is an element of a library domain (Symbolic Math Toolbox) `T` that has a slot “`indets`”, then the slot routine `T::indets` is called with `object` as argument. This can

be used to extend the functionality of `indets` to user-defined domains. If no such slot exists, then `indets` returns the empty set.

## See Also

### **MuPAD Functions**

`Type::Indeterminate` | `Type::PolyExpr` | `Type::RatExpr` | `collect` | `domtype` | `op` | `poly` | `rationalize` | `type`

## []\_index

Indexed access

### Syntax

```
x[ i ]
x[ i1,i2,... ]
x[ i1..i2 ]
x[ [i1,i2,...] ]
x[ [i1,i2,...], [k1,k2,...] ]
_index( x, i )
_index( x, i1,i2,... )
_index( x, i1..i2 )
_index( x, [i1,i2,...] )
_index( x, [i1,i2,...], [k1,k2,...] )
```

### Description

`_index` is a functional form of the `[]` operator. The calls `x[...]` and `_index(x,...)` are equivalent.

`x[i]` returns the entry of `x` corresponding to the index `i`. Any MuPAD object `x` allows an indexed call of the form `x[i]`. If `x` is not a container object (such as sets, lists, vectors, arrays, hfarrays, tables, matrices), then `x[i]` returns a symbolic indexed object. In particular, if `x` is an identifier on page 7-29, then `x[i]` returns an “indexed identifier”. In this case, indices can be arbitrary MuPAD objects. See “Example 1” on page 1-1019 (Symbolic Math Toolbox).

`x[i1,i2,...]` returns the entries of `x` corresponding to the indices `i1,i2,...`, specified as a sequence. For example, if `x` is a matrix, then `x[2, 3]` returns the third element of the second row of `x`.

`x[i1..i2]` returns the entries of `x` corresponding to integer indices in the range `[i1..i2]`, including `x[i1]` and `x[i2]`. In particular, this applies to lists, sets, expression sequences, and strings on page 7-53. See “Example 7” on page 1-1022 (Symbolic Math Toolbox).

`x[[i1,i2,...]]` returns the entries of `x` corresponding to the specified indices, given as a list of integers. Here, `x` must be a list, matrix, or vector.

- If `x` is a list, then `x[[i1,i2,...]]` returns the list `[x[i] $ i in [i1,i2,...]]`. See “Example 8” on page 1-1024 (Symbolic Math Toolbox).
- If `x` is a row vector, then `x[[i1,i2,...]]` returns the row vector `matrix(1, nops([i1,i2,...]), [x[i] $ i in [i1,i2,...]])`.
- If `x` is a column vector, then `x[[i1,i2,...]]` returns the column vector `matrix(nops([i1,i2,...]), 1, [x[i] $ i in [i1,i2,...]])`.

`x[[i1,i2,...],[k1,k2,...]]` returns the matrix `matrix([[x[i,k] $ k in [k1,k2,...]] $ i in [i1,i2,...]])`. Here, `x` must be a matrix. See “Example 9” on page 1-1024 (Symbolic Math Toolbox).

Depending on the type of `x`, these restrictions apply to the indices:

- For lists on page 7-41, finite sets on page 7-50, or expression sequences on page 1-88, the index `i` can only be an integer from 1 to `nops(x)`, or `-nops(x)` to `-1`, or a range on page 1-16 of these numbers.
- For arrays on page 7-2 and `hfarrays` on page 7-27, use appropriate indices `i` or multiple indices `i1,i2,...` from the index range defined by `array` or `hfarray`. Integers outside this range cause an error. If any specified index is not an integer (for example, a symbol `i`), then `x[i]` or `x[i1,i2,...]` is returned symbolically.
- For matrices on page 1-2045 (Symbolic Math Toolbox), use appropriate indices `i` or double indices `i1,i2` from the index range defined by `matrix`. Indices outside this range or symbolic indices cause an error.
- For tables on page 1-2103, you can use any object as an index. If there is no corresponding entry in the table, then `x[i]` or `x[i1,i2,...]` is returned symbolically.
- For character strings on page 7-53, the index `i` must be an integer from 1 to `length(x)`.

`_index` uses the order in which the entries appear on the screen, and `op` uses the internal order of the entries. For some container objects, these orders differ. In particular:

- For lists and sequences,  $x[i] = \text{op}(x, i)$  for positive indices. For negative indices,  $x[i] = \text{op}(x, \text{nops}(x) + 1 + i)$ .
- For finite sets on page 7-50,  $x[i]$  returns the  $i$ th element as printed on the screen. Before screen output and indexed access, the elements of sets are sorted via the slot `DOM_SET::sort`. In general,  $x[i] \neq \text{op}(x, i)$  for finite sets  $x$ .
- For one-dimensional arrays  $x := \text{array}(1..n, [\dots])$  or  $x := \text{hfarray}(1..n, [\dots])$ , the entries correspond to the operands,  $x[i] = \text{op}(x, i)$ .
- For a one-dimensional matrix representing a column vector,  $x[i] = x[i, 1] = \text{op}(x, i)$ . For a one-dimensional matrix representing a row vector,  $x[i] = x[1, i] = \text{op}(x, i)$ .

The entry returned by an indexed call is fully evaluated. For lists, matrices, arrays, and tables, you can suppress evaluation in indexed calls by using `indexval`. See “Example 10” on page 1-1025 (Symbolic Math Toolbox).

Indexed access to expressions and numbers is implemented via library callbacks. Do not use `_index` in program files to access the operands of expressions and numbers. Use `op` instead for more efficiency.

If  $x$  is not a container object (such as sets, lists, vectors, arrays, hfarrays, tables, matrices), then indexed assignments (such as  $x[i] := \text{value}$ ) implicitly convert  $x$  into a table on page 1-263 (Symbolic Math Toolbox) with a single entry.

## Examples

### Example 1

Solve these equations specifying variables as indexed identifiers:

```
n := 4:
equations := {x[i-1] - 2*x[i] + x[i+1] = 1 $ i = 1..n}:
unknowns := {x[i] $ i = 1..n}:
linsolve(equations, unknowns)
```

$$\left[ x_1 = \frac{4x_0}{5} + \frac{x_5}{5} - 2, x_2 = \frac{3x_0}{5} + \frac{2x_5}{5} - 3, x_3 = \frac{2x_0}{5} + \frac{3x_5}{5} - 3, x_4 = \frac{x_0}{5} + \frac{4x_5}{5} - 2 \right]$$

Symbolic indexed objects are of type "`_index`":

```
type(x[i])
```

```
"_index"
```

```
delete n, equations, unknowns:
```

## Example 2

Use indices to access the entries of typical container objects, such as lists, arrays, hardware floating-point arrays, and tables:

```
L := [1, 2, [3, 4]]:  
A := array(1..2, 2..3, [[a12, a13], [a22, a23]]):  
B := harray(1..2, 2..3, [[12.0, 13.0], [22.0, 23.0]]):  
T := table(1 = T1, x = Tx, (1, 2) = T12):
```

```
L[1], L[3][2], A[2, 3], B[2, 3], T[1], T[x], T[1, 2]
```

```
1, 4, a23, 23.0, T1, Tx, T12
```

Use indexed assignments to change the entries:

```
L[2]:= 22: L[3][2]:= 32: A[2, 3]:= 23: B[2, 3]:= 0: T[x]:= T12:  
L, A, B, T
```

```
[1, 22, [3, 32]], ( a12 a13 ), ( 12.0 13.0 ),  $\begin{array}{c|c} 1 & T1 \\ x & T12 \\ \hline 1, 2 & T12 \end{array}$ 
```

```
delete L, A, B, T:
```

## Example 3

For finite sets, an indexed call `x[i]` returns the *i*th element as printed on the screen. This element does not necessarily coincide with the *i*th (internal) operand returned by `op`:

```
S := {3, 2, 1}
```

```
{1, 2, 3}
```

```
S[i] $ i = 1..3
```

```
1, 2, 3
```

```
op(S, i) $ i = 1..3
```

```
3, 2, 1
```

```
delete S:
```

#### Example 4

The index operator also operates on character strings. The characters are enumerated starting from 1:

```
"ABCDEF"[1], "ABCDEF"[6]
```

```
"A", "F"
```

#### Example 5

The index operator also operates on mathematical expressions containing operators, such as +, -, \*, and so on:

```
X := a - b + c - 2;
X[2], X[3..-1];
delete X:
```

```
a - b + c - 2
```

```
-b, c - 2
```

For expressions with `_plus`- and `_mult` operators, the output of `_index` corresponds to the output order of the operands. If an expression with `_mult` is printed as a fraction, you can access the nominator and the denominator via indices 1 and 2:

```
X := ((a/2 + b) * c * 2)/(e-f)/x^2;  
X[1], X[2], X[1][3];  
delete X;
```

$$\frac{2c\left(\frac{a}{2}+b\right)}{x^2(e-f)}$$

$$2c\left(\frac{a}{2}+b\right), x^2(e-f), \frac{a}{2}+b$$

## Example 6

The index operator also operates on rational and complex numbers. For rational numbers, index 1 refers to the numerator, and index 2 refers to the denominator:

```
(2/3)[1], (2/3)[2]
```

2, 3

For complex numbers, indices 1 and 2 refer to the real and imaginary parts, respectively:

```
(3*I)[1], (1-I)[2]
```

0, -1

## Example 7

You can use a range on page 1-16 as an index. For lists on page 7-41, sets on page 7-50, expression sequences on page 1-88, and strings on page 7-53, this operation returns a “subexpression” consisting of the entries within the range, according to `_index`:



```
L := [1, 2, 3, 4, 5]:
S := {1, 2, 3, 4, 5}:
Str := "abcde":
```

```
L[3..4];
S[3..4];
Str[3..4]
```

```
[3, 4]
```

```
{3, 4}
```

```
"cd"
```

This includes ranges with negative numbers. When you use negative indices  $i$  for container type objects  $x$ , such as lists and sets, the call  $x[i]$  returns  $x[\text{nops}(x) + 1 + i]$ . Thus, you access elements counting indices from the end of  $x$ : the index  $-1$  refers to the last element of  $x$ , the index  $-2$  refers to the second element from the end, and so on.

```
L[3..-1];
S[1..-2]
```

```
[3, 4, 5]
```

```
{1, 2, 3, 4}
```

When you use negative indices  $i$  for strings, `_index` internally replaces  $\text{Str}[i]$  with indices  $\text{op}(\text{Str}, i + 1 + \text{length}(\text{Str}))$ :

```
Str[3..-1]
```

```
"cde"
```

You also can use this form of indexing to assign values to elements of lists and strings:

```
L[2..4] := [234]: L;
Str[3..-1] := " ??": Str;
```

```
[1, 234, 5]
```

```
"ab ??"
```

As seen above, this operation can change the number of elements in a list or the length of a string. If necessary, new places are filled with NIL or spaces, respectively:

```
L[42..42] := [42]: L;  
Str[10..11] := "the end.": Str
```

```
[1, 234, 5, NIL, NIL, NIL, NIL, NIL, NIL, NIL, NIL, NIL, NIL, NIL, NIL,  
NIL, NIL, NIL, NIL, NIL, NIL, NIL, NIL, NIL, NIL, NIL, NIL, NIL, NIL,  
NIL, NIL, NIL, NIL, NIL, NIL, NIL, NIL, 42]
```

```
"ab ??  the end."
```

## Example 8

Use the following indexed call to return a permutation of the list L. Here, the index list perm specifies the permutation.

```
L := [a, b, c, d, e]:  
perm := [5, 3, 1, 2, 4]:  
L[perm]
```

```
[e, c, a, b, d]
```

## Example 9

Use two lists of indices to pick and return a particular submatrix of a matrix:

```
A := matrix([[a11, a12, a13], [a21, a22, a23], [a31, a32, a33]]):  
l1 := [1,2]: l2 := [2,3]:  
A[l1, l2]
```

$$\begin{pmatrix} a_{12} & a_{13} \\ a_{22} & a_{23} \end{pmatrix}$$

## Example 10

Indexed calls evaluate the returned entry. Use `indexval` to suppress full evaluation:

```
delete a:
x := [a, b]: a := c:
x[1] = eval(x[1]), x[1] <> indexval(x, 1)
```

$$c = c, c \neq a$$

```
delete a:
x := table(1 = a, 2 = b): a := c:
x[1] = eval(x[1]), x[1] <> indexval(x, 1)
```

$$c = c, c \neq a$$

```
delete a:
x := array(1..2, [a, b]): a := c:
x[1] = eval(x[1]), x[1] <> indexval(x, 1)
```

$$c = c, c \neq a$$

```
delete a: x := matrix([a, b]): a := c:
x[1] = eval(x[1]), x[1] <> indexval(x, 1)
```

$$c = c, c \neq a$$

```
delete x, a:
```

## Example 11

Indexed access is not implemented for some kernel domains:

```
12343[3]
```

Error: Invalid operand. [\_index]

Define a method implementing the indexed access to integer numbers:

```
unprotect(DOM_INT):  
DOM_INT::_index := (n, i) -> text2expr(expr2text(n)[i]):  
12343[3];  
delete DOM_INT::_index: protect(DOM_INT):
```

3

## Parameters

**x**

An arbitrary MuPAD object. In particular, a container object: a list on page 7-41, a finite set on page 7-50, an array on page 7-2, an hfarray on page 7-27, a matrix on page 1-2045 (Symbolic Math Toolbox), a table on page 1-2103, an expression sequence on page 1-88, an expression in operator notation on page 1-1505, a rational number on page 7-48, a complex number on page 7-84, or a character string on page 7-53.

**i**

An index. For most container objects  $x$ , indices must be integers. If  $x$  is a table, you can use arbitrary MuPAD objects as indices.

**i1, i2, ...**

Multiple indices for matrices and multidimensional arrays. For these containers, the indices must be integers. For tables, you can also use multiple indices given by arbitrary MuPAD objects.

**i1..i2**

Indices, specified as a range on page 1-16.

**[i1, i2, ...]**

Indices, specified as a list of integers. In this case,  $x$  must be a list, matrix, or vector. (In MuPAD, a vector is a  $1 \times n$  or  $n \times 1$  matrix.)

[i1,i2...], [k1,k2...]

Indices, specified as two lists of integers. In this case, x must be a matrix.

## Return Values

Entry of x corresponding to the index. Calls with lists of indices can return a sequence, a list, a vector, or a matrix of entries corresponding to the indices. If x is not a list, a set, an array, or any other container object, then the return value is an indexed object of type "\_index".

## Overloaded By

x

## See Also

### MuPAD Domains

DOM\_ARRAY | DOM\_HFARRAY | DOM\_LIST | DOM\_SET | DOM\_STRING | DOM\_TABLE

### MuPAD Functions

:= | Type::Indeterminate | \_assign | array | contains | hfarray | indexval | op | slot | table

# indexval

Indexed access to arrays and tables without evaluation

## Syntax

```
indexval(x, i)
```

```
indexval(x, i1, i2, ...)
```

## Description

`indexval(x, i)` and `indexval(x, i1, i2, ...)` yields the entry of `x` corresponding to the indices `i` and `i1, i2, ...`, respectively, without evaluation.

The three calls `indexval(x, i)`, `_index(x, i)`, and `x[i]` all return the element of index `i` in the array on page 7-2 or `harray` on page 7-2 or list on page 7-41 or table on page 1-2103 `x`. In contrast to `_index` and the equivalent index operator `[ ]`, however, `indexval` returns the corresponding entry without evaluating it. This is sometimes desirable for efficiency reasons.

The arguments `i` or `i1, i2, ...` must be a valid indices of `x`, otherwise an error message is printed (see “Example 3” on page 1-1031 (Symbolic Math Toolbox)). When several indices `i1, i2, ...` are given, they are interpreted as a higher-dimensional index (see “Example 4” on page 1-1031 (Symbolic Math Toolbox)).

The first argument `x` may also be a set on page 7-50, a string on page 7-53, or an expression sequence on page 1-88. However, in these cases `indexval` behaves exactly like `_index` and the index operator `[ ]`: it returns the evaluation of the corresponding element. In particular, `indexval` does not flatten (Symbolic Math Toolbox) its first argument.

For all other basic domains (Symbolic Math Toolbox), `indexval` behaves exactly like `_index`: either an error occurs, or a symbolic `indexval` call is returned (see “Example 3” on page 1-1031 (Symbolic Math Toolbox)).

## Examples

### Example 1

indexval works with tables:

```
T := table("1" = a, Be = b, `+` = a + b):
a := 1: b := 2:
indexval(T, Be), indexval(T, "1"), indexval(T, `+`)
```

*b, a, a + b*

In contrast `_index` evaluates returned entries:

```
_index(T, Be), _index(T, "1"), _index(T, `+`)
```

*2, 1, 3*

The next input line has the same meaning as the last:

```
T[Be], T["1"], T[`+`]
```

*2, 1, 3*

indexval works with arrays, too. The behavior is the same, but the indices must be positive integers:

```
delete a, b:
A := array(1..2, 1..2, [[a, a + b], [a - b, b]]):
a := 1: b := 2:
indexval(A, 2, 2), indexval(A, 1, 1), indexval(A, 1, 2)
```

*b, a, a + b*

```
_index(A, 2, 2), _index(A, 1, 1), _index(A, 1, 2)
```

*2, 1, 3*

```
A[2, 2], A[1, 1], A[1, 2]
```

```
2, 1, 3
```

```
delete A, T, a, b:
```

`indexval` works lists, too:

```
delete a, b:  
L := [a, b, 2]:  
b := 5:  
L[2], _index(L, 2), indexval(L, 2), op(L, 2)
```

```
5, 5, b, 5
```

## Example 2

However, there is no difference between `indexval` and `_index` for all other valid objects, e.g., sets:

```
delete a, b:  
S := {a, b, 2}:  
b := 5:  
S[2], _index(S, 2), indexval(S, 2), op(S, 2)
```

```
5, 5, 5, 5
```

Similarly, there is no difference when the first argument is an expression sequence (which is not flattened by `indexval`):

```
delete a, b: S := a, b, 2:  
b := 5:  
S[2], _index(S, 2), indexval(S, 2), op(S, 2)
```

```
5, 5, 5, 5
```

```
delete L, S, a, b:
```



### Example 3

If the second argument is not a valid index, an error occurs:

```
A := array(1..2, 1..2, [[a, b], [a, b]]):
indexval(A, 3)
```

Error: Index dimension does not match. [array]

```
indexval(A, 1, 0)
```

Error: Invalid argument. [array]

```
indexval("12345", 6)
```

Error: Invalid index. [string]

However, the result of `indexval` can also be a symbolic `indexval` call:

```
T := table(1 = a, 2 = b):
indexval(T, 3)
```

```
indexval(T, 3)
```

```
delete X, i:
indexval(X, i)
```

```
indexval(X, i)
```

```
delete A, T:
```

### Example 4

For arrays the number of indices must be equal to the number of dimensions of the array:

```
A := array(1..2, 1..2, [[a, b], [a, b]]):
a := 1: b := 2:
indexval(A, 1, 2), indexval(A, 2, 1)
```

*b, a*

Otherwise an error occurs:

```
indexval(A, 1)
```

Error: Index dimension does not match. [array]

Tables can have expression sequences as indices, too:

```
delete a, b:  
T := table((1, 1) = a, (2, 2) = b):  
a := 1: b := 2:  
indexval(T, 1, 1), indexval(T, 2, 2)
```

*a, b*

```
delete A, T, a, b:
```

## Parameters

**x**

Essentially a table on page 1-2103, a list on page 7-41, or an array on page 7-2. Also allowed: a harray on page 7-27, a finite set on page 7-50, an expression sequence on page 1-88, or a character string on page 7-53

**i, i1, i2, ...**

Indices. For most “containers” *x*, indices must be integers. If *x* is a table, arbitrary MuPAD objects can be used as indices.

## Return Values

Entry of *x* corresponding to the index. When *x* is a table, a list or an array, the returned entry is not evaluated again.

## Overloaded By

x

## See Also

### MuPAD Domains

DOM\_ARRAY | DOM\_HFARRAY | DOM\_LIST | DOM\_SET | DOM\_STRING | DOM\_TABLE

### MuPAD Functions

:= | \_assign | \_index | array | contains | op | table

# infinity

Real positive infinity

## Syntax

`infinity`

## Description

`infinity` represents the infinite point on the positive real semi-axis.

`infinity` is an element of the domain `stdlib::Infinity`. It may be used in arithmetical operations. Some system functions accept `infinity` as a parameter or return it as a result.

## Examples

### Example 1

`infinity` can be used in arithmetical operations with real numbers:

```
7*infinity + 3, -3.0*infinity, 1/infinity,  
infinity*infinity, infinity^2, sqrt(infinity)
```

```
 $\infty, -\infty, 0, \infty, \infty, \infty$ 
```

Arithmetic with complex numbers or symbolic objects yields symbolic expressions:

```
I*infinity + b
```

```
 $i\infty + b$ 
```

The arithmetic responds to properties on page 1-265:

```
assume(a > 0): a*infinity
```

 $\infty$ 

```
assume(a < 0): a*infinity
```

 $-\infty$ 

```
unassume(a): a*infinity
```

 $a \infty$ 

Cancellation of infinities yields undefined:

```
infinity - infinity, infinity/infinity
```

 $\text{undefined, undefined}$ 

Some system functions accept `infinity` as a parameter or return it as result:

```
exp(infinity), sum(1/n, n = 1..infinity),
int(exp(-x^2), x = -infinity..infinity),
limit(x, x = infinity)
```

 $\infty, \infty, \sqrt{\pi}, \infty$ 

## See Also

### MuPAD Functions

`complexInfinity` | `undefined`

## info

Prints short information

### Syntax

```
info(object)
```

```
info()
```

### Description

`info(object)` prints short information about `object`.

`info` prints a short descriptive information about `object`.

If `object` is a domain (Symbolic Math Toolbox), additional information is given about the methods of the domain.

A call to `info` without arguments prints a reference to a random help page.

Users can add information about their own functions and domains by overloading (Symbolic Math Toolbox)`info`. If `object` is a user-defined domain (Symbolic Math Toolbox) or function environment on page 7-25 providing a slot on page 1-1980 "`info`", whose value is a string on page 7-53, then the call `info(object)` prints this string. See "Example 2" on page 1-1037 (Symbolic Math Toolbox).

### Examples

#### Example 1

With `info()`, you obtain a reference to a random help page:

```
info()
```

---

-- Help page of the day:

?input

The next example shows information about the library property (Symbolic Math Toolbox):

```
info(property)
```

```
Library 'property': properties of identifiers
```

-- Interface:

```
property::depends, property::hasprop,
```

info prints information about preferences:

```
info(Pref::autoPlot)
```

```
Automatically plot graphical objects instead of typesetting
```

If no more information is available, a short type description is given:

```
info(a + b):
```

```
info([a, b]):
```

```
a + b -- an expression of type "_plus"
```

```
[a, b] -- of domain type 'DOM_LIST'
```

## Example 2

info prints information about a function environment:

```
info(sqrt)
```

```
sqrt -- the square root
```

`sqrt` is a function environment on page 7-25 and has a slot on page 1-1980 named "info":

```
domtype(sqrt), sqrt::info
```

```
DOM_FUNC_ENV, "sqrt -- the square root"
```

User-defined procedures on page 7-45 can contain short information. By default, `info` does only return some general information:

```
f := x -> x^2: info(f):
```

```
f(x) -- a procedure of domain type 'DOM_PROC'
```

To improve this, we embed the function `f` into a function environment on page 7-25 and store an information string in its "info" slot:

```
f := funcenv(f):  
f::info := "f -- the squaring function":  
info(f)
```

```
f -- the squaring function
```

```
delete f:
```

## Parameters

### object

Any MuPAD object

## Return Values

Void object `null()` of type `DOM_NULL`.



## Algorithms

If the argument `object` of `info` is a domain (Symbolic Math Toolbox), then the call `info(object)` first prints the entry "info", which must be a string on page 7-53. Then the entry "interface", which must be a set of identifiers on page 7-29, is used to display all public methods, and the entry "exported", which is a set of identifiers on page 7-29 created by `export::stl`, is used to display all exported methods.

## See Also

### MuPAD Functions

`help` | `print`

# input

Interactive input of objects

## Syntax

```
input(<prompt1>)
```

```
input(<prompt1>, x1, <prompt2>, x2, ...)
```

## Description

`input` allows interactive input of MuPAD objects.

`input()` displays the prompt "Please enter expression:" and waits for input by the user. The input, terminated by pressing the Return key, is parsed and returned *unevaluatedly*.

`input(prompt1)` uses the character string `prompt1` instead of the default prompt "Please enter expression:".

`input(prompt1 x1)` assigns the input to the identifier or local variable `x1`. The default prompt is used, if no prompt string is specified.

Several objects can be read with a single `input` command. Each identifier or variable in the sequence of arguments makes `input` return a prompt, waiting for input to be assigned to it. A character string preceding an identifier or variable in the argument sequence replaces the default prompt (see "Example 2" on page 1-1042 (Symbolic Math Toolbox)). Arguments that are neither prompt strings nor identifiers or variables are ignored.

The identifiers or variables `x1` etc. may have values. These are overwritten by `input`.

`input` only parses the input objects for syntactical correctness. It does not evaluate them. Use `eval` to evaluate the results (see "Example 3" on page 1-1042 (Symbolic Math Toolbox)).

## Examples

### Example 1

The default prompt is displayed. The input is returned without evaluation:

```
input()  
Please enter expression: << 1 + 2 >>  
  
1 + 2
```

A character string is used as a prompt:

```
input("enter a number: ")  
enter a number: << 5  
>>  
  
5
```

The input may be assigned to an identifier:

```
input(x)  
Please enter expression: << 5 >>  
  
5  
  
x  
  
5
```

A user-defined prompt is used, the input is assigned to an identifier:

```
input("enter a number: ", x)  
enter a number: << 6  
>>
```

```
        6
x
        6
delete x:
```

## Example 2

If several objects are to be read, for each object a separate prompt can be defined:

```
input("enter a matrix: ", A, "enter a vector: ", x)
enter a matrix: << matrix([[a11,
a12], [a21, a22]]) >>
enter
a vector: << matrix([x1, x2]) >>
matrix([x1, x2])
A, x
```

$$\begin{pmatrix} a11 & a12 \\ a21 & a22 \end{pmatrix}, \begin{pmatrix} x1 \\ x2 \end{pmatrix}$$

```
delete A, x:
```

## Example 3

The following procedure asks for an expression and a variable. After interactive input, the derivative of the expression with respect to the variable is computed:

```
interactiveDiff :=
proc()
local f, x;
begin
f := input("enter an expression: ");
x := input("enter an identifier: ");
```

```

        print(Unquoted, "The derivative of " . expr2text(f) .
              " with respect to " . expr2text(x) . " is:");
        diff(f, x)
    end_proc:
interactiveDiff()

enter an expression: <<
x^2 + x*y^3 >>

enter an identifier:
<< x >>

The derivative
of x^2 + x*y^3 with respect to x is:

```

$$2x + y^3$$

The function input does not evaluate the input. This leads to the following unexpected result:

```

f := x^2 + x*y^3:
z := x:
interactiveDiff()

enter
an expression: << f >>

enter
an identifier: << z >>

The
derivative of f with respect to z is:

```

$$0$$

The following modification enforces full evaluation via eval:

```

interactiveDiff :=
  proc()
    local f, x;
    begin
      f := eval(input("enter an expression: "));

```

```
x := eval(input("enter an identifier: "));
print(Unquoted, "The derivative of " . expr2text(f) .
      " with respect to " . expr2text(x) . " is:");
diff(f, x)
end_proc:

interactiveDiff()

enter an expression: <<
f >>

enter an identifier:
<< z >>

The derivative
of x^2 + x*y^3 with respect to x is:

2 x + y3

delete interactiveDiff, f, z:
```

## Parameters

**prompt1, prompt2, ...**

Input prompts: character strings on page 7-53

**x1, x2, ...**

identifiers on page 7-29 or local variables on page 7-56

## Return Values

Last input

## See Also

### MuPAD Functions

`finput` | `fprint` | `fread` | `ftextinput` | `import::readbitmap` | `import::readdata`  
| `print` | `read` | `text2expr` | `textinput` | `write`

# int

Definite and indefinite integrals

---

**Note** For indefinite integration in MATLAB®, see the Symbolic Math Toolbox™ `int` function. For numerical integration, see the `integral` function.

---

## Syntax

```
int(f, x)
```

```
int(f, x = a .. b, options)
```

## Description

`int(f, x)` computes the indefinite integral  $\int f(x) dx$ .

`int(f, x = a..b)` computes the definite integral  $\int_a^b f(x) dx$ .

`int(f, x)` determines a function  $F$  such that  $\frac{\partial}{\partial x} F(x) = f(x)$ . The function  $F(x)$  is called the antiderivative of  $f(x)$ . Results returned by `int` do not include integration constants.

For indefinite integrals, `int` implicitly assumes that the integration variable  $x$  is real. For definite integrals, `int` restricts the integration variable  $x$  to the specified integration interval  $[a, b]$  of the type `Type::Interval`. If one or both integration bounds  $a$  and  $b$  are not numeric, `int` assumes that  $a \leq b$  unless you explicitly specify otherwise. By default, `int` does not issue warnings about these assumptions. To display the warnings about using implicit assumptions, set the value of `intlib::printWarnings` to `TRUE`.

In general, the result of `int` is not required to be valid for all complex values of  $x$ . For example, the identity  $\ln(e^x) = x$  is only valid for real values of  $x$ . Therefore,

$\int \ln(e^x) dx = \frac{x^2}{2}$  is also valid only for real values of  $x$ .



You can specify your own assumptions of the integration variable. If these assumptions do not conflict with the default assumption that the variable is real or with the integration interval, then MuPAD uses your assumptions. Otherwise, the `int` function issues a warning and changes the assumptions. Use `intlib::printWarnings` to enable or disable the warnings.

If you compute an indefinite integral and specify properties of the integration variable that describe a subset of the real numbers, MuPAD assumes that the variable is real. Otherwise, the system uses temporary assumption that the integration variable is complex. This assumption holds only during this particular integration.

If you compute a definite integral and specify properties that conflict with the integration interval, `int` uses the integration interval.

`int` can return results with discontinuities even if the integrand is continuous.

Integration techniques, such as table lookup or Risch integration for an indefinite integral, can add new discontinuities during the integration process. These new discontinuities appear because the antiderivatives can require the introduction of complex logarithms. Complex logarithms have a jump discontinuity when the argument crosses the negative real axis, and the integration algorithms sometimes cannot find a representation where these jumps cancel.

If you compute a definite integral by first computing an indefinite integral and then substituting the integration boundaries into the result, remember that indefinite integration can produce discontinuities. If it does, you must investigate the discontinuities in the integration interval.

If MuPAD cannot find a closed-form solution for the integral and cannot prove that such form does not exist, it returns an unresolved integral. In this case, you can approximate the integral numerically or try computing a series expansion of the integral. See “Example 2” on page 1-1049 (Symbolic Math Toolbox) and “Example 3” on page 1-1050 (Symbolic Math Toolbox).

You can approximate a definite integral numerically using `numeric::int` or `float`. Numeric approximation of a definite integral only works when the `float` function can convert the boundaries `a` and `b` of the integration interval to floating-point numbers on page 7-23. See “Example 2” on page 1-1049 (Symbolic Math Toolbox).

`int` might not find a closed form of a definite integral because of singularities of the integrand in the interval of integration. If the integral does not exist in a strict mathematical sense, `int` returns the value `undefined`. In this case, try using

assumptions. Alternatively, use the `PrincipalValue` option to compute a weaker form of a definite integral called the Cauchy principal value. This form of an integral can exist even though the standard integral value is undefined. See “Example 6” on page 1-1052 (Symbolic Math Toolbox).

In general, the derivative of the result coincides with  $f$  on a dense subset of the real numbers (or, if you use assumptions on the integration variable, the subset of real numbers specified by these assumptions).

It is not always possible to decide algorithmically if  $\frac{\partial}{\partial x} F(x)$  and  $f$  are equivalent. The reason is the so-called zero equivalence problem, which in general is undecidable.

## Environment Interactions

`int` is sensitive to properties (Symbolic Math Toolbox) of identifiers set by `assume`. See “Example 6” on page 1-1052 (Symbolic Math Toolbox).

## Examples

### Example 1

Compute the indefinite integrals  $\int \frac{1}{x \ln(x)} dx$  and  $\int \frac{1}{x^2 - 8} dx$ :

```
int(1/x/ln(x), x)
```

$\ln(\ln(x))$

```
int(1/(x^2 - 8), x)
```

$-\frac{\sqrt{2} \operatorname{arctanh}\left(\frac{\sqrt{2} x}{4}\right)}{4}$

Compute the definite integral  $\frac{1}{(x \ln(x))}$  over the interval  $[e, e^2]$ :

```
int(1/x/ln(x), x = exp(1)..exp(2))
```

$$\ln(2)$$

When computing definite integrals, you can use infinities as the boundaries of the integration interval:

```
int(exp(-x^2), x = 0..infinity)
```

$$\frac{\sqrt{\pi}}{2}$$

You can compute multiple integrals. For example, compute the following definite multiple integral:

```
int(int(int(1, z = 0..c*(1 - x/a - y/b)),
      y = 0..b*(1 - x/a)), x = 0..a)
```

$$\frac{a b c}{6}$$

## Example 2

Use `int` to compute this definite integral. Since `int` cannot find a closed form of this integral, it returns an unresolved integral:

```
S := int(sin(cos(x)), x = 0..1)
```

$$\int_0^1 \sin(\cos(x)) \, dx$$

Use the `float` function to approximate the integral numerically:

```
float(S)
```

$$0.738642998$$

Alternatively, use the `numeric::int` function, which is faster because it does not involve any symbolic preprocessing:

```
numeric::int(sin(cos(x)), x = 0..1)
```

0.738642998

### Example 3

Use `int` to compute this indefinite integral. Since `int` cannot find a closed form of this integral, it returns an unresolved integral:

```
int((x^2 + 1)/sqrt(sqrt(x + 1) + 1), x)
```

$$\int \frac{x^2 + 1}{\sqrt{\sqrt{x+1} + 1}} dx$$

Use the `series` function to compute a series expansion of the integral:

```
series(%, x = 0)
```

$$\frac{\sqrt{2} x}{2} - \frac{\sqrt{2} x^2}{32} + \frac{45 \sqrt{2} x^3}{256} - \frac{161 \sqrt{2} x^4}{8192} + \frac{2507 \sqrt{2} x^5}{327680} - \frac{12647 \sqrt{2} x^6}{3145728} + O(x^7)$$

Alternatively, compute a series expansion of the integrand, and then integrate the result. This approach is faster because it does not try to integrate the original expression. It integrates an approximation (the series expansion) of the original expression:

```
int(series((x^2 + 1)/sqrt(sqrt(x + 1) + 1), x = 0), x)
```

$$\frac{\sqrt{2} x}{2} - \frac{\sqrt{2} x^2}{32} + \frac{45 \sqrt{2} x^3}{256} - \frac{161 \sqrt{2} x^4}{8192} + \frac{2507 \sqrt{2} x^5}{327680} - \frac{12647 \sqrt{2} x^6}{3145728} + O(x^7)$$

### Example 4

The `IgnoreAnalyticConstraints` option applies a set of purely algebraic simplifications including the equality of sum of logarithms and a logarithm of a product.

Using this option, you get a simpler result, but one that might be incorrect for some of the values of the variables:

```
int(ln(x) + ln(y) - ln(x*y), x, IgnoreAnalyticConstraints)
```

$$0$$

Without using this option, you get the following result, which is valid for all values of the parameters:

```
int(ln(x) + ln(y) - ln(x*y), x)
```

$$x (\ln(x) - \ln(x y) + \ln(y))$$

The results obtained with `IgnoreAnalyticConstraints` might be not generally valid:

```
f := int(ln(x) + ln(y) - ln(x*y), x):
g := int(ln(x) + ln(y) - ln(x*y), x, IgnoreAnalyticConstraints):
simplify([f, g]) assuming x = -1 and y = -1
```

$$[-2 \pi i, 0]$$

## Example 5

By default, `int` returns this integral as a piecewise object where every branch corresponds to a particular value (or a range of values) of the symbolic parameter `t`:

```
int(x^t, x)
```

$$\begin{cases} \ln(x) & \text{if } t = -1 \\ \frac{x^{t+1}}{t+1} & \text{if } t \neq -1 \end{cases}$$

To ignore special cases of parameter values, use `IgnoreSpecialCases`:

```
int(x^t, x, IgnoreSpecialCases)
```

$$\frac{x^{t+1}}{t+1}$$

## Example 6

Compute this definite integral, where the integrand has a pole in the interior of the interval of integration. Mathematically, this integral is not defined:

```
int(1/(x - 1), x = 0..2)
```

undefined

However, the Cauchy principal value of the integral exists. Use the `PrincipalValue` option to compute the Cauchy principal value of the integral:

```
hold(int)(1/(x - 1), x = 0..2, PrincipalValue) =  
int(1/(x - 1), x = 0..2, PrincipalValue)
```

$$\int_0^2 \frac{1}{x-1} dx = 0$$

For integrands with parameters, `int` might be unable to decide if the integrand has poles in the interval of integration. In this case, `int` returns a piecewise-defined function or an unresolved integral:

```
int(1/(x - a), x = 0..2)
```

$$\begin{cases} \int_0^2 \frac{1}{x-a} dx & \text{if } a \in [0, 2] \\ \ln(2-a) - \ln(-a) & \text{if } a < 0 \vee 2 < a \vee a \notin \mathbb{R} \end{cases}$$

`int` does not call simplification functions for its results. To simplify results returned by `int`, use `eval`, `simplify`, or `Simplify`:

```
Simplify(eval(%))
```

$$\{ \ln(2-a) - \ln(-a) \text{ if } a < 0 \vee 2 < a \vee a \notin \mathbb{R}$$

The resulting piecewise expression has only one branch. If the parameter  $a$  does not satisfy this condition, the integral is undefined.

## Parameters

**f**

The integrand: an arithmetical expression (Symbolic Math Toolbox) representing a function in  $x$

**x**

The integration variable: an identifier on page 7-29

**a, b**

The boundaries: arithmetical expressions (Symbolic Math Toolbox)

## Options

### IgnoreAnalyticConstraints

When you use this option, `int` applies these simplifications rules to the integrand:

- $\ln(a) + \ln(b) = \ln(ab)$  for all values of  $a$  and  $b$ . In particular:

$$(a b)^c = e^{c \ln(ab)} = e^{c(\ln(a) + \ln(b))} = a^c b^c \text{ for all values of } a, b, \text{ and } c$$

- $\ln(a^b) = b \ln(a)$  for all values of  $a$  and  $b$ . In particular:

$$(a^b)^c = e^{b c \ln(a)} = e^{\ln(a)^{b c}} = a^{b c} \text{ for all values of } a, b, \text{ and } c$$

- If  $f$  and  $g$  are standard mathematical functions and  $f(g(x)) = x$  for all small positive numbers,  $f(g(x)) = x$  is assumed to be valid for all complex  $x$ . In particular:
  - $\ln(e^x) = x$

- $\arcsin(\sin(x)) = x$ ,  $\arccos(\cos(x)) = x$ ,  $\arctan(\tan(x)) = x$
- $\operatorname{arcsinh}(\sinh(x)) = x$ ,  $\operatorname{arccosh}(\cosh(x)) = x$ ,  $\operatorname{arctanh}(\tanh(x)) = x$
- $W_k(x e^x) = x$  for all values of  $k$

Using this option, you can get simpler solutions for some integrals for which the direct call of the integrator returns complicated results. With this option the integrator does not verify the correctness and completeness of the result. See “Example 4” on page 1-1050 (Symbolic Math Toolbox).

### **IgnoreSpecialCases**

If integration requires case analysis, ignore cases that require one or more parameters to be elements of a comparatively small set, such as a fixed finite set or a set of integers.

With this option, `int` tries to reduce the number of branches in piecewise objects. MuPAD finds equations and memberships in comparatively small sets. First, MuPAD tries to prove such equations and memberships by using the property mechanism. If the property mechanism proves an equation or a membership is true, MuPAD keeps that statement. Otherwise, MuPAD can replace that statement with the value `FALSE`.

For example, if the property mechanism cannot prove that a denominator is equal to zero, MuPAD regards this denominator as nonzero. This option can significantly reduce the number of piecewise objects in the result.

See “Example 5” on page 1-1051 (Symbolic Math Toolbox).

### **PrincipalValue**

Compute the Cauchy principal value of the integral.

If the interior of the integration interval contains poles of the integrand or the boundaries are  $a = -\infty$  and  $b = \infty$ , then the definite integral might not exist in a strict mathematical sense. However, if the integrand changes sign at all poles in the integration interval, you can compute a weaker form of a definite integral called the *Cauchy principal value*. In this form, the so-called infinite parts of the integral to the left and to the right of a pole cancel each other. When you use the `PrincipalValue` option, `int` computes the Cauchy principal value. If the definite integral exists in a strict mathematical sense, it coincides with the Cauchy principal value. See “Example 6” on page 1-1052 (Symbolic Math Toolbox).



## Return Values

arithmetical expression (Symbolic Math Toolbox)

## Overloaded By

f

## References

- [1] Bronstein, M. "A Unification of Liouvillian Extension." AAEECC Applicable Algebra in Engineering, Communication and Computing. 1: 5-24, 1990.
- [2] Bronstein, M. "The Transcendental Risch Differential Equation." Journal of Symbolic Computation. 9: 49-60, 1990.
- [3] Bronstein, M. "Symbolic Integration I: Transcendental Functions." Springer. 1997.
- [4] Epstein, H. I. and B. F. Caviness. "A Structure Theorem for the Elementary Functions and its Application to the Identity Problem." International Journal of Computer and Information Science. 8: 9-37, 1979.
- [5] Fakler, W. "Vereinfachen von komplexen Integralen reeller Funktionen." mathPAD 9 No. 1: 5-9, 1999.
- [6] Geddes, K. O., S. R. Czapora and G. Labahn. "Algorithms for Computer Algebra." 1992.

## See Also

### MuPAD Functions

D | diff | limit | numeric::int | sum

## Topics

- "Compute Indefinite Integrals" (Symbolic Math Toolbox)
- "Compute Definite Integrals" (Symbolic Math Toolbox)
- "Compute Multiple Integrals" (Symbolic Math Toolbox)

“Apply Standard Integration Methods Directly” (Symbolic Math Toolbox)

“Get Simpler Results” (Symbolic Math Toolbox)

“If an Integral Is Undefined” (Symbolic Math Toolbox)

“If MuPAD Cannot Compute an Integral” (Symbolic Math Toolbox)

# int::addpattern

Add patterns for integration

## Syntax

```
int::addpattern(pat, x, res, <[var, ...], <[cond, ...]>>)
```

```
int::addpattern(pat, x = u .. v, res, <[var, ...], <[cond, ...]>>)
```

## Description

`int::addpattern(pat, x, res)` teaches `int` to make use of  $\frac{\partial}{\partial x} \text{res} = \text{pat}$ .

`int::addpattern(pat, x=u..v, res)` teaches `int` that  $\int_u^v \text{pat} \, dx = \text{res}$ .

A large part of a computer algebra system's integration abilities stems from mathematical pattern matching. The MuPAD pattern matcher can be extended at runtime with `int::addpattern`.

Unless further limited by conditions in the fifth argument, pattern variables listed in the fourth argument represent arbitrary MuPAD expressions not containing the variable of integration, `x`.

Any identifier can be used as the variable of integration in a call to `int::addpattern`, and any identifier can be used in calls to `int`. They need not be identical.

For definite integration, each integration bound is either an arithmetical expression which may contain pattern variables, or an identifier which can be used as a variable in the result and condition terms.

Users can include additional conditions by giving additional arguments. These conditions, as well as the result, are protected from premature evaluation, i.e., it is not necessary to write `hold( _not @ iszero )(a^2-b)`, a simple `not iszero(a^2-b)` suffices.

The difference between `not iszero(a^2-b)` and `a^2-b <> 0` when given as a condition is that the latter takes into account assumptions on the identifiers encountered, while the first does not. Cf. “Example 4” on page 1-1060 (Symbolic Math Toolbox).

Patterns introduced by `int::addpattern` are also used in recursive calls of the integrator and are automatically extended to include simple applications of integration by change of variables. Cf. “Example 1” on page 1-1058 (Symbolic Math Toolbox).

Patterns added by `int::addpattern` are *not* replaced by later calls, they remain active. `int` selects the most simple result found. There is no way to remove patterns once added. Cf. “Example 5” on page 1-1061 (Symbolic Math Toolbox).

## Environment Interactions

Calling `int::addpattern` changes the expressions returned by future calls to `int`. Additionally, the remembered values of previous calls to `int` are forgotten.

## Examples

### Example 1

Not surprisingly, MuPAD does not know how to integrate the function `foo`:

```
int(foo(x), x)
```

$$\int \text{foo}(x) \, dx$$

We add a pattern for this function:

```
int::addpattern(foo(x), x, foo(x)^x)
```

```
int(foo(x), x)
```

$$\text{foo}(x)^x$$

Note that this pattern is also used indirectly:

```
int(x*foo(x^2), x)
```

$$\frac{\text{foo}(x^2)x^2}{2}$$

```
intlib::byparts(int(foo(x)*sin(x), x), foo(x))
```

$$\text{foo}(x)^x \sin(x) - \int \cos(x) \text{foo}(x)^x dx$$

## Example 2

Definite integrals can be added similarly. Note that the result does not depend on the integration variable:

```
int::addpattern(wilma(x), x=0..1, fred)
```

```
int(wilma(x), x=0..1)
```

fred

The above pattern will not match integrals with different integration bounds:

```
int(wilma(x), x=0..2)
```

$$\int_0^2 \text{wilma}(x) dx$$

Integration bounds may also contain variables occurring in the pattern or result:

```
int::addpattern(wilma(x, a), x=0..a, fred(a), [a])
```

```
int(wilma(x,2), x=0..2)
```

fred(2)

### Example 3

The integration variable in the call to `int::addpattern` need not be the same as used in the integration call:

```
int::addpattern(1/(t^2*(ln(t)+1)), t, -E*Ei(ln(t)+1))
```

```
int(cos(y)/sin(y)^2/(ln(sin(y)) + 1), y)
```

$$-e \operatorname{Ei}(\ln(\sin(y)) + 1)$$

### Example 4

Conditions are checked using `is` and therefore react to assumptions:

```
int::addpattern(1/(a+b*tan(x)^2), x,
                x/(a-b)
                - b/(2*(a-b)*sqrt(-a*b))
                  * ln((b*tan(x)-sqrt(-a*b))
                      /(b*tan(x)+sqrt(-a*b))),
                [a, b],
                [a*b < 0])
```

```
int::addpattern(1/(a+b*tan(x)^2), x,
                x/(a-b)
                - b/((a-b)*sqrt(a*b))
                  * arctan(b*tan(x)/
                          sqrt(a*b)),
                [a, b],
                [a*b > 0])
```

```
int(1/(3+a*tan(x)^2), x) assuming a > 0
```

$$\frac{3x - \sqrt{3}\sqrt{a} \arctan\left(\frac{\sqrt{3}\sqrt{a}\tan(x)}{3}\right)}{3a - 9}$$

```
int(1/(3+a*tan(x)^2), x) assuming a < 0
```

$$-\frac{x}{a-3} - \frac{\ln\left(\frac{\sqrt{-3a-a\tan(x)}}{\sqrt{-3a+a\tan(x)}}\right)\sqrt{-3a}}{6(a-3)}$$

If either the conditions are not satisfied or substituting the values into the result yields an error, the pattern is ignored. In the patterns above, the case  $a = b$  causes a division by zero. There is no need to include a condition to guard against this case, though, MuPAD simply computes the integral as usual:

```
int(1/(3+3*tan(x)^2), x)
```

$$\frac{x}{6} + \frac{\sin(2x)}{12}$$

## Example 5

Assume we have added the following pattern:

```
int::addpattern(f(x), x, f(x)^x):
```

Now,  $f$  is a pretty generic name, so we could later regard it as a different function and attempt to redefine its antiderivative:

```
int::addpattern(f(x), x, 1/sin(f'(x))):
```

```
int(f(x), x)
```

$$f(x)^x$$

What happened?

As it turns out, `int::addpattern` has simply *added* the new pattern, and since  $f(x)^x$  is considered “simpler” than  $\frac{1}{\sin(f'(x))}$ , the result of the first pattern added is still returned.

This behavior is reasonable, since there may be multiple ways of representing an antiderivative and depending on parameter values, one or the other may be preferable:

```
int::addpattern(f(a, x), x, x*f1(a, x^a), [a]):  
int::addpattern(f(a, x), x, x*f2(a, x^(1-a)), [a]):  
  
int(f(0, x), x)  
  
x f1(0, 1)  
  
int(f(1, x), x)  
  
x f2(1, 1)  
  
int(f(a, x), x)  
  
x f1(a, xa)
```

## Parameters

### **pat**

The pattern to match: an arithmetical expression (Symbolic Math Toolbox) in  $x$ .

### **x**

The variable of integration: an **identifier**.

### **u .. v**

The interval of integration for a definite integral: arithmetical expressions (Symbolic Math Toolbox) or identifiers.

### **res**

The antiderivative pattern: an arithmetical expression

### **[var, ...]**

“pattern variables”: placeholders in **pat** and **ret**, i.e., **identifiers** that do not represent themselves but almost arbitrary MuPAD expressions not containing  $x$  and restricted by the conditions in the fifth parameter.



[**cond**, ...]

Conditions on the pattern variables

## **Return Values**

Object of type DOM\_NULL

## **See Also**

### **MuPAD Functions**

int

## int2text

Convert an integer to a character string

### Syntax

```
int2text(n, <b>)
```

### Description

`int2text(n, b)` converts the integer `n` to a string that corresponds to the `b`-adic representation of `n`.

The string returned by `int2text` consists of the first `b` characters in `0, 1, ..., 9, A, B, ..., Z, a, b, ..., z`. For bases larger than 10, the letters represent the `b`-adic digits larger than 9: `A = 10, B = 11, ..., Z = 35, a = 36, b = 37, ..., z = 61`.

For the bases 2, 8, or 16, `int2text` provides the conversion from decimal representation to binary, octal, or hexadecimal representation, respectively.

`int2text` is the inverse of `text2int`.

Since the output of the numerical datatypes in MuPAD uses the decimal representation, strings are used by `int2text` to represent `b`-adic numbers. The function `numlib::g_adic` provides an alternative representation via lists.

### Examples

#### Example 1

Relative to the default base 10, `int2text` provides a mere datatype conversion from `DOM_INT` to `DOM_STRING`:

```
int2text(123), int2text(-45678)
```

```
"123", "-45678"
```

## Example 2

The decimal integer 32 has the following binary representation:

```
int2text(32, 2)
```

```
"100000"
```

The decimal integer  $10^9$  has the following hexadecimal representation:

```
int2text(10^9, 16)
```

```
"3B9ACA00"
```

... and with the base 62:

```
int2text(10^9, 62)
```

```
"15ftgG"
```

## Example 3

Negative integers can be converted as well:

```
int2text(-15, 8)
```

```
"-17"
```

## Parameters

**n**

An integer

**b**

The base: an integer between 2 and 62. The default base is 10.

## **Return Values**

character string on page 7-53.

## **See Also**

### **MuPAD Functions**

`coerce` | `expr2text` | `genpoly` | `numlib::g_adic` | `tbl2text` | `text2expr` |  
`text2int` | `text2list` | `text2tbl`

# interpolate

Polynomial interpolation

## Syntax

`interpolate(xList, yList, X, <F>)`

`interpolate(nodes, values, ind, <F>)`

## Description

`interpolate` computes an interpolating polynomial through data over a rectangular grid.

The call `interpolate(xList, yList, X)` with `xList = [x1, ..., xn]` and `yList = [y1, ..., yn]` returns the polynomial of degree less than  $n$  in the variable  $X$  which interpolates the points  $(x_1, y_1), \dots, (x_n, y_n)$ .

This call with a 1-dimensional grid `xList` is equivalent to the corresponding ‘multi-dimensional’ call `interpolate([xList], array(1..n, [yList]), [X])`.

For  $d$ -dimensional interpolation, assume that indeterminates `ind = [X1, ..., Xd]` are specified. The interpolating polynomial  $P = \text{poly}(\dots, [X_1, \dots, X_d], F)$  satisfies

$$\text{evalp}(P, X_1 = L_1[i_1], \dots, X_d = L_d[i_d]) = \text{value}[i_1, \dots, i_d]$$

for all points  $[(L_1)_{i_1}, \dots, (L_d)_{i_d}]$  in the grid.  $P$  is the polynomial of minimal degree satisfying the interpolation conditions, i.e.,  $\text{degree}(P, X_i) < n_i$ .

If only interpolating values at concrete numerical points  $X_1 = v_1, \dots, X_d = v_d$  are required, we recommend not to compute  $P$  with symbolic indeterminates `ind = [X1, ..., Xd]` and then evaluate  $P(v_1, \dots, v_d)$ . It is faster to compute this value directly by `interpolate` with `ind = [v1, ..., vd]`. Cf. examples “Example 1” on page 1-1068 (Symbolic Math Toolbox) and “Example 3” on page 1-1069 (Symbolic Math Toolbox).

## Examples

### Example 1

We consider a 1-dimensional interpolation problem. To each node  $x_i$ , a value  $y_i$  is associated. The interpolation polynomial  $P$  with  $P(x_i) = y_i$  is:

```
xList := [1, 2, 3]:  
yList := [y1, y2, y3]:  
P := interpolate(xList, yList, X)
```

$$\text{poly}\left(\left(\frac{y1}{2} - y2 + \frac{y3}{2}\right) X^2 + \left(-\frac{5y1}{2} + 4y2 - \frac{3y3}{2}\right) X + 3y1 - 3y2 + y3, [X]\right)$$

The evaluation of  $P$  at the point  $X = \frac{5}{2}$  is given by:

```
evalp(P, X = 5/2)
```

$$\frac{3y2}{4} - \frac{y1}{8} + \frac{3y3}{8}$$

This value can also be computed directly without the symbolic polynomial:

```
interpolate(xList, yList, 5/2)
```

$$\frac{3y2}{4} - \frac{y1}{8} + \frac{3y3}{8}$$

```
delete xList, yList, P:
```

### Example 2

We demonstrate multi-dimensional interpolation. Consider data over the following 2-dimensional  $2 \times 3$  grid:

```
XList := [1, 2]: YList := [1, 2, 3]:  
values := array(1..2, 1..3, [[1, 2, 3], [3, 2, 1]]):  
P := interpolate([XList, YList], values, [X, Y])
```

```
poly(-2 X Y + 4 X + 3 Y - 4, [X, Y])
```

Next, interpolation over a 3-dimensional  $2 \times 3 \times 2$  grid is demonstrated:

```
L1 := [1, 2]: L2 := [1, 2, 3]: L3 := [1, 2]:
values := array(1..2, 1..3, 1..2,
  [[1, 4], [1, 2], [3, 3]], [[1, 4], [1, 3], [4, 0]]):
interpolate([L1, L2, L3], values, [X, Y, Z])
```

$$\text{poly}\left(-3 X Y^2 Z + \frac{7 X Y^2}{2} + 10 X Y Z - \frac{23 X Y}{2} - 7 X Z + 8 X + \frac{7 Y^2 Z}{2} - 3 Y^2 - \frac{27 Y Z}{2} + 12 Y + 13 Z - 11, [X, Y, Z]\right)$$

```
delete XList, values, P, L1, L2, L3:
```

### Example 3

We interpolate data over a 2-dimensional grid:

```
n1 := 4: L1 := [i $ i = 1..n1]:
n2 := 5: L2 := [i $ i = 1..n2]:
f := (X, Y) -> 1/(1 + X^2 + Y^2):
values := array(1..n1, 1..n2,
  [[f(L1[i], L2[j]) $ j=1..n2] $ i=1..n1]):
```

First, we compute the symbolic polynomial:

```
P := interpolate([L1, L2], values, [X, Y])
```

$$\text{poly}\left(-\frac{5563 X^3 Y^4}{23108085} + \frac{16376 X^3 Y^3}{4621617} - \dots - \frac{4401895 Y}{3081078} + \frac{4199983}{2567565}, [X, Y]\right)$$

Fixing the value  $Y = 2.5$ , this yields a polynomial in  $X$ .

```
evalp(P, Y = 2.5)
```

$$\text{poly}(0.0007372500794 X^3 - 0.002155538175 X^2 - 0.03076935248 X + 0.1533997618, [X])$$

It can also be computed directly by using an evaluation point for the indeterminate  $Y$ :

```
interpolate([L1, L2], values, [X, 2.5])
```

```
poly(0.0007372500794 X3 - 0.002155538175 X2 - 0.03076935248 X + 0.1533997618, [X])
```

If all indeterminates are replaced by evaluation points, the corresponding interpolation value is returned:

```
interpolate([L1, L2], values, [1.2, 2.5])
```

```
0.114646532
```

```
delete n1, n2, f, values, P:
```

## Example 4

We demonstrate interpolation over a special coefficient field. Consider the following data over a 2-dimensional  $2 \times 3$  grid:

```
XList := [3, 4]: YList := [1, 2, 3]:  
values := array(1..2, 1..3, [[0, 1, 2], [3, 2, 1]]):
```

With the following call, these data are converted to integers modulo 7. Arithmetic over this field is used:

```
F := Dom::IntegerMod(7):  
P := interpolate([XList, YList], values, [X, Y], F)
```

```
poly(5 X Y + 5 X + 5, [X, Y], Dom::IntegerMod(7))
```

Evaluation of  $P$  at grid points reproduces the associated values converted to the field:

```
evalp(P, X = XList[2], Y = YList[3]) = F(values[2, 3])
```

```
1 mod 7 = 1 mod 7
```

```
delete XList, YList, values, F, P:
```



## Parameters

### **xList**

The nodes: a list  $[x_1, x_2, \dots]$  of distinct arithmetical expressions (Symbolic Math Toolbox)

### **yList**

The values: a list  $[y_1, y_2, \dots]$  of arithmetical expressions. This list must have the same length as **xList**.

### **X**

An indeterminate or an arithmetical expression. An indeterminate is either an identifier (of domain type `DOM_IDENT`) or an indexed identifier on page 1-1017 (of type `"_index"`).

### **nodes**

A list  $[L_1, \dots, L_d]$  of  $d$  lists  $L_i$  defining a  $d$ -dimensional rectangular grid

$$\{(x_1, \dots, x_d) \mid x_1 \in L_1, \dots, x_d \in L_d\}$$

The lists  $L_i$  may have different lengths  $n_i = |L_i|$ . The elements of each  $L_i$  must be distinct.

### **values**

A  $d$ -dimensional array  $(1..n[1], \dots, 1..n[d], [\dots])$  or `hfarray(1..n[1], \dots, 1..n[d], [\dots])` associating a value with each grid point:

$$\left[ (L_1)_{i_1}, \dots, (L_d)_{i_d} \right] \rightarrow \text{values}[i_1, \dots, i_d], i_1 = 1..n_1, \dots, i_d = 1..n_d$$

### **ind**

A list of  $d$  indeterminates or arithmetical expressions. Indeterminates are either identifiers (of domain type `DOM_IDENT`) or indexed identifiers (of type `"_index"`).

### **F**

Either `Expr` or any field of category `Cat::Field`

The returned polynomial is of type `poly(..., F)`.

For the default field `Expr`, all input data may be arbitrary MuPAD expressions. Standard arithmetic over such expressions is used to compute the polynomial.

For `F` not being `Expr`, the grid nodes as well as the entries of `values` must be elements of `F` or must be convertible to such elements. Conversion of the input data to elements of `F` is done automatically.

## Return Values

Interpolating polynomial  $P$  of domain type `DOM_POLY` in the indeterminates specified by `ind` over the coefficient field `F` is returned. The elements in `ind` that are not indeterminates but arithmetical expressions are not used as indeterminates in  $P$ , but enter its coefficients: the polynomial is “evaluated” at these points. If no element of `ind` is an indeterminate, the value of the polynomial at the point specified by `ind` is returned. This is an element of the field `F` or an arithmetical expression if `F = Expr`.

## Algorithms

For a  $d$ -dimensional rectangular grid

$$L_j = [x_{j,1}, \dots, x_{j,n_j}], j = 1, \dots, d$$

specified by the lists

$$\{(x_1, \dots, x_d) \mid x_1 \in L_1, \dots, x_d \in L_d\}$$

with associated values

$$P(x_{i_1}, \dots, x_{i_d}) = v_{i_1, \dots, i_d},$$

the interpolating polynomial in the indeterminates  $X_1, \dots, X_d$  is given by

$$P(X_1, \dots, X_d) = \sum_{i_1=1}^{n_1} \dots \sum_{i_d=1}^{n_d} v_{i_1, \dots, i_d} \times p_{1, i_1}(X_1) \times p_{d, i_d}(X_d)$$

with the Lagrange polynomials

$$p_{j,k}(X) = \prod_{l=1}^{n_j} \frac{X - x_{j,l}}{x_{j,k} - x_{j,l}}, \quad l \neq k, \quad j = 1, \dots, d, \quad k = 1, \dots, d$$

associated with the  $k$ -th node of the  $j$ -th coordinate.

## See Also

### MuPAD Functions

genpoly | numeric::cubicSpline | numeric::cubicSpline2d | poly

## intersect\_intersect

Intersection of sets or intervals or both

### Syntax

```
set1 intersect set2  
_intersect(set1, set2, ...)
```

### Description

`intersect` computes the intersection of sets and intervals.

`set1 intersect set2` is equivalent to `_intersect(set1, set2)`.

The precedences of `intersect`, `minus`, `union` are as follows. If in doubt, use parentheses to ensure that the expression is parsed as desired.

- The operator `intersect` is stronger binding than `minus`, that is, `set1 intersect set2 minus set3 = (set 1 intersect set2) minus set3`.
- The operator `minus` is stronger binding than `union`, that is, `set1 minus set2 union set3 = (set1 minus set2) union set3`.
- `set1 minus set2 minus set3 = (set 1 minus set2) minus set3`

If sets or intervals are specified by symbolic expressions involving identifiers or indexed identifiers, then symbolic calls of `_intersect` are returned. On the screen, they are represented via the operator notation `set1 intersect set2`.

---

**Note** On finite sets of type `DOM_SET`, `intersect` acts in a purely *syntactical* way. For example, `{1} intersect {x}` simplifies to an empty set `{}`. Mathematically, this result can be incorrect in general, because `x` can represent the value 1.

---

On intervals of type `Dom :: Interval`, `intersect` acts in a *semantical* way. In particular, properties on page 1-265 of identifiers are taken into account.

`_intersect()` returns `universe` (of type `stdlib::Universe`), which represents the set of all mathematical objects.

## Examples

### Example 1

`intersect` operates on finite sets:

```
{x, 1, 5} intersect {x, 1, 3, 4}
```

```
{1, x}
```

For symbolic sets, specified as identifiers or indexed identifiers, symbolic calls are returned:

```
{1, 2} intersect A intersect {2, 3}
```

```
{2} ∩ A
```

Note that `intersect` acts on finite sets in a purely syntactical way. In the following call, `x` does not match any of the numbers 1, 2, 3 syntactically:

```
{1, 2, 3} intersect {1, x}
```

```
{1}
```

### Example 2

`intersect` is overloaded by the domain `Dom::Interval`:

```
Dom::Interval(2, infinity) intersect Dom::Interval([1, 3])
```

```
(2, 3]
```

```
{PI/2, 2, 2.5, 3} intersect Dom::Interval(1,3)
```

$$\left\{2, 2.5, \frac{\pi}{2}\right\}$$

In contrast to finite sets of type `DOM_SET`, the interval domain works semantically. It takes properties into account:

```
Dom::Interval(-1, 1) intersect {x}
```

$$\begin{cases} \{x\} & \text{if } x \in (-1, 1) \\ \emptyset & \text{if } x \notin (-1, 1) \end{cases}$$

```
assume(0 < x < 1):  
Dom::Interval(-1, 1) intersect {x}
```

$$\{x\}$$

```
unassume(x):
```

### Example 3

The following list provides a collection of sets:

```
L := [{a, b}, {1, 2, a, c}, {3, a, b}, {a, c}]:
```

The functional equivalent `_intersect` of the `intersect` operator accepts an arbitrary number of arguments. Thus, the intersection of all sets in `L` can be computed as follows:

```
_intersect(op(L))
```

$$\{a\}$$

```
delete L:
```

### Example 4

`universe` represents the set of all mathematical objects:

```
_intersect()
```

universe

## Parameters

**set<sub>1</sub>, set<sub>2</sub>, ...**

Finite sets of type `DOM_SET`, or intervals of type `Dom::Interval`, or arithmetical expressions (Symbolic Math Toolbox)

## Return Values

Set, an interval, a symbolic expression of type `"_intersect"`, or universe.

## Overloaded By

set1, set2

## See Also

### **MuPAD Functions**

minus | subset | union | universe

## minus\_minus

Difference of sets or intervals or both

### Syntax

```
set1 minus set2  
_minus(set1, set2)
```

### Description

minus computes the difference between sets and intervals.

set1 minus set2 is equivalent to `_minus(set1, set2)`.

The precedences of `intersect`, `minus`, `union` are as follows. If in doubt, use parentheses to ensure that the expression is parsed as desired.

- The operator `intersect` is stronger binding than `minus`, that is, `set1 intersect set2 minus set3 = (set 1 intersect set2) minus set3`.
- The operator `minus` is stronger binding than `union`, that is, `set1 minus set2 union set3 = (set1 minus set2) union set3`.
- `set1 minus set2 minus set3 = (set 1 minus set2) minus set3`

If sets or intervals are specified by symbolic expressions involving identifiers or indexed identifiers, then symbolic calls of `_minus` are returned. On the screen, they are represented via the operator notation `set1 minus set2`.

---

**Note** On finite sets of type `DOM_SET`, `minus` acts in a purely *syntactical* way. For example, `{1} minus {x}` simplifies to `{1}`. Mathematically, this result can be incorrect in general, because `x` can represent the value 1.

---

On intervals of type `Dom :: Interval`, `minus` acts in a *semantical* way. In particular, properties on page 1-265 of identifiers are taken into account.



## Examples

### Example 1

minus operates on finite sets:

```
{x, 1, 5} minus {x, 1, 3, 4}
```

```
{5}
```

For symbolic sets, specified as identifiers or indexed identifiers, symbolic calls are returned:

```
{1, 2} minus A minus {2, 3}
```

```
(({1, 2} \ A) \ {2, 3})
```

Note that the set operations act on finite sets in a purely syntactical way. In the following call, x does not match any of the numbers 1, 2, 3 syntactically:

```
{1, 2, 3} minus {1, x}
```

```
{2, 3}
```

### Example 2

minus is overloaded by the domain `Dom::Interval`:

```
Dom::Interval(1, PI) minus {2, 3}
```

```
(1, 2) ∪ (2, 3) ∪ (3, π)
```

In contrast to finite sets of type `DOM_SET`, the interval domain works semantically. It takes properties into account:

```
Dom::Interval(-1, 1) minus {x}
```

$(-1, 1) \setminus \{x\}$

```
assume(x > 2):  
Dom::Interval(-1, 1) minus {x}
```

$(-1, 1)$

```
unassume(x):
```

## Parameters

**set<sub>1</sub>, set<sub>2</sub>, ...**

Finite sets of type `DOM_SET`, or intervals of type `Dom::Interval`, or arithmetical expressions (Symbolic Math Toolbox)

## Return Values

Set, an interval, a symbolic expression of type "`_minus`".

## Overloaded By

set1, set2

## See Also

### MuPAD Functions

intersect | subset | union | universe

# union\_union

Union of sets or intervals or both

## Syntax

```
set1 union set2  
_union(set1, set2, ...)
```

## Description

union computes the union of sets and intervals.

set1 union set2 is equivalent to `_union(set1, set2)`.

The precedences of `intersect`, `minus`, `union` are as follows. If in doubt, use parentheses to ensure that the expression is parsed as desired.

- The operator `intersect` is stronger binding than `minus`, that is, `set1 intersect set2 minus set3 = (set 1 intersect set2) minus set3`.
- The operator `minus` is stronger binding than `union`, that is, `set1 minus set2 union set3 = (set1 minus set2) union set3`.
- `set1 minus set2 minus set3 = (set 1 minus set2) minus set3`

If sets or intervals are specified by symbolic expressions involving identifiers or indexed identifiers, then symbolic calls of `_union` are returned. On the screen, they are represented via the operator notation `set1 union set2`.

---

**Note** On finite sets of type `DOM_SET`, `union` acts in a purely *syntactical* way. For example, `{1} union {x}` simplifies to `{1,x}`. Mathematically, this result can be incorrect in general, because `x` can represent the value 1.

---

On intervals of type `Dom::Interval`, `union` acts in a *semantical* way. In particular, properties on page 1-265 of identifiers are taken into account.

`_union()` returns the empty set `{}`.

## Examples

### Example 1

`union` operates on finite sets:

```
{x, 1, 5} union {x, 1, 3, 4}
```

```
{1, 3, 4, 5, x}
```

For symbolic sets, specified as identifiers or indexed identifiers, symbolic calls are returned:

```
{1, 2} union A union {2, 3}
```

```
{1, 2, 3} ∪ A
```

Note that the set operations act on finite sets in a purely syntactical way. In the following call, `x` does not match any of the numbers 1, 2, 3 syntactically:

```
{1, 2, 3} union {1, x}
```

```
{1, 2, 3, x}
```

### Example 2

`union` is overloaded by the domain `Dom::Interval`:

```
Dom::Interval([0, 1]) union Dom::Interval(1, 4)
```

```
[0, 4)
```

```
Dom::Interval([0, 1]) union Dom::Interval(4, infinity)
```

$$[0, 1] \cup (4, \infty)$$

In contrast to finite sets of type `DOM_SET`, the interval domain works semantically. It takes properties into account:

```
Dom::Interval(-1, 1) union {x}
```

$$\{x\} \cup (-1, 1)$$

```
assume(0 < x < 1):
Dom::Interval(-1, 1) union {x}
```

$$(-1, 1)$$

```
unassume(x):
```

### Example 3

The following list provides a collection of sets:

```
L := [{a, b}, {1, 2, a, c}, {3, a, b}, {a, c}]:
```

The functional equivalent `_union` of the union operator accepts an arbitrary number of arguments. Thus, the union of all sets in `L` can be computed as follows:

```
_union(op(L))
```

$$\{1, 2, 3, a, b, c\}$$

```
delete L:
```

## Parameters

`set1`, `set2`, ...

Finite sets of type `DOM_SET`, or intervals of type `Dom::Interval`, or arithmetical expressions (Symbolic Math Toolbox)

## **Return Values**

Set, an interval, a symbolic expression of type "\_union".

## **Overloaded By**

set1, set2

## **See Also**

### **MuPAD Functions**

intersect | minus | subset | universe

---

# interval

Convert constant subexpressions to intervals

## Syntax

`interval(object)`

## Description

`interval(object)` converts all constant subexpressions of `object` to floating point intervals. on page 7-33

`interval` is the analogue of `float`. While the latter converts exact numbers and numerical expressions to floating-point approximations, `interval` converts numbers and numerical expressions to enclosing floating-point intervals on page 7-33.

If `object` is an arithmetical expression (Symbolic Math Toolbox), `interval(object)` recursively descends into the subexpressions of `object` and replaces all integers, on page 7-31rationals, on page 7-48 and floating point numbers on page 7-23 as well as the constants CATALAN (Symbolic Math Toolbox), EULER (Symbolic Math Toolbox) and PI (Symbolic Math Toolbox) by floating-point intervals on page 7-33 enclosing them. Afterwards, the resulting expression is evaluated via interval arithmetic on page 7-33.

If `object` is not an arithmetical expression (Symbolic Math Toolbox), `interval` returns the object unchanged.

## Examples

### Example 1

Only constant expressions such as numbers  $1$ ,  $\frac{2}{3}$ ,  $0.123 + 4.5i$  etc. and numerical expressions  $\text{PI} + \text{sqrt}(2)$ ,  $\text{sin}(\text{PI}/24)$  etc. are converted to floating-point intervals. Symbolic objects such as identifiers, indexed identifiers etc. are left untouched:

```
interval(4*x[1] + PI*x[2]^2/sin(1) + 1/4)
```

```
3.733453333 ... 3.733453334 x22 + x1 4.0 ... 4.0 + 0.25 ... 0.25
```

```
interval(f(g(2 + x) + sin(1)*sqrt(PI)))
```

```
f(g(x + 2.0 ... 2.0) + 1.491468487 ... 1.491468488)
```

## Example 2

The special MuPAD constants CATALAN (Symbolic Math Toolbox), EULER (Symbolic Math Toolbox) and PI (Symbolic Math Toolbox) can be converted to an enclosing floating-point interval:

```
interval(CATALAN), interval(EULER), interval(PI)
```

```
0.9159655941 ... 0.9159655942, 0.5772156649 ... 0.577215665, 3.141592653 ... 3.141592654
```

## Parameters

### object

An arbitrary MuPAD object

## Return Values

MuPAD object

## See Also

### MuPAD Domains

Dom::FloatIV



**MuPAD Functions**

float | hull | misc::maprec

# inverse

Inverse of a matrix

---

**Note** For the inverse of a matrix in MATLAB®, see `inv`.

---

## Syntax

`inverse(A, <Normal>)`

## Description

`inverse(A)` returns the inverse of the matrix  $A$ .

If the input is a matrix  $A$  of category `Cat::Matrix`, then  $A^{-1}$  is called to compute the result. In contrast to the overloaded arithmetics, the function `inverse` also operates on arrays and `hfarrays`.

If the input matrix is an array of domain type `DOM_ARRAY`, then `numeric::inverse(A, Symbolic)` is called to compute the result.

The inverse of `hfarrays` of domain type `DOM_HFARRAY` is internally computed via `numeric::inverse(A)`.

If the argument does not evaluate to a matrix of one of the types mentioned above, a symbolic call `inverse(A)` is returned.

By default, `inverse` calls `normal` before returning results. This additional internal call ensures that the final result is normalized. This call can be computationally expensive. It also affects the result returned by `inverse` only if a matrix contains variables or exact expressions, such as `sqrt(5)` or `sin(PI/7)`.

To avoid this additional call, specify `Normal = FALSE`. In this case, `inverse` also can return normalized results, but does not guarantee such normalization. See “Example 4” on page 1-1090 (Symbolic Math Toolbox).

## Examples

### Example 1

Compute the inverse of a matrix given by various data types:

```
A := array(1..2, 1..2, [[1, 2], [3, PI]]);
inverse(A)
```

$$\begin{pmatrix} 1 & 2 \\ 3 & \pi \end{pmatrix}$$

$$\begin{pmatrix} \frac{\pi}{\pi-6} & -\frac{2}{\pi-6} \\ -\frac{3}{\pi-6} & \frac{1}{\pi-6} \end{pmatrix}$$

```
B := hfarray(1..2, 1..2, [[1, 2], [3, PI]]);
inverse(B)
```

$$\begin{pmatrix} 1.0 & 2.0 \\ 3.0 & 3.141592654 \end{pmatrix}$$

$$\begin{pmatrix} -1.099071012 & 0.6996903372 \\ 1.049535506 & -0.3498451686 \end{pmatrix}$$

```
C := matrix(2, 2, [[1, 2], [3, PI]]);
inverse(C)
```

$$\begin{pmatrix} 1 & 2 \\ 3 & \pi \end{pmatrix}$$

$$\begin{pmatrix} \frac{\pi}{\pi-6} & -\frac{2}{\pi-6} \\ -\frac{3}{\pi-6} & \frac{1}{\pi-6} \end{pmatrix}$$

```
delete A, B, C:
```

## Example 2

The following matrix is not invertible:

```
inverse(matrix([[1, 2], [3, 6]]))
```

FAIL

## Example 3

If the input does not evaluate to a matrix, then symbolic calls are returned:

```
delete A, B:  
inverse(A + 2*B)
```

$(A + 2 B)^{-1}$

## Example 4

Using `Normal` can significantly decrease the performance of `inverse`. For example, computing the inverse of this matrix takes a long time:

```
n := 5:  
inv5 := inverse(matrix(n, n, [[1/(x[i] + x[j]) $  
                               j = 1..n] $  
                               i = 1..n]]):
```

For better performance, specify `Normal = FALSE`:

```
n := 5:  
inv5 := inverse(matrix(n, n, [[1/(x[i] + x[j]) $  
                               j = 1..n] $  
                               i = 1..n]),  
                   Normal = FALSE):
```

## Parameters

**A**

Square matrix: either a two-dimensional array, a two-dimensional harray, or an object of the category `Cat::Matrix`

## Options

**Normal**

Option, specified as `Normal = b`

Return normalized results. The value `b` must be `TRUE` or `FALSE`. By default, `Normal = TRUE`, meaning that `inverse` guarantees normalization of the returned results. Normalizing results can be computationally expensive.

## Return Values

The inverse is returned as a matrix of the same type as the input matrix. If the matrix is not invertible, then `FAIL` is returned. If the input does not evaluate to a matrix, then a symbolic call of `inverse` is returned.

## Overloaded By

**A**

## See Also

**MuPAD Functions**  
`numeric::inverse`

## **`_invert`**

Reciprocal of an expression

### **Syntax**

`1/ x`

`_invert(x)`

### **Description**

`_invert(x)` computes the reciprocal  $1/x$  of  $x$ .

$1/x$  is equivalent to the function call `_invert(x)`. It represents the inverse of the element  $x$  with respect to multiplication, i.e.,  $x * (1/x) = 1$ .

The reciprocal of a number of type `Type::Numeric` is returned as a number.

$1/x$  is overloaded (Symbolic Math Toolbox) for matrix domains on page 7-252 (`matrix`) and returns the inverse of the matrix  $x$ .

If  $x$  is not an element of a library domain (Symbolic Math Toolbox) with an "`_invert`" method,  $1/x$  is internally represented as  $x^{-1} = \text{\_power}(x, -1)$ .

If  $x$  is an element of a domain with a slot on page 1-1980 "`_invert`", then this method is used to compute  $1/x$ . Many library domains overload the `/` operator by an appropriate "`_invert`" slot. Note that `a/x` calls the overloading slot `x::dom::_invert(x)` only for `a = 1`.

If neither  $x$  nor  $y$  overload the binary operator `/` by a "`_divide`" method, the quotient  $x/y$  is equivalent to  $x * y^{-1} = \text{\_mult}(x, \text{\_power}(y, -1))$ .

For finite sets,  $1/X$  is the set  $\left\{ \frac{1}{x} \mid x \in X \right\}$ .

## Examples

### Example 1

The reciprocal of an expression is the inverse with respect to \*:

```
_invert(x), x * (1/x) = x * _invert(x)
```

$$\frac{1}{x}, 1 = 1$$

```
3 * y * x^2 / 27 / x
```

$$\frac{x y}{9}$$

Internally, a symbolic expression 1/x is represented as  $x^{-1} = \text{\_power}(x, -1)$ :

```
type(1/x), op(1/x, 0), op(1/x, 1), op(1/x, 2)
```

```
"_power", _power, x, -1
```

### Example 2

For finite sets, 1/X is the set  $\left\{ \frac{1}{x} \mid x \in X \right\}$ :

```
1/{a, b, c}
```

$$\left\{ \frac{1}{a}, \frac{1}{b}, \frac{1}{c} \right\}$$

### Example 3

Various library domains such as matrix on page 7-252 domains or residue class on page 7-216 domains overload `_invert`:

```
x := Dom::Matrix(Dom::IntegerMod(7))([[2, 3], [3, 4]]):  
x, 1/x, x * (1/x)
```

$$\begin{pmatrix} 2 \bmod 7 & 3 \bmod 7 \\ 3 \bmod 7 & 4 \bmod 7 \end{pmatrix}, \begin{pmatrix} 3 \bmod 7 & 3 \bmod 7 \\ 3 \bmod 7 & 5 \bmod 7 \end{pmatrix}, \begin{pmatrix} 1 \bmod 7 & 0 \bmod 7 \\ 0 \bmod 7 & 1 \bmod 7 \end{pmatrix}$$

```
delete x:
```

## Parameters

**x**

An arithmetical expression (Symbolic Math Toolbox) or a set on page 7-50

## Return Values

Arithmetical expression or a set.

## Overloaded By

x

## See Also

### MuPAD Functions

\*|+|-|/|^|\_divide|\_subtract



# irreducible

Test irreducibility of a polynomial

## Syntax

`irreducible(p)`

## Description

`irreducible(p)` tests if the polynomial `p` is irreducible.

A polynomial  $p \in k[x_1, \dots, x_n]$  is irreducible over the field  $k$  if  $p$  is nonconstant and is not a product of two nonconstant polynomials in  $k[x_1, \dots, x_n]$ .

`irreducible` returns `TRUE` if the polynomial is irreducible over the field implied by its coefficients. Otherwise, `FALSE` is returned. See the function `factor` for details on the coefficient field that is assumed implicitly.

The polynomial may be either a (multivariate) polynomial over the rationals, a (multivariate) polynomial over a field (such as the residue class ring `IntMod(n)` with a prime number  $n$ ) or a univariate polynomial over an algebraic extension (see `Dom::AlgebraicExtension`).

Internally, a polynomial expression (Symbolic Math Toolbox) is converted to a polynomial (Symbolic Math Toolbox) of type `DOM_POLY` before irreducibility is tested.

## Examples

### Example 1

With the following call, we test if the polynomial expression  $x^2 - 2$  is irreducible. Implicitly, the coefficient field is assumed to consist of the rational numbers:

```
irreducible(x^2 - 2)
```

TRUE

```
factor(x^2 - 2)
```

$$x^2 - 2$$

Since  $x^2 - 2$  factors over a field extension of the rationals containing the radical  $\sqrt{2}$ , the following irreducibility test is negative:

```
irreducible(sqrt(2)*(x^2 - 2))
```

FALSE

```
factor(sqrt(2)*(x^2 - 2))
```

$$\sqrt{2} (x - \sqrt{2}) (x + \sqrt{2})$$

The following calls use polynomials of type DOM\_POLY. The coefficient field is given explicitly by the polynomials:

```
irreducible(poly(6*x^3 + 4*x^2 + 2*x - 4, IntMod(13)))
```

TRUE

```
factor(poly(6*x^3 + 4*x^2 + 2*x - 4, IntMod(13)))
```

$$6 \text{ poly}(x^3 + 5x^2 - 4x - 5, [x], \text{IntMod}(13))$$

```
irreducible(poly(3*x^2 + 5*x + 2, IntMod(13)))
```

FALSE

```
factor(poly(3*x^2 + 5*x + 2, IntMod(13)))
```

$$3 \text{ poly}(x + 5, [x], \text{IntMod}(13)) \text{ poly}(x + 1, [x], \text{IntMod}(13))$$

## Parameters

**p**

A polynomial (Symbolic Math Toolbox) of type `DOM_POLY` or a polynomial expression (Symbolic Math Toolbox)

## Return Values

TRUE or FALSE.

## Overloaded By

**p**

## See Also

### **MuPAD Functions**

`content` | `factor` | `gcd` | `icontent` | `ifactor` | `igcd` | `ilcm` | `isprime` | `lcm` | `poly` | `polylib::divisors` | `polylib::primpart` | `polylib::sqrfree`

## **is**

Check a mathematical property of an expression

### **Syntax**

`is(cond)`

`is(ex, set)`

### **Description**

`is(cond)` checks whether the condition `cond` holds for all possible values.

`is(ex, set)` checks whether the expression `ex` lies in the set `set`.

The property mechanism (Symbolic Math Toolbox) helps to simplify expressions involving expressions that carry “mathematical properties”. The function `assume` allows to assume “assumptions” such as ‘`x` is a real number’ or ‘`x` is an odd integer’ to an identifier `x`, say. Arithmetical expressions involving `x` may inherit such properties. E.g., ‘`1 + x^2` is positive’ if ‘`x` is a real number’. The function `is` is the basic tool for querying mathematical properties.

`is` queries the assumptions of all involved identifiers and checks whether the condition `cond` holds for all possible values. If this is the case, then `is` returns `TRUE`. If `is` derives that `cond` is not satisfied by any possible value it returns `FALSE`. Otherwise, `is` returns `UNKNOWN`.

If a relation is given to `is`, and the operands are complex numbers or identifiers with this property, `is` returns `FALSE`, because a relations holds only with real objects. Cf. “Example 4” on page 1-1101 (Symbolic Math Toolbox).

It may happen that `is` returns `UNKNOWN`, although the queried property holds mathematically. Cf. “Example 5” on page 1-1101 (Symbolic Math Toolbox).

In MuPAD, there also exists the function `bool` to check a relation `y rel z`. However, there are two main differences between `bool` and `is`:

- 1 `bool` produces an error if it cannot decide whether the relation holds or not; `is(y rel z)` returns `UNKNOWN` in this case.
- 2 `bool` does not take properties into account.

Cf. “Example 3” on page 1-1100 (Symbolic Math Toolbox).

If `bool(y rel z)` returns `TRUE`, then so does `is(y rel z)`. However, `is` is more powerful than `bool`, even when no properties are involved. Cf. “Example 3” on page 1-1100 (Symbolic Math Toolbox). On the other hand, `is` is usually much slower than `bool`.

---

**Note** Be careful when using `is` in a condition of an `if` statement or a `for`, `while`, or repeat loop: these constructs cannot handle the value `UNKNOWN`. Use either `is(...) = TRUE` or a case statement. Cf. “Example 6” on page 1-1102 (Symbolic Math Toolbox).

---

If `is` needs to check whether a constant symbolic expression is zero, then it may employ a heuristic numerical zero test based on floating-point evaluation. Despite internal numerical stabilization, this zero test may return the wrong answer in exceptional pathological cases; in such a case, `is` may return a wrong result as well.

## Examples

### Example 1

The identifier `x` is assumed to be an integer:

```
assume(x, Type::Integer):
is(x, Type::Integer), is(x > 0), is(x^2 >= 0)
```

TRUE, UNKNOWN, TRUE

The identifier `x` is assumed to be a positive real number:

```
assume(x > 0):
is(x > 1), is(x >= 0), is(x < 0)
```

UNKNOWN, TRUE, FALSE

```
unassume(x):
```

## Example 2

is can derive certain facts even when no properties were assumed explicitly:

```
is(x > x + 1), is(abs(x) >= 0)
```

```
FALSE, TRUE
```

```
is(Re(exp(x)), Type::Real)
```

```
TRUE
```

## Example 3

For relations between numbers, is yields the same answers as bool:

```
bool(1 > 0), is(1 > 0)
```

```
TRUE, TRUE
```

is resolves more constant symbolic expressions than bool:

```
is(sqrt(14) <= sqrt(2)*sqrt(7)),  
is(sin(10^20) > 0),  
is(sqrt(2) > 1.41)
```

```
TRUE, FALSE, TRUE
```

```
bool(sqrt(14) <= sqrt(2)*sqrt(7))
```

```
Error: Unable to evaluate to Boolean. [_leequal]
```

```
bool(sin(10^20) > 0)
```

```
Error: Unable to evaluate to Boolean. [_less]
```

```
is(exp(5), Type::Real), is(PI, Type::PosInt)
```

TRUE, FALSE

## Example 4

In the next example a relation with complex objects is given, the returned value is FALSE:

```
is(0 < I), is(I + 1 > I), is(1 + 2*I <= 2 + 3*I)
```

FALSE, FALSE, FALSE

The identifier in the next example is assumed to be complex, but it could be real too:

```
assume(x, Type::Complex):
is(x > 0)
```

UNKNOWN

The next relation is false, either the identifier  $x$  is real, then the relation is false, or the identifiers is not real, then the comparison is illegal:

```
unassume(x):
is(x + 1 < x)
```

FALSE

```
unassume(x):
```

## Example 5

Here are some examples where the queried property can be derived mathematically. However, the current implementation of `is` is not yet strong enough to derive the property:

```
assume(x in Z_ and y in Z_ and x^2 + y^2 = 2);
is(x > 1)
```

## UNKNOWN

```
unassume(x):
```

### Example 6

Care must be taken when using `is` in `if` statements or `for`, `repeat`, `while` loops:

```
myabs := proc(x)
begin
  if is(x >= 0) then
    x
  elif is(x < 0) then
    -x
  else
    procname(x)
  end_if
end_proc:

assume(x < 0): myabs(1), myabs(-2), myabs(x)
```

1, 2, -x

When the call of `is` returns `UNKNOWN`, an error occurs because `if` expects `TRUE` or `FALSE`:

```
unassume(x): myabs(x)
```

```
Error: Unable to evaluate to Boolean. [if]
Evaluating: myabs
```

The easiest way to achieve the desired functionality is a comparison of the result of `is` with `TRUE`:

```
myabs := proc(x)
begin
  if is(x >= 0) = TRUE then
    x
  elif is(x < 0) = TRUE then
    -x
  else
```



```

        procname(x)
      end_if
    end_proc:

myabs(x)

```

```

  myabs(x)

```

```

delete myabs:

```

## Example 7

is can handle sets returned by solve. These include intervals of type `Dom::Interval` and `R_ = solvelib::BasicSet(Dom::Real)`:

```

assume(x >= 0 and x <= 1):
is(x in Dom::Interval([0, 1])), is(x in R_)

```

```

  TRUE, TRUE

```

The following solve command returns the solution as an infinite parameterized set of type `Dom::ImageSet`:

```

unassume(x): solutionset := solve(sin(x) = 0, x)

```

```

  {π k | k ∈ ℤ}

```

```

domtype(solutionset)

```

```

  DomImageSet

```

is can be used to check whether an expression is contained in this set:

```

is(20*PI in solutionset), is(PI/2 in solutionset)

```

```

  TRUE, FALSE

```

```

delete solutionset:

```

## Parameters

### **cond**

A condition

### **ex**

arithmetical expression (Symbolic Math Toolbox)

### **set**

A property representing a set of numbers (e.g., `Type::PosInt`) or a set returned by `solve`; such a set can be an element of `Dom::Interval`, `Dom::ImageSet`, `piecewise`, or one of `C_`, `R_`, `Q_`, `Z_`.

## Return Values

TRUE, FALSE, or UNKNOWN.

## See Also

### **MuPAD Functions**

`assume` | `bool` | `getprop` | `unassume`

# isolate

Isolate variable or expression from equation

## Syntax

```
isolate(eq, expr)
```

## Description

`isolate(eq, expr)` rearranges the equation `eq` so that the expression `expr` appears on the left side. The result is similar to solving `eq` for `expr`. However, `isolate` returns only one solution even if multiple solutions exist. If `isolate` cannot isolate `expr` from `eq`, it moves all terms containing `expr` to the left side. You can use the output of `isolate` as input to `subs` to eliminate `expr` from `eq`.

If `eq` has no solution, `isolate` returns an error. The `isolate` function also ignores special cases. If the only solutions to `eq` are special cases, then `isolate` ignores those special cases and returns an error. Additionally, if the solution returned contains parameters, the parameters might not be valid for special cases.

You cannot specify `expr` as a mathematical constant such as `PI` (Symbolic Math Toolbox), `EULER` (Symbolic Math Toolbox), and so on.

By default, `isolate(eq, expr)` returns only solutions consistent with the properties (Symbolic Math Toolbox) of `expr`.

If the input contains floating-point numbers, the solver replaces them by approximate rational values. The accuracy of these approximate values depends on the environment variable `DIGITS`. If `isolate` finds a solution, MuPAD internally calls the `float` function for that solution, and then returns the result.

## Environment Interactions

`isolate` reacts to properties (Symbolic Math Toolbox) of identifiers.

## Examples

### Example 1

Isolate  $x$  from the equation  $a*x^2 + b*x + c = 0$ .

```
eqn := a*x^2 + b*x + c = 0:  
xSol := isolate(eqn, x)
```

$$x = -\frac{b + \sqrt{b^2 - 4ac}}{2a}$$

Even though the equation has multiple solutions, `isolate` returns only one solution.

Eliminate  $x$  from `eqn` by calling `subs` to substitute for  $x$  using `xSol`.

```
subs(eqn, xSol)
```

$$c + \frac{(b + \sqrt{b^2 - 4ac})^2}{4a} - \frac{b(b + \sqrt{b^2 - 4ac})}{2a} = 0$$

You can also isolate expressions. Isolate  $x(t)$  from the following equation.

```
isolate(a*x(t)^2 + b*c = 0, x(t))
```

$$x(t) = \frac{\sqrt{-b} \sqrt{c}}{\sqrt{a}}$$

Isolate  $a*x(t)$  from the same equation.

```
isolate(a*x(t)^2 + b*c = 0, a*x(t))
```

$$a x(t) = -\frac{bc}{x(t)}$$

If `isolate` cannot find a symbolic solution, it returns an error. Because `isolate` does not return special cases, it also returns an error if the only solutions are special cases.

Compare `isolate` with `solve` for an equation whose only solution is a special case.

```
solve(x = x+a, x);
isolate(x = x+a, x)
```

$$\begin{cases} \mathbb{C} & \text{if } a = 0 \\ \emptyset & \text{if } a \neq 0 \end{cases}$$

Error: Unable to isolate 'x' because the equation has no solution. [isolate]

`solve` returns the special case while `isolate` ignores the special case and returns an error.

## Example 2

For equations with multiple solutions, `isolate` returns the 'simplest' solution.

Isolate `x` from equations with many solutions to demonstrate this behavior of `isolate`.

```
isolate(cos(x) = x, x)
```

$$\cos(x) - x = 0$$

```
isolate(x^2 = 1, x)
```

$$x = 1$$

```
isolate(sin(x) = 0, x)
```

$$x = 0$$

```
isolate(sqrt(x) = C, x)
```

$$x = C^2$$

### Example 3

`isolate` only returns results compatible with assumptions on the variable to be isolated. For example, assume that  $x$  represents a real negative number. Then, isolate it from the following equation.

```
assume(x, Type::Negative):  
isolate(x^4 = 1, x)
```

$$x = -1$$

Remove the assumption. `isolate` chooses a different solution to return.

```
unassume(x):  
isolate(x^4 = 1, x)
```

$$x = 1$$

### Example 4

If the input contains floating-point numbers, MuPAD calls the `float` function for the obtained solution.

Isolate  $x$  from an equation with floating-point numbers.

```
isolate(x^3 + 3.0*x + 1 = 0, x)
```

$$x = -0.3221853546$$

### Example 5

You can isolate an expression in an equation with symbolic parameters. The `isolate` function returns a general solution where the parameter values are not guaranteed to hold for special cases.

Isolate  $x$  in the equation.

```
isolate(a*x^2/(x-a) = 1, x)
```

$$x = \frac{\sqrt{-(2a-1)(2a+1)} + 1}{2a}$$

The returned value of  $x$  does not hold in the special case that parameter  $a$  has value  $0$ .

## Parameters

### **eq**

An equation.

### **expr**

The variable or expression to be isolated.

## Return Values

`isolate(eq, expr)` returns an equation where the right side does not contain the variable or expression to be isolated. `isolate` does not introduce newly generated parameters. The returned equation is always a valid input to `subs`.

## See Also

### **MuPAD Functions**

`RootOf` | `float` | `lhs` | `linsolve` | `numeric::linsolve` | `numeric::solve` | `rhs` | `solve`

### **Topics**

“Solve Algebraic Equations and Inequalities” (Symbolic Math Toolbox)

### **Introduced in R2015a**

# **isprime**

Primality test

## **Syntax**

`isprime(n)`

## **Description**

`isprime(n)` checks whether  $n$  is a prime number.

`isprime` is a fast probabilistic prime number test (Miller-Rabin test). The function returns `TRUE` when the positive integer on page 7-31  $n$  is either a prime number or a strong pseudo-prime for 10 independently and randomly chosen bases. Otherwise, `isprime` returns `FALSE`.

If  $n$  is positive and `isprime` returns `FALSE`, then  $n$  is guaranteed to be composite. If  $n$  is positive and `isprime` returns `TRUE`, then  $n$  is prime with a very high probability.

Use `numlib::proveprime` for a prime number test that always returns the correct answer. Note, however, that it is usually much slower than `isprime`.

`isprime()` and `isprime(1)` return `FALSE`. `isprime` returns always `FALSE` if  $n$  is a negative integer.

`isprime` returns an error message if its argument is a number but not an integer on page 7-31. `isprime` returns a symbolic `isprime` call if the argument is not a number (Symbolic Math Toolbox).

## **Examples**

### **Example 1**

The number 989999 is prime:



```
isprime(989999)
```

```
TRUE
```

```
ifactor(989999)
```

```
989999
```

In contrast to `ifactor`, `isprime` can handle large numbers:

```
isprime(2^(2^11) + 1)
```

```
FALSE
```

`isprime()` and `isprime(1)` return `FALSE`:

```
isprime(0), isprime(1)
```

```
FALSE, FALSE
```

Negative numbers yield `FALSE` as well:

```
isprime(-13)
```

```
FALSE
```

For non-numeric arguments, a symbolic `isprime` call is returned:

```
delete n: isprime(n)
```

```
isprime(n)
```

## Parameters

**n**

An arithmetical expression (Symbolic Math Toolbox) representing an integer

## Return Values

Either TRUE or FALSE, or a symbolic `isprime` call.

## Algorithms

Reference: Michael O. Rabin, Probabilistic algorithms, in J. F. Traub, ed., *Algorithms and Complexity*, Academic Press, New York, 1976, pp. 21-39.

## See Also

### **MuPAD Functions**

`factor` | `ifactor` | `igcd` | `ilcm` | `irreducible` | `ithprime` | `nextprime` |  
`numlib::primedivisors` | `numlib::proveprime` | `prevprime`

# isqrt

Integer square root

## Syntax

```
isqrt(n)
```

## Description

`isqrt(n)` computes an integer approximation to the square root of the integer  $n$ .

If  $n$  is a perfect square, then `isqrt` returns the unique nonnegative integer whose square is  $n$ . More generally, if  $n$  is a nonnegative integer on page 7-31, then `isqrt` computes `trunc(sqrt(n))`. Thus the approximation error is less than 1.

If  $n$  is a negative integer, then `isqrt` computes `trunc(sqrt(-n)) * I`.

`isqrt` returns an error message if its argument is a number but not an integer on page 7-31. `isqrt` returns a symbolic `isqrt` call if the argument is not a number (Symbolic Math Toolbox).

## Examples

### Example 1

We compute some integer square roots:

```
isqrt(4), isqrt(5)
```

```
2, 2
```

The approximation error is less than 1:

```
isqrt(99), float(sqrt(99))
```

```
9, 9.949874371
```

The integer square root of a negative integer is an integral multiple of I:

```
isqrt(-4), isqrt(-5)
```

```
2 i, 2 i
```

If the argument is not a number, the result is a symbolic `isqrt` call:

```
delete n: isqrt(n)
```

```
isqrt(n)
```

```
type(%)
```

```
"isqrt"
```

## Parameters

`n`

An arithmetical expression (Symbolic Math Toolbox) representing an integer

## Return Values

Nonnegative integer on page 7-31, an integral multiple of I, or a symbolic `isqrt` call.

## Overloaded By

`n`

## See Also

### MuPAD Functions

`_power` | `icontent` | `ifactor` | `igcd` | `ilcm` | `numlib::ispower` | `numlib::issqr` | `sqrt` | `trunc`

# iszero

Generic zero test

## Syntax

`iszero(object)`

## Description

`iszero(object)` checks whether `object` is the zero element in the domain of `object`.

Use the condition `iszero(object)` instead of `object = 0` to decide whether `object` is the zero element, because `iszero(object)` is more general than `object = 0`. If the call `bool(object = 0)` returns `TRUE`, then `iszero(object)` returns `TRUE` as well, but in general not vice versa (see “Example 1” on page 1-1117 (Symbolic Math Toolbox)).

If `object` is an element of a basic type (Symbolic Math Toolbox), then `iszero` returns `TRUE` precisely if one of the following is true: `object` is the integer  $0$  (of domain type `DOM_INT`), the floating-point value  $0.0$  (of domain type `DOM_FLOAT`), the floating-point interval (of domain type `DOM_INTERVAL`)  $0 \dots 0$ , or the zero polynomial (of domain type `DOM_POLY`). In the case of a polynomial on page 1-1601, the result `FALSE` is guaranteed to be correct only if the coefficients of the polynomial are in normal form (i.e., if zero has a unique representation in the coefficient ring). See also `Ax : normalRep`.

If `object` is an element of a library domain (Symbolic Math Toolbox), then the method “`iszero`” of the domain is called and the result is returned. If this method does not exist, then the function `iszero` returns `FALSE`.

`iszero` performs a purely syntactical zero test. If `iszero` returns `TRUE`, then the answer is always correct. If `iszero` returns `FALSE`, however, then it may still be true that mathematically `object` represents zero (see “Example 3” on page 1-1118 (Symbolic Math Toolbox)). In such cases, the MuPAD functions `normal` or `simplify` may be able to recognize this.

---

**Note** `iszero` does *not* take into account properties (Symbolic Math Toolbox) of identifiers in `object` that have been set via `assume`. In particular, you should not use

iszero in an argument passed to `assume` or `is`; use the form `object = 0` instead (see “Example 2” on page 1-1118 (Symbolic Math Toolbox)).

---

**Note** Do not use `iszero` in a condition passed to `piecewise`. In contrast to `object = 0`, the command `iszero(object)` is evaluated immediately, before it is passed to `piecewise`, while the evaluation of `object = 0` is handled by `piecewise` itself. Thus using `iszero` in a `piecewise` command usually leads to unwanted effects (see “Example 4” on page 1-1118 (Symbolic Math Toolbox)).

---

## Examples

### Example 1

`iszero` handles the basic data types:

```
iszero(0), iszero(1/2), iszero(0.0), iszero(I), iszero(-1...1)
```

```
TRUE, FALSE, TRUE, FALSE, FALSE
```

`iszero` works for polynomials:

```
p:= poly(x^2 + y, [x]):  
iszero(p)
```

```
FALSE
```

```
iszero(poly(0, [x, y]))
```

```
TRUE
```

`iszero` is more general than `=`:

```
bool(0 = 0), bool(0.0 = 0), bool(poly(0, [x]) = 0)
```

```
TRUE, FALSE, FALSE
```

```
iszero(0), iszero(0.0), iszero(poly(0, [x]))
```

```
TRUE, TRUE, TRUE
```

## Example 2

`iszero` does not react to properties (Symbolic Math Toolbox):

```
assume(a = b): is(a - b = 0)
```

```
TRUE
```

```
iszero(a - b)
```

```
FALSE
```

## Example 3

Although `iszero` returns `FALSE` in the following example, the expression in question mathematically represents zero:

```
iszero(sin(x)^2 + cos(x)^2 - 1)
```

```
FALSE
```

In this case `simplify` is able to decide this:

```
simplify(sin(x)^2 + cos(x)^2 - 1)
```

```
0
```

## Example 4

`iszero` should not be used in a condition passed to `piecewise`:



```
delete x:  
piecewise([iszero(x), 0], [x <> 0, 1])
```

$$\{ 1 \text{ if } x \neq 0$$

The first branch was discarded because `iszero(x)` immediately evaluates to `FALSE`. Instead, use the condition `x = 0`, which is passed unevaluated to `piecewise`:

```
piecewise([x = 0, 0], [x <> 0, 1])
```

$$\begin{cases} 0 & \text{if } x = 0 \\ 1 & \text{if } x \neq 0 \end{cases}$$

## Parameters

### object

An arbitrary MuPAD object

## Return Values

Either `TRUE` or `FALSE`

## Overloaded By

object

## See Also

**MuPAD Axioms**  
Ax::normalRep

**MuPAD Functions**

`_equal` | `bool` | `is` | `normal` | `sign` | `simplify`

# ithprime

I-th prime number

## Syntax

```
ithprime(i)
```

```
ithprime(<PrimeLimit>)
```

## Description

`ithprime(i)` returns the *i*-th prime number.

If the argument *i* is a positive integer, then `ithprime` returns the *i*-th prime number. An unevaluated call is returned, if the argument is not of type `Type::Numeric`. An error occurs if the argument is a number that is not a positive integer on page 7-31.

The first prime number `ithprime(1)` is 2.

If the *i*-th prime number is contained in the system's internal prime number table (see the help page for `ifactor`), then it is returned by a fast kernel function. Otherwise, MuPAD iteratively calls `nextprime`, using some suitable pre-computed value of `ithprime` as starting point. This is still reasonably fast for  $i \leq 1000000$ . If *i* exceeds this value, however, then the run time grows exponentially with the number of digits of *i*.

## Examples

### Example 1

The first 10 prime numbers:

```
ithprime(i) $ i = 1..10
```

```
2, 3, 5, 7, 11, 13, 17, 19, 23, 29
```

A larger prime:

```
ithprime(123456)
```

```
1632899
```

Symbolic arguments lead to an unevaluated call:

```
ithprime(i)
```

```
ithprime(i)
```

## Parameters

**i**

An arithmetical expression (Symbolic Math Toolbox)

## Options

**PrimeLimit**

Return the number of primes in the internal prime table

`ithprime(PrimeLimit)` returns an integer, namely the number of primes in the internal prime number table. The table contains all primes below some bound which can be obtained by calling `ifactor(PrimeLimit)`. On UNIX platforms, the size of this table can be changed via the MuPAD command line flag `-L`.

## Return Values

Prime number or an unevaluated call to `ithprime`

## See Also

### MuPAD Functions

`ifactor` | `igcd` | `ilcm` | `isprime` | `nextprime` | `numlib::pi` | `prevprime`

## iztrans

Inverse Z transform

### Syntax

`iztrans(F, z, k)`

### Description

`iztrans(F, z, k)` computes the inverse Z transform of the expression  $F = F(z)$  with respect to the variable  $z$  at the point  $k$ .

If  $R$  is a positive number, such that the function  $F(Z)$  is analytic on and outside the circle  $|z| = R$ , then the inverse Z-transform is defined as follows:

$$f(k) = \frac{1}{2\pi i} \oint_{|z|=R} F(z)z^{k-1}dz, \quad k = 0, 1, 2, \dots$$

If `iztrans` cannot find an explicit representation of the transform, it returns an unevaluated function call. See “Example 3” on page 1-1125 (Symbolic Math Toolbox).

If  $F$  is a matrix, `iztrans` applies the inverse Z transform to all components of the matrix.

To compute the direct Z transform, use `ztrans`.

### Examples

#### Example 1

Compute the inverse Z transform of these expressions:

```
iztrans(exp(1/z), z, k)
```

$$\frac{1}{k!}$$

```
iztrans((z*sin(1))/(z^2 - 2*cos(1)*z + 1), z, k)
```

$$\sin(k)$$

## Example 2

Compute the inverse Z transform of this expression with respect to the variable z:

```
f := iztrans((3*z)/(z - 1) + (2*z)/(z - 1)^2, z, k)
```

$$2k + 3$$

Evaluate the inverse Z transform of the expression at the points  $k = 2a + 3$  and  $k = 1 + i$ . You can evaluate the resulting expression f using | (or its functional form evalAt):

```
f | k = 2*a + 3
```

$$4a + 9$$

Also, you can evaluate the inverse Z transform at a particular point directly:

```
iztrans((3*z)/(z - 1) + (2*z)/(z - 1)^2, z, 1 + I)
```

$$5 + 2i$$

## Example 3

If iztrans cannot find an explicit representation of the transform, it returns an unevaluated call:

```
iztrans(F(z), z, k)
```

$$\text{iztrans}(F(z), z, k)$$

ztrans returns the original expression:

```
ztrans(%, k, z)
```

$$F(z)$$

### Example 4

Compute the inverse Z transforms of these expressions. The results involve the kroneckerDelta function:

```
iztrans(1/z, z, k)
```

$$\delta_{k-1,0}$$

```
iztrans((z^3 + 3*z^2 + 6*z + 5)/z^5, z, k)
```

$$\delta_{k-2,0} + 3 \delta_{k-3,0} + 6 \delta_{k-4,0} + 5 \delta_{k-5,0}$$

### Example 5

Compute the inverse Z transform of this expression:

```
iztrans(z*diff(g(z), z), z, k)
```

$$-k \text{ iztrans}(g(z), z, k)$$

## Parameters

**F**

Arithmetical expression or matrix on page 1-2045 (Symbolic Math Toolbox) of such expressions



**z**

Identifier on page 7-29 or indexed identifier on page 1-1017

**k**

Arithmetical expression representing the evaluation point

## Return Values

Arithmetical expression or unevaluated function call of type `iztrans`. An explicit result can be a `piecewise` object. If the first argument is a matrix, then the result is returned as a matrix.

## Overloaded By

F

## See Also

### MuPAD Functions

`iztrans::addpattern` | `ztrans` | `ztrans::addpattern`

## Topics

“Z-Transforms” (Symbolic Math Toolbox)

## iztrans::addpattern

Add patterns for the inverse Z transform

### Syntax

```
iztrans::addpattern(pat, z, k, res, <vars, <conds>>)
```

### Description

`iztrans::addpattern(pat, z, k, res)` teaches `iztrans` to return `iztrans(pat, z, k) = res`.

The `iztrans` function uses a set of patterns for computing inverse Z transforms. You can extend the set by adding your own patterns. To add a new pattern to the pattern matcher, use `iztrans::addpattern`. MuPAD does not save custom patterns permanently. The new patterns are available in the *current* MuPAD session only.

Variable names that you use when calling `iztrans::addpattern` can differ from the names that you use when calling `iztrans`. See “Example 2” on page 1-1129 (Symbolic Math Toolbox).

You can include a list of free parameters and a list of conditions on these parameters. These conditions and the result are protected from premature evaluation. This means that you can use `not iszero(a^2 - b)` instead of `hold( _not @ iszero )(a^2 - b)`.

The following conditions treat assumptions on identifiers differently:

- `a^2 - b <> 0` takes into account assumptions on identifiers.
- `not iszero(a^2 - b)` disregards assumptions on identifiers.

See “Example 3” on page 1-1130 (Symbolic Math Toolbox).

## Environment Interactions

Calling `iztrans::addpattern` changes the expressions returned by future calls to `iztrans`.

## Examples

### Example 1

Compute the inverse Z transform of the function `bar`. By default, MuPAD does not have a pattern for this function:

```
iztrans(bar(z), z, k)
```

```
iztrans(bar(z), z, k)
```

Add a pattern for the inverse Z transform of `bar` using `iztrans::addpattern`:

```
iztrans::addpattern(bar(z), z, k, foo(k)):
```

Now `iztrans` returns the inverse Z transform of `bar`:

```
iztrans(bar(z), z, k)
```

```
foo(k)
```

### Example 2

Define the inverse Z transform of `bar(y)` using the variables `x` and `y` as parameters:

```
iztrans::addpattern(bar(y), y, x, foo(x))
```

The `iztrans` function recognizes the added pattern even if you use other variables as parameters:

```
iztrans(bar(z), z, k)
```

```
foo(k)
```

### Example 3

Use assumptions when adding this pattern for the inverse Z transform:

```
iztrans::addpattern(BAR(x*z), z, k, FOO(k/(x - 1/2))*sin(x),  
                    [x], [abs(x) < 1]):  
iztrans(BAR(x*z), z, k) assuming -1 < x < 1
```

$$\text{FOO}\left(\frac{k}{x - \frac{1}{2}}\right) \sin(x)$$

If  $|x| \geq 1$ , you cannot apply this pattern:

```
iztrans(BAR(x*z), z, k) assuming x >= 1
```

$$\text{iztrans}(\text{BAR}(x z), z, k)$$

If MuPAD cannot determine whether the conditions are satisfied, it returns a `piecewise` object:

```
iztrans(BAR(x*z), z, k)
```

$$\left\{ \text{FOO}\left(\frac{k}{x - \frac{1}{2}}\right) \sin(x) \text{ if } |x| < 1 \right.$$

Note that the resulting expression defining the inverse Z transform of  $\text{BAR}(x*z)$  implicitly assumes that the value of  $x$  is not  $1/2$ . A strict definition of the pattern is:

```
ztrans::addpattern(BAR(x*z), z, k, FOO(k/(x - 1/2))*sin(x),  
                  [x], [abs(x) < 1, x <> 1/2]):
```

If either the conditions are not satisfied or substituting the values into the result gives an error, `iztrans` ignores the pattern. For this particular pattern, you can omit specifying the assumption  $x \neq 1/2$ . If  $x = 1/2$ , MuPAD throws an internal “Division by zero.” error and ignores the pattern:

```
iztrans(BAR(z/2), z, k)
```

$$\text{iztrans}\left(\text{BAR}\left(\frac{z}{2}\right), z, k\right)$$

## Parameters

### **pat**

Arithmetical expression (Symbolic Math Toolbox) in the variable `z` representing the pattern to match

### **z**

Identifier on page 7-29 used as a variable in the pattern

### **k**

Identifier on page 7-29 used as a variable in the result

### **res**

Arithmetical expression in the variable `k` representing the pattern for the result of the transformation

### **vars**

List of identifiers on page 7-29 or indexed identifiers on page 1-1017 used as “pattern variables” (placeholders in `pat` and `res`). You can use pattern variables as placeholders for almost arbitrary MuPAD expressions not containing `z` or `k`. You can restrict them by conditions given in the optional parameter `conds`.

### **conds**

List of conditions on the pattern variables

## Return Values

Object of type `DOM_NULL`

## See Also

### **MuPAD Functions**

`iztrans` | `ztrans` | `ztrans::addpattern`

**Topics**

“Use Custom Patterns for Transforms” (Symbolic Math Toolbox)

# **jacobiAM**

Jacobi amplitude function `am`

## **Syntax**

`jacobiAM(u,m)`

## **Description**

`jacobiAM(u,m)` represents the Jacobi amplitude function which is defined as the solution  $\text{am}(u \mid m) := \varphi$  of  $F(\varphi \mid m) = u$ .

The Jacobi amplitude  $\text{am}(u \mid m)$  is defined for complex arguments  $u$  and  $m$ .

Exact results are returned for  $m = 0$ ,  $m = 1$  or  $u = 0$ . In all other cases an unevaluated symbolic call is returned.

A floating-point value is computed if both arguments are numerical and at least one is a floating-point number.

## **Environment Interactions**

When called with floating-point arguments, these functions are sensitive to the environment variable `DIGITS` which determines the numerical working precision.

## **Examples**

### **Example 1**

Most calls with exact arguments are returned evaluated:

```
jacobiAM(PI/3, 1/2)
```

$$\text{am}\left(\frac{\pi}{3} \mid \frac{1}{2}\right)$$

If  $m = 0$ ,  $m = 1$  or  $u = 0$ , an exact result is returned:

`jacobiAM(PI/2, 0)`

$$\frac{\pi}{2}$$

`jacobiAM(2, 1)`

$$2 \arctan(e^2) - \frac{\pi}{2}$$

`jacobiAM(0, 1/2)`

$$0$$

## Parameters

**u**

An arithmetical expression.

**m**

An arithmetical expression specifying the parameter.

## Return Values

Arithmetical expression.



## See Also

**MuPAD Functions**

ellipticF

## **jacobiSN**

Jacobi elliptic function sn

### **Syntax**

`jacobiSN(u,m)`

### **Description**

`jacobiSN(u,m)` represents the Jacobi elliptic function sn.

Let  $u = F(\varphi \mid m)$ . Then the Jacobi elliptic function SN is defined as follows:

$$\text{sn}(u \mid m) = \sin(\varphi)$$

The Jacobi functions are defined for complex values of  $u$  and  $m$ .

The Jacobi functions are meromorphic and doubly periodic with periods  $4K(m)$  and  $4iK'(m)$  with respect to  $u$ .

For  $m = 0$  and  $m = 1$ , the Jacobi functions reduce to trigonometric or constant functions.

If one argument is a floating-point number, and the other one can be converted to a floating-point number, then a floating-point number is returned.

### **Environment Interactions**

When called with floating-point arguments, these functions are sensitive to the environment variable DIGITS which determines the numerical working precision.

## Examples

### Example 1

For most arguments, the Jacobi functions return themselves unevaluated:

```
jacobiSN(2,1/2)
```

$$\operatorname{sn}\left(2 \mid \frac{1}{2}\right)$$

Floating-point numbers are returned if at least one of the arguments is a floating-point number:

```
jacobiSN(1.5,1/2)
```

```
0.9681760157
```

Floating-point evaluation can be enforced by using `float`:

```
float(jacobiSN(1,-1))
```

```
0.9076832214
```

### Example 2

For  $m = 0$  and  $m = 1$ , the result is expressed using a trigonometric function:

```
jacobiSN(u,0)
```

$$\sin(u)$$

```
jacobiSN(u,1)
```

$$\tanh(u)$$

## Parameters

`m`

An arithmetical expression specifying the parameter.

## Return Values

Arithmetical expression.

## See Also

### **MuPAD Functions**

`ellipticCK` | `ellipticF` | `ellipticK` | `jacobiAM` | `jacobiCD` | `jacobiCN` | `jacobiCS`  
| `jacobiDC` | `jacobiDN` | `jacobiDS` | `jacobiNC` | `jacobiND` | `jacobiNS` | `jacobiSC` |  
`jacobiSD`

# **jacobiCN**

Jacobi elliptic function cn

## **Syntax**

`jacobiCN(u,m)`

## **Description**

`jacobiCN(u,m)` represents the Jacobi elliptic function cn.

Let  $u = F(\varphi \mid m)$ . Then the Jacobi elliptic function cn is defined as follows:

$$\text{cn}(u \mid m) = \cos(\varphi)$$

The Jacobi functions are defined for complex values of  $u$  and  $m$ .

The Jacobi functions are meromorphic and doubly periodic with periods  $4K(m)$  and  $4iK'(m)$  with respect to  $u$ .

For  $m = 0$  and  $m = 1$ , the Jacobi functions reduce to trigonometric or constant functions.

If one argument is a floating-point number, and the other one can be converted to a floating-point number, then a floating-point number is returned.

## **Environment Interactions**

When called with floating-point arguments, these functions are sensitive to the environment variable DIGITS which determines the numerical working precision.

## Examples

### Example 1

For most arguments, the Jacobi elliptic functions return themselves unevaluated:

```
jacobiCN(2,1/2)
```

$$\operatorname{cn}\left(2 \mid \frac{1}{2}\right)$$

Floating-point numbers are returned if at least one of the arguments is a floating-point number:

```
jacobiCN(1.5,1/2)
```

```
0.2502702593
```

Floating-point evaluation can be enforced by using `float`:

```
float(jacobiCN(1,-1))
```

```
0.4196560134
```

### Example 2

For  $m = 0$  and  $m = 1$ , the result is expressed using a trigonometric function:

```
jacobiCN(u,0)
```

```
cos(u)
```

```
jacobiCN(u,1)
```

$$\frac{1}{\cosh(u)}$$

## Parameters

**m**

An arithmetical expression specifying the parameter.

## Return Values

Arithmetical expression.

## See Also

### **MuPAD Functions**

ellipticCK | ellipticF | ellipticK | jacobiAM | jacobiCD | jacobiCS | jacobiDC  
| jacobiDN | jacobiDS | jacobiNC | jacobiND | jacobiNS | jacobiSC | jacobiSD |  
jacobiSN

## **jacobiDN**

Jacobi elliptic function dn

### **Syntax**

`jacobiDN(u,m)`

### **Description**

`jacobiDN(u,m)` represents the Jacobi elliptic function dn.

Let  $u = F(\varphi \mid m)$ . Then the Jacobi elliptic function dn is defined as follows:

$$\text{dn}(u \mid m) = \sqrt{1 - m \sin(\varphi)^2}$$

The Jacobi functions are defined for complex values of  $u$  and  $m$ .

The Jacobi functions are meromorphic and doubly periodic with periods  $4K(m)$  and  $4iK'(m)$  with respect to  $u$ .

For  $m = 0$  and  $m = 1$ , the Jacobi functions reduce to trigonometric or constant functions.

If one argument is a floating-point number, and the other one can be converted to a floating-point number, then a floating-point number is returned.

### **Environment Interactions**

When called with floating-point arguments, these functions are sensitive to the environment variable DIGITS which determines the numerical working precision.



## Examples

### Example 1

For most arguments, the Jacobi functions return themselves unevaluated:

```
jacobiDN(2, 1/2)
```

$$\operatorname{dn}\left(2 \mid \frac{1}{2}\right)$$

Floating-point numbers are returned if at least one of the arguments is a floating-point number:

```
jacobiDN(1.5, 1/2)
```

```
0.7289153595
```

Floating-point evaluation can be enforced by using `float`:

```
float(jacobiDN(1, -1))
```

```
1.350514284
```

### Example 2

For  $m = 0$ , the result is a constant:

```
jacobiDN(u, 0)
```

```
1
```

For  $m = 1$ , the result is expressed using a trigonometric function:

```
jacobiDN(u, 1)
```

$$\frac{1}{\cosh(u)}$$

## Parameters

`m`

An arithmetical expression specifying the parameter.

## Return Values

Arithmetical expression.

## See Also

### **MuPAD Functions**

`ellipticCK` | `ellipticF` | `ellipticK` | `jacobiAM` | `jacobiCD` | `jacobiCN` | `jacobiCS`  
| `jacobiDC` | `jacobiDS` | `jacobiNC` | `jacobiND` | `jacobiNS` | `jacobiSC` | `jacobiSD` |  
`jacobiSN`

# **jacobiCD**

Jacobi elliptic function cd

## **Syntax**

`jacobiCD(u,m)`

## **Description**

`jacobiCD(u,m)` represents the Jacobi elliptic function cd.

Let  $u = F(\varphi | m)$ . Then the Jacobi elliptic function cd is defined as follows:

$$\text{cd}(u | m) = \frac{\text{cn}(u | m)}{\text{dn}(u | m)}$$

The Jacobi functions are defined for complex values of  $u$  and  $m$ .

The Jacobi functions are meromorphic and doubly periodic with periods  $4K(m)$  and  $4iK'(m)$  with respect to  $u$ .

For  $m = 0$  and  $m = 1$ , the Jacobi functions reduce to trigonometric or constant functions.

If one argument is a floating-point number, and the other one can be converted to a floating-point number, then a floating-point number is returned.

## **Environment Interactions**

When called with floating-point arguments, these functions are sensitive to the environment variable DIGITS which determines the numerical working precision.

## Examples

### Example 1

For most arguments, the Jacobi functions return themselves unevaluated:

```
jacobiCD(2,1/2)
```

$$\text{cd}\left(2 \mid \frac{1}{2}\right)$$

Floating-point numbers are returned if at least one of the arguments is a floating-point number:

```
jacobiCD(1.5,1/2)
```

```
0.3433461183
```

Floating-point evaluation can be enforced by using `float`:

```
float(jacobiCD(1,-1))
```

```
0.3107379303
```

### Example 2

For  $m = 0$ , the result is expressed using a trigonometric function:

```
jacobiCD(u,0)
```

$$\cos(u)$$

For  $m = 1$ , the result is a constant:

```
jacobiCD(u,1)
```

```
1
```

## Parameters

**m**

An arithmetical expression specifying the parameter.

## Return Values

Arithmetical expression.

## See Also

### **MuPAD Functions**

ellipticCK | ellipticF | ellipticK | jacobiAM | jacobiCN | jacobiCS | jacobiDC  
| jacobiDN | jacobiDS | jacobiNC | jacobiND | jacobiNS | jacobiSC | jacobiSD |  
jacobiSN

## jacobiSD

Jacobi elliptic function sd

### Syntax

`jacobiSD(u,m)`

### Description

`jacobiSD(u,m)` represents the Jacobi elliptic function sd.

Let  $u = F(\varphi \mid m)$ . Then the Jacobi function SD is defined as follows:

$$\text{sd}(u \mid m) = \frac{\text{sn}(u \mid m)}{\text{dn}(u \mid m)}$$

The Jacobi functions are defined for complex values of  $u$  and  $m$ .

The Jacobi functions are meromorphic and doubly periodic with periods  $4K(m)$  and  $4iK'(m)$  with respect to  $u$ .

For  $m = 0$  and  $m = 1$ , the Jacobi functions reduce to trigonometric or constant functions.

If one argument is a floating-point number, and the other one can be converted to a floating-point number, then a floating-point number is returned.

### Environment Interactions

When called with floating-point arguments, these functions are sensitive to the environment variable DIGITS which determines the numerical working precision.

## Examples

### Example 1

For most arguments, the Jacobi functions return themselves unevaluated:

```
jacobiSD(2,1/2)
```

$$\text{sd}\left(2 \mid \frac{1}{2}\right)$$

Floating-point numbers are returned if at least one of the arguments is a floating-point number:

```
jacobiSD(1.5,1/2)
```

1.328242028

Floating-point evaluation can be enforced by using `float`:

```
float(jacobiSD(1,-1))
```

0.672101904

### Example 2

For  $m = 0$  and  $m = 1$ , the result is expressed using a trigonometric function:

```
jacobiSD(u,0)
```

$\sin(u)$

```
jacobiSD(u,1)
```

$\sinh(u)$

## Parameters

`m`

An arithmetical expression specifying the parameter.

## Return Values

Arithmetical expression.

## See Also

### **MuPAD Functions**

`ellipticCK` | `ellipticF` | `ellipticK` | `jacobiAM` | `jacobiCD` | `jacobiCN` | `jacobiCS`  
| `jacobiDC` | `jacobiDN` | `jacobiDS` | `jacobiNC` | `jacobiND` | `jacobiNS` | `jacobiSC` |  
`jacobiSN`



# **jacobiND**

Jacobi elliptic function nd

## **Syntax**

`jacobiND(u,m)`

## **Description**

`jacobiND(u,m)` represents the Jacobi elliptic function nd.

Let  $u = F(\varphi \mid m)$ . Then the Jacobi elliptic function nd is defined as follows:

$$\text{nd}(u \mid m) = \frac{1}{\text{dn}(u \mid m)}$$

The Jacobi functions are defined for complex values of  $u$  and  $m$ .

The Jacobi functions are meromorphic and doubly periodic with periods  $4K(m)$  and  $4iK'(m)$  with respect to  $u$ .

For  $m = 0$  and  $m = 1$ , the Jacobi functions reduce to trigonometric or constant functions.

If one argument is a floating-point number, and the other one can be converted to a floating-point number, then a floating-point number is returned.

## **Environment Interactions**

When called with floating-point arguments, these functions are sensitive to the environment variable DIGITS which determines the numerical working precision.

## Examples

### Example 1

For most arguments, the Jacobi functions return themselves unevaluated:

```
jacobiND(2,1/2)
```

$\text{nd}\left(2 \mid \frac{1}{2}\right)$

Floating-point numbers are returned if at least one of the arguments is a floating-point number:

```
jacobiND(1.5,1/2)
```

1.371901397

Floating-point evaluation can be enforced by using `float`:

```
float(jacobiND(1,-1))
```

0.7404586624

### Example 2

For  $m = 0$ , the result is a constant:

```
jacobiND(u,0)
```

1

For  $m = 1$ , the result is expressed using a trigonometric function:

```
jacobiND(u,1)
```

$\cosh(u)$

## Parameters

**m**

An arithmetical expression specifying the parameter.

## Return Values

Arithmetical expression.

## See Also

### **MuPAD Functions**

ellipticCK | ellipticF | ellipticK | jacobiAM | jacobiCD | jacobiCN | jacobiCS  
| jacobiDC | jacobiDN | jacobiDS | jacobiNC | jacobiNS | jacobiSC | jacobiSD |  
jacobiSN

## jacobiDC

Jacobi elliptic function dc

### Syntax

`jacobiDC(u,m)`

### Description

`jacobiDC(u,m)` represents the Jacobi elliptic function dc.

Let  $u = F(\varphi \mid m)$ . Then the Jacobi elliptic function dc is defined as follows:

$$\text{dc}(u \mid m) = \frac{\text{dn}(u \mid m)}{\text{cn}(u \mid m)}$$

The Jacobi functions are defined for complex values of  $u$  and  $m$ .

The Jacobi functions are meromorphic and doubly periodic with periods  $4K(m)$  and  $4iK'(m)$  with respect to  $u$ .

For  $m = 0$  and  $m = 1$ , the Jacobi functions reduce to trigonometric or constant functions.

If one argument is a floating-point number, and the other one can be converted to a floating-point number, then a floating-point number is returned.

### Environment Interactions

When called with floating-point arguments, these functions are sensitive to the environment variable DIGITS which determines the numerical working precision.

## Examples

### Example 1

For most arguments, the Jacobi functions return themselves unevaluated:

```
jacobiDC(2,1/2)
```

$$\text{dc}\left(2 \mid \frac{1}{2}\right)$$

Floating-point numbers are returned if at least one of the arguments is a floating-point number:

```
jacobiDC(1.5,1/2)
```

2.912512904

Floating-point evaluation can be enforced by using `float`:

```
float(jacobiDC(1,-1))
```

3.218145911

### Example 2

For  $m = 0$ , the result is expressed using a trigonometric function:

```
jacobiDC(u,0)
```

$$\frac{1}{\cos(u)}$$

For  $m = 1$ , the result is a constant:

```
jacobiDC(u,1)
```

1

## Parameters

`m`

An arithmetical expression specifying the parameter.

## Return Values

Arithmetical expression.

## See Also

### **MuPAD Functions**

`ellipticCK` | `ellipticF` | `ellipticK` | `jacobiAM` | `jacobiCD` | `jacobiCN` | `jacobiCS`  
| `jacobiDN` | `jacobiDS` | `jacobiNC` | `jacobiND` | `jacobiNS` | `jacobiSC` | `jacobiSD` |  
`jacobiSN`

# **jacobiNC**

Jacobi elliptic function nc

## **Syntax**

`jacobiNC(u,m)`

## **Description**

`jacobiNC(u,m)` represents the Jacobi elliptic function nc.

Let  $u = F(\varphi \mid m)$ . Then the Jacobi elliptic function nc is defined as follows:

$$\text{nc}(u \mid m) = \frac{1}{\text{cn}(u \mid m)}$$

The Jacobi functions are defined for complex values of  $u$  and  $m$ .

The Jacobi functions are meromorphic and doubly periodic with periods  $4K(m)$  and  $4iK'(m)$  with respect to  $u$ .

For  $m = 0$  and  $m = 1$ , the Jacobi functions reduce to trigonometric or constant functions.

If one argument is a floating-point number, and the other one can be converted to a floating-point number, then a floating-point number is returned.

## **Environment Interactions**

When called with floating-point arguments, these functions are sensitive to the environment variable DIGITS which determines the numerical working precision.

## Examples

### Example 1

For most arguments, the Jacobi functions return themselves unevaluated:

```
jacobiNC(2,1/2)
```

$$\text{nc}\left(2 \mid \frac{1}{2}\right)$$

Floating-point numbers are returned if at least one of the arguments is a floating-point number:

```
jacobiNC(1.5,1/2)
```

```
3.995680521
```

Floating-point evaluation can be enforced by using `float`:

```
float(jacobiNC(1,-1))
```

```
2.382904017
```

### Example 2

For  $m = 0$  and  $m = 1$ , the result is expressed using a trigonometric function:

```
jacobiNC(u,0)
```

$$\frac{1}{\cos(u)}$$

```
jacobiNC(u,1)
```

$$\cosh(u)$$



## Parameters

**m**

An arithmetical expression specifying the parameter.

## Return Values

Arithmetical expression.

## See Also

### **MuPAD Functions**

ellipticCK | ellipticF | ellipticK | jacobiAM | jacobiCD | jacobiCN | jacobiCS  
| jacobiDC | jacobiDN | jacobiDS | jacobiND | jacobiNS | jacobiSC | jacobiSD |  
jacobiSN

# **jacobiSC**

Jacobi elliptic function `sc`

## **Syntax**

`jacobiSC(u,m)`

## **Description**

`jacobiSC(u,m)` represents the Jacobi elliptic function `sc`.

Let  $u = F(\varphi \mid m)$ . Then the Jacobi elliptic function `sc` is defined as follows:

$$\text{sc}(u \mid m) = \frac{\text{sn}(u \mid m)}{\text{cn}(u \mid m)}$$

The Jacobi functions are defined for complex values of  $u$  and  $m$ .

The Jacobi functions are meromorphic and doubly periodic with periods  $4K(m)$  and  $4iK'(m)$  with respect to  $u$ .

For  $m = 0$  and  $m = 1$ , the Jacobi functions reduce to trigonometric or constant functions.

If one argument is a floating-point number, and the other one can be converted to a floating-point number, then a floating-point number is returned.

## **Environment Interactions**

When called with floating-point arguments, these functions are sensitive to the environment variable `DIGITS` which determines the numerical working precision.

## Examples

### Example 1

For most arguments, the Jacobi functions return themselves unevaluated:

```
jacobiSC(2,1/2)
```

$\text{sc}\left(2 \mid \frac{1}{2}\right)$

Floating-point numbers are returned if at least one of the arguments is a floating-point number:

```
jacobiSC(1.5,1/2)
```

3.868522047

Floating-point evaluation can be enforced by using `float`:

```
float(jacobiSC(1,-1))
```

2.162921994

### Example 2

For  $m = 0$  and  $m = 1$ , the result is expressed using a trigonometric function:

```
jacobiSC(u,0)
```

$\tan(u)$

```
jacobiSC(u,1)
```

$\sinh(u)$

## Parameters

`m`

An arithmetical expression specifying the parameter.

## Return Values

Arithmetical expression.

## See Also

### **MuPAD Functions**

`ellipticCK` | `ellipticF` | `ellipticK` | `jacobiAM` | `jacobiCD` | `jacobiCN` | `jacobiCS`  
| `jacobiDC` | `jacobiDN` | `jacobiDS` | `jacobiNC` | `jacobiND` | `jacobiNS` | `jacobiSD` |  
`jacobiSN`

# **jacobiNS**

Jacobi elliptic function ns

## **Syntax**

`jacobiNS(u,m)`

## **Description**

`jacobiNS(u,m)` represents the Jacobi elliptic function ns.

Let  $u = F(\varphi \mid m)$ . Then the Jacobi elliptic function ns is defined as follows:

$$\text{ns}(u \mid m) = \frac{1}{\text{sn}(u \mid m)}$$

The Jacobi functions are defined for complex values of  $u$  and  $m$ .

The Jacobi functions are meromorphic and doubly periodic with periods  $4K(m)$  and  $4iK'(m)$  with respect to  $u$ .

For  $m = 0$  and  $m = 1$ , the Jacobi functions reduce to trigonometric or constant functions.

If one argument is a floating-point number, and the other one can be converted to a floating-point number, then a floating-point number is returned.

## **Environment Interactions**

When called with floating-point arguments, these functions are sensitive to the environment variable DIGITS which determines the numerical working precision.

## Examples

### Example 1

For most arguments, the Jacobi functions return themselves unevaluated:

```
jacobiNS(2,1/2)
```

$$\text{ns}\left(2 \mid \frac{1}{2}\right)$$

Floating-point numbers are returned if at least one of the arguments is a floating-point number:

```
jacobiNS(1.5,1/2)
```

```
1.03287004
```

Floating-point evaluation can be enforced by using `float`:

```
float(jacobiNS(1,-1))
```

```
1.101705944
```

### Example 2

For  $m = 0$  and  $m = 1$ , the result is expressed using a trigonometric function:

```
jacobiNS(u,0)
```

$$\frac{1}{\sin(u)}$$

```
jacobiNS(u,1)
```

```
coth(u)
```

## Parameters

**m**

An arithmetical expression specifying the parameter.

## Return Values

Arithmetical expression.

## See Also

### **MuPAD Functions**

ellipticCK | ellipticF | ellipticK | jacobiAM | jacobiCD | jacobiCN | jacobiCS  
| jacobiDC | jacobiDN | jacobiDS | jacobiNC | jacobiND | jacobiSC | jacobiSD |  
jacobiSN

## jacobiDS

Jacobi elliptic function ds

### Syntax

`jacobiDS(u, m)`

### Description

`jacobiDS(u, m)` represents the Jacobi elliptic function ds.

Let  $u = F(\varphi \mid m)$ . Then the Jacobi elliptic function ds is defined as follows:

$$\text{ds}(u \mid m) = \frac{\text{dn}(u \mid m)}{\text{sn}(u \mid m)}$$

The Jacobi functions are defined for complex values of  $u$  and  $m$ .

The Jacobi functions are meromorphic and doubly periodic with periods  $4K(m)$  and  $4iK'(m)$  with respect to  $u$ .

For  $m = 0$  and  $m = 1$ , the Jacobi functions reduce to trigonometric or constant functions.

If one argument is a floating-point number, and the other one can be converted to a floating-point number, then a floating-point number is returned.

### Environment Interactions

When called with floating-point arguments, these functions are sensitive to the environment variable DIGITS which determines the numerical working precision.



## Examples

### Example 1

For most arguments, the Jacobi functions return themselves unevaluated:

```
jacobiDS(2,1/2)
```

$$ds\left(2 \mid \frac{1}{2}\right)$$

Floating-point numbers are returned if at least one of the arguments is a floating-point number:

```
jacobiDS(1.5,1/2)
```

```
0.7528748365
```

Floating-point evaluation can be enforced by using `float`:

```
float(jacobiDS(1,-1))
```

```
1.487869613
```

### Example 2

For  $m = 0$  and  $m = 1$ , the result is expressed using a trigonometric function:

```
jacobiDS(u,0)
```

$$\frac{1}{\sin(u)}$$

```
jacobiDS(u,1)
```

$$\frac{1}{\sinh(u)}$$

## Parameters

**m**

An arithmetical expression specifying the parameter.

## Return Values

Arithmetical expression.

## See Also

### **MuPAD Functions**

ellipticCK | ellipticF | ellipticK | jacobiAM | jacobiCD | jacobiCN | jacobiCS  
| jacobiDC | jacobiDN | jacobiNC | jacobiND | jacobiNS | jacobiSC | jacobiSD |  
jacobiSN

# **jacobiCS**

Jacobi elliptic function cs

## **Syntax**

`jacobiCS(u,m)`

## **Description**

`jacobiCS(u,m)` represents the Jacobi elliptic function cs.

Let  $u = F(\varphi \mid m)$ . Then the Jacobi elliptic function cs is defined as follows:

$$\text{cs}(u \mid m) = \frac{\text{cn}(u \mid m)}{\text{sn}(u \mid m)}$$

The Jacobi functions are defined for complex values of  $u$  and  $m$ .

The Jacobi functions are meromorphic and doubly periodic with periods  $4K(m)$  and  $4iK'(m)$  with respect to  $u$ .

For  $m = 0$  and  $m = 1$ , the Jacobi functions reduce to trigonometric or constant functions.

If one argument is a floating-point number, and the other one can be converted to a floating-point number, then a floating-point number is returned.

## **Environment Interactions**

When called with floating-point arguments, these functions are sensitive to the environment variable DIGITS which determines the numerical working precision.

## Examples

### Example 1

For most arguments, the Jacobi functions return themselves unevaluated:

```
jacobiCS(2,1/2)
```

$$\text{cs}\left(2 \mid \frac{1}{2}\right)$$

Floating-point numbers are returned if at least one of the arguments is a floating-point number:

```
jacobiCS(1.5,1/2)
```

```
0.2584966527
```

Floating-point evaluation can be enforced by using `float`:

```
float(jacobiCS(1,-1))
```

```
0.4623375243
```

### Example 2

For  $m = 0$  and  $m = 1$ , the result is expressed using a trigonometric function:

```
jacobiCS(u,0)
```

```
cot(u)
```

```
jacobiCS(u,1)
```

$$\frac{1}{\sinh(u)}$$

## Parameters

**m**

An arithmetical expression specifying the parameter.

## Return Values

Arithmetical expression.

## See Also

### **MuPAD Functions**

`ellipticCK` | `ellipticF` | `ellipticK` | `jacobiAM` | `jacobiCD` | `jacobiCN` | `jacobiDC`  
| `jacobiDN` | `jacobiDS` | `jacobiNC` | `jacobiND` | `jacobiNS` | `jacobiSC` | `jacobiSD` |  
`jacobiSN`

# jacobian

Jacobian matrix of a vector function

## Syntax

`jacobian(v, x)`

## Description

`jacobian(v, x)` computes the Jacobian matrix of the vector function  $\vec{v}$  with respect to  $\vec{x}$ .

If  $v$  is a vector then the component ring of  $v$  must be a field (i.e., a domain of category `Cat::Field`) for which differentiation with respect to  $x$  is defined.

If  $v$  is given as a list of arithmetical expressions, then `jacobian` returns a matrix with the standard component ring `Dom::ExpressionField()`.

## Examples

### Example 1

The Jacobian matrix of the vector function  $\vec{v} = \begin{pmatrix} x^3 \\ xz \\ y+z \end{pmatrix}$  is:

`delete x, y, z:`

`jacobian([x^3, x*z, y+z], [x, y, z])`

$$\begin{pmatrix} 3x^2 & 0 & 0 \\ z & 0 & x \\ 0 & 1 & 1 \end{pmatrix}$$

## Parameters

**v**

A list of arithmetical expressions, or a vector (i.e., an  $n \times 1$  or  $1 \times n$  matrix of a domain of category `Cat::Matrix`)

**x**

A list of (indexed) identifiers

## Return Values

Matrix of the domain `Dom::Matrix(R)`, where  $R$  is the component ring of  $v$  or the domain `Dom::ExpressionField()`.

## Algorithms

For a vector function  $\vec{v}: G \rightarrow R^m$ , where  $G$  is a subset of  $\mathbb{R}^n$  the matrix

$$H_f(\vec{x}) = \begin{pmatrix} \frac{\partial}{\partial x_1} v_1 & \frac{\partial}{\partial x_2} v_1 & \dots & \frac{\partial}{\partial x_n} v_1 \\ \frac{\partial}{\partial x_1} v_2 & \frac{\partial}{\partial x_2} v_2 & \dots & \frac{\partial}{\partial x_n} v_2 \\ \vdots & \vdots & \ddots & \vdots \\ \frac{\partial}{\partial x_1} v_m & \frac{\partial}{\partial x_2} v_m & \dots & \frac{\partial}{\partial x_n} v_m \end{pmatrix}$$

is the *Jacobian matrix* of  $\vec{v}$ .

## See Also

**MuPAD Functions**  
gradient | hessian



# **jacobiZeta**

Jacobi Zeta function

## **Syntax**

`jacobiZeta(u, m)`

## **Description**

`jacobiZeta(u, m)` represents the Jacobi Zeta function  $Z(u \mid m)$  which is defined as

$$Z(u \mid m) = \frac{2 \pi}{K(m)} \left( \sum_{s=1}^{\infty} \frac{q(m)^s}{1 - q(m)^{2s}} \sin\left(\frac{2 \pi}{K(m)} s u\right) \right)$$

The Jacobi Zeta function  $Z(u \mid m)$  is defined for complex arguments  $u$  and  $m$ .

Exact results are returned for  $m = 0$ ,  $m = 1$  or  $u = 0$ . In all other cases an unevaluated symbolic call is returned.

A floating-point value is computed if both arguments are numerical and at least one is a floating-point number.

## **Environment Interactions**

When called with floating-point arguments, these functions are sensitive to the environment variable DIGITS which determines the numerical working precision.

## Examples

### Example 1

Most calls with exact arguments are returned unevaluated:

```
jacobiZeta(2, -1)
```

$Z(2 \mid -1)$

If  $m = 0$ ,  $m = 1$  or  $u = 0$ , an exact result is returned:

```
jacobiZeta(0, 3)
```

0

```
jacobiZeta(1, 0)
```

0

```
jacobiZeta(2, 1)
```

$\tanh(2)$

## Parameters

**u**

An arithmetical expression.

**m**

An arithmetical expression specifying the parameter.

## **Return Values**

Arithmetical expression.

# kroneckerDelta

Kronecker's delta symbol

## Syntax

`kroneckerDelta(m, <n>)`

## Description

`kroneckerDelta(m, n)` is Kronecker's delta symbol. It represents 1 if  $m = n$  and 0 if  $m \neq n$ .

`kroneckerDelta(m)` represents 1 if  $m = 0$  and 0 if  $m \neq 0$ .

The calls `kroneckerDelta(m, n)` and `kroneckerDelta(m - n)` are equivalent.

`kroneckerDelta(m, n)` yields 1 if the arguments  $m, n$  coincide.

It yields 0 if  $m - n$  yields a non-zero numerical value.

If either  $m$  or  $n$  contain symbolic objects and  $m - n$  does not yield a numerical value, then the symbolic call `kroneckerDelta(m, n)` or the equivalent call `kroneckerDelta(n, m)` is returned.

Floating point numbers such as 1.0, 2.0 etc. are treated like integers.

Note that `kroneckerDelta(m, n) = kroneckerDelta(n, m)` for arbitrary arguments  $m, n$ . In symbolic return values, the ordering of the input arguments may be exchanged.

`kroneckerDelta` is used and processed by `sum` and `ztrans, iztrans`.

## Examples

### Example 1

kroneckerDelta returns 1 or 0, respectively, for arguments that definitely coincide or do not coincide:

```
kroneckerDelta(2, 2), kroneckerDelta(n, n),
kroneckerDelta(2, 3), kroneckerDelta(n - 1, n + 1)
```

1, 1, 0, 0

A symbolic call is returned if the system cannot decide whether the arguments coincide:

```
kroneckerDelta(m, n), kroneckerDelta(m, 3), kroneckerDelta(3, n)
```

$\delta_{m-n,0}, \delta_{m-3,0}, \delta_{n-3,0}$

### Example 2

kroneckerDelta is processed by sum:

```
sum(a[n]*kroneckerDelta(n, 3), n = 0..infinity)
```

$a_3$

```
sum(a[n]*kroneckerDelta(n, m), n = 0..infinity)
```

$$\begin{cases} a_m & \text{if } 0 \leq m \wedge m \in \mathbb{Z} \\ 0 & \text{if } m \leq -1 \vee m \notin \mathbb{Z} \end{cases}$$

iztrans may produce terms involving kroneckerDelta:

```
iztrans(1/(z - 1), z, n)
```

$1 - \delta_{n,0}$

`ztrans(% , n, z)`

$$\frac{z}{z-1} - 1$$

## Parameters

`m`, `n`

arithmetical expressions. (Symbolic Math Toolbox) The default value for `n` is 0.

## Return Values

Arithmetical expression.

## Overloaded By

`m`, `n`

## See Also

### MuPAD Functions

`iztrans` | `sum` | `ztrans`

# kummerU

Confluent hypergeometric KummerU function

## Syntax

kummerU(a, b, z)

## Description

kummerU(a, b, z) represents the KummerU function  $U(a, b, z)$ , whose integral representation is given by

$$\frac{1}{\Gamma(a)} \int_0^{\infty} e^{-zt} t^{a-1} (1+t)^{b-a-1} dt$$

for  $\Re(a) > 0$  and  $\Re(z) > 0$ .

kummerU is defined for complex arguments  $a$ ,  $b$ , and  $z$ .

For most parameter values, an unevaluated function call is returned. Cf. “Example 1” on page 1-1182 (Symbolic Math Toolbox).

Explicit symbolic expressions are returned for some particular values of the parameters:

- If  $b = 2a$ , the `besselK` function may appear.
- If  $a$  is a negative integer, the result is a polynomial.
- If  $a = 1$  or  $b = a$ , the `igamma` function may appear.

Cf. “Example 2” on page 1-1182 (Symbolic Math Toolbox).

## Environment Interactions

When called with floating-point arguments, this function is sensitive to the environment variable DIGITS which determines the numerical working precision.

## Examples

### Example 1

Unevaluated calls are returned for exact or symbolic arguments:

`kummerU(a, b, x), kummerU(1/2, -1, 0)`

$$\text{kummerU}(a, b, x), \text{kummerU}\left(\frac{1}{2}, -1, 0\right)$$

Floating point values are returned for floating-point arguments:

`kummerU(1/3, 2.0, -50), kummerU(1/2, -1, 0.0)`

$$0.1351149381 - 0.2340259377 i, 0.7522527781$$

### Example 2

Explicit expressions are returned for some specific values of the parameters:

`kummerU(1/2, 1, x), kummerU(-2, b, x),  
kummerU(1, 1/3, x), kummerU(a, a, x)`

$$\frac{e^{\frac{x}{2}} K_0\left(\frac{x}{2}\right)}{\sqrt{\pi}}, b - 2 x (b + 1) + b^2 + x^2, x^{2/3} e^x \left( \frac{3 e^{-x}}{2 x^{2/3}} - \frac{3 \Gamma\left(\frac{1}{3}, x\right)}{2} \right), e^x \Gamma(1 - a, x)$$



### Example 3

The functions `diff`, `float`, `limit`, and `series` handle expressions involving the `kummerU` function

```
diff(kummerU(a, b, z), z), float(kummerU(1/2, -1, 0))
```

$$\frac{a \operatorname{kummerU}(a+1, b, z) (a-b+1)}{z} - \frac{a \operatorname{kummerU}(a, b, z)}{z}, 0.7522527781$$

```
limit(kummerU(1/2, -1, x), x),
series(kummerU(1/2, -1, x), x = infinity, 3)
```

$$\frac{4}{3\sqrt{\pi}}, \frac{1}{\sqrt{x}} - \frac{5}{4x^{3/2}} + \frac{105}{32x^{5/2}} + O\left(\frac{1}{x^{7/2}}\right)$$

## Parameters

**a, b, z**

arithmetical expressions (Symbolic Math Toolbox)

## Return Values

Arithmetical expression.

## Overloaded By

z

## Algorithms

$U(a, b, z)$  satisfies Kummer's differential equation:

$$z \frac{\partial^2}{\partial z^2} y + (b - z) \frac{\partial}{\partial z} y - a y = 0$$

for which the hypergeometric function on page 1-944  ${}_1F_1(a, b, z)$  is another solution.

$U(a, b, z)$  is related to the whittakerW function  $W_{a,b}(z)$  by the formula:

$$W_{a,b}(z) = e^{-\frac{z}{2}} z^{\frac{1}{2}+b} U\left(\frac{1}{2} + b - a, 1 + 2b, z\right)$$

## See Also

### MuPAD Functions

hypergeom | whittakerM | whittakerW

# laguerreL

Laguerre polynomials and L function

## Syntax

laguerreL(*n*, *x*)

laguerreL(*n*, *a*, *x*)

## Description

laguerreL(*n*, *a*, *x*) represents Laguerre's L function. When *n* is a nonnegative integer, this is the classical Laguerre polynomial of degree *n*.

Laguerre's L function is defined in terms of hypergeometric functions on page 1-944 by

$$\text{laguerreL}(n, a, x) = \binom{n+a}{a} {}_1F_1(-n; a+1; x)$$

For nonnegative integer values of *n*, the function returns the classical (generalized) polynomials that are orthogonal with respect to the scalar product

$\langle f1, f2 \rangle = \int_0^\infty e^{-x} x^a f1(x) f2(x) dx$ . In particular:

$$\langle \text{laguerreL}(n, a, x), \text{laguerreL}(m, a, x) \rangle = \begin{cases} 0 & \text{if } n \neq m \\ \frac{\Gamma(a+n+1)}{n!} & \text{if } n = m \end{cases}$$

The Laguerre's L function is not well defined for all values of the parameters *n* and *a*, because certain restrictions on the parameters exist in the definition of the hypergeometric functions on page 1-944. If the Laguerre's L function is not defined for a particular pair *n* and *a*, the call laguerreL(*n*, *a*, *x*) returns 0 or issues an error message.

The calls laguerre(*n*, *x*) and laguerre(*n*, 0, *x*) are equivalent.

If  $n$  is a nonnegative integer, the function `laguerreL` returns the explicit form of the corresponding Laguerre polynomial. The special values  $\text{laguerreL}(n, a, 0) = \binom{n+a}{a}$  are implemented for arbitrary values of  $n$  and  $a$ . If  $n$  is a negative integer and  $a$  is a numerical noninteger value satisfying  $a \geq -n$ , then the function `laguerreL` returns 0. If  $n$  is a negative integer and  $a$  is an integer satisfying  $a < -n$ , then the function returns an explicit expression defined by the reflection rule

$$\text{laguerreL}(n, a, x) = (-1)^a e^x \text{laguerreL}(-n-a-1, a, -x)$$

If all arguments are numerical and at least one of the arguments is a floating-point number, then `laguerreL(x)` returns a floating-point number. For all other arguments, `laguerreL(n, a, x)` returns a symbolic function call.

## Environment Interactions

When called with floating-point arguments, the function is sensitive to the environment variable `DIGITS`, which determines the numerical working precision.

## Examples

### Example 1

You can call the `laguerreL` function with exact and symbolic arguments:

```
laguerreL(2, a, x), laguerreL(-2, -2, PI)
```

$$\frac{3a}{2} - x(a+2) + \frac{a^2}{2} + \frac{x^2}{2} + 1, e^x \left( \frac{\pi^2}{2} + \frac{\pi^3}{6} \right)$$

If the first argument is a nonnegative integer, the function returns a polynomial:

```
laguerreL(3, x)
```

$$-\frac{x^3}{6} + \frac{3x^2}{2} - 3x + 1$$

laguerreL(3, a, x)

$$\frac{11a}{6} - x \left( \frac{a^2}{2} + \frac{5a}{2} + 3 \right) + x^2 \left( \frac{a}{2} + \frac{3}{2} \right) + a^2 + \frac{a^3}{6} - \frac{x^3}{6} + 1$$

Floating-point values are computed for floating-point arguments:

laguerreL(2, 3, 4.0), laguerreL(5.0, sqrt(2), PI)

-2.0, 1.851157209

laguerreL(1 + I, 1.0), laguerreL(-2.0, exp(I))

-0.2457246594 - 0.6867435489 i, 0.6848682701 + 2.933911244 i

## Example 2

The Laguerre function is not defined for all parameter values:

laguerreL(-5/2, -3/2, x)

Error: Function 'laguerreL' not supported for parameter values '-5/2' and '-3/2'. [lag

## Example 3

System functions such as diff, float, limit, and series handle expressions involving laguerreL:

diff(laguerreL(n, a, x), x, x, x), float(laguerreL(2, 3, sqrt(PI)))

-laguerreL(n - 3, a + 3, x), 2.708527072

limit(laguerreL(3, 4, x^2/(1+x)), x = infinity)

-∞

limit(laguerreL(4, 3, x^2/(1+x)), x = infinity)

$\infty$ 

```
series(laguerreL(n, a, x), x = 0, 3)
```

$$\binom{a+n}{n} - \frac{n x \binom{a+n}{n}}{a+1} + \frac{n x^2 (n-1) \binom{a+n}{n}}{2 (a+1) (a+2)} + O(x^3)$$

```
series(laguerreL(3/2, x), x = infinity, 3)
```

$$\frac{3 e^x}{4 x^{5/2} \sqrt{\pi}} + \frac{75 e^x}{16 x^{7/2} \sqrt{\pi}} + \frac{3675 e^x}{128 x^{9/2} \sqrt{\pi}} + O\left(\frac{e^x}{x^{11/2}}\right)$$

## Parameters

**n, a, x**

arithmetical expressions (Symbolic Math Toolbox)

## Return Values

Arithmetical expression.

## Overloaded By

x

## See Also

### MuPAD Functions

hypergeom | orthpoly::laguerre

# LambertW

The Lambert function

## Syntax

`lambertW(x)`

`lambertW(k, x)`

## Description

For integer  $k$ , the values  $y = W_k(x)$  represent the solutions of the equation  $y e^y = x$ .

`lambertW` is the inverse function of  $y \rightarrow y e^y$ .

In the complex plane, the equation  $y e^y = x$  has a countably infinite number of solutions. They are represented by `lambertW(k, x)` with  $k$  ranging over the integers.

For all real  $x \geq 0$ , the equation  $y e^y = x$  has exactly one real solution. It is represented by `y=lambertW(x)` or, equivalently, `y=lambertW(0, x)`.

For all real  $x$  in the range  $-\exp(-1) < x < 0$ , there are exactly two real solutions. The larger one is represented by `y=lambertW(x)`, the smaller one by `y=lambertW(-1, x)`.

Exactly one real solution `lambertW(0, -exp(-1))= lambertW(-1, -exp(-1))= -1` exists for  $x = -e^{-1}$ .

For  $k \notin \{0, -1\}$ , `lambertW(k, x)` takes no real value.

The values `lambertW(-1, 0)=- infinity` and `lambertW(0, 0)=0` are implemented.

Further, the result  $y$  is returned for some exact arguments of the form  $x = y e^y$ . For floating-point arguments a floating-point value is returned. For all other arguments, unevaluated function calls are returned.

The `float` attributes are kernel functions, i.e., floating-point evaluation is fast.

## Environment Interactions

When called with a floating-point argument, the function is sensitive to the environment variable DIGITS which determines the numerical working precision.

## Examples

### Example 1

We demonstrate some calls with exact and symbolic input data:

```
lambertW(-3), lambertW(-1, -5/2), lambertW(1/2),  
lambertW(5, I), lambertW(3, 1 + I), lambertW(-1, x + 1)
```

$$W_0(-3), W_{-1}\left(-\frac{5}{2}\right), W_0\left(\frac{1}{2}\right), W_5(i), W_3(1+i), W_{-1}(x+1)$$

Some exact values are found:

```
lambertW(-1, -exp(-1)), lambertW(-1, -2*exp(-2)),  
lambertW(-1, -3/2*exp(-3/2)), lambertW(exp(1)),  
lambertW(2*exp(2)), lambertW(5/2*exp(5/2)),  
lambertW(1, (3+4*I)*exp(3+4*I))
```

$$-1, -2, -\frac{3}{2}, 1, 2, \frac{5}{2}, 3+4i$$

Floating point values are computed for floating-point arguments:

```
lambertW(-1, -0.3), lambertW(2000.0)
```

$$-1.781337023, 5.836731495$$

```
lambertW(-3, -0.277), lambertW(1, 2345.6)
```

$$-3.951784369 - 13.85940405i, 5.690470601 + 5.513574431i$$



## Example 2

The functions `diff`, `float`, and `series` handle expressions involving the Lambert function:

```
diff(lambertW(k, x), x)
```

$$\frac{W_k(x)}{x(W_k(x) + 1)}$$

```
float(ln(3 + lambertW(sqrt(PI))))
```

1.334475971

```
series(lambertW(x), x = 0);
series(lambertW(x), x = -1/exp(1), 3);
series(lambertW(-1, x), x = -1/exp(1), 3);
```

$$x - x^2 + \frac{3x^3}{2} - \frac{8x^4}{3} + \frac{125x^5}{24} - \frac{54x^6}{5} + O(x^7)$$

$$-1 + \sqrt{2} \sqrt{e} \sqrt{x + e^{-1}} - \frac{2e(x + e^{-1})}{3} + O((x + e^{-1})^{3/2})$$

$$-1 - \sqrt{2} \sqrt{e} \sqrt{x + e^{-1}} - \frac{2e(x + e^{-1})}{3} + O((x + e^{-1})^{3/2})$$

## Parameters

**x**

An arithmetical expression (Symbolic Math Toolbox), the “argument”

**k**

An arithmetical expression (Symbolic Math Toolbox) representing an integer, the “branch”

## **Return Values**

Arithmetical expression.

## **References**

R.M. Corless, D.J. Jeffrey and D.E. Knuth: “A sequence of Series for the Lambert W Function”, in: Proceedings of ISSAC'97, Maui, Hawaii. W.W. Kuechlin (ed.). New York: ACM, pp. 197-204, 1997.

# laplace

Laplace transform

## Syntax

`laplace(f, t, s)`

## Description

`laplace(f, t, s)` computes the Laplace transform of the expression  $f = f(t)$  with respect to the variable  $t$  at the point  $s$ .

The Laplace transform is defined as follows:

$$F(s) = \int_0^{\infty} f(t) e^{-st} dt$$

If `laplace` cannot find an explicit representation of the transform, it returns an unevaluated function call. See “Example 3” on page 1-1194 (Symbolic Math Toolbox).

If  $f$  is a matrix, `laplace` applies the Laplace transform to all components of the matrix.

To compute the inverse Laplace transform, use `ilaplace`.

## Examples

### Example 1

Compute the Laplace transforms of these expressions with respect to the variable  $t$ :

`laplace(exp(-a*t), t, s)`

$$\frac{1}{a + s}$$

```
laplace(1 + exp(-a*t)*sin(b*t), t, s)
```

$$\frac{1}{s} + \frac{b}{(a+s)^2 + b^2}$$

## Example 2

Compute the Laplace transform of this expression with respect to the variable  $t$ :

```
F := laplace(t^10*exp(-s_0*t), t, s)
```

$$\frac{3628800}{(s + s_0)^{11}}$$

Evaluate the Laplace transform of the expression at the points  $s = -2s_0$  and  $s = 1 + \pi$ . You can evaluate the resulting expression  $F$  using `|` (or its functional form `evalAt`):

```
F | s = -2*s_0
```

$$-\frac{3628800}{s_0^{11}}$$

Also, you can evaluate the Laplace transform at a particular point directly:

```
laplace(t^10*exp(-s_0*t), t, 1 + PI)
```

$$\frac{3628800}{(s_0 + \pi + 1)^{11}}$$

## Example 3

If `laplace` cannot find an explicit representation of the transform, it returns an unevaluated call:

```
laplace(exp(-t^3), t, s)
```

$$\text{laplace}\left(e^{-t^3}, t, s\right)$$

ilaplace returns the original expression:

```
ilaplace(%, s, t)
```

$$e^{-t^3}$$

## Example 4

Compute the following Laplace transforms that involve the Dirac and the Heaviside functions:

```
laplace(dirac(t - 3), t, s)
```

$$e^{-3s}$$

```
laplace(heaviside(t - PI), t, s)
```

$$\frac{e^{-\pi s}}{s}$$

## Example 5

The Laplace transform of a function is related to the Laplace transform of its derivative:

```
laplace(diff(f(t), t), t, s)
```

$$s \text{ laplace}(f(t), t, s) - f(0)$$

## Parameters

**f**

Arithmetical expression or matrix on page 1-2045 (Symbolic Math Toolbox) of such expressions

**t**

Identifier on page 7-29 or indexed identifier on page 1-1017 representing the transformation variable

**s**

Arithmetical expression representing the evaluation point

## Return Values

Arithmetical expression or unevaluated function call of type `laplace`. If the first argument is a matrix, then the result is returned as a matrix.

## Overloaded By

f

## See Also

### MuPAD Functions

`ilaplace` | `ilaplace::addpattern` | `laplace::addpattern`

## Topics

“Integral Transforms” (Symbolic Math Toolbox)

# laplace::addpattern

Add patterns for the Laplace transform

## Syntax

```
laplace::addpattern(pat, t, s, res, <vars, <conds>>)
```

## Description

`laplace::addpattern(pat, t, s, res)` teaches `laplace` to return

$$\text{laplace}(\text{pat}, t, s) = \int_0^{\infty} \text{pat} e^{-s t} dt = \text{res}.$$

The `laplace` function uses a set of patterns for computing Laplace transforms. You can extend the set by adding your own patterns. To add a new pattern to the pattern matcher, use `laplace::addpattern`. MuPAD does not save custom patterns permanently. The new patterns are available in the *current* MuPAD session only.

Variable names that you use when calling `laplace::addpattern` can differ from the names that you use when calling `laplace`. See “Example 2” on page 1-1198 (Symbolic Math Toolbox).

You can include a list of free parameters and a list of conditions on these parameters. These conditions and the result are protected from premature evaluation. This means that you can use `not iszero(a^2 - b)` instead of `hold( _not @ iszero )(a^2 - b)`.

The following conditions treat assumptions on identifiers differently:

- `a^2 - b <> 0` takes into account assumptions on identifiers.
- `not iszero(a^2 - b)` disregards assumptions on identifiers.

See “Example 4” on page 1-1200 (Symbolic Math Toolbox).

## Environment Interactions

Calling `laplace::addpattern` changes the expressions returned by future calls to `laplace`.

## Examples

### Example 1

Compute the Laplace transform of the function `foo`. By default, MuPAD does not have a pattern for this function:

```
laplace(foo(t), t, s)
```

```
laplace(foo(t), t, s)
```

Add a pattern for the Laplace transform of `foo` using `laplace::addpattern`:

```
laplace::addpattern(foo(t), t, s, bar(s)):
```

Now `laplace` returns the Laplace transform of `foo`:

```
laplace(foo(t), t, s)
```

```
bar(s)
```

After you add a new transform pattern, MuPAD can use that pattern indirectly:

```
laplace(t^3 + exp(2*t)*foo(t), t, s)
```

```
bar(s - 2) +  $\frac{6}{s}$ 
```

### Example 2

Define the Laplace transform of `foo(x)` using the variables `x` and `y` as parameters:



```
laplace::addpattern(foo(x), x, y, bar(y)):
```

The `laplace` function recognizes the added pattern even if you use other variables as parameters:

```
laplace(foo(t), t, s)
```

```
bar(s)
```

### Example 3

Add this pattern for the Laplace transform of  $f$ :

```
laplace::addpattern(f(a*x)*g(a*x), x, y, y/(y^4 + 4*a^4)):
laplace(f(a*v)*g(a*v), v, w)
```

$$\frac{w}{4a^4 + w^4}$$

This pattern holds only when the first argument of  $f$  is the symbolic parameter  $a$ . If you use any other value of this parameter, `laplace` ignores the pattern:

```
laplace(f(A*v)*g(A*v), v, w)
```

```
laplace(f(A v) g(A v), v, w)
```

To use the pattern for arbitrary values of the parameter, declare the parameter  $a$  as an additional pattern variable:

```
laplace::addpattern(f(a*x)*g(a*x), x, y, y/(y^4 + 4*a^4), [a]):
```

Now `laplace` applies the specified pattern for an arbitrary value of  $a$ :

```
laplace(f(A*v)*g(A*v), v, w)
```

$$\frac{w}{4A^4 + w^4}$$

## Example 4

Use assumptions when adding the following pattern for the Laplace transform:

```
laplace::addpattern(F00(x*t), t, s, sin(1/(x-1/2))*BAR(s),  
                    [x], [abs(x) < 1]):  
laplace(F00(x*t),t,s) assuming -1 < x < 1
```

$$\sin\left(\frac{1}{x-\frac{1}{2}}\right) \text{BAR}(s)$$

If  $|x| \geq 1$ , you cannot apply this pattern:

```
laplace(F00(x*t),t,s) assuming x >= 1
```

$$\text{laplace}(\text{FOO}(t x), t, s)$$

If MuPAD cannot determine whether the conditions are satisfied, it returns a *piecewise* object:

```
laplace(F00(x*t), t, s)
```

$$\left\{ \sin\left(\frac{1}{x-\frac{1}{2}}\right) \text{BAR}(s) \text{ if } |x| < 1 \right.$$

Note that the resulting expression defining the Laplace transform of  $F00(x*t)$  implicitly assumes that the value of  $x$  is not  $1/2$ . A strict definition of the pattern is:

```
laplace::addpattern(F00(x*t), t, s, sin(1/(x-1/2))*BAR(s),  
                    [x], [abs(x) < 1, x <> 1/2]):
```

If either the conditions are not satisfied or substituting the values into the result gives an error, `laplace` ignores the pattern. For this particular pattern, you can omit specifying the assumption  $x \neq 1/2$ . If  $x = 1/2$ , MuPAD throws an internal “Division by zero.” error and ignores the pattern:

```
laplace(F00(1/2*t), t, s)
```

$$\text{laplace}\left(\text{FOO}\left(\frac{t}{2}\right), t, s\right)$$

## Parameters

### **pat**

Arithmetical expression (Symbolic Math Toolbox) in the variable `t` representing the pattern to match

### **t**

Identifier on page 7-29 or indexed identifier on page 1-1017 used as a variable in the pattern

### **s**

Identifier on page 7-29 or indexed identifier on page 1-1017 used as a variable in the result

### **res**

Arithmetical expression in the variable `s` representing the pattern for the result of the transformation

### **vars**

List of identifiers on page 7-29 or indexed identifiers on page 1-1017 used as “pattern variables” (placeholders in `pat` and `res`). You can use pattern variables as placeholders for almost arbitrary MuPAD expressions not containing `t` or `s`. You can restrict them by conditions given in the optional parameter `conds`.

### **conds**

List of conditions on the pattern variables

## Return Values

Object of type `DOM_NULL`

## See Also

### MuPAD Functions

`ilaplace` | `ilaplace::addpattern` | `laplace`

### Topics

“Use Custom Patterns for Transforms” (Symbolic Math Toolbox)

# laplacian

The Laplacian

## Syntax

`laplacian(f, [x1, x2, ...])`

`laplacian(f, [x1, x2, ...], ogCoord, <c>)`

## Description

`laplacian(f, [ x1, x2, ...])` computes the Laplacian  $\Delta f = \sum \frac{\partial^2}{\partial x_i^2} f$ , i.e.  $\text{div}(\text{grad}(f))$ , of the function  $f = f(x_1, x_2, \dots)$  in the Cartesian coordinates  $x_1, x_2, \dots$

The table `linalg::ogCoordTab` provides some predefined three-dimensional orthogonal coordinate transformations. Presently, its entries are `Cartesian`, `Cylindrical`, `Spherical`, `Spherical[LeftHanded]`, `EllipticCylindrical`, `ParabolicCylindrical`, `RotationParabolic`, and `Torus`. See `linalg::ogCoordTab` for details. For example, the command

`laplacian(f(r, Theta, phi), [r, Theta, phi], Spherical)`

produces the Laplacian of  $f$  in spherical coordinates  $r, \theta, \phi$  defined by the transformation

$$x = r \sin(\theta) \cos(\phi), \quad y = r \sin(\theta) \sin(\phi), \quad z = r \cos(\theta)$$

Arbitrary orthogonal systems  $u = (u_1, \dots, u_n)$  (in any dimension  $n$ ) can be used by passing corresponding “scale parameters” as third argument to `laplacian`. These are defined as

follows. Let  $\vec{x} = (x_1, \dots, x_n)$  be Cartesian coordinates, let  $\vec{x}(\vec{u})$  be an orthogonal

transformation (i.e., the vectors  $\frac{\partial \vec{x}}{\partial u_i}$  are orthogonal). The Euclidean lengths  $s_i = \left| \frac{\partial \vec{x}}{\partial u_i} \right|$  of the vectors define the “scales”. The list  $s = [s_1, \dots, s_n]$  can be passed as a third

argument to `laplacian`. For example, the usual two-dimensional polar coordinates  $x = r \cos(\phi)$ ,  $y = r \sin(\phi)$  lead to scale factors

$$s = \left[ \left| \left( \frac{\partial}{\partial r} x, \frac{\partial}{\partial r} y \right) \right|, \left| \left( \frac{\partial}{\partial \phi} x, \frac{\partial}{\partial \phi} y \right) \right| \right] = [ |(\cos(\phi), \sin(\phi))|, |(-r \sin(\phi), r \cos(\phi))| ] = [1, r]$$

Thus, `laplacian(f(r, phi), [r, phi], [1, r])` produces the Laplacian of  $f(r, \phi)$  in polar coordinates  $r$  and  $\phi$ .

## Examples

### Example 1

Compute the Laplacian in Cartesian coordinates:

```
laplacian(f(x[1], x[2]), [x[1], x[2]])
```

$$\frac{\partial^2}{\partial x_1^2} f(x_1, x_2) + \frac{\partial^2}{\partial x_2^2} f(x_1, x_2)$$

```
laplacian(x^2*y + c*exp(y) + u*v^2, [x, y, u, v])
```

$$2u + 2y + c e^y$$

### Example 2

Compute the Laplacian in cylindrical coordinates  $(r, \phi, z)$  given by

$$x = r \cos(\phi), y = r \sin(\phi), z = z$$

```
expand(laplacian(f(r, phi, z), [r, phi, z], Cylindrical))
```

$$\frac{\frac{\partial^2}{\partial \text{phi}^2} f(r, \text{phi}, z)}{r^2} + \frac{\frac{\partial}{\partial r} f(r, \text{phi}, z)}{r} + \frac{\partial^2}{\partial r^2} f(r, \text{phi}, z) + \frac{\partial^2}{\partial z^2} f(r, \text{phi}, z)$$

```
laplacian(r*cos(phi)*z^3, [r, phi, z], Cylindrical)
```

```
6 r z cos(phi)
```

Passing the name `Cylindrical` of the orthogonal system predefined in `linalg::ogCoordTab` is the simplest way of using cylindrical coordinates. Alternatively, one may pass appropriate 'scale parameters' explicitly. They are stored in `linalg::ogCoordTab` and can be called in the following way:

```
linalg::ogCoordTab[Cylindrical, Scales](r, phi, z)
```

```
[1, r, 1]
```

```
laplacian(r*cos(phi)*z^3, [r, phi, z], %)
```

```
6 r z cos(phi)
```

### Example 3

Consider Torus coordinates  $(r, \theta, \phi)$  introduced by

$$x = (c - r \cos(\theta)) \cos(\phi), y = (c - r \cos(\theta)) \sin(\phi), z = r \sin(\theta)$$

Here,  $c$  is a real constant and  $0 \leq r < c$ ,  $0 \leq \theta \leq 2\pi$ ,  $0 \leq \phi \leq 2\pi$  is assumed. The "scale parameters" are stored in `linalg::ogCoordTab`:

```
linalg::ogCoordTab[Torus, Scales](r, thet, phi, c)
```

```
[1, r, c - r cos(thet)]
```

The Laplacian of the function  $f(r, \phi, z) = r$  in these coordinates is:

```
laplacian(r, [r, thet, phi], %)
```

$$\frac{c - 2 r \cos(\text{thet})}{r (c - r \cos(\text{thet}))}$$

### Example 4

You can introduce new orthogonal systems. For example, consider the orthogonal “6-sphere coordinates”  $(u, v, w)$  introduced by

$$x = \frac{u}{u^2 + v^2 + w^2}, y = \frac{v}{u^2 + v^2 + w^2}, z = \frac{w}{u^2 + v^2 + w^2}.$$

This transformation  $(u, v, w) \rightarrow \vec{x} = (x, y, z)$  is not stored in `linalg::ogCoordTab`, hence the corresponding “scale factors” of the metric have to be computed first:

$$\left| \frac{\partial \vec{x}}{\partial u} \right| = \left| \frac{\partial \vec{x}}{\partial v} \right| = \left| \frac{\partial \vec{x}}{\partial w} \right| = \frac{1}{u^2 + v^2 + w^2}.$$

With these “scales”, the Laplacian can be computed via `laplacian`:

```
s := 1/(u^2 + v^2 + w^2):  
factor(laplacian(f(u, v, w), [u, v, w], [s, s, s]))
```



$$\begin{aligned} & (u^2 + v^2 + w^2) \left( u^2 \sigma_3 + v^2 \sigma_3 + w^2 \sigma_3 - 2 u \frac{\partial}{\partial u} f(u, v, w) + u^2 \sigma_2 + v^2 \sigma_2 + w^2 \sigma_2 \right. \\ & \left. - 2 v \frac{\partial}{\partial v} f(u, v, w) + u^2 \sigma_1 + v^2 \sigma_1 + w^2 \sigma_1 - 2 w \frac{\partial}{\partial w} f(u, v, w) \right) \end{aligned}$$

where

$$\sigma_1 = \frac{\partial^2}{\partial w^2} f(u, v, w)$$

$$\sigma_2 = \frac{\partial^2}{\partial v^2} f(u, v, w)$$

$$\sigma_3 = \frac{\partial^2}{\partial u^2} f(u, v, w)$$

Since the Laplacian is the divergence of the gradient, you can compute it in the following way, too:

```
divergence(gradient(f(u, v, w), [u, v, w], [s, s, s]),
           [u, v, w], [s, s, s])
```

$$\begin{aligned} & \sigma_1^2 \frac{\partial^2}{\partial u^2} f(u, v, w) + \sigma_1^2 \frac{\partial^2}{\partial v^2} f(u, v, w) + \sigma_1^2 \frac{\partial^2}{\partial w^2} f(u, v, w) - 2 u \sigma_1 \frac{\partial}{\partial u} f(u, v, w) \\ & - 2 v \sigma_1 \frac{\partial}{\partial v} f(u, v, w) - 2 w \sigma_1 \frac{\partial}{\partial w} f(u, v, w) \end{aligned}$$

where

$$\sigma_1 = u^2 + v^2 + w^2$$

```
expand(% - %2)
```

```
0
```

delete s:

## Parameters

**f**

An arithmetical expression (Symbolic Math Toolbox) in the variables  $x_1, x_2$  etc.

$x_1, x_2, \dots$

identifiers on page 7-29 or indexed identifiers on page 1-1017

**ogCoord**

The name of a three-dimensional orthogonal coordinate system predefined in the table `linalg::ogCoordTab`, or a list of algebraic expressions representing the scale factors of an orthogonal coordinate system.

**c**

The parameter of the coordinate systems `EllipticCylindrical` on page 15-167 and `Torus` on page 15-167, respectively: an arithmetical expression (Symbolic Math Toolbox). The default value is  $c = 1$ .

## Return Values

Arithmetical expression.

## Algorithms

Orthogonal coordinates  $\vec{u}$  on  $\mathbb{R}^n$  are defined by a transformation  $\vec{x}(\vec{u})$  to Cartesian coordinates  $\vec{x}$  on  $\mathbb{R}^n$ . The metric tensor associated with the coordinates  $\vec{u}$  is given by

$$(g_{i,j}) = \left( \frac{\partial}{\partial u_i} \vec{x}, \frac{\partial}{\partial u_j} \vec{x} \right) = \text{diag}(s_1^2, \dots, s_n^2), \quad s_i = \left| \frac{\partial}{\partial u_i} \vec{x} \right|$$

The Laplacian of a function  $f$  is given by the divergence

$$\Delta f = \operatorname{div}(\vec{F}) = \sum_{j=1}^n \left( \frac{\partial}{\partial u_j} \frac{F_j}{s_j} + \frac{F_j}{s_j} \left( \sum_{k=1}^n \frac{1}{s_k} \frac{\partial}{\partial u_j} s_k \right) \right),$$

where  $F_j = \frac{1}{s_j} \frac{\partial}{\partial u_j} f$  are the components of the gradient  $\vec{F} = \operatorname{grad}(f)$ .

## See Also

### MuPAD Functions

`curl` | `divergence` | `gradient` | `linalg::ogCoordTab` | `potential` | `vectorPotential`

## **%last**

Access a previously computed object

### **Syntax**

`%`

`% n`

`last(n)`

### **Description**

`last()` or `%` returns the result of the last command.

`last(n)` or `%n` returns the result of the *n*th previous command.

By default, MuPAD stores the last 20 commands and their results in an internal history table on page 1-924. `last(n)` returns the result entry of the *n*th element in this table, counted from the end of the table. Thus `last(1)` returns the result of the last command, `last(2)` returns the result of the next to last one, etc. Instead of `last(n)` one can also write more briefly `%n`. Instead of `last(1)` or `%1`, one can use even more briefly `%`.

The environment variable `HISTORY` determines the number of previous results that can be accessed at interactive level, i.e., the number of entries in the history table. In procedures on page 7-45, the length of this table is always 3, independent of the value of `HISTORY`. Thus admissible values for *n* are the integers between 1 and `HISTORY` at interactive level, and the integers 1, 2, 3 inside a procedure.

Use `history` to access entries of the history table at interactive level directly, including the command that produced the corresponding result.

The result returned by `last` or `%` is not evaluated again. Use the function `eval` to force a subsequent evaluation. See “Example 4” on page 1-1213 (Symbolic Math Toolbox).

---

**Note** `last` behaves differently at interactive level and in procedures on page 7-45. At interactive level, compound statements, such as `for`, `repeat`, and `while` loops and `if`

and case branching instructions, are stored in the history table as a whole. In procedures, the statements within a compound statement are stored in a separate history table of this procedure, but not the compound statement itself. See “Example 5” on page 1-1214 (Symbolic Math Toolbox).

---

Commands and their results are stored in the history table even if the output is suppressed by a colon. Thus the result of `last(n)` may differ from the *n*th previous output that is visible on the screen at interactive level. See “Example 1” on page 1-1211 (Symbolic Math Toolbox).

Commands appearing on the same input line lead to separate entries in the history table if they are separated by a colon or a semicolon. In contrast, an expression sequence on page 1-88 is regarded as a single command. See “Example 2” on page 1-1212 (Symbolic Math Toolbox).

Commands that are read from a file via `fread` or `read` are stored in the history table *before* the `fread` or `read` command itself. If the option `Plain` is used, then a separate history table is valid within the file, and the commands from the file do not appear in the history table of the enclosing context. See the help page of `history` for examples.

Using `last` in procedures is generally considered bad programming style and is therefore deprecated. Future MuPAD releases may no longer support the use of `last` within procedures.

If the abbreviated syntax `%n` is used, then *n* must be a positive integer on page 7-31 literally. If this is not the case, but *n* evaluates to a positive integer, use the equivalent functional notation `last(n)` (see “Example 3” on page 1-1213 (Symbolic Math Toolbox)).

## Examples

### Example 1

Here are some examples for using `last` at interactive level. Note that `last(n)` refers to the *n*th previously computed result, whether it was displayed or not:

```
a := 42;  
last(1), %, %1
```

42

```
42, 42, 42
```

```
a := 34: b := 56: last(2) = %2
```

```
34 = 34
```

## Example 2

Commands appearing on one input line lead to separate entries in the history table:

```
"First command"; 11: 22; 33:
```

```
"First command"
```

```
22
```

```
last(1), last(2);
```

```
33, 22
```

If a sequence of commands is bracketed, it is regarded as a single command:

```
"First command"; (11: 22; 33:)
```

```
"First command"
```

```
33
```

```
last(1), last(2);
```

```
33, "First command"
```

An expression sequence is also regarded as a single command:

```
"First command"; 11, 22, 33;
```

```
"First command"
```

```
11, 22, 33
```

```
last(1), last(2);
```

```
11, 22, 33, "First command"
```

### Example 3

Due to the fact that the MuPAD parser expects a number after the % sign, there is a difference between the use of % and last. last can be called with an expression that evaluates to a positive integer:

```
n := 2: a := 35: b := 56: last(n)
```

```
35
```

If you try the same with %, an error occurs:

```
n := 2: a := 35: b := 56: %n
```

```
Error: Unexpected 'identifier'. [line 1, col 28]
```

### Example 4

The result of last is not evaluated again:

```
delete a, b:  
c := a + b + a: a:= b: %2
```

```
2 a + b
```

Use eval to enforce the evaluation:

```
eval(%)
```

```
3 b
```

## Example 5

We demonstrate the difference between the use of `last` at interactive level and in procedures:

```
1: for i from 1 to 3 do i: print(%): end_for:
```

```
1
```

```
1
```

```
1
```

Here `last(1)` refers to the most recent entry in the history table, which is the 1 executed before the `for` loop. We can also verify this by inspecting the history table after these commands. The command `history` returns a list with two elements. The first entry is a previously entered MuPAD command, and the second entry is the result of this command returned by MuPAD. You see that the history table contains the whole `for` loop as a single command:

```
history(history() - 1), history(history())
```

```
[1, 1], [(for i from 1 to 3 do  
  i;  
  print(%)  
end_for), null()]
```

However, if the `for` loop defined above is executed inside a procedure, then we obtain a different result. In the following example, `last(1)` refers to the last evaluated expression, namely the `i` inside the loop:

```
f := proc()  
begin
```



```
1: for i from 1 to 3 do i: print(last(1)): end_for  
end_proc:
```

```
f():
```

```
1
```

```
2
```

```
3
```

The command history refers only to the interactive inputs and their results:

```
history(history())
```

```
[f(), null()]
```

## Parameters

**n**

A positive integer on page 7-31

## Return Values

MuPAD object.

## See Also

**MuPAD Functions**  
HISTORY | history

**Topics**

“History Mechanism” (Symbolic Math Toolbox)

# lasterror

Reproduce the last error

## Syntax

```
lasterror()
```

## Description

`lasterror()` reproduces the last error that occurred in the current MuPAD session.

Typically, `lasterror` is used to reproduce errors that were caught by `traperror`. Cf. "Example 2" on page 1-1218 (Symbolic Math Toolbox).

## Examples

### Example 1

We produce an error:

```
x := 0: y := 1/x
```

```
Error: Division by zero. [_invert]
```

This error may be reproduced by `lasterror`:

```
lasterror()
```

```
Error: Division by zero. [_invert]
```

A further error is produced:

```
error("my error")
```

```
Error: my error
```

```
lasterror()
```

```
Error: my error
```

```
delete x, y:
```

## Example 2

The following procedure `myln` computes the `ln` function of its argument. In case of an error produced by the system function `ln`, it prints information on the argument and reproduces the error:

```
myln := proc(x)
  local result;
begin
  if traperror((result := ln(x))) = 0 then
    return(result)
  else
    print(Unquoted, "the following error occurred " .
          "when calling ln(Expr2text(x).):");
    lasterror()
  end_if;
end;
```

Indeed, the `ln` has a singularity at 0 and produces:

```
myln(0)
```

```
the following error occurred when calling ln(0):
```

```
Error: Singularity. [ln]
  Evaluating: myln
```

```
delete myln:
```

## See Also

### MuPAD Functions

error | getlasterror | traperror

## **&&\_lazy\_and**

“short circuit and” of Boolean expressions

### **Syntax**

```
b1 && b2 && ...
```

```
_lazy_and(b1, b2, ...)
```

### **Description**

`b1 && b2 && ...` evaluates the Boolean expression `b1 and b2 and ...` by “short circuit evaluation”.

`b1 && b2 && ...` produces the same result as `bool(b1 and b2 and ...)`, provided the latter call does not throw an error. The difference between these calls is as follows. The call `bool(b1 and b2 and ...)` evaluates *all* Boolean expressions before combining them logically via `and`.

`_lazy_and(b1, b2, ...)` is equal to `b1 && b2 && ...`.

Note that the result is `FALSE` if one of `b1`, `b2`, and so on evaluates to `FALSE`. “short circuit evaluation” is based on this fact: `b1 && b2 && ...` evaluates the arguments from left to right. The evaluation stops immediately if one argument evaluates to `FALSE`. In this case, `_lazy_and` returns `FALSE` *without* evaluating the remaining Boolean expressions. If none of the expressions `b1`, `b2`, and so on evaluates to `FALSE`, then all arguments are evaluated and the corresponding result (`TRUE` or `UNKNOWN`) is returned.

`_lazy_and` is also called “conditional and”.

If any of the considered Boolean expressions `b1`, `b2`, and so on cannot be evaluated to `TRUE`, `FALSE`, or `UNKNOWN`, then `_lazy_and` throws an error.

`_lazy_and` is used internally by the `if`, `repeat`, and `while` statements. For example, the statement `if b1 and b2 then ...` is equivalent to `if b1 && b2 then ...`.

`_lazy_and()` returns `TRUE`.

## Examples

### Example 1

This example show the difference between short circuit and complete evaluation of

Boolean conditions. For  $x = 0$ , the evaluation of  $\sin\left(\frac{1}{x}\right)$  leads to an error:

```
x := 0:  
bool(x <> 0 and sin(1/x) = 0)
```

Error: Division by zero. [\_invert]

With “short circuit evaluation”, the expression  $\sin\left(\frac{1}{x}\right) = 0$  is not evaluated. This avoids the previous error:

```
x <> 0 && sin(1/x) = 0
```

FALSE

```
delete x
```

### Example 2

The following statements do not lead to an error because `if` uses short circuit evaluation internally:

```
for x in [0, PI, 1/PI] do  
  if x <> 0 and sin(1/x) = 0 then  
    print(x)  
  end_if;  
end_for:
```

$\frac{1}{\pi}$

```
delete x
```

### Example 3

`_lazy_and` can be called without parameters:

```
_lazy_and()
```

```
TRUE
```

### Parameters

`b1, b2, ...`

Boolean expressions

### Return Values

TRUE, FALSE, or UNKNOWN.

### Overloaded By

`b1, b2`

### See Also

#### MuPAD Functions

FALSE | TRUE | UNKNOWN | `_lazy_or` | `and` | `bool` | `if` | `is` | `or` | `repeat` | `while`



# ||\_lazy\_or

“short circuit or” of Boolean expressions

## Syntax

```
b1 || b2 || ...  
_lazy_or(b1, b2, ...)
```

## Description

`b1 || b2 || ...` evaluates the Boolean expression `b1 or b2 or ...` by “short circuit evaluation”.

`b1 || b2 || ...` produces the same result as `bool(b1 or b2 or ...)`, provided the latter call does not throw an error. The difference between these calls is as follows. The call `bool(b1 or b2 or ...)` evaluates *all* Boolean expressions before combining them logically via `or`.

`_lazy_or(b1, b2, ...)` is equal to `b1 || b2 || ...`.

The result is `TRUE` if one of `b1`, `b2`, and so on evaluates to `TRUE`. “short circuit evaluation” is based on this fact: `b1 || b2 || ...` evaluates the arguments from left to right. The evaluation stops immediately if one argument evaluates to `TRUE`. In this case, `_lazy_or` returns `TRUE` *without* evaluating the remaining Boolean expressions. If none of the expressions `b1`, `b2`, and so on evaluates to `TRUE`, then all arguments are evaluated and the corresponding result `FALSE` or `UNKNOWN` is returned.

`_lazy_or` is also called “conditional or”.

If any of the considered Boolean expressions `b1`, `b2`, and so on cannot be evaluated to `TRUE`, `FALSE`, or `UNKNOWN`, then `_lazy_or` throws an error.

`_lazy_or` is used internally by the `if`, `repeat`, and `while` statements. For example, the statement `if b1 or b2 then ...` is equivalent to `if b1 || b2 then ...`.

`_lazy_or()` returns `FALSE`.

## Examples

### Example 1

This example show the difference between short circuit evaluation and complete evaluation of Boolean conditions. For  $x = 0$ , the evaluation of  $\sin\left(\frac{1}{x}\right)$  leads to an error:

```
x := 0:  
bool(x = 0 or sin(1/x) = 0)
```

Error: Division by zero. [\_invert]

With “short circuit evaluation”, the expression  $\sin\left(\frac{1}{x}\right) = 0$  is not evaluated. This avoids the previous error:

```
x = 0 || sin(1/x) = 0
```

TRUE

```
delete x:
```

### Example 2

The following statements do no lead to an error because `if` uses short circuit evaluation internally:

```
for x in [0, PI, 1/PI] do  
  if x = 0 or sin(1/x) = 0 then  
    print(x)  
  end_if;  
end_for:
```

0

$\frac{1}{\pi}$

delete x

### Example 3

\_lazy\_or() can be called without parameters:

```
_lazy_or()
```

```
FALSE
```

## Parameters

**b1, b2, ...**

Boolean expressions

## Return Values

TRUE, FALSE, or UNKNOWN.

## Overloaded By

b1, b2

## See Also

### MuPAD Functions

FALSE | TRUE | UNKNOWN | \_lazy\_and | and | bool | if | is | or | repeat | while

## lcm

Least common multiple of polynomials

### Syntax

`lcm(p, q, ...)`

`lcm(f, g, ...)`

### Description

`lcm(p, q, ...)` calculates the least common multiple of any number of polynomials. The coefficient ring on page 1-1601 of the polynomials may either be the integers or the rational numbers, `Expr`, a residue class ring `IntMod(n)` with a prime number `n`, or a domain (Symbolic Math Toolbox).

All polynomials must have the same indeterminates and the same coefficient ring.

Polynomial expressions are converted to polynomials. See `poly` for details. `FAIL` is returned if an argument cannot be converted to a polynomial.

The return value is of the same type as the input polynomials, i.e., either a polynomial of type `DOM_POLY` or a polynomial expression.

`lcm` returns 1 if all arguments are 1 or -1, or if no argument is given. If at least one of the arguments is 0, then `lcm` returns 0.

Use `ilcm` if all arguments are known to be integers, since it is much faster than `lcm`.

## Examples

### Example 1

The least common multiple of two polynomial expressions can be computed as follows:

```
lcm(x^3 - y^3, x^2 - y^2);
```

$$(x + y) (x^3 - y^3)$$

One may also choose polynomials as arguments:

```
p := poly(x^2 - y^2, [x, y], IntMod(17));
q := poly(x^2 - 2*x*y + y^2, [x, y], IntMod(17));
lcm(p, q)
```

$$\text{poly}(x^3 - x^2 y - x y^2 + y^3, [x, y], \text{IntMod}(17))$$

```
delete f, g, p, q;
```

## Parameters

**pq, ...**

polynomials (Symbolic Math Toolbox) of type DOM\_POLY

**fg, ...**

polynomial expressions (Symbolic Math Toolbox)

## Return Values

Polynomial, a polynomial expression, or the value FAIL.

## Overloaded By

f, g, p, q

## See Also

### MuPAD Functions

`content` | `factor` | `gcd` | `gcdex` | `icontent` | `ifactor` | `igcd` | `igcdex` | `ilcm` | `poly`

# lcoeff

Leading coefficient of a polynomial

## Syntax

`lcoeff(p, <order>)`

`lcoeff(f, <vars>, <order>)`

## Description

`lcoeff(p)` returns the leading coefficient of the polynomial  $p$ .

The returned coefficient is “leading” with respect to the lexicographical ordering, unless a different ordering is specified via the argument `order`. Cf. “Example 1” on page 1-1229 (Symbolic Math Toolbox).

A polynomial expression  $f$  is first converted to a polynomial with the variables given by `vars`. If no variables are given, they are searched for in  $f$ . See `poly` about details of the conversion. The result is returned as polynomial expression. FAIL is returned if  $f$  cannot be converted to a polynomial. Cf. “Example 3” on page 1-1230 (Symbolic Math Toolbox).

The result of `lcoeff` is not fully evaluated. Evaluation can be enforced by the function `eval`. Cf. “Example 2” on page 1-1230 (Symbolic Math Toolbox).

## Examples

### Example 1

We demonstrate how various orderings influence the result:

```
p := poly(5*x^4 + 4*x^3*y*z^2 + 3*x^2*y^3*z + 2, [x, y, z]):
lcoeff(p), lcoeff(p, DegreeOrder), lcoeff(p, DegInvLexOrder)
```

5, 4, 3

The following call uses the reverse lexicographical order on page 7-309 on 3 indeterminates:

```
lcoeff(p, Dom::MonomOrdering(RevLex(3)))
```

```
3
```

```
delete p:
```

## Example 2

The result of `lcoeff` is not fully evaluated:

```
p := poly(a*x^2 + 27*x, [x]): a := 5:  
lcoeff(p), eval(lcoeff(p))
```

```
a, 5
```

```
delete p, a:
```

## Example 3

The expression  $1/x$  may not be regarded as polynomial:

```
lcoeff(1/x)
```

```
FAIL
```

## Parameters

**p**

A polynomial (Symbolic Math Toolbox) of type `DOM_POLY`

**f**

A polynomial expression (Symbolic Math Toolbox)



**vars**

A list on page 7-41 of indeterminates of the polynomial: typically, identifiers on page 7-29 or indexed identifiers on page 1-1017

**order**

The term ordering: either `LexOrder`, or `DegreeOrder`, or `DegInvLexOrder`, or a user-defined term ordering of type `Dom::MonomOrdering`. The default is the lexicographical ordering `LexOrder`.

## Return Values

Element of the coefficient domain of the polynomial or `FAIL`.

## Overloaded By

`p`

## See Also

**MuPAD Functions**

`coeff` | `collect` | `degree` | `degreevec` | `ground` | `ldegree` | `lmonomial` | `lterm` | `monomials` | `nterms` | `nthcoeff` | `nthmonomial` | `nthterm` | `poly` | `poly2list` | `tcoeff`

# ldegree

Lowest degree of the terms in a polynomial

## Syntax

`ldegree(p)`

`ldegree(p, x)`

`ldegree(f, <vars>)`

`ldegree(f, <vars>, x)`

## Description

`ldegree(p)` returns the lowest total degree of the terms of the polynomial `p`.

`ldegree(p, x)` returns the lowest degree of the terms in `p` with respect to the variable `x`.

If the first argument `f` is not element of a polynomial domain, then `ldegree` converts the expression to a polynomial via `poly(f)`. If a list of indeterminates is specified, then the polynomial `poly(f, vars)` is considered.

`ldegree(f, vars, x)` returns 0 if `x` is not an element of `vars`.

The low degree of the zero polynomial is defined as 0.

## Examples

### Example 1

The lowest total degree of the terms in the following polynomial is computed:

```
ldegree(x^3 + x^2*y^2)
```

3

The next call regards the expression as a polynomial in  $x$  with a parameter  $y$ :

```
ldegree(x^3 + x^2*y^2, x)
```

2

The next expression is regarded as a bi-variate polynomial in  $x$  and  $z$  with coefficients containing the parameter  $y$ . The total degree with respect to  $x$  and  $z$  is computed:

```
ldegree(x^3*z^2 + x^2*y^2*z, [x, z])
```

3

We compute the low degree with respect to  $x$ :

```
ldegree(x^3*z^2 + x^2*y^2*z, [x, z], x)
```

2

A polynomial in  $x$  and  $z$  is regarded constant with respect to any other variable, i.e., its corresponding degree is 0:

```
ldegree(poly(x^3*z^2 + x^2*y^2*z, [x, z]), y)
```

0

## Parameters

**p**

A polynomial (Symbolic Math Toolbox) of type DOM\_POLY

**f**

A polynomial expression (Symbolic Math Toolbox)

### **vars**

A list on page 7-41 of indeterminates of the polynomial: typically, identifiers on page 7-29 or indexed identifiers on page 1-1017

### **x**

An indeterminate

## **Return Values**

Nonnegative number. FAIL is returned if the input cannot be converted to a polynomial.

## **Overloaded By**

f, p

## **See Also**

### **MuPAD Functions**

[coeff](#) | [degree](#) | [degreevec](#) | [ground](#) | [lcoeff](#) | [lmonomial](#) | [lterm](#) | [monomials](#) | [nterms](#) | [nthcoeff](#) | [nthmonomial](#) | [nthterm](#) | [poly](#) | [poly2list](#) | [tcoeff](#)

# length

The “length” of a object (heuristic complexity)

## Syntax

`length(object)`

## Description

`length(object)` returns an integer indicating the complexity of the object.

The (heuristic) complexity of an object may be useful in algorithms that need to predict the complexity and time for manipulating objects. E.g., a symbolic Gaussian algorithm for solving linear equations prefers Pivot elements of small complexity.

The length of an object is determined as follows:

- Objects of domain type `DOM_BOOL`, `DOM_DOMAIN`, `DOM_EXEC`, `DOM_FAIL`, `DOM_FLOAT`, `DOM_FUNC_ENV`, `DOM_IDENT`, `DOM_NIL`, `DOM_VAR`, and `DOM_PROC_ENV` are regarded as “atomic”. They have length 1. In particular, the length of identifiers and real floating-point numbers is 1.
- The length of an integer on page 7-31 is (a close approximation of) the number of decimal digits, including the sign.
- The length of a string on page 7-53 is the number of its characters.
- The length of composite objects such as complex numbers on page 7-84, rational numbers on page 7-48, arithmetical expressions on page 7-20, lists on page 7-41, sets on page 7-50, arrays on page 7-2, hfarrays on page 7-27, tables on page 1-2103 etc. is the sum of the lengths of the operands plus 1.

`length()` yields 0.

---

**Note** `length` does *not* return the number of elements or entries in sets, lists or tables. Use `nops` instead!

---

## Examples

### Example 1

Intuitively, the length measures the complexity of an object:

```
length(1 + x) < length(x^3 + exp(a - b)/ln(45 - t) - 1234*I)
```

```
3 < 30
```

### Example 2

We compute the lengths of some simple objects:

```
length(1.2), length(-1234.5), length(123456), length(-123456)
```

```
1, 1, 6, 7
```

```
length(17), length(123), length(17/123)
```

```
2, 3, 6
```

```
length(12), length(123), length(12 + 123*I)
```

```
2, 3, 6
```

```
length(x), length(x^2), length(x^12345)
```

```
1, 3, 7
```

```
length("123"), length("")
```

```
3, 0
```

```
length(x), length(a_long_name)
```

1, 1

### Example 3

The length of an array is the sum of the lengths of all its elements plus 1:

```
A := array(1..2, [x, y]): length(A) = length(x) + length(y) + 1
```

3 = 3

```
A[1] := 12345: length(A) = length(12345) + length(y) + 1
```

7 = 7

```
A := hfarray(1..10, [1.0 $ 10]):
length(A) = 10*length(1.0) + 1
```

11 = 11

```
A := hfarray(1..10, [1.0 + 2.0*I $ 10]):
length(A) = 10*length(1.0 + 2.0*I) + 1
```

31 = 31

Beware: If only one complex number is contained in an hfarray, then *all* entries are regarded as complex numbers, even if they are real:

```
A := hfarray(1..10, [2.0 $ 9, 2.0 + 3.0*I]):
length(A) = 10*length(2.0 + 3.0*I) + 1
```

31 = 31

```
delete A:
```

## Example 4

The operands of a table on page 1-2103 are the equations associating indices and entries. The length of each operand is the length of the index plus the length of the corresponding entry plus 1:

```
T[1] := 45: T
```

```
1|45
```

```
length(T) = length(1 = 45) + 1
```

```
5 = 5
```

```
delete T:
```

## Parameters

### object

An arbitrary MuPAD object

## Return Values

Nonnegative integer.

## See Also

### MuPAD Functions

nops | op



# LEVEL

Substitution depth of identifiers

## Description

The environment variable LEVEL determines the maximal substitution depth of identifiers.

Possible values: a positive integer on page 7-31 smaller than  $2^{31}$ .

When a MuPAD object is evaluated, identifiers on page 7-29 occurring in it are replaced by their values. This happens recursively, i.e., if the values themselves contain identifiers, then these are replaced as well. LEVEL determines the maximal recursion depth of this process.

Technically, evaluation of a MuPAD object works as follows. For a compound object, usually first the operands on page 1-1493 are evaluated recursively, and then the object itself is evaluated. E.g., if the object is a function call with arguments, the arguments are evaluated first, and then the function is executed with the evaluated arguments.

With respect to the evaluation of identifiers on page 7-29, the *current substitution depth* is recorded internally. Initially, this value is zero. If an identifier is encountered during the recursive evaluation process as described above and the current substitution depth is smaller than LEVEL, then the identifier is replaced by its value, the current substitution depth is increased by one, and evaluation proceeds recursively with the value of the identifier. After the identifier has been evaluated, the current substitution depth is reset to its previous value. If the current substitution depth equals LEVEL, however, then the recursion stops and the identifier remains unevaluated.

---

**Note** The default value of LEVEL at interactive level is 100. However, the default value of LEVEL within a procedure on page 7-45 is 1. Then an identifier is only replaced by its value, which is not evaluated recursively.

---

The value of LEVEL may be changed within a procedure, but it is reset to 1 each time a new procedure is entered. After the procedure returns, LEVEL is reset to its previous value. See “Example 3” on page 1-1242 (Symbolic Math Toolbox).

---

**Note** The evaluation of local variables and formal parameters of procedures on page 7-45, of type `DOM_VAR`, is not affected by `LEVEL`: they are always evaluated with substitution depth 1. This means that a local variable or a formal parameter is replaced by its value when evaluated, but the value is not evaluated further.

---

See “Example 3” on page 1-1242 (Symbolic Math Toolbox).

---

**Note** `LEVEL` does not affect the evaluation of arrays on page 7-2, tables on page 1-2103 and polynomials on page 1-1601.

---

See “Example 4” on page 1-1243 (Symbolic Math Toolbox).

The function `eval` evaluates its argument with substitution depth given by `LEVEL`, and then evaluates the result again with the same substitution depth.

The call `level(object, n)` evaluates its argument with substitution depth `n`, independent of the value of `LEVEL`.

If, during evaluation, the substitution depth `MAXLEVEL`, is reached, then the evaluation is terminated with an error. This is a heuristic for recognizing recursive definitions, as in the example `delete a; a := a + 1; a`. Here, `a` would be replaced by `a + 1` infinitely often. Note that this has no effect if `MAXLEVEL` is greater than `LEVEL`. The default value of `MAXLEVEL` is 100, i.e., it is equal to the default value of `LEVEL` at interactive level. However, unlike `LEVEL`, `MAXLEVEL` is not changed within a procedure on page 7-45, and hence recursive definitions are usually not recognized within procedures. See the help page of `MAXLEVEL` for examples.

The default value of `LEVEL` is 100 at interactive level; `LEVEL` has this value after starting or resetting the system via `reset`. Within a procedure, the default value is 1. The command `delete LEVEL` restores the default value.

## Examples

### Example 1

We demonstrate the effect of various values of `LEVEL` at interactive level:

```
delete a0, a1, a2, a3, a4, b: b := b + 1:
a0 := a1: a1 := a2 + 2: a2 := a3 + a4: a3 := a4^2: a4 := 5:
```

```
LEVEL := 1: a0, a0 + a2, b;
LEVEL := 2: a0, a0 + a2, b;
LEVEL := 3: a0, a0 + a2, b;
LEVEL := 4: a0, a0 + a2, b;
LEVEL := 5: a0, a0 + a2, b;
LEVEL := 6: a0, a0 + a2, b;
delete LEVEL:
```

$a_1, a_1 + a_3 + a_4, b + 1$

$a_2 + 2, a_4^2 + a_2 + 7, b + 2$

$a_3 + a_4 + 2, a_3 + a_4 + 32, b + 3$

$a_4^2 + 7, a_4^2 + 37, b + 4$

$32, 62, b + 5$

$32, 62, b + 6$

## Example 2

In the following calls, the identifier `a` is fully evaluated:

```
delete a, b, c:
a := b: b := c: c := 7: a
```

7

After assigning the value 2 to LEVEL, `a` is evaluated only with depth two:

```
LEVEL := 2: a;  
delete LEVEL:
```

c

If we set MAXLEVEL to 2 as well, evaluation of a produces an error, although there is no recursive definition involved:

```
LEVEL := 2: MAXLEVEL := 2: a
```

```
Error: Recursive definition: Reached maximal evaluation level.
```

```
delete LEVEL, MAXLEVEL:
```

### Example 3

This example shows the difference between the evaluation of identifiers on page 7-29 and local variables on page 7-56. By default, the value of LEVEL is 1 within a procedure, i.e., a global identifier is replaced by its value when evaluated, but there is no further recursive evaluation. This changes when LEVEL is assigned a bigger value inside the procedure:

```
delete a0, a1, a2, a3:  
a0 := a1 + a2: a1 := a2 + a3: a2 := a3^2 - 1: a3 := 5:  
p := proc()  
  save LEVEL;  
  begin  
    print(a0, eval(a0));  
    LEVEL := 2:  
    print(a0, eval(a0));  
  end_proc:
```

```
p()
```

```
a1 + a2, a32 + a3 + a2 - 1
```

```
a32 + a3 + a2 - 1, 53
```

In contrast, evaluation of a local variable replaces it by its value, without further evaluation. When `eval` is applied to an object containing a local variable, then the effect is an evaluation of the value of the local variable with substitution depth `LEVEL`:

```
q := proc()
  save LEVEL;
  local x;
  begin
    x := a0;
    print(x, eval(x));
    LEVEL := 2;
    print(x, eval(x));
  end_proc;
q()

a1 + a2, a32 + a3 + a2 - 1

a1 + a2, a32 + 28
```

The command `x:=a0` assigns the value of the identifier `a0`, namely the unevaluated expression `a1+a2`, to the local variable `x`, and `x` is replaced by this value every time it is evaluated, independent of the value of `LEVEL`.

## Example 4

`LEVEL` does not affect on evaluation of polynomials:

```
delete a, x: p := poly(a*x, [x]): a := 2: x := 3:
p, eval(p);
LEVEL := 1: p, eval(p);
delete LEVEL:
```

`poly(a x, [x]), poly(a x, [x])`

`poly(a x, [x]), poly(a x, [x])`

The same is true for arrays and tables:

```
delete a, b:  
A := array(1..2, [a, b]): T := table(a = b):  
a := 1: b := 2:  
A, eval(A), T, eval(T);  
LEVEL := 1: A, eval(A), T, eval(T);  
delete LEVEL:
```

$(a\ b), (a\ b), \overline{a|b}, \overline{a|b}$

$(a\ b), (a\ b), \overline{a|b}, \overline{a|b}$

## See Also

### MuPAD Functions

MAXDEPTH | MAXLEVEL | context | eval | hold | level | val

### Topics

“Level of Evaluation” (Symbolic Math Toolbox)

## level

Evaluate an object with a specified substitution depth

### Syntax

```
level(object)
```

```
level(object, n)
```

### Description

`level(object, n)` evaluates `object` with substitution depth `n`.

When a MuPAD object is evaluated, identifiers on page 7-29 occurring in it are replaced by their values. This happens recursively, i.e., if the values themselves contain identifiers, then these are replaced as well. `level` serves to evaluate an object with a specified recursion depth for this substitution process.

With `level(object, 0)`, `object` is evaluated without replacing any identifier on page 7-29 occurring in it by its value. In most cases, but not always, this equivalent to `hold(object)`, and `object` is returned unevaluated. See “Example 3” on page 1-1249 (Symbolic Math Toolbox).

With `level(object, 1)`, all identifiers on page 7-29 occurring in `object` are replaced by their values, but not recursively, and then all function calls in the result of the substitution are executed. This is how objects are evaluated within a procedure on page 7-45 by default.

The call `level(object)` is equivalent to `level(object, MAXLEVEL)`, i.e., identifiers occurring in `object` are recursively replaced by their values up to substitution depth `MAXLEVEL - 1`, and an error occurs if the substitution depth `MAXLEVEL` is reached. Usually, this leads to a complete evaluation of `object`. See “Example 1” on page 1-1247 (Symbolic Math Toolbox).

You can use `level` without a second argument to request the complete evaluation of an object not containing local variables or formal parameters within a procedure on page 7-

45. This may be necessary since by default, objects are evaluated with substitution depth 1 within procedures. See “Example 2” on page 1-1249 (Symbolic Math Toolbox).

Otherwise, it should never be necessary to use `level`.

---

**Note** `level` does not affect the evaluation of local variables and formal parameters, of type `DOM_VAR`, in procedures on page 7-45. When such a local variable occurs in object, then it is always replaced by its value, independent of the value of `n`, and the value is not further recursively evaluated. See “Example 2” on page 1-1249 (Symbolic Math Toolbox).

---

`level` works by temporarily setting the value of `LEVEL` to `n`, or to  $2^{31} - 1$  if `n` is not given. However, the value of `MAXLEVEL` remains unchanged. If the substitution depth `MAXLEVEL` is reached, then an error message is returned. See `LEVEL` and `MAXLEVEL` for more information on these environment variables.

In contrast to most other functions, `level` does not flatten (Symbolic Math Toolbox) its first argument if it is an expression sequence on page 1-88. See “Example 5” on page 1-1250 (Symbolic Math Toolbox).

`level` does not recursively descend into arrays, tables, matrices or polynomials. Use the call `map(object, eval)` to evaluate the entries of an array, a table, a matrix or `mapcoeffs(object, eval)` to evaluate the coefficients of a polynomial. See “Example 4” on page 1-1250 (Symbolic Math Toolbox) and “Example 6” on page 1-1251 (Symbolic Math Toolbox).

Further information concerning the evaluation of arrays, tables, matrices or polynomials can be found on the `eval` help page.

The maximal substitution depth of `level` depends on the environment variable `MAXLEVEL`, while the maximum evaluation depth of the function `eval` depends on the environment variable `LEVEL`. See “Example 7” on page 1-1251 (Symbolic Math Toolbox).

Because `eval` evaluates the result again there is a difference between evaluating an expression with depth `n` by `level` in comparison with `eval`. See “Example 7” on page 1-1251 (Symbolic Math Toolbox).

As mentioned `level` does not affect the evaluation of local variables and formal parameters, of type `DOM_VAR`, in procedures on page 7-45. Here `eval` behaves



different. See “Example 7” on page 1-1251 (Symbolic Math Toolbox) and the `eval` help page for more information.

The result of `level(hold(x))` is always `x`, because a full evaluation of `hold(x)` leads to `x`. The same does not hold for `eval(hold(x))`, because `eval` first evaluates its argument and then evaluates the result again.

The evaluation of elements of a user-defined domain (Symbolic Math Toolbox) depends on the implementation of the domain. Usually domain elements remain unevaluated by `level`. If the domain has a slot “evaluate”, the corresponding slot routine is called with the domain element as argument at each evaluation, and hence it is called once when `level` is invoked. Cf. “Example 8” on page 1-1253 (Symbolic Math Toolbox).

## Examples

### Example 1

We demonstrate the effect of `level` for various values of the second parameter:

```
delete a0, a1, a2, a3, a4, b: b := b + 1:
a0 := a1: a1 := a2 + 2: a2 := a3 + a4: a3 := a4^2: a4 := 5:
```

```
hold(a0), hold(a0 + a2), hold(b);
level(a0, 0), level(a0 + a2, 0), level(b, 0);
level(a0, 1), level(a0 + a2, 1), level(b, 1);
level(a0, 2), level(a0 + a2, 2), level(b, 2);
level(a0, 3), level(a0 + a2, 3), level(b, 3);
level(a0, 4), level(a0 + a2, 4), level(b, 4);
level(a0, 5), level(a0 + a2, 5), level(b, 5);
level(a0, 6), level(a0 + a2, 6), level(b, 6);
```

`a0, a0 + a2, b`

`a0, a0 + a2, b`

`a1, a1 + a3 + a4, b + 1`

$a^2 + 2, a^4 + a^2 + 7, b + 2$

$a^3 + a^4 + 2, a^3 + a^4 + 32, b + 3$

$a^4 + 7, a^4 + 37, b + 4$

$32, 62, b + 5$

$32, 62, b + 6$

Evaluating object by just typing object at the command prompt is equivalent to `level(object, LEVEL)`:

```
LEVEL := 2: MAXLEVEL := 4: a0, a2, b;  
level(a0, LEVEL), level(a2, LEVEL), level(b, LEVEL)
```

$a^2 + 2, a^4 + 5, b + 2$

$a^2 + 2, a^4 + 5, b + 2$

If the second argument is omitted, then this corresponds to a complete evaluation up to substitution depth `MAXLEVEL - 1`:

```
level(a0)
```

```
Error: Recursive definition: Reached maximal evaluation level.
```

```
level(a2)
```

30

```
level(b)
```

Error: Recursive definition: Reached maximal evaluation level.

```
delete LEVEL, MAXLEVEL:
```

## Example 2

We demonstrate the behavior of `level` in procedures:

```
delete a, b, c: a := b: b := c: c := 42:
p := proc()
  local x;
begin
  x := a:
  print(level(x, 0), x, level(x, 2), level(x)):
  print(level(a, 0), a, level(a, 2), level(a)):
end_proc:
p()
```

*b, b, b, b*

*a, b, c, 42*

Since `a` is evaluated with the default substitution depth 1, the assignment `x:=a` sets the value of the local variable `x` to the unevaluated identifier `b`. You can see that any evaluation of `x`, whether `level` is used or not, simply replaces `x` by its value `b`, but no further recursive evaluation happens. In contrast, evaluation of the identifier `a` takes place with the default substitution depth 1, and `level(a, 2)` evaluates it with substitution depth 2.

Thus `level` without a second argument can be used to request the complete evaluation of an object not containing any local variables or formal parameters.

## Example 3

There are some rare cases where `level(object, 0)` and `hold(object)` behaves different. This is the case if `object` is not an identifier, e.g., a nameless function, because `level` influences only the evaluation of identifiers:

```
level((x -> x^2)(2),0), hold((x -> x^2)(2))
```

4,  $(x \rightarrow x^2)(2)$

For the same reason `level(object, 0)` and `hold(object)` behave differently if `object` is a local variable of a procedure:

```
f:=proc() local x; begin
  x := 42;
  hold(x), level(x, 0);
end_proc:
f();
delete f:
```

DOM\_VAR(0, 2), 42

## Example 4

In contrast to lists on page 7-41 and sets on page 7-50, evaluation of an array on page 7-2 does not evaluate its entries. Thus `level` has no effect for arrays either. The same holds for tables on page 1-2103 and matrices on page 1-2045 (Symbolic Math Toolbox). Use `map` to evaluate all entries of an array. On the `eval` help page further examples can be found:

```
delete a, b:
L := [a, b]: A := array(1..2, L): a := 1: b := 2:
L, A, level(A), map(A, level), map(A, eval)
```

[1, 2], (a b), (a b), (a b), (1 2)

## Example 5

The first argument of `level` may be an expression sequence, which is not flattened. However, it must be enclosed in parentheses:

```
delete a, b: a := b: b := 3:
level((a, b), 1);
level(a, b, 1)
```

b, 3

Error: Invalid number of arguments. [level]

## Example 6

Polynomials are inert when evaluated, and so `level` has no effect:

```
delete a, x: p := poly(a*x, [x]): a := 2: x := 3:
p, level(p)
```

`poly(a x, [x]), poly(a x, [x])`

Use `mapcoeffs` and the function `eval` to evaluate all coefficients:

```
mapcoeffs(p, eval)
```

`poly(2 x, [x])`

If you want to substitute a value for the indeterminate `x`, use `evalp`:

```
delete x: evalp(p, x = 3)
```

`3 a`

As you can see, the result of an `evalp` call may contain unevaluated identifiers, and you can evaluate them by an application of `eval`. It is necessary to use `eval` instead of `level` because `level` does not evaluate its result:

```
eval(evalp(p, x = 3))
```

`6`

## Example 7

The subtle difference between `level` and `eval` is shown. The evaluation depth of `eval` is limited by the environment variable `LEVEL`. `level` pays no attention to `LEVEL`, but rather continues evaluating its argument either as many times as the second argument implies or until it has been evaluated completely:

```
delete a0, a1, a2, a3:
a0 := a1 + a2: a1 := a2 + a3: a2 := a3^2 - 1: a3 := 5:
LEVEL := 1:
eval(a0), level(a0);
```

$a3^2 + a3 + a2 - 1, 53$

If the evaluation depth exceeds the value of MAXLEVEL, an error is raised in both cases:

```
delete LEVEL:
MAXLEVEL := 3:
level(a0);
```

Error: Recursive definition: Reached maximal evaluation level.

```
delete LEVEL:
MAXLEVEL := 3:
eval(a0);
delete MAXLEVEL:
```

Error: Recursive definition: Reached maximal evaluation level.

It is not the same evaluating an expression `ex` with `eval` and an evaluation depth `n` and by `level((ex, n))`, because `eval` evaluates its result:

```
LEVEL := 2: eval(a0), level(a0, 2);
delete LEVEL:
```

$53, a3^2 + a3 + a2 - 1$

`level` does not affect the evaluation of local variables of type `DOM_VAR` while `eval` evaluates them with evaluation depth `LEVEL`, which is one in a procedure:

```
p := proc()
  local x;
begin
  x := a0:
  print(eval(x), level(x)):
end_proc:
p()
```

$$a^3 + a^3 + a^2 - 1, a^1 + a^2$$

## Example 8

The evaluation of an element of a user-defined domain (Symbolic Math Toolbox) depends on the implementation of the domain. Usually it is not further evaluated:

```
delete a: T := newDomain("T"):
e := new(T, a): a := 1:
e, level(e), map(e, level), val(e)
```

$$\text{new}(T, a), \text{new}(T, a), \text{new}(T, a), \text{new}(T, a)$$

If the slot "evaluate" exists, the corresponding slot routine is called for a domain element each time it is evaluated. We implement the routine `T::evaluate`, which simply evaluates all internal operands of its argument, for our domain T. The unevaluated domain element can still be accessed via `val`:

```
T::evaluate := x -> new(T, eval(extop(x))):
e, level(e), map(e, level), val(e);
```

$$\text{new}(T, 1), \text{new}(T, 1), \text{new}(T, 1), \text{new}(T, a)$$

```
delete e, T:
```

## Parameters

### object

Any MuPAD object

### n

A nonnegative integer on page 7-31 less than  $2^{31}$

## **Return Values**

Evaluated object.

## **See Also**

### **MuPAD Functions**

LEVEL | MAXLEVEL | context | eval | hold | indexval | val

## **Topics**

“Level of Evaluation” (Symbolic Math Toolbox)



# lhs

Left side of equations, inequalities, relations, intervals, ranges and tables

## Syntax

`lhs(f)`

## Description

`lhs(f)` returns the left side of `f`.

The call `lhs(f)` is equivalent to the direct call `op(f, 1)`, of the operand function `op`, if `f` is not a table.

If `t` is a table, the call `lhs(t)` returns the list of keys of the table (left side). Note that the `i`th value in `rhs(t)` corresponds to the `i`th key in `lhs(t)`.

## Examples

### Example 1

Extract the left sides of various objects:

```
lhs(x = sin(2)), lhs(3.14 <> PI), lhs(x + 3 < 2*y)
```

```
x, 3.14, x + 3
```

The operands of an expression depend on its internal representation. In particular, a “greater” relation is always converted to the corresponding “less” relation:

```
y > -infinity;
lhs(y > -infinity)
```

```
-∞ < y
```

$-\infty$

```
y >= 4;  
lhs(y >= 4)
```

$4 \leq y$

4

## Example 2

Extract the left sides of the solution of the following system:

```
s := solve({x + y = 1, 2*x - 3*y = 2})
```

$\{[x = 1, y = 0]\}$

```
map(op(s), lhs)
```

$[x, y]$

Calls to `lhs` can be easier to read than the equivalent calls to the operand function `op`:

```
map(op(s), op, 1)
```

$[x, y]$

However, direct calls to `op` must be preferred inside procedures for higher efficiency.

```
delete s:
```

## Example 3

Extract the keys (left side) and values (right side) from a table:

```
t := table(1=2, 4=PI, 5=5.6, 19=1/2):
l := lhs(t);
```

[1, 4, 5, 19]

```
r := rhs(t);
```

$\left[2, \pi, 5.6, \frac{1}{2}\right]$

Note that the *i*th value corresponds to the *i*th key:

```
bool(r = map(lhs(t), e->t[e]))
```

TRUE

```
delete t,l,r;
```

## Parameters

**f**

An equation  $x = y$ , an inequality  $x <> y$ , a relation  $x < y$ , a relation  $x <= y$ , an “is element of”-relation  $x \text{ in } y$ , an interval  $x \dots y$ , a range  $x \dots y$ , or a table  $\text{table}(x=y, \dots)$ .

## Return Values

arithmetical expression (Symbolic Math Toolbox).

## Overloaded By

**f**

## See Also

**MuPAD Functions**  
isolate | op | rhs

# rhs

Right side of equations, inequalities, relations, intervals, ranges and tables

## Syntax

`rhs(f)`

## Description

`rhs(f)` returns the right side of `f`.

The call `rhs(f)` is equivalent to the direct call `op(f, 2)`, of the operand function `op`, if `f` is not a table.

If `t` is a table, the call `rhs(t)` returns the list of values of the table (right side). Note that the `i`th value in `rhs(t)` corresponds to the `i`th key in `lhs(t)`.

## Examples

### Example 1

Extract the right sides of various objects:

```
rhs(a <= b), rhs(m-1..n+1)
```

$b, n + 1$

The operands of an expression depend on its internal representation. In particular, a “greater” relation is always converted to the corresponding “less” relation:

```
y > -infinity;
rhs(y > -infinity)
```

$-\infty < y$

$y$

```
y >= 4;  
rhs(y >= 4)
```

$4 \leq y$

$y$

## Example 2

Extract the right sides of the solution of the following system:

```
s := solve({x + y = 1, 2*x - 3*y = 2})
```

$\{[x = 1, y = 0]\}$

```
map(op(s), rhs)
```

$[1, 0]$

Calls to `rhs` can be easier to read than the equivalent calls to the operand function `op`:

```
map(op(s), op, 2)
```

$[1, 0]$

However, direct calls to `op` must be preferred inside procedures for higher efficiency.

```
delete s:
```

## Example 3

Extract the keys (left side) and values (right side) from a table:

```
t := table(1=2, 4=PI, 5=5.6, 19=1/2):
l := lhs(t);
```

```
[1, 4, 5, 19]
```

```
r := rhs(t);
```

```
[2, pi, 5.6, 1/2]
```

Note that the *i*th value corresponds to the *i*th key:

```
bool(r = map(lhs(t), e->t[e]))
```

```
TRUE
```

```
delete t,l,r:
```

## Parameters

**f**

An equation  $x = y$ , an inequality  $x <> y$ , a relation  $x < y$ , a relation  $x <= y$ , an “is element of”-relation  $x \text{ in } y$ , an interval  $x \dots y$ , a range  $x \dots y$ , or a table  $\text{table}(x=y, \dots)$

## Return Values

arithmetical expression (Symbolic Math Toolbox).

## Overloaded By

**f**

## See Also

**MuPAD Functions**  
isolate | lhs | op



# Li

Integral logarithm

## Syntax

`Li(x)`

## Description

`Li(x)` represents the integral logarithm  $\int_0^x \frac{1}{\ln(t)} dt$ .

Note that in some places in the literature, the notation `li` is used while `Li` is reserved for the offset logarithmic integral  $\int_2^x \frac{1}{\ln(t)} dt$ . The latter may be obtained by entering `Li(x) - Li(2)`.

Further, do not confuse the integral logarithm `Li` with the polylogarithms `polylog` which are displayed on the screen as  $Li_n$  (with an index).

If `x` is a floating-point number, then `Li(x)` returns the numerical value of the integral logarithm. The special values  $Li(0) = 1$  and  $Li(1) = -\infty$  are implemented. For all other arguments, `Li` returns a symbolic function call.

For all complex numbers `z`, the identity  $Li(z) = Ei(\ln(z))$  holds.

The continuation of `Li` to the complex plane is chosen such that the resulting function is analytic with a singularity at 1 and a branch cut on the real axis left to that singularity; such that  $\text{conjugate}(Li(z)) = Li(\text{conjugate}(z))$  holds for non-real `z`; and such that `Li` is continuous from above on the negative real axis. Between 0 and 1, `Li` is real and thus neither continuous from above nor from below.

## Environment Interactions

When called with a floating-point argument, the function is sensitive to the environment variable DIGITS which determines the numerical working precision.

## Examples

### Example 1

For symbolic arguments, `Li` returns a symbolic function call in most cases:

```
Li(I), Li(0), Li(2), Li(x)
```

```
Li(i), 0, Li(2), Li(x)
```

### Example 2

The integral logarithm of a large real number approximately equals the number of primes below that number:

```
numlib::pi(123456789), Li(123456789.0)
```

```
7027260, 7028122.595
```

Riemann suggested to use the approximation  $\sum_{i=1}^{\infty} \text{Li}\left(x^{1/i}\right) \text{numlib::moebius}(i)$ . This often gives a slightly better result, but it suffices to sum this series up to  $i=2$ :

```
R:= (x, n) -> _plus(float(Li(x^(1/i))) * numlib::moebius(i) $i=1..n):  
for j from 1 to 9 do  
  print(numlib::pi(10^j), float(Li(10^j)), R(10^j, 2), R(10^j, 50))  
end_for:  
delete j, R:
```

```
4, 6.165599505, 3.857761291, 5.065725444
```

25, 30.12614158, 23.96054208, 21.04138706

168, 177.609658, 164.1135957, 156.8772935

1229, 1246.137216, 1216.011074, 1202.985411

9592, 9629.809001, 9558.64347, 9536.769885

78498, 78627.54916, 78449.9395, 78413.40907

664579, 664918.405, 664455.4442, 664393.3058

5761455, 5762209.375, 5760963.238, 5760854.674

50847534, 50849234.96, 50845801.05, 50845606.04

## Parameters

x

An arithmetical expression (Symbolic Math Toolbox)

## Return Values

Arithmetical expression.

## Overloaded By

x

## See Also

### MuPAD Functions

Ci | Ei | Shi | Si | Ssi | int | ln

# READPATH

Search path for the command ' Read '

## Description

READPATH determines the directories, where the function `read` searches for files.

Possible values: String or a sequence of strings.

The variable `READPATH` can represent more than one search directory. This variable can be assigned a sequence of strings: each element of the sequence represents a directory in which files are search for.

---

**Note** When concatenated with a file name, the directories given by the path variables must produce valid path names.

---

Path names are slightly system dependent. You can separate subdirectories with a `/` on all systems. On Windows systems, you may alternatively use a backslash character (`\`).

Note that in MuPAD, a single backslash inside a character string is created by typing two backslashes. E.g., the MuPAD string representing the path "C:\Programs\MuPAD" must be defined by "C:\\Programs\\MuPAD".

The function `pathname` allows to create path names independent of the current operating system.

## Examples

### Example 1

This example shows how to define a `READPATH`. More than one path may be given. `read` will look for files to be opened in the directories given by `READPATH`. The following produces a valid `READPATH` for UNIX and Linux® systems only, since the path separators are hard coded in the strings:

```
READPATH := "math/lib/", "math/local/"
```

```
"math/lib/", "math/local/"
```

It is good programming style to use platform independent path strings. This can be achieved with the function `pathname`:

```
READPATH := pathname("math", "lib"),  
            pathname("math", "local")
```

```
"math/lib/", "math/local/"
```

All path variables can be set to their default values by deleting them:

```
delete READPATH:
```

## Example 2

The path variable `WRITEPATH` only accepts one path string:

```
WRITEPATH := "math/lib/", "math/local/"
```

```
Error: Invalid argument. [WRITEPATH]
```

## See Also

### MuPAD Functions

FILEPATH | NOTEBOOKFILE | NOTEBOOKPATH | WRITEPATH | fclose | finput | fopen |  
fprint | fread | ftextinput | pathname | print | protocol | read | write

# WRITEPATH

Search path for the command ' Write ' et al.

## Description

Possible values: String or a sequence of strings.

WRITEPATH determines the directory, into which the functions `fopen`, `fprint`, `write`, and `protocol` write files which are not specified with a full (absolute) pathname. If WRITEPATH is not defined, then the files are written into the "working directory".

Note that the "working directory" depends on the operating system. On Windows systems, it is the folder where MuPAD is installed. On UNIX or Linux systems, the "working directory" is the directory where MuPAD was started.

---

**Note** When concatenated with a file name, the directories given by the path variables must produce valid path names.

---

Path names are slightly system dependent. You can separate subdirectories with a / on all systems. On Windows systems, you may alternatively use a backslash character (\).

Note that in MuPAD, a single backslash inside a character string is created by typing two backslashes. E.g., the MuPAD string representing the path "math\lib\" must be defined by "math\\lib\\".

The function `pathname` allows to create path names independent of the current operating system.

## Examples

### Example 1

This example shows how to define a READPATH. More than one path may be given. `read` will look for files to be opened in the directories given by READPATH. The following

produces a valid READPATH for UNIX and Linux systems only, since the path separators are hard coded in the strings:

```
READPATH := "math/lib/", "math/local/"  
  
"math/lib/", "math/local/"
```

It is good programming style to use platform independent path strings. This can be achieved with the function pathname:

```
READPATH := pathname("math", "lib"),  
             pathname("math", "local")  
  
"math/lib/", "math/local/"
```

All path variables can be set to their default values by deleting them:

```
delete READPATH:
```

## Example 2

The path variable WRITEPATH only accepts one path string:

```
WRITEPATH := "math/lib/", "math/local/"
```

```
Error: Invalid argument. [WRITEPATH]
```

## See Also

### MuPAD Functions

FILEPATH | NOTEBOOKFILE | NOTEBOOKPATH | READPATH | fclose | finput | fopen |  
fprint | fread | ftextinput | pathname | print | protocol | read | write



# limit

Compute a limit

## Syntax

`limit(f, x, <Left | Right | Real>, <Intervals>, <NoWarning>)`

`limit(f, x = x0, <Left | Right | Real>, <Intervals>, <NoWarning>)`

## Description

`limit(f, x = x0, Real)` computes the bidirectional limit  $\lim_{x \rightarrow x_0} f(x)$ ,  $x - x_0 \in \mathbb{R} \setminus \{0\}$ .

`limit(f, x = x0, Left | Right)` computes the one-sided limit  $\lim_{x \rightarrow x_0^-} f(x)$ ,

$\lim_{x \rightarrow x_0^+} f(x)$  respectively.

`limit(f, x = x0, Intervals)` computes a set containing all accumulation points of

$\lim_{x \rightarrow x_0} f(x)$ ,  $x - x_0 \in \mathbb{R} \setminus \{0\}$ .

`limit(f, x = x0, <Real>)` computes the bidirectional limit of  $f$  when  $x$  tends to  $x_0$  on the real axis. The limit point  $x_0$  may be omitted, in which case `limit` assumes  $x_0 = 0$ .

If the limit point  $x_0$  is *infinity* or  $-\infty$ , then the limit is taken from the left to *infinity* or from the right to  $-\infty$ , respectively.

If provably no limit exists, then `undefined` is returned. See “Example 2” on page 1-1273 (Symbolic Math Toolbox).

`limit(f, x = x0, Left)` returns the limit when  $x$  tends to  $x_0$  from the left.  
`limit(f, x = x0, Right)` returns the limit when  $x$  tends to  $x_0$  from the right. See “Example 2” on page 1-1273 (Symbolic Math Toolbox).

If it cannot be determined whether a limit exist, or cannot determine its value, then a symbolic `limit` is returned. See “Example 3” on page 1-1274 (Symbolic Math Toolbox). The same holds, in case the option `Intervals` is given, if no information on the set of accumulation points could be obtained.

If  $f$  contains parameters, then `limit` reacts to properties (Symbolic Math Toolbox) of those parameters set by `assume`. See “Example 5” on page 1-1274 (Symbolic Math Toolbox). It may also return a case analysis (`piecewise`) depending on these parameters.

You can compute the limit of a piecewise function. The conditions you use to define a piecewise function can depend on the limit variable. See “Example 6” on page 1-1275 (Symbolic Math Toolbox).

Internally, `limit` tries to determine the limit from a series expansion of  $f$  around  $x = x_0$  computed via `series`. It may be necessary to increase the value of the environment variable `ORDER` in order to find the limit.

---

**Note** `limit` works on a symbolic level and should not be called with arguments containing floating point arguments on page 7-23.

---

## Environment Interactions

The function is sensitive to the environment variable `ORDER`, which determines the default number of terms in series computations (see `series`).

Properties (Symbolic Math Toolbox) of identifiers set by `assume` are taken into account.

## Examples

### Example 1

The following command computes  $\lim_{x \rightarrow 0} \frac{1 - \cos(x)}{x^2}$ :

```
limit((1 - cos(x))/x^2, x)
```

$$\frac{1}{2}$$

A possible definition of  $e$  is given by the limit of the sequence  $\left(1 + \frac{1}{n}\right)^n$  for  $n \rightarrow \infty$ :

```
limit((1 + 1/n)^n, n = infinity)
```

$e$

Here is a more complex example:

```
limit(
  (exp(x*exp(-x))/(exp(-x) + exp(-2*x^2/(x+1)))) - exp(x))/x,
  x = infinity
)
```

$$-e^2$$

## Example 2

The bidirectional limit of  $f(x) = \frac{1}{x}$  for  $x \rightarrow 0$  does not exist:

```
limit(1/x, x = 0)
```

undefined

You can compute the one-sided limits from the left and from the right by passing the options `Left` and `Right`, respectively:

```
limit(1/x, x = 0, Left),
limit(1/x, x = 0, Right)
```

$-\infty, \infty$

### Example 3

If `limit` is not able to compute the limit, then a symbolic `limit` call is returned:

```
delete f: limit(f(x), x = infinity)
```

$$\lim_{x \rightarrow \infty} f(x)$$

### Example 4

The function  $\sin(x)$  oscillates for  $x \rightarrow \infty$  between -1 and 1; no accumulation points outside that interval exist:

```
limit(sin(x), x = infinity, Intervals)
```

$$[-1, 1]$$

In fact, all elements of the interval returned are accumulation points. This need not be the case in general. In the following example, the limit inferior and the limit superior are in fact  $-\sqrt{2}$  and  $\sqrt{2}$ , respectively:

```
limit(sin(1/x) + cos(1/x), x = 0, Intervals)
```

$$[-\sqrt{2}, \sqrt{2}]$$

### Example 5

`limit` is not able to compute the limit of  $x^n$  for  $x \rightarrow \infty$  without additional information about the parameter  $n$ :

```
assume(n in R_):  
limit(x^n, x = infinity)
```

$$\begin{cases} 1 & \text{if } n = 0 \\ \infty & \text{if } 0 < n \\ 0 & \text{if } n < 0 \end{cases}$$

We can also assume immediately that  $n > 0$  and get no case analysis then:

```
assume(n > 0): limit(x^n, x = infinity)
```

$\infty$

Similarly, we can assume that  $n < 0$ :

```
assume(n < 0): limit(x^n, x = infinity)
```

0

```
delete n:
```

## Example 6

Compute limit of the piecewise function:

```
limit(piecewise([x^3 > 10000*x, 1/x],
                [x^3 <= 10000*x, 10]),
      x = infinity)
```

0

## Example 7

Compute limits of the incomplete Gamma function:

```
limit(igamma(z, t), t = infinity);
limit(igamma(z, t), t = 0)
```

0

$\Gamma(z)$

## Parameters

**f**

An arithmetical expression (Symbolic Math Toolbox) representing a function in  $x$

**x**

An identifier on page 7-29

**$x_0$**

The limit point: an arithmetical expression (Symbolic Math Toolbox), possibly `infinity` or `-infinity`

## Options

### Left, Real, Right

This controls the direction of the limit computation. The option `Real` is the default case and means the bidirectional limit (i.e., there is no need to specify this option).

### Intervals

Either `TRUE` or `FALSE`, by default `FALSE`. If this option is set to `TRUE`, then a superset of the set of all accumulation points is returned. If the result contains only one element, that element is the limit; on the other hand, if it contains more elements, not all of them are necessarily accumulation points, such that the limit may nevertheless exist.

### NoWarning

If this option is set to `TRUE`, no warning messages are printed on the screen. Default is `FALSE`.

## Return Values

arithmetical expression (Symbolic Math Toolbox). If the option `Intervals` was given, the result is a (finite or infinite) set.

## Overloaded By

f

## Algorithms

limit uses an algorithm based on the thesis of Dominik Gruntz: “On Computing Limits in a Symbolic Manipulation System”, Swiss Federal Institute of Technology, Zurich, Switzerland, 1995. If this fails, it tries to proceed recursively; finally, it attempts a series expansion.

## See Also

### MuPAD Functions

0 | asympt | diff | discontin | int | series | taylor

## Topics

“Compute Bidirectional Limits” (Symbolic Math Toolbox)

“Compute Right and Left Limits” (Symbolic Math Toolbox)

“If Limits Do Not Exist” (Symbolic Math Toolbox)

# linsolve

Solve a system of linear equations

## Syntax

```
linsolve(eqs, options)
```

```
linsolve(eqs, vars, options)
```

## Description

`linsolve(eqs, vars)` solves a system of linear equations with respect to the unknowns `vars`.

`linsolve(eqs, < vars , < ShowAssumptions >>)` solves the linear system `eqs` with respect to the unknowns `vars`. If no unknowns are specified, then `linsolve` solves for all indeterminates in `eqs`; the unknowns are determined internally by `indets(eqs, PolyExpr)`.

`linsolve(eqs, vars, Domain = R)` solves the system over the domain (Symbolic Math Toolbox) `R`, which must be a field, i.e., a domain of category `Cat::Field`.

---

**Note** Note that the return format does not allow to return kernel elements if elements of the domain `R` cannot be multiplied with the symbolic unknowns that span the kernel. In such a case, `linsolve` issues a warning and returns only a special solution. The kernel can be computed via `linalg::matlinsolve` for any field `R`.

---

Each element of `eqs` must be either an equation or an arithmetical expression (Symbolic Math Toolbox) `f`, which is considered to be equivalent to the equation  $f = 0$ .

The unknowns in `vars` need not be identifiers on page 7-29 or indexed identifiers; expressions such as  $\sin(x)$ ,  $f(x)$ , or  $y^{1/3}$  are allowed as well. More generally, any expression accepted as indeterminate by `poly` is a valid unknown.

If the option `ShowAssumptions` is not given and the system is solvable, then the return value is a list of equations of the form `var = value`, where `var` is one of the unknowns



in `vars` and `value` is an arithmetical expression (Symbolic Math Toolbox) that does not involve any of the unknowns on the left side of a returned equation. Note that if the solution manifold has dimension greater than zero, then some of the unknowns in `vars` will occur on the right side of some returned equations, representing the degrees of freedom. See “Example 2” on page 1-1281 (Symbolic Math Toolbox).

If `vars` is a list on page 7-41, then the solved equations are returned in the the same order as the unknowns in `vars`.

The function `linsolve` can only solve systems of linear equations. Use `solve` for nonlinear equations.

`linsolve` is an interface function to the procedures `numeric::linsolve` and `linalg::matlinsolve`. For more details see the `numeric::linsolve`, `linalg::matlinsolve` help pages and the background section of this help page.

The system `eqs` is checked for linearity. Since such a test can be expensive, it is recommended to use `numeric::linsolve` or `linalg::matlinsolve` directly when you know that the system is linear.

---

**Note** `linsolve` does *not* react to properties (Symbolic Math Toolbox) of identifiers set by `assume`.

---

## Examples

### Example 1

Equations and variables may be entered as sets or lists:

```
linsolve({x + y = 1, 2*x + y = 3}, {x, y}),  
linsolve({x + y = 1, 2*x + y = 3}, [x, y]),  
linsolve([x + y = 1, 2*x + y = 3], {x, y}),  
linsolve([x + y = 1, 2*x + y = 3], [x, y])
```

```
[x = 2, y = -1], [x = 2, y = -1], [x = 2, y = -1], [x = 2, y = -1]
```

Also expressions may be used as variables:

```
linsolve({cos(x) + sin(x) = 1, cos(x) - sin(x) = 0},  
         {cos(x), sin(x)})
```

$$\left[ \cos(x) = \frac{1}{2}, \sin(x) = \frac{1}{2} \right]$$

Furthermore, indexed identifiers are valid, too:

```
S := linsolve({2*a[1] + 3*a[2] = 5, 7*a[2] + 11*a[3] = 13,  
             17*a[3] + 19*a[1] = 23}, {a[1], a[2], a[3]})
```

$$\left[ a_1 = \frac{691}{865}, a_2 = \frac{981}{865}, a_3 = \frac{398}{865} \right]$$

Assign individual solutions to variables using `assign`. Alternatively, access the solution by indexing into `S`:

```
assign(S):  
a[1];  
a2_val := S[2][2];
```

$$\frac{691}{865}$$

$$\frac{981}{865}$$

Delete `a` for use in further computations.

```
delete a;
```

Next, we demonstrate the use of option `Domain` and solve a system over the field  $\mathbb{Z}_{23}$  with it:

```
linsolve([2*x + y = 1, -x - y = 0],  
         Domain = Dom::IntegerMod(23))
```

$$[x = 1 \text{ mod } 23, y = 22 \text{ mod } 23]$$

The following system does not have a solution:

```
linsolve({x + y = 1, 2*x + 2*y = 3}, {x, y})
```

FAIL

## Example 2

If the solution of the linear system is not unique, then some of the unknowns are used as “free parameters” spanning the solution space. In the following example the unknown  $z$  is such a parameter. It does not appear on the left side of the solved equations:

```
eqs := [x + y = z, x + 2*y = 0, 2*x - z = -3*y, y + z = 0]:
```

```
vars := [w, x, y, z]:
```

```
linsolve(eqs, vars)
```

$[x = 2z, y = -z]$

## Example 3

If you use the `Normal` option, `linsolve` calls the `normal` function for final results. This call ensures that `linsolve` returns results in normalized form:

```
linsolve([x + a*y = a + 1, b*x - y = b - 1], {x, y})
```

$[x = 1, y = 1]$

If you specify `Normal = FALSE`, `linsolve` does not call `normal` for the final result:

```
linsolve([x + a*y = a + 1, b*x - y = b - 1], {x, y}, Normal = FALSE)
```

$$\left[ x = a - \frac{a(b(a+1) - b + 1)}{ab + 1} + 1, y = \frac{b(a+1) - b + 1}{ab + 1} \right]$$

## Example 4

Solve this system:

```
eqs := [x + a*y = b, x + A*y = b]:
```

```
linsolve(eqs, [x, y])
```

```
[x = b, y = 0]
```

Note that more solutions exist for  $a = A$ . `linsolve` omits these solutions because it makes some additional assumptions on symbolic parameters of this system. To see the assumptions that `linsolve` made while solving this system, use the `ShowAssumptions` option:

```
linsolve(eqs, [x, y], ShowAssumptions)
```

```
[[x = b, y = 0], [], [A - a ≠ 0]]
```

```
delete eqs:
```

## Parameters

### **eqs**

A list on page 7-41 or a set on page 7-50 of linear equations or arithmetical expressions (Symbolic Math Toolbox)

### **vars**

A list on page 7-41 or a set on page 7-50 of unknowns to solve for: typically identifiers on page 7-29 or indexed identifiers on page 1-1017

## Options

### **Domain**

Option, specified as `Domain = R`

Solve the system over the field  $R$ , which must be a domain (Symbolic Math Toolbox) of category `Cat::Field`.

## Normal

Option, specified as `Normal = b`

Return normalized results. The value `b` must be `TRUE` or `FALSE`. By default, `Normal = TRUE`, meaning that `linsolve` guarantees normalization of the returned results. Normalizing results can be computationally expensive.

By default, `linsolve` calls `normal` before returning results. This option affects the output only if the solution contains variables or exact expressions, such as `sqrt(5)` or `sin(PI/7)`.

To avoid this additional call, specify `Normal = FALSE`. In this case, `linsolve` also can return normalized results, but does not guarantee such normalization. See “Example 3” on page 1-1281 (Symbolic Math Toolbox).

## ShowAssumptions

Return information about internal assumptions that `linsolve` made on symbolic parameters in `eqs`.

With this option, `linsolve` returns a list `[Solution, Constraints, Pivots]`. `Solution` is a list of solved equations representing the complete solution manifold of `eqs`, as described above. The lists `Constraints` and `Pivots` contain equations and inequalities involving symbolic parameters in `eqs`. Internally, these were assumed to hold true when solving the system. See “Example 4” on page 1-1281 (Symbolic Math Toolbox).

When Gaussian elimination produces an equation  $0 = c$  with nonzero  $c$ , `linsolve` without `ShowAssumptions` returns `FAIL`. If  $c$  involves symbolic parameters, try using `linsolve` with `ShowAssumptions` to solve such systems. If the system is solvable, you will get the solution. In this case, an equation  $0 = c$  is returned in the `Constraints` list. If the system is not solvable, `linsolve` with `ShowAssumptions` returns `[FAIL, [], []]`.

## Return Values

Without the `ShowAssumptions` option, a list of simplified equations is returned. It represents the general solution of the system `eqs`. `FAIL` is returned if the system is not solvable.

With `ShowAssumptions`, a list `[Solution, Constraints, Pivots]` is returned. `Solution` is a list of simplified equations representing the general solution of `eqs`. The lists `Constraints` and `Pivots` contain equations and inequalities involving symbolic parameters in `eqs`. Internally, these were assumed to hold true when solving the system.

## Algorithms

If the option `Domain` is not present, the system is solved by calling `numeric::linsolve` with the option `Symbolic`.

If the option `Domain = R` is given and `R` is either `Dom::ExpressionField()` or `Dom::Float`, then `numeric::linsolve` is used to compute the solution of the system. This function uses a sparse representation of the equations.

Otherwise, `eqs` is first converted into a matrix and then solved by `linalg::matlinsolve`. A possibly sparse structure of the input system is not taken into account.

## See Also

### MuPAD Functions

`isolate` | `linalg::matlinsolve` | `numeric::linsolve` | `solve`

## Topics

“Solve Algebraic Systems” (Symbolic Math Toolbox)

# lllint

Compute an LLL-reduced basis of a lattice

## Syntax

```
lllint(A)
```

## Description

`lllint(A)` applies the LLL algorithm to the list of integer vectors  $A$ .

`lllint` applies the LLL algorithm to the entries of the list  $A$ . The entries of  $A$  must be lists of integers, all of the same length; the number of lists need not equal that length.

The return value of `lllint` has the same form.

The computations are done entirely with integers and are both accurate and quite fast.

## Examples

### Example 1

We apply the LLL algorithm to a list of two vectors of length three:

```
A := [[1, 2, 3], [4, 5, 6]]:  
lllint(A)
```

```
[[2, 1, 0], [-1, 1, 3]]
```

The result is to be interpreted as follows: the two vectors in the output form an LLL-reduced basis of the lattice generated by the two vectors in the input.

## Example 2

If the input vectors are not linearly independent, FAIL is returned:

```
lllint([[1, 2], [2, 4]])
```

FAIL

## Parameters

**A**

A list on page 7-41 of vectors, each being a list of integers on page 7-31

## Return Values

list on page 7-41 of lists is returned whose entries form an LLL-reduced basis of the lattice spanned by the entries of A. If the entries of A are not linearly independent, FAIL is returned.

## Algorithms

A. K. Lenstra, H. W. Lenstra Jr., and L. Lovasz, Factoring polynomials with rational coefficients. *Math. Ann.* 261, 1982, pp. 515-534.

Joachim von zur Gathen and Jürgen Gerhard, *Modern Computer Algebra*. Cambridge University Press, 1999, Chapter 16.

George L. Nemhauser and Laurence A. Wolsey, *Integer and Combinatorial Optimization*. New York, Wiley, 1988.

A. Schrijver, *Theory of Linear and Integer Programming*. New York, Wiley, 1986.



## See Also

### **MuPAD Functions**

`linalg::basis` | `linalg::factorLU` | `linalg::factorQR` | `linalg::gaussElim` |  
`linalg::hermiteForm` | `linalg::orthog`

# lmonomial

Leading monomial of a polynomial

## Syntax

```
lmonomial(p, <order>, <Rem>)
```

```
lmonomial(f, <vars>, <order>, <Rem>)
```

## Description

`lmonomial(p)` returns the leading monomial of the polynomial `p`.

The returned monomial is “leading” with respect to the lexicographical ordering, unless a different ordering is specified via the argument `order`. Cf. “Example 1” on page 1-1288 (Symbolic Math Toolbox).

The leading monomial of the zero polynomial is the zero polynomial.

A polynomial expression `f` is first converted to a polynomial with the variables given by `vars`. If no variables are given, they are searched for in `f`. See `poly` about details of the conversion. The result is returned as polynomial expression. FAIL is returned if `f` cannot be converted to a polynomial. Cf. “Example 4” on page 1-1290 (Symbolic Math Toolbox).

The result of `lmonomial` is not fully evaluated. It can be evaluated by the functions `mapcoeffs` and `eval`. Cf. “Example 3” on page 1-1289 (Symbolic Math Toolbox).

## Examples

### Example 1

We demonstrate how various orderings influence the result:

```
p := poly(5*x^4 + 4*x^3*y*z^2 + 3*x^2*y^3*z + 2, [x, y, z]):
lmonomial(p), lmonomial(p, DegreeOrder),
lmonomial(p, DegInvLexOrder)
```

$$\text{poly}(5x^4, [x, y, z]), \text{poly}(4x^3yz^2, [x, y, z]), \text{poly}(3x^2y^3z, [x, y, z])$$

The following call uses the reverse lexicographical order on page 7-309 on 3 indeterminates:

```
lmonomial(p, Dom::MonomOrdering(RevLex(3)))
```

$$\text{poly}(3x^2y^3z, [x, y, z])$$

```
delete p:
```

## Example 2

We compute the reductum of a polynomial:

```
p := poly(2*x^2*y + 3*x*y^2 + 6, [x, y]):
q := lmonomial(p, Rem)
```

$$[\text{poly}(2x^2y, [x, y]), \text{poly}(3xy^2 + 6, [x, y])]$$

The leading monomial and the reductum add up to the polynomial p:

```
p = q[1] + q[2]
```

$$\text{poly}(2x^2y + 3xy^2 + 6, [x, y]) = \text{poly}(2x^2y + 3xy^2 + 6, [x, y])$$

```
delete p, q:
```

## Example 3

We demonstrate the evaluation strategy of lmonomial:

```
p := poly(6*x^6*y^2 + x^2 + 2, [x]): y := 4: lmonomial(p)
```

```
poly((6 y^2) x^6, [x])
```

Evaluation is enforced by `eval`:

```
mapcoeffs(%, eval)
```

```
poly(96 x^6, [x])
```

```
delete p, y:
```

## Example 4

The expression  $1/x$  may not be regarded as polynomial:

```
lmonomial(1/x)
```

```
FAIL
```

## Parameters

**p**

A polynomial (Symbolic Math Toolbox) of type `DOM_POLY`

**f**

A polynomial expression (Symbolic Math Toolbox)

**vars**

A list on page 7-41 of indeterminates of the polynomial: typically, identifiers on page 7-29 or indexed identifiers on page 1-1017

**order**

The term ordering: either `LexOrder` or `DegreeOrder` or `DegInvLexOrder` or a user-defined term ordering of type `Dom::MonomOrdering`. The default is the lexicographical ordering `LexOrder`.

## Options

### Rem

Makes `lmonomial` return a list with two polynomials: the leading monomial and the reductum. The reductum of a polynomial  $p$  is  $p - \text{lmonomial}(p)$ .

## Return Values

Polynomial of the same type as  $p$ . An expression is returned if an expression is given as input. FAIL is returned if the input cannot be converted to a polynomial. With `Rem`, a list of two polynomials is returned.

## Overloaded By

$p$

## See Also

### MuPAD Functions

`coeff` | `degree` | `degreevec` | `ground` | `lcoeff` | `ldegree` | `lterm` | `monomials` | `nterms` | `nthcoeff` | `nthmonomial` | `nthterm` | `poly` | `poly2list` | `tcoeff`

# ln

Natural logarithm

---

**Note** For the `ln` function in MATLAB®, see `log`.

---

## Syntax

`ln(x)`

## Description

`ln(x)` represents the natural logarithm of  $x$ .

Natural logarithm is defined for all complex arguments  $x \neq 0$ .

`ln` applies the following simplification rules to its arguments:

- If  $x$  is of the type `Type::Numeric`, then  $\ln(e^x) = x + k i 2 \pi$ . Here  $k$  is an integer, such that the imaginary part of the result lies in the interval  $(-\pi, \pi]$ . Similar simplifications occur for  $(e^y)^a$ .
- If  $x$  is a negative integer or a negative rational, then  $\ln(x) = i \pi + \ln(-x)$ .
- If  $x$  is an integer, then  $\ln\left(\frac{1}{x}\right) = -\ln(x)$ .
- `ln` uses the following special values:

$$\ln(1) = 0, \ln(-1) = i \pi, \ln(i) = \frac{i \pi}{2}, \ln(-i) = -\frac{i \pi}{2}, \ln(\infty) = \infty, \ln(-\infty) = i \pi + \infty.$$

For exact numeric and symbolic arguments, `ln` typically returns unresolved function calls.

If an argument is a floating-point value, `ln` returns a floating-point result. The imaginary part of the result takes values in the interval  $(-\pi, \pi]$ . The negative real axis is a branch cut; the imaginary part of the result jumps when crossing the cut. On the negative real

axis, the imaginary part is  $\pi$  according to  $\ln(x) = i\pi + \ln(-x)$ ,  $x < 0$ . See “Example 3” on page 1-1294 (Symbolic Math Toolbox).

If an argument is a floating-point interval of type `DOM_INTERVAL`, `ln` returns the results of type `DOM_INTERVAL`, properly rounded outwards. This implies that the result contains only real numbers. See “Example 4” on page 1-1295 (Symbolic Math Toolbox).

Arithmetical rules such as  $\ln(xy) = \ln(x) + \ln(y)$  are not valid throughout the complex plane. Use properties to mark identifiers as real and apply functions such as `expand`, `combine` or `simplify` to manipulate expressions involving `ln`. See “Example 5” on page 1-1295 (Symbolic Math Toolbox).

## Environment Interactions

When called with a floating-point argument, the function is sensitive to the environment variable `DIGITS` which determines the numerical working precision.

## Examples

### Example 1

Compute the natural logarithms of these numeric and symbolic values:

`ln(2)`, `ln(-3)`, `ln(1/4)`, `ln(1 + I)`, `ln(x^2)`

`ln(2)`, `ln(3) + pi i`, `-ln(4)`, `ln(1 + i)`, `ln(x^2)`

For floating-point arguments, `ln` returns floating-point results:

`ln(123.4)`, `ln(5.6 + 7.8*I)`, `ln(1.0/10^20)`

`4.815431111`, `2.261980065 + 0.948125538 i`, `-46.05170186`

`ln` applies special simplification rules to its arguments:

`ln(1)`, `ln(-1)`, `ln(exp(-5))`, `ln(exp(5 + 27/4*I))`

$$0, \pi i, -5, 5 - 2\pi i + \frac{27i}{4}$$

## Example 2

diff, float, limit, series and similar functions handle expressions involving ln:

```
diff(ln(x^2), x)
```

$$\frac{2}{x}$$

```
float(ln(PI + I))
```

$$1.192985153 + 0.3081690711 i$$

```
limit(ln(x)/x, x = infinity)
```

$$0$$

```
series(x*ln(sin(x)), x = 0, 10)
```

$$x \ln(x) - \frac{x^3}{6} - \frac{x^5}{180} - \frac{x^7}{2835} - \frac{x^9}{37800} + O(x^{11})$$

## Example 3

The negative real axis is a branch cut. The imaginary part of the values returned by ln jump when crossing this cut:

```
ln(-2.0), ln(-2.0 + I/10^1000), ln(-2.0 - I/10^1000)
```

$$0.6931471806 + 3.141592654 i, 0.6931471806 + 3.141592654 i, \\ 0.6931471806 - 3.141592654 i$$



## Example 4

The natural logarithm of an interval on page 7-33 is the image set of the logarithm function over the set represented by the interval:

```
ln(1 ... 2)
```

```
0.0 ... 0.6931471806
```

```
ln(-1 ... 1)
```

```
RD_NINF ... 0.0 ∪ RD_NINF ... 0.0 + 3.141592653 ... 3.141592654 i
```

This definition extends to unions of intervals:

```
ln(1 ... 2 union 3 ... 4)
```

```
0.0 ... 0.6931471806 ∪ 1.098612288 ... 1.386294362
```

## Example 5

expand, combine, and simplify react to properties set via assume. The following call does not produce an expanded result, because the arithmetical rule  $\ln(xy) = \ln(x) + \ln(y)$  does not hold for arbitrary complex  $x, y$ :

```
expand(ln(x*y))
```

```
ln(x y)
```

If one of the factors is real and positive, the rule is valid:

```
assume(x > 0): expand(ln(x*y))
```

```
ln(x) + ln(y)
```

```
combine(%, ln)
```

$\ln(x y)$

`simplify(ln(x^3*y) - ln(x))`

$\ln(x^2 y)$

For further computations, clear the assumption:

`unassume(x):`

## Parameters

**x**

An arithmetical expression (Symbolic Math Toolbox)

## Return Values

Arithmetical expression

## Overloaded By

x

## See Also

### MuPAD Functions

`dilog` | `log` | `log10` | `log2` | `polylog`

# Log

Logarithm to arbitrary base

---

**Note** For log in MATLAB®, see log.

---

## Syntax

log(b, x)

log(x)

## Description

---

**Note** The output of syntax log(b, x) has been changed and is rewritten in terms of natural logarithms as  $\ln(x)/\ln(b)$ .

---

log(b, x) represents the logarithm of x to the base b.

log(x) is an alias for the natural logarithm  $\ln(x)$ .

Mathematically,  $\log_b(x)$  coincides with  $\ln(x)/\ln(b)$ . When you call log, the result is rewritten in terms of the natural logarithms.

The logarithm is defined for all complex arguments  $x \neq 0$ . The base b, however, is assumed to be real, positive and not equal to 1.

---

**Note** For symbolic b, MuPAD applies simplifications based on these assumptions.

---

log applies the following simplification rules to its arguments:

- $\log_b(b^x) = x$  in the following cases:

- `b` is a symbolic (indexed) identifier and `x` is of type `Type : Real`
- `b` is numerical and `x` is integer or rational.

Mathematically, this rule is valid for any real value `x`.

•

If `x` is a negative integer or a negative rational, then  $\log_b(x) = \frac{i\pi}{\ln(b)} + \frac{\ln(-x)}{\ln(b)}$ .

•

If `x` is an integer, then  $\log_b\left(\frac{1}{x}\right) = -\frac{\ln(x)}{\ln(b)}$ .

- `log` uses the following special values:

$$\log_b(1) = 0, \log_b(-1) = \frac{i\pi}{\ln(b)}, \log_b(i) = \frac{i\pi}{2\ln(b)}, \log_b(-i) = -\frac{i\pi}{2\ln(b)}.$$

For exact numeric and symbolic arguments, `log` rewrites the function call in terms of the natural logarithm.

If both arguments are numerical and at least one of them is a floating-point number, `log` returns a floating-point result. The imaginary part of the result takes values in the interval

$\left(-\frac{\pi}{\ln(b)}, \frac{\pi}{\ln(b)}\right]$  if  $b > 1$  and in the interval  $\left[\frac{\pi}{\ln(b)}, -\frac{\pi}{\ln(b)}\right)$  if  $b < 1$ . The negative real axis is a branch cut, the imaginary part of the result jumps when crossing the cut. On the

negative real axis, the imaginary part is  $\frac{\pi}{\ln(b)}$  according to  $\log_b(x) = \frac{i\pi}{\ln(b)} + \frac{\ln(-x)}{\ln(b)}$ ,  $x < 0$ . See “Example 3” on page 1-1300 (Symbolic Math Toolbox).

Arithmetical rules such as  $\log_b(xy) = \frac{\ln(x)}{\ln(b)} + \frac{\ln(y)}{\ln(b)}$  are not valid throughout the complex plane. Use properties to mark identifiers as `real` and apply functions such as `expand` or `simplify` to manipulate expressions involving `log`. See “Example 4” on page 1-1300 (Symbolic Math Toolbox).

## Environment Interactions

When called with a floating-point argument, the function is sensitive to the environment variable `DIGITS` which determines the numerical working precision.

## Examples

### Example 1

When computing a logarithm to an arbitrary base, use identifiers, indexed identifiers, or numbers of type `Type::Positive` to specify the base of a logarithm:

```
log(b, 2), log(b[1], 3), log(2, 5), log(2/3, 4/9), log(0.3, x)
```

$$\frac{\ln(2)}{\ln(b)}, \frac{\ln(3)}{\ln(b_1)}, \frac{\ln(5)}{\ln(2)}, 2, -0.8305835451 \ln(x)$$

Do not use general arithmetical expressions to specify the base:

```
log(-PI^2, 2)
```

Error: Base must be an identifier, an indexed identifier, or a positive real number. [

For floating-point arguments, `log` returns floating-point results:

```
log(2, 123.4), log(2.0, 5.6 + 7.8*I), log(10.0, 2/10^20)
```

$$6.947198584, 3.263347423 + 1.367856012 i, -19.69897$$

`log` applies special simplification rules to its arguments:

```
log(b, 1), log(b, -1), log(2/3, (4/9)^10), log(b, b^(-5))
```

$$0, \frac{\pi i}{\ln(b)}, 20, -5$$

### Example 2

`diff`, `float`, `limit`, `series` and similar functions handle expressions involving `log`:

```
diff(log(b, x^2), x)
```

$$\frac{2}{x \ln(b)}$$

```
float(log(10, PI + I))
```

```
0.5181068691 + 0.1338361271 i
```

```
limit(log(10, x)/x, x = infinity)
```

```
0
```

```
series(x*log(x, sin(x)), x = 0)
```

$$x - \frac{x^3}{6 \ln(x)} - \frac{x^5}{180 \ln(x)} + O(x^7)$$

### Example 3

The negative real axis is a branch cut. The imaginary part of the values returned by `log` jump when crossing this cut:

```
log(10, -2.0),
log(10, -2.0 + I/10^1000),
log(10, -2.0 - I/10^1000)
```

```
0.3010299957 + 1.364376354 i, 0.3010299957 + 1.364376354 i,
0.3010299957 - 1.364376354 i
```

### Example 4

`expand` and `simplify` react to properties set via `assume`. The following call does not produce an expanded result, because the arithmetical rule  $\log_b(x y) = \log_b(x) + \log_b(y)$  does not hold for arbitrary complex  $x, y$ :

```
expand(log(10, x*y))
```

$$\frac{\ln(x y)}{\ln(10)}$$

If one of the factors is real and positive, the rule is valid:

```
assume(x > 0): expand(log(b, x*y))
```

$$\frac{\ln(x)}{\ln(b)} + \frac{\ln(y)}{\ln(b)}$$

```
simplify(log(b, x^3*y) - log(b, x))
```

$$\frac{\ln(x^2 y)}{\ln(b)}$$

For further computations, clear the assumption:

```
unassume(x):
```

## Parameters

**b**

An identifier of domain type `DOM_IDENT`, indexed identifier on page 1-1017, real numerical value of type `Type::Positive`, or the expression `exp(1)` that leads to the natural logarithm:  $\log(\exp(1), x) = \ln(x)$ .

**x**

An arithmetical expression (Symbolic Math Toolbox)

## Return Values

Arithmetical expression

## Overloaded By

x

## See Also

### MuPAD Functions

dilog | ln | log10 | log2 | polylog



# log10

Logarithm to base 10

---

**Note** For `log10` in MATLAB®, see `log10`.

---

## Syntax

`log10(x)`

## Description

`log10(x)` represents the logarithm of  $x$  to the base 10.

Mathematically, `log10(x)` is equivalent to  $\log(10, x)$ . See “Example 1” on page 1-1304 (Symbolic Math Toolbox).

The logarithm to the base 10 is defined for all complex arguments  $x \neq 0$ .

`log10(x)` rewrites logarithms to the base 10 in terms of the natural logarithm:  $\log_{10}(x) = \ln(x)/\ln(10)$ . See “Example 2” on page 1-1304 (Symbolic Math Toolbox).

See the `ln` help page for details.

## Environment Interactions

When called with a floating-point argument, this function is sensitive to the environment variable `DIGITS` which determines the numerical working precision.

## Examples

### Example 1

Compute these logarithms using `log10`:

`log10(10), log10(1000), log10(1)`

`1, 3, 0`

Compute the same logarithms using `log` with 10 as the first argument:

`log(10, 10), log(10, 1000), log(10, 1)`

`1, 3, 0`

### Example 2

`log10` rewrites logarithms in terms of `ln`:

`log10(x), log10(x^2 - 1)`

$$\frac{\ln(x)}{\ln(10)}, \frac{\ln(x^2 - 1)}{\ln(10)}$$

### Example 3

For floating-point values, `log10` returns floating-point results:

`log10(123.4), log10(5.6 + 7.8*I), log10(-15.45)`

`2.09131516, 0.9823654605 + 0.4117656893 i, 1.188928484 + 1.364376354 i`

### Example 4

For floating-point intervals, `log10` returns results as floating-point intervals:

`log10(2.0...10.15)`

`0.3010299956 ... 1.006466043`

## Parameters

**x**

An arithmetical expression (Symbolic Math Toolbox)

## Return Values

Arithmetical expression

## Overloaded By

x

## See Also

### MuPAD Functions

`dilog` | `ln` | `log` | `log2` | `polylog`

## log2

Logarithm to base 2

### Syntax

`log2(x)`

### Description

`log2(x)` represents the logarithm of  $x$  to the base 2.

Mathematically, `log2(x)` is equivalent to `log(2, x)`. See “Example 1” on page 1-1306 (Symbolic Math Toolbox).

The logarithm to the base 2 is defined for all complex arguments  $x \neq 0$ .

`log2(x)` rewrites logarithms to the base 2 in terms of the natural logarithm: `log2(x) = ln(x)/ln(2)`. See “Example 2” on page 1-1307 (Symbolic Math Toolbox).

See the `ln` help page for details.

### Environment Interactions

When called with a floating-point argument, this function is sensitive to the environment variable `DIGITS` which determines the numerical working precision.

### Examples

#### Example 1

Compute these logarithms using `log2`:

```
log2(2), log2(8), log2(1)
```

1, 3, 0

Compute the same logarithms using log with 2 as the first argument:

log(2, 2), log(2, 8), log(2, 1)

1, 3, 0

## Example 2

log2 rewrites logarithms in terms of ln:

log2(x), log2(x<sup>2</sup> - 1)

$$\frac{\ln(x)}{\ln(2)}, \frac{\ln(x^2 - 1)}{\ln(2)}$$

## Example 3

For floating-point values, log2 returns floating-point results:

log2(123.4), log2(5.6 + 7.8\*I), log2(-15.45)

6.947198584, 3.263347423 + 1.367856012 i, 3.949534933 + 4.532360142 i

## Example 4

For floating-point intervals, log2 returns results as floating-point intervals:

log2(2.0...10.15)

0.999999999 ... 3.343407823

## Parameters

**x**

An arithmetical expression (Symbolic Math Toolbox)

## Return Values

Arithmetical expression

## Overloaded By

**x**

## See Also

### **MuPAD Functions**

dilog | ln | log | log10 | polylog

# **lterm**

Leading term of a polynomial

## **Syntax**

`lterm(p, <order>)`

`lterm(f, <vars>, <order>)`

## **Description**

`lterm(p)` returns the leading term of the polynomial  $p$ .

The returned term is “leading” with respect to the lexicographical ordering, unless a different ordering is specified via the argument `order`. Cf. “Example 1” on page 1-1309 (Symbolic Math Toolbox).

The identity `lterm(p)*lcoeff(p) = lmonomial(p)` holds.

The leading term of the zero polynomial is the zero polynomial.

A polynomial expression  $f$  is first converted to a polynomial with the variables given by `vars`. If no variables are given, they are searched for in  $f$ . See `poly` about details of the conversion. The result is returned as polynomial expression. FAIL is returned if  $f$  cannot be converted to a polynomial. Cf. “Example 3” on page 1-1310 (Symbolic Math Toolbox).

## **Examples**

### **Example 1**

We demonstrate how various orderings influence the result:

```
p := poly(5*x^4 + 4*x^3*y*z^2 + 3*x^2*y^3*z + 2, [x, y, z]):  
lterm(p), lterm(p, DegreeOrder), lterm(p, DegInvLexOrder)
```

$\text{poly}(x^4, [x, y, z]), \text{poly}(x^3 y z^2, [x, y, z]), \text{poly}(x^2 y^3 z, [x, y, z])$

The following call uses the reverse lexicographical order on page 7-309 on 3 indeterminates:

```
lterm(p, Dom::MonomOrdering(RevLex(3)))
```

$\text{poly}(x^2 y^3 z, [x, y, z])$

```
delete p:
```

## Example 2

The leading monomial is the product of the leading coefficient and the leading term:

```
p := poly(2*x^2*y + 3*x*y^2 + 6, [x, y]):  
mapcoeffs(lterm(p), lcoeff(p)) = lmonomial(p)
```

$\text{poly}(2 x^2 y, [x, y]) = \text{poly}(2 x^2 y, [x, y])$

```
delete p:
```

## Example 3

The expression  $1/x$  may not be regarded as polynomial:

```
lterm(1/x)
```

FAIL

## Parameters

**p**

A polynomial (Symbolic Math Toolbox) of type DOM\_POLY



**f**

A polynomial expression (Symbolic Math Toolbox)

**vars**

A list on page 7-41 of indeterminates of the polynomial: typically, identifiers on page 7-29 or indexed identifiers on page 1-1017

**order**

The term ordering: either `LexOrder` or `DegreeOrder` or `DegInvLexOrder` or a user-defined term ordering of type `Dom::MonomOrdering`. The default is the lexicographical ordering `LexOrder`.

## Return Values

Polynomial of the same type as `p`. An expression is returned if an expression is given as input. `FAIL` is returned if the input cannot be converted to a polynomial.

## Overloaded By

`p`

## See Also

**MuPAD Functions**

`coeff` | `degree` | `degreevec` | `ground` | `lcoeff` | `ldegree` | `lmonomial` | `monomials` | `nterms` | `nthcoeff` | `nthmonomial` | `nthterm` | `poly` | `poly2list` | `tcoeff`

# match

Pattern matching

## Syntax

```
match(expression, pattern, options)
```

## Description

`match(expression, pattern)` checks whether the syntactical structure of `expression` matches `pattern`. If so, the call returns a set of replacement equations transforming `pattern` into `expression`.

`match` computes a set of replacement equations `S` for the identifiers on page 7-29 occurring in `pattern`, such that `subs(pattern, S)` and `expression` coincide up to associativity, commutativity, and neutral elements.

Without additional options, a purely syntactical matching is performed; associativity, commutativity, or neutral elements are taken into account only for the builtin operators `+` and `*`, `and` and `or`, and `union` and `intersect`. In this case, `subs(pattern, S) = expression` holds for the set `S` of replacement equations returned by `match` if the matching was successful. Cf. “Example 1” on page 1-1313 (Symbolic Math Toolbox). You can declare these properties for operators via the options `Associative`, `Commutative`, and `Null` (see below). Then `subs(pattern, S)` and `expression` need no longer be equal in MuPAD, but they can be transformed into each other by application of the rules implied by the options.

Both `expression` and `pattern` may be arbitrary MuPAD expressions, i.e., both atomic expressions such as numbers on page 33-76, Boolean constants on page 1-2180, and identifiers on page 7-29, and composite on page 7-20expressions on page 7-20.

Each identifier on page 7-29 without a value that occurs in `pattern`, including the 0th operands, is regarded as a *pattern variable*, in the sense that it may be replaced by some expression in order to transform `pattern` into `expression`. Use the option `Const` (see below) to declare identifiers as non-replaceable.

With the exception of some automatic simplifications performed by the MuPAD kernel, distributivity is *not* taken into account. Cf. “Example 5” on page 1-1315 (Symbolic Math Toolbox).

---

**Note** `match` evaluates its arguments, as usual. This evaluation usually encompasses a certain amount of simplification, which may change the syntactical structure of both `expression` and `pattern` in an unexpected way. Cf. “Example 6” on page 1-1315 (Symbolic Math Toolbox).

---

Even if there are several possible matches, `match` returns at most one of them. Cf. “Example 7” on page 1-1316 (Symbolic Math Toolbox).

If the structure of `expression` does not match `pattern`, `match` returns `FAIL`.

If `expression` and `pattern` are equal, the empty set on page 7-50 is returned.

Otherwise, if a match is found and `expression` and `pattern` are different, then a set `S` of replacement equations is returned. For each pattern variable `x` occurring in `pattern` that is not declared constant via the option `Const`, `S` contains exactly one replacement equation of the form `x = y`, and `y` is the expression to be substituted for `x` in order to transform `pattern` into `expression`.

## Examples

### Example 1

All identifiers of the following pattern are pattern variables:

```
match(f(a, b), f(X, Y))
```

$$\{X = a, Y = b, f = f\}$$

The function `f` is declared non-replaceable:

```
match(f(a, b), f(X, Y), Const = {f})
```

$$\{X = a, Y = b\}$$

## Example 2

The following call contains a condition for the pattern variable X:

```
match(f(a, b), f(X, Y), Const = {f}, Cond = {X -> not has(X, a)})
```

FAIL

If the function `f` is declared commutative, the expression matches the given pattern—in contrast to the preceding example:

```
match(f(a, b), f(X, Y), Const = {f}, Commutative = {f},  
      Cond = {X -> not has(X, a)})
```

$\{X = b, Y = a\}$

## Example 3

The following expression cannot be matched since the number of arguments of the expression and the pattern are different:

```
match(f(a, b, c), f(X, Y), Const = {f})
```

FAIL

We declare the function `f` associative with the option `Associative`. In this case the pattern matches the given expression:

```
match(f(a, b, c), f(X, Y), Const = {f}, Associative = {f})
```

$\{X = a, Y = f(b, c)\}$

## Example 4

If, however, the function call in the pattern has more arguments than the corresponding function call in the expression, no match is found:

```
match(f(a, b), f(X, Y, Z), Const = {f}, Associative = {f})
```

FAIL

If the neutral element with respect to the operator  $f$  is known, additional matches are possible by substituting it for some of the pattern variables:

```
match(f(a, b), f(X, Y, Z), Const = {f},
      Associative = {f}, Null = {f = 0})
```

$\{X = a, Y = b, Z = 0\}$

## Example 5

Distributivity is *not* taken into account in general:

```
match(a*x + a*y, a*(X + Y), Const = {a})
```

FAIL

The next call finds a match, but not the expected one:

```
match(a*(x + y), X + Y)
```

$\{Y = 0, X = a(x + y)\}$

The following declarations and conditions do not lead to the expected result, either:

```
match(a*(x + y), a*X + a*Y, Const = {a},
      Cond = {X -> X <> 0, Y -> Y <> 0})
```

FAIL

## Example 6

Automatic simplifications can “destroy” the structure of the given expression or pattern:

```
match(sin(-2), sin(X))
```

FAIL

The result is FAIL, because the first argument `sin(-2)` is evaluated and rewritten to `-sin(2)`:

```
sin(-2)
```

```
-sin(2)
```

You can circumvent this problem by using `hold`:

```
match(hold(sin(-2)), sin(X))
```

```
{X = -2}
```

## Example 7

`match` returns only one possible match:

```
match(a + b + c + 1, X + Y)
```

```
{X = a, Y = b + c + 1}
```

To obtain other solutions, use conditions to exclude the solutions that you already have:

```
match(a + b + c + 1, X + Y, Cond = {X <> a})
```

```
{Y = a, X = b + c + 1}
```

```
match(a + b + c + 1, X + Y, Cond = {X <> a and Y <> a})
```

```
{X = b, Y = a + c + 1}
```

```
match(a + b + c + 1, X + Y,  
      Cond = {X <> a and X <> b and Y <> a})
```

$$\{X = c, Y = a + b + 1\}$$

## Example 8

Every pattern variable can have at most one condition procedure. Simple conditions can be given by anonymous procedures (->):

```
match(a + b, X + Y, Cond = {X -> X <> a, Y -> Y <> b})
```

$$\{X = b, Y = a\}$$

Several conditions on a pattern variable can be combined in one procedure:

```
Xcond := proc(X) begin
  if domtype(X) = DOM_IDENT then
    X <> a and X <> b
  else
    X <> 0
  end_if
end_proc:
```

```
match(sin(a*b), sin(X*Y), Cond = {Xcond})
```

$$\{Y = 1, X = a b\}$$

```
match(sin(a*c), sin(X*Y), Cond = {Xcond})
```

$$\{Y = a, X = c\}$$

```
delete Xcond:
```

## Parameters

### expression

A MuPAD expression

**pattern**

The pattern: a MuPAD expression

**option1, option2, ...**

Optional arguments as listed below

## Options

### Associative

Option, specified as `Associative = {f1, f2, ...}`

It is assumed that identifiers on page 7-29 `f1`, `f2`, ... represent associative operators and may take an arbitrary number of arguments, i.e., expressions such as `f1(f1(a, b), c)`, `f1(a, f1(b, c))`, and `f1(a, b, c)` are considered equal.

No special rules for associative operators with less than two arguments apply. In particular, `f1(a)` and `a` are *not* considered equal.

### Commutative

Option, specified as `Commutative = {g1, g2, ...}`

It is assumed that the identifiers on page 7-29 `g1`, `g2`, ... represent commutative operators, i.e., expressions such as `g1(a, b)` and `g1(b, a)` are considered equal.

### Cond

Option, specified as `Cond = {p1, p2, ...}`

Only matches satisfying the conditions specified by the procedures `p1`, `p2`, ... are considered. Each procedure on page 7-45 must take exactly one argument and represents a condition on exactly one pattern variable. The name of the procedure's formal argument must be equal to the name of a pattern variable occurring in `pattern` that is not declared constant via the option `Const`. Each condition procedure must return an expression that the function `bool` can evaluate to one of the Boolean values `TRUE` or `FALSE`.

Anonymous procedures created via `->` can be used to express simple conditions. Cf. "Example 8" on page 1-1317 (Symbolic Math Toolbox).



If a possible match is found, given by a set of replacement equations  $S$ , then `match` checks whether all specified conditions are satisfied by calling `bool(p1(y1) and p2(y2) and ...)`, where  $y1$  is the expression to be substituted for the pattern variable  $x1$  that agrees with the formal argument of the procedure  $p1$ , etc. If the return value of the call is `TRUE`, then `match` returns  $S$ . Otherwise, the next possible match is tried.

For example, if  $p1$  is a procedure with formal argument  $x1$ , where  $x1$  is a pattern variable occurring in `pattern`, then a match  $S = \{ \dots, x1 = y1, \dots \}$  is considered valid only if `bool(p1(y1))` returns `TRUE`.

There can be at most one condition procedure for each pattern variable. If necessary, use the logical operators `and` and `or` as well as the control structures `if` and `case` to combine several conditions for the same pattern variable in one condition procedure. Cf. "Example 8" on page 1-1317 (Symbolic Math Toolbox).

### **Const**

Option, specified as `Const = {c1, c2, ...}`

The identifiers  $c1$ ,  $c2$ ,  $\dots$  are regarded as constants, i.e., they must match literally and must not be replaced in order to transform `pattern` into `expression`.

### **Null**

Option, specified as `Null = {h1 = e1, h2 = e2, ...}`

It is assumed that  $e1$ ,  $e2$ ,  $\dots$  are the neutral elements with respect to the associative operations  $h1$ ,  $h2$ ,  $\dots$  i.e., expressions such as  $h1(a, e1)$ ,  $h1(e1, a)$ , and  $h1(a)$  are considered equal.

This declaration affects only operators that are declared associative via the option `Associative`. Moreover, the neutral elements are not implicitly assumed to be constants.

## **Return Values**

Set of replacement equations, or `FAIL`.

## See Also

### **MuPAD Functions**

simplify | subs | subsex | subsop

## map

Apply a function to all operands of an object

### Syntax

```
map(object, f, <p1, p2, , ...>)
```

```
map(object, f, <p1, p2, , ...>, <Unsimpified>)
```

### Description

`map(object, f)` returns a copy of `object` where each operand on page 1-1493 `x` has been replaced by `f(x)`. The object itself is not modified by `map` (see “Example 2” on page 1-1323 (Symbolic Math Toolbox)).

The second argument `f` may be a procedure on page 7-45 generated via `->` or `proc` (e.g., `x -> x^2 + 1`), a function environment on page 7-25 (e.g., `sin`), or a functional expression (e.g., `sin@exp + 2*id`).

If optional arguments are present, then each operand on page 1-1493 `x` of `object` is replaced by `f(x, p1, p2, ...)` (see “Example 1” on page 1-1323 (Symbolic Math Toolbox)).

It is possible to apply an operator, such as `+` or `*`, to all operands of `object`, by using its functional equivalent, such as `_plus` or `_mult`. See “Example 1” on page 1-1323 (Symbolic Math Toolbox).

In contrast to `op`, `map` does not decompose rational numbers and complex numbers further. Thus, if the argument is a rational number on page 7-48 or a complex number on page 7-84, then `f` is applied to the number itself and not to the numerator and the denominator or the real part and the imaginary part, respectively (see “Example 3” on page 1-1324 (Symbolic Math Toolbox)).

If `object` is a string on page 7-53, then `f` is applied to the string as a whole and not to the individual characters (see “Example 3” on page 1-1324 (Symbolic Math Toolbox)).

If `object` is an expression on page 7-20, then `f` is applied to the operands of `f` as returned by `op` (see “Example 1” on page 1-1323 (Symbolic Math Toolbox)).

If `object` is an expression sequence on page 1-88, then this sequence is not flattened (Symbolic Math Toolbox) by `map` (see “Example 4” on page 1-1324 (Symbolic Math Toolbox)).

If `object` is a polynomial on page 1-1601, then `f` is applied to the polynomial itself and not to all of its coefficients. Use `mapcoeffs` to achieve the latter (see “Example 3” on page 1-1324 (Symbolic Math Toolbox)).

If `object` is a list on page 7-41, a set on page 7-50, an array on page 7-2, or an `hfarray` on page 7-27, then the function `f` is applied to all elements of the corresponding data structure.

---

**Note** If `object` is a table on page 1-2103, the function `f` is applied to all *entries* of the table, not to the indices (see “Example 9” on page 1-1327 (Symbolic Math Toolbox)). The entries are the right sides of the operands on page 1-1493 of a table.

---

If `object` is an element of a library domain (Symbolic Math Toolbox), then the slot “`map`” of the domain is called and the result is returned. This can be used to extend the functionality of `map` to user-defined domains. If no “`map`” slot exists, then `f` is applied to the object itself (see “Example 10” on page 1-1327 (Symbolic Math Toolbox)).

`map` does not evaluate its result after the replacement; use `eval` to achieve this. Nevertheless, internal simplifications occur after the replacement, unless the option `Unsimpified` is given (see “Example 8” on page 1-1326 (Symbolic Math Toolbox)).

`map` does not descend recursively into an object; the function `f` is only applied to the operands at first level. Use `misc::maprec` for a recursive version of `map` (see “Example 11” on page 1-1328 (Symbolic Math Toolbox)).

The procedure `f` should be deterministic and should not have side effects (such as changing and using global variables). The user does not have any control over the ordering in which the function is applied to the operands of the object!

## Examples

### Example 1

map works for expressions:

```
map(a + b + 3, sin)
```

$$\sin(3) + \sin(a) + \sin(b)$$

The optional arguments of map are passed to the function being mapped:

```
map(a + b + 3, f, x, y)
```

$$f(3, x, y) + f(a, x, y) + f(b, x, y)$$

In the following example, we add 10 to each element of a list:

```
map([1, x, 2, y, 3, z], _plus, 10)
```

$$[11, x + 10, 12, y + 10, 13, z + 10]$$

### Example 2

Like most other MuPAD functions, map does not modify its first argument, but returns a modified copy:

```
a := [0, PI/2, PI, 3*PI/2]:
map(a, sin)
```

$$[0, 1, 0, -1]$$

The list a still has its original value:

```
a
```

$$\left[0, \frac{\pi}{2}, \pi, \frac{3\pi}{2}\right]$$

### Example 3

map does not decompose rational and complex numbers:

```
map(3/4, _plus, 1), map(3 + 4*I, _plus, 1)
```

$\frac{7}{4}, 4 + 4i$

map does not decompose strings:

```
map("MuPAD", text2expr)
```

MuPAD

map does not decompose polynomials:

```
map(poly(x^2 + x + 1), _plus, 1)
```

$\text{poly}(x^2 + x + 2, [x])$

Use `mapcoeffs` to apply a function to all coefficients of a polynomial:

```
mapcoeffs(poly(x^2 + x + 1), _plus, 1)
```

$\text{poly}(2x^2 + 2x + 2, [x])$

### Example 4

The first argument is not flattened:

```
map((1, 2, 3), _plus, 2)
```

3, 4, 5

## Example 5

Sometimes a MuPAD function returns a set or a list of big symbolic expressions containing mathematical constants etc. To get a better intuition about the result, you can map the function `float` to all elements, which often drastically reduces the size of the expressions:

```
solve(x^4 + x^2 + PI, x)
```

$$\left\{ \sqrt{-\frac{\sqrt{1-4\pi}}{2} - \frac{1}{2}}, \sqrt{\frac{\sqrt{1-4\pi}}{2} - \frac{1}{2}}, -\sqrt{-\frac{\sqrt{1-4\pi}}{2} - \frac{1}{2}}, -\sqrt{\frac{\sqrt{1-4\pi}}{2} - \frac{1}{2}} \right\}$$

```
map(%, float)
```

$$\{-0.7976383425 - 1.065939457 i, -0.7976383425 + 1.065939457 i, 0.7976383425 - 1.065939457 i, 0.7976383425 + 1.065939457 i\}$$

## Example 6

In the following example, we delete the values of all global identifiers in the current MuPAD session. The command `anames(All, User)` returns a set with the names of all user-defined global identifiers having a value. Mapping the function `_delete` to this set deletes the values of all these identifiers. Since the return value of `_delete` is the empty sequence `null()`, the result of the call is the empty set:

```
x := 3: y := 5: x + y
```

8

```
map(anames(All, User), _delete)
```

∅

```
x + y
```

x + y

## Example 7

It is possible to perform arbitrary actions with all elements of a data structure via a single `map` call. This works by passing an anonymous procedure on page 7-45 as the second argument `f`. In the following example, we check that the fact “an integer  $n \geq 2$  is prime if and only if  $\varphi(n) = n - 1$ ”, where  $\varphi$  denotes Euler’s totient function, holds for all integer  $2 \leq n < 10$ . We do this by comparing the result of `isprime(n)` with the truth value of the equation  $\varphi(n) = n - 1$  for all elements `n` of a list containing the integers between 2 and 9:

```
map([2, 3, 4, 5, 6, 7, 8, 9],  
    n -> bool(isprime(n) = bool(numlib::phi(n) = n - 1)))
```

```
[TRUE, TRUE, TRUE, TRUE, TRUE, TRUE, TRUE, TRUE]
```

## Example 8

The result of `map` is not evaluated further. If desired, you must request evaluation explicitly by `eval`:

```
map(sin(5), float);  
eval(%)
```

```
sin(5.0)
```

```
-0.9589242747
```

```
delete a:  
A := array(1..1, [a]);  
a := 0:  
map(A, sin);  
map(A, eval@sin);  
delete a:
```

```
( a )
```

```
( sin(a) )
```



( 0 )

Nevertheless, certain internal simplifications take place, such as the calculation of arithmetical operations with numerical arguments. The following call replaces `sqrt(2)` and `PI` by floating-point approximations, and the system automatically simplifies the resulting sum:

```
map(sin(5) + cos(5), float)
```

```
-0.6752620892
```

This internal simplification can be avoided by giving the option `Unimplified`:

```
map(sin(5) + cos(5), float, Unimplified)
```

```
0.2836621855 - 0.9589242747
```

## Example 9

`map` applied to a table on page 1-2103 changes only the right sides (the entries) of each operand on page 1-1493 of the table. Assume the entries stand for net prices and the sales tax (16 percent in this case) must be added:

```
T := table(1 = 65, 2 = 28, 3 = 42):
map(T, _mult, 1.16)
```

```

1 | 75.4
2 | 32.48
3 | 48.72
```

## Example 10

`map` can be overloaded for elements of library domains on page 1-1422, if a slot on page 1-1980 "`map`" is defined. In this example `d` is a domain, its elements contains two integer numbers: an index and an entry (like a table). For nice input and printing elements of this domain the slots on page 1-1980 "`new`" and "`print`" are defined:

```
d := newDomain("d"):
d::new := () -> new(d, args()):
d::print := object -> _equal(extop(object)):
d(1, 65), d(2, 28), d(3, 42)
```

1 = 65, 2 = 28, 3 = 42

Without a slot "map" the function `f` will be applied to the domain element itself. Because the domain `d` has no slot "`_mult`", the result is the symbolic `_mult` call:

```
map(d(1, 65), _mult, 1.16),
type(map(d(1, 65), _mult, 1.16))
```

1.16 (1 = 65), "\_mult"

The slot "map" of this domain should map the given function only onto the second operand of a domain element. The domain `d` gets a slot "map" and `map` works properly (in the authors sense) with elements of this domain:

```
d::map := proc(obj, f)
begin
  if args(0) > 2 then
    d(extop(obj, 1), f(extop(obj, 2), args(3..args(0))))
  else
    d(extop(obj, 1), f(extop(obj, 2)))
  end_if
end_proc:
map(d(1, 65), _mult, 1.16),
map(d(2, 28), _mult, 1.16),
map(d(3, 42), _mult, 1.16)
```

1 = 75.4, 2 = 32.48, 3 = 48.72

## Example 11

`map` does not work recursively. Suppose that we want to de-nest a nested list. We use `map` to apply the function `op`, which replaces a list by the sequence of its operands, to all entries of the list `l`. However, this only affects the entries at the first level:

```
l := [1, [2, [3]], [4, [5]]]:  
map(l, op)
```

```
[1, 2, [3], 4, [5]]
```

Use `misc::maprec` to achieve the desired behavior:

```
[misc::maprec(l, {DOM_LIST} = op)]
```

```
[1, 2, 3, 4, 5]
```

## Parameters

### **object**

An arbitrary MuPAD object

### **f**

A function (Symbolic Math Toolbox)

### **p<sub>1</sub>, p<sub>2</sub>, ...**

Any MuPAD objects accepted by `f` as additional parameters

## Options

### **Unsimplified**

The resulting expressions are not further simplified.

## Return Values

Copy of `object` with `f` applied to all operands.

## Overloaded By

object

## See Also

### **MuPAD Functions**

eval | mapcoeffs | misc::maprec | op | select | split | subs | subsex | subsop |  
zip

# mapcoeffs

Apply a function to the coefficients of a polynomial

## Syntax

```
mapcoeffs(p, F, <a1, a2, ...>)
```

```
mapcoeffs(f, <vars>, F, <a1, a2, ...>)
```

## Description

`mapcoeffs(p, F, a1, a2, ...)` applies the function `F` to the polynomial `p` by replacing each coefficient `c` in `p` by `F(c, a1, a2, ...)`.

For a polynomial `p` of type `DOM_POLY` generated by `poly`, the function `F` must accept arguments from the coefficient ring of `p` and must produce corresponding results.

A polynomial expression `f` is first converted to a polynomial with the variables given by `vars`. If no variables are given, they are searched for in `f`. See `poly` about details of the conversion. `FAIL` is returned if `f` cannot be converted to a polynomial. After applying the function `F`, the result is converted to an expression.

`mapcoeffs` evaluates its arguments. Note, however, that polynomials of type `DOM_POLY` do not evaluate their coefficients for efficiency reasons. Cf. "Example 4" on page 1-1333 (Symbolic Math Toolbox).

## Examples

### Example 1

The function `sin` is mapped to the coefficients of a polynomial expression in the indeterminates `x` and `y`:

```
mapcoeffs(3*x^3 + x^2*y^2 + 2, sin)
```

$$\sin(3) x^3 + \sin(1) x^2 y^2 + \sin(2)$$

The following call makes `mapcoeffs` regard this expression as a polynomial in `x`. Consequently, `y` is regarded as a parameter that becomes part of the coefficients:

```
mapcoeffs(3*x^3 + x^2*y^2 + 2, [x], sin)
```

$$\sin(3) x^3 + \sin(y^2) x^2 + \sin(2)$$

The system function `_plus` adds its arguments. In the following call, it is used to add 2 to all coefficients by providing this shift as an additional argument:

```
mapcoeffs(c1*x^3 + c2*x^2*y^2 + c3, [x, y], _plus, 2)
```

$$(c1 + 2) x^3 + (c2 + 2) x^2 y^2 + c3 + 2$$

## Example 2

The function `sin` is mapped to the coefficients of a polynomial in the indeterminates `x` and `y`:

```
mapcoeffs(poly(3*x^3 + x^2*y^2 + 2, [x, y]), sin)
```

$$\text{poly}(\sin(3) x^3 + \sin(1) x^2 y^2 + \sin(2), [x, y])$$

In the following call, the polynomial has the indeterminate `x`. Consequently, `y` is regarded as a parameter that becomes part of the coefficients:

```
mapcoeffs(poly(3*x^3 + x^2*y^2 + 2, [x]), sin)
```

$$\text{poly}(\sin(3) x^3 + \sin(y^2) x^2 + \sin(2), [x])$$

A user-defined function is mapped to a polynomial:

```
F := (c, a1, a2) -> exp(c + a1 + a2):  
mapcoeffs(poly(x^3 + c*x, [x]), F, a1, a2)
```

$$\text{poly}\left(e^{a1+a2+1} x^3 + e^{a1+a2+c} x, [x]\right)$$

delete F:

### Example 3

We consider a polynomial over the integers modulo 7:

```
p := poly(x^3 + 2*x*y, [x, y], Dom::IntegerMod(7)):
```

A function to be applied to the coefficients must produce values in the coefficient ring of the polynomial:

```
mapcoeffs(p, c -> c^2)
```

$$\text{poly}(x^3 + 4 x y, [x, y], \text{Dom}::\text{IntegerMod}(7))$$

The following call maps a function which converts its argument to an integer modulo 3. Such a return value is not a valid coefficient of p:

```
mapcoeffs(p, c -> Dom::IntegerMod(3)(expr(c)))
```

FAIL

delete p:

### Example 4

Note that polynomials of type DOM\_POLY do not evaluate their arguments:

```
delete a, x: p := poly(a*x, [x]): a := PI: p
```

$$\text{poly}(a x, [x])$$

Evaluation can be enforced by the function eval:

```
mapcoeffs(p, eval)
```

```
poly( $\pi$  x, [x])
```

We map the sine on page 1-688 (Symbolic Math Toolbox) function to the coefficients of `p`. The polynomial does not evaluate its coefficient `sin(a)` to 0:

```
mapcoeffs(p, sin)
```

```
poly(sin(a) x, [x])
```

The composition on page 1-74 of `sin` and `eval` is mapped to the coefficients of the polynomial:

```
mapcoeffs(p, eval@sin)
```

```
poly(0, [x])
```

```
delete p, a:
```

## Parameters

**p**

A polynomial (Symbolic Math Toolbox) of type `DOM_POLY`

**F**

A procedure on page 1-1654

**a1, a2, ...**

Additional parameters for the function `F`

**f**

A polynomial expression (Symbolic Math Toolbox)



**vars**

A list on page 7-41 of indeterminates of the polynomial: typically, identifiers on page 7-29 or indexed identifiers on page 1-1017

**Return Values**

Polynomial of type DOM\_POLY, or a polynomial expression, or FAIL.

**Overloaded By**

f, p

**See Also****MuPAD Functions**

coeff | degree | degreevec | lcoeff | ldegree | lterm | map | monomials | nterms | nthcoeff | nthmonomial | nthterm | poly | tcoeff

## maprat

Apply a function to a rationalized expression

### Syntax

```
maprat(object, f, options)
```

### Description

As a first step, `maprat(object, f, options)` calls `rationalize(object, options)`, which generates a rational expression. The `maprat` function uses the expression returned by `rationalize` as an input to the function `f`. As a second step, `maprat` replaces all variables generated by `rationalize` with the original subexpressions in `object`.

See the `rationalize` help page for details.

### Examples

#### Example 1

Find the greatest common divisor (the `gcd` function) for the following two rationalized expressions. The first argument of `maprat` is a sequence of the two expressions `p`, `q`, which `gcd` takes as two parameters. Note the brackets around the sequence `p`, `q`:

```
p := (x - sqrt(2))*(x^2 + sqrt(3)*x - 1):  
q := (x - sqrt(2))*(x - sqrt(3)):  
maprat((p, q), gcd)
```

$$\sqrt{2} - x$$

## Example 2

The `maprat` function accepts the same options as the `rationalize` function. For example, find the least common multiple (the `lcm` function) for the following two rationalized expressions. Use the `FindRelations` option to detect trigonometric relations:

```
p := tan(x)^2 + 1/cos(x)^2:
q := 1/sin(x)^4 + cot(x)^4:
maprat((p, q), lcm, FindRelations = ["sin"])
```

$$\left(\tan\left(\frac{x}{2}\right)^4 + 6 \tan\left(\frac{x}{2}\right)^2 + 1\right) \left(\tan\left(\frac{x}{2}\right)^8 + 6 \tan\left(\frac{x}{2}\right)^4 + 1\right)$$

Without this option, the result is:

```
p := tan(x)^2 + 1/cos(x)^2:
q := 1/sin(x)^4 + cot(x)^4:
maprat((p, q), lcm)
```

$$\left(\cot(x)^4 \sin(x)^4 + 1\right) \left(\cos(x)^2 \tan(x)^2 + 1\right)$$

Free the variables for further calculations:

```
delete p, q:
```

## Parameters

### object

An arithmetical expression (Symbolic Math Toolbox), or a sequence on page 1-88, or a set on page 7-50, or a list on page 7-41 of such expressions

### f

A procedure on page 1-1654 or a functional expression on page 1-74

## Options

### **ApproximateFloats**

Approximate floating-point numbers by rational numbers.

### **FindRelations**

Detect algebraic dependencies for subexpressions of specified types.

### **DescendInto**

If the original expression contains subexpressions, rationalize the specified types of subexpressions.

### **ReplaceHardToEval**

Replace all subexpressions with limits, sums, and integrals by variables.

### **ReplaceTypes**

Replace all subexpressions of the specified types by variables.

### **StopOn**

Do not rationalize specified types of subexpressions.

### **StopOnConstants**

Do not rationalize numbers, strings, Boolean constants, NIL, FAIL, PI (Symbolic Math Toolbox), EULER (Symbolic Math Toolbox), and CATALAN (Symbolic Math Toolbox) in the set `Type::ConstantIdents`.

## Return Values

Object returned by the function `f`.

## See Also

### MuPAD Functions

map | rationalize

## matrix

Create a matrix or a vector

---

**Note** For matrices in MATLAB®, see “Matrices and Arrays” (MATLAB).

---

### Syntax

`matrix(Array)`

`matrix(List)`

`matrix(ListOfRows)`

`matrix(Matrix)`

`matrix(m, n)`

`matrix(m, n, Array)`

`matrix(m, n, List)`

`matrix(m, n, ListOfRows)`

`matrix(m, n, Table)`

`matrix(m, n, [(i1, j1) = value1, (i2, j2) = value2, ...])`

`matrix(m, n, f)`

`matrix(m, n, List, Diagonal)`

`matrix(m, n, g, Diagonal)`

`matrix(m, n, List, Banded)`

`matrix(1, n, [j1 = value1, j2 = value2, ...])`

`matrix(m, 1, [i1 = value1, i2 = value2, ...])`

## Description

`matrix(m, n, [[a11, a12, ...], [a21, a22, ...], ...])` returns an  $m \times n$  matrix of the domain type (Symbolic Math Toolbox) `Dom::Matrix()`.

`matrix(m, n, [a11, a12, ..., a21, a22, ..., a.m.n])` returns an  $m \times n$  matrix of the domain type (Symbolic Math Toolbox) `Dom::Matrix()`.

`matrix(m, 1, [a1, a2, ...])` returns an  $m \times 1$  column vector of the domain type (Symbolic Math Toolbox) `Dom::Matrix()`.

`matrix(1, n, [a1, a2, ...])` returns an  $1 \times n$  row vector of the domain type (Symbolic Math Toolbox) `Dom::Matrix()`.

`matrix` is equivalent to `Dom::Matrix()`.

`matrix` creates matrices and vectors. A column vector is represented as an  $m \times 1$  matrix. A row vector is represented as a  $1 \times n$  matrix.

Matrix and vector components must be arithmetical expressions (Symbolic Math Toolbox) (numbers and/or symbolic expressions). If matrices over special component rings are desired, use the domain constructor `Dom::Matrix` with a suitable component ring.

Arithmetical operations with matrices can be performed by using the standard arithmetical operators of MuPAD.

E.g., if `A` and `B` are two matrices defined by `matrix`, then `A + B` computes the sum and `A * B` computes the product of the two matrices, provided that the dimensions are appropriate.

Similarly, `A^(-1)` or `1/A` computes the inverse of a square matrix `A` if it can be inverted. Otherwise, `FAIL` is returned.

Cf. "Example 1" on page 1-1344 (Symbolic Math Toolbox).

Many system functions accept matrices as input, such as `map`, `subs`, `has`, `zip`, `conjugate`, `norm` or `exp`. Cf. "Example 4" on page 1-1348 (Symbolic Math Toolbox).

Most of the functions in the MuPAD linear algebra package `linalg` (Symbolic Math Toolbox) work with matrices. For example, the command `linalg::gaussJordan(A)` performs Gauss-Jordan elimination on `A` to transform `A` to its reduced row echelon form.

For numerical matrix computations, the corresponding functions of the `numeric` package accept matrices.

Matrix components can be extracted by the usual index operator `[ ]`, which also works for lists on page 7-41, arrays on page 7-2, and tables on page 1-2103. The call `A[i, j]` extracts the matrix component in the  $i$ -th row and the  $j$ -th column.

Assignments on page 1-257 to matrix components are performed similarly. The call `A[i, j] := c` replaces the matrix component in the  $i$ -th row and the  $j$ -th column of  $A$  by  $c$ .

If one of the indices is not in its valid range, an error message is issued.

The index operator also extracts submatrices. The call `A[r1..r2, c1..c2]` creates the submatrix of  $A$  comprising the rows with the indices  $r_1, r_1 + 1, \dots, r_2$  and the columns with the indices  $c_1, c_1 + 1, \dots, c_2$  of  $A$ .

See “Example 3” on page 1-1347 (Symbolic Math Toolbox) and “Example 5” on page 1-1350 (Symbolic Math Toolbox).

`matrix(Array)` or `matrix(Matrix)` create a new matrix with the same dimension and the components of `Array` or `Matrix`, respectively. The array on page 7-2 must not contain any uninitialized entries. If `Array` is one-dimensional, the result is a column vector. Cf. “Example 8” on page 1-1353 (Symbolic Math Toolbox).

`matrix(List)` creates an  $m \times 1$  column vector with components taken from the non-empty list on page 7-41, where  $m$  is the number of entries of `List`. Cf. “Example 5” on page 1-1350 (Symbolic Math Toolbox).

`matrix(ListOfRows)` creates an  $m \times n$  matrix with components taken from the nested list on page 7-41 `ListOfRows`, where  $m$  is the number of inner lists of `ListOfRows`, and  $n$  is the maximal number of elements of an inner list. Each inner list corresponds to a row of the matrix. Both  $m$  and  $n$  must be non-zero.

If a row has less than  $n$  entries, the remaining entries in the corresponding row of the matrix are regarded as zero. Cf. “Example 7” on page 1-1352 (Symbolic Math Toolbox).

The call `matrix(m, n)` returns the  $m \times n$  zero matrix.

The call `matrix(m, n, Array)` creates an  $m \times n$  matrix with components taken from `Array`, which must be an array on page 7-2 or an `hfarray` on page 7-27. `Array` must have  $m \cdot n$  operands. The first  $m$  operands define the first row, the next  $m$  operands define the second row, etc. The formatting of the array is irrelevant. E.g., any array with 6 elements can be used to create matrices of dimension  $1 \times 6$ , or  $2 \times 3$ , or  $3 \times 2$ , or  $6 \times 1$ .



`matrix(m, n, List)` creates an  $m \times n$  matrix with components taken row after row from the non-empty list on page 7-41. The list must contain  $m n$  entries. Cf. “Example 7” on page 1-1352 (Symbolic Math Toolbox).

`matrix(m, n, ListOfRows)` creates an  $m \times n$  matrix with components taken from the list on page 7-41 `ListOfRows`.

If  $m \geq 2$  and  $n \geq 2$ , then `ListOfRows` must consist of at most  $m$  inner lists, each having at most  $n$  entries. The inner lists correspond to the rows of the returned matrix.

If a row has less than  $n$  entries, the remaining components of the corresponding row of the matrix are regarded as zero. If there are less than  $m$  rows, the remaining lower rows of the matrix are filled with zeroes. Cf. “Example 7” on page 1-1352 (Symbolic Math Toolbox).

`matrix(m,n,Table)` creates an  $m \times n$  matrix with components taken from the table on page 1-2103 `Table`. The table entries `Table[i, j]` with positive integer values of  $i$  and  $j$  define the corresponding entries of the matrix. Zero entries need not be specified in the table. This way, sparse table input can be used to create the matrix.

For large sparse matrices, the fastest way of creation is the generation of an empty table that is filled by indexed assignments and then passed to `matrix`. Alternatively, one may first create an empty sparse matrix via `matrix(m, n)` and then fill in the non-zero entries via indexed assignments. Note that the indexed assignment to a matrix is somewhat slower than the indexed assignment to a table.

`matrix(m, n, [(i1, j1) = value1, (i2, j2) = value2, ...])` is a further way to create a matrix specifying only the non-zero entries  $A[i1, j1] = \text{value1}$ ,  $A[i2, j2] = \text{value2}$  etc. The ordering of the entries in the input list is irrelevant.

`matrix(m, n, f)` returns the matrix whose  $(i, j)$ -th component is the return value of the function call  $f(i, j)$ . The row index  $i$  runs from 1 to  $m$  and the column index  $j$  from 1 to  $n$ . Cf. “Example 9” on page 1-1355 (Symbolic Math Toolbox).

`matrix(m, 1, Array)` returns the  $m \times 1$  column vector with components taken from `Array`. The array or `harray` `Array` must have  $m$  entries.

`matrix(m, 1, List)` returns the  $m \times 1$  column vector with components taken from `List`. The list `List` must have no more than  $m$  entries. If there are fewer entries, the remaining vector components are regarded as zero. Cf. “Example 5” on page 1-1350 (Symbolic Math Toolbox).

`matrix(m, 1, Table)` returns the  $m \times 1$  column vector with components taken from `Table`. The table `Table` must have no more than  $m$  entries. If there are fewer entries, the remaining vector components are regarded as zero. Cf. “Example 6” on page 1-1351 (Symbolic Math Toolbox).

`matrix(m, 1, [i1 = value1, i2 = value2, ...])` provides a way to create a sparse column vector specifying only the non-zero entries  $A[i1] = \text{value1}$ ,  $A[i2] = \text{value2}$  etc. The ordering of the entries in the input list is irrelevant.

`matrix(1, n, Array)` returns the  $1 \times n$  row vector with components taken from `Array`. The array or `harray` `Array` must have  $n$  entries.

`matrix(1, n, List)` returns the  $1 \times n$  row vector with components taken from `List`. The list `List` must not have more than  $n$  entries. If there are fewer entries, the remaining vector components are regarded as zero. Cf. “Example 5” on page 1-1350 (Symbolic Math Toolbox).

`matrix(1, n, Table)` returns the  $1 \times n$  row vector with components taken from `Table`. The table `Table` must not have more than  $n$  entries. If there are fewer entries, the remaining vector components are regarded as zero. Cf. “Example 6” on page 1-1351 (Symbolic Math Toolbox).

`matrix(1, n, [j1 = value1, j2 = value2, ...])` provides a way to create a sparse row vector specifying only the non-zero entries  $A[j1] = \text{value1}$ ,  $A[j2] = \text{value2}$  etc. The ordering of the entries in the input list is irrelevant.

---

**Note** The number of rows and columns, respectively, of a matrix must be less than  $2^{31}$ .

---

---

**Note** The components of a matrix are no longer evaluated after the creation of the matrix, i.e., if they contain free identifiers they will not be replaced by their values.

---

## Examples

### Example 1

We create a  $2 \times 2$  matrix by passing a list of two rows to `matrix`, where each row is a list of two elements:

```
A := matrix([[1, 5], [2, 3]])
```

$$\begin{pmatrix} 1 & 5 \\ 2 & 3 \end{pmatrix}$$

In the same way, we generate the following  $2 \times 3$  matrix:

```
B := matrix([[ -1, 5/2, 3], [1/3, 0, 2/5]])
```

$$\begin{pmatrix} -1 & \frac{5}{2} & 3 \\ \frac{1}{3} & 0 & \frac{2}{5} \end{pmatrix}$$

We can do matrix arithmetic using the standard arithmetical operators of MuPAD. For example, the matrix product  $AB$ , the fourth power of  $A$ , and the scalar multiplication of  $A$  by  $\frac{1}{3}$  are given by:

```
A * B, A^4, 1/3 * A
```

$$\begin{pmatrix} \frac{2}{3} & \frac{5}{2} & 5 \\ -1 & 5 & \frac{36}{5} \end{pmatrix}, \begin{pmatrix} 281 & 600 \\ 240 & 521 \end{pmatrix}, \begin{pmatrix} \frac{1}{3} & \frac{5}{3} \\ \frac{2}{3} & 1 \end{pmatrix}$$

Since the dimensions of the matrices  $A$  and  $B$  differ, the sum of  $A$  and  $B$  is not defined and MuPAD returns an error message:

```
A + B
```

```
Error: Dimensions do not match. [(Dom::Matrix(Dom::ExpressionField()))::_plus]
```

To compute the inverse of  $A$ , enter:

```
1/A
```

$$\begin{pmatrix} -\frac{3}{7} & \frac{5}{7} \\ \frac{2}{7} & -\frac{1}{7} \end{pmatrix}$$

If a matrix is not invertible, the result of this operation is FAIL:

```
C := matrix([[2, 0], [0, 0]])
```

$$\begin{pmatrix} 2 & 0 \\ 0 & 0 \end{pmatrix}$$

```
C^(-1)
```

FAIL

```
delete A, B, C:
```

## Example 2

In addition to standard matrix arithmetic, the library `linalg` (Symbolic Math Toolbox) offers numerous functions handling matrices. For example, the function `linalg::rank` determines the rank of a matrix:

```
A := matrix([[1, 5], [2, 3]])
```

$$\begin{pmatrix} 1 & 5 \\ 2 & 3 \end{pmatrix}$$

```
linalg::rank(A)
```

2

The function `linalg::eigenvectors` computes the eigenvalues and the eigenvectors of A:

```
linalg::eigenvectors(A)
```

$$\left[ \left[ 2 - \sqrt{11}, 1, \begin{pmatrix} -\frac{\sqrt{11}}{2} - \frac{1}{2} \\ 1 \end{pmatrix} \right], \left[ \sqrt{11} + 2, 1, \begin{pmatrix} \frac{\sqrt{11}}{2} - \frac{1}{2} \\ 1 \end{pmatrix} \right] \right]$$

To determine the dimension of a matrix, use the function `linalg::matdim`:

```
linalg::matdim(A)
```

```
[2, 2]
```

The result is a list of two positive integers, the row and column number of the matrix.

Use `info(linalg)` to obtain a list of available functions, or enter `?linalg` for details about this library.

```
delete A:
```

### Example 3

Matrix entries can be accessed with the index operator [ ]:

```
A := matrix([[1, 2, 3, 4], [2, 0, 4, 1], [-1, 0, 5, 2]])
```

$$\begin{pmatrix} 1 & 2 & 3 & 4 \\ 2 & 0 & 4 & 1 \\ -1 & 0 & 5 & 2 \end{pmatrix}$$

```
A[2, 1] * A[1, 2] - A[3, 1] * A[1, 3]
```

```
7
```

You can redefine a matrix entry by assigning a value to it:

```
A[1, 2] := a^2: A
```

$$\begin{pmatrix} 1 & a^2 & 3 & 4 \\ 2 & 0 & 4 & 1 \\ -1 & 0 & 5 & 2 \end{pmatrix}$$

The index operator can also be used to extract submatrices. The following call creates a copy of the submatrix of  $A$  comprising the second and the third row and the first three columns of  $A$ :

```
A[2..3, 1..3]
```

$$\begin{pmatrix} 2 & 0 & 4 \\ -1 & 0 & 5 \end{pmatrix}$$

The index operator does *not* allow to replace a submatrix of a given matrix by another matrix. Use `linalg::substitute` to achieve this.

```
delete A:
```

### Example 4

Some system functions can be applied to matrices. For example, if you have a matrix with symbolic entries and want to have all entries in expanded form, simply apply the function `expand`:

```
delete a, b:  
A := matrix(  
  [(a - b)^2, a^2 + b^2],  
  [a^2 + b^2, (a - b)*(a + b)]  
)
```

$$\begin{pmatrix} (a-b)^2 & a^2 + b^2 \\ a^2 + b^2 & (a+b)(a-b) \end{pmatrix}$$

```
expand(A)
```

$$\begin{pmatrix} a^2 - 2ab + b^2 & a^2 + b^2 \\ a^2 + b^2 & a^2 - b^2 \end{pmatrix}$$

You can differentiate all matrix components with respect to some indeterminate:

```
diff(A, a)
```

$$\begin{pmatrix} 2a - 2b & 2a \\ 2a & 2a \end{pmatrix}$$

The following command evaluates all matrix components at a given point:

```
subs(A, a = 1, b = -1)
```

$$\begin{pmatrix} 4 & 2 \\ 2 & 0 \end{pmatrix}$$

Note that the function `subs` does not evaluate the result of the substitution. For example, we define the following matrix:

```
A := matrix([[sin(x), x], [x, cos(x)]])
```

$$\begin{pmatrix} \sin(x) & x \\ x & \cos(x) \end{pmatrix}$$

Then we substitute  $x = 0$  in each matrix component:

```
B := subs(A, x = 0)
```

$$\begin{pmatrix} \sin(0) & 0 \\ 0 & \cos(0) \end{pmatrix}$$

You see that the matrix components are not evaluated completely. For example, if you enter `sin(0)` directly, it evaluates to zero.

The function `eval` can be used to evaluate the result of the function `subs`. However, `eval` does not operate on matrices directly, and you must use the function `map` to apply the function `eval` to each matrix component:

```
map(B, eval)
```

$$\begin{pmatrix} 0 & 0 \\ 0 & 1 \end{pmatrix}$$

The function `zip` can be applied to matrices. The following call combines two matrices  $A$  and  $B$  by dividing each component of  $A$  by the corresponding component of  $B$ :

```
A := matrix([[4, 2], [9, 3]]):
B := matrix([[2, 1], [3, -1]]):
A, B, zip(A, B, `/`)
```

$$\begin{pmatrix} 4 & 2 \\ 9 & 3 \end{pmatrix}, \begin{pmatrix} 2 & 1 \\ 3 & -1 \end{pmatrix}, \begin{pmatrix} 2 & 2 \\ 3 & -3 \end{pmatrix}$$

`delete A, B:`

## Example 5

A vector is either an  $m \times 1$  matrix (a column vector) or a  $1 \times n$  matrix (a row vector). To create a vector with `matrix`, pass the dimension of the vector and a list of vector components as argument to `matrix`:

```
row_vector := matrix(1, 3, [1, 2, 3]);  
column_vector := matrix(3, 1, [1, 2, 3])
```

$$(1 \ 2 \ 3)$$

$$\begin{pmatrix} 1 \\ 2 \\ 3 \end{pmatrix}$$

If the only argument of `matrix` is a non-nested list or a one-dimensional array, the result is a column vector:

```
matrix([1, 2, 3])
```

$$\begin{pmatrix} 1 \\ 2 \\ 3 \end{pmatrix}$$

For a row vector `r`, the calls `r[1, i]` and `r[i]` both return the  $i$ -th vector component of `r`. Similarly, for a column vector `c`, the calls `c[i, 1]` and `c[i]` both return the  $i$ -th vector component of `c`.

We extract the second component of the vectors defined above:

```
row_vector[2] = row_vector[1, 2],  
column_vector[2] = column_vector[2, 1]
```

$$2 = 2, 2 = 2$$



Use the function `linalg::vecdim` to determine the number of components of a vector:

```
linalg::vecdim(row_vector), linalg::vecdim(column_vector)
```

```
3, 3
```

The number of components of a vector can also be determined directly by the call `nops(vector)`.

The dimension of a vector can be determined as described above in the case of matrices:

```
linalg::matdim(row_vector),  
linalg::matdim(column_vector)
```

```
[1, 3], [3, 1]
```

See the `linalg` (Symbolic Math Toolbox) package for functions working with vectors, and the help page of `norm` for computing vector norms.

```
delete row_vector, column_vector:
```

## Example 6

A vector is either an  $m \times 1$  matrix (a column vector) or a  $1 \times n$  matrix (a row vector). To create a vector with `matrix`, one may also pass the dimension of the vector and a table of vector components as argument to `matrix`:

```
delete v1, v2, t1, t2:  
t1 := table():  
t1[1,1] := 1:  
t1[1,2] := 2:  
t1[1,3] := 3:  
v1 := matrix(1, 3, t1);
```

```
(1 2 3)
```

```
t2 := table():  
t2[1,1] := 1:  
t2[2,1] := 2:
```

```
t2[3,1] := 3:  
v2 := matrix(3, 1, t2);
```

$$\begin{pmatrix} 1 \\ 2 \\ 3 \end{pmatrix}$$

All functions applied to the vectors in the previous example (see above) can also be used on these vectors.

```
delete t1, t2, v1, v2;
```

## Example 7

In the following examples, we illustrate various calls of `matrix` as described above. We start by passing a nested list to `matrix`, where each inner list corresponds to a row of the matrix:

```
matrix([[1, 2], [2]])
```

$$\begin{pmatrix} 1 & 2 \\ 2 & 0 \end{pmatrix}$$

The number of rows of the created matrix is the number of inner lists, namely  $m = 2$ . The number of columns is determined by the maximal number of entries of an inner list. In the example above, the first list is the longest one, and hence  $n = 2$ . The second list has only one element and, therefore, the second entry in the second row of the returned matrix was set to zero.

In the following call, we use the same nested list, but in addition pass two dimension parameters to create a  $4 \times 4$  matrix:

```
matrix(4, 4, [[1, 2], [2]])
```

$$\begin{pmatrix} 1 & 2 & 0 & 0 \\ 2 & 0 & 0 & 0 \\ 0 & 0 & 0 & 0 \\ 0 & 0 & 0 & 0 \end{pmatrix}$$

In this case, the dimension of the matrix is given by the dimension parameters. As before, missing entries in an inner list correspond to zero, and in addition missing rows are treated as zero rows.

If the dimension  $m \times n$  of the matrix is stated explicitly, the entries may also be specified by a plain list with  $m n$  elements. The matrix is filled with these elements row by row:

```
matrix(2, 3, [1, 2, 3, 4, 5, 6])
```

$$\begin{pmatrix} 1 & 2 & 3 \\ 4 & 5 & 6 \end{pmatrix}$$

```
matrix(3, 2, [1, 2, 3, 4, 5, 6])
```

$$\begin{pmatrix} 1 & 2 \\ 3 & 4 \\ 5 & 6 \end{pmatrix}$$

## Example 8

A one- or two-dimensional array of arithmetical expressions, such as:

```
a := array(1..3, 2..4,
  [[1, 1/3, 0], [-2, 3/5, 1/2], [-3/2, 0, -1]]
)
```

$$\begin{pmatrix} 1 & \frac{1}{3} & 0 \\ -2 & \frac{3}{5} & \frac{1}{2} \\ -\frac{3}{2} & 0 & -1 \end{pmatrix}$$

can be converted into a matrix as follows:

```
A := matrix(a)
```

$$\begin{pmatrix} 1 & \frac{1}{3} & 0 \\ -2 & \frac{3}{5} & \frac{1}{2} \\ -\frac{3}{2} & 0 & -1 \end{pmatrix}$$

Arrays serve, for example, as an efficient structured data type for programming. However, arrays do not have any algebraic meaning, and no mathematical operations are defined for them. If you convert an array into a matrix, you can use the full functionality defined for matrices as described above. For example, let us compute the matrix  $2A - A^2$  and the Frobenius norm of  $A$ :

```
2*A - A^2, norm(A, Frobenius)
```

$$\begin{pmatrix} \frac{5}{3} & \frac{2}{15} & -\frac{1}{6} \\ -\frac{1}{20} & \frac{113}{75} & \frac{6}{5} \\ -3 & \frac{1}{2} & -3 \end{pmatrix}, \frac{\sqrt{2} \sqrt{4037}}{30}$$

Note that an array may contain uninitialized entries:

```
b := array(1..4): b[1] := 2: b[4] := 0: b
```

```
(2 NIL NIL 0)
```

`matrix` cannot handle arrays that have uninitialized entries, and responds with an error message:

```
matrix(b)
```

```
Error: Unable to define a matrix over 'Dom::ExpressionField()'. [(Dom::Matrix(Dom::Exp
```

We initialize the remaining entries of the array `b` and convert it into a matrix, or more precisely, into a column vector:

```
b[2] := 0: b[3] := -1: matrix(b)
```

$$\begin{pmatrix} 2 \\ 0 \\ -1 \\ 0 \end{pmatrix}$$

delete a, A, b:

## Example 9

We show how to create a matrix whose components are defined by a function of the row and the column index. The entry in the  $i$ -th row and the  $j$ -th column of a Hilbert matrix

(see also `linalg::hilbert`) is  $\frac{1}{(i+j-1)}$ . Thus the following command creates a  $2 \times 2$  Hilbert matrix:

```
matrix(2, 2, (i, j) -> 1/(i + j - 1))
```

$$\begin{pmatrix} 1 & \frac{1}{2} \\ \frac{1}{2} & \frac{1}{3} \end{pmatrix}$$

The following two calls produce different results. In the first call,  $x$  is regarded as an unknown function, while it is a constant in the second call:

```
delete x;
matrix(2, 2, x), matrix(2, 2, (i, j) -> x)
```

$$\begin{pmatrix} x(1, 1) & x(1, 2) \\ x(2, 1) & x(2, 2) \end{pmatrix}, \begin{pmatrix} x & x \\ x & x \end{pmatrix}$$

## Example 10

Diagonal matrices can be created by passing the option `Diagonal` and a list of diagonal entries:

```
matrix(3, 4, [1, 2, 3], Diagonal)
```

$$\begin{pmatrix} 1 & 0 & 0 & 0 \\ 0 & 2 & 0 & 0 \\ 0 & 0 & 3 & 0 \end{pmatrix}$$

One can generate the 3×3 identity matrix as follows:

```
matrix::identity(3)
```

$$\begin{pmatrix} 1 & 0 & 0 \\ 0 & 1 & 0 \\ 0 & 0 & 1 \end{pmatrix}$$

Here are alternative ways to create this matrix:

```
matrix(3, 3, [1 $ 3], Diagonal)
```

$$\begin{pmatrix} 1 & 0 & 0 \\ 0 & 1 & 0 \\ 0 & 0 & 1 \end{pmatrix}$$

Equivalently, you can use a function of one argument:

```
matrix(3, 3, i -> 1, Diagonal)
```

$$\begin{pmatrix} 1 & 0 & 0 \\ 0 & 1 & 0 \\ 0 & 0 & 1 \end{pmatrix}$$

Since the integer 1 also represents a constant function, the following shorter call creates the same matrix:

```
matrix(3, 3, 1, Diagonal)
```

$$\begin{pmatrix} 1 & 0 & 0 \\ 0 & 1 & 0 \\ 0 & 0 & 1 \end{pmatrix}$$

To demonstrate the use of tables for creating (sparse) matrices we can also create the identity matrix above by the lines:

```
t := table(): t[1, 1] := 1: t[2, 2] := 1: t[3, 3] := 1:
matrix(3, 3, t)
```

$$\begin{pmatrix} 1 & 0 & 0 \\ 0 & 1 & 0 \\ 0 & 0 & 1 \end{pmatrix}$$

```
delete t:
```

## Example 11

Banded Toeplitz matrices can be created with the option `Banded`. The following command creates a tri-diagonal matrix with constant bands:

```
matrix(4, 4, [-1, 2, -1], Banded)
```

$$\begin{pmatrix} 2 & -1 & 0 & 0 \\ -1 & 2 & -1 & 0 \\ 0 & -1 & 2 & -1 \\ 0 & 0 & -1 & 2 \end{pmatrix}$$

## Example 12

Matrices can also be created by using a `table`:

```
t := table():
t[1, 2] := 12:
t[3, 1] := 31:
t[3, 2] := 32:
t
```

$$\begin{array}{cc|c} 1, 2 & & 12 \\ 3, 1 & & 31 \\ 3, 2 & & 32 \end{array}$$

The missing table entries correspond to empty matrix entries:

```
A := matrix(4, 6, t)
```

$$\begin{pmatrix} 0 & 12 & 0 & 0 & 0 & 0 \\ 0 & 0 & 0 & 0 & 0 & 0 \\ 31 & 32 & 0 & 0 & 0 & 0 \\ 0 & 0 & 0 & 0 & 0 & 0 \end{pmatrix}$$

By using tables, one can easily create large (sparse) matrices without being forced to define all zero entries of the matrix. Note that this is a great advantage over using arrays where every component has to be initialized before.

```
delete t, A:
```

### Example 13

The method "doprint" of `Dom::Matrix()` prints only the non-zero components of a sparse matrix:

```
A := matrix(4, 6):  
A[1, 2] := 12: A[3, 1] := 31: A[3, 2] := 32:  
print(A::dom::doprint(A)):
```

$$\begin{pmatrix} 0 & 12 & 0 & 0 & 0 & 0 \\ 0 & 0 & 0 & 0 & 0 & 0 \\ 31 & 32 & 0 & 0 & 0 & 0 \\ 0 & 0 & 0 & 0 & 0 & 0 \end{pmatrix}$$

```
delete A:
```

## Parameters

### Array

A one- or two-dimensional array on page 7-2 or `hfarray` on page 7-27

### List

A list on page 7-41 of arithmetical expressions (Symbolic Math Toolbox)



**ListOfRows**

A nested list on page 7-41 of rows, each row being a list of arithmetical expressions (Symbolic Math Toolbox)

**Matrix**

A matrix, i.e., an object of a data type of category `Cat::Matrix`

**Table**

A table on page 1-2103 of matrix components

**m**

The number of rows: a positive integer on page 7-31

**n**

The number of columns: a positive integer on page 7-31

**f**

A function (Symbolic Math Toolbox) or a functional expression (Symbolic Math Toolbox) of two arguments

**g**

A function or a functional expression of one argument

 **$i_1, i_2, \dots$** 

Row indices: integers between 1 and  $m$

 **$j_1, j_2, \dots$** 

Column indices: integers between 1 and  $m$

 **$value_1, value_2, \dots$** 

Matrix entries: arithmetical expressions (Symbolic Math Toolbox)

## Options

### Diagonal

Create a diagonal matrix

With this option, diagonal matrices can be created with diagonal elements taken from a list on page 7-41, or computed by a function (Symbolic Math Toolbox) or a functional expression (Symbolic Math Toolbox).

`matrix(m, n, List, Diagonal)` creates the  $m \times n$  diagonal matrix whose diagonal elements are the entries of `List`. Cf. “Example 10” on page 1-1355 (Symbolic Math Toolbox).

`List` must have no more than  $\min(m, n)$  entries. If it has fewer elements, the remaining diagonal elements are regarded as zero.

`matrix(m, n, g, Diagonal)` returns the sparse matrix whose  $i$ -th diagonal element is `g(i, i)`, where the index  $i$  runs from 1 to  $\min(m, n)$ . Cf. “Example 10” on page 1-1355 (Symbolic Math Toolbox).

### Banded

Create a banded Toeplitz matrix

A *banded matrix* has zero entries outside the main diagonal and some of the adjacent sub- and superdiagonals.

`matrix(m, n, List, Banded)` creates an  $m \times n$  banded Toeplitz matrix with the elements of `List` as entries. The number of entries of `List` must be odd, say  $2h + 1$ , where  $h$  must not exceed  $n$ . The bandwidth of the resulting matrix is at most  $h$ .

All elements of the main diagonal of the created matrix are initialized with the middle element of `List`. All elements of the  $i$ -th subdiagonal are initialized with the  $(h + 1 - i)$ -th element of `List`. All elements of the  $i$ -th superdiagonal are initialized with the  $(h + 1 + i)$ -th element of `List`. All entries on the remaining sub- and superdiagonals are regarded as zero.

Cf. “Example 11” on page 1-1357 (Symbolic Math Toolbox).

## Return Values

Matrix of the domain type (Symbolic Math Toolbox) `Dom::Matrix()`.

## See Also

### MuPAD Domains

`DOM_ARRAY` | `DOM_HFARRAY` | `Dom::DenseMatrix` | `Dom::Matrix`

### MuPAD Functions

`array` | `densematrix` | `hfarray`

## Topics

“Create Matrices” (Symbolic Math Toolbox)

“Create Vectors” (Symbolic Math Toolbox)

“Create Special Matrices” (Symbolic Math Toolbox)

“Create Matrices over Particular Rings” (Symbolic Math Toolbox)

## max

Maximum of numbers

### Syntax

```
max(x1, x2, , ...)
```

```
max({x1, x2, ...})
```

```
max([x1, x2, ...])
```

```
max(A)
```

### Description

`max(x1, x2, ...)` returns the maximum of the numbers  $x_1, x_2, \dots$

If the arguments of `max` are either integers on page 7-31, rational numbers on page 7-48, or floating-point numbers on page 7-23, then `max` returns the numerical maximum of these arguments.

Exact numerical expressions such as `PI + sqrt(2)` etc. are internally converted to floating-point intervals on page 1-940 using the current value of `DIGITS`. After comparison, the exact expression is restored in the return value. If the current value of `DIGITS` does not suffice to determine the maximum of several expressions, a symbolic call of `max` is returned. Cf. “Example 2” on page 1-1364 (Symbolic Math Toolbox).

The call `max()` is illegal and leads to an error message. If there is only one argument `x1`, then `max` evaluates `x1` and returns it. Cf. “Example 3” on page 1-1365 (Symbolic Math Toolbox).

If one of the arguments is `infinity`, then `max` returns `infinity`. If an argument is `-infinity`, then it is removed from the argument list. Cf. “Example 4” on page 1-1365 (Symbolic Math Toolbox).

`max` returns an error when one of its arguments is a complex number on page 7-84 or a floating point interval with non-zero imaginary part. Cf. “Example 3” on page 1-1365 (Symbolic Math Toolbox).

If one of the arguments is not a number (Symbolic Math Toolbox), then a symbolic `max` call with the maximum of the numerical arguments and the remaining evaluated arguments may be returned. Cf. “Example 1” on page 1-1363 (Symbolic Math Toolbox).

Nested `max` calls with symbolic arguments are rewritten as a single `max` call, i.e., they are flattened (Symbolic Math Toolbox). Cf. “Example 5” on page 1-1366 (Symbolic Math Toolbox).

`max` reacts to a very limited set of properties (Symbolic Math Toolbox) of identifiers set via `assume`. Use `simplify` to handle more general assumptions. Cf. “Example 5” on page 1-1366 (Symbolic Math Toolbox).

## Environment Interactions

When called with exact numerical expressions such as `PI`, `sqrt(2)` etc., the function is sensitive to the environment variable `DIGITS`, which determines the numerical working precision.

## Examples

### Example 1

`max` computes the maximum of integers, rational numbers, and floating-point values:

```
max(-3/2, 7, 1.4)
```

```
7
```

Floating point intervals are interpreted as “any number within this range” and may thus cause symbolic `max` calls to be returned:

```
max(2...3 union 6...7, 4)
```

```
max(2.0 ... 3.0 ∪ 6.0 ... 7.0, 4)
```

```
max(2...3, 6...7, 4)
```

6.0 ... 7.0

```
max(2...3, PI)
```

$\pi$

If the argument list contains symbolic expressions, then a symbolic `max` call may be returned:

```
delete b:  
max(-4, b + 2, 1, 3)
```

$\max(b + 2, 3)$

In the following two examples, `max` is able to determine the maximum despite getting symbolic arguments (contrast this with `<`):

```
max(sqrt(2), 1)
```

$\sqrt{2}$

```
assume(x > 0):  
max(exp(x), exp(-x))
```

$e^x$

## Example 2

The following rational number `pi` approximates  $\pi$  to about 20 decimal places:

```
pi := 314159265358979323846/10^20:
```

With the default value `DIGITS = 10`, the function `max` cannot distinguish between `PI` and `pi` via floating-point approximations:

```
max(pi, PI)
```

$$\max\left(\frac{157079632679489661923}{5000000000000000000}, \pi\right)$$

With an increased value of DIGITS, the floating-point interval approximation of PI considered by max allows to decide that PI is larger than pi:

```
DIGITS := 20:
max(pi, PI)
```

$\pi$

```
delete pi, DIGITS:
```

### Example 3

max with one argument returns the evaluated argument:

```
delete a:
max(a), max(sin(2*PI)), max(2)
```

$a, 0, 2$

Complex numbers lead to an error message:

```
max(0, 1, I)
```

Error: Invalid argument. [max]

### Example 4

infinity is always the maximum of arbitrary arguments:

```
delete x:
max(100000000000, infinity, x)
```

$\infty$

-infinity is removed from the argument list:

```
max(1000000000000, -infinity, x)
```

```
max(1000000000000, x)
```

## Example 5

max reacts only to very few properties (Symbolic Math Toolbox) of identifiers set via assume:

```
delete a, b, c;  
assume(a > 0 and b > a and c > b);  
max(a, max(b, c), 0)
```

```
max(a, b, c)
```

An application of `simplify` yields the desired result:

```
simplify(%)
```

```
c
```

## Parameters

`x1, x2, ...`

Arbitrary MuPAD objects

**A**

An array of domain type (Symbolic Math Toolbox) `DOM_HFARRAY` with real entries

## Return Values

One of the arguments, a floating-point number, or a symbolic `max` call.



## Overloaded By

## See Also

### MuPAD Functions

`_leequal` | `_less` | `min` | `sort` | `sysorder`

## MAXDEPTH

Prevent infinite recursion during procedure calls

### Description

The environment variable `MAXDEPTH` determines the maximal recursion depth of nested procedure calls. When this recursion depth is reached, an error occurs.

Possible values: Positive integer on page 7-31; the maximum value depends on the operating system, see below.

The purpose of `MAXDEPTH` is to provide a heuristic for recognizing infinite recursion with respect to procedure on page 7-45 calls, like in `p := x -> p(x) : p(0)`. If, in this example, the recursion depth would not be limited, then the procedure `p` would call itself recursively infinitely often, and the system would “hang”.

If during the evaluation of an object the recursion depth `MAXDEPTH` is reached, then the computation is aborted with an error.

Similarly, the environment variable `MAXLEVEL` provides a heuristic for recognizing infinite recursion with respect to the substitution of values for identifiers on page 7-29; see the corresponding help page for details and examples.

The default value of `MAXDEPTH` is 500; `MAXDEPTH` has this value after starting or resetting the system via `reset`. Also the command `delete MAXDEPTH` restores the default value.

`MAXDEPTH` is a global variable. Use the statement `save MAXDEPTH` in a procedure to confine any changes to `MAXDEPTH` to this procedure.

The maximum value of `MAXDEPTH` depends on the operating system. Under Windows it is  $2^{11} = 2048$ . Under UNIX operating systems the maximum value depends on the maximum size of the C-stack. With a default stack size of 8 MB the value is 2048, too; with a bigger stack size it can be bigger (in a bash the stack size can be set with `ulimit -s`).

## Examples

### Example 1

Evaluation of objects defined by an infinite recursion produces an error:

```
p := proc() begin p() end_proc: p()
```

```
Error: Recursive definition: Reached maximal depth for nested procedure calls.
Evaluating: p
```

This also works for mutually recursive definitions:

```
p := proc(x) begin q(x + 1)^2 end_proc:
q := proc(y) begin p(x) + 2 end_proc:
p(0)
```

```
Error: Recursive definition: Reached maximal depth for nested procedure calls.
Evaluating: p
```

### Example 2

If the maximal recursion depth is reached, then this does not necessarily mean that infinite recursion is involved. The following recursive procedure computes the factorial of a nonnegative integer. If we set the maximal recursion depth to a smaller value than necessary to compute  $5!$ , then an error occurs:

```
factorial := proc(n) begin
  if n = 0 then 1
  else n*factorial(n - 1)
  end_if
end_proc:
MAXDEPTH := 4: factorial(5)
```

```
Error: Recursive definition: Reached maximal depth for nested procedure calls.
Evaluating: factorial
```

If we set MAXDEPTH to 5, then the recursion depth is big enough for computing  $5!$ . The command `delete MAXDEPTH` resets MAXDEPTH to its default value 500:

```
MAXDEPTH := 5: factorial(5); delete MAXDEPTH:
```

120

## See Also

### MuPAD Functions

LEVEL | MAXLEVEL | eval | freeze | level | proc

# MAXEFFORT

Maximum amount of work to spend on the computation

## Description

The environment variable MAXEFFORT determines the amount of effort allowed for heuristical parts of a computation, measured in “working units”. The default value is `MAXEFFORT = 1000000`.

Possible values: Non-negative floating-point number; or `infinity`.

MAXEFFORT determines the maximum number of “working units” that may be spent on internal heuristics.

One working unit roughly corresponds to 1000 evaluation steps done by an average kernel function.

Whatever MAXEFFORT is set to, every MuPAD function returns a correct though possibly unsimplified result; in particular, some functions may return unevaluated. MAXEFFORT determines the amount of additional time spent on obtaining a better or more simplified result; a value of `infinity` means that all built-in heuristics are really tried, a value of `0` means that all heuristics that might take considerable effort are left out.

A function whose result is uniquely specified has no way to react to MAXEFFORT.

Other functions carry out, in any event, all computations necessary to obtain some correct result; MAXEFFORT only determines the time available for improving that result. In case of functions that may return unevaluated immediately (e.g., `solve` or `int`), or may return their input immediately (as, e.g., `simplify`), or may answer a question by `UNKNOWN` immediately (as, e.g., `is`), all of their time consumption is counted to be spent on heuristics (purely heuristic functions).

Purely heuristic functions will usually return immediately if their input is quite complicated in relation to the effort allowed. This is also true if the user has provided that input on the interactive level. In order to pose a difficult problem where a longer running time is acceptable, MAXEFFORT should be increased.

A simplification achieved by heuristic methods may speed up the deterministic parts, such that a small value of `MAXEFFORT` does not necessarily decrease the total computing time.

The user may employ `MAXEFFORT` in his own functions as follows: any function may use the amount of effort given by `MAXEFFORT` partly for own overhead, and distribute the rest on the functions it calls. To do this, the caller has to `save` the variable `MAXEFFORT` and set it to whatever it wants to make available to the called function. Depending on whether the call is necessary to obtain a correct result at all and whether the called function is a heuristic one, there are the following cases to handle. If the call is necessary and the called function is deterministic, `MAXEFFORT` has no influence. If the call is not absolutely necessary and as far as the called function is deterministic, the caller has to subtract the necessary amount as own overhead from `MAXEFFORT` if enough is available; otherwise, such call must not take place. As far as the called function works heuristically (for whatever reason it was called), it has to limit its efforts to the amount given by `MAXEFFORT`.

In no event may the value of `MAXEFFORT` on entering a procedure be different from the value on leaving it, even not in case of an error. `save` must be used to ensure this.

No function may distribute and/or use more than the amount it has been given by its caller. The own overhead should be estimated; if it is supposedly small, `MAXEFFORT` may be ignored.

In order to avoid casual, not reproducible effects, e.g., by other programs running on the same computer, `MAXEFFORT` should not be used in connection with time measurement using `time` or `rtime`. For example, the running time saved in one recursive call according to time measurement must not be supplied to another recursive call.

## Examples

### Example 1

The decomposition of an integer into prime factors is unique; hence the result of `ifactor` is uniquely determined, such that `ifactor` does not react to `MAXEFFORT`:

```
MAXEFFORT:= 0:  
ifactor(2^10 + 1)
```

$5^2 41$

## Example 2

The `solve` function can return unevaluated. For example, this happens if there is no effort left to spend on the computation:

```
MAXEFFORT:= 0:
solve(ln(x) + x = 3, x)
```

$$\text{solve}(x + \ln(x) - 3 = 0, x)$$

## Example 3

Increasing the value of `MAXEFFORT` can help solve equations, for which the solver normally returns unevaluated results. The following example uses `MAXEFFORT = 100` and  $x^{1000}$  because running this example for the default value `MAXEFFORT = 1000000` and  $x^{100000000}$  takes many hours.

When you use `MAXEFFORT = 100`, the solver returns unevaluated result for the following equation.

```
MAXEFFORT:= 100:
solve(ln(x) + x^1000 = 3, x)
```

$$\text{solve}(\ln(x) + x^{1000} - 3 = 0, x)$$

Setting the `MAXEFFORT` to `200` allows the solver to return an explicit solution. To display the solution, delete the colon at the end of the `solve` command.

```
MAXEFFORT:= 200:
solve(ln(x) + x^1000 = 3, x):
```

Warning: Possibly spurious solutions. `[solvelib::checkSolutions]`

You can set the value of `MAXEFFORT` to `infinity` to ensure that the system will try all built-in heuristics. Note that for some computations, setting `MAXEFFORT` to `infinity` might lead to extremely long computation times.

## See Also

### MuPAD Functions

`prog::ntime` | `time` | `traperror`



# MAXLEVEL

Prevent infinite recursion during evaluation

## Description

The environment variable MAXLEVEL determines the maximal substitution depth of identifiers. When this substitution depth is reached, an error occurs.

Possible values: integer on page 7-31 greater 2; the maximum value depends on the operating system, see below.

When a MuPAD object is evaluated, identifiers on page 7-29 occurring in it are replaced by their values. This happens recursively, i.e., if the values themselves contain identifiers, then these are replaced as well. MAXLEVEL determines the maximal recursion depth of this process. If the substitution depth MAXLEVEL is reached, then an error occurs.

The purpose of MAXLEVEL is to provide a heuristic for recognizing infinite recursion with respect to the replacement of identifiers by their values, like in `delete a: a := a + 1; a`. If, in this example, the substitution depth would not be limited, then `a + 1` would be substituted for `a` infinitely often, and the system would “hang”.

Similarly, the environment variable MAXDEPTH provides a heuristic for recognizing infinite recursion with respect to function calls; see the corresponding help page for details.

There is a close connection between LEVEL and MAXLEVEL. If the substitution depth LEVEL is reached during the evaluation process, then the recursion stops and any remaining identifiers on page 7-29 remain unevaluated, but no error occurs.

Thus, if `MAXLEVEL > LEVEL`, then MAXLEVEL has no effect. By default, LEVEL and MAXLEVEL have the same value 100 at interactive level. However, the default value of LEVEL within a procedure is 1, and thus usually MAXLEVEL has no effect within procedures.

There are some notable differences between LEVEL and MAXLEVEL. The value of LEVEL depends on the context, namely whether the evaluation happens at interactive level or in a procedure. Moreover, some system functions, such as `context` and `level`, do not respect the current value of LEVEL. In contrast, MAXLEVEL is a global bound. It works as a last resort when the control of the evaluation via LEVEL fails.

The default value of `MAXLEVEL` is 100; `MAXLEVEL` has this value after starting or resetting the system via `reset`. Also the command `delete MAXLEVEL` restores the default value.

`MAXLEVEL` is a global variable. Use the statement `save MAXLEVEL` in a procedure to confine any changes to `MAXLEVEL` to this procedure.

The maximum value of `MAXLEVEL` depends on the operating system. Under Windows it is  $2^{13} = 8192$ . Under UNIX operating systems the maximum value depends on the maximum size of the C-stack. With a default stack size of 8 MB the value is 8192, too; with a bigger stack size it can be bigger (in a bash the stack size can be set with `ulimit -s`).

## Examples

### Example 1

Evaluation of objects defined by an infinite recursion produces an error:

```
delete a: a := a + 1: a
```

```
Error: Recursive definition: Reached maximal evaluation level.
```

This also works for mutually recursive definitions:

```
delete a, b: a := b^2: b := a + 1: b
```

```
Error: Recursive definition: Reached maximal evaluation level.
```

### Example 2

If `MAXLEVEL` is smaller or equal to `LEVEL`, as is the default at interactive level, then objects are evaluated completely up to depth `MAXLEVEL - 1`, and an error occurs if the substitution depth `MAXLEVEL` is reached, whether a recursive definition is involved or not:

```
delete a, b, c, d:  
a := b: b := c: c := 7: d := d + 1:  
MAXLEVEL := 2: LEVEL := 2: c
```

a

Error: Recursive definition: Reached maximal evaluation level.

d

Error: Recursive definition: Reached maximal evaluation level.

On the other hand, MAXLEVEL has no effect if it exceeds LEVEL. Then any object is evaluated up to depth at most LEVEL, and the “recursive definition” error does not occur:

```
MAXLEVEL := 3: a, b, c, d
```

*c, 7, 7, d + 2*

In particular, MAXLEVEL normally has no effect within procedures, where by default LEVEL has the value 1:

```
MAXLEVEL := 2:
p := proc() begin a, d end_proc:
p();
delete MAXLEVEL, LEVEL:
```

*b, d + 1*

## See Also

### MuPAD Functions

LEVEL | MAXDEPTH | context | eval | hold | level | val

## meijerG

The Meijer G function

### Syntax

meijerG([[a<sub>1</sub>, ..., a<sub>n</sub>], [a<sub>n+1</sub>, ..., a<sub>p</sub>]], [[b<sub>1</sub>, ..., b<sub>m</sub>], [b<sub>m+1</sub>, ..., b<sub>q</sub>]], z)

meijerG([a<sub>1</sub>, ..., a<sub>n</sub>], [a<sub>n+1</sub>, ..., a<sub>p</sub>], [b<sub>1</sub>, ..., b<sub>m</sub>], [b<sub>m+1</sub>, ..., b<sub>q</sub>], z)

meijerG(m, n, [a<sub>1</sub>, ..., a<sub>p</sub>], [b<sub>1</sub>, ..., b<sub>q</sub>], z)

### Description

meijerG([ [ a<sub>1</sub>, ..., a<sub>n</sub> ], [ a<sub>n+1</sub>, ..., a<sub>p</sub> ] ], [ [ b<sub>1</sub>, ..., b<sub>m</sub> ], [ b<sub>m+1</sub>, ..., b<sub>q</sub> ] ], z) represents the Meijer G function.

The following calls are equivalent:

meijerG([ a<sub>1</sub>, ..., a<sub>n</sub> ], [ a<sub>n+1</sub>, ..., a<sub>p</sub> ], [ b<sub>1</sub>, ..., b<sub>m</sub> ], [ b<sub>m+1</sub>, ..., b<sub>q</sub> ], z), and

meijerG(m, n, [ a<sub>1</sub>, ..., a<sub>n</sub>, a<sub>n+1</sub>, ..., a<sub>p</sub> ], [ b<sub>1</sub>, ..., b<sub>m</sub>, b<sub>m+1</sub>, ..., b<sub>q</sub> ], z).

meijerG([ [ a<sub>1</sub>, ..., a<sub>n</sub> ], [ a<sub>n+1</sub>, ..., a<sub>p</sub> ] ], [ [ b<sub>1</sub>, ..., b<sub>m</sub> ], [ b<sub>m+1</sub>, ...,

b<sub>q</sub> ] ], z) represents the Meijer G function  $G_{p,q}^{m,n} \left( \begin{matrix} a_1, \dots, a_n, a_{n+1}, \dots, a_p \\ b_1, \dots, b_m, b_{m+1}, \dots, b_q \end{matrix} \middle| z \right)$ . The function is defined as

$$G_{p,q}^{m,n} \left( \begin{matrix} a_1, \dots, a_p \\ b_1, \dots, b_q \end{matrix} \middle| z \right) = \frac{1}{2\pi i} \int \frac{\left( \prod_{j=1}^m \Gamma(b_j - s) \right) \left( \prod_{j=1}^n \Gamma(1 - a_j + s) \right)}{\left( \prod_{j=m+1}^q \Gamma(1 - b_j + s) \right) \left( \prod_{j=n+1}^p \Gamma(a_j - s) \right)} z^s ds$$

where  $0 \leq m \leq q$  and  $0 \leq n \leq p$ . The parameters  $a_i$ ,  $b_j$  and the argument  $z$  can be complex numbers. The integral represents an inverse Laplace transform or, more specifically, a Mellin-Barnes type of integral. See the Algorithms section for more details.

If  $m = 0$ ,  $m = q$ ,  $n = 0$ ,  $n = p$ ,  $p = 0$ , or  $q = 0$ , you can pass empty parameter lists to `meijerG`:  $[a_1, \dots, a_n] = []$ ,  $[a_{n+1}, \dots, a_p] = []$ ,  $[b_1, \dots, b_m] = []$ , or  $[b_{m+1}, \dots, b_q] = []$ .

No pair of parameters  $a_i - b_j$ ,  $i = 1, \dots, n$ ,  $j = 1, \dots, m$ , should differ by a positive integer.

Thus, no pole of  $\Gamma(b_j - s)$  coincides with any pole of  $\Gamma(1 - a_i + s)$ . Otherwise, `meijerG` returns an error.

Meijer G functions with different parameters can represent the same function:

- The Meijer G function is symmetric with respect to the parameters. Changing the order inside each of the following lists of parameters does not change the resulting Meijer G function:  $[a_1, \dots, a_n]$ ,  $[a_{n+1}, \dots, a_p]$ ,  $[b_1, \dots, b_m]$ ,  $[b_{m+1}, \dots, b_q]$ .
- If  $z$  is not a negative real number, the function satisfies the following identity:

$$G^{m,n} \left( \begin{matrix} a_1, \dots, a_p \\ b_1, \dots, b_q \end{matrix} \middle| z \right) = G^{n,m} \left( \begin{matrix} 1-b_1, \dots, 1-b_q \\ a_1, \dots, a_p \end{matrix} \middle| \frac{1}{z} \right).$$

- If  $0 < r < p$ , and  $r = a_1 - a_p$  is an integer, the function satisfies the following identity:

$$G^{m,n} \left( \begin{matrix} a_1, a_2, \dots, a_{p-1}, a_p \\ b_1, b_2, \dots, b_{q-1}, b_q \end{matrix} \middle| z \right) = (-1)^r G^{m,n} \left( \begin{matrix} a_p, a_2, \dots, a_{p-1}, a_1 \\ b_1, b_2, \dots, b_{q-1}, b_q \end{matrix} \middle| z \right).$$

- If  $0 < r < q$  and  $r = b_1 - b_q$  is an integer, the function satisfies the following identity:

$$G^{m,n} \left( \begin{matrix} a_1, a_2, \dots, a_{p-1}, a_p \\ b_1, b_2, \dots, b_{q-1}, b_q \end{matrix} \middle| z \right) = (-1)^r G^{m,n} \left( \begin{matrix} a_1, a_2, \dots, a_{p-1}, a_p \\ b_q, b_2, \dots, b_{q-1}, b_1 \end{matrix} \middle| z \right).$$

According to these rules, the `meijerG` function can return `meijerG` with modified input parameters.

If at least one of the arguments is a floating-point number and all other arguments can be converted to floating-point numbers, the function returns a floating-point value.

Particular choices of parameters can reduce the Meijer G function to simpler special or elementary functions. Most special functions can be derived from the Meijer G function. In many cases, you can rewrite results involving `meijerG` in terms of more elementary

functions using `simplify` or `Simplify`. See “Example 3” on page 1-1381 (Symbolic Math Toolbox).

The call `meijerG([], [], [], [], x)` returns 0.

## Environment Interactions

When called with floating-point arguments, this function is sensitive to the environment variable `DIGITS`, which determines the numerical working precision.

## Examples

### Example 1

For exact or symbolic arguments, the `meijerG` function returns `meijerG`:

```
meijerG([1], [], [], [2], x)
```

$$G_{1,1}^{0,1} \left( \begin{matrix} 1 \\ 2 \end{matrix} \middle| x \right)$$

```
meijerG([1], [1/2], [], [1/2], PI + I)
```

$$G_{1,2}^{1,0} \left( \begin{matrix} \frac{1}{2} \\ 0, \frac{1}{2} \end{matrix} \middle| \frac{1}{\pi + i} \right)$$

For floating-point arguments, `meijerG` returns floating-point values:

```
meijerG([1], [], [1], [1/2], 3.0),  
meijerG([PI], [2]), [1], [3], 4.0),  
meijerG([I+1,2], [], [1/(I+1), 1/2], [], 0.5*I)
```

$$0.7115950253, 0.3712122423, 0.3868927363 + 1.005593841 i$$

## Example 2

The functions `diff` and `float` handle expressions involving the Meijer G function:

```
diff(meijerG([[a], [b]], [[c], [d]], x), x)
```

$$\frac{G_{2,2}^{1,1}\left(\begin{matrix} a-1, b \\ c, d \end{matrix} \middle| x\right)}{x} + \frac{(a-1) G_{2,2}^{1,1}\left(\begin{matrix} a, b \\ c, d \end{matrix} \middle| x\right)}{x}$$

Differentiating a Meijer G function with respect to one of its parameters  $a_1, \dots, b_q$  does not generally result in Meijer G functions. Such derivatives are not implemented:

```
diff(meijerG([a], [b], [c], [d], z), a)
```

$$\frac{\partial}{\partial a} G_{2,2}^{1,1}\left(\begin{matrix} a, b \\ c, d \end{matrix} \middle| z\right)$$

You can evaluate the expressions involving `meijerG` numerically using `float`:

```
meijerG([[1], []], [[2], [sqrt(PI)]], 3) ~=
float(meijerG([[1], []], [[2], [sqrt(PI)]], 3))
```

$$G_{1,2}^{1,1}\left(\begin{matrix} 1 \\ 2, \sqrt{\pi} \end{matrix} \middle| 3\right) \approx -0.6659717596$$

```
delete z:
```

## Example 3

Particular choices of parameters can reduce the Meijer G function to simpler special or elementary functions. Use `simplify` or `Simplify` to obtain such a representation:

```
simplify(meijerG([], [], [[0], []], z))
```

$$e^{-z}$$

```
simplify(meijerG([[1], []], [[1/2], [0]], z))
```

$$\sqrt{\pi} \operatorname{erf}(\sqrt{z})$$

```
simplify(meijerG([], [], [[1/2, -1/2], []], z))
```

$$2 K_1(2 \sqrt{z})$$

You can verify these relations numerically:

```
z:= float(PI+I):  
meijerG([], [], [[0], []], z) = exp(-z);
```

$$0.02334857968 - 0.03636325836 i = 0.02334857968 - 0.03636325836 i$$

```
meijerG([[1], []], [[1/2], [0]], z) = float(sqrt(PI)*erf(sqrt(z)))
```

$$1.76330129 + 0.01917545012 i = 1.76330129 + 0.01917545012 i$$

```
meijerG([], [], [[1/2, -1/2], []], z) = 2*besselK(1, 2*sqrt(z))
```

$$0.03176922109 - 0.02400073308 i = 0.03176922109 - 0.02400073308 i$$

## Parameters

$\mathbf{a}_1, \dots, \mathbf{a}_p$

The 'first list of parameters': arithmetical expressions (Symbolic Math Toolbox)

$\mathbf{b}_1, \dots, \mathbf{b}_q$

The 'second list of parameters': arithmetical expressions (Symbolic Math Toolbox)

$\mathbf{z}$

The 'argument': an arithmetical expression (Symbolic Math Toolbox)



$m, n$

Integers satisfying  $0 \leq m \leq q$ ,  $0 \leq n \leq p$  or symbolic expressions.

## Return Values

Arithmetical expression.

## Overloaded By

$z$

## Algorithms

$$G_{p,q}^{m,n} \left( \begin{matrix} a_1, \dots, a_p \\ b_1, \dots, b_q \end{matrix} \middle| z \right) = \frac{1}{2\pi i} \int \frac{\left( \prod_{j=1}^m \Gamma(b_j - s) \right) \left( \prod_{j=1}^n \Gamma(1 - a_j + s) \right)}{\left( \prod_{j=m+1}^q \Gamma(1 - b_j + s) \right) \left( \prod_{j=n+1}^p \Gamma(a_j - s) \right)} z^s ds$$

involves a complex contour integral with one of the following types of integration paths:

- The contour goes from  $-i\infty$  to  $i\infty$  so that all poles of  $\Gamma(b_j - s)$ ,  $j = 1, \dots, m$ , lie to the right of the path, and all poles of  $\Gamma(1 - a_k + s)$ ,  $k = 1, \dots, n$ , lie to the left of the path.

The integral converges if  $c = m + n - \frac{p+q}{2} > 0$ ,  $|\arg(z)| < c\pi$ . If  $|\arg(z)| = c\pi$ ,  $c \geq 0$ , the integral converges absolutely when  $p \neq q$  and  $\Re(\psi) < -1$ , where

$\psi = \left( \sum_{j=1}^q b_j \right) - \left( \sum_{j=1}^p a_j \right)$ . When  $p \neq q$ , the integral converges if you choose the contour so that the contour points near  $i\infty$  and  $-i\infty$  have a real part  $\sigma$  satisfying

$$(q - p) \sigma > \Re(\psi) + 1 - \frac{q-p}{2}.$$

- The contour is a loop beginning and ending at *infinity* and encircling all poles of  $\Gamma(b_j - s)$ ,  $j = 1, \dots, m$ , moving in the negative direction, but none of the poles of

$\Gamma(1 - a_k + s)$ ,  $k = 1, \dots, n$ . The integral converges if  $q \geq 1$  and either  $p < q$  or  $p = q$  and  $|z| < 1$ .

- The contour is a loop beginning and ending at  $-\infty$  and encircling all poles of

$\Gamma(1 - a_k + s)$ ,  $k = 1, \dots, n$ , moving in the positive direction, but none of the poles of

$\Gamma(b_j + s)$ ,  $j = 1, \dots, m$ . The integral converges if  $p \geq 1$  and either  $p > q$  or  $p = q$  and  $|z| > 1$ .

For a given set of parameters, the contour chosen in the definition of the Meijer G function is the one for which the integral converges. To avoid confusion, if the integral converges for several contours, all contours lead to the same function.

The Meijer G function satisfies a differential equation of order  $\max(p, q)$  with respect to a variable  $z$ :

$$\left( (-1)^{m+n-p} z \left( \prod_{i=1}^p \left( z \frac{d}{dz} - a_i - 1 \right) \right) - \prod_{j=1}^q \left( z \frac{d}{dz} - b_j \right) \right) G_{p,q}^{m,n} \left( \begin{matrix} a_1, \dots, a_p \\ b_1, \dots, b_q \end{matrix} \middle| z \right) = 0$$

If  $p < q$ , this differential equation has a regular singularity at  $z = 0$  and an irregular singularity at  $z = \infty$ . If  $p = q$ , the points  $z = 0$  and  $z = \infty$  are regular singularities, and there is an additional regular singularity at  $z = (-1)^{m+n-p}$ .

The Meijer G function represents an analytic continuation of the Hypergeometric Function on page 1-944 (for details, see Luke in the references). For particular choices of parameters, you can express the Meijer G function through the hypergeometric function. For example, if no two of the  $b_h$  terms,  $h = 1, \dots, m$ , differ by an integer or zero, all poles are simple, and

$$G_{p,q}^{m,n} \left( \begin{matrix} a_1, \dots, a_p \\ b_1, \dots, b_q \end{matrix} \middle| z \right) = \sum_{h=1}^m \frac{\left( \prod_{\substack{j=1..m \\ j \neq h}} \Gamma(b_j - b_h) \right) \left( \prod_{j=1}^n \Gamma(1 + b_h - a_j) \right)}{\left( \prod_{j=m+1}^q \Gamma(1 + b_h - b_j) \right) \left( \prod_{j=n+1}^p \Gamma(a_j - b_h) \right)} z^{b_h} {}_pF_{q-1} \left( \begin{matrix} A_h \\ B_h \end{matrix} ; (-1)^{p-m-n} z \right)$$

where  $p < q$  or  $p = q$  and  $|z| < 1$ . The symbols  $A_h, B_h$  denote

$$A_h = 1 + b_h - a_1, \dots, 1 + b_h - a_p$$

and

$$B_h = 1 + b_h - b_1, \dots, 1 + b_h - b_{h-1}, 1 + b_h - b_{h+1}, \dots, 1 + b_h - b_q$$

## References

- Y.L. Luke, "The Special Functions and Their Approximations", Vol. 1, Academic Press, New York, 1969.
- A.P. Prudnikov, Yu.A. Brychkov and O.I. Marichev, "Integrals and Series", Vol. 3: More Special Functions, Gordon and Breach, 1990.
- M. Abramowitz and I.A. Stegun, "Handbook of Mathematical Functions", Dover Publications, New York, 9th printing, 1970.

## See Also

### MuPAD Functions

hypergeom

## **min**

Minimum of numbers

### **Syntax**

```
min(x1, x2, , ...)
```

```
min({x1, x2, ...})
```

```
min([x1, x2, ...])
```

```
min(A)
```

### **Description**

`min(x1, x2, ...)` returns the minimum of the numbers  $x_1, x_2, \dots$

If the arguments of `min` are integers on page 7-31, rational numbers on page 7-48, or floating-point numbers on page 7-23, then `min` returns the numerical minimum of these arguments.

The call `min()` is illegal and leads to an error message. If there is only one argument  $x_1$ , then `min` evaluates  $x_1$  and returns it. See “Example 2” on page 1-1388 (Symbolic Math Toolbox).

If one of the arguments is `-infinity`, then `min` returns `-infinity`. If an argument is `infinity`, then it is removed from the argument list (see “Example 3” on page 1-1388 (Symbolic Math Toolbox)).

`min` returns an error when one of its arguments is a complex number on page 7-84 or a floating point interval with on-zero imaginary part (see “Example 2” on page 1-1388 (Symbolic Math Toolbox)).

If one of the arguments is not a number (Symbolic Math Toolbox), then a symbolic `min` call with the minimum of the numerical arguments and the remaining evaluated arguments may be returned (see “Example 1” on page 1-1387 (Symbolic Math Toolbox)).

Nested `min` calls with symbolic arguments are rewritten as a single `min` call, i.e., they are flattened (Symbolic Math Toolbox); see “Example 4” on page 1-1389 (Symbolic Math Toolbox).

`min` reacts to a very limited set of properties (Symbolic Math Toolbox) of identifiers set via `assume`. Use `simplify` to handle more general assumptions (see “Example 4” on page 1-1389 (Symbolic Math Toolbox)).

## Examples

### Example 1

`min` computes the minimum of integers, rational numbers, and floating-point values:

```
min(-3/2, 7, 1.4)
```

$$-\frac{3}{2}$$

If the argument list contains symbolic expressions, then a symbolic `min` call is returned:

```
delete b: min(-4, b + 2, 1, 3)
```

$$\min(-4, b + 2)$$

In the following two examples, `min` is able to determine the minimum despite getting symbolic arguments:

```
min(sqrt(2), 1)
```

$$1$$

```
assume(x > 0): min(exp(x), exp(-x))
```

$$e^{-x}$$

Floating point intervals are interpreted as “any number within this range” and may thus cause symbolic `min` calls to be returned:

```
min(2...3 union 6...7, 4)
```

```
min(2.0 ... 3.0 ∪ 6.0 ... 7.0, 4)
```

```
min(2...3, 6...7, 4)
```

```
2.0 ... 3.0
```

```
min(6...7, 4)
```

```
4
```

## Example 2

`min` with one argument returns the evaluated argument:

```
delete a:  
min(a), min(sin(2*PI)), min(2)
```

```
a, 0, 2
```

Complex numbers lead to an error message:

```
min(0, 1, I)
```

```
Error: Invalid argument. [min]
```

## Example 3

`-infinity` is always the minimum of arbitrary arguments:

```
delete x:  
min(-100000000000, -infinity, x)
```

$$-\infty$$

infinity is removed from the argument list:

```
min(-1000000000000, infinity, x)
```

$$\min(-100000000000, x)$$

## Example 4

min reacts only to very few properties (Symbolic Math Toolbox) of identifiers set via assume:

```
delete a, b, c;
assume(a > 0 and b > a and c > b);
min(a, min(b, c), 0)
```

$$\min(a, b, c, 0)$$

An application of simplify yields the desired result:

```
simplify(%)
```

$$0$$

## Parameters

$x_1, x_2, \dots$

Arbitrary MuPAD objects

**A**

An array of domain type (Symbolic Math Toolbox) `DOM_HFARRAY` with real entries

## **Return Values**

One of the arguments, a floating-point number, or a symbolic `min` call.

## **Overloaded By**

## **See Also**

### **MuPAD Functions**

`_leequal` | `_less` | `max` | `sort` | `sysorder`



## mod\_mod

Modulo operator

---

**Note** For the mod function in MATLAB®, see mod.

---

### Syntax

`x mod m`

`_mod(x, m)`

### Description

If  $m \neq 0$ , then `mod(x, m)` returns the value  $x - n*m$  where  $n = \text{floor}(x/m)$ . If  $x$  and  $m$  have different signs, then `mod(x, m)` has the same sign as  $m$ . If  $m = 0$ , then `mod(x, m)` returns  $x$ . See “Example 1” on page 1-1392 (Symbolic Math Toolbox).

`_mod(x, m)` is the functional equivalent of the operator notation `x mod m`. See “Example 2” on page 1-1392 (Symbolic Math Toolbox).

By default, `x mod m` and `_mod(x, m)` are both equivalent to `modp(x, m)`. You can redefine the modulo operator `mod` and its functional form `_mod` by using `modp` and `mods`. For example, after the assignment `_mod:=mods`, both the operator `mod` and the equivalent function `_mod` return remainders of least absolute value. See “Example 3” on page 1-1393 (Symbolic Math Toolbox).

All functions return an error when one of the arguments is a floating-point number on page 7-23, a complex number on page 7-84, or not an arithmetical expression (Symbolic Math Toolbox).

If one of the arguments is not a number (Symbolic Math Toolbox), then a symbolic function call is returned. See “Example 4” on page 1-1393 (Symbolic Math Toolbox).

`_mod` and `modp` are kernel functions.

## Examples

### Example 1

Find the modulus after division of these integers.

`27 mod 4, 27 mod -4, -27 mod 4, -27 mod -4`

`3, -1, 1, -3`

Find the modulus after division by zero.

`9 mod 0, -9 mod 0, 0 mod 0`

`9, -9, 0`

Find the modulus after division of these rational numbers.

`22/3 mod 5, 22 mod 5/3, 22/3 mod 5/4`

`7/3, 1/3, 13/12`

### Example 2

Find the modulus after division of 23 by 5 using the modulo operator and its functional form. `_mod` and the operator `mod` are equivalent.

`hold(_mod(23, 5))`

`23 mod 5`

`23 mod 5 = _mod(23, 5)`

`3 = 3`

### Example 3

By default the binary operator `mod` and the equivalent function `_mod` are both equivalent to `modp`. You can redefine `_mod`.

```
modp(11, 7), mods(11,7);
11 mod 7
```

4, -3

4

```
_mod := mods:
11 mod 7
```

-3

For further computations, define `_mod` as `modp`.

```
_mod := modp:
```

### Example 4

If one of the arguments is not a number, then the modulo operator returns a symbolic function call.

```
delete x, m:
x mod m, x mod 2, 2 mod m
```

$x \bmod m, x \bmod 2, 2 \bmod m$

When called with nonnumeric arguments, the function currently associated with `_mod` is printed in the operator notation.

```
_mod := mods:
modp(x, m), mods(x, m)
```

$x \bmod m, x \bmod m$

```
_mod := modp:  
modp(x, m), mods(x, m)
```

```
x mod m, mods(x, m)
```

## Parameters

**x**

An integer, a rational number, or an arithmetical expression (Symbolic Math Toolbox)

**m**

An integer or an arithmetical expression (Symbolic Math Toolbox)

## Return Values

arithmetical expression (Symbolic Math Toolbox).

## Overloaded By

m, x

## See Also

### MuPAD Domains

Dom::IntegerMod

### MuPAD Functions

/ | IntMod | div | divide | frac | gcd | gcdex | igcd | igcdex | modp | mods |  
powermod

## Topics

“Modular Arithmetic” (Symbolic Math Toolbox)

# modp

Positive modulo function

## Syntax

`modp(x, m)`

## Description

If  $m \neq 0$ , then `modp(x, m)` returns the value  $x - n*m$  where  $n = \text{floor}(x/m)$ . If  $x$  and  $m$  have different signs, then `modp(x, m)` has the same sign as  $m$ . If  $m = 0$ , then `modp(x, m)` returns  $x$ . See “Example 1” on page 1-1395 (Symbolic Math Toolbox).

By default,  $x \bmod m$  and `_mod(x, m)` are both equivalent to `modp(x, m)`. You can redefine the modulo operator `mod` and its functional form `_mod` by using `modp` and `mods`. For example, after the assignment `_mod:=mods`, both the operator `mod` and the equivalent function `_mod` return remainders of least absolute value. See “Example 2” on page 1-1396 (Symbolic Math Toolbox).

All functions return an error when one of the arguments is a floating-point number on page 7-23, a complex number on page 7-84, or not an arithmetical expression (Symbolic Math Toolbox).

If one of the arguments is not a number (Symbolic Math Toolbox), then a symbolic function call is returned. See “Example 3” on page 1-1397 (Symbolic Math Toolbox).

`modp` is a kernel function.

## Examples

### Example 1

Find the modulus after division of these integers.

`modp(27, 4), modp(27, -4), modp(-27, 4), modp(-27, -4)`

3, -1, 1, -3

Find the modulus after division by zero.

```
modp(9, 0), modp(-9, 0), modp(0, 0)
```

9, -9, 0

Find the modulus after division of these rational numbers.

```
modp(22/3, 5), modp(22, 5/3), modp(22/3, 5/4)
```

$\frac{7}{3}$ ,  $\frac{1}{3}$ ,  $\frac{13}{12}$

## Example 2

By default the binary operator `mod` and the equivalent function `_mod` are both equivalent to `modp`. You can redefine `_mod`.

```
modp(11, 7), mods(11,7);  
11 mod 7
```

4, -3

4

```
_mod := mods:  
11 mod 7
```

-3

For further computations, define `_mod` as `modp`.

```
_mod := modp:
```

### Example 3

If one of the arguments is not a number, then `modp` returns a symbolic function call.

```
delete x, m:
modp(x, m), modp(x, 2), modp(2, m)
```

$x \bmod m, x \bmod 2, 2 \bmod m$

When called with nonnumeric arguments, the function currently associated with `_mod` is printed in the operator notation.

```
_mod := mods:
modp(x, m), mods(x, m)
```

$x \bmod m, x \bmod m$

```
_mod := modp:
modp(x, m), mods(x, m)
```

$x \bmod m, \text{mods}(x, m)$

## Parameters

**x**

An integer, a rational number, or an arithmetical expression (Symbolic Math Toolbox)

**m**

An integer or an arithmetical expression (Symbolic Math Toolbox)

## Return Values

arithmetical expression (Symbolic Math Toolbox).

## Overloaded By

m, x

## See Also

### MuPAD Domains

Dom::IntegerMod

### MuPAD Functions

/ | IntMod | div | divide | frac | gcd | gcdex | igcd | igcdex | mod | mods |  
powermod

## Topics

“Modular Arithmetic” (Symbolic Math Toolbox)



## mods

Symmetric modulo function

### Syntax

`mods(x, m)`

### Description

If  $m \neq 0$ , then `mods(x, m)` returns the value  $x + n*m$  where  $n = \text{round}(-x/m)$ . If  $m = 0$ , then `mods(x, m)` returns  $x$ . See “Example 1” on page 1-1399 (Symbolic Math Toolbox).

By default,  $x \bmod m$  and `_mod(x, m)` are both equivalent to `modp(x, m)`. You can redefine the modulo operator `mod` and its functional form `_mod` by using `modp` and `mods`. For example, after the assignment `_mod:=mods`, both the operator `mod` and the equivalent function `_mod` return remainders of least absolute value. See “Example 2” on page 1-1400 (Symbolic Math Toolbox).

All functions return an error when one of the arguments is a floating-point number on page 7-23, a complex number on page 7-84, or not an arithmetical expression (Symbolic Math Toolbox).

If one of the arguments is not a number (Symbolic Math Toolbox), then a symbolic function call is returned. See “Example 3” on page 1-1401 (Symbolic Math Toolbox).

`mods` is a kernel function.

## Examples

### Example 1

Use the symmetric modulo function to find the modulus after division of these integers.

```
mods(27, 4), mods(27, -4), mods(-27, 4), mods(-27, -4)
```

$-1, -1, 1, 1$

Find the modulus after division by zero.

`mods(9, 0), mods(-9, 0), mods(0, 0)`

$9, -9, 0$

Use the symmetric modulo function to find the modulus after division of these rational numbers.

`mods(22/3, 5), mods(22, 5/3), mods(22/3, 5/4)`

$\frac{7}{3}, \frac{1}{3}, -\frac{1}{6}$

## Example 2

By default the binary operator `mod` and the equivalent function `_mod` are both equivalent to `modp`. You can redefine `_mod`.

`modp(11, 7), mods(11,7);`  
`11 mod 7`

$4, -3$

$4$

`_mod := mods;`  
`11 mod 7;`

$-3$

For further computations, define `_mod` as `modp`.

`_mod := modp;`

### Example 3

If one of the arguments is not a number, then the modulo operator returns a symbolic function call.

```
delete x, m:
x mod m, x mod 2, 2 mod m
```

$x \bmod m, x \bmod 2, 2 \bmod m$

When called with nonnumeric arguments, the function currently associated with `_mod` is printed in the operator notation.

```
_mod := mods: modp(x, m), mods(x, m)
```

$x \bmod m, x \bmod m$

```
_mod := modp: modp(x, m), mods(x, m)
```

$x \bmod m, \text{mods}(x, m)$

## Parameters

**x**

An integer, a rational number, or an arithmetical expression (Symbolic Math Toolbox)

**m**

An integer or an arithmetical expression (Symbolic Math Toolbox)

## Return Values

arithmetical expression (Symbolic Math Toolbox).

## Overloaded By

m, x

## See Also

### MuPAD Domains

Dom::IntegerMod

### MuPAD Functions

/ | IntMod | div | divide | frac | gcd | gcdex | igcd | igcdex | mod | modp |  
powermod

## Topics

“Modular Arithmetic” (Symbolic Math Toolbox)

# monomials

Sorted list of monomials of a polynomial

## Syntax

```
monomials(p, <order>)
```

```
monomials(f, <vars>, <order>)
```

## Description

`monomials(p, order)` returns the list of non-zero monomials of the polynomial `p`. The list is sorted with respect to the term ordering `order`.

`monomials` returns a list of all non-trivial monomials of the polynomial given. The monomials are sorted according to the term ordering given. The list is empty if the polynomial is zero.

A polynomial expression `f` is first converted to a polynomial with the variables given by `vars`. If no variables are given, they are searched for in `f`. See `poly` about details of the conversion. The result is returned as list of polynomial expressions. `FAIL` is returned if `f` cannot be converted to a polynomial.

The result of `monomials` is not fully evaluated. It can be evaluated by the functions `mapcoeffs` and `eval`. Cf. "Example 4" on page 1-1405 (Symbolic Math Toolbox).

## Examples

### Example 1

We give some self explaining examples:

```
p := poly(100*x^100 + 49*x^49 + 7*x^7, [x]):  
monomials(p)
```

```
[poly(100 x100, [x]), poly(49 x49, [x]), poly(7 x7, [x])]
```

```
monomials(poly(0, [x]))
```

```
[]
```

```
delete p:
```

## Example 2

We demonstrate the effect of various term orders:

```
p := poly(5*x4 + 4*x3*y*z2 + 3*x2*y3*z + 2, [x, y, z]):  
monomials(p)
```

```
[poly(5 x4, [x, y, z]), poly(4 x3 y z2, [x, y, z]), poly(3 x2 y3 z, [x, y, z]),  
poly(2, [x, y, z])]
```

```
monomials(p, DegreeOrder)
```

```
[poly(4 x3 y z2, [x, y, z]), poly(3 x2 y3 z, [x, y, z]), poly(5 x4, [x, y, z]),  
poly(2, [x, y, z])]
```

```
monomials(p, DegInvLexOrder)
```

```
[poly(3 x2 y3 z, [x, y, z]), poly(4 x3 y z2, [x, y, z]), poly(5 x4, [x, y, z]),  
poly(2, [x, y, z])]
```

```
delete p:
```

### Example 3

This example features a user defined term ordering. Here we use the reverse lexicographical order on page 7-309 on 3 indeterminates:

```
order := Dom::MonomOrdering(RevLex(3)):
p := poly(5*x^4 + 4*x^3*y*z^2 + 3*x^2*y^3*z + 2, [x, y, z]):
monomials(p, order)
```

```
[poly(3 x^2 y^3 z, [x, y, z]), poly(4 x^3 y z^2, [x, y, z]), poly(5 x^4, [x, y, z]),
poly(2, [x, y, z])]
```

```
delete order, p:
```

### Example 4

We demonstrate the evaluation strategy of monomials:

```
p := poly(3*x^3 + 6*x^2*y^2 + 2, [x]): y := 4:
monomials(p)
```

```
[poly(3 x^3, [x]), poly((6 y^2) x^2, [x]), poly(2, [x])]
```

Evaluation is enforced by eval:

```
map(%, mapcoeffs, eval)
```

```
[poly(3 x^3, [x]), poly(96 x^2, [x]), poly(2, [x])]
```

```
delete p, y:
```

## Parameters

**p**

A polynomial (Symbolic Math Toolbox) of type DOM\_POLY

## **f**

A polynomial expression (Symbolic Math Toolbox)

## **vars**

A list on page 7-41 of indeterminates of the polynomial: typically, identifiers on page 7-29 or indexed identifiers on page 1-1017

## **order**

The term ordering: `LexOrder`, or `DegreeOrder`, or `DegInvLexOrder`, or a user-defined term ordering of type `Dom::MonomOrdering`. The default is the lexicographical ordering `LexOrder`.

## **Return Values**

List of polynomials of the same type as `p`. A list of expressions is returned if an expression is given. The list is empty if the polynomial is zero.

## **Overloaded By**

`p`

## **See Also**

### **MuPAD Functions**

`coeff` | `degree` | `degreevec` | `ground` | `lcoeff` | `ldegree` | `lmonomial` | `lterm` | `nterms` | `nthcoeff` | `nthmonomial` | `nthterm` | `poly` | `poly2list` | `tcoeff`



# mtaylor

Compute a multivariate Taylor series expansion

## Syntax

```
mtaylor(f, x = x0, <order>, <mode>, <weights>, <Mapcoeffs = mc>)
```

```
mtaylor(f, x, <order>, <mode>, <weights>, <Mapcoeffs = mc>)
```

```
mtaylor(f, x = x0, AbsoluteOrder = order, <weights>, <Mapcoeffs = mc>)
```

```
mtaylor(f, x = x0, RelativeOrder = order, <weights>, <Mapcoeffs = mc>)
```

```
mtaylor(f, [x = x0, y = y0, ...], <order>, <mode>, <weights>, <Mapcoeffs = mc>)
```

```
mtaylor(f, [x, y, ...], <order>, <mode>, <weights>, <Mapcoeffs = mc>)
```

```
mtaylor(f, [x = x0, y = y0, ...], <AbsoluteOrder = order>, <weights>, <Mapcoeffs = mc>)
```

```
mtaylor(f, [x = x0, y = y0, ...], RelativeOrder = order, <weights>, <Mapcoeffs = mc>)
```

## Description

`mtaylor(f, [x = x0, y = y0, ...])` computes the first terms of the multivariate Taylor series of  $f$  with respect to the variables  $x$ ,  $y$  etc. around the points  $x = x_0$ ,  $y = y_0$  etc.

With the default mode `RelativeOrder`, the number of requested terms for the expansion is determined by `order` if specified. If no order is specified, the value of the environment variable `ORDER` is used. You can change the default value 6 by assigning a new value to `ORDER`.

The terms are counted from the lowest total degree on for finite expansion points, and from the highest total degree term on for expansions around infinity.

If `AbsoluteOrder` is specified, `order` represents the truncation order of the series, i.e., no terms of total degree `order` or higher are computed.

For infinite expansion points, the absolute values of the exponents of the corresponding variables are used to compute the total degree.

For finite expansion points  $x_0$ ,  $y_0$ , ..., the computed series with respect to the variables  $x$ ,  $y$ , ... of weight  $w_1$ ,  $w_2$ , ... is

`taylor(f(x0 + t^w1*(x - x0), y0 + t^w2*(y - y0), dots), t = 0)`,

evaluated at the point  $t = 1$ .

## Environment Interactions

The function is sensitive to the environment variable `ORDER`, which determines the default number of terms in series computations.

## Examples

### Example 1

We compute a Taylor series around the origin (default). The expansion contains all terms through total degree 3:

```
mtaylor(exp(x^2 - y), [x, y], 4)
```

$$-x^2 y + x^2 - \frac{y^3}{6} + \frac{y^2}{2} - y + 1$$

We request additional terms of higher order:

```
mtaylor(exp(x^2 - y), [x, y], 5)
```

$$\frac{x^4}{2} + \frac{x^2 y^2}{2} - x^2 y + x^2 + \frac{y^4}{24} - \frac{y^3}{6} + \frac{y^2}{2} - y + 1$$

In the example above, the leading term is of total degree 0. In the following example, the leading term is of total degree 2. Thus, the default mode `RelativeOrder` produces terms of total degree smaller than  $4 + 2 = 6$ :

```
mtaylor(x*y*exp(x^2 - y), [x, y], 4)
```

$$-x^3 y^2 + x^3 y - \frac{x y^4}{6} + \frac{x y^3}{2} - x y^2 + x y$$

We request an absolute truncation order of 4, so that only terms of total degree smaller than 4 are computed:

```
mtaylor(x*y*exp(x^2 - y), [x, y], AbsoluteOrder = 4)
```

$$x y - x y^2$$

## Example 2

For infinite expansions points a series in the reciprocal of the variable is returned:

```
mtaylor(exp(z)/(x - y), [x = infinity, y = 0, z])
```

$$\frac{y^2}{x^3} + \frac{z^2}{2x} + \frac{z^3}{6x} + \frac{z^4}{24x} + \frac{z^5}{120x} + \frac{y}{x^2} + \frac{z}{x} + \frac{1}{x} + \frac{y z}{x^2} + \frac{y z^2}{2x^2} + \frac{y z^3}{6x^2} + \frac{y^2 z}{x^3}$$

We reduce the order in z by giving z a higher weight:

```
mtaylor(exp(z)/(x - y), [x = infinity, y = 0, z], [1, 1, 2])
```

$$\frac{y^2}{x^3} + \frac{z^2}{2x} + \frac{y}{x^2} + \frac{z}{x} + \frac{1}{x} + \frac{y z}{x^2}$$

## Example 3

If a Taylor series expansion does not exist, or if `mtaylor` cannot find a Taylor series expansion, then `mtaylor` throws an error.

Try to find the Taylor series expansion of  $f(x) = \frac{1}{x}$  around  $x = 1$ ,  $y = 1$ . The Taylor series expansion does not exist, and `mtaylor` throws an error:

```
mtaylor(1/(x*y - 1), [x = 1, y = 1])
```

```
Error: Unable to compute Taylor expansion of '1/(x*y - 1)'. [mtaylor]
```

## Example 4

This is an example of a directed Taylor expansion along the real axis around  $x = \text{infinity}$ :

```
mtaylor(sqrt(y)*sin(sqrt(y)/x), [x = infinity, y = 0])
```

$$\frac{y}{x} - \frac{y^2}{6x^3}$$

In fact, this is even an undirected expansion:

```
mtaylor(sqrt(y)*sin(sqrt(y)/x), [x = complexInfinity, y = 0])
```

$$\frac{y}{x} - \frac{y^2}{6x^3}$$

## Example 5

A common problem in symbolic calculations is “expression swell:” Intermediate expressions which are not or cannot be simplified lead to unnecessarily complicated results. The following is an example of such behavior:

```
mtaylor((a+x)^n, x, 4)
```

$$\sigma_1 - x^2 \sigma_1 \left( \frac{n}{2a^2} - \frac{n^2}{2a^2} \right) - x^3 \sigma_1 \left( \frac{n^2}{4a^3} - \frac{n}{3a^3} + \frac{n \left( \frac{n}{4a^2} - \frac{n^2}{6a^2} \right)}{a} \right) + \frac{nx\sigma_1}{a}$$

where

$$\sigma_1 = e^{n \ln(a)}$$

In general, applying `simplify` or `Simplify` to complicated results is a strategy that often helps. In this case, however, it would destroy the format of the series:

`simplify(%)`

$$\frac{a^{n-3} (6a^3 + 6a^2nx + 3an^2x^2 - 3anx^2 + n^3x^3 - 3n^2x^3 + 2nx^3)}{6}$$

What is required is a way to map a function like `simplify` to the coefficients of the series only. Since `mtaylor` returns an ordinary expression, this must be done in the `mtaylor` call itself, using the `Mapcoeffs` option:

`mtaylor((a+x)^n, x, 4, Mapcoeffs=simplify)`

$$a^n + a^{n-1}nx + \frac{a^{n-2}nx^2(n-1)}{2} + \frac{a^{n-3}nx^3(n^2-3n+2)}{6}$$

## Parameters

**f**

An arithmetical expression (Symbolic Math Toolbox) representing a function in  $x$ ,  $y$ , ...

**x, y, ...**

identifiers on page 7-29 or indexed identifiers on page 1-1017

**$x_0, y_0, \dots$**

The expansion points: arithmetical expressions. Also expressions involving `infinity` or `complexInfinity` are accepted.

If not specified, the default expansion point 0 is used.

**order**

The truncation order (in conjunction with `AbsoluteOrder`) or, in conjunction with `RelativeOrder`, the number of terms to be computed, respectively. A nonnegative integer; the default order is given by the environment variable `ORDER` (default value 6).

The order concept refers to the total degree in the variables (the sum of all exponents).

**mode**

One of the flags `AbsoluteOrder` or `RelativeOrder`. The default is `RelativeOrder`.

**weights**

A list of positive integers determining the number of terms of the computed series. A variable  $x$  with weight  $w$  contributes as  $x^w$  to the total degree of the terms in the series. Thus, using weight 2 for  $x$ , halves the order in  $x$  to which the series is computed.

By default, all variables have the weight 1.

## Options

**AbsoluteOrder**

With this flag, the integer value `order` is the truncation order of the computed series, i.e., only terms of total degree less than `order` are present.

**RelativeOrder**

With this flag, the terms in the computed series range from some leading total degree  $v$  to the highest total degree  $v + \text{order} - 1$  (i.e., the truncation order w.r.t. the total degree is  $v + \text{order}$ ).

### **Mapcoeffs**

Option, specified as `Mapcoeffs = mc`

When building the resulting expression, for each coefficient  $c$ , insert `mc(c)` instead.

## **Return Values**

Arithmetical expression.

## **Overloaded By**

`f`

## **See Also**

### **MuPAD Functions**

`0` | `Series::Puisseux` | `Type::Series` | `asympt` | `diff` | `limit` | `series` | `taylor`

## **Topics**

“Compute Taylor Series for Multivariate Expressions” (Symbolic Math Toolbox)

“O-term (The Landau Symbol)” (Symbolic Math Toolbox)

## multcoeffs

Multiply the coefficients of a polynomial with a factor

### Syntax

```
multcoeffs(p, c)
```

```
multcoeffs(f, <vars>, c)
```

### Description

`multcoeffs(p, c)` multiplies all coefficients of the polynomial `p` with the factor `c`.

A polynomial expression `f` is first converted to a polynomial with the variables given by `vars`. If no variables are given, they are searched for in `f`. See `poly` about details of the conversion. `FAIL` is returned if `f` cannot be converted to a polynomial. After multiplication with `c`, the result is converted to an expression.

For a polynomial expression `f`, the factor `c` may be any arithmetical expression (Symbolic Math Toolbox). For a polynomial `p` of type `DOM_POLY`, the factor `c` must be convertible to an element of the coefficient ring of `p`.

### Examples

#### Example 1

Some simple examples:

```
multcoeffs(3*x^3 + x^2*y^2 + 2, 5)
```

$$15x^3 + 5x^2y^2 + 10$$

```
multcoeffs(3*x^3 + x^2*y^2 + 2, c)
```



$$3 c x^3 + c x^2 y^2 + 2 c$$

```
multcoeffs(poly(x^3 + 2, [x]), sin(y))
```

$$\text{poly}(\sin(y) x^3 + 2 \sin(y), [x])$$

## Example 2

Mathematically, `multcoeffs(f, c)` is the same as `f*c`. However, `multcoeffs` produces an expanded form of the product which depends on the indeterminates:

```
f := 3*x^3 + x^2*y^2 + 2;
multcoeffs(f, [x], c), multcoeffs(f, [y], c),
multcoeffs(f, [z], c)
```

$$3 c x^3 + c x^2 y^2 + 2 c, c (3 x^3 + 2) + c x^2 y^2, c (3 x^3 + x^2 y^2 + 2)$$

```
delete f;
```

## Parameters

**p**

A polynomial (Symbolic Math Toolbox) of type `DOM_POLY`

**c**

An arithmetical expression (Symbolic Math Toolbox) or an element of the coefficient ring of `p`

**f**

A polynomial expression (Symbolic Math Toolbox)

**vars**

A list on page 7-41 of indeterminates of the polynomial: typically, identifiers on page 7-29 or indexed identifiers on page 1-1017

## Return Values

Polynomial of type DOM\_POLY, or a polynomial expression, or FAIL.

## Overloaded By

f, p

## See Also

### MuPAD Functions

coeff | degree | degreevec | lcoeff | ldegree | lterm | monomials | nterms |  
nthcoeff | nthmonomial | nthterm | poly | tcoeff

## new

Create a domain element

## Syntax

```
new(T, object1, object2, ...)
```

## Description

Within a method of the domain type  $T$ , `new(T, object1, object2, ...)` creates a new element of the domain  $T$  with the internal representation `object1, object2, ...`.

`new` is a low-level function for creating elements of library domains (Symbolic Math Toolbox).

The internal representation of a domain element comprises a reference to the corresponding domain (Symbolic Math Toolbox) and an arbitrary number of MuPAD objects, the internal operands of the domain element.

`new(T, object1, object2, ...)` creates a new element of the domain  $T$ , whose internal representation is the sequence of operands `object1, object2, ...`, and returns this element.

`new(T)` creates a new element of the domain  $T$ , whose internal representation is an empty sequence of operands.

---

**Note** `new` is intended only for programmers implementing their own domains in MuPAD. You should never use `new` directly to generate elements of a predefined domain  $T$ ; use the corresponding constructor `T(...)` instead, for the following reasons. The internal representation of the predefined MuPAD domains may be subject to changes more often than the interface provided by the constructor. Moreover, in contrast to `new`, the constructors usually perform argument checking. Thus using `new` directly may lead to invalid internal representations of MuPAD objects.

---

New domains can be created via `newDomain`.

You can access the operands of the internal representation of a domain element via `extop`, which, in contrast to `op`, cannot be overloaded (Symbolic Math Toolbox) for the domain. The function `op` is sometimes overloaded for a domain in order to hide the internal, technical representation of an object and to provide a more user friendly and intuitive interface.

Similarly, the function `extnops` returns the number of operands of a domain element in the internal representation, and `extsubsop` modifies an operand in the internal representation. These functions, in contrast to the related functions `nops` and `subsop`, cannot be overloaded for a domain.

You can write a constructor for your own domain `T` by providing a "new" method. This method is invoked whenever the user calls `T(arg1, arg2, ...)`. This is recommended since it provides a more elegant and intuitive user interface than `new`. The "new" method usually performs some argument checking and converts the arguments `arg1`, `arg2`, `...` into the internal representation of the domain, using `new` (see "Example 1" on page 1-1418 (Symbolic Math Toolbox)).

## Examples

### Example 1

We create a new domain `Time` for representing clock times. The internal representation of an object of this domain has two operands: the hour and the minutes. Then we create a new domain element for the time 12:45:

```
Time := newDomain("Time");  
a := new(Time, 12, 45)
```

```
new(Time, 12, 45)
```

The domain type of `a` is `Time`, the number of operands is 2, and the operands are 12 and 45:

```
domtype(a), extnops(a)
```

```
Time, 2
```

extop(a)

12, 45

We now implement a "new" method for our new domain Time, permitting several input formats. It expects either two integers, the hour and the minutes, or only one integer that represents the minutes, or a rational number or a floating-point number, implying that the integral part is the hour and the fractional part represents a fraction of an hour corresponding to the minutes, or no arguments, representing midnight. Additionally, the procedure checks that the arguments are of the correct type:

```
Time::new := proc(HR = 0, MN = 0)
  local m;
begin
  if args(0) = 2 and domtype(HR) = DOM_INT
    and domtype(MN) = DOM_INT then
    m := HR*60 + MN
  elif args(0) = 1 and domtype(HR) = DOM_INT then
    m := HR
  elif args(0) = 1 and domtype(HR) = DOM_RAT then
    m := trunc(float(HR))*60 + frac(float(HR))*60
  elif args(0) = 1 and domtype(HR) = DOM_FLOAT then
    m := trunc(HR)*60 + frac(HR)*60
  elif args(0) = 0 then
    m := 0
  else
    error("wrong number or type of arguments")
  end_if;
  new(Time, trunc(m/60), trunc(m) mod 60)
end_proc;
```

Now we can use this method to create new objects of the domain Time, either by calling Time::new directly, or, preferably, by using the equivalent but shorter call Time(...):

Time::new(12, 45), Time(12, 45), Time(12 + 3/4)

new(Time, 12, 45), new(Time, 12, 45), new(Time, 12, 45)

Time(), Time(8.25), Time(1/2)

new(Time, 0, 0), new(Time, 8, 15), new(Time, 0, 30)

In order to have a nicer output for objects of the domain `Time`, we also define a "print" method (see the help page for `print`):

```
Time::print := proc(TM)
begin
  expr2text(extop(TM, 1)) . ":" .
  stringlib::format(expr2text(extop(TM, 2)), 2, Right, "0")
end_proc:
```

```
Time::new(12, 45), Time(12, 45), Time(12 + 3/4)
```

```
12:45, 12:45, 12:45
```

```
Time(), Time(8.25), Time(1/2)
```

```
0:00, 8:15, 0:30
```

## Parameters

**T**

A MuPAD domain (Symbolic Math Toolbox)

**object1, object2, ...**

Arbitrary MuPAD objects

## Return Values

Element of the domain `T`.

## See Also

**MuPAD Domains**

`DOM_DOMAIN`

## **MuPAD Functions**

extnops | extop | extsubsop | newDomain | op

## newDomain

Create a new data type (domain)

### Syntax

```
newDomain(k)
```

```
newDomain(k, T)
```

```
newDomain(k, t)
```

### Description

`newDomain(k)` creates a new domain with key `k`.

`newDomain(k, T)` creates a copy of the domain `T` with new key `k`.

`newDomain(k, t)` creates a new domain with key `k` and slots from the table `t`.

Data types in MuPAD are called *domains*. `newDomain` is a low-level function for defining new data types. Cf. the corresponding entry in the Glossary (Symbolic Math Toolbox) for links to documentation about domains and more comfortable ways of defining new data types. The help page of `DOM_DOMAIN` contains a tutorial example for defining a new domain via `newDomain`.

Technically, a domain is something like a table. The entries of this table are called slots on page 1-1980 or *methods*. They serve for extending the functionality of standard MuPAD functions, such as the arithmetic operations `+` and `*`, the special mathematical functions `exp` and `sin`, or the symbolic manipulation functions `simplify` and `normal`, to objects of a domain in a modular, object-oriented way, without the need to modify the source code of the standard function. This is known as overloading (Symbolic Math Toolbox).

The function `slot` and the equivalent operator `::` serve for defining and accessing a specific slot of a domain. The function `op` returns all slots of a domain.

Each domain has a distinguished slot "key", which is its unique identification. There can be no two different domains with the same key. Typically, but not necessarily, the key is a



string on page 7-53. However, the key serves mainly for internal and output purposes. Usually a domain is assigned to an identifier on page 7-29 immediately after its creation, and you access the domain via this identifier.

If a domain with the given key already exists, `newDomain(k)` returns that domain; both other forms of calling `newDomain` yield an error.

## Examples

### Example 1

We create new domain with key "my-domain". This key is also used for output, but without quotes:

```
T := newDomain("my-domain")
```

```
my-domain
```

You can create elements of this domain with the function `new`:

```
e := new(T, 42);
domtype(e)
```

```
new(my-domain, 42)
```

```
my-domain
```

With the slot operator `::`, you can define a new slot or access an existing one:

```
op(T)
```

```
"key" = "my-domain"
```

```
T::key, T::myslot
```

```
"my-domain", FAIL
```

```
T::myslot := 42: op(T)
```

```
"key" = "my-domain", "myslot" = 42
```

```
T::myslot^2
```

```
1764
```

If a domain with key *k* already exists, then `newDomain(k)` does not create a new domain, but returns the existing domain instead:

```
T1 := newDomain("my-domain"):
op(T1)
```

```
"key" = "my-domain", "myslot" = 42
```

Note that you cannot delete a domain; the command `delete T` only deletes the value of the identifier *T*, but does not destroy the domain with the key "my-domain":

```
delete T, T1:
T2 := newDomain("my-domain"):
op(T2);
delete T2:
```

```
"key" = "my-domain", "myslot" = 42
```

## Example 2

There cannot exist different domains with the same key at the same time. Defining a slot for a domain implicitly changes all identifiers that have this domain as their value:

```
T := newDomain("1st"): T1 := T:
op(T);
op(T1);
```

```
"key" = "1st"
```

```
"key" = "1st"
```

```
T1::mySlot := 42:
op(T);
op(T1);
```

```
"key" = "1st", "mySlot" = 42
```

```
"key" = "1st", "mySlot" = 42
```

To avoid this, you can create a copy of a domain. You must reserve a new, unused key for that copy:

```
T2 := newDomain("2nd", T):
T2::anotherSlot := infinity:
op(T);
op(T2);
```

```
"key" = "1st", "mySlot" = 42
```

```
"key" = "2nd", "mySlot" = 42, "anotherSlot" = ∞
```

```
delete T, T1, T2:
```

### Example 3

You can provide a domain with slots already when creating it:

```
T := newDomain("3rd",
  table("myslot" = 42, "anotherSlot" = infinity)):
op(T);
T::myslot, T::anotherSlot
```

```
"myslot" = 42, "anotherSlot" = ∞, "key" = "3rd"
```

```
42, ∞
```

**delete T:**

## Parameters

**k**

An arbitrary object; typically a string on page 7-53

**T**

A domain

**t**

The slots on page 1-1980 of the domain: a table on page 1-2103

## Return Values

Object of type `DOM_DOMAIN`.

## See Also

### MuPAD Domains

`DOM_DOMAIN`

### MuPAD Functions

`domtype` | `new` | `slot`

## Topics

“Define Your Own Data Types” (Symbolic Math Toolbox)

# next\_next

Skip a step in a loop

## Syntax

```
next
```

```
_next()
```

## Description

`next` interrupts the current step in `for`, `repeat`, and `while` loops. Execution proceeds with the next step of the loop.

The `next` statement is equivalent to the function call `_next()`. The return value is the void object of type `DOM_NULL`.

Inside `for`, `repeat`, and `while` loops, the `next` statement interrupts the current step of the loop. In `for` statements, the loop variable is incremented and execution continues at the beginning of the loop. Similarly, the control conditions at the beginning of a `while` loop and in the `until` clause of a `repeat` loop are verified, before execution continues at the beginning of the loop.

Outside `for`, `repeat`, and `while` loops, the `next` statement has no effect.

## Examples

### Example 1

In the following `for` loop, any step with even `i` is skipped:

```
for i from 1 to 5 do
  if testtype(i, Type::Even) then next end_if;
  print(i)
end_for:
```

1

3

5

In the following repeat loop, all steps with odd *i* are skipped:

```
i := 0:  
repeat  
  i := i + 1;  
  if testtype(i, Type::Odd) then next end_if;  
  print(i)  
until i >= 5 end_repeat:
```

2

4

```
delete i:
```

## See Also

### MuPAD Functions

break | case | for | repeat | return | while

# nextprime

Next prime number

## Syntax

```
nextprime(m)
```

## Description

`nextprime(m)` returns the smallest prime number larger than or equal to `m`.

If the argument `m` is an integer, then `nextprime` returns the smallest prime number larger than or equal to `m`. A symbolic call of type "nextprime" is returned, if the argument is not of type `Type::Numeric`. An error occurs if the argument is a number that is not an integer on page 7-31.

The first prime number is 2.

## Examples

### Example 1

The first prime number is computed:

```
nextprime(-13)
```

2

If the argument of `nextprime` is a prime number, this number is returned:

```
nextprime(11)
```

11

We compute a large prime:

```
nextprime(56475767478567)
```

```
56475767478601
```

Symbolic arguments lead to a symbolic call:

```
nextprime(x)
```

```
nextprime(x)
```

## Parameters

**m**

An arithmetical expression (Symbolic Math Toolbox)

## Return Values

Prime number or a symbolic call to `nextprime`.

## References

Michael O. Rabin, Probabilistic algorithms, in J. F. Traub, ed., *Algorithms and Complexity*, Academic Press, New York, 1976, pp. 21-39.

## Algorithms

`nextprime` uses a fast probabilistic prime number test (Miller-Rabin test) to decide if the computed result is a prime number. The result returned by `nextprime` is either a prime number or a strong pseudo-prime for 10 randomly chosen bases.



## See Also

### MuPAD Functions

`ifactor` | `igcd` | `ilcm` | `isprime` | `ithprime` | `prevprime`

## **NIL**

Singleton element of the domain `DOM_NIL`

## **Syntax**

`NIL`

## **Description**

`NIL` is a keyword of the MuPAD language which represents the singleton element of the domain `DOM_NIL`.

The kernel domain `DOM_NIL` has only one singleton element. `NIL` is a keyword of the MuPAD language which represents this element. `NIL` is not changed by evaluation, see `DOM_NIL`.

Most often, `NIL` is used to represent a “missing” or “void” operand in a data structure. The “void object” returned by `null` is not suitable for this, because it is removed from most containers (like lists, sets or expressions) during evaluation.

When a new array from the kernel domain `DOM_ARRAY` is created, its elements are initialized with the value `NIL`. The function `op` returns `NIL` for un-initialized array elements. Note, however, that an indexed access of an un-initialized array element returns the indexed expression instead of `NIL`.

Local variables of procedures defined by `proc` are initialized with `NIL`. Nevertheless, a warning is printed if one accesses a local variable without explicitly initializing its value.

In former versions of MuPAD, `NIL` was used to delete values of identifiers or entries of tables, by assigning `NIL` to the identifier or entry. This is no longer supported. One must use `delete` to delete values. `NIL` now is a valid value of an identifier and a valid entry of a table.

## Examples

### Example 1

Unlike the “void object” returned by `null`, `NIL` is not removed from lists and sets:

```
[1, NIL, 2, NIL], [1, null(), 2, null()],
{1, NIL, 2, NIL}, {1, null(), 2, null()}

[1, NIL, 2, NIL], [1, 2], {1, 2, NIL}, {1, 2}
```

### Example 2

`NIL` is used to represent “missing” entries of procedures. For example, the simplest procedure imaginable has the following operands:

```
op(proc() begin end)
```

```
NIL, NIL, NIL, NIL, NIL, NIL, NIL, NIL, NIL, NIL, NIL, NIL, NIL, NIL, NIL
```

The first `NIL`, for example, represents the empty argument list, the second the void list of local variables and the third the void set of procedure options.

### Example 3

Array elements are initialized with `NIL` if not defined otherwise. Note, however, that the indexed access for such elements yields the indexed expression:

```
A := array(1..2): A[1], op(A,1)
```

```
A1, NIL
```

```
delete A:
```

## Example 4

Local variables in procedures are implicitly initialized with NIL. Still, a warning is printed if one uses the variable without explicitly initializing it:

```
p := proc() local l; begin print(l) end: p():
```

```
Warning: Uninitialized variable 'l' is used.  
Evaluating: p
```

```
NIL
```

```
delete p:
```

## Example 5

NIL may be assigned to an identifier or indexed identifier like any other value. Such an assignment no longer deletes the value of the identifier:

```
a := NIL: b[1] := NIL: a, b[1]
```

```
NIL, NIL
```

```
delete a, b:
```

## See Also

### MuPAD Functions

FAIL | delete | null

# nops

Number of operands

## Syntax

`nops(object)`

## Description

`nops(object)` returns the number of operands of the object.

See the help page of `op` for details on the MuPAD concept of “operands”.

For sets on page 7-50, lists on page 7-41, and tables on page 7-41, the function `nops` returns the number of elements or entries, respectively. Note that expressions of type `DOM_EXPR`, arrays on page 7-2 and `hfarrays` on page 7-27 have a 0-th operand which is *not counted* by `nops`. For arrays, also non-initialized elements are counted by `nops`.

The void object `null()` of type `DOM_NULL`, the empty list on page 7-41 [ ], the empty set on page 7-50{ }, and the empty table on page 1-2103`table()` have no operands: `nops` returns 0. Cf. “Example 1” on page 1-1436 (Symbolic Math Toolbox).

Integers of domain type `DOM_INT`, real floating-point numbers of domain type `DOM_FLOAT`, Boolean constants of domain type `DOM_BOOL`, identifiers of domain type `DOM_IDENT`, and strings of domain type `DOM_STRING` are ‘atomic’ objects having only 1 operand: the object itself. Rational numbers of domain type `DOM_RAT` and complex numbers of domain type `DOM_COMPLEX` have 2 operands: the numerator and denominator and the real part and imaginary part, respectively. Cf. “Example 2” on page 1-1436 (Symbolic Math Toolbox).

In contrast to most other MuPAD functions, `nops` does not flatten (Symbolic Math Toolbox)expression sequences on page 1-88. Cf. “Example 3” on page 1-1437 (Symbolic Math Toolbox).

## Examples

### Example 1

The following expression has the type "`_plus`" on page 1-40 and the three operands `a*b`, `3*c`, and `d`:

```
nops(a*b + 3*c + d)
```

3

For sets and lists, `nops` returns the number of elements. Note that the sublist `[1, 2, 3]` and the subset `{1, 2}` each count as one operand in the following examples:

```
nops({a, 1, [1, 2, 3], {1, 2}})
```

4

```
nops([[1, 2, 3], 4, 5, {1, 2}])
```

4

Empty objects have no operands:

```
nops(null()), nops([ ]), nops({}), nops(table())
```

0, 0, 0, 0

The number of operands of a symbolic function call is the number of arguments:

```
nops(f(3*x, 4, y + 2)), nops(f())
```

3, 0

### Example 2

Integers and real floating-point numbers only have one operand:

```
nops(12), nops(1.41)
```

```
1, 1
```

The same holds true for strings; use `length` to query the length of a string:

```
nops("MuPAD"), length("MuPAD")
```

```
1, 5
```

The number of operands of a rational number or a complex number is 2, even if the real part is zero:

```
nops(-3/2), nops(1 + I), nops(2*I)
```

```
2, 2, 2
```

A function environment on page 7-25 has 3 and a procedure on page 7-45 has 16 operands:

```
nops(sin), nops(op(sin, 1))
```

```
3, 16
```

### Example 3

Expression sequences are not flattened (Symbolic Math Toolbox) by `nops`:

```
nops((1, 2, 3))
```

```
3
```

In contrast to the previous call, the following command calls `nops` with three arguments:

```
nops(1, 2, 3)
```

```
Error: Invalid number of arguments. [nops]
```

## **Parameters**

**object**

An arbitrary MuPAD object

## **Return Values**

Nonnegative integer.

## **Overloaded By**

object

## **See Also**

### **MuPAD Functions**

extnops | extop | extsubsop | length | op | subsop



## norm

Compute the norm of a matrix, a vector, or a polynomial

### Syntax

`norm(M, <1 | 2 | Frobenius | Infinity | Spectral>)`

`norm(v, <Frobenius | Infinity | kv>)`

`norm(p, <kp>)`

`norm(f, <vars>, <kp>)`

### Description

`norm(M, kM)` computes the norm of index kM of the matrix M.

`norm(v, kv)` computes the norm of index kv of the vector v.

`norm(p, kp)` computes the norm of index kp of the polynomial p.

In MuPAD, there is no difference between matrices on page 1-2045 (Symbolic Math Toolbox) and vectors: a vector is a matrix of dimension  $1 \times n$  or  $n \times 1$ , respectively.

For an  $m \times n$  matrix  $M = (M_{ij})$  with  $\min(m, n) > 1$ , only the 1-norm (maximum column sum)

$$\|M\|_1 = \max \left( \sum_{i=1}^m |M_{i,j}| \right), j = 1, \dots, n$$

the Frobenius norm

$$\|M\| = \sqrt{\sum_{i=1}^m \left( \sum_{j=1}^n |M_{ij}|^2 \right)}$$

the spectral norm

$$\|M\|_2 = \sqrt{\phi}$$

where  $\phi$  is the largest eigenvalue of  $A^H A$  and the *infinity*-norm (maximum row sum)

$$\|M\|_\infty = \max \left( \sum_{j=1}^n |M_{1,j}|, \sum_{j=1}^n |M_{2,j}|, \dots, \sum_{j=1}^n |M_{m,j}| \right)$$

can be computed. The 1-norm and the Infinity-norm are operator norms with respect to the corresponding norms on the vector spaces the matrix is acting upon.

For vectors  $v = (v_i)$ , represented by matrices of dimension  $1 \times n$  or  $n \times 1$ , norms with arbitrary positive integer indices  $k$  as well as Infinity can be computed. For integers  $k > 1$ , the vector norms are given by

$$\|v\|_k = \left( \sum_{i=1}^n |v_i|^k \right)^{1/k}$$

for column vectors as well as for row vectors.

For indices 1, Infinity, and Frobenius, the vector norms are given by the corresponding matrix norms. For column vectors, the 1-norm is the sum norm

$$\|v\|_1 = \sum_{i=1}^n |v_i|$$

the Infinity-norm is the maximum norm

$$\|v\|_\infty = \max(|v_1|, \dots, |v_n|)$$

(this is the limit of the  $k$ -norms as  $k$  tends to infinity).

---

**Note** For row vectors, the 1-norm is the maximum norm, whilst the Infinity-norm is the sum norm.

---

The Frobenius norm coincides with `norm(v, 2)` for both column and row vectors.

Cf. “Example 2” on page 1-1443 (Symbolic Math Toolbox).

Matrices and vectors may contain symbolic entries. No internal float conversion is applied.

For matrix and vector norms, also refer to the help page of `Dom::Matrix` (note that the function `matrix` generates matrices of type `Dom::Matrix()`).

For polynomials  $p$  with coefficients  $c_i$ , the norms are given by

$$\|p\|_{\infty} = \max(|c_i|), \quad \|p\|_k = \left( \sum_{i=1}^n |c_i|^k \right)^{1/k}$$

Also multivariate polynomials are accepted by `norm`. The coefficients with respect to all indeterminates are taken into account.

For polynomials, only numerical norms can be computed. The coefficients of the polynomial must not contain symbolic parameters that cannot be converted to floating-point numbers. Coefficients containing symbolic numerical expressions such as `PI+1`, `sqrt(2)` etc. are accepted. Internally, they are converted to floating-point numbers. Cf. “Example 3” on page 1-1443 (Symbolic Math Toolbox).

For indices  $k > 1$ , `norm(p, k)` always returns a floating-point number. The 1-norm produces an exact result if all coefficients are integers or rational numbers. The *infinity*-norm `norm(p)` produces an exact result, if the coefficient of largest magnitude is an integer or a rational number. In all other cases, also the 1-norm and the *infinity*-norm produce floating-point numbers. Cf. “Example 3” on page 1-1443 (Symbolic Math Toolbox).

For polynomials over the coefficient ring `IntMod(m)`, `norm` produces an error.

If the coefficient ring of the polynomial is a domain (Symbolic Math Toolbox), it must implement the method “`norm`”. This method must return the norm of the coefficients as a number or as a numerical expression that can be converted to a floating-point number via `float`. With the coefficient norms  $\|c_i\|$ , `norm(p)` computes the maximum norm

$$\max(\|c_1\|, \dots, \|c_n\|); \quad \text{norm}(p, k) \text{ computes } \left( \sum_{i=1}^n \|c_i\|^k \right)^{1/k}.$$

A polynomial expression  $f$  is internally converted to the polynomial  $\text{poly}(f)$ . If a list of indeterminates is specified, the norm of the polynomial  $\text{poly}(f, \text{vars})$  is computed.

For polynomials and polynomial expressions, the norms are computed by a function of the system kernel.

## Examples

### Example 1

We compute various norms of a  $2 \times 3$  matrix:

```
M := matrix([[2, 5, 8], [-2, 3, 5]]):  
norm(M) = norm(M, Infinity),  
norm(M, 1),  
norm(M, Frobenius),  
norm(M, Spectral)
```

$$15 = 15, 13, \sqrt{131}, \sqrt{\frac{\sqrt{13429}}{2} + \frac{131}{2}}$$

For matrices, `norm` produces exact symbolic results:

```
M := matrix([[2/3, 63, PI],[x, y, z]]):  
norm(M)
```

$$\max\left(\pi + \frac{191}{3}, |x| + |y| + |z|\right)$$

```
norm(M, 1)
```

$$\max\left(|x| + \frac{2}{3}, |y| + 63, \pi + |z|\right)$$

```
norm(M, Frobenius)
```

$$\sqrt{|x|^2 + |y|^2 + |z|^2 + \pi^2 + \frac{35725}{9}}$$

delete M:

## Example 2

A column vector `col` and a row vector `row` are considered:

```
col := matrix([x1, PI]): row := matrix([[x1, PI]]): col, row
```

$$\begin{pmatrix} x1 \\ \pi \end{pmatrix}, (x1 \ \pi)$$

```
norm(col, 2) = norm(row, 2)
```

$$\sqrt{|x1|^2 + \pi^2} = \sqrt{|x1|^2 + \pi^2}$$

```
norm(col, 3) = norm(row, 3)
```

$$(|x1|^3 + \pi^3)^{1/3} = (|x1|^3 + \pi^3)^{1/3}$$

Note that the norms of index 1 and Infinity have exchanged meanings for column and row vectors:

```
norm(col, 1) = norm(row, Infinity)
```

$$\pi + |x1| = \pi + |x1|$$

```
norm(col, Infinity) = norm(row, 1)
```

$$\max(|x1|, \pi) = \max(|x1|, \pi)$$

```
delete col, row:
```

## Example 3

The norms of some polynomials are computed:

```
p := poly(3*x^3 + 4*x, [x]): norm(p), norm(p, 1)
```

4, 7

If the coefficients are not integers or rational numbers, automatic conversion to floating-point numbers occurs:

```
p := poly(3*x^3 + sqrt(2)*x + PI, [x]): norm(p), norm(p, 1)
```

3.141592654, 7.555806216

Floating point numbers are always produced for indices greater than 1:

```
p := poly(3*x^3 + 4*x + 1, [x]):  
norm(p, 1), norm(p, 2), norm(p, 5), norm(p, 10), norm(p)
```

8, 5.099019514, 4.174686339, 4.021974513, 4

```
delete p:
```

## Example 4

The norms of some polynomial expressions are computed:

```
norm(x^3 + 1, 1), norm(x^3 + 1, 2), norm(x^3 + PI)
```

2, 1.414213562, 1

The following call yields an error, because the expression is regarded as a polynomial in  $x$ . Consequently, symbolic coefficients  $6y$  and  $9y^2$  are found which are not accepted:

```
f := 6*x*y + 9*y^2 + 2: norm(f, [x])
```

```
Error: Invalid argument. [norm]
```

As a bivariate polynomial with the indeterminates  $x$  and  $y$ , the coefficients are 6, 9, and 2. Now, norms can be computed:

```
norm(f, [x, y], 1), norm(f, [x, y], 2), norm(f, [x, y])
```

17, 11.0, 9

delete f:

## Parameters

**M**

A matrix on page 1-2045 (Symbolic Math Toolbox) of domain type `Dom::Matrix(...)`

**v**

A vector (a 1-dimensional matrix on page 1-2045 (Symbolic Math Toolbox))

**kv**

A positive integer as index of the vector norm.

**p**

A polynomial (Symbolic Math Toolbox) generated by `poly`

**f**

A polynomial expression (Symbolic Math Toolbox)

**vars**

A list of identifiers or indexed identifiers, interpreted as the indeterminates of `f`

**kp**

The index of the norm of the polynomial: a real number greater or equal than 1. If no index is specified, the maximum norm (of index infinity) is computed.

## Options

**Frobenius**

Computes the Frobenius norm for vectors and matrices.

### **Infinity**

Computes the Infinity norm for vectors and matrices.

### **Spectral**

Computes the Spectral norm for matrices.

## **Return Values**

Arithmetical expression.

## **Overloaded By**

f, p

## **See Also**

### **MuPAD Functions**

`coeff` | `float` | `matrix` | `poly`



# normal

Normalize an expression

## Syntax

```
normal(f, options)
```

```
normal(object)
```

## Description

`normal(f)` returns a normal form of the rational expression `f`. MuPAD regards an expression as normalized when it is a fraction where both numerator and denominator are polynomials whose greatest common divisor is 1.

`normal(object)` replaces the operands of `object` with their normalized form.

`normal` and `simplifyFraction` are equivalent.

If argument `f` contains irrational subexpressions such as `sin(x)`, `x-1/3` etc., then these are replaced by auxiliary variables before normalization. After normalization, these variables are replaced by the normalization of the original subexpressions. Algebraic dependencies of the subexpressions are not taken into account. The operands of the non-rational subexpressions are normalized recursively.

If argument `f` contains floating-point numbers, then these are replaced by rational approximants (see `numeric::rationalize`). In the end, `float` is applied to the result.

With the `Expand` option, the normal form is unique for rational expressions: it is the quotient of expanded polynomials whose greatest common divisor is 1. If `f` and `g` are rational expressions, the following statements are equivalent:

- `f` and `g` are mathematically equivalent.
- `normal(f, Expand) = normal(g, Expand)`
- `normal(f - g, Expand) = 0`

A normal form generated without the `Expand` option (which is equivalent to `Expand = FALSE`) is the quotient of products of powers of expanded polynomials, where all factors of the numerator and the denominator are coprime. MuPAD regards factorized expressions, such as  $x(x + 1)$ , and equivalent expanded expressions, such as  $x^2 + x$ , as normalized. Therefore, if you do not use `Expand`, there is no unique normal form of a rational expression.

If  $f$  and  $g$  are rational expressions, these statements are equivalent:

- $f$  and  $g$  are mathematically equivalent.
- `normal(f - g) = 0`

For special objects, `normal` is automatically mapped to its operands. In particular, if `object` is a polynomial of domain type `DOM_POLY`, then its coefficients are normalized. Further, if `object` is a set, list, table or array, respectively, then `normal` is applied to all entries. Further, the left and right sides of equations (type `"_equal"`), inequalities (type `"_unequal"`), and relations (type `"_less"` or `"_leequal"`) are normalized. Further, the operands of ranges (type `"_range"`) are normalized automatically.

## Examples

### Example 1

Compute the normal form of some rational expressions:

```
normal(x^2 - (x + 1)*(x - 1))
```

$1$

```
normal((x^2 - 1)/(x + 1))
```

$x - 1$

```
normal(1/(x + 1) + 1/(y - 1))
```

$$\frac{x + y}{(x + 1)(y - 1)}$$

The following expression must be regarded as a rational expression in the “indeterminates”  $y$  and  $\sin(x)$ :

```
normal(1/sin(x)^2 + y/sin(x))
```

$$\frac{y \sin(x) + 1}{\sin(x)^2}$$

## Example 2

Normalize the entries of this list:

```
[(x^2 - 1)/(x + 1), x^2 - (x + 1)*(x - 1)]
```

$$\left[ \frac{x^2 - 1}{x + 1}, x^2 - (x - 1)(x + 1) \right]$$

```
normal(%)
```

$$[x - 1, 1]$$

Now, normalize the coefficients of polynomials:

```
poly((x^2-1)/(x+1)*Y^2 + (x^2-(x+1)*(x-1))*Y - 1, [Y])
```

$$\text{poly}\left(\frac{x^2 - 1}{x + 1} Y^2 + (-(x - 1)(x + 1) + x^2) Y - 1, [Y]\right)$$

```
normal(%)
```

$$\text{poly}((x - 1) Y^2 + Y - 1, [Y])$$

### Example 3

If you use the `Expand` option, `normal` returns a fraction with the expanded numerator and denominator:

```
normal(x/(x^6 - 1) + x^2/(x^4 - 1), Expand)
```

$$-\frac{x^6 + x^4 + x^3 + x^2 + x}{-x^8 - x^6 + x^2 + 1}$$

Without `Expand`, a fraction returned by `normal` can contain factored expressions:

```
normal(x/(x^6 - 1) + x^2/(x^4 - 1))
```

$$\frac{x(x^5 + x^3 + x^2 + x + 1)}{(x^2 - 1)(x^2 + 1)(x^4 + x^2 + 1)}$$

### Example 4

If you use the `List` option, `normal` returns a list consisting of the numerator and denominator of the input:

```
normal((x^2-1)/(x^2+2*x+1), List)
```

$$[x - 1, x + 1]$$

Note that `normal(f, List)` is *not* the same as `[numer(f), denom(f)]`:

```
[numer, denom]((x^2-1)/(x^2+2*x+1))
```

$$[x^2 - 1, x^2 + 2x + 1]$$

### Example 5

To skip calculation of common divisors of the numerator and denominator of an expression, use the `NoGcd` option:

```

y := (x^4 - 1)/(x + 1) + 1:
normal(y);
normal(y, NoGcd)

```

$$x^3 - x^2 + x$$

$$\frac{x^4 + x}{x + 1}$$

## Example 6

To specify common divisors that you want to cancel out, use the `ToCancel` option:

```

y := (x^4 - 1)/(x^2 - 1):
normal(y, ToCancel = {x - 1})

```

$$\frac{x^3 + x^2 + x + 1}{x + 1}$$

## Example 7

By default, `normal` calls the `rationalize` function in attempt to rationalize the input expression. You might speed up computations by using `Rationalize = None` in conjunction with the `Expand` option. This combination of options lets you skip investigating algebraic dependencies and, therefore, saves some time:

```

n := exp(u):
a := (n^2 + n)/(n + 1) + 1:
normal(a, Expand, Rationalize = None)

```

$$\frac{e^{2u} + 2e^u + 1}{e^u + 1}$$

Without `Rationalize = None`, MuPAD analyzes algebraic dependencies and returns this result:

`normal(a, Expand)`

$$e^u + 1$$

### Example 8

Disable recursive calls to `normal` for subexpressions by using `Recursive = FALSE`:

```
y := sqrt((x^2 + 2*x + 1)/(x + 1)):
normal(y, Recursive = FALSE)
```

$$\sqrt{\frac{x^2 + 2x + 1}{x + 1}}$$

### Example 9

Solve this equation, and sum up the fifth powers of the solutions:

```
solutions := solve(x^3 + x^2 + 1, x, MaxDegree = 3):
f := _plus((solutions[i]^7) $i = 1..3)
```

$$-\left(\frac{1}{3} - \frac{\sigma_1}{2} - \frac{1}{18\sigma_1} + \frac{\sqrt{3}\left(\frac{1}{9\sigma_1} - \sigma_1\right)i}{2}\right)^7 + \left(\frac{1}{18\sigma_1} + \frac{\sigma_1}{2} - \frac{1}{3} + \frac{\sqrt{3}\left(\frac{1}{9\sigma_1} - \sigma_1\right)i}{2}\right)^7 - \left(\frac{1}{9\sigma_1} + \sigma_1 + \frac{1}{3}\right)^7$$

where

$$\sigma_1 = \left(\frac{29}{54} - \frac{\sqrt{31}\sqrt{108}}{108}\right)^{1/3}$$

Normalizing the result returns:

`normal(f)`

- 15

To limit the number of internally repeated calls to `normal` due to analysis of algebraic dependencies, use the `Iterations` option. The default number of iterations is 5. Use the `Iterations` option to increase or decrease the number of iterations. For example, normalize the result using just one iteration:

```
normal(f, Iterations = 1)
```

$$-\frac{\frac{181875 \sqrt{31} \sqrt{108}}{4} + 3168963 \left( \frac{\sqrt{31} \sqrt{108}}{108} - \frac{29}{54} \right)^3 - \frac{5261843}{2}}{531441 \left( \frac{29 \sqrt{31} \sqrt{108}}{2916} - \frac{839}{1458} \right)}$$

After two iterations, the result becomes shorter:

```
normal(f, Iterations = 2)
```

$$-\frac{5073840 \sqrt{31} \sqrt{108} - 293582880}{11664 (29 \sqrt{31} \sqrt{108} - 1678)}$$

After three iterations, you get the simplest result:

```
normal(f, Iterations = 3)
```

- 15

## Parameters

**f**

An arithmetical expression (Symbolic Math Toolbox)

**object**

A polynomial (Symbolic Math Toolbox) of type `DOM_POLY`, list on page 7-41, set on page 7-50, table on page 1-2103, array on page 7-2, equation on page 1-19, inequality on page 1-23, or range on page 1-16

## Options

**Expand**

Return the numerator and denominator of the normalized expression in expanded form. See “Details” for more information. By default, `Expand = FALSE`.

**List**

Return a list consisting of the numerator and denominator of `f`. By default, `List = FALSE`.

**NoGcd**

Skip computing common divisors of the numerator and denominator of `f`. By default, `NoGcd = FALSE`.

**ToCancel**

Option, specified as `ToCancel = {expr1, expr2, ...}`

Cancel out only the specified common divisors `{expr1, expr2, ...}`.

**Rationalize**

Option, specified as `Rationalize = None`

Perform only basic rationalization of an irrational input expression. Skip investigating algebraic dependencies. This option works only in conjunction with the `Expand` option. Otherwise, `normal` ignores this option. See “Example 7” on page 1-1451 (Symbolic Math Toolbox).

**Recursive**

Recursively normalize subexpressions of an irrational expression. By default, `Recursive = TRUE`.



## Iterations

Option, specified as `Iterations = n`

Specify the number of repeated calls to `normal`. Repeated calls appear when analysis of algebraic dependencies results in new irrational subexpressions. By default, `n = 5`.

## Return Values

Object of the same type as the input object, or a list of two arithmetical expressions if the `List` option is used.

## Overloaded By

object

## See Also

### MuPAD Functions

`collect` | `combine` | `denom` | `expand` | `factor` | `gcd` | `indets` | `numer` | `partfrac` | `rationalize` | `rectform` | `rewrite` | `simplify` | `simplifyFraction`

## Topics

“Manipulate Expressions” (Symbolic Math Toolbox)

“Choose Simplification Functions” (Symbolic Math Toolbox)

# **simplifyFraction**

Normalize an expression

## **Syntax**

`simplifyFraction(f, options)`

`simplifyFraction(object)`

## **Description**

`normal` and `simplifyFraction` are equivalent. For details and examples, see `normal`.

# NOTEBOOKFILE

Notebook file name

## Description

The environment variables `NOTEBOOKFILE` and `NOTEBOOKPATH` store the absolute file name and the directory name, respectively, of the current notebook in the MuPAD Notebook as a string on page 7-53.

Possible values: String

The environment variable `NOTEBOOKFILE` stores the name of the current notebook that is connected to the MuPAD kernel.

The environment variable `NOTEBOOKPATH` stores the name of the directory where the current notebook is located.

These variables are useful, for example, when reading files that are located relative to the notebook.

Both variables only have a value if the notebook has a name, which is generally the case when an existing notebook has been opened or a new notebook has been saved.

The name given by `NOTEBOOKFILE` is an absolute file name.

Both variables are read-only and are write-protected. One cannot assign a new value to `NOTEBOOKFILE` in order to change the name of the notebook.

`NOTEBOOKFILE` and `NOTEBOOKPATH` are only defined in the MuPAD Notebook. When using the MuPAD engine from MATLAB, the two variables are just normal identifiers on page 7-29.

## Examples

### Example 1

In the MuPAD Notebook, you can specify startup commands for a notebook, which are executed when the notebook is connected to a kernel.

In the startup commands you can use `NOTEBOOKPATH` to read a source file "my\_init.mu" which is stored in the directory of the notebook:

```
fread(NOTEBOOKPATH."my_init.mu")
```

## See Also

### MuPAD Functions

`NOTEBOOKPATH` | `READPATH` | `WRITEPATH`

# NOTEBOOKPATH

Notebook path

## Description

The environment variables `NOTEBOOKFILE` and `NOTEBOOKPATH` store the absolute file name and the directory name, respectively, of the current notebook in the MuPAD Notebook as a string on page 7-53.

Possible values: String

The environment variable `NOTEBOOKFILE` stores the name of the current notebook that is connected to the MuPAD kernel.

The environment variable `NOTEBOOKPATH` stores the name of the directory where the current notebook is located.

These variables are useful, for example, when reading files that are located relative to the notebook.

Both variables only have a value if the notebook has a name, which is generally the case when an existing notebook has been opened or a new notebook has been saved.

The name given by `NOTEBOOKFILE` is an absolute file name.

Both variables are read-only and are write-protected. One cannot assign a new value to `NOTEBOOKFILE` in order to change the name of the notebook.

`NOTEBOOKFILE` and `NOTEBOOKPATH` are only defined in the MuPAD Notebook. When using the MuPAD engine from MATLAB, the two variables are just normal identifiers on page 7-29.

## Examples

### Example 1

In the MuPAD Notebook, you can specify startup commands for a notebook, which are executed when the notebook is connected to a kernel.

In the startup commands, you can use `NOTEBOOKPATH` to read a source file "my\_init.mu" which is stored in the directory of the notebook:

```
fread(NOTEBOOKPATH."my_init.mu")
```

## See Also

### MuPAD Functions

`NOTEBOOKFILE` | `READPATH` | `WRITEPATH`

# nterms

Number of terms of a polynomial

## Syntax

```
nterms(p)
```

```
nterms(f, <vars>)
```

## Description

`nterms(p)` returns the number of terms of the polynomial `p`.

If the first argument `f` is not element of a polynomial domain, then `nterms` converts the expression to a polynomial via `poly(f)`. If a list of indeterminates is specified, then the polynomial `poly(f, vars)` is considered.

A zero polynomial has no terms: the return value is 0.

## Examples

### Example 1

We give some self explaining examples:

```
nterms(x^2*y^2 + x^2 + y + 2, [x, y])
```

```
4
```

```
nterms(poly(x^2*y^2 + x^2 + y + 2))
```

```
4
```

```
nterms(poly(0, [x]))
```

```
0
```

## Example 2

The following polynomial expression may be regarded as a polynomial in different ways:

```
f := x^2*y^2 + x^2 + y + 2:  
nterms(f, [x]), nterms(f, [y]), nterms(f, [x, y]),  
nterms(f, [z])
```

```
2, 3, 4, 1
```

```
delete f:
```

## Parameters

**p**

A polynomial (Symbolic Math Toolbox) of type `DOM_POLY`

**f**

A polynomial expression (Symbolic Math Toolbox)

**vars**

A list on page 7-41 of indeterminates of the polynomial: typically, identifiers on page 7-29 or indexed identifiers on page 1-1017

## Return Values

Nonnegative number. `FAIL` is returned if the input cannot be converted to a polynomial.



## Overloaded By

p

## See Also

### **MuPAD Functions**

[coeff](#) | [degree](#) | [degreevec](#) | [ground](#) | [lcoeff](#) | [ldegree](#) | [lmonomial](#) | [lterm](#) | [monomials](#) | [nthcoeff](#) | [nthmonomial](#) | [nthterm](#) | [poly](#) | [poly2list](#) | [tcoeff](#)

## **nthcoeff**

N-th non-zero coefficient of a polynomial

### **Syntax**

`nthcoeff(p, n)`

`nthcoeff(f, <vars>, n)`

### **Description**

`nthcoeff(p, n)` returns the n-th non-zero coefficient of the polynomial `p`.

`nthcoeff` returns the n-th non-zero coefficient with respect to the lexicographical ordering.

The “first” coefficient is the leading coefficient as returned by `lcoeff`, the “last” coefficient is the trailing coefficient as returned by `tcoeff`.

A zero polynomial has no terms: `nthcoeff` returns `FAIL`.

A polynomial expression `f` is first converted to a polynomial with the variables given by `vars`. If no variables are given, they are searched for in `f`. See `poly` about details of the conversion. `FAIL` is returned if `f` cannot be converted to a polynomial.

The result of `nthcoeff` is not fully evaluated. Evaluation can be enforced by the function `eval`. Cf. “Example 2” on page 1-1465 (Symbolic Math Toolbox).

### **Examples**

#### **Example 1**

We give some self explaining examples:

```
p := poly(100*x^100 + 49*x^49 + 7*x^7, [x]):
nthcoeff(p, 1), nthcoeff(p, 2), nthcoeff(p, 3)
```

```
100, 49, 7
```

```
nthcoeff(p, 4)
```

```
FAIL
```

```
nthcoeff(poly(0, [x]), 1)
```

```
FAIL
```

```
delete p:
```

## Example 2

We demonstrate the evaluation strategy of `nthcoeff`:

```
p := poly(3*x^3 + 6*x^2*y^2 + 2, [x]): y := 4:
nthcoeff(p, 2)
```

```
6 y^2
```

Evaluation is enforced by `eval`:

```
eval(%)
```

```
96
```

```
delete p, y:
```

## Parameters

**p**

A polynomial (Symbolic Math Toolbox) of type `DOM_POLY`

**f**

A polynomial expression (Symbolic Math Toolbox)

**vars**

A list on page 7-41 of indeterminates of the polynomial: typically, identifiers on page 7-29 or indexed identifiers on page 1-1017

**n**

A positive integer

## Return Values

Element of the coefficient domain of the polynomial. An expression is returned if a polynomial expression is given as input. FAIL is returned if n is larger than the actual number of terms.

## Overloaded By

p

## See Also

### MuPAD Functions

coeff | collect | degree | degreevec | ground | lcoeff | ldegree | lmonomial | lterm | monomials | nterms | nthmonomial | nthterm | poly | poly2list | tcoeff

# nthmonomial

N-th monomial of a polynomial

## Syntax

```
nthmonomial(p, n)
```

```
nthmonomial(f, <vars>, n)
```

## Description

`nthmonomial(p, n)` returns the n-th non-trivial monomial of the polynomial `p`.

`nthmonomial` returns the n-th non-trivial monomial with respect to the lexicographical ordering.

The “first” monomial is the leading monomial as returned by `lmonomial`.

A zero polynomial has no terms: `nthmonomial` returns `FAIL`.

A polynomial expression `f` is first converted to a polynomial with the variables given by `vars`. If no variables are given, they are searched for in `f`. See `poly` about details of the conversion. The result is returned as polynomial expression. `FAIL` is returned if `f` cannot be converted to a polynomial.

The result of `nthmonomial` is not fully evaluated. It can be evaluated by the functions `mapcoeffs` and `eval`. Cf. “Example 2” on page 1-1468 (Symbolic Math Toolbox).

## Examples

### Example 1

We give some self explaining examples:

```
p := poly(100*x^100 + 49*x^49 + 7*x^7, [x]):  
nthmonomial(p, 1), nthmonomial(p, 2), nthmonomial(p, 3)
```

```
poly(100 x100, [x]), poly(49 x49, [x]), poly(7 x7, [x])
```

```
nthmonomial(p, 4)
```

```
FAIL
```

```
nthmonomial(poly(0, [x]), 1)
```

```
FAIL
```

```
delete p:
```

## Example 2

We demonstrate the evaluation strategy of `nthmonomial`:

```
p := poly(3*x^3 + 6*x^2*y^2 + 2, [x]): y := 4:  
nthmonomial(p, 2)
```

```
poly((6 y2) x2, [x])
```

Evaluation is enforced by `eval`:

```
mapcoeffs(%, eval)
```

```
poly(96 x2, [x])
```

```
delete p, y:
```

## Parameters

**p**

A polynomial (Symbolic Math Toolbox) of type DOM\_POLY

**f**

A polynomial expression (Symbolic Math Toolbox)

**vars**

A list on page 7-41 of indeterminates of the polynomial: typically, identifiers on page 7-29 or indexed identifiers on page 1-1017

**n**

A positive integer

## Return Values

Polynomial of the same type as **p**. An expression is returned if a polynomial expression is given as input. FAIL is returned if **n** is larger than the actual number of terms of the polynomial.

## Overloaded By

**p**

## See Also

### MuPAD Functions

[coeff](#) | [degree](#) | [degreevec](#) | [ground](#) | [lcoeff](#) | [ldegree](#) | [lmonomial](#) | [lterm](#) | [monomials](#) | [nterms](#) | [nthcoeff](#) | [nthterm](#) | [poly](#) | [poly2list](#) | [tcoeff](#)

## nthterm

N-th term of a polynomial

### Syntax

```
nthterm(p, n)
```

```
nthterm(f, <vars>, n)
```

### Description

`nthterm(p, n)` returns the *n*-th non-zero term of the polynomial on page 1-1601p.

`nthterm` returns the *n*-th non-zero term with respect to the lexicographical ordering.

The “first” term is the leading term as returned by `lterm`.

A zero polynomial has no terms: `nthterm` returns FAIL.

The identity  $nthterm(p, n) nthcoeff(p, n) = nthmonomial(p, n)$  holds.

A polynomial expression *f* is first converted to a polynomial with the variables given by *vars*. If no variables are given, they are searched for in *f*. See `poly` about details of the conversion. The result is returned as polynomial expression. FAIL is returned if *f* cannot be converted to a polynomial.

### Examples

#### Example 1

We give some self explaining examples:

```
p := poly(100*x^100 + 49*x^49 + 7*x^7, [x]):  
nthterm(p, 1), nthterm(p, 2), nthterm(p, 3)
```



```
poly(x100, [x]), poly(x49, [x]), poly(x7, [x])
```

```
nthterm(p, 4)
```

```
FAIL
```

```
nthterm(poly(0, [x]), 1)
```

```
FAIL
```

```
delete p:
```

## Example 2

The  $n$ -th monomial is the product of the  $n$ -th coefficient and the  $n$ -th term:

```
p := poly(2*x^2*y + 3*x*y^2 + 6, [x, y]):
mapcoeffs(nthterm(p, 2), nthcoeff(p, 2)) =
nthmonomial(p, 2)
```

```
poly(3 x y2, [x, y]) = poly(3 x y2, [x, y])
```

```
delete p:
```

## Parameters

**p**

A polynomial (Symbolic Math Toolbox) of type DOM\_POLY

**f**

A polynomial expression (Symbolic Math Toolbox)

**vars**

A list on page 7-41 of indeterminates of the polynomial: typically, identifiers on page 7-29 or indexed identifiers on page 1-1017

**n**

A positive integer

## Return Values

Polynomial of the same type as `p`. An expression is returned if a polynomial expression is given as input. FAIL is returned if `n` is larger than the actual number of terms of the polynomial.

## Overloaded By

`p`

## See Also

**MuPAD Functions**

`coeff` | `degree` | `degreevec` | `ground` | `lcoeff` | `ldegree` | `lmonomial` | `lterm` | `monomials` | `nterms` | `nthcoeff` | `nthmonomial` | `poly` | `poly2list` | `tcoeff`

# null

Generate the void object of type DOM\_NULL

## Syntax

```
null()
```

## Description

`null()` returns the void object of domain type `DOM_NULL`. It represents an empty sequence of MuPAD expressions or statements.

The void object does not produce any output on the screen.

Various systems functions such as `print` or `reset` return the void object.

The void object is removed from sequences (“flattening” (Symbolic Math Toolbox)). It can be used to remove elements from lists or sets. Cf. “Example 2” on page 1-1474 (Symbolic Math Toolbox).

## Examples

### Example 1

`null()` returns the void object which does not produce any screen output:

```
null()
```

The resulting object is of domain type `DOM_NULL`:

```
domtype(null())
```

```
DOM_NULL
```

This object represents the empty expression sequence and the empty statement sequence:

```
domtype(_exprseq()), domtype(_stmtseq())
```

*DOM\_NULL, DOM\_NULL*

Some system functions such as `print` return the void object:

```
print("Hello world!"): 
```

*"Hello world!"*

```
domtype(%)
```

*DOM\_NULL*

## Example 2

The void object is removed from lists on page 7-41, sets on page 7-50, and expression sequences on page 1-88:

```
[null(), a, b, null(), c], {null(), a, b, null(), c},  
f(null(), a, b, null(), c)
```

*[a, b, c], {a, b, c}, f(a, b, c)*

```
a + null() + b = _plus(a, null(), b)
```

*a + b = a + b*

```
subsop([a, x, b], 2 = null()), subs({a, x, b}, x = null())
```

*[a, b], {a, b}*

However, `null()` is a valid entry in arrays and tables:

```
a := array(1..2): a[1] := 1: a[2] := null(): a
```

```
( 1 null() )
```

```
domtype(a[1]), domtype(a[2])
```

```
DOM_INT, DOM_NULL
```

```
t := table(null() = "void", 1 = 2.5, b = null())
```

1	2.5
b	null()
null()	"void"

```
domtype(t[b]), t[]
```

```
DOM_NULL, "void"
```

```
delete a, t:
```

### Example 3

The void object remains if you delete on page 1-499 all elements from an expression sequence:

```
a := (1, b): delete a[1]: delete a[1]: domtype(a)
```

```
DOM_NULL
```

The operand function `op` returns the void object when applied to an object with no operands:

```
domtype(op([])), domtype(op({})), domtype(op(f()))
```

```
DOM_NULL, DOM_NULL, DOM_NULL
```

```
delete a:
```

## **Return Values**

Void object of domain type DOM\_NULL.

## **See Also**

### **MuPAD Functions**

FAIL | NIL | \_exprseq | \_stmtseq

# numer

Numerator of a rational expression

## Syntax

`numer(f)`

## Description

`numer(f)` returns the numerator of the expression `f`.

`numer` regards the input as a rational expression (Symbolic Math Toolbox): non-rational subexpressions such as `sin(x)`, `x^(1/2)` etc. are internally replaced by “temporary variables”. The numerator of this rationalized expression is computed, the temporary variables are finally replaced by the original subexpressions.

---

**Note** Numerator and denominator are not necessarily cancelled: the numerator returned by `numer` may have a non-trivial gcd with the denominator returned by `denom`. Preprocess the expression by `normal` to enforce cancellation of common factors. Cf. “Example 2” on page 1-1478 (Symbolic Math Toolbox).

---

## Examples

### Example 1

We compute the numerators of some expressions:

```
numer(-3/4)
```

```
-3
```

```
numer(x + 1/(2/3*x - 2/x))
```

$$x(2x^2 - 3)$$

```
numer((cos(x)^2 - 1)/(cos(x) - 1))
```

$$\cos(x)^2 - 1$$

## Example 2

numer performs no cancellations if the rational expression is of the form “numerator/denominator”:

```
r := (x^2 - 1)/(x^3 - x^2 + x - 1): numer(r)
```

$$x^2 - 1$$

This numerator has a common factor with the denominator of r; normal enforces cancellation of common factors:

```
numer(normal(r))
```

$$x + 1$$

However, automatic normalization occurs if the input expression is a sum:

```
numer(r + x/(x + 1) + 1/(x + 1) - 1)
```

$$x + 1$$

```
delete r:
```

## Parameters

**f**

An arithmetical expression (Symbolic Math Toolbox)



## Return Values

Arithmetical expression.

## Overloaded By

f

## See Also

### **MuPAD Functions**

denom | factor | gcd | normal

## 0

Domain of order terms (Landau symbols)

### Syntax

`O(f, <x = x0, y = y0, ...>)`

### Description

`O(f, x = x0)` represents the Landau symbol  $O(f, x \rightarrow x_0)$ .

Mathematically, for a function  $f$  in the variables  $(x, y, \dots)$ , the Landau symbol

$$g := O(f, x \rightarrow x_0, y \rightarrow y_0, \dots)$$

is a function in these variables with the following property: there exists a constant  $c$  and a neighborhood of the limit point  $(x_0, y_0, \dots)$  such that  $|g| \leq c|f|$  for all values  $(x, y, \dots)$  in that neighborhood.

---

**Note** Typically, Landau symbols are used to denote the order terms (“error terms”) of series expansions. Note, however, that the series expansions produced by `asymp`, `series`, and `taylor` represent order terms as a part of the data structures `Series::Puiseux` and `Series::gseries`; they do *not* use the domain `0`.

---

With the equations  $x = x_0$ ,  $y = y_0$  etc.,  $f$  is regarded as a function of the specified variables. All other identifiers contained in  $f$  are regarded as constant parameters.

If no variables and limit points are specified, then all identifiers in  $f$  are used as variables, each tending to the default limit point `0`.

Variables tending to `0` are not printed on the screen.

The variables of an order term may be obtained with the function `indets`. The limit points may be queried with the function `0::points`.

The arithmetical operations +, -, \*, /, and ^ are overloaded for order terms.

Automatic simplifications are currently restricted to polynomial expressions f. Univariate polynomial expressions are reduced to the leading monomial of the expansion around the limit point. In multivariate polynomial expressions, all terms are discarded that are divisible by lower order terms. For non-polynomial expressions, only integer factors are removed.

## Examples

### Example 1

For polynomial expressions, certain simplifications occur:

$$0(x^4 + 2*x^2), 0(7*x^3), 0(x, x = 1)$$

$$O(x^2), O(x^3), O(1, x = 1)$$

A zero limit point is not printed on the screen:

$$0(1), 0(1, x = 1), 0(x^2/(y + 1), x = 0, y = -1, z = \pi)$$

$$O(1), O(1, x = 1), O\left(\frac{x^2}{y+1}, y = -1, z = \pi\right)$$

The arithmetical operations are overloaded for order terms:

$$7*0(x), 0(x^2) + 0(x^{13}), 0(x^3) - 0(x^3), 0(x^2)^2 + 0(x^4)$$

$$O(x), O(x^2), O(x^3), O(x^4)$$

### Example 2

For multivariate polynomial expression, higher order terms are discarded if they are divisible by lower order terms:

$$0(15*x*y^2 + 3*x^2*y + x^2*y^2)$$

$$O(x^2 y + 5 x y^2)$$

$$O(x + x^2*y) = O(x)*O(1 + x*y)$$

$$O(x) = O(x)$$

### Example 3

We demonstrate how to access the variables and the limit points of an order term:

```
a := O(x^2*y^2)
```

$$O(x^2 y^2)$$

```
indets(a) = 0::indets(a), 0::points(a)
```

$$\{x, y\} = \{x, y\}, \{x=0, y=0\}$$

```
delete a:
```

## Parameters

**f**

An arithmetical expression (Symbolic Math Toolbox) representing a function in  $x$ ,  $y$  etc.

**x, y, ...**

The variables: identifiers on page 7-29

**x0, y0, ...**

The limit points: arithmetical expressions

## Return Values

Element of the domain 0.

## See Also

### **MuPAD Functions**

`asympt` | `limit` | `series` | `taylor`

## ode

Domain of ordinary differential equations

### Syntax

```
ode(eq, y(x))
```

```
ode({eq, <inits>}, y(x))
```

```
ode({eq1, eq2, , ..., <inits>}, {y1(x), y2(x), ...})
```

### Description

`ode(eq, y(x))` represents an ordinary differential equation (ODE) for the function  $y(x)$ .

`ode({eq1, eq2, ...}, {y1(x), y2(x), ...})` represents a system of ODEs for the functions  $y1(x)$ ,  $y2(x)$  etc.

In the equations `eq`, `eq1` etc., the unknown functions must be represented by  $y(x)$ ,  $y1(x)$  etc. Derivatives may be represented either by the `diff` function or by the differential operator `D`. Note that the token `'` provides a handy shortcut:  $y'(x) = D(y(x))$  means the same as `diff(y(x), x)`.

The unknown functions must be univariate in the independent variable  $x$ . Multivariate expressions such as  $y(x, t)$  are not accepted.

The `ode` function does not accept `piecewise` input.

Initial and boundary conditions are defined by sequences of equations involving the unknown functions or their derivatives on the left hand side. The corresponding values must be specified on the right hand side of the equations. In particular, the differential operator `D` (or the token `'`) must be used to specify values of derivatives at some point. E.g.,

```
{ {y(1) = 2, y'(0) = 0, y''(0) = 1} }
```

is a valid sequence of boundary conditions for `inits`.

Boundary conditions of the first and second kind are allowed. Mixed conditions are not accepted.

The initial/boundary points and the corresponding initial/boundary values may be symbolic expressions.

For scalar initial value or boundary value problems, use `ode({eq, inits}, y(x))` to specify the conditions.

For systems of ODEs, there must be as many equations as unknown functions.

The main purpose of the `ode` domain is to provide an environment for overloading the function `solve`.

In the case of one single equation (possibly together with initial or boundary conditions), `solve` returns a set of explicit solutions or an implicit solution. Each element of the set represents a solution branch.

In the case of a system of equations, `solve` returns a set of lists of equations for the unknown functions. Each list represents a solution branch.

An symbolic `solve` call is returned if no solution is found.

## Examples

### Example 1

In the following, we show how to create and solve a scalar ODE. First, we define the ODE

$x^2 y'(x) + 3 x y(x) = \frac{\sin(x)}{x}$ . We use the quote token ' to represent derivatives:

```
eq := ode(x^2*y'(x) + 3*x*y(x) = sin(x)/x, y(x))
```

$$\text{ode}\left(x^2 y'(x) - \frac{\sin(x)}{x} + 3 x y(x), y(x)\right)$$

We get an element of the domain `ode` which we can now solve:

`solve(eq)`

$$\left\{ \frac{C1}{x^3} - \frac{\cos(x)}{x^3} \right\}$$

`delete eq:`

## Example 2

An initial value problem is defined as a set consisting of the ODE and the initial conditions:

```
ivp := ode({f''(t) + 4*f(t) = sin(2*t),
           f(0) = a, f'(0) = b}, f(t))
```

$$\text{ode}\{f(0) = a, f'(0) = b, f''(t) + 4 f(t) - \sin(2 t)\}, f(t)$$

`solve(ivp)`

$$\left\{ \sin(2 t) \left( \frac{b}{2} + \frac{1}{8} \right) - \frac{\sin(6 t)}{32} - \cos(2 t) \left( \frac{t}{4} - \frac{\sin(4 t)}{16} \right) - \frac{\sin(2 t)}{32} + a \cos(2 t) \right\}$$

`delete ivp:`

## Example 3

With some restrictions, it is also possible to solve systems of ODEs. First, define a system:

```
sys := {x'(t) - x(t) + y(t) = 0, y'(t) - x(t) - y(t) = 0}
```

$$\{x'(t) - x(t) + y(t) = 0, y'(t) - y(t) - x(t) = 0\}$$

A call to `solve` yields the general solution with arbitrary parameters:

```
solution := solve(ode(sys, {x(t), y(t)}))
```

$$\{[y(t) = C7 e^t \cos(t) + C6 e^t \sin(t), x(t) = C6 e^t \cos(t) - C7 e^t \sin(t)]\}$$



To verify the result, substitute it back into the system `sys`. However, for the substitution, you must rewrite the system into a notation using the `diff` function:

```
eval(subs(rewrite(sys, diff), op(solution)))
```

$$\{0 = 0\}$$

```
delete sys, solution:
```

If you have a system of differential equations in a matrix form, extract the components of the matrix to a set of differential equations:

```
Y:= matrix([x(t), y(t)]):
A:= matrix([[1, 2], [-1, 6]]):
s := ode({op(diff(Y, t) - A*Y)}, {x(t), y(t)})
```

$$\text{ode}(\{x'(t) - x(t) - 2 y(t), y'(t) - 6 y(t) + x(t)\}, \{x(t), y(t)\})$$

Now, use the `solve` function to solve the system:

```
solve(s)
```

$$\left\{ \left[ y(t) = C8 \sigma_2 \left( \frac{\sqrt{17}}{4} + \frac{5}{4} \right) - C9 \sigma_1 \left( \frac{\sqrt{17}}{4} - \frac{5}{4} \right), x(t) = C8 \sigma_2 + C9 \sigma_1 \right] \right\}$$

where

$$\sigma_1 = e^{-\frac{t(\sqrt{17}-7)}{2}}$$

$$\sigma_2 = e^{\frac{t(\sqrt{17}+7)}{2}}$$

## Example 4

In this example, we point out the various return formats of `ode`'s solve facility. First, we solve an ODE with an initial condition. The solution involves a symbolic integral:

```
solve(ode({y'(x) + x*y(x) = cos(x), y(0) = 3}, y(x)))
```

$$\left\{ 3 e^{-\frac{x^2}{2}} + e^{-\frac{x^2}{2}} \int_0^x e^{\frac{y^2}{2}} \cos(y) \, dy \right\}$$

For the next equation, we get an implicit solution:

```
solve(ode((x*y'(x) - y(x))^4*exp(x*y'(x) - y(x))  
- ln(x*y'(x) - y(x)), y(x)))
```

$$\text{solve}\left(e^{C11 x - X1027} (X1027 - C11 x)^4 - \ln(C11 x - X1027) = 0, X1027\right)$$

This is an *algebraic* equation for  $y$ . Its solution defines  $y$  as a function of  $x$  and an arbitrary parameter  $C$  followed by a number automatically generated by MuPAD (constant of integration). However, the algebraic equation does not have a solution in closed form.

```
delete sys, solution:
```

## Example 5

It may happen that MuPAD cannot solve a given equation. In such a case, a symbolic `solve` command is returned:

```
solve(ode(x*diff(y(x),x)-y(x)*(x*ln(x^3/y(x))+2), y(x)))
```

$$\text{solve}\left(\text{ode}\left(x y'(x) - y(x) \left(x \ln\left(\frac{x^3}{y(x)}\right) + 2\right), y(x)\right)\right)$$

## Example 6

The MuPAD ODE solver contains algebraic algorithms for computing Liouvillian and non-Liouvillian solutions of linear ordinary differential equations. These algorithms are based on differential Galois theory and on additional methods for finding solutions of linear ordinary differential equations given in terms of special functions. For the famous Kovacic's example

$$y'' + \left( \frac{\frac{3}{16}}{x^2} + \frac{\frac{2}{9}}{(x-1)^2} - \frac{\frac{3}{16}}{x-1} \right) y = 0$$

the solution can be found as:

```
solve(ode(y''(x) + (3/(16*x^2) + 2/(9*(x - 1)^2)
- 3/(16*x*(x - 1)))*y(x), y(x)))
```

$$\left\{ C12 x^{1/4} (x-1)^{2/3} {}_2F_1\left(\frac{1}{4}, \frac{7}{12}; \frac{1}{2}; x\right) + C13 x^{3/4} (x-1)^{2/3} {}_2F_1\left(\frac{3}{4}, \frac{13}{12}; \frac{3}{2}; x\right) \right\}$$

MuPAD may find Liouvillian and non-Liouvillian solutions for higher order equations as well. However, in case of Liouvillian solutions, there is no guarantee that all of them are found.

MuPAD also finds non-Liouvillian solutions in terms of the Bessel, Airy, and Whittaker functions:

```
eq := y'(x) + y(x)^2 + b + a*x
```

$$y'(x) + y(x)^2 + b + a x$$

```
solve(ode(eq, y(x)))
```

$$\left\{ \frac{\text{airyBi}(\sigma_1, 1) + C14 \text{airyAi}(\sigma_1, 1)}{\sigma_2} + \frac{\sqrt{3} \text{airyBi}(\sigma_1, 1) i + \sqrt{3} C14 \text{airyAi}(\sigma_1, 1) i}{\sigma_2} \right\} \\ \frac{\quad}{2 (C14 \text{airyAi}(\sigma_1, 0) + \text{airyBi}(\sigma_1, 0))}$$

where

$$\sigma_1 = -\frac{(-1 + \sqrt{3} i)^2 \left(x + \frac{b}{a}\right)}{4 \sigma_2}$$

$$\sigma_2 = \left(\frac{1}{a}\right)^{1/3}$$

We check this solution:

```
simplify(eval(subs(rewrite(eq, diff), y(x) = op(%))))
```

0

## Example 7

It is also possible to compute the series solutions of an ordinary differential equation (cf. `ode::series` for further details):

```
series(ode(y''(x) + 4*y(x) = sin(w*x), y(x)), x = 0, 8)
```

$$\left\{ y(0) + x y'(0) - 2 x^2 y(0) + x^3 \left( \frac{w}{6} - \frac{\sigma_1}{3} \right) + \frac{2 x^4 y(0)}{3} - x^5 \left( -\frac{\sigma_1}{15} + \frac{w^3}{120} + \frac{w}{30} \right) - \frac{4 x^6 y(0)}{45} + x^7 \left( -\frac{4 y'(0)}{315} + \frac{w^5}{5040} + \frac{w^3}{1260} + \frac{w}{315} \right) + O(x^8) \right\}$$

where

$$\sigma_1 = 2 y'(0)$$

## Parameters

**eq, eq1, eq2, ...**

Equations or arithmetical expressions (Symbolic Math Toolbox) in the unknown functions and their derivatives with respect to  $x$ . An arithmetical expression is regarded as an equation with vanishing right hand side.

**y, y1, y2, ...**

The unknown functions: identifiers on page 7-29

**x**

The independent variable: an identifier

## **inits**

The initial or boundary conditions: a sequence of equations

## **Return Values**

Object of type ode.

## **References**

- [1] E. Kamke. "Differentialgleichungen: Lösungsmethoden und Lösungen". B.G. Teubner, Stuttgart, 1997.
- [2] G.M. Murphy. "Ordinary differential equations and their solutions". Van Nostrand, Princeton, 1960.
- [3] D. Zwillinger. "Handbook of differential equations". San Diego: Academic Press, 1992.
- [4] W. Fakler. Algebraische Algorithmen zur Lösung von linearen Differentialgleichungen. Stuttgart, Leipzig: Teubner, Reihe MuPAD Reports, 1999.
- [5] M. van der Put and M.F. Singer. "Galois theory of linear differential equations". Grundlehren der Mathematischen Wissenschaften, 328, Springer-Verlag, Berlin, 2003.
- [6] F. Ulmer and M.F. Singer. Liouvillian and algebraic solutions of second and third order linear differential equations. "J. Symb. Comp.", 16:37-74, 1993.

## **See Also**

### **MuPAD Domains**

`Dom::LinearOrdinaryDifferentialOperator`

### **MuPAD Functions**

`numeric::odesolve` | `numeric::odesolve2` | `ode::series` | `ode::solve`

### **MuPAD Graphical Primitives**

`plot::ode2d` | `plot::ode3d`

## **Topics**

“Solve Ordinary Differential Equations and Systems” (Symbolic Math Toolbox)

“Solve Equations Numerically” (Symbolic Math Toolbox)

## op

Operands of an object

### Syntax

```
op(object)
```

```
op(object, i)
```

```
op(object, i .. j)
```

```
op(object, [i1, i2, ...])
```

### Description

`op(object)` returns all operands of the object.

`op(object, i)` returns the  $i$ -th operand.

`op(object, i .. j)` returns the  $i$ -th to  $j$ -th operands.

MuPAD objects are composed of simpler parts: the “operands”. The function `op` is the tool to decompose objects and to extract individual parts. The actual definition of an operand depends on the type of the object. The 'Background' section below explains the meaning for some of the basic data types.

`op(object)` returns a sequence on page 1-88 of all operands except the 0-th one. This call is equivalent to `op(object, 1..nops(object))`. Cf. “Example 1” on page 1-1494 (Symbolic Math Toolbox).

`op(object, i)` returns the  $i$ -th operand. Cf. “Example 2” on page 1-1495 (Symbolic Math Toolbox).

`op(object, i .. j)` returns the  $i$ -th to  $j$ -th operands as an expression sequence on page 1-88;  $i$  and  $j$  must be nonnegative integers with  $i$  smaller or equal to  $j$ . This sequence is equivalent to `op(object, k) $k = i..j`. Cf. “Example 3” on page 1-1495 (Symbolic Math Toolbox).

`op(object, [i1, i2, ...])` is an abbreviation for the recursive call `op (... op ( op(object, i1) , i2) , ...)` if `i1, i2, ...` are integers.

A call such as `op(object, [i..j, i2])` with integers `i < j` corresponds to `map(op(object, i..j), op, i2)`. Cf. “Example 4” on page 1-1496 (Symbolic Math Toolbox).

`op` returns `FAIL` if the specified operand does not exist. Cf. “Example 5” on page 1-1497 (Symbolic Math Toolbox).

Expressions of domain type `DOM_EXPR`, arrays on page 7-2, `hfarrays` on page 7-27, and floating point intervals on page 7-33 have a 0-th operand.

- For expressions, this is “the operator” connecting the other operands. In particular, for symbolic function calls, it is the name of the function.
- For array and `hfarrays`, the 0-th operand is a sequence consisting of an integer (the dimension of the array) and a range for each array index.
- For a floating-point interval, the value of the 0-th operand depends on the precise type of the interval: If the interval is a union of rectangles, the 0-th operand is `hold(_union)`. If the interval is not a union and consists only of real numbers, the 0-th operand is `hold(hull)`. In the remaining case of a rectangle with non-vanishing imaginary part, the 0-th operand is `FAIL`.

Other basic data types such as lists on page 7-41 or sets on page 7-50 do not have a 0-th operand. Cf. “Example 6” on page 1-1497 (Symbolic Math Toolbox).

For library domains (Symbolic Math Toolbox), `op` is overloadable (Symbolic Math Toolbox). In the “`op`” method, the internal representation can be accessed with `extop`. It is sufficient to handle the cases `op(x)`, `op(x, i)`, and `op(x, i..j)` in the overloading method, the call `op(x, [i1, i2, ...])` needs not be considered. Cf. “Example 7” on page 1-1498 (Symbolic Math Toolbox).

`op` is not overloadable for kernel domains.

## Examples

### Example 1

The call `op(object)` returns all operands:



op([a, b, c, [d, e], x + y])

*a, b, c, [d, e], x + y*

op(a + b + c<sup>d</sup>)

*a, b, c<sup>d</sup>*

op(f(x1, x2, x3))

*x1, x2, x3*

## Example 2

The call op(object, i) extracts a single operand:

op([a, b, c, [d, e], x + y], 4)

*[d, e]*

op(a + b + c<sup>d</sup>, 3)

*c<sup>d</sup>*

op(f(x1, x2, x3), 2)

*x2*

## Example 3

The call op(object, i..j) extracts a range of operands:

op([a, b, c, [d, e], x + y], 3..5)

*c, [d, e], x + y*

`op(a + b + c^d, 2..3)`

*b, c<sup>d</sup>*

`op(f(x1, x2, x3), 2..3)`

*x2, x3*

A range may include the 0-th operand if it exists:

`op(a + b + c^d, 0..2)`

*\_plus, a, b*

`op(f(x1, x2, x3), 0..2)`

*f, x1, x2*

## **Example 4**

The call `op(object, [i1, i2, ...])` specifies suboperands:

`op([a, b, c, [d, e], x + y], [4, 1])`

*d*

`op(a + b + c^d, [3, 2])`

*d*

`op(f(x1, x2, x3 + 17), [3, 2])`

*17*

Also ranges of suboperands can be specified:

`op([a, b, c, [d, e], x + y], [4..5, 2])`

`e, y`

`op(a + b + c^d, [2..3, 1])`

`b, c`

`op(f(x1, x2, x3 + 17), [2..3, 1])`

`x2, x3`

## Example 5

Nonexisting operands are returned as FAIL:

`op([a, b, c, [d, e], x + y], 8), op(a + b + c^d, 4),  
op(f(x1, x2, x3), 4)`

`FAIL, FAIL, FAIL`

## Example 6

For expressions of type DOM\_EXPR, the 0-th operand is “the operator” connecting the other operands:

`op(a + b + c, 0), op(a*b*c, 0), op(a^b, 0), op(a[1, 2], 0)`

`_plus, _mult, _power, _index`

For symbolic function calls, it is the name of the function:

`op(f(x1, x2, x3), 0), op(sin(x + y), 0), op(besselJ(0, x), 0)`

`f, sin, besselJ`

The 0-th operand of an array is a sequence consisting of the dimension of the array and a range for each array index:

```
op(array(3..100), 0)
```

```
1, 3..100
```

```
op(array(1..2, 1..3, 2..4), 0)
```

```
3, 1..2, 1..3, 2..4
```

```
op(hfarray(3..100), 0)
```

```
1, 3..100
```

```
op(hfarray(1..2, 1..3, 2..4), 0)
```

```
3, 1..2, 1..3, 2..4
```

No 0-th operand exists for other kernel domains:

```
op([1, 2, 3], 0), op({1, 2, 3}, 0), op(table(1 = y), 0)
```

```
FAIL, FAIL, FAIL
```

## Example 7

For library domains, `op` is overloadable. First, a new domain `d` is defined via `newDomain`. The "new" method serves for creating elements of this type. The internal representation of the domain is a list of all arguments of this "new" method:

```
d := newDomain("d"): d::new := () -> new(dom, [args()]):
```

The "op" method of this domain is defined. It is to return the elements of a sorted copy of the internal list which is accessed via `extop`:

```
d::op := proc(x, i = null())  
    local internalList;
```

```

begin
  internalList := extop(x, 1);
  op(sort(internalList), i)
end_proc:

```

By overloading, this method is called when the operands of an object of type `d` are requested via `op`:

```

e := d(3, 7, 1):
op(e);
op(e, 2);
op(e, 1..2)

```

```

1, 3, 7

```

```

3

```

```

1, 3

```

```

delete d, e:

```

## Example 8

Identifiers on page 7-29, integers on page 7-31, real floating-point numbers on page 7-23, character strings on page 7-53, and the Boolean constants on page 7-4 are “atomic” objects. The only operand is the object itself:

```

op(x), op(17), op(0.1234), op("Hello World!")

```

```

x, 17, 0.1234, "Hello World!"

```

For rational numbers on page 7-48, the operands are the numerator and the denominator:

```

op(17/3)

```

```

17, 3

```

For complex numbers on page 7-84, the operands are the real part and the imaginary part:

```
op(17 - 7/3*I)
```

17,  $-\frac{7}{3}$

## Example 9

For sets on page 7-50, `op` returns the elements according to the *internal* order. Note that this order may differ from the ordering with which sets are printed on the screen:

```
s := {i^2 $ i = 1..19}
```

{1, 4, 9, 16, 25, 36, 49, 64, 81, 100, 121, 144, 169, 196, 225, 256, 289, 324, 361}

```
op(s)
```

1, 4, 361, 9, 16, 25, 36, 49, 64, 81, 100, 121, 144, 169, 196, 225, 256, 289, 324

Indexed access to set elements uses the ordering visible on the screen:

```
s[1], s[2], s[3]
```

1, 4, 9

Note that access to set elements via `op` is *much faster* than indexed calls:

```
s := {sqrt(i) $ i = 1..500};  
time([op(s)])/time([s[i] $ i = 1..nops(s)]);
```

$\frac{1}{364}$

```
delete s:
```

## Example 10

The operands of a list on page 7-41 are its entries:

```
op([a, b, c, [d, e]])
```

```
a, b, c, [d, e]
```

```
op([[a11, a12], [a21, a22]], [2, 1])
```

```
a21
```

## Example 11

Internally, the operands of arrays on page 7-2 and hfarrays on page 7-2 form a "linear" sequence containing all entries:

```
op(array(1..2, 1..2, [[11, 12], [21, 22]]))
```

```
11, 12, 21, 22
```

```
op(hfarray(1..2, 1..2, [[11, 12], [21, 22]]))
```

```
11.0, 12.0, 21.0, 22.0
```

Undefined entries are returned as NIL:

```
op(array(1..2, 1..2))
```

```
NIL, NIL, NIL, NIL
```

## Example 12

The operands of a table on page 1-2103 consist of equations relating the indices and the corresponding entries:

```
T := table((1, 2) = x + y, "diff(sin)" = cos, a = b)
```

```
      a b
    1, 2 x + y
"diff(sin)" | cos
```

`op(T)`

```
(1, 2) = x + y, "diff(sin)" = cos, a = b
```

`delete T:`

### Example 13

Expression sequences are not flattened (Symbolic Math Toolbox):

```
op((a, b, c), 2)
```

```
b
```

Note, however, that the arguments passed to `op` are evaluated. In the following call, evaluation of `x` flattens this object:

```
x := hold((1, 2), (3, 4)): op(x, 1)
```

```
1
```

Use `val` to prevent simplification of `x`:

```
op(val(x), 1)
```

```
1, 2
```

`delete x:`



## Parameters

### **object**

An arbitrary MuPAD object

### **i, j**

Nonnegative integers

### **i1, i2, ...**

Nonnegative integers or ranges on page 1-16 of such integers

## Return Values

sequence on page 1-88 of operands or the requested operand. **FAIL** is returned if no corresponding operand exists.

## Overloaded By

object

## Algorithms

We explain the meaning of “operands” for some basic data types:

- Identifiers on page 7-29, integers on page 7-31, real floating-point numbers on page 7-23, character strings on page 7-53, as well as the Boolean constants on page 7-4 are “atomic” objects. They have only one operand: the object itself. Cf. “Example 8” on page 1-1499 (Symbolic Math Toolbox).
- A rational number of type `DOM_RAT` has two operands: the numerator and the denominator. Cf. “Example 8” on page 1-1499 (Symbolic Math Toolbox).
- A complex number of type `DOM_COMPLEX` has two operands: the real part and the imaginary part. Cf. “Example 8” on page 1-1499 (Symbolic Math Toolbox).

- The operands of a set on page 7-50 are its elements.

---

**Note** Note that the ordering of the elements as printed on the screen does not necessarily coincide with the internal ordering referred to by `op`. Cf. “Example 9” on page 1-1500 (Symbolic Math Toolbox).

---

- The operands of a list on page 7-41 are its elements. Cf. “Example 10” on page 1-1501 (Symbolic Math Toolbox).
- The operands of arrays on page 7-2 and `hfarrays` on page 7-27 are its entries. Undefined entries are returned as `NIL`. Cf. “Example 11” on page 1-1501 (Symbolic Math Toolbox) and “Example 6” on page 1-1497 (Symbolic Math Toolbox).
- The operands of tables on page 1-2103 are the equations associating an index with the corresponding entry. Cf. “Example 12” on page 1-1501 (Symbolic Math Toolbox).
- The operands of an expression sequence on page 1-88 are its elements. Note that such sequences are not flattened (Symbolic Math Toolbox) by `op`. Cf. “Example 13” on page 1-1502 (Symbolic Math Toolbox).
- The operands of a symbolic function call such as `f(x, y, ...)` are the arguments `x`, `y` etc. The function name `f` is the 0-th operand.
- In general, the operands of expressions of type `DOM_EXPR` are given by their internal representation. There is a 0-th operand (“the operator”) corresponding to the type of the expression. Internally, the operator is a system function, the expression corresponds to a function call. E.g., `a + b + c` has to be interpreted as `_plus(a, b, c)`, a symbolic indexed call such as `A[i, j]` corresponds to `_index(A, i, j)`. The name of the system function is the 0-th operand (i.e., `_plus` and `_index` in the previous examples), the arguments of the function call are the further operands.

## See Also

### MuPAD Functions

`_index` | `contains` | `extnops` | `extop` | `extsubsop` | `map` | `new` | `nops` | `select` | `split` | `subs` | `subsex` | `subsop` | `zip`

# operator

Define a new operator symbol

## Syntax

```
operator(symb, f, <Prefix | Postfix | Binary | Nary, prio>, <Global>)
```

```
operator(symb, Delete, <Global>)
```

## Description

`operator(symb, f, T, prio)` defines a new operator symbol `symb` of type `T` with priority `prio`. The function `f` evaluates expressions using the new operator.

`operator(symb, Delete)` removes the definition of the operator symbol `symb`.

`operator` is used to define new user-defined operator symbols or to delete them.

Given the operator symbol "++", say, with evaluating function `f`, the following expressions are built by the parser, depending on the type of the operator:

- **Prefix:**

The input `++x` results in `f(x)`.

- **Postfix:**

The input `x++` results in `f(x)`.

- **Binary:**

The input `x ++ y ++ z` results in `f(f(x, y), z)`.

- **Nary:**

The input `x ++ y ++ z` results in `f(x, y, z)`.

There may exist operator symbols which are prefixes of other operator symbols. The scanner reads as many characters as possible and chooses the longest matching operator symbol. Cf. "Example 3" on page 1-1507 (Symbolic Math Toolbox).

It is not possible to define two operators with the same symbol. So one may not define a unary ++ and a binary ++ at the same time.

The following restrictions exist for the operator symbol string `ymb`:

- It may not be longer than 32 characters.
- It may not start with a white-space.
- It may not start with a \ (backslash) character.

Thus, the strings " @ " and " / " are not allowed. Please note that currently operator does not check these restrictions.

Builtin operators may be redefined.

It is not possible to define out-fix operators like  $|x|$  or 3-nary or other types of operators.

The new operator symbol is also used if files are read, with one exception: if a file is read with the function `read` using the option `Plain`, the new operator is not taken into account. (This option is used if MuPAD library files are read, because otherwise user-defined operators could change the meaning of the source code in an uncontrolled way.)

If the operator is defined while reading a file with option `Plain`, the definition will be used for the remainder of the file and then be deleted automatically. If the operator is defined with the option `Global`, this behavior is changed and the operator will not be active while reading the file, but will exist at the interactive level instead.

## Environment Interactions

The new operator symbol `ymb` is known by the parser and may be used to enter expressions. The new operator symbol will *not* be used when reading files using the function `read` with the option `Plain`.

The function `f` corresponding to the new operator will always be converted into a function environment containing an additional output routine for the operator output, unless it contained an output routine already.

## Examples

### Example 1

This example shows how to define an operator symbol for the bit-shift operation (as in the language C):

```
bitshiftleft := (a, b) -> a * 2^b:
operator("<<", bitshiftleft, Binary, 950):
```

After this call, the symbol << can be used to enter expressions:

```
2 << 1, x << y
```

```
4, 2yx
```

```
operator("<<", Delete):
```

### Example 2

Identifiers can be used as operator symbols:

```
operator("x", _vector_product, Binary, 1000):
```

```
PRETTYPRINT := FALSE:
print(Plain, a x b x c)
```

```
(a x b) x c
```

```
PRETTYPRINT := TRUE:
operator("x", Delete):
```

### Example 3

This example shows that the scanner tries to match the longest operator symbol:

```
operator("~", F, Prefix, 1000):
operator("~>", F1, Prefix, 1000):
operator("~>", F2, Prefix, 1000):
```

```
print(Plain, ~~ x, ~~> x, ~ ~> x, ~~~> x)
```

```
~ ~ x, ~~> x, ~ ~> x, ~ ~~~> x
```

```
operator("~", Delete):  
operator("~>", Delete):  
operator("~~>", Delete):
```

## Parameters

### **symp**

The operator symbol: a character string on page 7-53.

### **f**

The function (Symbolic Math Toolbox) evaluating expressions using the operator.

### **prio**

The priority of the operator: an integer between 1 and 1999. The default is 1300.

## Options

### **Prefix**

The operator is regarded as a unary operator with prefix notation. Given the operator symbol "++" and the evaluation function *f*, the input ++*x* is parsed as the expression *f*(*x*).

### **Postfix**

The operator is regarded as a unary operator with postfix notation. Given the operator symbol "++" and the evaluation function *f*, the input *x*++ is parsed as the expression *f*(*x*).

## Binary

The operator is regarded as a non-associative binary operator with infix notation. Given the operator symbol "++" and the evaluation function  $f$ , the input  $x ++ y ++ z$  is parsed as the expression  $f(f(x, y), z)$ , i.e. the operator binds left-to-right.

## Nary

The operator is regarded as an associative n-ary operator with infix notation. Given the operator symbol "++" and the evaluation function  $f$ , the input  $x ++ y ++ z$  is parsed as the expression  $f(x, y, z)$ .

## Delete

The operator with symbol `symb` is deleted

## Global

When defining an operator inside library or package code (technically: inside a file which is read with the option `Plain`), the option `Global` changes the meaning of the operator definition: Instead of defining an operator for the remainder of the file, it defines an operator for the interactive level.

## Return Values

Void object of type `DOM_NULL`.

## Algorithms

When the scanner reads a new token, it first discards any whitespace and backslash characters. Then it tries to match user-defined operator symbols. The longest user-defined operator symbol matching the scanned characters is made the next token. If no user-defined operator symbol matches, it scans for the built-in tokens.

The parser uses both recursive-descend and a operator precedence parsing. Built-in and user-defined operators are parsed using operator precedence.

## ORDER

Default number of terms in series expansions

### Description

The environment variable `ORDER` controls the default number of terms that the system returns when you compute a series expansion.

Possible values: Positive integer less than  $2^{31}$ . The default value is 6.

The functions `taylor`, `series`, and `asympt` have an optional third argument specifying the desired number of terms of the requested series expansion, counting from the dominant term on (relative order). If this optional argument is missing, then the value of `ORDER` is used instead.

`ORDER` may also affect the results returned by the function `limit`.

Deletion via the statement “`delete ORDER`” resets `ORDER` to its default value 6. Executing the function `reset` also restores the default value.

In some cases, the number of terms returned by `taylor`, `series`, or `asympt` may not agree with the value of `ORDER`. Cf. “Example 2” on page 1-1511 (Symbolic Math Toolbox).

### Examples

#### Example 1

In the following example, we compute the first 6 terms of the series expansion of the function  $\exp(x)/x^2$  around the origin:

```
series(exp(x)/x^2, x = 0)
```

$$\frac{1}{x^2} + \frac{1}{x} + \frac{1}{2} + \frac{x}{6} + \frac{x^2}{24} + \frac{x^3}{120} + O(x^4)$$



To obtain the first 10 terms, we specify the third argument of `series`:

```
series(exp(x)/x^2, x = 0, 10)
```

$$\frac{1}{x^2} + \frac{1}{x} + \frac{1}{2} + \frac{x}{6} + \frac{x^2}{24} + \frac{x^3}{120} + \frac{x^4}{720} + \frac{x^5}{5040} + \frac{x^6}{40320} + \frac{x^7}{362880} + O(x^8)$$

Alternatively, we increase the value of `ORDER`. This affects all subsequent calls to `series` or any other function returning a series expansion:

```
ORDER := 10: series(exp(x)/x^2, x = 0)
```

$$\frac{1}{x^2} + \frac{1}{x} + \frac{1}{2} + \frac{x}{6} + \frac{x^2}{24} + \frac{x^3}{120} + \frac{x^4}{720} + \frac{x^5}{5040} + \frac{x^6}{40320} + \frac{x^7}{362880} + O(x^8)$$

```
taylor(x^2/(1 - x), x = 0)
```

$$x^2 + x^3 + x^4 + x^5 + x^6 + x^7 + x^8 + x^9 + x^{10} + x^{11} + O(x^{12})$$

Finally, we reset `ORDER` to its default value 6:

```
delete ORDER: taylor(x^2/(1 - x), x = 0)
```

$$x^2 + x^3 + x^4 + x^5 + x^6 + x^7 + O(x^8)$$

## Example 2

The number of terms returned by `series` may differ from the value of `ORDER` when cancellation or rational exponents occur:

```
ORDER := 3:
```

```
series(exp(x) - 1 - x - x^2/2 - x^3/6, x = 0)
```

$$\frac{x^4}{24} + \frac{x^5}{120} + O(x^6)$$

```
series(1/(1 - sqrt(x)), x = 0)
```

$$1 + \sqrt{x} + x + x^{3/2} + x^2 + x^{5/2} + O(x^3)$$

delete ORDER:

## See Also

### MuPAD Functions

0 | [asympt](#) | [limit](#) | [series](#) | [taylor](#)

# pade

Pade approximation

## Syntax

```
pade(f, x, <[m, n]>)
```

```
pade(f, x = x0, <[m, n]>)
```

## Description

`pade(f, ...)` computes a Pade approximant of the expression  $f$ .

The Pade approximant of order  $[m, n]$  around  $x = x_0$  is a rational expression

$$\frac{(x-x_0)^p (a_0 + a_1(x-x_0) + \dots + a_m(x-x_0)^m)}{1 + b_1(x-x_0) + \dots + b_n(x-x_0)^n}$$

approximating  $f$ . The parameters  $p$  and  $a_0$  are given by the leading order term  $f = a_0(x - x_0)^p + O((x - x_0)^{p+1})$  of the series expansion of  $f$  around  $x = x_0$ . The parameters  $a_1, \dots, b_n$  are chosen such that the series expansion of the Pade approximant coincides with the series expansion of  $f$  to the maximal possible order.

The expansion points `infinity`, `-infinity`, and `complexInfinity` are not allowed.

If no series expansion of  $f$  can be computed, then `FAIL` is returned. Note that `series` must be able to produce a Taylor series or a Laurent series of  $f$ , i.e., an expansion in terms of integer powers of  $x - x_0$  must exist.

## Examples

### Example 1

The Pade approximant is a rational approximation of a series expansion:

```
f := cos(x)/(1 + x): P := pade(f, x, [2, 2])
```

$$\frac{-7x^2 + 2x + 12}{x^2 + 14x + 12}$$

For most expressions of leading order 0, the series expansion of the Pade approximant coincides with the series expansion of the expression through order  $m + n$ :

```
S := series(f, x, 6)
```

$$1 - x + \frac{x^2}{2} - \frac{x^3}{2} + \frac{13x^4}{24} - \frac{13x^5}{24} + O(x^6)$$

This differs from the expansion of the Pade approximant at order 5:

```
series(P, x, 6)
```

$$1 - x + \frac{x^2}{2} - \frac{x^3}{2} + \frac{13x^4}{24} - \frac{85x^5}{144} + O(x^6)$$

The series expansion can be used directly as input to pade:

```
pade(S, x, [2, 3]), pade(S, x, [3, 2])
```

$$-\frac{5x^2 - 12}{x^3 + x^2 + 12x + 12}, \frac{-7x^3 + 7x^2 + 12x - 12}{13x^2 - 12}$$

Both Pade approximants approximate  $f$  through order  $m + n = 5$ :

```
map([%], series, x)
```

$$\left[ 1 - x + \frac{x^2}{2} - \frac{x^3}{2} + \frac{13x^4}{24} - \frac{13x^5}{24} + O(x^6), 1 - x + \frac{x^2}{2} - \frac{x^3}{2} + \frac{13x^4}{24} - \frac{13x^5}{24} + O(x^6) \right]$$

delete f, P, S:

## Example 2

The following expression does not have a Laurent expansion around  $x = 0$ :

`series(x^(1/3)/(1 - x), x)`

$$x^{1/3} + x^{4/3} + x^{7/3} + x^{10/3} + x^{13/3} + x^{16/3} + O(x^{19/3})$$

Consequently, pade fails:

`pade(x^(1/3)/(1 - x), x, [3, 2])`

FAIL

## Example 3

Note that the specified orders  $[m, n]$  do not necessarily coincide with the orders of the numerator and the denominator if the series expansion does not start with a constant term:

`pade(x^10*exp(x), x, [2, 2]), pade(x^(-10)*exp(x), x, [2, 2])`

$$\frac{x^{10} (x^2 + 6x + 12)}{x^2 - 6x + 12}, \frac{x^2 + 6x + 12}{x^{10} (x^2 - 6x + 12)}$$

## Parameters

**f**

An arithmetical expression (Symbolic Math Toolbox) or a series of domain type `Series::Puiseux` generated by the function `series`

**x**

An identifier on page 7-29

**x0**

An arithmetical expression (Symbolic Math Toolbox). If `x0` is not specified, then `x0 = 0` is assumed.

**[m, n]**

A list of nonnegative integers specifying the order of the approximation. The default values are `[3, 3]`.

## Return Values

Arithmetical expression or FAIL.

## See Also

**MuPAD Functions**

`series`

# partfrac

Partial fraction decomposition

## Syntax

`partfrac(f, <x>)`

`partfrac(f, x, options)`

## Description

`partfrac(f, x)` returns the partial fraction decomposition of the rational expression  $f$  with respect to the variable  $x$ .

Consider the rational expression  $f(x) = g(x) + \frac{p(x)}{q(x)}$  with polynomials  $g, p, q$ , such that  $\text{degree}(p) < \text{degree}(q)$ .

Factor of the denominator into non-constant and pair-wise coprime polynomials  $q_i$  with integer exponents  $e_i$ :

$$q(x) = q_1(x)^{e_1} q_2(x)^{e_2} \dots$$

The partial fraction decomposition based on this factorization is a representation

$$f(x) = g(x) + \frac{p_{1,1}(x)}{q_1(x)} + \dots + \frac{p_{1,e_1}(x)}{q_1(x)^{e_1}} + \frac{p_{2,1}(x)}{q_2(x)} + \dots + \frac{p_{2,e_2}(x)}{q_2(x)^{e_2}} + \dots$$

where  $p_{i,j}$  are polynomials, such that  $\text{degree}(p_{i,j}) < \text{degree}(q_i)$ . In particular,  $p_{i,j}$  are constants if  $q_i$  is a linear polynomial.

`partfrac` uses factors  $q_i$  found by the `factor` function. This function finds factorization over the field implied by the coefficients of the denominator. See “Example 2” on page 1-1519 (Symbolic Math Toolbox).

If `f` has only one indeterminate, and you do not use options, then you can omit the second argument `x` in a call to `partfrac`. Otherwise, specify the indeterminate as a second parameter.

`partfrac` can also find partial fraction decomposition with respect to expressions instead of variables. See “Example 3” on page 1-1519 (Symbolic Math Toolbox).

The option `Full` invokes a full factorization of the denominator into linear factors. The `MaxDegree` option determines whether partial fraction decomposition is a symbolic sum of `RootOf` terms or an expression in radicals. In general, roots belonging to an irreducible factor of the denominator of degree five or larger cannot be expressed in terms of radicals. See “Example 6” on page 1-1521 (Symbolic Math Toolbox).

## Examples

### Example 1

Find partial fraction decomposition of the following expressions. You can omit specifying a variable because these rational expressions are univariate.

```
partfrac(x^2/(x^3 - 3*x + 2))
```

$$\frac{5}{9(x-1)} + \frac{1}{3(x-1)^2} + \frac{4}{9(x+2)}$$

```
partfrac(23 + (x^4 + x^3)/(x^3 - 3*x + 2))
```

$$x + \frac{19}{9(x-1)} + \frac{2}{3(x-1)^2} + \frac{8}{9(x+2)} + 24$$

```
partfrac(x^3/(x^2 + 3*I*x - 2))
```

$$x - \frac{7x + 6i}{x^2 + 3xi - 2} - 3i$$



Find partial fraction decomposition of the following expression containing two variables,  $x$  and  $y$ . For multivariate expressions, specify the variable with respect to which you compute the partial fraction decomposition.

```
f := x^2/(x^2 - y^2):
partfrac(f, x), partfrac(f, y)
```

$$\frac{y}{2(x-y)} - \frac{y}{2(x+y)} + 1, \frac{x}{2(x+y)} + \frac{x}{2(x-y)}$$

```
delete f:
```

## Example 2

Find the partial fraction decomposition of this expression.

```
partfrac(1/(x^2 - 2), x)
```

$$\frac{1}{x^2 - 2}$$

The denominator  $x^2 - 2$  does not factor over the rational numbers.

```
factor(x^2 - 2)
```

$$x^2 - 2$$

Extend the coefficient field used by `factor` and `partfrac` by using the `Adjoin` option.

```
partfrac(1/(x^2 - 2), x, Adjoin = [sqrt(2)])
```

$$\frac{\sqrt{2}}{4(x-\sqrt{2})} - \frac{\sqrt{2}}{4(x+\sqrt{2})}$$

## Example 3

Find the partial fraction decomposition with respect to an expression, such as  $\sin(x)$ .

```
partfrac(1/(sin(x)^4 - sin(x)^2 + sin(x) - 1), sin(x))
```

$$\frac{1}{3(\sin(x) - 1)} - \frac{\frac{\sin(x)^2}{3} + \frac{2\sin(x)}{3} + \frac{2}{3}}{\sin(x)^3 + \sin(x)^2 + 1}$$

### Example 4

Return a list consisting of the numerators and denominators of the partial fraction decomposition by using the `List` option.

```
partfrac(x^2/(x^3 - 3*x + 2), x, List)
```

$$\left[\frac{4}{9}, \frac{5}{9}, \frac{1}{3}\right], [x+2, x-1, (x-1)^2]$$

### Example 5

Find the partial fraction decomposition using numeric factorization over the field real numbers, `R_`.

```
partfrac(1/(x^3 - 2), x, Domain = R_)
```

$$\frac{0.2099868416}{x - 1.25992105} - \frac{0.2099868417x + 0.529133684}{x^2 + 1.25992105x + 1.587401052}$$

Find the partial fraction decomposition of the same expression using numeric factorization over the field complex numbers, `C_`.

```
partfrac(1/(x^3 - 2), x, Domain = C_)
```

$$\frac{0.2099868416}{x - 1.25992105} + \frac{-0.1049934208 + 0.1818539393i}{x + 0.6299605249 - 1.091123636i} + \frac{-0.1049934208 - 0.1818539393i}{x + 0.6299605249 + 1.091123636i}$$

## Example 6

Find the partial fraction decomposition factoring the denominator into linear factors symbolically. For this, use the `Full` option.

```
partfrac(1/(x^3 + x - 2), x, Full)
```

$$\frac{1}{4(x-1)} + \frac{-\frac{1}{8} + \frac{3\sqrt{7}i}{56}}{x + \frac{1}{2} - \frac{\sqrt{7}i}{2}} - \frac{\frac{1}{8} + \frac{3\sqrt{7}i}{56}}{x + \frac{1}{2} + \frac{\sqrt{7}i}{2}}$$

For irreducible denominators of the third and higher degrees, the partial fraction decomposition is a symbolic sum of the roots.

```
S:= partfrac(1/(x^3 + x - 3), x, Full)
```

$$\sum_{k=1}^3 \left( -\frac{\frac{6 \operatorname{RootOf}(z^3 + z - 3, z, k)^2}{247} + \frac{27 \operatorname{RootOf}(z^3 + z - 3, z, k)}{247} + \frac{4}{247}}{\operatorname{RootOf}(z^3 + z - 3, z, k) - x} \right)$$

MuPAD uses the `freeze` function to keep the result in the form of an unevaluated symbolic sum. To evaluate this symbolic sum, use `unfreeze`. Evaluating this symbolic sum simplifies it back to the original input.

```
unfreeze(S); delete S;
```

$$\frac{1}{x^3 + x - 3}$$

## Parameters

**f**

Rational expression (Symbolic Math Toolbox) in  $x$

**x**

Indeterminate: typically, an identifier on page 7-29 or an indexed identifier on page 1-1017

## Options

### Full

Factor the denominator completely into linear factors, and find the partial fraction decomposition with respect to that factorization.

### List

Return a list consisting of the numerators and denominators of the partial fraction decomposition.

### MaxDegree

Option, specified as `MaxDegree = n`

Adjoin only the coefficients of the denominator with the algebraic degree not exceeding  $n$  to the field over which the denominator is factored. If you also use `Full`, then `partfrac` does not use explicit formulas involving radicals to solve polynomial equations of a degree higher than  $n$ .

### Adjoin

Option, specified as `Adjoin = g`

Factor the denominator over the smallest field containing the rational numbers, all coefficients of the denominator, and the elements of  $g$ .

### Domain

Option, specified as `Domain = d`

Factor the denominator over the domain  $d$ , where  $d$  is one of the following: `Expr`, `R_`, or `C_`. By default,  $d = \text{Expr}$ . For more details, see `factor`.

**Mapcoeffs**

Option, specified as `Mapcoeffs = mp`

When building the resulting expression, insert `mp(c)` instead of each coefficient `c`.

**Return Values**

arithmetical expression (Symbolic Math Toolbox).

**Overloaded By**

f

**See Also****MuPAD Functions**

`collect` | `denom` | `divide` | `expand` | `factor` | `normal` | `numer` | `rectform` | `rewrite` | `simplify`

**Topics**

“Manipulate Expressions” (Symbolic Math Toolbox)

“Choose Simplification Functions” (Symbolic Math Toolbox)

## pathname

Create a platform dependent path name

### Syntax

```
pathname(dir, subdir, ...)
```

```
pathname(<Root>, dir, subdir, ...)
```

### Description

`pathname(dir, subdir, ...)` returns a relative path name valid on the used operating system.

`pathname` is used to specify pathnames via MuPAD strings. Directories and subdirectories are concatenated in a suitable way creating a valid pathname for the currently used operating system. For example, this mechanism may be used to specify the location of library files independent of the platform.

In order to create valid path names for the operating systems supported by MuPAD, the conventions holding for the corresponding operating system must be complied with. In particular, the names must not contain the characters `"/`, `"\"` or `":"`. Compliance with these conventions is tested by `pathname`.

Under Microsoft® Windows, `pathname` does not allow to specify a volume to become part of the path name. Names are always relative to the current volume.

Examples:

Call	Platform	Result
<code>pathname("lib", "linalg")</code>	UNIX (Linux/ Mac OS X)	<code>"lib/linalg/"</code>
	Microsoft Windows	<code>"lib\\linalg\\"</code>

Call	Platform	Result
pathname(Root, "lib", "linalg")	UNIX (Linux/Mac OS X)	"/lib/linalg/"
	Microsoft Windows	"\\lib\\linalg\\"

## Examples

### Example 1

The following examples are created on a UNIX/Linux system:

```
pathname("lib", "linalg")
```

```
"lib/linalg/"
```

```
pathname(Root, "lib", "linalg") . "det.mu"
```

```
"/lib/linalg/det.mu"
```

## Parameters

**dir, subdir, ...**

Names of directories: character strings on page 7-53

## Options

**Root**

Makes `pathname` generate an absolute path name

## Return Values

String.

## See Also

### **MuPAD Functions**

READPATH | WRITEPATH | fclose | finput | fopen | fprintf | fread | ftextinput |  
import::readbitmap | import::readdata | print | protocol | read | write



# pdivide

Pseudo-division of polynomials

## Syntax

```
pdivide(p, q, <[x]>, <order>, options)
```

```
pdivide(p, q, <[x1, x2, ...]>, <order>, options)
```

```
pdivide(p, q1, q2, ..., <[x1, x2, ...]>, <order>, options)
```

## Description

`pdivide(p, q)` performs pseudo-division of polynomials or polynomial expressions  $p$  and  $q$ . The function returns the factor  $b$ , the pseudo-quotient  $s$ , and the pseudo-remainder  $r$ , such that  $b*p = s*q + r$ .

`pdivide(p, q1, q2, q3, ..., qN)` performs pseudo-division of a polynomial or a polynomial expression  $p$  by polynomials or polynomial expressions  $q1, q2, q3, \dots, qN$ .

`pdivide(p, q)` returns the sequence  $b, s, r$ , where  $b$  is an element of the coefficient ring of the polynomials. The pseudo-quotient  $s$  and pseudo-remainder  $r$  satisfy these conditions:  $b*p = s*q + r$ ,  $\text{degree}(p) = \text{degree}(s) + \text{degree}(q)$ , and  $\text{degree}(r) < \text{degree}(q)$ .

By default, `pdivide` determines the factor  $b$  as  $b = \text{lcoeff}(q)^{(\text{degree}(p) - \text{degree}(q) + 1)}$ . `AnyFactor` enables `pdivide` to use other values of  $b$ . See “Example 2” on page 1-1529 (Symbolic Math Toolbox).

`pdivide` operates on polynomials (Symbolic Math Toolbox) or polynomial expressions (Symbolic Math Toolbox).

Polynomials must be of the same type, meaning that their variables and coefficient rings must be identical.

When you call `pdivide` for polynomial expressions, MuPAD internally converts these expressions to polynomials. See the `poly` function. If the expressions cannot be converted

to polynomials, `pdivide` returns `FAIL`. See “Example 3” on page 1-1530 (Symbolic Math Toolbox).

If you call `pdivide` for polynomials, it returns polynomials. If you call `pdivide` for polynomial expressions, it returns polynomial expressions.

If you perform pseudo-division of polynomial expressions that contain multiple variables, you can specify particular variables to be treated as variables. The `pdivide` function treats all other variables as symbolic parameters. By default, `pdivide` assumes that all variables in polynomial expressions are variables, and none of them is a symbolic parameter. See “Example 4” on page 1-1530 (Symbolic Math Toolbox).

`pdivide(p, q1, q2, q3, ..., qN)` returns the factor `b`, pseudo-quotients `s1`, `s2`, ..., `sN` and the pseudo-remainder `r`, such that  $b*p = s1*q1 + s2*q2 + \dots + sN*qN + r$ .

When performing pseudo-division of a polynomial by one or more polynomials, you can select the term ordering. The ordering accepts these values:

- `LexOrder` sets the lexicographical ordering.
- `DegreeOrder` sets the total degree ordering. When using this ordering, MuPAD sorts the terms of a polynomial according to the total degree of each term (the sum of the exponents of the variables).
- `DegInvLexOrder` sets the total degree inverse lexicographic ordering. When using this ordering, MuPAD sorts the terms of a polynomial according to the total degree of each term (the sum of the exponents of the variables). If several terms have equal total degrees, MuPAD sorts them using the inverse lexicographic ordering.
- Your custom term ordering of type `Dom::MonomOrdering`.

See “Example 5” on page 1-1531 (Symbolic Math Toolbox).

In contrast to `divide`, `pdivide` does not require that the coefficient ring of the polynomials implements a “`_divide`” slot on page 1-1980 because coefficients are not divided in this algorithm. See “Example 6” on page 1-1532 (Symbolic Math Toolbox).

## Examples

### Example 1

Perform pseudo-division of these two polynomials:

```
p := poly(x^3 + x + 1); q := poly(3*x^2 + x + 1);
[b, s, r] := [pdivide(p, q)]
```

```
[9, poly(3 x - 1, [x]), poly(7 x + 10, [x])]
```

The result satisfies this equation:

```
p*b = s*q + r
```

```
poly(9 x^3 + 9 x + 9, [x]) = poly(9 x^3 + 9 x + 9, [x])
```

Now compute the pseudo-quotient and pseudo-remainder separately:

```
pdivide(p, q, Quo), pdivide(p, q, Rem)
```

```
poly(3 x - 1, [x]), poly(7 x + 10, [x])
```

```
delete p, q, b, s, r;
```

### Example 2

By default, pdivide performs pseudo-division of p by q with the factor b determined by the formula  $b = \text{lcoeff}(q)^{(\text{degree}(p) - \text{degree}(q) + 1)}$ :

```
p := 4*x^2 + 3; q := 2*x + 2;
b = lcoeff(q)^(degree(p) - degree(q) + 1);
pdivide(p, q)
```

```
b = 4
```

```
4, 8 x - 8, 28
```

To enable `pdivide` to alter the value of `b`, use `AnyFactor`:

```
pdivide(4*x^2 + 3, 2*x + 2, AnyFactor)
```

```
1, 2 x - 2, 7
```

### Example 3

If an expression cannot be converted to a polynomial, `pdivide` returns `FAIL`:

```
pdivide(1/x, x)
```

```
FAIL
```

### Example 4

When performing pseudo-division of multivariate polynomials, you can specify the list of variables. The `pdivide` function assumes all other variables are symbolic parameters. For example, divide the following two polynomial expressions specifying that `x`, `y`, and `a` are variables. The resulting pseudo-quotient is 0, and the pseudo-remainder equals the dividend `p`:

```
p := x^3 + x + y;  
q := a*x^2 + x + 1;  
pdivide(p, q, [x, y, a])
```

```
1, 0, x^3 + x + y
```

Divide these expressions specifying that `x` and `y` are variables. MuPAD assumes that `a` is a symbolic parameter. Here, both the pseudo-quotient and pseudo-remainder are not equal to 0:

```
pdivide(p, q, [x, y])
```

```
a^2, a x - 1, a^2 y + x (a^2 - a + 1) + 1
```

Now divide the same polynomial expressions specifying that only  $y$  is a variable. MuPAD assumes that  $x$  and  $a$  are symbolic parameters. Here the pseudo-remainder is 0:

```
pdivide(p, q, [y])
```

$$(ax^2 + x + 1)^2, y(ax^2 + x + 1) + (x^3 + x)(ax^2 + x + 1), 0$$

By default, the `pdivide` function treats polynomial expressions with multiple variables as multivariate polynomial expressions. The function does not assume that any of the variables are symbolic parameters:

```
pdivide(x^3 + x + y, a*x^2 + x + 1)
```

$$1, 0, x^3 + x + y$$

## Example 5

`pdivide` lets you perform pseudo-division of a polynomial (or polynomial expression) by multiple polynomials (or polynomial expressions):

```
p := 4*x^4 + a*x^2*y^4:
q1 := x^3 - a:
q2 := x + y:
[b, s1, s2, r] := [pdivide(p, q1, q2)]
```

$$[-1, x^2 y^4, -x^4 y^4 + x^3 y^5 - 4x^3 - x^2 y^6 + 4x^2 y + x y^7 - 4x y^2 - y^8 + 4y^3, y^9 - 4y^4]$$

The result satisfies the condition  $b \cdot p = s1 \cdot q1 + s2 \cdot q2 + r$ :

```
testeq(b*p, s1*q1 + s2*q2 + r)
```

TRUE

When dividing a polynomial by multiple polynomials, you can select the term ordering:

```
pdivide(p, q1, q2, LexOrder)
```

$$-1, x^2 y^4, -x^4 y^4 + x^3 y^5 - 4x^3 - x^2 y^6 + 4x^2 y + x y^7 - 4x y^2 - y^8 + 4y^3, y^9 - 4y^4$$

```
pdivide(p, q1, q2, DegreeOrder)
```

```
1, 4 x, -a y5 + a x y4 + 4 a, a y6 - 4 a y
```

## Example 6

The coefficient ring can be an arbitrary ring. For example, here the residue class ring of integers modulo 8 represents the coefficient ring:

```
pdivide(poly(x3 + x + 1, IntMod(8)),  
        poly(4*x3 + x + 1, IntMod(8)))
```

```
4, poly(1, [x], IntMod(8)), poly(3 x + 3, [x], IntMod(8))
```

Note that `pdivide` does not require divisibility of the coefficients.

## Parameters

### **p, q**

Univariate or multivariate polynomials (Symbolic Math Toolbox) or polynomial expressions (Symbolic Math Toolbox).

### **p, q1, q2, ...**

Univariate or multivariate polynomials (Symbolic Math Toolbox) or polynomial expressions (Symbolic Math Toolbox).

### **x**

The indeterminate of the polynomial, which is typically an identifier on page 7-29 or an indexed identifier on page 1-1017. `pdivide` treats the expressions as univariate polynomials in the indeterminate `x`.

### **x1, x2, ...**

The indeterminates of the polynomial, which are typically identifiers on page 7-29 or indexed identifiers on page 1-1017. `pdivide` treats multivariate expressions as multivariate polynomials in these indeterminates.

**order**

The term ordering when performing pseudo-division of one multivariate polynomial by one or more multivariate polynomials: `LexOrder`, `DegreeOrder`, `DegInvLexOrder`, or a custom term ordering of type `Dom::MonomOrdering`. The default is the lexicographical ordering `LexOrder`.

## Options

**Quo, Rem**

Return only the pseudo-quotient or pseudo-remainder. By default, `pdivide` returns the sequence containing the factor `b`, pseudo-quotient `s` (or pseudo-quotients `s1`, `s2`, ...), and pseudo-remainder `r`. See “Example 1” on page 1-1529 (Symbolic Math Toolbox).

**AnyFactor**

Allow flexibility for the factor `b`. Without this option,  $b = \text{lcoeff}(q)^{(\text{degree}(p) - \text{degree}(q) + 1)}$ .

## Return Values

Polynomial, or polynomial expression, or a sequence containing an element of the coefficient ring of the input polynomials and polynomials (or polynomial expressions), or the value `FAIL`.

## Overloaded By

`f`, `g`, `p`, `q`

## See Also

**MuPAD Functions**

`content` | `degree` | `divide` | `factor` | `gcd` | `gcdex` | `ground` | `lcoeff` | `multcoeffs` | `poly`

# piecewise

Domain of conditionally defined objects

## Syntax

```
piecewise([cond1, value1], [cond2, value2], ..., <[Otherwise, valueN]>, <ExclusiveConditions>)
```

## Description

`piecewise([cond1, value1], [cond2, value2], ...)` defines a conditional object that equals `value1` if `cond1` is provably true, `value2` if `cond2` is provably true, and so on. Typically, such objects define piecewise functions or express solutions based on a case analysis of the free parameters of the mathematical problem. See “Example 1” on page 1-1536 (Symbolic Math Toolbox).

A pair `[condition, value]` is called a *branch*. If `condition` is provably false, then `piecewise` discards the entire branch. If `condition` is provably true, then `piecewise` returns the corresponding `value`. If neither condition in a `piecewise` object is provably true, `piecewise` returns an object of type `piecewise` that contains all branches, except for branches with provably false conditions.

If all conditions are provably false, or if you call `piecewise` without any branches, then `piecewise` returns `undefined`. See “Example 1” on page 1-1536 (Symbolic Math Toolbox).

Conditions do not need to be exhaustive or exclusive. If conditions contain parameters, and you substitute values for the parameters, all conditions can become false. Also, several conditions can become true.

If several conditions are simultaneously true, `piecewise` returns the value from the first branch that contains the condition recognized as true. Ensure that all values corresponding to the true conditions have the same mathematical meaning. Do not rely on the system to recognize the first mathematically true condition as true. Alternatively, you can use the `ExclusiveConditions` option to fix the order of the branches.

```
piecewise([cond1, value1], [cond2, value2], ..., [Otherwise, valueN])
```

 checks the conditions, and, if they are not satisfied, discards them and returns



valueN. The `Otherwise` condition occurs in the last branch. It can occur only once. It remains unchanged as long as there are other branches, but it is treated as true when all other branches are discarded because their conditions are false. See “Example 2” on page 1-1537 (Symbolic Math Toolbox).

The system checks the truth of the conditions for current values and properties of all involved identifiers each time it evaluates an object of type `piecewise`. Thus, it simplifies `piecewise` expressions under various different assumptions.

`piecewise` objects can be nested: both conditions and values can be `piecewise` objects themselves. `piecewise` automatically “flattens” (Symbolic Math Toolbox) such objects. For example, `piecewise([conditionA, piecewise([conditionB, valueC])])` becomes `piecewise([conditionA and conditionB, valueC])`. See “Example 3” on page 1-1537 (Symbolic Math Toolbox).

Arithmetical and set-theoretic operations work for `piecewise` objects, provided these operations are defined for all values contained in the branches. If `f` is such an operation and `p1`, `p2`, ... are `piecewise` objects, then `f(p1, p2, ...)` is the `piecewise` object consisting of all branches of the form `[cond1 and cond2 and ..., f(value1, value2, ...)]`, where `[cond1, value1]` is a branch of `p1`, `[cond2, value2]` is a branch of `p2`, and so on. In other words, applying `f` commutes with any assignment to free parameters in the conditions. See “Example 4” on page 1-1538 (Symbolic Math Toolbox).

`piecewise` objects can also be mixed with other objects in such operations. In such cases, if `p1` is not a `piecewise` object, the system treats it as a `piecewise` object with the only branch `[TRUE, p1]`. See “Example 5” on page 1-1538 (Symbolic Math Toolbox).

`diff`, `float`, `limit`, `int` and similar functions handle expressions involving `piecewise`. When you use a `piecewise` argument in unary operators and functions with one argument, the system maps the operator or function to the values in each branch. See “Example 6” on page 1-1538 (Symbolic Math Toolbox), “Example 7” on page 1-1539 (Symbolic Math Toolbox), and “Example 8” on page 1-1539 (Symbolic Math Toolbox).

`piecewise` differs from the `if` and `case` branching statements. First, `piecewise` uses the property (Symbolic Math Toolbox) mechanism when deciding the truth of the conditions. Therefore, the result depends on the properties of the identifiers on page 7-29 that appear in the conditions. Second, `piecewise` treats conditions mathematically, while `if` and `case` evaluate them syntactically. Third, `piecewise` internally sorts the branches. If conditions in several branches are true, `piecewise` can return any of these branches. See “Example 9” on page 1-1539 (Symbolic Math Toolbox).

The `ExclusiveConditions` option fixes the order of branches in a `piecewise` expression. If the condition in the first branch returns `TRUE`, then `piecewise` returns the value from the first branch. If a true condition appears in any further branch, then `piecewise` returns the value from that branch and removes all subsequent branches. Thus, `piecewise` with `ExclusiveConditions` is very similar to an `if-elif-end_if` statement. Nevertheless, `piecewise` with `ExclusiveConditions` still takes into account assumptions on identifiers and treats conditions mathematically while `if-elif-end_if` treats them syntactically. See “Example 10” on page 1-1540 (Symbolic Math Toolbox).

## Environment Interactions

`piecewise` takes into account properties of identifiers.

## Examples

### Example 1

Define this rectangular function `f`. Without additional information about the variable `x`, the system cannot evaluate the conditions to `TRUE` or `FALSE`. Therefore, it returns the `piecewise` object.

```
f := x -> piecewise([x < 0 or x > 1, 0], [x >= 0 and x <= 1, 1])
```

$$x \rightarrow \begin{cases} 0 & \text{if } x < 0 \vee 1 < x \\ 1 & \text{if } 0 \leq x \wedge x \leq 1 \end{cases}$$

Call the function `f` with the following arguments. Every time you call this `piecewise` function, the system checks the conditions in its branches and evaluates the function.

```
f(0), f(2), f(I)
```

```
1, 0, undefined
```

## Example 2

Create this piecewise function using the syntax that includes `Otherwise`:

```
pw:= piecewise([x > 0 and x < 1, 1], [Otherwise, 0])
```

$$\begin{cases} 1 & \text{if } x \in (0, 1) \\ 0 & \text{otherwise} \end{cases}$$

Evaluate `pw` for these three values:

```
pw | x = 1/2;
pw | x = 2;
pw | x = I;
```

1

0

0

For further computations, delete the identifier `pw`:

```
delete pw:
```

## Example 3

Create this nested piecewise expression. MuPAD flattens nested `piecewise` objects.

```
p1 := piecewise([a > 0, a^2], [a <= 0, -a^2]):
piecewise([b > 0, a + b], [b = 0, p1 + b], [b < 0, a + b])
```

$$\begin{cases} a^2 & \text{if } 0 < a \wedge b = 0 \\ -a^2 & \text{if } a \leq 0 \wedge b = 0 \\ a + b & \text{if } b \neq 0 \wedge b \in \mathbb{R} \end{cases}$$

### Example 4

Find the sum of these piecewise functions. You can perform most operations on piecewise functions the same way as you would on ordinary arithmetical expressions. The result of an arithmetical operation is only defined at the points where all of the arguments are defined:

```
piecewise([x > 0, 1], [x < -3, x^2]) + piecewise([x < 2, x])
```

$$\begin{cases} x^2 + x & \text{if } x < -3 \\ x + 1 & \text{if } x \in (0, 2) \end{cases}$$

### Example 5

Solve this equation. The solver returns the result as a piecewise set:

```
S := solve(a*x = 0, x)
```

$$\begin{cases} \mathbb{C} & \text{if } a = 0 \\ \{0\} & \text{if } a \neq 0 \end{cases}$$

You can use set-theoretic operations work for such sets. For example, find the intersection of this set and the interval (3, 5):

```
S intersect Dom::Interval(3, 5)
```

$$\begin{cases} (3, 5) & \text{if } a = 0 \\ \emptyset & \text{if } a \neq 0 \end{cases}$$

### Example 6

Many unary functions are overloaded for piecewise by mapping them to the objects in all branches of the input:

```
f := piecewise([x >= 0, arcsin(x)], [x < 0, arccos(x)]):  
sin(f)
```

$$\begin{cases} \sqrt{1-x^2} & \text{if } x < 0 \\ x & \text{if } 0 \leq x \end{cases}$$

### Example 7

Find the limit of this piecewise function:

```
limit(piecewise([a > 0, x],[a < 0 and x > 1, 1/x],
               [a < 0 and x <= 1, -x]), x = infinity)
```

$$\begin{cases} \infty & \text{if } 0 < a \\ 0 & \text{if } a < 0 \end{cases}$$

### Example 8

Find the integral of this piecewise function:

```
int(piecewise([x < 0, x^2], [x > 0, x^3]), x = -1..1)
```

$$\frac{7}{12}$$

### Example 9

Create this piecewise function. Here, `piecewise` cannot determine if any branch is true or false. To do that, `piecewise` needs additional information about the identifier `a`.

```
p1 := piecewise([a = 0, 0], [a <> 0, 1/a])
```

$$\begin{cases} 0 & \text{if } a = 0 \\ \frac{1}{a} & \text{if } a \neq 0 \end{cases}$$

Create a similar structure by using `if-then-else`. The `if-then-else` structure evaluates the conditions syntactically. Here, `a = 0` is technically false because the identifier `a` and the integer `0` are different objects.

```
p2 := (if a = 0 then 0 else 1/a end)
```

$$\frac{1}{a}$$

`piecewise` takes properties of identifiers into account:

```
p1 := piecewise([a + b = 0, 0], [otherwise, 1/a]) assuming a + b = 0
```

$$0$$

`if-then-else` does not:

```
p2 := (if a + b = 0 then 0 else 1/a end) assuming a + b = 0
```

$$\frac{1}{a}$$

For further computations, delete identifiers `a`, `b`, `p1`, and `p2`:

```
delete a, b, p1, p2:
```

## Example 10

Create this piecewise expression:

```
p := piecewise([x > 0, 1], [y > 0, 2])
```

$$\begin{cases} 1 & \text{if } 0 < x \\ 2 & \text{if } 0 < y \end{cases}$$

Evaluate the expression at `y = 1`:

```
p | y = 1
```

2

Now, create the piecewise expression with the same branches, but this time use `ExclusiveConditions` to fix the order of the branches. When you use this option, any branch can be true only if the previous branches are false.

```
pE := piecewise([x > 0, x], [y > 0, y], ExclusiveConditions)
```

$$\left\{ \begin{array}{ll} x & \text{if } 0 < x \\ y & \text{if } 0 < y \\ \text{ExclusiveConditions}_2 & \text{if } \text{ExclusiveConditions}_1 \end{array} \right.$$

Evaluate the expression at  $y = 1$ :

```
pE | y = 1
```

$$\left\{ \begin{array}{ll} x & \text{if } 0 < x \\ 1 & \text{if TRUE} \\ \text{ExclusiveConditions}_2 & \text{if } \text{ExclusiveConditions}_1 \end{array} \right.$$

When you use `ExclusiveConditions`, `piecewise` acts the same way as an if-then-else statement, but does not ignore properties of identifiers. For example, set the assumption that  $x = 0$ :

```
assume(x = 0)
```

The `piecewise` function call returns 0 because it uses the assumption on identifier  $x$ :

```
p := piecewise([x = 0, x], [Otherwise, 1/x^2])
```

$x$

The corresponding if-then-else statement ignores the assumption, and, therefore, returns  $1/x^2$ :

```
pIf := (if x = 0 then x else 1/x^2 end)
```

$$\frac{1}{x^2}$$

For further computations, delete identifiers `p`, `pE`, `x`, and `pIf`:

`delete p, pE, x, pIf:`

### Example 11

Find a set of accumulation points of this piecewise function by calling `limit` with the `Intervals` option:

```
limit(piecewise([a > 0, sin(x)], [a < 0 and x > 1, 1/x],
               [a < 0 and x <= 1, -x]), x = infinity, Intervals)
```

$$\begin{cases} [-1, 1] & \text{if } 0 < a \\ \{0\} & \text{if } a < 0 \\ \emptyset & \text{if } a = 0 \vee a \notin \mathbb{R} \end{cases}$$

### Example 12

Rewrite the `sign` function in terms of a `piecewise` object:

```
f := rewrite(sign(x), piecewise)
```

$$\begin{cases} 0 & \text{if } x = 0 \\ 1 & \text{if } 0 < x \\ -1 & \text{if } x < 0 \\ \frac{x}{\sqrt{\Im(x)^2 + \Re(x)^2}} & \text{if } x \notin \mathbb{R} \end{cases}$$

### Example 13

Create this `piecewise` object:



```
f := piecewise([x > 0, 1], [x < -3, x^2])
```

$$\begin{cases} 1 & \text{if } 0 < x \\ x^2 & \text{if } x < -3 \end{cases}$$

Extract a particular condition or object:

```
piecewise::condition(f, 1), piecewise::expression(f, 2)
```

$$0 < x, x^2$$

The index operator has the same meaning as `piecewise::expression` and can be typed faster:

```
f[2]
```

$$x^2$$

The `piecewise::branch` function extracts whole branches:

```
piecewise::branch(f, 1)
```

$$[0 < x, 1]$$

You can form another `piecewise` object from the branches for which the condition satisfies a given selection criterion, or split the input into two `piecewise` objects, as the system functions `select` and `split` do it for lists:

```
piecewise::selectConditions(f, has, 0)
```

$$\{1 \text{ if } 0 < x\}$$

```
piecewise::splitConditions(f, has, 0)
```

$$[\{1 \text{ if } 0 < x, \{x^2 \text{ if } x < -3, \text{undefined}\}]$$

You can also create a copy of `f` with some branches added or removed:

```
piecewise::remove(f, 1)
```

$$\{ x^2 \text{ if } x < -3$$

```
piecewise::insert(f, [x > -3 and x < 0, sin(x)])
```

$$\left\{ \begin{array}{ll} 1 & \text{if } 0 < x \\ x^2 & \text{if } x < -3 \\ \sin(x) & \text{if } x \in (-3, 0) \end{array} \right.$$

## Parameters

**cond1, cond2, ...**

Boolean constants on page 1-2180, or expressions on page 7-20 representing logical formulas

**object1, object2, ...**

Arbitrary objects

**Otherwise**

Identifier that specifies the last condition. This condition is always treated as a true condition.

## Options

**ExclusiveConditions**

The `ExclusiveConditions` option fixes the order of branches in a piecewise expression. This option causes `piecewise` to automatically remove branches with false conditions. Thus, `piecewise` with `ExclusiveConditions` is almost equivalent to an

`if-elif-end_if` statement, except that `piecewise` takes into account assumptions on identifiers. For example, if the condition in the first branch returns `TRUE`, then `piecewise` returns the expression from the first branch. If a true condition appears in any further branch, then `piecewise` returns the expression from that branch and removes all subsequent branches.

## Methods

### Mathematical Methods

**`_in` – Membership with `piecewise` on the left side**

`_in(p, S)`

**`contains` – Apply the function `contains` to the objects in all branches**

`contains(p, a)`

This method overloads the function `contains`. The values in all branches must be valid first arguments for `contains`.

**`diff` – (partial) differentiation**

`diff(p, <x, ...>)`

If no variables are given, `p` is returned.

**`discont` – Determine the discontinuities of a piecewise function**

`discont(p, x, <F>)`

`discont(p, x = a .. b, <F>)`

The values in all branches of `p` must be arithmetical expressions (Symbolic Math Toolbox).

The optional third parameter has the same meaning as for the function `discont`.

As for the function `discont`, only discontinuities in the given interval `[a, b]` are returned when calling `piecewise(p, x = a..b)`.

**disregardPoints — Heuristic for simplifying conditions**

disregardPoints(p)

**expand — Apply the function expand to the objects in all branches**

expand(p)

**factor — Apply the function factor to the objects in all branches**

factor(p)

**getElement — Get any element of a piecewise set**

getElement(p)

The result is FAIL if no such common element is found.

This method overloads the function `solveLib::getElement`.

**has — Test for the existence of a subobject**

has(p, a)

**int — Definite and indefinite integration of a piecewise function**

int(p, x, <r>)

If a range  $a..b$  is given, this method computes the definite integral of  $p$  when  $x$  runs through that range.

**ilaplace — Apply the function ilaplace to the objects in all branches**

ilaplace(p, x, t)

**isFinite — Test whether a piecewise set is finite**

isFinite(p)

This method overloads `solveLib::isFinite`.

**laplace — Apply the function laplace to the objects in all branches**

laplace(p, x, t)

**limit — Compute the limit of a piecewise function**

```
limit(p, x, <Left | Right | Real>, <Intervals>, <NoWarning>)
```

```
limit(p, x = x0, <Left | Right | Real>, <Intervals>, <NoWarning>)
```

When called with the `Intervals` option, the method returns the set of accumulation points of a function.

If the method cannot find the function limit and cannot prove the limit does not exist, the function call returns an unevaluated `limit` function.

If the limit of a function does not exist, the method returns the special value `undefined`.

This method overloads the function `limit`.

**normal — Apply the function normal to the objects in all branches**

```
normal(p)
```

**partfrac — Apply the function partfrac to the objects in all branches**

```
partfrac(p)
```

**restrict — Impose an additional condition**

```
restrict(p, C)
```

**set2expr — Membership with piecewise on the right side**

```
set2expr(p, x)
```

The objects in all branches of `p` must represent sets.

This method overloads the system function `_in`.

**simplify — Simplify a conditionally defined object**

```
simplify(p)
```

**solve — Solve a conditionally defined equation or inequality**

```
solve(p, x, <option1, option2, ...>)
```

For each branch [condition, value] of `p`, with `value` being an equation or inequality, the method determines the set of all values `x` such that both `condition` and `value` become true mathematically, and returns the union of all obtained sets. The return value can be a conditionally defined set.

This method overloads the function `solve`. See the corresponding help page for a description of the available options and an overview of the types of sets that can be returned.

### **solveConditions — Isolate a given identifier in all conditions**

`solveConditions(p, x)`

### **Union — Union of a system of sets**

`Union(p, x, indexset)`

The values in all branches of `p` must represent sets.

For each branch [condition, value] of `p`, this method does the following. It substitutes for `x` in `value` all values from `indexset` satisfying `condition` and takes the union over all obtained sets. Then it returns the union over the resulting sets for all branches.

This method overloads the function `solveLib::Union`.

## **Access Methods**

### **\_concat — Merge piecewise objects**

`_concat(p, ...)`

### **branch — Nth branch**

`branch(p, n)`

### **op — Branches**

`op(p)`

`op(p, n)`

`op(p, n)` returns the  $n$ th branch of `p` as a list. If  $n = 0$ , then `piecewise` is returned.

**setBranch — Replace the  $i$ th branch**

`setBranch(p, i, b)`

**numberOfBranches — Number of branches**

`numberOfBranches(p)`

**condition — Condition in a specific branch**

`condition(p, i)`

**setCondition — Replace the condition in a specific branch by another**

`setCondition(p, i, cond)`

**expression — Object in a specific branch**

`expression(p, i)`

Instead of `piecewise::expression(p, i)`, the index operator `p[i]` can be used synonymously.

**\_index — Object in a specific branch**

`_index(p, i)`

`piecewise::expression` can be used synonymously.

**setExpression — Replace the object in a specific branch by another**

`setExpression(p, i, a)`

**insert — Insert a branch**

`insert(p, b)`

`b` can either be a branch extracted from another conditionally defined object using `extop`, or a list `[condition, object]`.

See “Example 13” on page 1-1542 (Symbolic Math Toolbox).

**extmap — Apply a function to the objects in all branches**

extmap(p, f, <a, ...>)

**mapConditions — Apply a function to the conditions in all branches**

mapConditions(p, f, <a, ...>)

**map — Apply the function map to the objects in all branches**

map(p, f, <a, ...>)

map(p, f) is equivalent to `piecewise::extmap(p, map, f)`.

**remove — Remove a branch**

remove(p, i)

**splitBranch — Split a branch into two branches**

splitBranch(p, i, newcondition)

**selectConditions — Select branches depending on their condition**

selectConditions(p, f, <a, ...>)

For every condition in p, `f(condition a, ...)` must return a Boolean on page 1-2180 constant on page 1-2180.

If none of the conditions satisfies the selection criterion, `undefined` is returned.

**selectExpressions — Select branches depending on their value**

selectExpressions(p, f, <a, ...>)

For every value in p, `f(value a, ...)` must return a Boolean on page 1-2180 constant on page 1-2180.

If none of the objects satisfies the selection criterion, `undefined` is returned.

**splitConditions — Split branches depending on conditions**

splitConditions(p, f, <a, ...>)



For every condition in `p`, `f(condition a, ...)` must return a Boolean on page 1-2180 constant on page 1-2180.

See “Example 13” on page 1-1542 (Symbolic Math Toolbox).

### **subs — Substitution**

`subs(p, s, ...)`

This method overloads the function `subs`. The calling syntax is identical to that function. See the corresponding help page for a description of the various types that are allowed for `s`.

### **zip — Apply a binary operation pointwise**

`zip(p1, p2, f)`

If we regard conditionally defined objects as functions from the set  $A$  of parameter values to a set  $B$  of objects, this method implements the canonical extension of the binary operation  $f$  on  $B$  to the binary operation  $g$  on the set  $B^A$  of all functions from  $A$  to  $B$  via  $g(p1, p2)(a) = f(p1(a), p2(a))$  for all  $a$  in  $A$ .

If only one of the first two arguments—`p1`, say—is of type `piecewise`, then each branch `[condition, value]` of `p1` is replaced by `[condition, f(value, p2)]`.

If neither `p1` nor `p2` are of type `piecewise`, then `piecewise::zip(p1, p2, f)` returns `f(p1, p2)`.

## **Algorithms**

The operands of a `piecewise` object (the branches) are pairs consisting of a condition and the value valid under that condition.

Methods overloading system functions always assume that they have been called via overloading, and that there is some conditionally defined object among their arguments. All other methods do not assume that one of their arguments is of type `piecewise`. This simplifies the use of `piecewise`: it is always allowed to enter `p:=piecewise(...)` and to call some method of `piecewise` with `p` as an argument. You do not need to care about the special case where `p` is not of type `piecewise` because some condition in its definition is true or all conditions are false.

## See Also

### MuPAD Functions

assume | bool | case | if | is

# plot

Display graphical objects on the screen

## Syntax

```
plot(object1, <object2, ...>, <attribute1, attribute2, ...>)
```

## Description

`plot(object1, object2, ...)` displays the graphical objects `object1`, `object2` etc. on the screen.

`plot()` creates an empty graphical 2D scene.

`display` and `plot` are equivalent.

This function calls `plot::easy` for preprocessing its input.

The parameters `object1`, `object2` and so on, must be accepted by `plot::easy` or directly be graphical objects generated by routines of the plot library. This library provides many such objects including:

- function graphs (`plot::Function2d`, `plot::Function3d`),
- curves (`plot::Curve2d`, `plot::Curve3d`),
- points (`plot::Point2d`, `plot::Point3d`),
- lines (`plot::Line2d`, `plot::Line3d`),
- polygons (`plot::Polygon2d`, `plot::Polygon3d`),
- surfaces (of domain type `plot::Surface`)

and many more. See “Example 1” on page 1-1554 (Symbolic Math Toolbox).

There are also many high level objects, such as `plot::VectorField2d`, `plot::Ode2d`, `plot::Ode3d`, `plot::Implicit2d`, `plot::Implicit3d`, that can also be rendered by `plot`. See “Example 2” on page 1-1556 (Symbolic Math Toolbox).

Graphical attributes `attribute1`, `attribute2`, and so on, are specified by equations of the form `AttributeName = AttributeValue`. There are several hundred such attributes that allow to modify almost any aspect of the graphics.

---

**Note** The graphical objects `object1`, `object2`, and so on, must have the same dimension. A mix of 2D and 3D objects in one plot is not supported.

---

## Examples

### Example 1

Use the following calls to return objects representing the graphs of the sine and the cosine function on the interval  $[0, 2\pi]$ :

```
f1 := plot::Function2d(sin(x), x = 0..2*PI, Color = RGB::Red);  
f2 := plot::Function2d(cos(x), x = 0..2*PI, Color = RGB::Blue)
```

```
plot::Function2d(sin(x), x = 0..2 π)
```

```
plot::Function2d(cos(x), x = 0..2 π)
```

The following call renders these graphs:

```
plot(f1, f2)
```

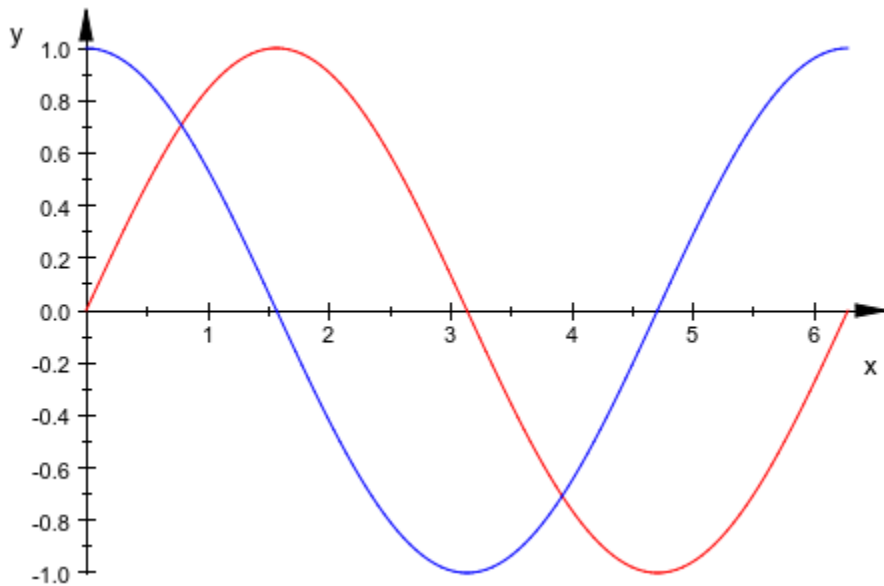

Apart from the explicitly requested colors, this call uses the default values of all graphical attributes. If different values are desired, an arbitrary number of attributes can be passed as additional parameters to `plot`. For example, to draw grid lines in the background of the previous plot, use:

```
plot(f1, f2, GridVisible = TRUE)
```

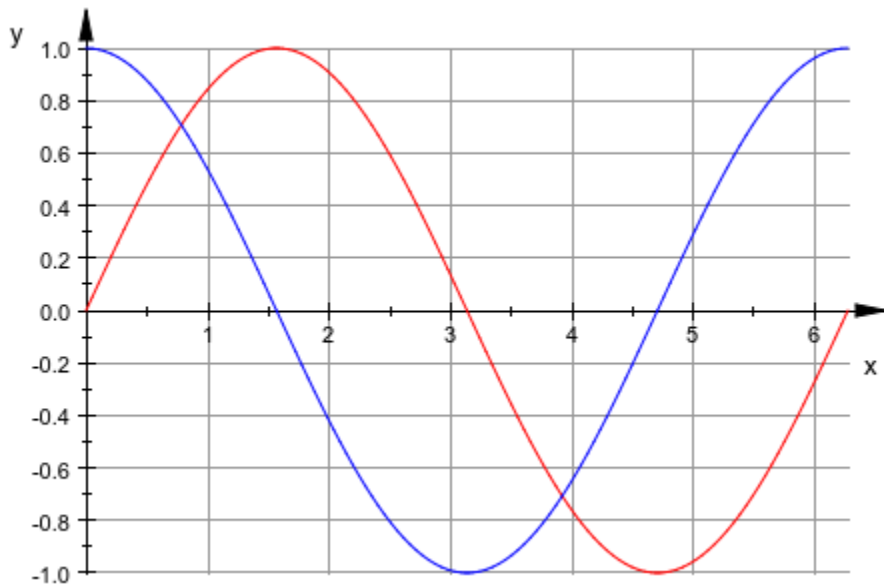

```
delete f1, f2:
```

## Example 2

The plot library contains various routines for creating more complex graphical objects, such as vectorfields on page 24-1003, solution curves of ordinary differential equations on page 24-511, and implicitly defined curves on page 24-372.

For example, to plot the implicitly defined curve  $x^2 + x + 2 = y^2$  with  $x, y$  from the interval  $[-5, 5]$ , use the function `plot::Implicit2d`:

```
plot(plot::Implicit2d(x^3 + x + 2 = y^2,  
                    x = -5..5, y = -5..5),  
      Scaling = Constrained)
```

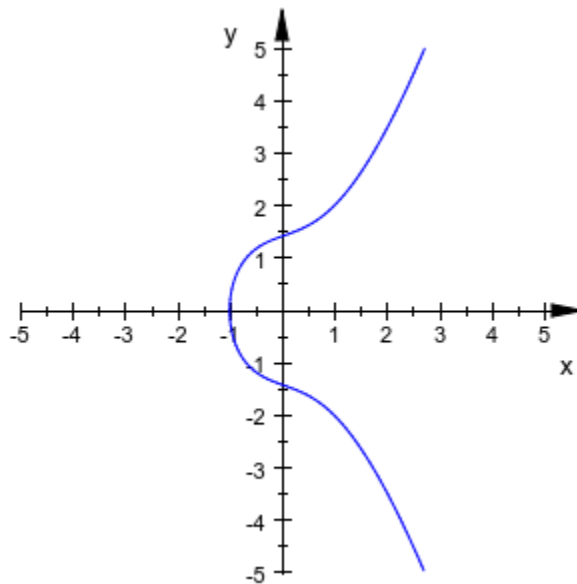

Here the `Scaling` attribute guarantees an aspect ratio 1:1 between the x and y coordinates independent of the window size.

## Parameters

`object1`, `object2`, ...

2D or 3D graphical objects of the plot library or expressions acceptable by `plot::easy`

`attribute1`, `attribute2`, ...

Graphical attributes of the form `AttributeName = AttributeValue`

## Overloaded By

`object_1`

## Algorithms

Technically, `plot` is not a function but a domain representing the library plot library. Thus, when calling `plot(...)`, the method `plot` is called.

## See Also

### MuPAD Functions

`display` | `plot::easy` | `plotfunc2d` | `plotfunc3d`

## Topics

“Use Graphics” (Symbolic Math Toolbox)



# display

Display graphical objects on screen

## Syntax

```
display(object1, <object2, ...>, <attribute1, attribute2, ...>)
```

## Description

`display(object1, object2, ...)` displays the graphical objects `object1`, `object2`,... on the screen.

`display(object1, object2, ...)` is equivalent to `plot(object1, object2, ...)`. For details and examples, see `plot`.

## Parameters

**object<sub>1</sub>, object<sub>2</sub>, ...**

2D or 3D graphical objects of the `plot` library or expressions accepted by `plot::easy`

**attribute<sub>1</sub>, attribute<sub>2</sub>, ...**

Graphical attributes of the form `AttributeName = AttributeValue`

## Overloaded By

`object_1`

## See Also

### MuPAD Functions

`plot` | `plot::easy` | `plotfunc2d` | `plotfunc3d`

### Topics

“Use Graphics” (Symbolic Math Toolbox)

# plotfunc2d

Function plots in 2D

## Syntax

```
plotfunc2d(f1, f2, ..., <Colors = [c1, c2, ...]>, <attributes>)
```

```
plotfunc2d(f1, f2, ..., x = xmin .. xmax, <Colors = [c1, c2, ...]>, <attributes>)
```

```
plotfunc2d(f1, f2, ..., x = xmin .. xmax, a = amin .. amax, <Colors = [c1, c2, ...]>, <attributes>)
```

## Description

`plotfunc2d(f1, f2, ...)` generates a 2D plot of the univariate functions `f1`, `f2` etc.

We strongly recommend reading the introduction to `plotfunc2d` in Section 2.1 (“2D Function Graphs”) (Symbolic Math Toolbox) of the plot document.

The functions to be plotted must not contain any symbolic parameters apart from the variable `x` and the animation parameter `a`. Exact numerical values such as `PI`, `sqrt(2)` etc. are accepted.

Animations are triggered by specifying a range `a = amin .. amax` for a parameter `a` that is different from the independent variable `x`. Thus, in animations, both the `x`-range `x = xmin .. xmax` as well as the animation range `a = amin .. amax` must be specified. See “Example 2” on page 1-1565 (Symbolic Math Toolbox).

Non-real function values are ignored. See “Example 3” on page 1-1566 (Symbolic Math Toolbox).

Functions with singularities are handled. See “Example 4” on page 1-1567 (Symbolic Math Toolbox) and “Example 5” on page 1-1571 (Symbolic Math Toolbox). If unbounded functions are plotted, the vertical viewing range is clipped, automatically. An explicit vertical viewing range `ymin .. ymax` may be requested via `ViewingBoxYRange = `y_{min}` .. `y_{max}`` or `YRange = `y_{min}` .. `y_{max}``.

Discontinuities and piecewise defined on page 1-1275 (Symbolic Math Toolbox) functions are handled. See “Example 6” on page 1-1572 (Symbolic Math Toolbox) and “Example 7” on page 1-1573 (Symbolic Math Toolbox).

The `plot` library provides the routine `plot::Function2d` which allows to create a function graph as a graphical primitive, and to combine it with other graphical objects.

A variety of graphical attributes can be specified for fine tuning the graphical output. Such attributes are passed as equations `AttributeName = AttributeValue` to the `plotfunc2d` command.

Section 2.3 (“Attributes for `plotfunc2d` and `plotfunc3d`”) (Symbolic Math Toolbox) provides an overview of the available attributes.

In particular, all attributes accepted by the graphical primitive `plot::Function2d` for function graphs are accepted by `plotfunc2d`. These attributes allow to specify the mesh for the numerical evaluation, the line width etc. The help page of `plot::Function2d` on page 24-295 provides a concise list.

Further, all attributes accepted by `plot::CoordinateSystem2d` are accepted by `plotfunc2d`. These attributes include the specification of a viewing box, of the axes, their tick marks and tick labels, the coordinate type (such as linear versus logarithmic plots), grid lines etc. The help page of `plot::CoordinateSystem2d` on page 24-1058 provides a concise list.

Further, all attributes accepted by `plot::Scene2d` are accepted by `plotfunc2d`. These attributes include the specification of the layout of the graphical scene, the background color etc. The help page of `plot::Scene2d` on page 24-1084 provides a concise list.

Further, all attributes accepted by `plot::Canvas` are accepted by `plotfunc2d`. These attributes include the specification of the size of the graphics, of further layout parameters etc. The help page of `plot::Canvas` on page 24-1053 provides a concise list.

A graphical attribute such as `Mesh = 500` (setting the number of mesh points for the numerical evaluation to 500) is applied to *all* functions in the call `plotfunc2d(f1, f2, ...)`. If separate attributes are appropriate, use the equivalent call

```
plot(plot::Function2d(f1, attr1), plot::Function2d(f2, attr2), ...),
```

in which the attributes `attr1`, `attr2` etc. can be set separately for each function.

Apart from few exceptions, `plotfunc2d` uses the standard default values for the graphical attributes (see the help page of `plot::Function2d`). The exceptions are:

- If more than one function is plotted, `plotfunc2d` automatically creates a legend. Use an explicit `LegendVisible = FALSE` to suppress the legend.
- `AdaptiveMesh` is set to 2, i.e., `plotfunc2d` uses adaptive function evaluation unless `AdaptiveMesh = 0` is requested in `plotfunc2d`.
- If a parameter range such as `x = `x_{min}` .. `x_{max}`` is passed to `plotfunc2d`, the name `x` is used as the title for the horizontal axis. Pass the attribute `XAxisTitle` if a different label for the horizontal axis is desired.

## Environment Interactions

The function is sensitive to the environment variable `DIGITS` which determines the numerical working precision. Make sure that `DIGITS` is set to a sufficiently small value (such as the default value 10) to avoid the costs of computing unnecessarily precise plot data.

## Examples

### Example 1

The following command draws the sine function and the cosine function on the interval  $[-\pi, \pi]$ :

```
plotfunc2d(sin(x), cos(x), x = -PI .. PI):
```

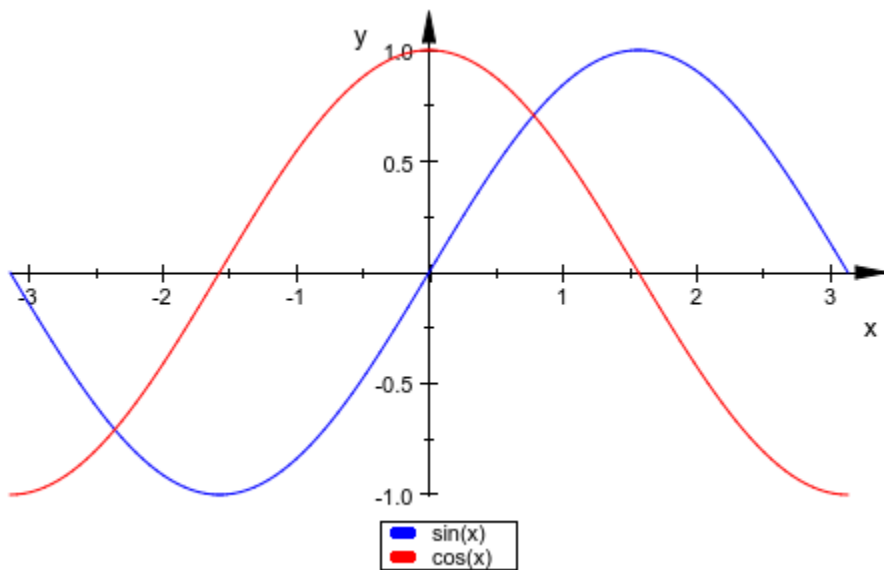

With the attribute `Scaling = Constrained`, the y-axis has the same scale as the x-axis:

```
plotfunc2d(sin(x), cos(x), x = -PI .. PI, Scaling = Constrained):
```

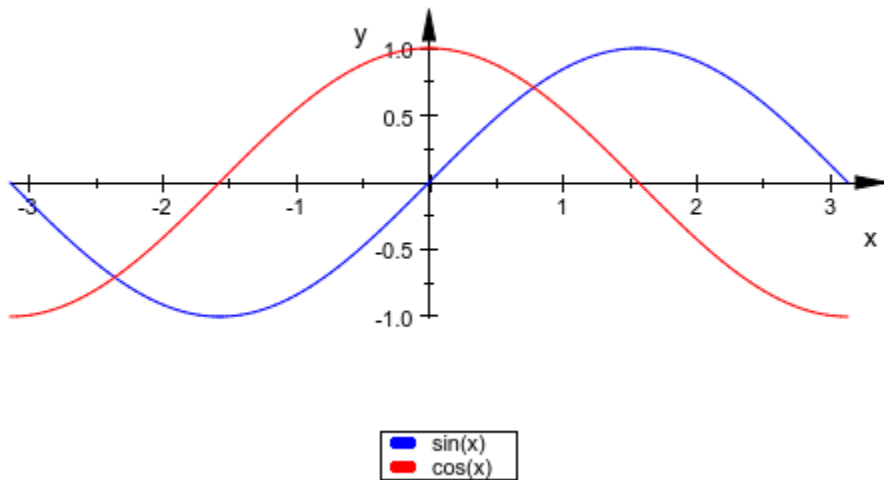

## Example 2

When creating an animation, a range for the independent variable  $x$  must be specified. An additional second range triggers the animation:

```
plotfunc2d(sin(x - a), cos(x + 2*a),  
           x = -PI .. PI, a = -PI .. PI)
```

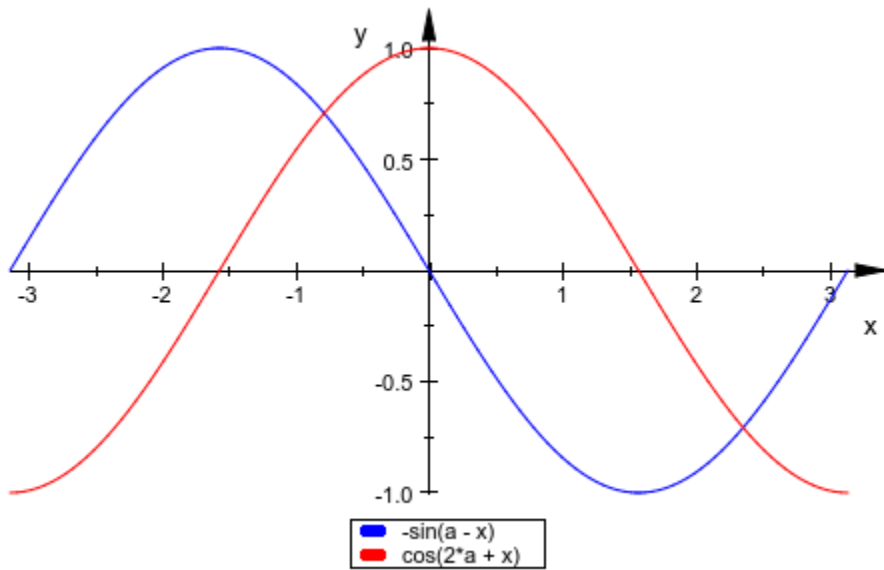

### Example 3

Only real function values are plotted:

```
plotfunc2d(sqrt(1 - x), sqrt(x), x = -2 .. 2):
```



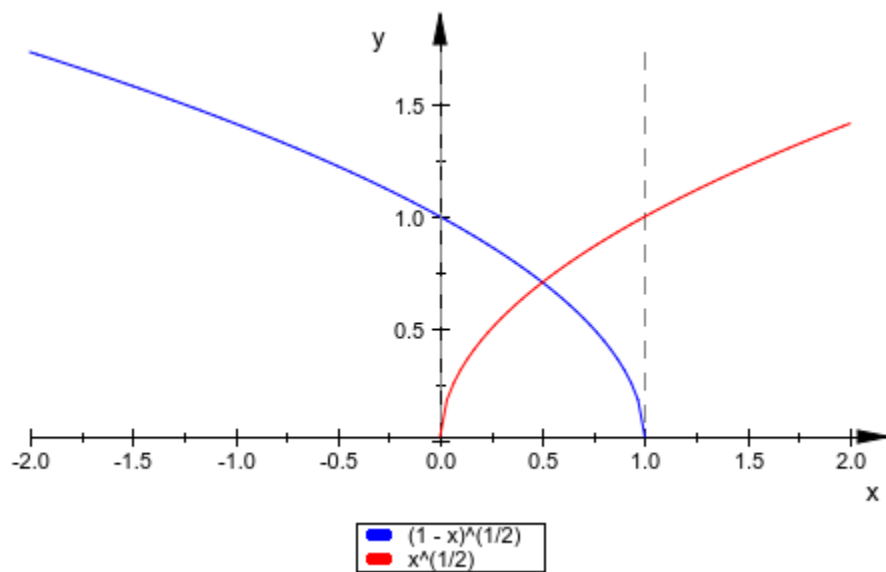

### Example 4

The following functions have singularities in the specified interval:

`plotfunc2d(x/(x^3 - 4*x), x = -5 .. 5):`

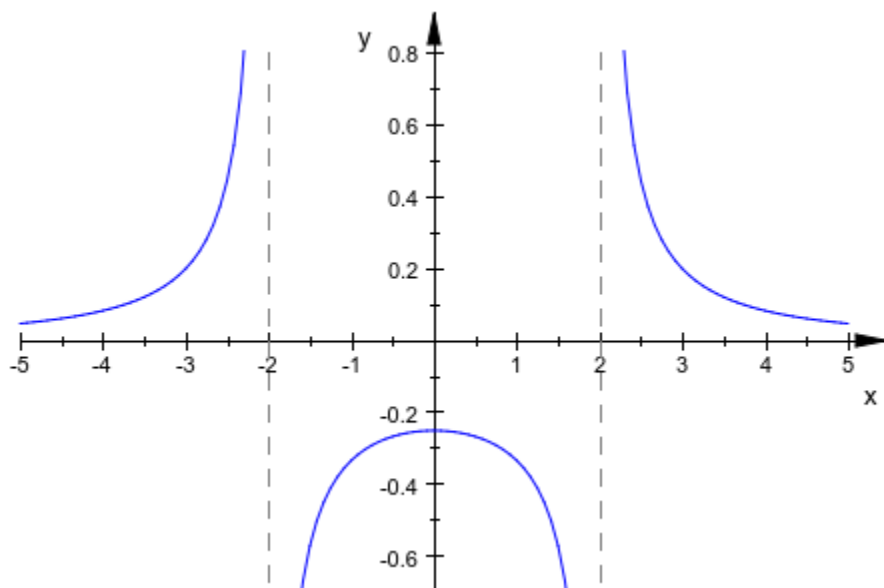

`plotfunc2d(1/sin(x), tan(x), x = 0 .. 2*PI):`

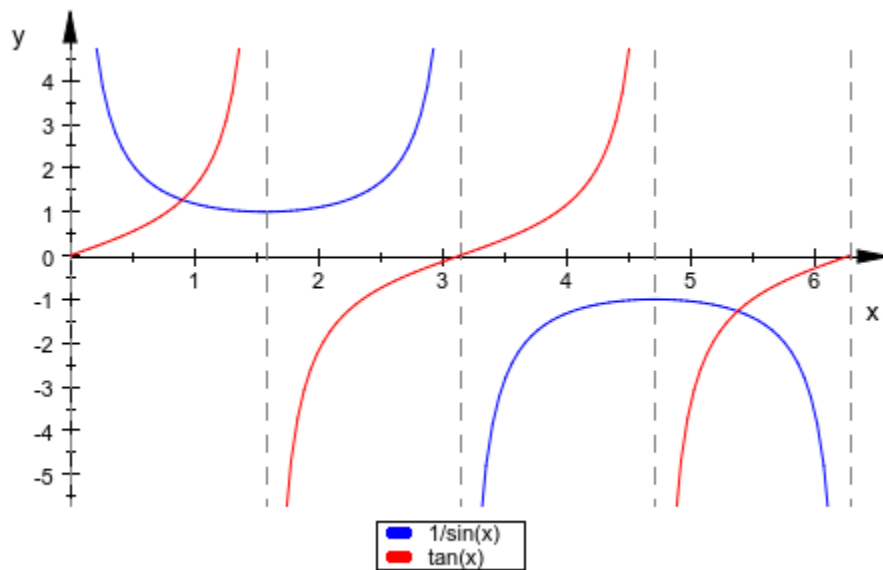

Note that the automatic clipping may in some cases lead to an incorrect impression, such as the following image where the function appears to converge to about - 4.6 (but actually goes to  $-\infty$  for small absolute values of  $x$ ):

```
plotfunc2d(ln(abs(x)))
```

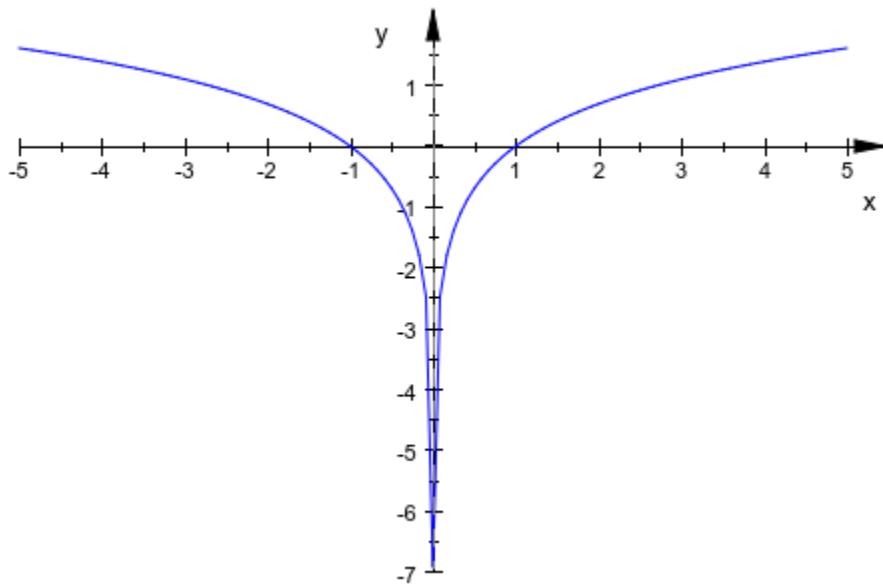

In this case, the asymptote which points to the pole is not seen because of the axis:

```
plotfunc2d(ln(abs(x)), Axes=Boxed)
```

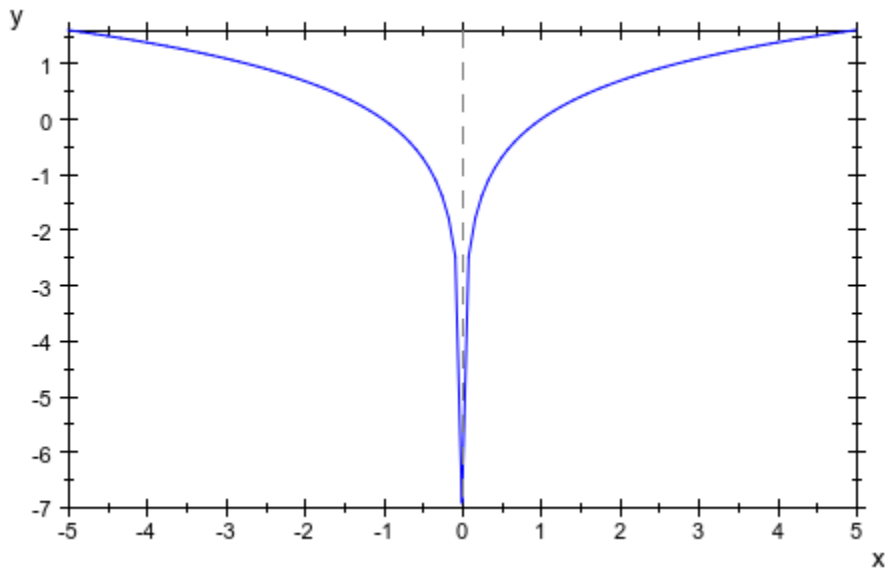

### Example 5

We specify a vertical range to which the function graph is restricted:

```
plotfunc2d(tan(x), x = -3 .. 3, YRange = -10 .. 10):
```

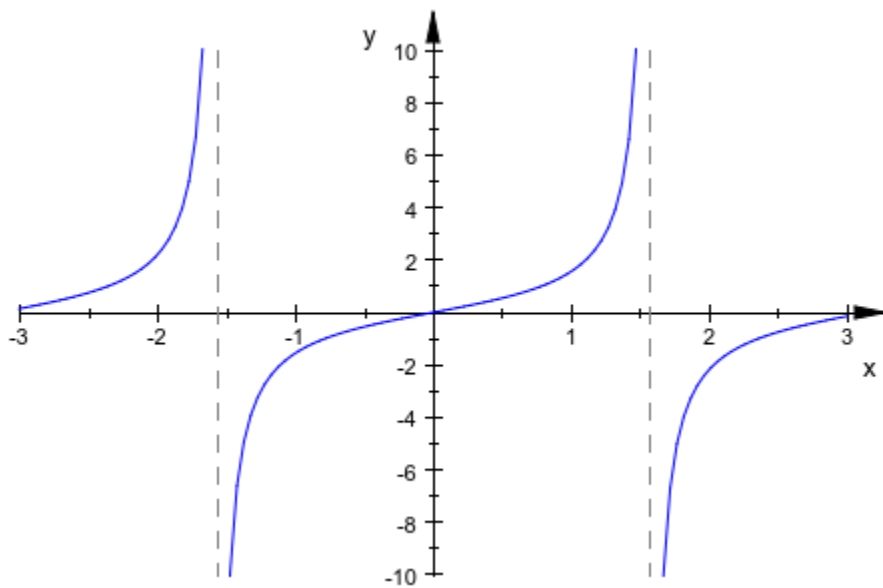

### Example 6

The following function has a jump discontinuity:

```
plotfunc2d((x^2 - x)/(2*abs(x - 1)), x = -3 .. 3,  
           YRange = -3 .. 3)
```

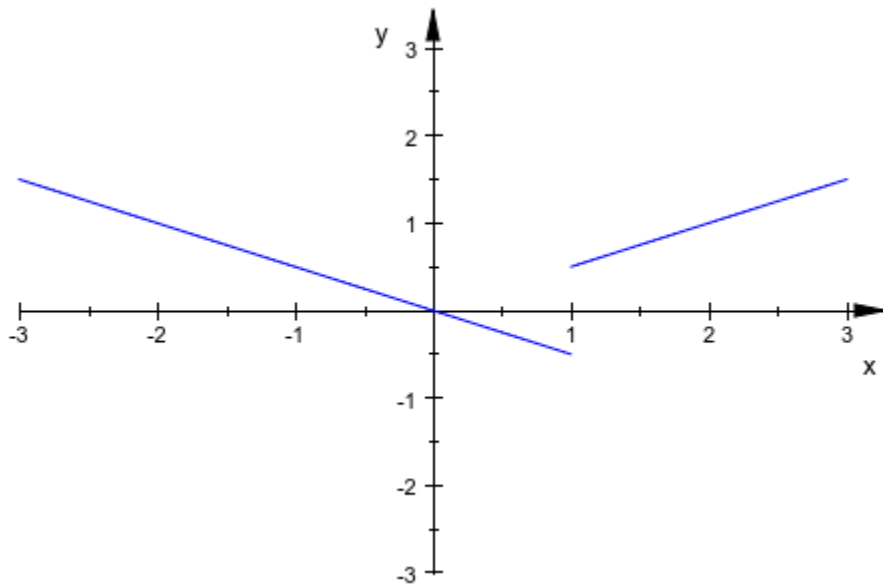

### Example 7

Piecewise defined on page 1-1275 (Symbolic Math Toolbox) functions are handled:

```
f := piecewise([x < 1, -x^2 + 1], [x >= 1, x]):  
plotfunc2d(f(x), x = -3 .. 3, YRange = -3 .. 3,  
           GridVisible = TRUE, TicksDistance = 1)
```

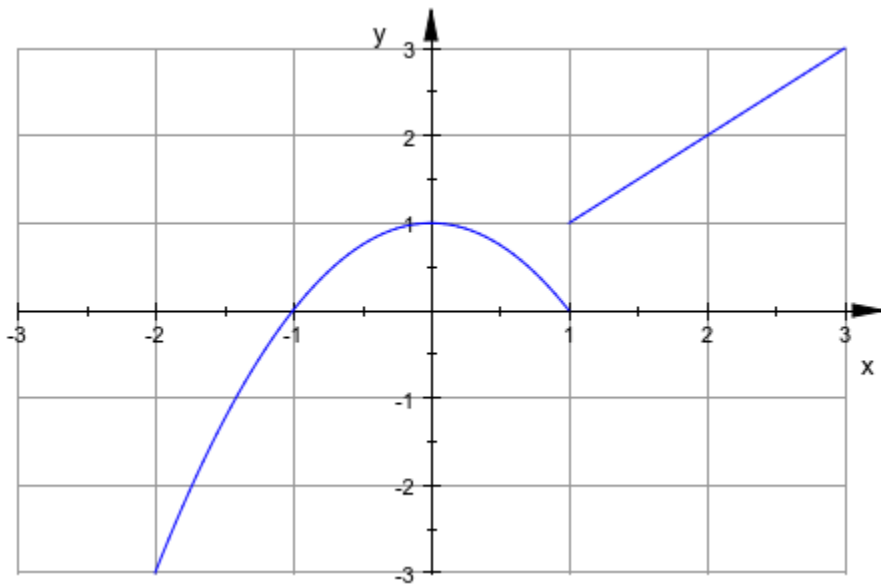

```
f := piecewise([x <= 0, x], [x > 0, 1/x]):  
plotfunc2d(f(x), x = -3 .. 3, YRange = -3 .. 3,  
           GridVisible = TRUE, TicksDistance = 1)
```



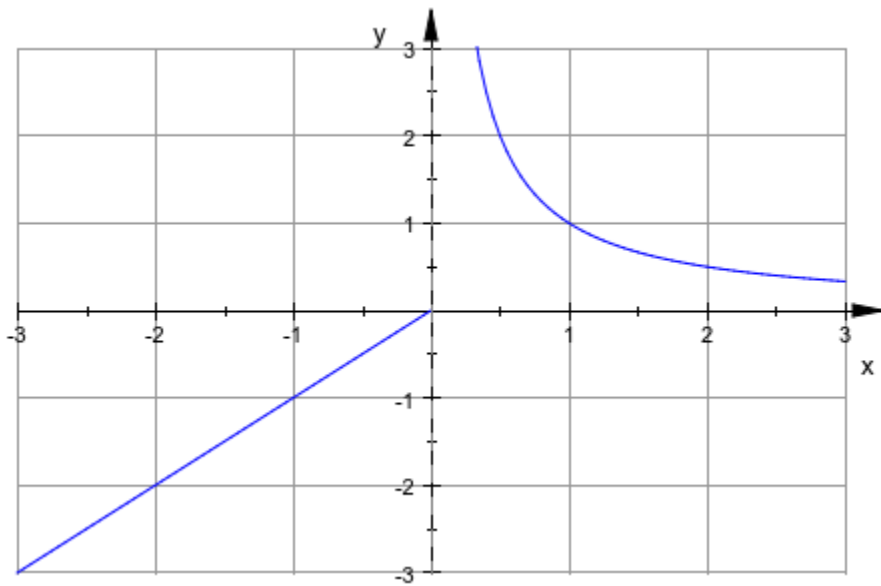

delete f:

## Example 8

We use the attribute `CoordinateType` to create a logarithmic plot:

```
plotfunc2d(exp(x/10) + exp(-x), x = -1 .. 10,  
           CoordinateType = LinLog)
```

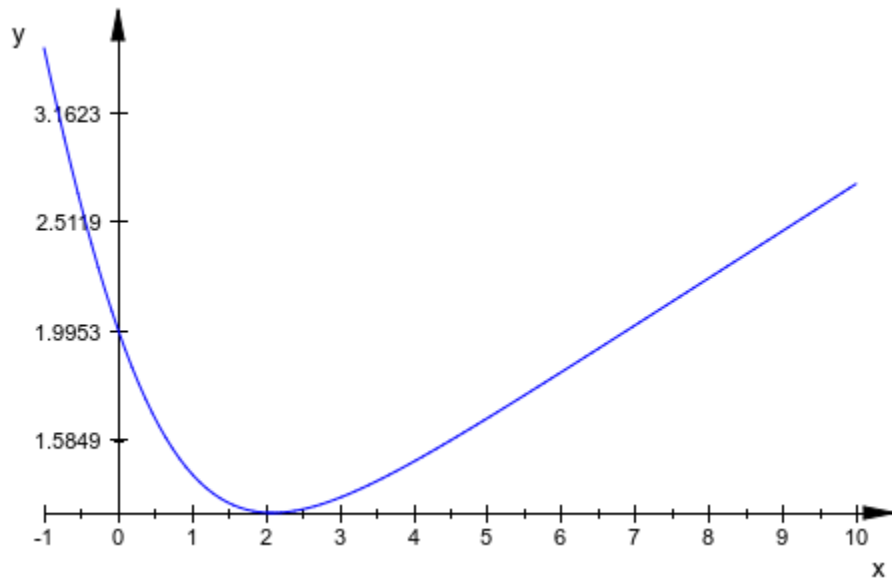

We demonstrate various further graphical attributes in a doubly logarithmic plot:

```
plotfunc2d(x^2, x^3/(1 + x^(1/2)), x^3,  
           x = 1/10 .. 10^3,  
           CoordinateType = LogLog,  
           Axes = Boxed,  
           DiscontinuitySearch = FALSE,  
           GridVisible = TRUE,  
           TicksNumber = None,  
           TicksAt = [[10^i $ i = -1 .. 3],  
                     [10^i $ i in {-3, 0, 3, 6, 9}]  
           ]):
```

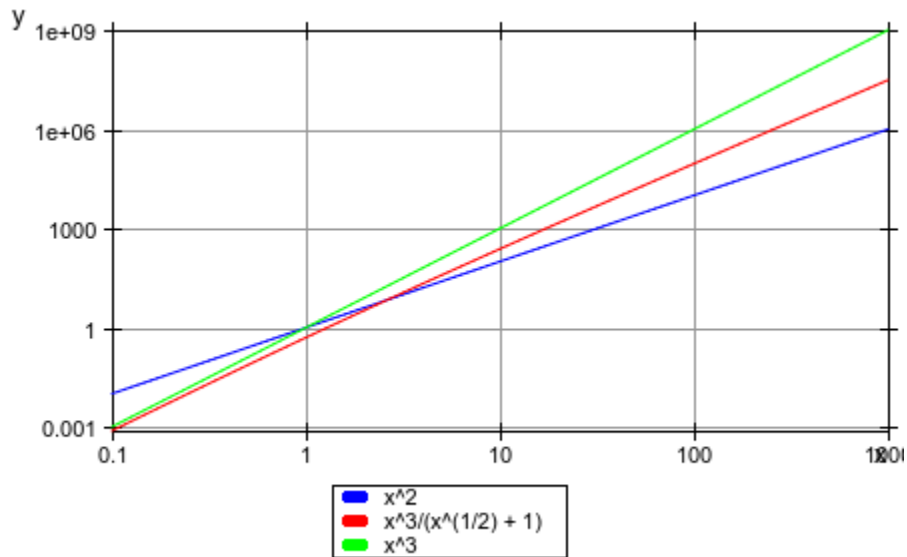

## Parameters

$f_1, f_2, \dots$

The functions: arithmetical expressions (Symbolic Math Toolbox) or `piecewise` objects in the indeterminate  $x$  and the animation parameter  $a$ . Alternatively, procedures on page 1-1654 that accept 1 input parameter  $x$  or 2 input parameters  $x, a$  and return a real numerical value when the input parameters are numerical.

$x$

The independent variable: an identifier on page 7-29 or an indexed identifier on page 1-1017.

$x_{\min} \dots x_{\max}$

The plot range:  $x_{\min}, x_{\max}$  must be numerical real values or expressions of the animation parameter  $a$ . If not specified, the default range  $x = -5 \dots 5$  is used.

**a**

The animation parameter: an identifier on page 7-29 or an indexed identifier on page 1-1017.

 **$a_{\min}$  ..  $a_{\max}$** 

The animation range:  $a_{\min}$ ,  $a_{\max}$  must be numerical real values.

 **$c_1$ ,  $c_2$ , ...**

The colors for  $f_1$ ,  $f_2$  etc.: RGB or RGBA values (Symbolic Math Toolbox). The length of the color list needs not coincide with the number of functions in the plot. The colors are used cyclically; surplus colors are ignored.

**attributes**

An arbitrary number of graphical attributes. Each attribute is given by an equation of the form `AttributeName = AttributeValue`.

## Return Values

MuPAD graphics tool is called to render the graphical scene. The `null()` object is returned to the MuPAD session.

## See Also

**MuPAD Functions**

`display` | `plot` | `plot::easy` | `plotfunc3d`

**MuPAD Graphical Primitives**

`plot::Function2d` | `plot::Function3d`

## Topics

“2D Function Graphs: `plotfunc2d`” (Symbolic Math Toolbox)

# plotfunc3d

Function plots in 3D

## Syntax

```
plotfunc3d(f1, f2, ..., <Colors = [c1, c2, ...]>, <attributes>)
```

```
plotfunc3d(f1, f2, ..., x = xmin .. xmax, <Colors = [c1, c2, ...]>, <attributes>)
```

```
plotfunc3d(f1, f2, ..., x = xmin .. xmax, y = ymin .. ymax, <Colors = [c1, c2, ...]>, <attributes>)
```

```
plotfunc3d(f1, f2, ..., x = xmin .. xmax, y = ymin .. ymax, a = amin .. amax, <Colors = [c1, c2, ...]>, <attributes>)
```

## Description

`plotfunc3d(f1, f2, ...)` generates a 3D plot of the bivariate functions `f1`, `f2` etc.

The functions to be plotted must not contain any symbolic parameters apart from the variables `x`, `y` and the animation parameter `a`. Exact numerical values such as `PI`, `sqrt(2)` etc. are accepted.

Animations are triggered by specifying a range `a = `a_{min}` .. `a_{max}`` for a parameter `a` that is different from the independent variables `x`, `y`. Thus, in animations, the `x`-range `x = `x_{min}` .. `x_{max}``, the `y`-range `y = `y_{min}` .. `y_{max}`` as well as the animation range `a = `a_{min}` .. `a_{max}`` must be specified. See “Example 2” on page 1-1582 (Symbolic Math Toolbox).

If unbounded functions are plotted, the range of the `z` coordinate is clipped, automatically. An explicit `z` range `z = `z_{min}` .. `z_{max}`` may be requested via `ViewingBoxZRange = `z_{min}` .. `z_{max}`` or `ZRange = `z_{min}` .. `z_{max}``.

Discontinuities and piecewise defined on page 1-1275 (Symbolic Math Toolbox) functions are handled. See “Example 6” on page 1-1587 (Symbolic Math Toolbox) and “Example 7” on page 1-1588 (Symbolic Math Toolbox).

The `plot` library provides the routine `plot::Function3d` which allows to create a function graph as a graphical primitive, and to combine it with other graphical objects.

A variety of graphical attributes can be specified for fine tuning the graphical output. Such attributes are passed as equations `AttributeName = AttributeValue` to the `plotfunc3d` command.

Section 2.3 (“Attributes for `plotfunc2d` and `plotfunc3d`”) (Symbolic Math Toolbox) provides an overview of the available attributes.

In particular, all attributes accepted by the graphical primitive `plot::Function3d` for function graphs are accepted by `plotfunc3d`. These attributes allow to specify the mesh for the numerical evaluation, the line width etc. The help page of `plot::Function3d` on page 24-315 provides a concise list.

Further, all attributes accepted by `plot::CoordinateSystem3d` are accepted by `plotfunc3d`. These attributes include the specification of a viewing box, of the axes, their tick marks and tick labels, the coordinate type (such as linear versus logarithmic plots), grid lines etc. The help page of `plot::CoordinateSystem3d` on page 24-1067 provides a concise list.

Further, all attributes accepted by `plot::Scene3d` are accepted by `plotfunc3d`. These attributes include the specification of the layout of the graphical scene, the background color etc. The help page of `plot::Scene3d` on page 24-1090 provides a concise list.

Further, all attributes accepted by `plot::Canvas` are accepted by `plotfunc3d`. These attributes include the specification of the size of the graphics, of further layout parameters etc. The help page of `plot::Canvas` on page 24-1053 provides a concise list.

A graphical attribute such as `Mesh = [20, 20]` (setting the number of mesh points for the numerical evaluation to 20 in each direction) is applied to *all* functions in the call `plotfunc3d(f1, f2, ...)`. If separate attributes are appropriate, use the equivalent call

`plot(plot::Function3d(f1, attr1), plot::Function3d(f2, attr2), ...)`,

in which the attributes `attr1`, `attr2` etc. can be set separately for each function.

Apart from few exceptions, `plotfunc3d` uses the standard default values for the graphical attributes (see the help page of `plot::Function3d`). The exceptions are:

- If more than one function is plotted, `plotfunc3d` automatically creates a legend. Use an explicit `LegendVisible = FALSE` to suppress the legend.
- If parameter ranges such as `x = xmin .. xmax`, `y = ymin .. ymax` are passed to `plotfunc3d`, the names `x`, `y` are used as the titles for the corresponding axis. Pass the attributes `XAxisTitle`, `YAxisTitle` if different labels are desired.

## Environment Interactions

The function is sensitive to the environment variable DIGITS which determines the numerical working precision. Make sure that DIGITS is set to a sufficiently small value (such as the default value 10) to avoid the costs of computing unnecessarily precise plot data.

## Examples

### Example 1

The following command draws two functions over the unit square:

```
plotfunc3d(sin(x^2 + y^2), cos(x^2 - y^2), x = 0..1, y = 0..2)
```

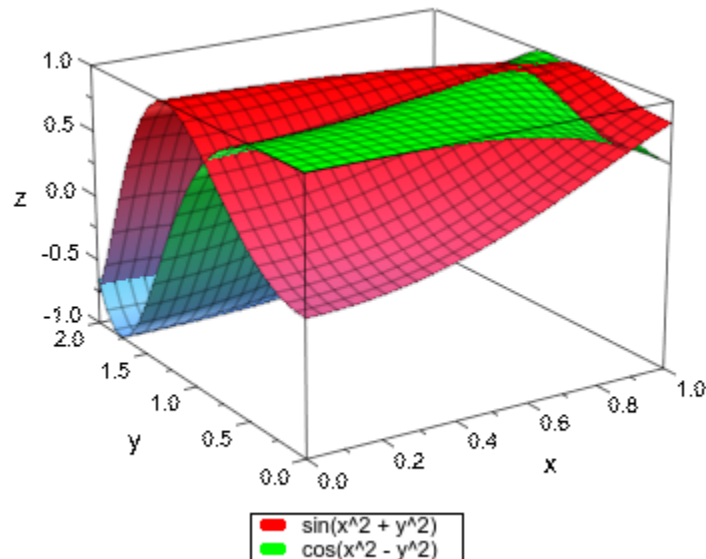

## Example 2

When creating an animation, ranges for the independent variables  $x$ ,  $y$  must be specified. An additional third range triggers the animation:

```
plotfunc3d(sin(x - a)*sin(y - a),  
           x = -PI .. PI, y = -PI .. PI, a = -PI .. PI)
```

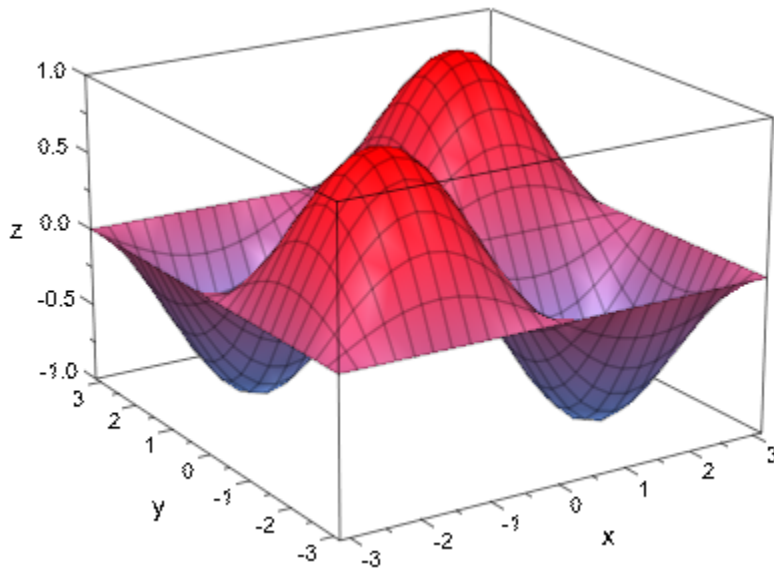

## Example 3

We demonstrate the effect of various graphical attributes:

```
plotfunc3d(abs(x + I*y), x = -1..1, y = -1..1,  
           FillColor = RGB::Green, TicksDistance = 0.5)
```



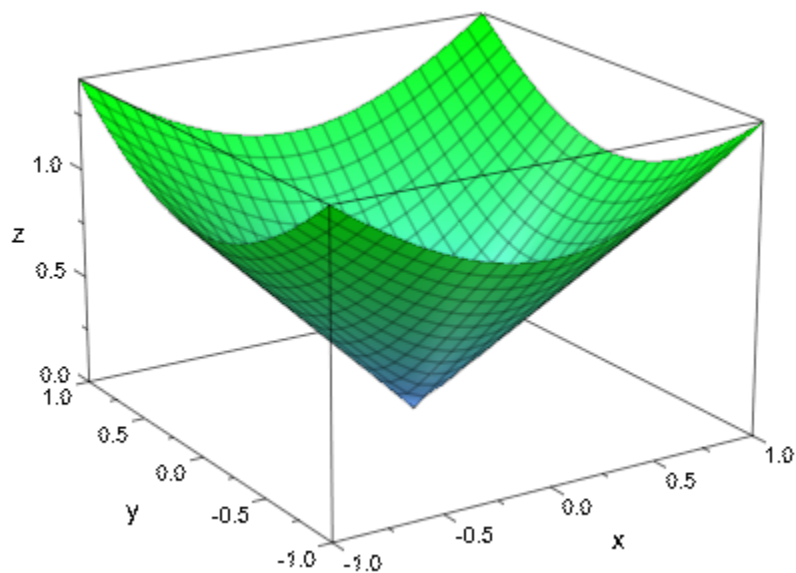

```
plotfunc3d(abs(x + I*y), x = -1..1, y = -1..1,  
           Mesh = [40, 40], Axes = Frame,  
           CameraDirection = [10, -5, 15])
```

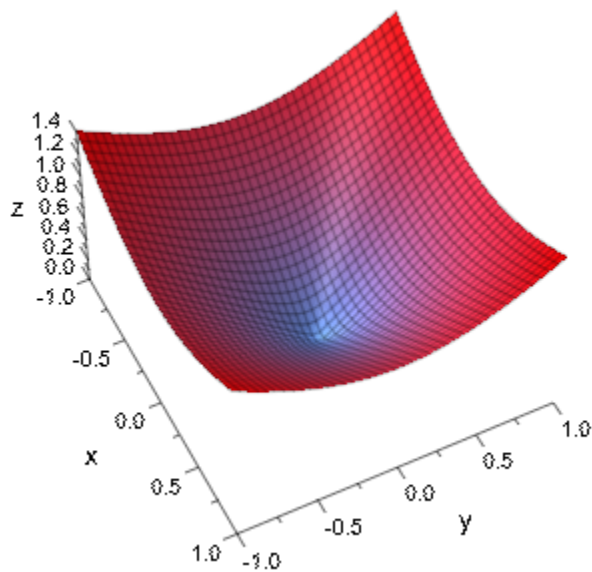

### Example 4

Points where the function to plot are not real-valued are left out from the plot:

```
plotfunc3d(sqrt(1 - x^2 - y^2), x = -1..1, y = -1..1):
```

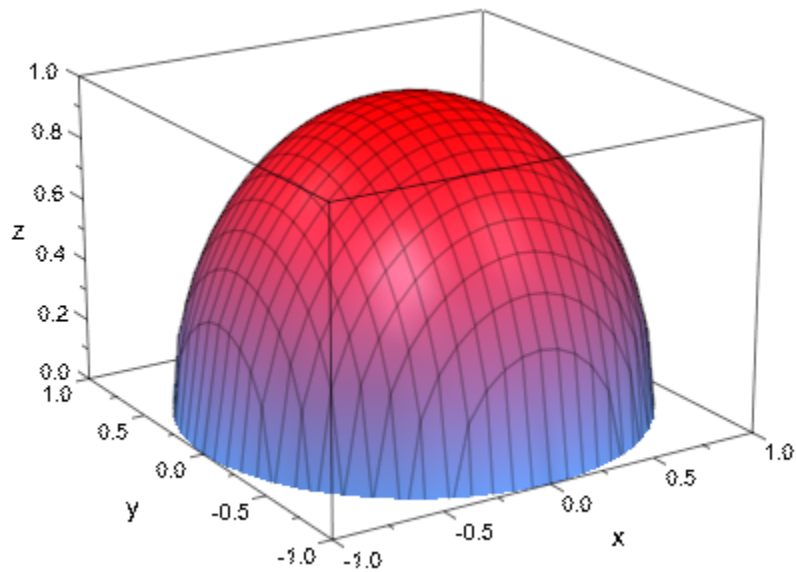

### Example 5

Singular functions are handled. The vertical coordinate range is automatically restricted by a heuristics:

```
plotfunc3d(1/(x^2 + y^2), x = -1..1, y = -1..1):
```

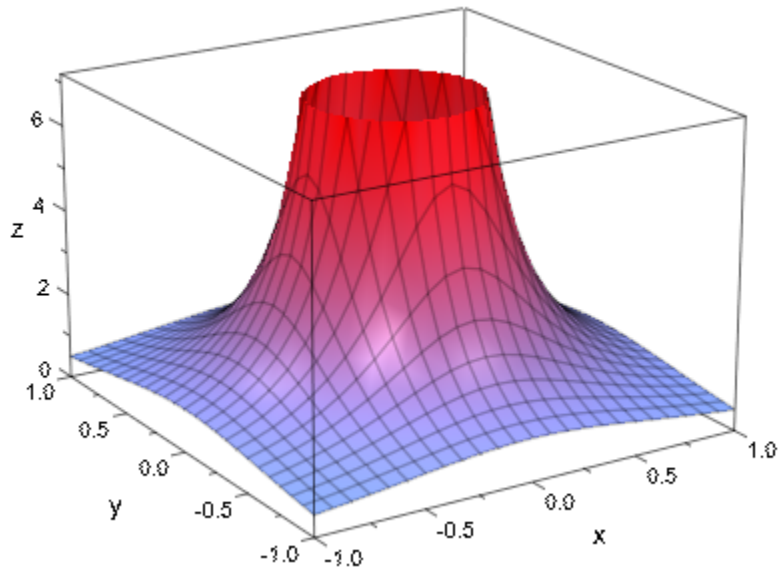

If the heuristics produces an inappropriate vertical range, you can request an appropriate range by the attribute `ViewingBoxZRange` or `ZRange`:

```
plotfunc3d(1/(x^2 + y^2), x = -1..1, y = -1..1,  
           ZRange = 0 .. 20):
```

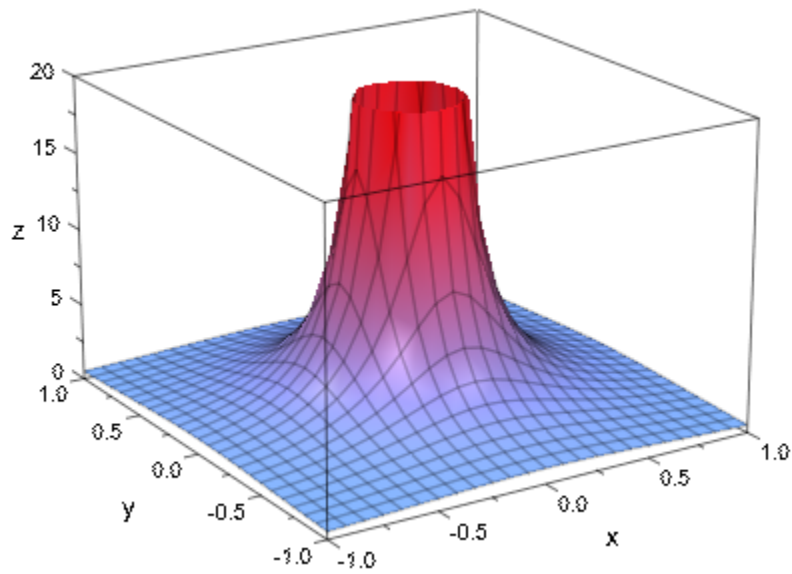

## Example 6

The following function has a discontinuity at the origin:

```
plotfunc3d((x^2 - y^2)/(x^2 + y^2),  
           x = -1 .. 1, y = -1 .. 1)
```

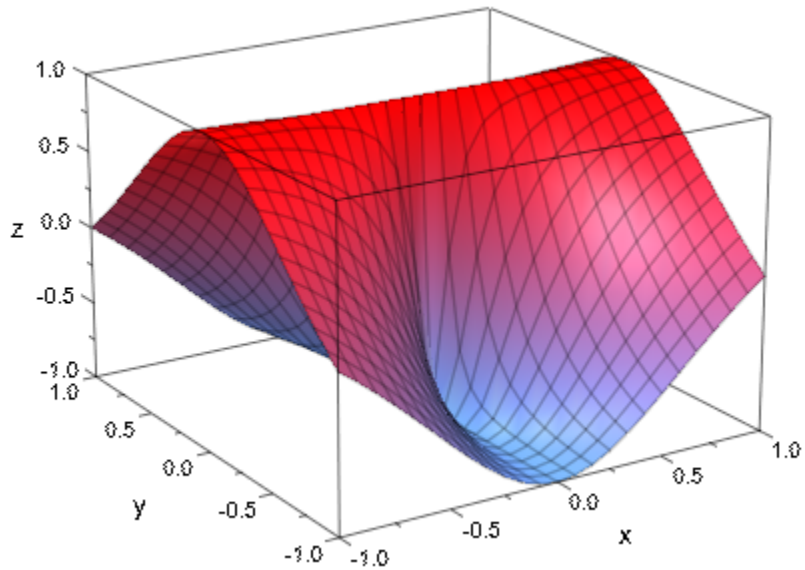

### **Example 7**

Piecewise defined on page 1-1275 (Symbolic Math Toolbox) functions are handled:

```
f := piecewise([x < y, 1 - x^2], [x >= y, 1 - y^2]):  
plotfunc3d(f(x, y), x = -3..3, y = -3..3, TicksDistance = 1)
```

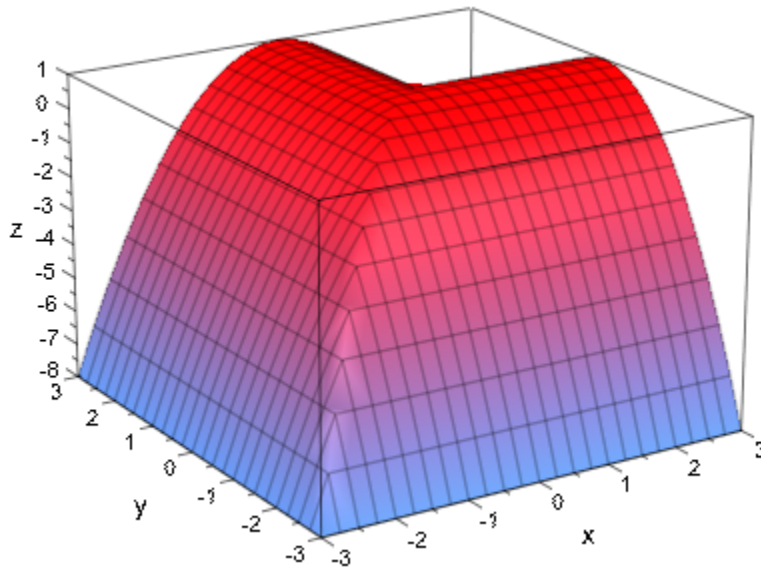

delete f:

## Parameters

$f_1, f_2, \dots$

The functions: arithmetical expressions (Symbolic Math Toolbox) or piecewise objects in the indeterminates  $x, y$  and the animation parameter  $a$ . Alternatively, procedures on page 1-1654 that accept 2 input parameter  $x, y$  or 3 input parameters  $x, y, a$  and return a real numerical value when the input parameters are numerical.

$x$

The first independent variable: an identifier on page 7-29 or an indexed identifier on page 1-1017.

$x_{\min} \dots x_{\max}$

The range of  $x$ :  $x_{\min}, x_{\max}$  must be numerical real values or expressions of the animation parameter  $a$ . If not specified, the default range  $x = -5 \dots 5$  is used.

**y**

The second independent variable: an identifier on page 7-29 or an indexed identifier on page 1-1017.

 **$y_{\min}$  ..  $y_{\max}$** 

The range of  $y$ :  $y_{\min}$ ,  $y_{\max}$  must be numerical real values or expressions of the animation parameter  $a$ . If not specified, the default range  $y = -5 \dots 5$  is used.

**a**

The animation parameter: an identifier on page 7-29 or an indexed identifier on page 1-1017.

 **$a_{\min}$  ..  $a_{\max}$** 

The animation range:  $a_{\min}$ ,  $a_{\max}$  must be numerical real values.

 **$c_1, c_2, \dots$** 

The colors for  $f_1, f_2$  etc.: RGB or RGBA values (Symbolic Math Toolbox). The length of the color list needs not coincide with the number of functions in the plot. The colors are used cyclically; surplus colors are ignored.

**attributes**

An arbitrary number of graphical attributes. Each attribute is given by an equation of the form `AttributeName = AttributeValue`.

## Return Values

MuPAD graphics tool is called to render the graphical scene. The `null()` object is returned to the MuPAD session.

## See Also

**MuPAD Functions**

`display` | `plot` | `plot::easy` | `plotfunc2d`



## **MuPAD Graphical Primitives**

`plot::Function2d` | `plot::Function3d`

## **Topics**

"3D Function Graphs: plotfunc3d" (Symbolic Math Toolbox)

## pochhammer

The Pochhammer symbol

### Syntax

`pochhammer(x, n)`

### Description

`pochhammer(x, n)` represents the Pochhammer symbol  $(x)_n = \frac{\Gamma(x+n)}{\Gamma(x)}$ .

If  $n$  is a positive integer, then  $(x)_n = x(x+1) \dots (x+n-1)$ . This is extended analytically

to arbitrary complex arguments via  $(x)_n = \frac{\Gamma(x+n)}{\Gamma(x)}$ , where *gamma* is the gamma function.

If both  $x$  and  $x+n$  are non-positive integers, `pochhammer(x, n)` produces the limit

$$\lim_{t \rightarrow 0} \frac{\Gamma(x+n+t)}{\Gamma(x+t)}.$$

If both  $x$  and  $n$  are numerical values, then an explicit numerical result is returned. Otherwise, a symbolic function call is returned.

If  $n$  is a negative integer, then the identity `pochhammer(x, n) = 1/pochhammer(x + n, -n)` is used to express the result.

The following special cases are implemented: `pochhammer(x, 0) = 1`, `pochhammer(x, 1) = x`, `pochhammer(x, -1) = 1/(x - 1)`, `pochhammer(1, n) = gamma(n + 1)`, `pochhammer(2, n) = gamma(n + 2)`.

If  $n$  is a positive integer, then `expand(pochhammer(x, n))` yields the expanded polynomial  $x(x+1) \dots (x+n-1)$ .

If  $n$  is not an integer, then `expand(pochhammer(x, n))` yields a representation in terms of `gamma`.

## Environment Interactions

When called with floating-point arguments, this function is sensitive to the environment variable DIGITS which determines the numerical working precision.

## Examples

### Example 1

pochhammer returns explicit results if both arguments are numbers:

`pochhammer(3, 5)`, `pochhammer(3/2, 2)`, `pochhammer(7/2, I - 1/2)`

$$2520, \frac{15}{4}, \frac{8 \Gamma(3 + i)}{15 \sqrt{\pi}}$$

Some special cases are implemented:

`pochhammer(x, -1)`, `pochhammer(x, 0)`, `pochhammer(x, 1)`

$$\frac{1}{x-1}, 1, x$$

`pochhammer(1, n)`, `pochhammer(2, n)`

$$\Gamma(n+1), \Gamma(n+2)$$

A symbolic call is returned for other arguments:

`pochhammer(x, 2)`, `pochhammer(3, n)`, `pochhammer(x + I, n)`

$$(x)_2, (3)_n, (x+i)_n$$

## Example 2

`expand` turns a symbolic `pochhammer` call into an explicit polynomial expression or rewrites it in terms of the `gamma` function if that function is known to be defined at its argument:

```
expand(pochhammer(x, 3))
```

$$x^3 + 3x^2 + 2x$$

```
expand(pochhammer(x, -3))
```

$$\frac{1}{x^3 - 6x^2 + 11x - 6}$$

```
expand(pochhammer(x, n)) assuming x>0 and n>0
```

$$\frac{\Gamma(n+x)}{\Gamma(x)}$$

```
expand(pochhammer(x + 1, n)) assuming x>0 and n>0
```

$$\frac{\Gamma(n+x)}{\Gamma(x)} + \frac{n \Gamma(n+x)}{x \Gamma(x)}$$

You can also use `rewrite` with the targets `gamma` or `fact` to rewrite `pochhammer`:

```
rewrite(pochhammer(x + 1, n), gamma)
```

$$\frac{\Gamma(n+x+1)}{\Gamma(x+1)}$$

```
rewrite(pochhammer(x + 1, n), fact)
```

$$\frac{(n+x)!}{x!}$$

### Example 3

`diff` and `series` act on symbolic `pochhammer` calls:

```
diff(pochhammer(x, n), x)
```

$$(x)_n (\psi(n+x) - \psi(x))$$

```
diff(pochhammer(x, n), n)
```

$$\psi(n+x) (x)_n$$

```
series(pochhammer(x, -3), x = 2)
```

$$-\frac{1}{x-2} - (x-2) - (x-2)^3 + O((x-2)^5)$$

## Parameters

**x**

An arithmetical expression (Symbolic Math Toolbox)

**n**

An arithmetical expression (Symbolic Math Toolbox)

## Return Values

Arithmetical expression.

## Overloaded By

n, x

## See Also

### MuPAD Functions

fact | gamma

# poles

Poles of expression or function

## Syntax

```
poles(f, x)
```

```
poles(f, x = a..b)
```

```
poles(f, x, options)
```

```
poles(f, x = a..b, options)
```

## Description

`poles(f, x)` finds nonremovable singularities of  $f$ . These singularities are called the poles of  $f$ . Here,  $f$  is a function of the variable  $x$ . See “Example 1” on page 1-1598 (Symbolic Math Toolbox).

`poles(f, x = a..b)` finds the poles in the interval  $(a, b)$ . See “Example 2” on page 1-1598 (Symbolic Math Toolbox).

If `poles` cannot find all nonremovable singularities and cannot prove that they do not exist, it returns an unevaluated call. See “Example 3” on page 1-1598 (Symbolic Math Toolbox).

If `poles` can prove that  $f$  has no poles (either in the specified interval  $(a, b)$  or in the complex plane), it returns an empty set. See “Example 4” on page 1-1598 (Symbolic Math Toolbox).

$a$  and  $b$  must be real numbers or infinities. If you provide complex numbers, `poles` uses an empty interval and returns an empty set.

## Examples

### Example 1

Find the poles of these expressions:

```
poles(1/(x - I), x);  
poles(sin(x)/(x - 1), x)
```

$\{i\}$

$\{1\}$

### Example 2

Find the poles of the tangent function in the interval  $(-PI, PI)$ :

```
poles(tan(x), x = -PI..PI)
```

$\left\{-\frac{\pi}{2}, \frac{\pi}{2}\right\}$

### Example 3

The tangent function has an infinite number of poles. If you do not specify the interval, `poles` cannot find all of them and, therefore, returns an unevaluated call:

```
poles(tan(x), x)
```

`poles(tan(x), x)`

### Example 4

If `poles` can prove that the expression or function does not have any poles in the specified interval, it returns an empty set:



```
poles(tan(x), x = -1..1)
```

 $\emptyset$ 

## Example 5

Use `Multiple` to find the poles of this expression and their orders. Restrict the search interval to  $(-\pi, 10\pi)$ :

```
poles(tan(x)/(x - 1)^3, x = -PI..PI, Multiple)
```

 $\left\{ [1, 3], \left[-\frac{\pi}{2}, 1\right], \left[\frac{\pi}{2}, 1\right] \right\}$ 

## Example 6

Use `Residues` to find the poles of this expression and their residues:

```
poles(a/x^2/(x - 1), x, Residues)
```

 $\{ [0, -a], [1, a] \}$ 

## Example 7

Use `Multiple` and `Residues` to find the poles of this expression and their orders and residues:

```
poles(a/x^2/(x - 1), x, Multiple, Residues)
```

 $\{ [0, 2, -a], [1, 1, a] \}$ 

## Parameters

**f**

Arithmetical expression (Symbolic Math Toolbox) representing a function in  $x$ .

**x**

Identifier on page 7-29.

**a, b**

Real numbers (including infinities) that specify the search interval for function poles. If you do not specify the interval  $(a, b)$ , then `poles` uses the entire complex plane.

## Options

### Multiple

When you use this option, `poles` finds the poles of  $f$  and their orders. It returns a set of lists. Each list contains two entries: the value of a pole and its order.

See “Example 5” on page 1-1599 (Symbolic Math Toolbox).

### Residues

When you use this option, `poles` finds the poles of  $f$  and their residues. It returns a set of lists. Each list contains two entries: the value of a pole and its residue.

See “Example 6” on page 1-1599 (Symbolic Math Toolbox).

## Return Values

Set or set of lists. Without the options, `poles` returns a set containing the values of poles. With `Multiple` or `Residues`, it returns a set of lists. Each list contains the value of a pole and its order or residue, respectively. With both options, `poles` returns a set of lists. Each list contains the value of a pole, its order, and residue.

## See Also

### MuPAD Functions

`discont` | `limit` | `solve`

# polyExprIntMod

Create a polynomial

## Syntax

```
poly(f, <[x1, x2, ...]>, <ring>)
```

```
poly(p, <[x1, x2, ...]>, <ring>)
```

```
poly(list, [x1, x2, ...], <ring>)
```

```
poly(coeffs, [x], <ring>)
```

## Description

`poly(f)` converts a polynomial expression `f` to a polynomial of the kernel domain `DOM_POLY`.

The kernel domain `DOM_POLY` represents polynomials. The arithmetic for this data structure is more efficient than the arithmetic for polynomial expressions. Moreover, this domain allows you to use special coefficient rings that cannot be represented by expressions. The function `poly` is the tool for generating polynomials of this type.

`poly(f, [x1, x2, ...], ring)` converts the expression `f` to a polynomial in the indeterminates `x1, x2, ...` over the specified coefficient ring. The `poly` function does not require an expanded form of the expression `f`. The function internally expands expressions.

If you do not specify indeterminates, MuPAD searches for them internally. If MuPAD cannot identify indeterminates, it returns `FAIL`.

By default, the `poly` function uses the coefficient ring of arbitrary MuPAD expressions. In this case, you can use arbitrary MuPAD expressions as coefficients.

If the `poly` function cannot convert an expression to a polynomial, the function returns `FAIL`. See “Example 10” on page 1-1609 (Symbolic Math Toolbox).

If  $f$  is a domain element, the system calls `f::dom::poly` for the conversion into a polynomial. If  $f$  contains domain elements, the system recursively calls `f::dom::poly` for domain elements inside  $f$ . See “Example 11” on page 1-1609 (Symbolic Math Toolbox).

`poly(p, [x1, x2, ...], ring)` converts a polynomial  $p$  of the type `DOM_POLY` to a polynomial in the indeterminates  $x_1, x_2, \dots$  over the specified coefficient ring. The indeterminates and the coefficient ring are part of the data structure `DOM_POLY`. Using this function call, you can change the indeterminates and the coefficient ring of a polynomial.

If you do not specify indeterminates, `poly` uses the indeterminates of the original polynomial  $p$ .

If you do not specify a coefficient ring, `poly` uses the ring of the original polynomial  $p$ .

See “Example 8” on page 1-1608 (Symbolic Math Toolbox) and “Example 9” on page 1-1609 (Symbolic Math Toolbox).

`poly(list, [x])` converts a list of coefficients  $[a_0, a_1, a_2, \dots]$  to a univariate polynomial  $a_0 + a_1x + a_2x^2 + \dots$ . See “Example 3” on page 1-1605 (Symbolic Math Toolbox).

For a univariate polynomial  $p$ , the call `poly(list, [x])` converts the result of the call `coeff(p, All)` back to a polynomial.

`poly(list, [x1, x2, ...], ring)` converts a list of coefficients and exponents to a polynomial in the indeterminates  $x_1, x_2, \dots$  over the specified coefficient ring. See “Example 4” on page 1-1606 (Symbolic Math Toolbox) and “Example 7” on page 1-1607 (Symbolic Math Toolbox).

This call is the fastest method to create polynomials of the type `DOM_POLY` because the input already has the form that MuPAD uses internally.

The list must contain an element for each nonzero monomial of the polynomial. Therefore, you must use sparse input involving only nonzero terms. In particular, an empty list results in the zero polynomial.

Each element of the list must be a list with two elements: the coefficient of the monomial and the exponent (or exponent vector). For a univariate polynomial in the variable  $x$ , the list

$$[[c_1, e_1], [c_2, e_2], \dots]$$

corresponds to  $c_1 x^{e_1} + c_2 x^{e_2} + \dots$ . For a multivariate polynomial, the exponent vectors are lists containing the exponents of all indeterminates of the polynomial. The order of the exponents must be the same as the order given by the list of indeterminates. For a multivariate polynomial in the variables  $x_1, x_2$ , the term list

$$[[c_1, [e_{11}, e_{12}]], [c_2, [e_{21}, e_{22}]], \dots]$$

corresponds to  $c_1 x_1^{e_{11}} x_2^{e_{12}} + c_2 x_1^{e_{21}} x_2^{e_{22}} + \dots$ .

The order of the elements of the term list does not affect the resulting polynomial. If you provide multiple entries corresponding to the same term, `poly` adds the coefficients.

This call lets you restore polynomials from the term lists returned by `poly2list`.

The position of the indeterminates in the input list `[x1, x2, ...]` determines their order in the resulting polynomial. If you do not specify indeterminates, MuPAD searches the expression `f` for possible indeterminates and determines their order. See “Example 2” on page 1-1605 (Symbolic Math Toolbox).

You can perform arithmetical operations on polynomials that have the same indeterminates and the same coefficient ring. Also, you can perform arithmetical operations on polynomials and arithmetical expressions. When you operate on a polynomial and an arithmetical expression, MuPAD internally converts that arithmetical expression to a polynomial and performs the calculation. See “Example 1” on page 1-1604 (Symbolic Math Toolbox).

The `poly` function does not limit acceptable indeterminates to identifiers on page 7-29 or indexed identifiers on page 1-1017. You can use any expression (except for rational expressions) as an indeterminate. For example, `poly` accepts the expressions `sin(x)` and `f(x)` as indeterminates. See “Example 5” on page 1-1606 (Symbolic Math Toolbox).

After creating a polynomial, the `poly` function does not evaluate the coefficients of the polynomial. If the coefficients contain free identifiers, `poly` does not replace these identifiers with their values. See “Example 12” on page 1-1610 (Symbolic Math Toolbox).

If any domain of type `DOM_DOMAIN` provides arithmetical operations, you can use that domain as a coefficient ring. See the “Background” section for details.

If you specify a coefficient domain, MuPAD accepts only the elements of that domain as coefficients of the polynomial. On input, `poly` tries to convert a polynomial expression `f` to a polynomial over the coefficient ring. For some coefficient rings, you cannot use

arithmetical expressions to represent a polynomial. The reason is that multiplication with the indeterminates can be an invalid operation in the ring. In such cases, you can define the polynomial by using a term list. See “Example 7” on page 1-1607 (Symbolic Math Toolbox).

## Examples

### Example 1

The `poly` function creates a polynomial from a polynomial expression:

```
p := poly(2*x*(x + 3))
```

```
poly(2 x2 + 6 x, [x])
```

The operators `*`, `+`, `-` and `^` work on polynomials:

```
p^2 - p*(p + 1)
```

```
poly(-2 x2 - 6 x, [x])
```

You can multiply a polynomial by an arithmetical expression. MuPAD internally converts the expression to a polynomial of the appropriate type, and then multiplies polynomials. For example, multiply the polynomial `p` by the constant 5:

```
p*5
```

```
poly(10 x2 + 30 x, [x])
```

Now, multiply the polynomial `p` by `x - 1`:

```
p*(x - 1)
```

```
poly(2 x3 + 4 x2 - 6 x, [x])
```

If MuPAD cannot convert the expression to a polynomial of the appropriate type, the arithmetical operation between a polynomial and this expression fails:

```
p*(1/x - 1)
```

```
Error: Invalid argument. [_mult]
```

```
delete p:
```

## Example 2

You can create a polynomial with parameters. In the following call,  $y$  is a parameter (not an indeterminate):

```
poly((x*(y + 1))^2, [x])
```

$$\text{poly}((y+1)^2 x^2, [x])$$

If you do not specify indeterminates, MuPAD tries to find indeterminates automatically. The following call converts a multivariate expression to a multivariate polynomial:

```
poly((x*(y + 1))^2)
```

$$\text{poly}(x^2 y^2 + 2 x^2 y + x^2, [x, y])$$

Now, specify the order of the indeterminates explicitly:

```
poly((x*(y + 1))^2, [y, x])
```

$$\text{poly}(y^2 x^2 + 2 y x^2 + x^2, [y, x])$$

## Example 3

Use the `poly` function to convert the following list of coefficients to a univariate polynomial in  $x$ . The first entry of the list produces the term with the zero exponent. The last entry produces the term with the highest exponent:

```
p := poly([1, 2, 3, 4, 5], [x])
```

```
poly(5 x4 + 4 x3 + 3 x2 + 2 x + 1, [x])
```

To revert the ordering of the coefficients in a polynomial, use the `revert` function:

```
revert(p)
```

```
poly(x4 + 2 x3 + 3 x2 + 4 x + 5, [x])
```

### Example 4

Create the following polynomials by term lists:

```
poly([[c2, 3], [c1, 7], [c3, 0]], [x])
```

```
poly(c1 x7 + c2 x3 + c3, [x])
```

If you provide multiple coefficients corresponding to the same exponent, `poly` adds those coefficients:

```
poly([[c2, 3], [c1, 7], [c3, 0], [a, 3]], [x])
```

```
poly(c1 x7 + (a + c2) x3 + c3, [x])
```

For multivariate polynomials, specify exponent vectors by lists:

```
poly([[c1, [2, 2]], [c2, [2, 1]], [c3, [2, 0]]], [x, y])
```

```
poly(c1 x2 y2 + c2 x2 y + c3 x2, [x, y])
```

### Example 5

You can use expressions as indeterminates:

```
poly(f(x)*(f(x) + x2))
```



$$\text{poly}(x^2 f(x) + f(x)^2, [x, f(x)])$$

## Example 6

The residue class ring `IntMod(7)` is a valid coefficient ring:

```
p := poly(9*x^3 + 4*x - 7, [x], IntMod(7))
```

$$\text{poly}(2x^3 - 3x, [x], \text{IntMod}(7))$$

For computations that involve polynomials over this ring, MuPAD uses modular arithmetic:

```
p^3
```

$$\text{poly}(x^9 - x^7 - 2x^5 + x^3, [x], \text{IntMod}(7))$$

However, MuPAD does not return coefficients as elements of a special domain. Instead, it returns coefficients as plain integers of the type `DOM_INT`:

```
coeff(p)
```

```
2, -3
```

```
delete p:
```

## Example 7

To create the following polynomial, combine the input syntax that uses term lists with a specified coefficient ring:

```
poly([[9, 3], [4, 1], [-2, 0]], [x], IntMod(7))
```

$$\text{poly}(2x^3 - 3x - 2, [x], \text{IntMod}(7))$$

MuPAD interprets the input coefficients as elements of the coefficient domain. For example, conversions such as  $9 \bmod 7 = 2 \bmod 7$  occur on input. You also can use the

domain `Dom::IntegerMod(7)` to define an equivalent polynomial. If you use `IntMod(7)`, MuPAD uses the symmetric modulo function `mods` and represents the coefficients by the numbers  $-3, \dots, 3$ . If you use `Dom::IntegerMod(7)`, MuPAD uses the positive modulo function `modp` and represents the coefficients by the numbers  $0, \dots, 6$ :

```
poly([[9, 3], [4, 1], [-2, 0]], [x], Dom::IntegerMod(7))
```

```
poly(2 x3 + 4 x + 5, [x], Dom::IntegerMod(7))
```

The domain `Dom::IntegerMod(7)` does not allow multiplication with identifiers:

```
c := Dom::IntegerMod(7)(3)
```

```
3 mod 7
```

```
poly(c*x^2, [x], Dom::IntegerMod(7))
```

```
FAIL
```

Instead, use the term list to specify the polynomial:

```
poly([[c, 2]], [x], Dom::IntegerMod(7))
```

```
poly(3 x2, [x], Dom::IntegerMod(7))
```

```
delete c:
```

## Example 8

Change the indeterminates in a polynomial:

```
p:= poly((a + b)*x - a^2)*x, [x]:  
p, poly(p, [a, b])
```

```
poly((a + b) x2 + (-a2) x, [x]), poly((-x) a2 + x2 a + x2 b, [a, b])
```

## Example 9

Change the coefficient ring of a polynomial:

```
p := poly(-4*x + 5*y - 5, [x, y], IntMod(7)):
p, poly(p, IntMod(3))
```

```
poly(3 x - 2 y + 2, [x, y], IntMod(7)), poly(y - 1, [x, y], IntMod(3))
```

## Example 10

Create a polynomial over the coefficient ring `Dom::Float`:

```
poly(3*x - y, Dom::Float)
```

```
poly(3.0 x - 1.0 y, [x, y], Dom::Float)
```

The identifier `y` cannot appear in coefficients from this ring because it cannot be converted to a floating-point number:

```
poly(3*x - y, [x], Dom::Float)
```

```
FAIL
```

## Example 11

You can overload `poly` by its first operand. For example, create a domain `polyInX` that represents polynomials in `x`:

```
domain polyInX
  new := () -> new(dom, poly(args(), [x]));
  print := p -> expr(extop(p, 1));
  poly := p ->
    if args(0) = 1 then
      print(Unquoted, "polyInX::poly called with 1 argument");
      extop(p, 1);
    else
      print(Unquoted,
        "polyInX::poly called with more than 1 argument");
```

```
                poly(extop(p, 1),
                    args(2..args(0)));
            end;
end_domain:
p := polyInX(3*x^2-2)
```

$$3x^2 - 2$$

You can convert the elements of `polyInX` into polynomials of the type `DOM_POLY`. The `poly` function calls the `poly` method of the domain:

```
poly(p)
```

```
polyInX::poly called with 1 argument
```

$$\text{poly}(3x^2 - 2, [x])$$

By reacting to additional arguments, the overloading defined above also allows you to create polynomials over other coefficient rings:

```
poly(p, [x], IntMod(2))
```

```
polyInX::poly called with more than 1 argument
```

$$\text{poly}(x^2, [x], \text{IntMod}(2))$$

## Example 12

Create a polynomial with coefficients containing the identifier `y`. Although you assign the value 1 to `y`, MuPAD does not substitute the new value into the polynomial:

```
f := poly(x^2 - y, [x]):
y := 1:
eval(f)
```

$$\text{poly}(x^2 - y, [x])$$

You can evaluate the coefficients explicitly. Use the `mapcoeffs` function to apply `eval` to the coefficients of the polynomial:

```
f := mapcoeffs(f, eval)
```

```
poly(x2 - 1, [x])
```

## Parameters

### **f**

A polynomial expression (Symbolic Math Toolbox)

### **x<sub>1</sub>, x<sub>2</sub>, ...**

The indeterminates of the polynomial: typically, identifiers on page 7-29 or indexed identifiers on page 1-1017.

### **ring**

The coefficient ring: either `Expr`, or `IntMod(n)` with some integer `n` greater than 1, or a domain of type `DOM_DOMAIN`. The default is the ring `Expr` of arbitrary MuPAD expressions.

### **p**

A polynomial of type `DOM_POLY` generated by `poly`

### **list**

A list containing coefficients and exponents

### **coeffs**

A list containing coefficients of a univariate polynomial

### **x**

The indeterminate of a univariate polynomial

## Options

### Expr

The default ring `Expr` represents arbitrary MuPAD expressions. Mathematically, this ring coincides with `Dom::ExpressionField()`. However, MuPAD operates differently on the polynomials created over `Expr` and the polynomials created over `Dom::ExpressionField()`. In particular, MuPAD performs arithmetic operations for polynomials over the ring `Expr` faster.

### IntMod

The ring `IntMod(n)` represents the residue class ring  $\mathbb{Z}_n$ , using the symmetrical representation. Here, `n` is an integer greater than 1. Mathematically, this ring coincides with `Dom::IntegerMod(n)`. However, MuPAD operates differently on the polynomials created over `IntMod(n)` and the polynomials created over `Dom::IntegerMod(n)`. In particular, MuPAD performs arithmetic operations for polynomials over the ring `IntMod` faster. Also, for polynomials over `IntMod`, `coeff` and similar functions return requested coefficients as integers of the type `DOM_INT`. See “Example 6” on page 1-1607 (Symbolic Math Toolbox), “Example 7” on page 1-1607 (Symbolic Math Toolbox), and “Example 9” on page 1-1609 (Symbolic Math Toolbox).

## Return Values

Polynomial of the domain type `DOM_POLY`. If conversion to a polynomial is not possible, the return value is `FAIL`.

## Overloaded By

f

## Algorithms

To use a domain as a coefficient, the domain must contain the following:

- The entry "zero" that provides the neutral element with respect to addition.

- The entry "one" that provides the neutral element with respect to multiplication.
- The method "\_plus" that adds domain elements.
- The method "\_negate" that returns the inverse with respect to addition.
- The method "\_mult" that multiplies domain elements.
- The method "\_power" that computes integer powers of a domain element. Call this method with the domain element as the first argument and an integer as the second argument.

In addition, you must define the following methods. Functions (such as `gcd`, `diff`, `divide`, `norm` and so on) call these methods:

- The method "gcd" that returns the greatest common divisor of domain elements.
- The method "diff" that differentiates a domain element with respect to a variable.
- The method "\_divide" that divides two domain elements. It must return FAIL if division is not possible.
- The method "norm" that computes the norm of a domain element and returns it as a number.
- The method "convert" that converts an expression to a domain element. The method must return FAIL if such conversion is not possible.

The system calls this method to convert the coefficients of polynomial expressions to coefficients of the specified domain. If this method does not exist, you can specify the coefficients only by using domain elements.

- The method "expr" that converts a domain element to an expression.

The system function `expr` calls this method to convert a polynomial over the coefficient domain to a polynomial expression. If this method does not exist, `expr` inserts domain elements into the expression.

You can convert a polynomial over a certain coefficient domain into a polynomial over the same domain, but a different set of indeterminates. This conversion is much more efficient when the domain has the axiom `Ax::indetElements`. MuPAD implicitly assumes that this axiom holds for the domain `IntMod(n)`, but not for `Expr`.

Internally, MuPAD stores polynomials of the type `DOM_POLY` in a sparse representation and uses machine integers for the exponents. This method implies that in a 32-bit environment, the exponent of each variable in each monomial cannot exceed  $2^{31} - 1$ .

## See Also

### MuPAD Domains

Dom::DistributedPolynomial | Dom::MultivariatePolynomial |  
Dom::Polynomial | Dom::UnivariatePolynomial

### MuPAD Functions

RootOf | coeff | collect | degree | degreevec | divide | evalp | expr | factor |  
gcd | ground | indets | lcoeff | ldegree | lmonomial | lterm | mapcoeffs |  
monomials | nterms | nthcoeff | nthmonomial | nthterm | poly2list | tcoeff



# poly2list

Convert a polynomial to a list of terms

## Syntax

```
poly2list(p)
```

```
poly2list(f, <vars>)
```

## Description

`poly2list(p)` returns a term list containing the coefficients and exponent vectors of the polynomial `p`.

The returned term list is a list where each element represents a monomial of the polynomial with non-zero coefficient. The monomials are also represented as lists, each containing two elements: The first element is the coefficient and the second the exponent or exponent vector of the monomial. If the polynomial is univariate, exponents are returned, otherwise exponent vectors are returned. Exponent vectors have the same form as returned by the function `degreevec`. A zero polynomial results in an empty list.

The elements of the term list are sorted lexicographically according to the exponent vectors. This is also the ordering used internally for the terms of polynomials.

`poly2list(f, vars)` is equivalent to `poly2list(poly(f, vars))`: First, the polynomial expression `f` is converted to a polynomial in the variables `vars` over the expressions. Then that polynomial is converted to a term list. If the variables `vars` are not given, the free identifiers contained in `f` are used as variables. See `poly` about details on how the expression is converted to a polynomial. `FAIL` is returned if the expression cannot be converted to a polynomial.

## Examples

### Example 1

The following expressions define univariate polynomials. Thus the term lists contain exponents and not exponent vectors:

```
poly2list(2*x^100 + 3*x^10 + 4)
```

```
[[2, 100], [3, 10], [4, 0]]
```

```
poly2list(2*x*(x + 1)^2)
```

```
[[2, 3], [4, 2], [2, 1]]
```

Specification of a list of indeterminates allows to distinguish symbolic parameters from the indeterminates:

```
poly2list(a*x^2 + b*x + c, [x])
```

```
[[a, 2], [b, 1], [c, 0]]
```

### Example 2

In this example the polynomial is bivariate, thus exponent vectors are returned:

```
poly2list((x*(y + 1))^2, [x, y])
```

```
[[1, [2, 2]], [2, [2, 1]], [1, [2, 0]]]
```

### Example 3

In this example a polynomial of domain type `DOM_POLY` is given. This form must be used if the polynomial has coefficients that does not consist of expressions:

```
poly2list(poly(-4*x + 5*y - 5, [x, y], IntMod(7)))
```

```
[[3, [1, 0]], [-2, [0, 1]], [2, [0, 0]]]
```

## Parameters

**p**

A polynomial (Symbolic Math Toolbox) of type `DOM_POLY`

**f**

A polynomial expression (Symbolic Math Toolbox)

**vars**

A list on page 7-41 of indeterminates of the polynomial: typically, identifiers on page 7-29 or indexed identifiers on page 1-1017

## Return Values

List containing the coefficients and exponent vectors of the polynomial. `FAIL` is returned if a given expression cannot be converted to a polynomial.

## See Also

### MuPAD Functions

`coeff` | `coerce` | `degree` | `degreevec` | `lcoeff` | `monomials` | `poly` | `tcoeff`

# polylog

Polylogarithm function

## Syntax

`polylog(n, x)`

## Description

`polylog(n, x)` represents the polylogarithm function  $Li_n(x)$  of index  $n$  at the point  $x$ .

For a complex number  $x$  of modulus  $|x| < 1$ , the polylogarithm function of index  $n$  is defined as

$$Li_n(x) = \sum_{k=1}^{\infty} \frac{x^k}{k^n}$$

This function is extended to the whole complex plane by analytic continuation. Do not confuse the polylogarithms  $Li_n$  with the integral logarithm function `Li` which is displayed using the same symbol (without an index).

If  $n$  is an integer and  $x$  a floating-point number, then a floating-point result is computed.

If  $n$  is an integer less or equal to 1, then an explicit expression is returned for any input parameter  $x$ . If  $n$  is an integer larger than 1 or if  $n$  is a symbolic expression, then an unevaluated call of `polylog` is returned, unless  $x$  is a floating-point number. If  $n$  is a numerical value, but not an integer, then an error occurs.

Some special values for  $n = 2$  are implemented (cf. `dilog`). The values  $Li_n(0) = 0$  and

$Li_n(1) = \zeta(n)$  are implemented for any  $n$ . Furthermore,  $Li_n(-1) = (2^{1-n} - 1) \zeta(n)$  for any  $n \neq 1$ .

$Li_n(x)$  has a singularity at the point  $x = 1$  for indices  $n \leq 1$ . For indices  $n \geq 1$ , the point  $x = 1$  is a branch point. The branch cut is the real interval  $[1, \infty)$ . A jump occurs when crossing this cut. Cf. "Example 2" on page 1-1620 (Symbolic Math Toolbox).

Mathematically,  $\text{polylog}(2, x)$  coincides with  $\text{dilog}(1-x)$ .

## Environment Interactions

When called with a floating-point argument  $x$ , the function is sensitive to the environment variable DIGITS which determines the numerical working precision.

## Examples

### Example 1

Explicit results are returned for integer indices  $n \leq 1$ :

`polylog(-5, x), polylog(-1, x), polylog(0, x), polylog(1, x)`

$$\frac{x^5 + 26x^4 + 66x^3 + 26x^2 + x}{(x-1)^6}, \frac{x}{(x-1)^2}, -\frac{x}{x-1}, -\ln(1-x)$$

An unevaluated call is returned if the index is an integer  $n > 1$  or a symbolic expression:

`polylog(2, x), polylog(n^2 + 1, 2), polylog(n + 1, 2.0)`

$$\text{polylog}(2, x), \text{polylog}(n^2 + 1, 2), \text{polylog}(n + 1, 2.0)$$

Floating point values are computed for integer indices  $n$  and floating-point arguments  $x$ :

`polylog(-5, -1.2), polylog(10, 100.0 + 3.2*I)`

$$-0.2326930882, 104.9131863 + 11.44600047 i$$

Some special symbolic values are implemented:

```
polylog(4, 1), polylog(5, -1), polylog(2, I)
```

$$\frac{\pi^4}{90}, -\frac{15 \zeta(5)}{16}, -\frac{\pi^2}{48} + \text{CATALAN } i$$

```
assume(n <> 1): polylog(n, -1)
```

$$\zeta(n) \left( 2^{1-n} - 1 \right)$$

```
unassume(n): polylog(n, -1)
```

$$\text{polylog}(n, -1)$$

## Example 2

For indices  $n \geq 1$ , the real interval  $[1, \infty)$  is a branch cut. The values returned by `polylog` jump when crossing this cut:

```
polylog(3, 1.2 + I/10^1000) - polylog(3, 1.2 - I/10^1000)
```

$$-1.379393155 \cdot 10^{-18} + 0.1044301529 i$$

## Example 3

The functions `diff`, `float`, `limit`, and `series` handle expressions involving `polylog`:

```
diff(polylog(n, x), x), float(polylog(4, 3 + I))
```

$$\frac{\text{polylog}(n-1, x)}{x}, 3.177636803 + 1.859135861 i$$

```
series(polylog(4, sin(x)), x = 0)
```

$$x + \frac{x^2}{16} - \frac{25 x^3}{162} - \frac{13 x^4}{768} + \frac{1523 x^5}{405000} + \frac{49 x^6}{51840} + O(x^7)$$

## Parameters

**n**

An arithmetical expression (Symbolic Math Toolbox) representing an integer

**x**

An arithmetical expression (Symbolic Math Toolbox)

## Return Values

Arithmetical expression.

## Overloaded By

x

## References

L. Lewin, "Polylogarithms and Related Functions", North Holland (1981). L. Lewin (ed.), "Structural Properties of Polylogarithms", Mathematical Surveys and Monographs Vol. 37, American Mathematical Society, Providence (1991).

## Algorithms

The polylogarithms are characterized by  $\frac{d}{dx} \text{Li}_n(x) = \frac{1}{x} \text{Li}_{n-1}(x)$  in conjunction with  $\text{Li}_n(0) = 0$  and  $\text{Li}_1(x) = -\ln(1-x)$ .  $\text{Li}_n(x)$  is a rational function in  $x$  for  $n \leq 0$ .

$\text{Li}_n$  has a branch cut along the real interval  $[1, \infty)$  for indices  $n \geq 1$ . The value at a point  $x$  on the cut coincides with the limit "from below":

$$\text{Li}_n(x) = \lim_{\varepsilon \rightarrow 0^+} \text{Li}_n(x - \varepsilon i) = \left( \lim_{\varepsilon \rightarrow 0^+} \text{Li}_n(x + \varepsilon i) \right) - \frac{2\pi i}{(n-1)!} \ln(x)^{n-1}$$

## See Also

### **MuPAD Functions**

`dilog` | `ln`



# potential

The (scalar) potential of a gradient field

## Syntax

potential(f, [x<sub>1</sub>, x<sub>2</sub>, ...], <[y<sub>1</sub>, y<sub>2</sub>, ...]>, <Test>)

## Description

potential(f, x) determines whether the vector field  $\vec{f} = \vec{f}(\vec{x})$  is a gradient field  $\vec{f}(\vec{x}) = \text{grad}(p(\vec{x}))$  of some scalar potential  $p$  with respect to the variables  $\vec{x}$ , and computes that potential if it exists.

The potential of a vector field  $\vec{f}(\vec{x}) = [f_1(x_1, x_2, \dots), f_2(x_1, x_2, \dots), \dots]$  exists (locally) if and only if the Jacobian matrix  $\left(\frac{\partial}{\partial x_j} f_i\right)$  is symmetric in  $i$  and  $j$ . In 3 space, this is the condition that  $\text{curl}(\vec{f}(\vec{x}))$  vanishes.

The potential  $p(\vec{x})$  with  $\vec{f}(\vec{x}) = \text{grad}(p(\vec{x}))$  is uniquely determined up to an additive constant.

An integral representation of the potential is given by

$$p(\vec{x}) = \int_0^1 (\vec{x} - \vec{y}) \cdot \vec{f}(\vec{y} + \lambda (\vec{x} - \vec{y})) \, d\lambda$$

where  $\vec{y}$  is an arbitrary "base point." This is the contour integral of  $\vec{f}(\vec{x})$  along the straight line from  $\vec{y}$  to  $\vec{x}$ .

If the Jacobian matrix  $\left(\frac{\partial}{\partial x_j} f_i\right)$  is not symmetric, the potential of  $\vec{f}(\vec{x})$  does not exist. In this case, `potential` returns `FALSE`.

---

**Note** Note that the answer `FALSE` is not always conclusive. For arbitrary expressions  $f_i$ ,

$f_j$ , there is no algorithm to decide whether  $\left(\frac{\partial}{\partial x_j} f_i\right) = \left(\frac{\partial}{\partial x_i} f_j\right)$  holds mathematically: `potential` may return `FALSE` due to insufficient simplification of the partial derivatives.

---

The representation of the potential depends on the strength of the symbolic integrator `int`. If `int` does not manage to find a closed form of the potential, symbolic calls of `int` may be returned. See “Example 3” on page 1-1626 (Symbolic Math Toolbox).

If no base point  $\vec{y}$  is specified, the potential is only defined up to some additive constant.

`potential` does not consider irregular points of the vector field and its potential and investigates the potential only locally. The returned potential may be a valid potential only in a neighbourhood of the current point  $\vec{x}$ !

If  $f$  is a vector, the component ring of  $f$  must be a field (i.e., a domain of category `Cat::Field`) which allows integration.

## Examples

### Example 1

Using the option `Test`, we check whether a vector field is a gradient field:

```
f := [x, y, z*exp(z)]:  
potential(f, [x, y, z], Test)
```

`TRUE`

Without the option `Test`, the potential is returned:

```
potential(f, [x, y, z])
```

$$\frac{x^2}{2} + \frac{y^2}{2} + e^z (z - 1)$$

We check the result:

```
normal(gradient(%, [x, y, z]))
```

$$\begin{pmatrix} x \\ y \\ z e^z \end{pmatrix}$$

When a 'base point' is specified, a suitable constant is added to the potential such that it vanishes at this point:

```
potential(f, [x, y, z], [0, 0, 0])
```

$$\frac{x^2}{2} + \frac{y^2}{2} + e^z (z - 1) + 1$$

```
potential(f, [x, y, z], [x0, y0, z0])
```

$$\frac{x^2}{2} - \frac{x0^2}{2} + \frac{y^2}{2} - \frac{y0^2}{2} + e^z (z - 1) - e^{z0} (z0 - 1)$$

```
delete f:
```

## Example 2

The vector field in this example is not a gradient field and has no potential:

```
potential([x[2], -x[1]], [x[1], x[2]])
```

FALSE

### Example 3

The vector field in this example is a gradient field and has a potential. However, the symbolic integrator does not find a closed form of the integral representation for the potential and returns a symbolic definite integral:

```
potential([a + b*x, sin(y^2)*exp(y)], [x, y])
```

$$\frac{b x^2}{2} + a x + \int_0^y \sin(X^2) e^{X^2} dX$$

We check the result:

```
gradient(%, [x, y])
```

$$\begin{pmatrix} a + b x \\ \sin(y^2) e^y \end{pmatrix}$$

## Parameters

**f**

The vector field: a list of arithmetical expressions (Symbolic Math Toolbox), or a vector of such expressions. A vector is an  $n \times 1$  or  $1 \times n$  matrix of a domain of category `Cat::Matrix`.

**x<sub>1</sub>, x<sub>2</sub>, ...**

The variables: identifiers on page 7-29 or indexed identifiers on page 1-1017

**y<sub>1</sub>, y<sub>2</sub>, ...**

The components of the “base point:” arithmetical expressions. If a base point  $\vec{y}$  is specified, the returned potential  $p$  satisfies  $p(\vec{y}) = 0$ .

## Options

### Test

Check whether the vector field has a potential and return TRUE or FALSE, respectively.

## Return Values

Arithmetical expression or a Boolean value.

## See Also

### MuPAD Functions

`curl` | `divergence` | `gradient` | `laplacian` | `vectorPotential`

## powermod

Compute a modular power of a number or a polynomial

### Syntax

`powermod(b, e, m)`

### Description

`powermod(b, e, m)` computes  $b^e \bmod m$ .

If  $b$  and  $m$  are numbers, the modular power  $b^e \bmod m$  can also be computed by the direct call `b^e mod m`. However, `powermod(b, e, m)` avoids the overhead of computing the intermediate result  $b^e$  and computes the modular power much more efficiently.

If  $b$  is a rational number, then the modular inverse of the denominator is calculated and multiplied with the numerator.

If the modulus  $m$  is an integer, then the base  $b$  must either be a number, a polynomial expression or a polynomial that is convertible to an `IntMod(m)`-polynomial.

If the modulus  $m$  is a polynomial expression, then the base  $b$  must either be a number, a polynomial expression or a polynomial over the coefficient ring of MuPAD expressions.

If the modulus  $m$  is a polynomial of domain type `DOM_POLY`, then the base  $b$  must either be a number, or a polynomial of the same type as  $m$  or a polynomial expression that can be converted to a polynomial of the same type as  $m$ .

Note that the system function `mod` in charge of modular arithmetic may be changed by the user; see the help page of `mod`. The function `powermod` reacts accordingly. See "Example 5" on page 1-1630 (Symbolic Math Toolbox).

Internally, polynomials are divided by the function `divide`.

## Examples

### Example 1

We compute  $3^{123456} \bmod 7$ :

```
powermod(3, 123456, 7)
```

1

If the base is a rational number, the modular inverse of the denominator is computed and multiplied with the numerator:

```
powermod(3/5, 1234567, 7)
```

2

### Example 2

The coefficients of the following polynomial expression are computed modulo 7:

```
powermod(x^2 + 7*x - 3, 10, 7)
```

$$x^{20} - 2x^{18} - x^{16} + x^{14} - 3x^6 - x^4 + 3x^2 - 3$$

### Example 3

The power of the following polynomial expression is reduced modulo the polynomial  $x^2 + 1$ :

```
powermod(x^2 + 7*x - 3, 10, x^2 + 1)
```

$$1029668584x - 534842913$$

## Example 4

The type of the return value coincides with the type of the base: a polynomial is returned if the base is a polynomial:

```
powermod(poly(x^2 + 7*x - 3), 2, x^2 + 1),  
powermod(poly(x^2 + 7*x - 3), 2, poly(x^2 + 1))
```

```
poly(-56 x - 33, [x]), poly(-56 x - 33, [x])
```

If the base is a polynomial expression, `powermod` returns a polynomial expression:

```
powermod(x^2 + 7*x - 3, 2, x^2 + 1),  
powermod(x^2 + 7*x - 3, 2, poly(x^2 + 1))
```

```
-56 x - 33, -56 x - 33
```

## Example 5

The following re-definition of `_mod` switches to a symmetric representation of modular numbers:

```
R := Dom::IntegerMod(17):  
_mod := mods: powermod(poly(2*x^2, R), 3, poly(3*x + 1, R))
```

```
poly(-4, [x], Dom::IntegerMod(17))
```

The following command restores the default representation:

```
_mod := modp: powermod(poly(2*x^2, R), 3, poly(3*x + 1, R))
```

```
poly(13, [x], Dom::IntegerMod(17))
```

```
unalias(R):
```



## Parameters

**b**

The base: an integer on page 7-31, a rational number on page 7-48, or a polynomial (Symbolic Math Toolbox) of type `DOM_POLY`, or a polynomial expression (Symbolic Math Toolbox)

**e**

The power: a nonnegative integer

**m**

The modulus: an integer (at least 2), or a polynomial (Symbolic Math Toolbox) of type `DOM_POLY`, or a polynomial expression (Symbolic Math Toolbox)

## Return Values

Depending on the type of `b`, the return value is an integer, a polynomial, or a polynomial expression. `FAIL` is returned if an expression cannot be converted to a polynomial.

## Overloaded By

`b`

## See Also

### MuPAD Functions

`divide` | `mod` | `modp` | `mods` | `poly`

# PRETTYPRINT

Control the formatting of output

## Description

The environment variable PRETTYPRINT determines whether the MuPAD results are printed in the one-dimensional or the two-dimensional format.

Possible values: Either TRUE or FALSE

PRETTYPRINT controls the pretty printer, which is responsible for formatted output. If PRETTYPRINT has the value TRUE, then pretty printing is enabled for output.

The default value of PRETTYPRINT is TRUE; PRETTYPRINT has this value after starting or resetting the system via `reset`. Also the command `delete PRETTYPRINT` restores the default value.

In the MuPAD Notebook, PRETTYPRINT normally has no effect when “typesetting” is activated. An exception occurs for MuPAD output without typesetting defined, where PRETTYPRINT determines the output style even if the typesetting is activated.

Typesetting is activated by default. You can switch it on or off by selecting **Notebook>Typeset Math** or via **View>Configure**.

## Examples

### Example 1

The following command disables pretty printing:

```
PRETTYPRINT := FALSE
```

```
FALSE
```

Now MuPAD results are printed in a one-dimensional, linearized form:

```
series(sin(x), x = 0, 14)
```

```
x - x^3/6 + x^5/120 - x^7/5040 + x^9/362880 - x^11/39916800 + x^13/6227020800\
800 + 0(x^15)
```

After setting PRETTYPRINT to TRUE again, the usual two-dimensional output format is used:

```
PRETTYPRINT := TRUE:
series(sin(x), x = 0, 14)
```

$$x - \frac{x^3}{6} + \frac{x^5}{120} - \frac{x^7}{5040} + \frac{x^9}{362880} - \frac{x^{11}}{39916800} + \frac{x^{13}}{6227020800} + 0(x^{15})$$

## See Also

**MuPAD Functions**  
TEXTWIDTH | print

## Topics

“Pretty Print Mode” (Symbolic Math Toolbox)

## prevprime

Next smaller prime

### Syntax

```
prevprime(a)
```

### Description

`prevprime(a)` returns the greatest prime number less or equal than  $a$ . If  $a < 2$ , then `prevprime(a)` returns FAIL.

`prevprime` returns the function call with evaluated argument if the argument is not an integer.

`prevprime` returns an error if the argument evaluates to zero or a negative integer.

### Examples

#### Example 1

Computing the largest prime  $p \leq 15485865$ :

```
prevprime(15485865)
```

```
15485863
```

#### Example 2

There are no primes smaller than 2:

```
prevprime(1)
```

FAIL

## Parameters

**a**

A positive integer

## Return Values

prevprime(a) returns either a natural number or FAIL.

## Algorithms

prevprime uses the probabilistic prime test `isprime` and may therefore return false results with small probability.

## See Also

### MuPAD Functions

`isprime` | `ithprime` | `nextprime` | `numlib::proveprime`

# print

Print objects to the screen

---

**Note** For printing in MATLAB®, see `print`. For displaying a value, see `display`.

---

## Syntax

`print(<Unquoted>, <NoNL>, <KeepOrder>, <Plain>, <Typeset>, object1, object2, ...)`

## Description

`print(object)` displays `object` on the screen.

At interactive level, the result of a MuPAD command entered at the command prompt is usually displayed on the screen automatically. `print` serves to generate additional output from within loops or procedures.

Apart from some exceptions mentioned below, the output generated by `print` is identical to the usual output of MuPAD results at interactive level.

`print` evaluates its arguments sequentially from left to right (cf. “Example 3” on page 1-1639 (Symbolic Math Toolbox)) and displays the results on the screen. The individual outputs are separated by commas. A new line is started at the end of the output if this is not suppressed by the option `NoNL`.

The output width for `print` with option `Plain` is limited by the environment variable `TEXTWIDTH`. Cf. “Example 4” on page 1-1639 (Symbolic Math Toolbox).

With option `Plain` the style of the output is determined by the value of the environment variable `PRETTYPRINT`. Cf. “Example 5” on page 1-1640 (Symbolic Math Toolbox).

`print` descends recursively into the operands of an object. For each subobject `s`, `print` first determines its domain type (Symbolic Math Toolbox)`T`. If the domain `T` has a “print” slot, then `print` issues the call `T::print(s)` to the slot routine. In contrast to the overloading (Symbolic Math Toolbox) mechanism for most other MuPAD functions,

---

`print` processes the result of this call recursively, and the result of the recursive process is printed at the position of `s` (cf. “Example 6” on page 1-1641 (Symbolic Math Toolbox)).

---

**Note** The result returned by the “`print`” method must not contain the domain element `s` itself as a subobject, since this leads to infinite recursion (cf. “Example 7” on page 1-1641 (Symbolic Math Toolbox)). The same remark also applies to the output procedures of function environments on page 7-25 (see below).

---

If `T` is a library domain (Symbolic Math Toolbox) without a “`print`” slot and the internal operands of `s` are `op1`, `op2`, ..., then `s` is printed as `new(T, op1, op2, ...)`. (See “Example 6” on page 1-1641 (Symbolic Math Toolbox).)

“`print`” methods may return strings or expressions. Strings are always printed unquoted. Expressions are printed in normal mode. If they contain strings, they will be printed with quotation marks. Cf. “Example 8” on page 1-1642 (Symbolic Math Toolbox).

The output of an expression is determined by the 0th operand of the expression. If the 0th operand is a function environment, then its second operand handles the output of the expression. See “Example 9” on page 1-1642 (Symbolic Math Toolbox). Otherwise, the expression is printed in functional notation.

In contrast to the usual output of MuPAD objects at interactive level, `print` does not perform resubstitution of aliases (see `Pref::alias` for details). Moreover, the routines defined via `Pref::output` and `Pref::postOutput` are not called by `print`. Cf. “Example 14” on page 1-1645 (Symbolic Math Toolbox).

The output of floating-point numbers depends on the environment variable `DIGITS` and the settings of `Pref::floatFormat` (exponential or floating-point representation) and `Pref::trailingZeroes` (printing of trailing zeroes). Cf. “Example 16” on page 1-1646 (Symbolic Math Toolbox).

## Environment Interactions

`print` is sensitive to the environment variables `DIGITS`, `PRETTYPRINT`, and `TEXTWIDTH`, and to the output preferences `Pref::floatFormat`, `Pref::keepOrder`, and `Pref::trailingZeroes`.

## Examples

### Example 1

This example shows a simple call of `print` with strings as arguments. They are printed with quotation marks:

```
print("Hello", "You." " !"):
```

```
"Hello", "You !"
```

### Example 2

On platforms supporting typesetting, `print` can generate typeset output:

```
print(Typeset, int(f(x)/g(x), x = a..b)):
```

$$\int_a^b \frac{f(x)}{g(x)} dx$$

`print` uses the `Typeset` option by default:

```
print(int(f(x)/g(x), x = a..b)):
```

$$\int_a^b \frac{f(x)}{g(x)} dx$$

ASCII output is available with the option `Plain`:

```
print(Plain, int(f(x)/g(x), x = a..b)):
```

$$\begin{array}{l} b \\ / \\ | \quad f(x) \\ | \quad ---- dx \end{array}$$



```
/ g(x)
a
```

### Example 3

Like most other functions, `print` evaluates its arguments. In the following call, `x` evaluates to `0` and `cos(0)` evaluates to `1`:

```
a := 0: print(cos(a)^2):
```

```
1
```

Use `hold` if you want to print the expression `cos(a)^2` literally:

```
print(hold(cos(a)^2)):
```

```
cos(a)2
```

```
delete a:
```

### Example 4

`print` with the option `Plain` is sensitive to the current value of `TEXTWIDTH`:

```
print(Plain, expand((a + b)^4)):
```

```
4      3      2 2      3      4
a  + 4 a  b + 6 a  b  + 4 a b  + b
```

```
TEXTWIDTH := 25:
```

```
print(Plain, expand((a + b)^4)):
```

```
4      3      2 2
a  + 4 a  b + 6 a  b
      3      4
+ 4 a b  + b
```

If you disable the pretty print mode, the `print` function inserts the line continuation character at the line breaks:

```
PRETTYPRINT:=FALSE:  
print(Plain, expand((a + b)^4)):
```

```
a^4 + 4*a^3*b + 6*a^2*b\  
2 + 4*a*b^3 + b^4
```

The line continuation character can be invalid for some strings. For example, when you use the code generators, such as `generate::MATLAB` and `generate::Simscape`, the displayed code containing the line continuation character is not valid. To avoid inserting this character, change the `TEXTWIDTH` setting or use the `fprint` function instead of `print`:

```
fprint(Unquoted, 0, expand((a + b)^4))  
a^4 + 4*a^3*b + 6*a^2*b^2 + 4*a*b^3 + b^4
```

Also, see the Example 4 on page 1-798 (Symbolic Math Toolbox) on the `fprint` help page.

```
PRETTYPRINT := TRUE:  
delete TEXTWIDTH:
```

## Example 5

`print` with option `Plain` is sensitive to the current value of `PRETTYPRINT`:

```
print(Plain, a/b):  
old := PRETTYPRINT: PRETTYPRINT := FALSE:  
print(Plain, a/b):  
PRETTYPRINT := old:
```

```
a  
-  
b
```

```
a/b
```

```
delete old:
```

## Example 6

We demonstrate how to achieve formatted output for elements of a user-defined domain. Suppose that we want to write a new domain `Complex` for complex numbers. Each element of this domain has two operands: the real part `r` and the imaginary part `s`:

```
Complex := newDomain("Complex"): z := new(Complex, 1, 3):
z + 1;
print(Plain, z + 1):
```

```
new(Complex, 1, 3) + 1
```

```
new(Complex, 1, 3) + 1
```

Now we want a nicer output for elements of this domain, namely in the form  $r+s*I$ , where  $I$  denotes the imaginary unit. We implement the slot routine `Complex::print` to handle this. This slot routine will be called by MuPAD with an element of the domain `Complex` as argument whenever such an element is to be printed on the screen:

```
Complex::print := (z -> extop(z, 1) + extop(z, 2)*I):
z + 1;
print(Plain, z + 1):
```

```
1 + 3 i + 1
```

```
1 + 3 I + 1
```

```
delete Complex, z:
```

## Example 7

The result of a "print" method must not contain the argument as a subobject; otherwise this leads to infinite recursion. In the following example, the slot routine `T::print` would be called infinitely often. MuPAD tries to trap such infinite recursions and prints ``????`` instead:

```
T := newDomain(T): T::print := id:
new(T, 1);
print(Plain, new(T, 1)):
```

```
`????`
```

```
`????`
```

```
delete T:
```

## Example 8

If a "print" method returns a string, it will be printed unquoted:

```
Example := newDomain("Example"): e := new(Example, 1):  
Example::print := x -> "elementOfExample":  
print(e):
```

```
elementOfExample
```

If a "print"-method returns an expression, it will be printed in normal mode. If the expression contains strings, they will be printed in the usual way with quotation marks:

```
Example::print := x -> ["elementOfExample", extop(x)]:  
print(e):
```

```
["elementOfExample", 1]
```

```
delete Example, e:
```

## Example 9

Suppose that you have defined a function `f` that may return itself symbolically, and you want such symbolic expressions of the form `f(x, ...)` to be printed in a special way. To this end, embed your procedure on page 7-45f in a function environment on page 7-25 and supply an output procedure as second argument to the corresponding `funcenv` call. Whenever an expression of the form `f(x, ...)` is to be printed, the output procedure will be called with the arguments `x, ...` of the expression:

```
f := funcenv(f,  
            proc(x) begin  
              if nops(x) = 2 then
```

```

        "f does strange things with its arguments ".
        expr2text(op(x, 1))." and ".expr2text(op(x,2))
    else
        FAIL
    end
end):

```

```

delete a, b:
f(a, b)/2;
f(a, b, c)/2

```

$$\frac{f \text{ does strange things with its arguments a and b}}{2}$$

$$\frac{f(a, b, c)}{2}$$

```

delete f:

```

## Example 10

With the option Unquoted, quotation marks are omitted:

```

print(Unquoted, "Hello", "World"." !"):

```

```

Hello, World !

```

With Unquoted the special characters \t and \n are expanded:

```

print(Unquoted, "As you can see,\n".
        "'\n' is the newline character\n".
        "\tand '\t' a tabulator"):

```

```

As you can see,
'\n' is the newline character
and '\t' a tabulator

```

## Example 11

It is useful to construct output strings using `expr2text` and the concatenation operator `..`:

```
d := 5: print(Unquoted, "d plus 3 = ".expr2text(d + 3)):
```

```
d plus 3 = 8
```

```
delete d:
```

## Example 12

With the option `NoNL`, no new line is put at the end of the output and `PRETTYPRINT` is implicitly set to `FALSE`. Apart from that, the behavior is the same as with the option `Unquoted`:

```
print(NoNL, "Hello"): print(NoNL, ", You".!" !\n"):
print(NoNL, "As you can see, PRETTYPRINT is FALSE: "):
print(NoNL, x^2-1): print(NoNL, "\n"):
```

```
Hello
```

```
, You !
```

```
As you can see, PRETTYPRINT is FALSE:
```

```
x^2 - 1
```

## Example 13

If the option `KeepOrder` is given, sums are printed in their internal order:

```
print(b - a): print(KeepOrder, b - a):
```

```
b - a
```

$$-a + b$$

## Example 14

Alias resubstitution (see `Pref::alias`) takes place for normal result outputs in an interactive session, but not for outputs generated by `print`:

```
delete a, b: alias(a = b):
a; print(a):
unalias(a):
```

$$a$$

$$b$$

In contrast to the usual result output, `print` does not react to `Pref::output`:

```
old := Pref::output(generate::TeX):
sin(a)^b; print(sin(a)^b):
Pref::output(old):
```

$$\text{"{\sin\left(a\right)}^b\text{"}$$

$$\sin(a)^b$$

The same is true for `Pref::postOutput`:

```
old := Pref::postOutput("postOutput was called"):
a*b; print(a*b):
Pref::postOutput(old):
```

$$a b$$

postOutput was called

*a b*

delete old:

## Example 15

The output of summands of a sum depends on the form of these summands. If the summand is a `_mult` expression, only the first and last operand of the product are taken into account for determining the sign of that term in the output. If one of them is a negative number then the "+"-symbol in the sum is replaced by a "-"-symbol:

```
print(hold(a + b*c*(-2)),
      hold(a + b*(-2)*c),
      hold(a + (-2)*b*c)):
```

*a - 2 b c, a - b 2 c, a - 2 b c*

This has to be taken into account when writing "print"-methods for polynomial domains.

## Example 16

Floating point numbers are usually printed in fixed-point notation. You can change this to floating-point form with mantissa and exponent via `Pref::floatFormat`:

```
print(0.000001, 1000.0): old := Pref::floatFormat("e"):
print(0.000001, 1000.0): Pref::floatFormat(old):
```

*0.000001, 1000.0*

*0.000001, 1000.0*

In the default output of floating-point numbers, trailing zeroes are cut off. This behavior can be changed via `Pref::trailingZeroes`:

*0.000001, 1000.0*



```
0.000001, 1000.0
```

```
print(0.000001, 1000.0): old := Pref::trailingZeroes(TRUE):
print(0.000001, 1000.0): Pref::trailingZeroes(old):
```

```
0.000001, 1000.0
```

```
0.0000010000000000, 1000.000000
```

The number of digits of floating-point numbers in output depends on the environment variable DIGITS:

```
print(float(PI)):
DIGITS := 20: print(float(PI)):
DIGITS := 30: print(float(PI)):
```

```
3.141592654
```

```
3.1415926535897932385
```

```
3.14159265358979323846264338328
```

```
delete old, DIGITS:
```

## Example 17

The output order of sets differs from the internal order of sets, which is returned by `op`:

```
s := {a, b, 1}:
s;
print(Plain, s):
op(s)
```

```
{1, a, b}
```

```
{1, a, b}
```

$a, b, 1$

The index operator `[]` can be used to access the elements of a set with respect to the output order:

```
s[1], s[2], s[3]
```

$1, a, b$

```
delete s:
```

### Example 18

The output of a domain (Symbolic Math Toolbox) is determined by its "Name" slot if it exists, and otherwise by its key:

```
T := newDomain("T");  
T;  
print(Plain, T):
```

$T$

```
T
```

```
T::Name := "domain T":  
T;  
print(Plain, T):
```

domain T

```
domain T
```

```
delete T:
```

### Example 19

It is sometimes desirable to combine strings with “pretty” expressions in an output. This is not possible via `expr2text`. On the other hand, an output with commas as separators

is usually regarded as ugly. The following dummy expression sequence on page 1-88 may be used to achieve the desired result. It uses the MuPAD internal function for standard operator output `builtin(1100, ...)`, with priority 20—the priority of `_exprseq`—and with an empty operator symbol "":

```
myexprseq := funcenv(myexprseq,
                    builtin(1100, 20, "", "myexprseq")):
print(Unquoted,
      myexprseq("String and pretty expression ", a^b, ".")):
```

```

                                     b
String and pretty expression a .
```

```
delete myexprseq:
```

## Example 20

If the option `Typeset` is combined with `Unquoted` or `NoNL`, a warning is given and `Typeset` is ignored:

```
print(Typeset, Unquoted, "1"):
```

```
Warning: Conflicting options, ignoring 'Typeset' [print]
```

## Example 21

For more elaborate constructions, you may want to combine multi-line strings with MuPAD expressions. A first attempt might look like the following:

```
myexprseq := funcenv(myexprseq,
                    builtin(1100, 20, "", "myexprseq")):
Example := newDomain("Example"):
Example::print :=
  x -> myexprseq("--- \n--\n-\n--\n---", op(x)):
e := new(Example, 1):
print(Plain, e):
```

```
"--- \n--\n-\n--\n---"1
```

Obviously, this approach doesn't work. The return value of the "print" method defined above is not a string, it's a (special) sequence, so the special rules for printing a string do

not apply. We would need another domain that simply takes a string and returns exactly this string from its "print" slot. Fortunately, MuPAD already has such a domain, `stdlib::Exposed`:

```
Example::print :=
  x -> myexprseq(stdlib::Exposed("--- \n--\n-\n--\n---"),
                op(x)):
print(e):
```

```
---
--
-  1
--
---
```

For expressions with a higher output, you see that the alignment of the string is constant:

```
new(Example,x^(1/n));
new(Example,x/y)
```

```
---
--  1/n
-   x
--
---
```

```
---
--  x
-   -
--  y
---
```

To change this alignment, replace a `\n` by `\b`, thereby making the line it terminates the "baseline" of the string:

```
Example::print :=
  x -> myexprseq(stdlib::Exposed("--- \b--\n-\n--\n---"),
                op(x)):
print(e+2):
```

```
--- 1 + 2
```

```
--
-
--
---
```

When multiple `\b` appear in a string, the first one is taken as defining the base line:

```
Example::print :=
  x -> myexprseq(stdlib::Exposed("--- \n--\n-\b--\b---"),
                 op(x)):
print(e+2):
```

```
---
--
- 1 + 2
--
---
```

## Parameters

**object1, object2, ...**

Any MuPAD objects

## Options

### Unquoted

With this option, character strings on page 7-53 are displayed without quotation marks. Moreover, the control characters `\n`, `\t`, and `\\` in strings are expanded into a new line, a tabulator skip, and a single backslash `\`, respectively. Cf. “Example 10” on page 1-1643 (Symbolic Math Toolbox).

The control character `\t` is expanded with tab-size 8. The following character is placed in the next column `i` with `i mod 8 = 0`.

`\b` is expanded into a newline, too, but when combining multiple strings, the last line with `\b` at its end is regarded as the “baseline”. Cf. “Example 21” on page 1-1649 (Symbolic Math Toolbox).

---

**Note** The option `Unquoted` implicitly sets the option `Plain`. If the option `Typeset` is used together with `Unquoted`, a warning is given and `Typeset` is ignored. Cf. “Example 20” on page 1-1649 (Symbolic Math Toolbox).

---

### **NoNL**

This option has the same functionality as `Unquoted`. In addition, the new line at the end of the output is suppressed. Cf. “Example 12” on page 1-1644 (Symbolic Math Toolbox).

Moreover, this option implicitly sets `PRETTYPRINT` to `FALSE`.

---

**Note** The option `NoNL` implicitly sets the option `Plain`. If the option `Typeset` is used together with `NoNL`, a warning is given and `Typeset` is ignored. Cf. “Example 20” on page 1-1649 (Symbolic Math Toolbox).

---

### **KeepOrder**

This option determines the order of terms in sums. Normally, the system sorts the terms of a sum such that a positive term is in the first position of the output. If `KeepOrder` is given, no such re-ordering takes place and sums are printed in the internal order. Cf. “Example 13” on page 1-1644 (Symbolic Math Toolbox).

This behavior can also be controlled via `Pref::keepOrder`. More precisely, the call `print(KeepOrder, ...)` generates the same output as the following command:

```
Pref::keepOrder(Always):  
print(...):  
Pref::keepOrder(%2):
```

### **Plain**

The output is in plain text mode. This is the default behavior in the terminal version. In text mode the value of `PRETTYPRINT` determines if the output is linear or in a more readable 2D form.

### **Typeset**

The output is in typesetting mode. This is the default print behavior in the notebook, if no other options are given. The option is only kept for backward compatibility.

In typesetting mode the value of PRETTYPRINT is ignored.

## Return Values

print returns the void object `null()` of type `DOM_NULL`.

## Overloaded By

`object1`, `object2`

## Algorithms

The output order of `sets` differs from the internal order of sets, which can be obtained via `op`. For this reordering in the output, the kernel calls the method `DOM_SET::sort`, which takes the set as argument and returns a sorted list. The elements of the set are then printed in the order given by this list.

## See Also

### MuPAD Domains

`DOM_FUNC_ENV`

### MuPAD Functions

`DIGITS` | `PrettyPrint` | `Pref::floatFormat` | `Pref::keepOrder` |  
`Pref::trailingZeroes` | `TEXTWIDTH` | `doprint` | `expose` | `expr2text` | `fininput` |  
`fprint` | `fread` | `funcenv` | `input` | `protocol` | `read` | `strprint` | `write`

**->--**

## **>procnameoptionlocalbeginend\_procprocname**

Define a procedure

### **Syntax**

```
( x1, x2, ... ) -> body
proc(
    x1 <= default1> <: type1>,
    x2 <= default2> <: type2>,
    ...
) <: returntype>
<name pname;>
<option option1, option2, ...>
<local local1, local2, ...>
<save global1, global2, ...>
begin
    body
end_proc
( x1, x2, ... ) --> body
_procdef(, ...)
```

### **Description**

`proc` - `end_proc` defines a procedure.

Procedures `f := proc(x1, x2, ...) ... end_proc` may be called like a system function in the form `f(x1, x2, ...)`. The return value of this call is the value of the last command executed in the procedure body (or the value returned by the body via the function return).

The procedure declaration `(x1, x2, ...) -> body` is equivalent to `proc(x1, x2, ...) begin body end_proc`. It is useful for defining *simple* procedures that do



not need local variables. E.g., `f := x -> x^2` defines the mathematical function  $f: x \rightarrow x^2$ . If the procedure uses more than one parameter, use brackets as in `f := (x, y) -> x^2 + y^2`. Cf. “Example 1” on page 1-1658 (Symbolic Math Toolbox).

The procedure declaration `(x1, x2, ...) -> body` is equivalent to `fp::unapply(body, x1, x2, ...)`. The difference from the other definitions is that `body` is *evaluated* before defining the procedure. Cf. “Example 2” on page 1-1658 (Symbolic Math Toolbox).

---

**Note** The evaluation of `body` must not contain references to parameters or local variables of an outer procedure.

---

A MuPAD procedure may have an arbitrary number of parameters. For each parameter, a default value may be specified. This value is used if no actual value is passed when the procedure is called. E.g.,

```
f := proc(x = 42) begin body end_proc
```

defines the default value of the parameter `x` to be 42. The call `f()` is equivalent to `f(42)`. Cf. “Example 3” on page 1-1659 (Symbolic Math Toolbox).

For each parameter, a type may be specified. This invokes an automatic type checking when the procedure is called. E.g.,

```
f := proc(x : DOM_INT) begin body end_proc
```

restricts the argument `x` to integer values. If the procedure is called with an argument of a wrong data type, the evaluation is aborted with an error message. Cf. “Example 4” on page 1-1660 (Symbolic Math Toolbox). Checking the input parameters should be a standard feature of every procedure. See Testing Arguments (Symbolic Math Toolbox).

Also an automatic type checking for the return value may be implemented specifying `returntype`. Cf. “Example 4” on page 1-1660 (Symbolic Math Toolbox).

With the keyword `name`, a name may be defined for the procedure, e.g.,

```
f := proc(...) name myName; begin body end_proc.
```

There is a special variable `procname` associated with a procedure which stores its name. When the body returns a symbolic call `procname(args())`, the actual name is

substituted. This is the name defined by the optional name entry. If no name entry is specified, the first identifier the procedure has been assigned to is used as the name, i.e., `f` in this case. Cf. “Example 5” on page 1-1661 (Symbolic Math Toolbox).

With the keyword `option`, special features may be specified for a procedure:

- `escape`

Must be used if the procedure creates and returns a new procedure which accesses local values of the enclosing procedure. Cf. “Example 6” on page 1-1662 (Symbolic Math Toolbox). This option should only be used if necessary. Also refer to `Pref::warnDeadProcEnv`.

- `hold`

Prevents the procedure from evaluating the actual parameters it is called with. See “Example 7” on page 1-1663 (Symbolic Math Toolbox).

- `noDebug`

Prevents the MuPAD source code debugger from entering this procedure. Also refer to `Pref::ignoreNoDebug`. Cf. “Example 8” on page 1-1663 (Symbolic Math Toolbox).

- `noFlatten`

Prevents flattening of sequences passed as arguments of the procedure. See “Example 9” on page 1-1664 (Symbolic Math Toolbox).

- `remember`

Instructs the procedure to store each computed result in a so-called remember table. When this procedure is called later with the same input parameters, the result is read from this table and needs not be computed again.

This may speed up, e.g., recursive procedures drastically. Cf. “Example 10” on page 1-1664 (Symbolic Math Toolbox). However, the remember table may grow large and use a lot of memory. Furthermore, the usefulness of this function is very limited in the light of properties (Symbolic Math Toolbox)—identification of “the same input parameters” does not depend on assumptions on identifiers or global variables such as `DIGITS` and `ORDER`, so the returned result may not be compatible with new assumptions. Use of `prog::remember` instead of this option is highly recommended for any function accepting symbolic input.

- `noExpose`

Instructs MuPAD to hide the procedure body from the user. Note that this prevents debugging the procedure, too. Cf. “Example 15” on page 1-1669 (Symbolic Math Toolbox).

With the keyword `local`, the local variables of the procedure are specified, e.g.,

```
f := proc(...) local x, y; begin body end_proc.
```

Cf. “Example 11” on page 1-1666 (Symbolic Math Toolbox).

Local variables cannot be used as “symbolic variables” (identifiers). They must be assigned values before they can be used in computations.

Note that the names of global MuPAD variables such `DIGITS`, `READPATH` etc. should not be used as local variables. Also refer to the keyword `save`.

With the keyword `save`, a local context for global MuPAD variables is created, e.g.,

```
f := proc(...) save DIGITS; begin DIGITS := newValue; ... end_proc.
```

This means that the values these variables have on entering the procedure are restored on exiting the procedure. This is true even if the procedure is exited because of an error. Cf. “Example 12” on page 1-1667 (Symbolic Math Toolbox).

One can define procedures that accept a variable number of arguments. E.g., one may declare the procedure without any formal parameters. Inside the body, the actual parameters the procedure is called with may be accessed via the function `args`. Cf. “Example 13” on page 1-1668 (Symbolic Math Toolbox).

Calling a procedure name `f`, say, usually does not print the source code of the body to the screen. Use `expose(f)` to see the body. Cf. “Example 14” on page 1-1669 (Symbolic Math Toolbox).

The environment variable `MAXDEPTH` limits the “nesting depth” of recursive procedure calls. The default value is `MAXDEPTH = 500`. Cf. “Example 10” on page 1-1664 (Symbolic Math Toolbox).

If a procedure is a domain (Symbolic Math Toolbox) slot on page 1-1980, the special variable `dom` contains the name of the domain the slot belongs to. If the procedure is not a domain slot, the value of `dom` is `NIL`.

Instead of `end_proc`, also the keyword `end` can be used.

The imperative declaration `proc - end_proc` internally results in a call of the kernel function `_procdef`. There is no need to call `_procdef` directly.

When evaluating a procedure, MuPAD parses the entire procedure first, and only then executes it. If you want to introduce a new syntax (for example, define a new operator), do it outside a procedure. See “Example 16” on page 1-1670 (Symbolic Math Toolbox).

## Examples

### Example 1

Simple procedures can be generated with the “arrow operator” `->`:

```
f := x -> x^2 + 2*x + 1:  
f(x), f(y), f(a + b), f(1.5)
```

$x^2 + 2x + 1, y^2 + 2y + 1, 2a + 2b + (a + b)^2 + 1, 6.25$

```
f := n -> isprime(n) and isprime(n + 2):  
f(i) $ i = 11..18
```

TRUE, FALSE, FALSE, FALSE, FALSE, FALSE, TRUE, FALSE

The following command maps an “anonymous” procedure to the elements of a list:

```
map([1, 2, 3, 4, 5, 6], x -> x^2)
```

[1, 4, 9, 16, 25, 36]

```
delete f:
```

### Example 2

The declaration of procedures with the “arrow operator” is a powerful tool. In some situations, however, it results in potentially unexpected results:

```
f := x -> sin(x^2)
```

$x \rightarrow \sin(x^2)$

`g := x -> f'(x)`

$x \rightarrow f'(x)$

The reason is simple: The body of a procedure definition is not evaluated at the time of definition. For those occasions where evaluation is desired, the long version of the arrow operator should be used:

`g := x --> f'(x)`

$x \rightarrow 2 x \cos(x^2)$

Of course, in this example, there is an even shorter way:

`g := f'`

$x \rightarrow 2 x \cos(x^2)$

### Example 3

The declaration of default values is demonstrated. The following procedure uses the default values if the procedure call does not provide all parameter values:

```
f := proc(x, y = 1, z = 2) begin [x, y, z] end_proc:
f(x, y, z), f(x, y), f(x)
```

`[x, y, z], [x, y, 2], [x, 1, 2]`

No default value was declared for the first argument. A warning is issued if this argument is missing:

`f()`

```
Warning: Uninitialized variable 'x' is used.  
Evaluating: f
```

```
[NIL, 1, 2]
```

```
delete f:
```

## Example 4

The automatic type checking of procedure arguments and return values is demonstrated. The following procedure accepts only positive integers on page 33-86 as argument:

```
f := proc(n : Type::PosInt) begin n! end_proc:
```

An error is raised if an unsuitable parameter is passed:

```
f(-1)
```

```
Error: Invalid object '-1'. Type of argument number 1 must be 'Type::PosInt'.  
Evaluating: f
```

```
Error: Wrong type of 1. argument (type 'Type::PosInt'  
expected, got argument '-1'); Evaluating: f
```

In the following procedure, automatic type checking of the return value is invoked:

```
f := proc(n : Type::PosInt) : Type::Integer  
begin  
  n/2  
end_proc:
```

An error is raised if the return value is not an integer:

```
f(3)
```

```
Error: Invalid return value '3/2'. It must be of type 'Type::Integer'.  
Evaluating: f
```

```
Error: Wrong type of return value (type 'Type::Integer'  
expected, value is '3/2'); Evaluating: f
```

delete f:

## Example 5

The name entry of procedures is demonstrated. A procedure returns a symbolic call to itself by using the variable `procname` that contains the current procedure name:

```
f := proc(x)
begin
  if testtype(x,Type::Numeric)
  then return(float(1/x))
  else return(procname(args()))
  end_if
end_proc:
f(x), f(x + 1), f(3), f(2*I)
```

*f(x), f(x + 1), 0.3333333333, -0.5 i*

Also error messages use this name:

f(0)

Error: Division by zero. [\_invert]  
Evaluating: f

If the procedure has a name entry, this entry is used:

```
f := proc(x)
name myName;
begin
  if testtype(x,Type::Numeric)
  then return(float(1/x))
  else return(procname(args()))
  end_if
end_proc:
f(x), f(x + 1), f(3), f(2*I)
```

*myName(x), myName(x + 1), 0.3333333333, -0.5 i*

f(0)

```
Error: Division by zero. [_invert]
  Evaluating: myName
```

```
delete f:
```

## Example 6

The option `escape` is demonstrated. This option must be used if the procedure returns another procedure that references a formal parameter or a local variable of the generating procedure:

```
f := proc(n)
begin
  proc(x) begin x^n end_proc
end_proc:
```

Without the option `escape`, the formal parameter `n` of `f` leaves its scope: `g := f(3)` references `n` internally. When `g` is called, it cannot evaluate `n` to the value 3 that `n` had inside the scope of the function `f`:

```
g := f(3): g(x)
```

```
Warning: Uninitialized variable 'unknown' is used.
  Evaluating: g
```

```
Error: Invalid operand. [_power]
  Evaluating: g
```

The option `escape` instructs the procedure `f` to deal with variables escaping the local scope. Now, the procedure `g := f(3)` references the value 3 rather than the formal parameter `n` of `f`, and `g` can be executed correctly:

```
f := proc(n)
option escape;
begin
  proc(x) begin x^n end_proc
end_proc:
g := f(3): g(x), g(y), g(10)
```

```
 $x^3, y^3, 1000$ 
```



```
delete f, g:
```

## Example 7

The option `hold` is demonstrated. With `hold`, the procedure sees the actual parameter in the form that was used in the procedure call. Without `hold`, the function only sees the value of the parameter:

```
f := proc(x) option hold; begin x end_proc:
g := proc(x) begin x end_proc:
x := PI/2:
f(sin(x) + 2) = g(sin(x) + 2), f(1/2 + 1/3) = g(1/2 + 1/3)
```

$$\sin(x) + 2 = 3, \frac{1}{2} + \frac{1}{3} = \frac{5}{6}$$

Procedures using `option hold` can evaluate the arguments with the function context:

```
f := proc(x) option hold; begin x = context(x) end_proc:
f(sin(x) + 2), f(1/2 + 1/3)
```

$$\sin(x) + 2 = 3, \frac{1}{2} + \frac{1}{3} = \frac{5}{6}$$

```
delete f, g, x:
```

## Example 8

The option `noDebug` is demonstrated. The `debug` command starts the debugger which steps inside the procedure `f`. After entering the debugger command `c` (continue), the debugger continues the evaluation:

```
f := proc(x) begin x end_proc: debug(f(42))

Activating debugger... #0 in f($1=42) at
/tmp/debug0.556:4 mdx> c Execution completed.
42
```

With the option `noDebug`, the debugger does not step into the procedure:

```
f := proc(x) option noDebug; begin x end_proc: debug(f(42))
```

```
Execution completed.  
42
```

```
delete f:
```

## Example 9

Create a procedure that accepts two arguments and returns a table containing the arguments:

```
f := proc(x, y) begin table(x = y) end_proc:
```

The parameters  $x$ ,  $y$  of the procedure  $f$  form a sequence. If you call this procedure for the sequence  $(a, b)$  and a variable  $c$ , MuPAD flattens the nested sequence  $((a, b), c)$  into  $(a, b, c)$ . The procedure  $f$  accepts only two arguments. Thus, it uses  $a$  and  $b$ , and ignores  $c$ :

```
f((a, b), c)
```

$$\overline{a|b}$$

When you use the `noFlatten` option, MuPAD does not flatten the arguments of the procedure:

```
g := proc(x, y) option noFlatten; begin table(x = y) end_proc:  
g((a, b), c)
```

$$\overline{a, b|c}$$

For further computations, delete  $f$  and  $g$ :

```
delete f, g:
```

## Example 10

The option `remember` is demonstrated. The `print` command inside the following procedure indicates if the procedure body is executed:

```
f := proc(n : Type::PosInt)  
option remember;
```

```
begin
  print("computing ".expr2text(n)."!");
  n!
end_proc:
f(5), f(10)
```

"computing 5!"

"computing 10!"

120, 3628800

When calling the procedure again, all values that were computed before are taken from the internal "remember table" without executing the procedure body again:

```
f(5)*f(10) + f(15)
```

"computing 15!"

1308109824000

option remember is used in the following procedure which computes the Fibonacci numbers on page 20-21  $F(0) = 0$ ,  $F(1) = 1$ ,  $F(n) = F(n - 1) + F(n - 2)$  recursively:

```
f := proc(n : Type::NonNegInt)
option remember;
begin
  if n = 0 or n = 1 then return(n) end_if;
  f(n - 1) + f(n - 2)
end_proc:
```

```
f(123)
```

22698374052006863956975682

Due to the recursive nature of f, the arguments are restricted by the maximal recursive depth (see MAXDEPTH):

```
f(1000)
```

```
Error: Recursive definition: Reached maximal depth for nested procedure calls.  
Evaluating: f
```

Without option remember, the recursion is rather slow:

```
f := proc(n : Type::NonNegInt)  
begin  
  if n = 0 or n = 1 then return(n) end_if;  
  f(n - 1) + f(n - 2)  
end_proc:  
f(28)
```

```
317811
```

```
delete f:
```

## Example 11

We demonstrate the use of local variables:

```
f := proc(a)  
local x, y;  
begin  
  x := a^2;  
  y := a^3;  
  print("x, y" = (x, y));  
  x + y  
end_proc:
```

The local variables  $x$  and  $y$  do not coincide with the global variables  $x, y$  outside the procedure. The call to  $f$  does not change the global values:

```
x := 0: y := 0: f(123), x, y
```

```
"x, y" = (15129, 1860867)
```

```
1875996, 0, 0
```

```
delete f, x, y;
```

## Example 12

The `save` declaration is demonstrated. The following procedure changes the environment variable `DIGITS` internally. Because of `save DIGITS`, the original value of `DIGITS` is restored after return from the procedure:

```
myfloat := proc(x, digits)
save DIGITS;
begin
  DIGITS := digits;
  float(x);
end_proc;
```

The current value of `DIGITS` is:

```
DIGITS
```

```
10
```

With the default setting `DIGITS = 10`, the following float conversion suffers from numerical cancellation. Due to the higher internal precision, `myfloat` produces a more accurate result:

```
x := 10^20*(PI - 21053343141/6701487259);
float(x), myfloat(x, 20)
```

```
0.0, 0.02616405487
```

The value of `DIGITS` was not changed by the call to `myfloat`:

```
DIGITS
```

```
10
```

The following procedure needs a global identifier, because local variables cannot be used as integration variables in the `int` function. Internally, the global identifier `x` is deleted to make sure that `x` does not have a value:

```
f := proc(n)
save x;
begin
  delete x;
  int(x^n*exp(-x), x = 0..1)
end_proc:
x := 3: f(1), f(2), f(3)
```

$1 - 2e^{-1}, 2 - 5e^{-1}, 6 - 16e^{-1}$

Because of `save x`, the previously assigned value of `x` is restored after the integration:

```
x
```

$3$

```
delete myfloat, x, f:
```

### Example 13

The following procedure accepts an arbitrary number of arguments. It accesses the actual parameters via `args`, puts them into a list, reverses the list via `revert`, and returns its arguments in reverse order:

```
f := proc()
local arguments;
begin
  arguments := [args()];
  op(revert(arguments))
end_proc:
f(a, b, c)
```

$c, b, a$

```
f(1, 2, 3, 4, 5, 6, 7)
```

$7, 6, 5, 4, 3, 2, 1$

```
delete f:
```

## Example 14

Use `expose` to see the source code of a procedure:

```
f := proc(x = 0, n : DOM_INT)
begin
  sourceCode;
end_proc
```

```
proc f(x, n) ... end
```

```
expose(f)
```

```
proc(x = 0, n : DOM_INT)
  name f;
begin
  sourceCode
end_proc
```

```
delete f:
```

## Example 15

The option `noExpose` prevents users from reading the definition of a procedure:

```
f := proc(a)
  option noExpose;
begin
  print(sin(a));
  if is(a>1)=TRUE then
    cos(a)
  else
    cos(a + 2)
  end_if
end_proc
```

```
proc f(a) ... end
```

```
f(x), f(0), f(3)

sin(x)

0

sin(3)

cos(x + 2), cos(2), cos(3)

expose(f)

proc(a)
  name f;
  option noDebug, noExpose;
begin
  /* Hidden */
end_proc
```

As you can see, setting option `noExpose` implicitly sets the option `noDebug`, too.

For more information on the intended use of this option, refer to the documentation of `write`.

## Example 16

When you evaluate a procedure, MuPAD parses the entire procedure, and only then executes it. Thus, you cannot define and use a new operator inside a procedure. For example, when MuPAD parses this procedure, it does not recognize the new operator `<<`. The reason is that the procedure is not executed yet, and therefore, the new operator is not defined:

```
f := proc(A, B)
begin
  bitshiftleft := (a, b) -> a * 2^b;
  operator("<<", bitshiftleft, Binary, 950):
```



```
C := A<<B;  
end_proc:
```

Error: Invalid input. Expected 'expression'. [line 6, col 10]

Define the operator << on the interactive level:

```
bitshiftleft := (a, b) -> a * 2^b;  
operator("<<", bitshiftleft, Binary, 950):
```

Now you can use << inside procedures on the interactive level:

```
f := proc(A, B)  
begin  
  C := A<<B;  
end_proc;  
f(2, 1)
```

4

```
m<<n
```

$2^n m$

## Parameters

$x_1, x_2, \dots$

The formal parameters of the procedure: identifiers

**default<sub>1</sub>, default<sub>2</sub>, ...**

Default values for the parameters: arbitrary MuPAD objects

**type<sub>1</sub>, type<sub>2</sub>, ...**

Admissible types for the parameters: type objects as accepted by the function `testtype`

**returntype**

Admissible type for the return value: a type object as accepted by the function `testtype`

**pname**

The name of the procedure: an expression

**option<sub>1</sub>, option<sub>2</sub>, ...**

Available options are: `escape`, `hold`, `noDebug`, `noExpose`, `noFlatten`, `remember`

**local<sub>1</sub>, local<sub>2</sub>, ...**

The local variables: identifiers

**global<sub>1</sub>, global<sub>2</sub>, ...**

Global variables: identifiers

**body**

The body of the procedure: an arbitrary sequence of statements

## Return Values

Procedure of type `DOM_PROC`.

## See Also

### MuPAD Functions

`MAXDEPTH` | `Pref::ignoreNoDebug` | `Pref::typeCheck` | `Pref::warnDeadProcEnv` | `args` | `context` | `debug` | `expose` | `fp::unapply` | `hold` | `newDomain` | `return` | `save` | `testargs`

# product

Definite and indefinite products

## Syntax

`product(f, i)`

`product(f, i = a .. b)`

`product(f, i = RootOf(p, <x>))`

`product(f, i in RootOf(p, <x>))`

`product(f, i in {x1, x2, ...})`

## Description

`product(f, i)` computes the indefinite product of  $f(i)$  with respect to  $i$ , i.e., a closed

form  $g$  such that  $\frac{g(i+1)}{g(i)} = f(i)$ .

`product(f, i = a .. b)` tries to find a closed form representation of the product

$$\prod_{i=a}^b f(i).$$

`product(f, i = RootOf(p, x))` computes the product of  $f(i)$  over the roots of the polynomial  $p$ .

`product(f, i in {x1, x2, ...})` computes the product  $\prod_{i \in \{x_1, x_2, \dots\}} f(i)$ .

`product` serves for simplifying *symbolic* products. It should *not* be used for multiplying a finite number of terms: if  $a$  and  $b$  are integers of type `DOM_INT`, the call `_mult(f $ i = a .. b)` is more efficient than `product(f, i = a .. b)`.

`product(f, i)` computes the indefinite product of  $f$  with respect to  $i$ . This is an

expression  $g$  such that  $f(i) = \frac{g(i+1)}{g(i)}$ .

It is implicitly assumed that `i` runs through integers only.

`product(f, i = a..b)` computes the definite product with `i` running from `a` to `b`. It is implicitly assumed that  $a \leq b$ ; it is an error if this is inconsistent.

`a` and `b` must not be numbers other than integers.

If `b - a` is an integer, the explicit product  $f(a)f(a + 1) \dots f(b)$  is returned if it has no more than 1000 factors.

`product(f, i = RootOf(p, x))` computes the definite product with `i` running through the roots of the polynomial `p` in `x` according to their multiplicity, i.e., the number of factors is equal to the degree of `p`.

The calls `product(f, i = RootOf(p, x))` and `product(f, i in RootOf(p, x))` are equivalent.

The system returns a symbolic `product` call if it cannot compute a closed form representation of the product.

## Examples

### Example 1

Each of the following two calls computes the product 1 2 3 4 5:

```
product(i, i = 1..5) = _mult(i $ i = 1..5)
```

```
120 = 120
```

However, using `_mult` is usually more efficient when the boundaries are integers of type `DOM_INT`.

There is a closed form of this definite product from 1 to `n`:

```
product(i, i = 1..n)
```

```
n!
```

Since the upper boundary is a symbolic identifier on page 7-29, `_mult` cannot handle this product:

```
_mult(i $ i = 1..n)
```

$$\_mult(i \$ i = 1..n)$$

The corresponding indefinite product is:

```
product(i, i)
```

$$\begin{cases} \Gamma(i) & \text{if } 1 \leq i \\ \frac{(-1)^i}{\Gamma(1-i)} & \text{if } i \leq -1 \end{cases}$$

The indefinite and the definite product of  $2i + 1$  are:

```
product(2*i + 1, i)
```

$$2^i \Gamma\left(i + \frac{1}{2}\right)$$

```
product(2*i + 1, i = 1..n)
```

$$\frac{1}{2^{n+1}} \frac{(2n+2)!}{(n+1)!}$$

The boundaries may be symbolic expressions or  $\pm\infty$  as well:

```
product(i^2/(i^2 - 1), i = 2..infinity)
```

$$2$$

The system cannot find closed forms of the following two products and returns symbolic product calls:

```
delete f: product(f(i), i)
```

$$\prod_i f(i)$$

```
product((1 + 2^(-i)), i = 1..infinity)
```

$$\prod_{i=1}^{\infty} \frac{2^i + 1}{2^i}$$

An approximation can be computed numerically via `float`:

```
float(%)
```

```
2.384231029
```

Alternatively, you can call `numeric::product` directly. This is usually more efficient, since it skips the symbolic computations performed by `product`:

```
numeric::product((1 + 2^(-i)), i = 1..infinity)
```

```
2.384231029
```

## Example 2

Some products over the roots of a polynomial:

```
product(1 + 1/x, x = RootOf(x^2 - 5*x + 6))
```

```
2
```

```
product(r+c, r = RootOf(x^3 + a*x^2 + b*x + c, x))
```

$$b c - c - a c^2 + c^3$$

The multiplicity of roots is taken into account:

```
product(x+2, x in RootOf(x^5))
```

32

MuPAD finds closed forms for products of rational expressions. In other cases, a symbolic call to `product` is returned:

```
product(sin(r), r = RootOf(x^2 - PI^2/4, x))
```

$$\prod_{k=1}^2 \sin\left(\text{RootOf}\left(x^2 - \frac{\pi^2}{4}, x, k\right)\right)$$

An approximation can be computed numerically via `float`:

```
float(%)
```

-1.0

### Example 3

Some products over elements of a set on page 7-50:

```
product(x+2, x in {2,4,8})
```

240

```
product(a*x, x in {3, b, 5})
```

 $15 a^3 b$ 

Identical objects appear only once in a set. Therefore, the second `a` in the following example has no effect on the result:

```
product(-x, x in {a,a,7,b})
```

 $-7 a b$

## Parameters

**f**

An arithmetical expression (Symbolic Math Toolbox) depending on **i**

**i**

The product index: an identifier on page 7-29 or indexed identifier on page 1-1017

**a, b**

The boundaries: arithmetical expressions (Symbolic Math Toolbox)

**p**

A polynomial expression (Symbolic Math Toolbox) in **x**

**x**

Indeterminate

## Return Values

arithmetical expression (Symbolic Math Toolbox).

## Algorithms

The product over the roots of a polynomial is computed via `polylib::resultant`.

## See Also

### MuPAD Functions

\* `|_mult| numeric::product| sum`



# protect

Protect an identifier

## Syntax

```
protect(x, <ProtectLevelError | ProtectLevelWarning | ProtectLevelNone>)
```

## Description

`protect(x)` protects the identifier `x`.

`protect(x, ProtectLevelError)` sets full write-protection for the identifier. Any subsequent attempt to assign a value to the identifier will lead to an error.

`protect(x, ProtectLevelWarning)` sets a “soft” protection. Any subsequent assignment to the identifier results in a warning message. However, the identifier will be assigned a value, anyway.

`protect(x)` is equivalent to `protect(x, ProtectLevelWarning)`.

`protect(x, ProtectLevelNone)` removes any protection from the identifier. This call is equivalent to `unprotect(x)`.

---

**Note** Overwriting protected identifiers such as the names of MuPAD functions may damage your current session.

---

## Examples

### Example 1

The following call protects the identifier `important` with the protection level “`ProtectLevelWarning`”:

```
protect(important, ProtectLevelWarning)
```

### ProtectLevelNone

The identifier can still be overwritten:

```
important := 1
```

```
Warning: Protected variable 'important' is overwritten. [_assign]
```

1

We protect the identifier with the level “ProtectLevelError”:

```
protect(important, ProtectLevelError)
```

### ProtectLevelWarning

Now, it is no longer possible to overwrite `important`:

```
important := 2
```

```
Error: Identifier 'important' is protected. [_assign]
```

The identifier keeps its previous value:

```
important
```

1

In order to overwrite this value, we must unprotect `important`:

```
protect(important, ProtectLevelNone)
```

### ProtectLevelError

```
important := 2
```

2

The identifier is protected again with the default level “ProtectLevelWarning”:

```
protect(important)
```

```
ProtectLevelNone
```

```
important := 1
```

```
Warning: Protected variable 'important' is overwritten. [_assign]
```

```
1
```

```
unprotect(important): delete important:
```

## Example 2

protect does not evaluate its first argument. Here the identifier x can still be overwritten, while its value - which is the identifier y - remains write protected:

```
protect(y, ProtectLevelError): x := y: protect(x): x := 1
```

```
Warning: Protected variable 'x' is overwritten. [_assign]
```

```
1
```

```
y := 2
```

```
Error: Identifier 'y' is protected. [_assign]
```

```
unprotect(x): unprotect(y): delete x, y:
```

## Parameters

**x**

An identifier on page 7-29

## Options

**ProtectLevelError, ProtectLevelNone, ProtectLevelWarning**

The level of protection to set. The default value is `ProtectLevelWarning`.

## Return Values

Previous protection level of `x`: either `ProtectLevelError` or `ProtectLevelWarning` or `ProtectLevelNone`.

## Algorithms

`protect` does not evaluate its first argument. This way identifiers can be protected that have been assigned a value.

Identifiers starting with a `#` are implicitly protected and cannot be assigned a value nor receive assumptions.

## See Also

**MuPAD Functions**

`:=` | `unprotect`

# protocol

Create a protocol of a session

## Syntax

```
protocol(filename | n, <InputOnly | OutputOnly>)
```

```
protocol()
```

## Description

`protocol(file)` starts a protocol of the current MuPAD terminal session.

`protocol()` stops the protocol.

`protocol` writes a protocol of input commands and corresponding MuPAD output of a terminal session to a text file.

When used from the MuPAD Notebook, `protocol` is disabled and raises an error.

The file may be specified directly by its name. This either creates a new file or overwrites an existing file. `protocol` opens and closes the file automatically.

If the filename ends in “.gz”, MuPAD will write a gzip-compressed text file.

If `WRITEPATH` does not have a value, `protocol` interprets the file name as a pathname relative to the “working directory.”

Note that the meaning of “working directory” depends on the operating system. On Microsoft Windows systems and on Mac OS X systems, the “working directory” is the folder where MuPAD is installed. On UNIX systems, it is the current working directory in which MuPAD was started; when started from a menu or desktop item, this is typically the user's home directory.

Also absolute path names are processed by `protocol`.

Alternatively, the file may be specified by a file descriptor `n`. In this case, the file must have been opened via `fopen(Text, filename, Write)` or `fopen(Text, filename,`

Append). This returns the file descriptor as an integer `n`. Note that `fopen(filename)` opens the file in read-only mode. A subsequent `protocol` command to this file causes an error.

The file is not closed automatically by `protocol()` and must be closed by a subsequent call to `fclose`.

A call of `protocol` without arguments terminates a running protocol and closes the corresponding file if it has been opened by `protocol`. Closing the protocol file with `fclose` also terminates the protocol.

If a new protocol is started while a protocol is running, then the old one is terminated and the corresponding file is closed.

## Environment Interactions

The function is sensitive to the environment variable `WRITEPATH`. If this variable has a value, then the protocol file is created in the corresponding directory. Otherwise, the file is created in the “current working directory.”

## Examples

### Example 1

We open a text file `test` in write mode with `fopen`:

```
n := fopen(Text, "test", Write):
```

A protocol is written into this file:

```
protocol(n):  
1 + 1, a/b;  
solve(x^2 = 2);  
protocol():  
fclose(n):
```

The file now has the following content:

```
1 + 1, a/b;
```

```

      a
2, -
      b
solve(x^2 = 2);

      1/2      1/2
{[x = 2  ], [x = - 2  ]}
protocol():

```

## Example 2

The protocol file is opened directly by `protocol`. Only input is protocolled:

```

protocol("test", InputOnly):
1 + 1, a/b;
solve(x^2 = 2);
protocol():

```

The file now has the following content:

```

1 + 1, a/b;
solve(x^2 = 2);
protocol():

```

## Example 3

The protocol file is opened directly by `protocol`. Only output is protocolled:

```

protocol("test", OutputOnly):
1 + 1, a/b;
solve(x^2 = 2);
protocol():

```

The file now has the following content:

```

      a
2, -
      b

```

$\{[x = 2^{1/2}], [x = -2^{1/2}]\}$

## Parameters

### **filename**

The name of a file: a character string on page 7-53

### **n**

A file descriptor provided by `fopen`: a positive integer

## Options

### **InputOnly**

Only input is protocolled

The protocol file only contains the input lines. All output is omitted.

### **OutputOnly**

Only output is protocolled

The protocol file only contains the output lines. All input is omitted.

## Return Values

Void object of type `DOM_NULL`.

## See Also

### **MuPAD Functions**

`READPATH` | `WRITEPATH` | `fclose` | `finput` | `fname` | `fopen` | `fprint` | `fread` |  
`ftextinput` | `pathname` | `print` | `read` | `write`



# psi

Digamma/polygamma function

## Syntax

`psi(x)`

`psi(x, n)`

## Description

`psi(x)` represents the digamma function, i.e., the logarithmic derivative  $\psi(x) = \frac{\Gamma'(x)}{\Gamma(x)}$  of the gamma function.

`psi(x, n)` represents the  $n$ -th polygamma function, i.e., the  $n$ -th derivative  $\psi^{(n)}(x)$ .

`psi(x, 0)` is equivalent to `psi(x)`.

The digamma/polygamma function is defined for all complex arguments  $x$  apart from the singular points  $0, -1, -2, \dots$

If  $x$  is a floating-point value, then a floating point value is returned.

Simplifications are implemented for rational numbers  $x$ . In particular, if  $x = \text{numer}(x)/k$  with denominators  $k = 1, 2, 3, 4$  or  $6$ , explicit results expressed in terms of EULER (Symbolic Math Toolbox), PI (Symbolic Math Toolbox), and  $\ln$  are returned. In general, for any rational  $x$  with  $|x| (n + 1) \leq 6$  `Pref::autoExpansionLimit() = 6000` (see `Pref::autoExpansionLimit`), the functional equation

$$\psi^{(n)}(x + 1) = \psi^{(n)}(x) + \frac{(-1)^n n!}{x^{n+1}}$$

is used to obtain a result with an argument  $x$  from the interval  $(0, 1]$ . Use `expand(psi(x, n))` to obtain such a shift of the argument for larger values of  $x$ .

Some explicit formulas are implemented including

$$\psi(1) = -\text{EULER}$$

$$\psi^{(n)}(1) = (-1)^{n+1} n! \zeta(n+1), n > 1$$

$$\psi\left(\frac{1}{2}\right) = -2 \ln(2) - \text{EULER}$$

$$\psi^{(n)}\left(\frac{1}{2}\right) = (-1)^{n+1} n! \left(2^{n+1} - 1\right) \zeta(n+1), n > 1$$

The special values  $\psi(\infty) = \infty$  and  $\psi^{(n)}(\infty) = 0$  for  $n > 0$  are implemented.

For all other arguments, a symbolic function call of `psi` is returned.

The float attribute of the digamma function `psi(x)` is a kernel function, i.e., floating-point evaluation is fast. The float attribute of the polygamma function `psi(x, n)` with  $n > 0$  is a library function. Note that `psi(float(x))` and `psi(float(x), n)` rather than `float(psi(x))` and `float(psi(x, n))` should be used for float evaluation because, for rational values of  $x$ , the computation of the symbolic result `psi(x)`, `psi(x, n)` may be costly. Further, the float evaluation of the symbolic result may be numerically unstable.

The `expand` attribute uses the functional equation

$$\psi^{(n)}(x+1) = \psi^{(n)}(x) + \frac{(-1)^n n!}{x^{n+1}}$$

the  $n$ th derivative of the reflection formula

$$\psi(-x) = \psi(x) + \frac{1}{x} + \pi \cot(\pi x)$$

and the Gauß multiplication formula for  $\psi^{(n)}(kx)$  when  $k$  is a positive integer, to rewrite `psi(x, n)`. For numerical  $x$ , the functional equation is used to shift the argument to the range  $0 < x < 1$ . Cf. examples “Example 3” on page 1-1690 (Symbolic Math Toolbox) and “Example 4” on page 1-1690 (Symbolic Math Toolbox).

## Environment Interactions

When called with a floating-point value  $x$ , the function is sensitive to the environment variable DIGITS which determines the numerical working precision.

## Examples

### Example 1

We demonstrate some calls with exact and symbolic input data:

```
psi(-3/2), psi(4, 1), psi(3/2, 2)
```

$$\frac{8}{3} - 2 \ln(2) - \text{EULER}, \frac{\pi^2}{6} - \frac{49}{36}, 16 - 14 \zeta(3)$$

```
psi(x + sqrt(2), 4), psi(infinity, 5)
```

$$\psi^{(4)}(x + \sqrt{2}), 0$$

Floating point values are computed for floating-point arguments:

```
psi(-5.2), psi(1.0, 3), psi(2.0 + 3.0*I, 10)
```

$$6.065773152, 6.493939402, 0.7526409593 - 2.299472238 i$$

### Example 2

psi is singular for nonpositive integers:

```
psi(-2)
```

```
Error: Singularity. [psi]
```

### Example 3

For positive integers and rational numbers  $x$  with denominators 2, 3, 4 and 6, respectively, the result is expressed in terms of EULER (Symbolic Math Toolbox), PI (Symbolic Math Toolbox), ln, and zeta if  $|x| (n + 1) \leq 6$   
Pref::autoExpansionLimit() = 6000:

```
Pref::autoExpansionLimit()
```

```
1000
```

```
psi(-5/2), psi(-3/2, 1), psi(13/3, 2), psi(11/6, 4)
```

$$\frac{46}{15} - 2 \ln(2) - \text{EULER}, \frac{\pi^2}{2} + \frac{40}{9}, \frac{75535713}{1372000} - \frac{4\sqrt{3}\pi^3}{9} - 26\zeta(3),$$
$$176\sqrt{3}\pi^5 - 90024\zeta(5) + \frac{186624}{3125}$$

For larger arguments, use `expand` to obtain such expressions:

```
psi(1001, 5)
```

```
 $\psi^{(5)}(1001)$ 
```

```
expand(%)
```

```
      6  
8 PI  
-----  
63  
  
- 133533.../1093808...
```

### Example 4

The functions `diff`, `expand`, `float`, `limit`, and `series` handle expressions involving `psi`:

```
diff(psi(x^2 + 1, 3), x), float(ln(3 + psi(sqrt(PI))))
```

$$2 x \psi^{(4)}(x^2 + 1), 1.183103343$$

```
expand(psi(2*x + 3, 2))
```

$$\frac{\psi''(x + \frac{1}{2})}{8} + \frac{2}{(2x + 1)^3} + \frac{2}{(2x + 2)^3} + \frac{1}{4x^3} + \frac{\psi''(x)}{8}$$

```
limit(x*psi(x), x = 0), limit(psi(x, 3), x = infinity)
```

$$-1, 0$$

```
series(psi(x), x = 0), series(psi(x, 3), x = infinity, 3)
```

$$-\frac{1}{x} - \text{EULER} + \frac{x \pi^2}{6} - x^2 \zeta(3) + \frac{x^3 \pi^4}{90} - x^4 \zeta(5) + O(x^5), \frac{2}{x^3} + \frac{3}{x^4} + \frac{2}{x^5} + O\left(\frac{1}{x^6}\right)$$

## Parameters

**x**

An arithmetical expression (Symbolic Math Toolbox)

**n**

A nonnegative integer

## Return Values

Arithmetical expression.

## Overloaded By

x

## See Also

### MuPAD Functions

beta | binomial | fact | gamma | harmonic | lngamma | zeta

# radsimp

Simplify radicals in arithmetical expressions

## Syntax

`radsimp(z)`

## Description

`radsimp(z)` tries to simplify the radicals in the expression `z`. The result is mathematically equivalent to `z`.

`radsimp` and `simplifyRadical` are equivalent.

## Examples

### Example 1

Simplify these constant expressions with square roots and higher order radicals:

```
radsimp(3*sqrt(7)/(sqrt(7) - 2)),
radsimp(sqrt(5 + 2*sqrt(6)));
radsimp(sqrt(5*sqrt(3) + 6*sqrt(2))),
radsimp(sqrt(3 + 2*sqrt(2)))
```

$$2\sqrt{7} + 7, \sqrt{2} + \sqrt{3}$$

$$\sqrt{2} 3^{1/4} + 3^{3/4}, \sqrt{2} + 1$$

```
radsimp((1/2 + 1/4*3^(1/2))^(1/2))
```

$$\frac{\sqrt{2}}{4} + \frac{\sqrt{6}}{4}$$

```
radsimp((5^(1/3) - 4^(1/3))^(1/2))
```

$$\frac{2^{2/3} 5^{1/3}}{3} + \frac{2^{1/3}}{3} - \frac{5^{2/3}}{3}$$

```
radsimp(sqrt(3*sqrt(3 + 2*sqrt(5 - 12*sqrt(3 - 2*sqrt(2))))
+ 14))
```

$$\sqrt{2} + 3$$

```
radsimp(2*2^(1/4) + 2^(3/4) - (6*2^(1/2) + 8)^(1/2))
```

$$0$$

```
radsimp(sqrt(1 + sqrt(3)) + sqrt(3 + 3*sqrt(3))
- sqrt(10 + 6*sqrt(3)))
```

$$0$$

## Example 2

Create the following expression and then simplify it using `radsimp`:

```
x := sqrt(3)*I/2 + 1/2; y := x^(1/3) + x^(-1/3); z := y^3 - 3*y
```

$$-\frac{3}{\left(\frac{1}{2} + \frac{\sqrt{3}i}{2}\right)^{1/3}} - 3 \left(\frac{1}{2} + \frac{\sqrt{3}i}{2}\right)^{1/3} + \left(\frac{1}{\left(\frac{1}{2} + \frac{\sqrt{3}i}{2}\right)^{1/3}} + \left(\frac{1}{2} + \frac{\sqrt{3}i}{2}\right)^{1/3}\right)^3$$

```
radsimp(z)
```

$$1$$

```
delete x, y, z;
```



### Example 3

Use `radsimp` to simplify these arithmetical expressions containing variables:

```
z := x/(sqrt(3) - 1) - x/2
```

$$\frac{x}{\sqrt{3}-1} - \frac{x}{2}$$

```
radsimp(z) = expand(radsimp(z))
```

$$x \left( \frac{\sqrt{3}}{2} + \frac{1}{2} \right) - \frac{x}{2} = \frac{\sqrt{3} x}{2}$$

```
delete z:
```

### Example 4

Use `radsimp` to simplify nested radicals. When simplifying nested radicals, `radsimp` tries to reduce the nesting depth:

```
radsimp((6*2^(1/2) + 8)^(1/2));
radsimp(((32/5)^(1/5) - (27/5)^(1/5))^(1/3));
radsimp(sqrt((3+2^(1/3))^(1/2) * (4-2^(1/3))^(1/2)))
```

$$2 \cdot 2^{1/4} + 2^{3/4}$$

$$\frac{5^{3/5} \left( 3^{1/5} - 3^{2/5} + 1 \right)}{5}$$

$$\left( 2^{1/3} - 2^{2/3} + 12 \right)^{1/4}$$

## Parameters

**z**

An arithmetical expression (Symbolic Math Toolbox)

## Return Values

Arithmetical expression.

## References

Borodin A., Fagin R., Hopcroft J.E., and Tompa M.: Decreasing the Nesting Depth of Expressions Involving Square Roots, JSC 1, 1985, pp. 169-188.

## See Also

### **MuPAD Functions**

`combine` | `ifactor` | `normal` | `rectform` | `simplify` | `simplifyRadical`

## Topics

“Manipulate Expressions” (Symbolic Math Toolbox)

“Choose Simplification Functions” (Symbolic Math Toolbox)

# simplifyRadical

Simplify radicals in arithmetical expressions

## Syntax

`simplifyRadical(z)`

## Description

`simplifyRadical(z)` tries to simplify the radicals in the expression  $z$ . The result is mathematically equivalent to  $z$ .

`radsimp` and `simplifyRadical` are equivalent.

## Examples

### Example 1

Simplify these constant expressions with square roots and higher order radicals:

```
simplifyRadical(3*sqrt(7)/(sqrt(7) - 2)),
simplifyRadical(sqrt(5 + 2*sqrt(6)));
simplifyRadical(sqrt(5*sqrt(3) + 6*sqrt(2))),
simplifyRadical(sqrt(3 + 2*sqrt(2)))
```

$$2\sqrt{7} + 7, \sqrt{2} + \sqrt{3}$$

$$\sqrt{2} 3^{1/4} + 3^{3/4}, \sqrt{2} + 1$$

```
simplifyRadical((1/2 + 1/4*3^(1/2))^(1/2))
```

$$\frac{\sqrt{2}}{4} + \frac{\sqrt{6}}{4}$$

```
simplifyRadical((5^(1/3) - 4^(1/3))^(1/2))
```

$$\frac{2^{2/3} 5^{1/3}}{3} + \frac{2^{1/3}}{3} - \frac{5^{2/3}}{3}$$

```
simplifyRadical(sqrt(3*sqrt(3 + 2*sqrt(5 - 12*sqrt(3 - 2*sqrt(2))))
+ 14))
```

$$\sqrt{2} + 3$$

```
simplifyRadical(2*2^(1/4) + 2^(3/4) - (6*2^(1/2) + 8)^(1/2))
```

$$0$$

```
simplifyRadical(sqrt(1 + sqrt(3)) + sqrt(3 + 3*sqrt(3))
- sqrt(10 + 6*sqrt(3)))
```

$$0$$

## Example 2

Create the following expression and then simplify it using `simplifyRadical`:

```
x := sqrt(3)*I/2 + 1/2: y := x^(1/3) + x^(-1/3): z := y^3 - 3*y
```

$$-\frac{3}{\left(\frac{1}{2} + \frac{\sqrt{3}i}{2}\right)^{1/3}} - 3 \left(\frac{1}{2} + \frac{\sqrt{3}i}{2}\right)^{1/3} + \left(\frac{1}{\left(\frac{1}{2} + \frac{\sqrt{3}i}{2}\right)^{1/3}} + \left(\frac{1}{2} + \frac{\sqrt{3}i}{2}\right)^{1/3}\right)^3$$

```
simplifyRadical(z)
```

$$1$$

```
delete x, y, z:
```

### Example 3

Use `simplifyRadical` to simplify these arithmetical expressions containing variables:

```
z := x/(sqrt(3) - 1) - x/2
```

$$\frac{x}{\sqrt{3}-1} - \frac{x}{2}$$

```
simplifyRadical(z) = expand(radsimp(z))
```

$$x \left( \frac{\sqrt{3}}{2} + \frac{1}{2} \right) - \frac{x}{2} = \frac{\sqrt{3}x}{2}$$

```
delete z:
```

### Example 4

Use `simplifyRadical` to simplify nested radicals. When simplifying nested radicals, `simplifyRadical` tries to reduce the nesting depth:

```
simplifyRadical((6*2^(1/2) + 8)^(1/2));
simplifyRadical(((32/5)^(1/5) - (27/5)^(1/5))^(1/3));
simplifyRadical(sqrt((3+2^(1/3))^(1/2) * (4-2^(1/3))^(1/2)))
```

$$2 \cdot 2^{1/4} + 2^{3/4}$$

$$\frac{5^{3/5} \left( 3^{1/5} - 3^{2/5} + 1 \right)}{5}$$

$$\left( 2^{1/3} - 2^{2/3} + 12 \right)^{1/4}$$

## Parameters

**z**

An arithmetical expression (Symbolic Math Toolbox)

## Return Values

Arithmetical expression.

## Algorithms

For constant algebraic expressions, `simplifyRadical` constructs a tower of algebraic extensions of  $\mathbb{Q}$  using the domain `Dom::AlgebraicExtension`. It tries to return the simplest possible form.

This function is based on an algorithm described in Borodin, Fagin, Hopcroft and Tompa, "Decreasing the Nesting Depth of Expressions Involving Square Roots", JSC 1, 1985, pp. 169-188. In some special cases, an algorithm based on Landau, "How to tangle with a nested radical", The Mathematical Intelligencer 16, 1994, no. 2, pp. 49-55, is used.

## See Also

### MuPAD Functions

`combine` | `ifactor` | `normal` | `radsimp` | `rectform` | `simplify`

## Topics

"Manipulate Expressions" (Symbolic Math Toolbox)

"Choose Simplification Functions" (Symbolic Math Toolbox)

# random

Generate random integer numbers

## Syntax

`random()`

`random( $n_1$  ..  $n_2$ )`

`random( $n$ )`

## Description

`random()` returns a random integer number between 0 and  $10^{12}$ .

`random( $n_1$  ..  $n_2$ )` returns a procedure that generates random integers between  $n_1$  and  $n_2$ .

The calls `random()` return uniformly distributed random integers between 0 and 999999999988 (approximately  $10^{12}$ ).

`r := random( $n_1$  ..  $n_2$ )` produces a random number generator  $r$ . Subsequent calls `r()` generate uniformly distributed random integers between  $n_1$  and  $n_2$ .

`random( $n$ )` is equivalent to `random(0 ..  $n$  - 1)`.

The global variable `SEED` is used for initializing or changing the sequence of random numbers. It may be assigned any *non-zero* integer. The value of `SEED` fixes the sequence of random numbers. This may be used to reset random generators and reproduce random sequences.

`SEED` is set to a default value when MuPAD is initialized. Thus, each time MuPAD is started or re-initialized with the `reset` function, the random generators produce the same sequence of numbers.

To get a non-predictable initial value, make it dependent on the current time. See "Example 5" on page 1-1704 (Symbolic Math Toolbox).

Several random generators produced by `random` may run simultaneously. All generators make use of the same global variable `SEED`.

For producing uniformly distributed floating-points numbers, it is recommended to use the faster function `frandom` instead. The `stats` (Symbolic Math Toolbox) library provides random generators with various other distributions. Cf. “Example 4” on page 1-1704 (Symbolic Math Toolbox).

## Environment Interactions

`random` as well as the random number generators created by it are sensitive to the environment variable `SEED`.

`random` and the random number generators created by it change the environment variable `SEED` on each call.

## Examples

### Example 1

The following call produces a sequence of random integers. Note that an index variable `i` must be used in the construction of the sequence. A call such as `random() $8` would produce 8 copies of the same random value:

```
random() $ i = 1..8
```

```
427419669081, 321110693270, 343633073697, 474256143563, 558458718976,  
746753830538, 32062222085, 722974121768
```

The following call produces a “die” that is rolled 20 times:

```
die := random(1..6): die() $ i = 1..20
```

```
2, 2, 2, 4, 4, 3, 3, 2, 1, 4, 4, 6, 1, 1, 1, 2, 4, 2, 1, 3
```

The following call produces a “coin” that produces “head” or “tail”:



```
coin := random(2): coin() $ i = 1..10
```

```
1, 0, 1, 1, 0, 1, 0, 1, 0, 0
```

```
subs(%, [0 = head, 1 = tail])
```

```
tail, head, tail, tail, head, tail, head, tail, head, head
```

```
delete dice, coin:
```

## Example 2

random is sensitive to the global variable SEED which is set and reset when MuPAD is (re-)initialized. The seed may also be set by the user. Random sequences can be reproduced by starting with a fixed SEED:

```
SEED := 1: random() $ i = 1..4
```

```
427419669081, 321110693270, 343633073697, 474256143563
```

```
SEED := 1: random() $ i = 1..4
```

```
427419669081, 321110693270, 343633073697, 474256143563
```

## Example 3

random allows you to create several random number generators for different ranges of numbers, and to use them simultaneously:

```
r1 := random(0..4): r2 := random(2..9): [r1(), r2()] $ i = 1..6
```

```
[1, 4], [0, 2], [1, 3], [0, 5], [2, 2], [4, 7]
```

```
delete r1, r2:
```

## Example 4

`random` can be used to build a random generator for uniformly distributed floating-point numbers. The following generator produces such numbers between `-1.0` and `1.0`:

```
r := float@random(-10^DIGITS..10^DIGITS)/10^DIGITS:  
r() $ i = 1..12;
```

```
0.2920457876, 0.3747019439, -0.5968604725, -0.9375052697,  
0.1053530039, -0.3513692809, 0.5590763459, -0.0607326312, -0.4571489053,  
0.2600608968, 0.9760099364, 0.5982933733
```

However, it is strongly recommended to use the much more efficient functions `frandom` or `stats::uniformRandom` instead:

```
r := stats::uniformRandom(-1, 1, Seed = 10^10):  
r() $ i = 1..12
```

```
-0.5438091778, 0.1842867446, -0.9859463167, -0.6071964914, -0.8190627066,  
-0.4262015812, 0.978028969, 0.4404626935, 0.05402948609,  
0.3740704365, -0.2952265339, -0.06597080227
```

```
delete r;
```

## Example 5

Usually, `random` is used to generate experimental input or “random” examples. In these cases, reproducibility is a good thing. However, on occasion a “more random” sequence is desirable. The usual way to get a random seed in a program is to use the current system time:

```
SEED := round(1e10*frandom(CurrentTime)())
```

```
1035804049
```

```
random(), random()
```

```
861209862222, 269921735546
```

## Parameters

$n_1, n_2$

Integers with  $n_1 < n_2$

$n$

A positive integer

## Return Values

`random()` returns a nonnegative integer. The calls `random(n1..n2)` and `random(n)` return a procedure of type `DOM_PROC`.

## Algorithms

`random` implements a linear congruence generator. The sequence of pseudo-random numbers generated by calling `random()` over and over again is  $f(x), f(f(x)), \dots$ , where  $x$  is the initial value of `SEED` and  $f$  is the function mapping  $x$  to  $a x \bmod m$  with suitable integer constants  $a$  and  $m$ .

## See Also

### MuPAD Functions

`random` | `stats::uniformRandom`

# rationalize

Transform an expression into a rational expression

## Syntax

```
rationalize(object, options)
```

## Description

`rationalize(object)` transforms the expression `object` into an equivalent rational expression by replacing non-rational subexpressions by newly generated variables.

By default, a rational expression is an expression that contains only sums, products, powers with integer exponents, integers, rational numbers, and identifiers as subexpressions.

The `rationalize` function returns a sequence `(rat, subsSet)`. The rationalized expression `rat` contains new variables. The set of substitutions `subsSet` expresses the new variables by the old ones.

If the original expression contains subexpressions, the `rationalize` function can rationalize or replace subexpressions or keep them in their original form. Use the options `DescendInto`, `ReplaceType`, and `StopOn` to control the action `rationalize` takes for particular types of subexpressions.

If `FindRelations = ["exp", "_power", "sin"]`, the `rationalize` function detects maximal number of algebraic dependencies.

If you call `rationalize` with any combination of the following three contradicting options, the function chooses the option using the following priorities: `ReplaceType`, `StopOn`, `DescendInto`. For example, if you specify the same type of subexpression with `StopOn` and `DescendInto`, the `rationalize` function uses only the `StopOn` option for subexpressions of the specified type. If you combine any of these options with the `ReplaceType` option, `rationalize` uses only the `ReplaceType` option.

## Examples

### Example 1

rationalize operates on single arithmetical expressions, lists, and sets of expressions:

```
rationalize(2*sqrt(3) + 0.5*x^3)
```

$$X4 x^3 + 2 X3, \{X3 = \sqrt{3}, X4 = 0.5\}$$

```
rationalize([(x - sqrt(2))*(x^2 + sqrt(3)),
             (x - sqrt(2))*(x - sqrt(3))])
```

$$[-(X5 - x)(x^2 + X6), (X5 - x)(X6 - x)], \{X5 = \sqrt{2}, X6 = \sqrt{3}\}$$

### Example 2

Use the ApproximateFloats option to replace all floating-point numbers with rational numbers:

```
rationalize([0.4, 0.333, 0.74], ApproximateFloats)
```

$$\left[\frac{2}{5}, \frac{333}{1000}, \frac{37}{50}\right], \emptyset$$

If you use both ApproximateFloats and ReplaceTypes options, ApproximateFloats does not apply to the types of subexpressions specified in ReplaceTypes:

```
rationalize(0.4*x^2 + sin(0.33/x),
            ApproximateFloats,
            ReplaceTypes={DOM_FLOAT})
```

$$X8 x^2 + X9, \left\{X7 = 0.33, X8 = 0.4, X9 = \sin\left(\frac{0.33}{x}\right)\right\}$$

Instead of specifying the value of ReplaceTypes as a sequence of types, you can specify it as a function. The function must return TRUE or FALSE as a result. For example,

rationalize the same expression  $0.4x^2 + \sin\left(\frac{0.33}{x}\right)$ . This time, use the function F to specify the type of subexpressions which you want to replace by variables:

```
F := X -> testtype(X, DOM_FLOAT):
rationalize(0.4*x^2 + sin(0.33/x),
           ApproximateFloats,
           ReplaceTypes = F)
```

$$X11 x^2 + X12, \left\{ X10 = 0.33, X11 = 0.4, X12 = \sin\left(\frac{0.33}{x}\right) \right\}$$

### Example 3

By default, `rationalize` rationalizes sums, products, bases of integer powers, lists, and sets:

```
rationalize(ln(sin(x)^2 + cos(x)*exp(x)))
```

$$X13, \left\{ X13 = \ln(\sin(x)^2 + e^x \cos(x)) \right\}$$

The `DescendInto` option lets you specify the types of subexpressions that you want to rationalize. Each type can be a domain type, a string as returned by the function `type` or a Type (Symbolic Math Toolbox) object. Note that `DescendInto` overwrites the default types with the types that you specify:

```
rationalize(ln(sin(x)^2 + cos(x)*exp(x)), DescendInto = {"ln"})
```

$$\ln(X14), \left\{ X14 = \sin(x)^2 + e^x \cos(x) \right\}$$

If you want to add new types of subexpressions to the default ones, define the value of `DescendInto` as a procedure that specifies all required types explicitly. The procedure must return `TRUE` or `FALSE`:

```
F := proc(X)
begin
  hastype(X, {"_plus", "_mult", DOM_SET, DOM_LIST, "ln"}) or
  (hastype(X, "_power") and hastype(op(X, 2), DOM_INT))
end:
```

```
rationalize(ln(sin(x)^2 + cos(x)*exp(x)), DescendInto = F)
```

$$\ln(X17^2 + X15 X16), \{X16 = \cos(x), X15 = e^x, X17 = \sin(x)\}$$

### Example 4

Use the `MinimalPolynomials` option to find minimal polynomials of irrational expressions:

```
rationalize(x^(7/6) + x^(3/2), MinimalPolynomials)
```

$$X18 + X19, \{X18 = x^{3/2}, X19 = x^{7/6}\}, \{X18^2 - x^3, X19^6 - x^7\}$$

### Example 5

Use `Prefix = s`, where `s` is a string, to specify the prefix for generated variables (the default prefix is `X`):

```
rationalize(x^(7/6) + x^(3/2), Prefix = "ABC")
```

$$ABC1 + ABC2, \{ABC1 = x^{3/2}, ABC2 = x^{7/6}\}$$

### Example 6

Use the `ReplaceHardToEval` option to replace limits, sums, and integrals with generated variables. Expressions with limits, sums, and integrals tend to be the most computationally expensive:

```
rationalize(sum(exp(x)/(x^2 + 1), x) +
            limit(sin(cos(1/x))*cos(1/x), x),
            ReplaceHardToEval)
```

$$X46 + X47, \left\{ X46 = \lim_{x \rightarrow 0} \cos\left(\frac{1}{x}\right) \sin\left(\cos\left(\frac{1}{x}\right)\right), X47 = \sum_x \frac{e^x}{x^2 + 1} \right\}$$

## Example 7

By default, `rationalize` avoids rationalization of integers, rational numbers, and identifiers:

```
rationalize(2*sqrt(3) + 0.5*x^3)
```

$$X49 x^3 + 2 X48, \{X48 = \sqrt{3}, X49 = 0.5\}$$

The `DescendInto` option lets you avoid rationalization of particular types of subexpressions. Each type can be specified as a domain type, a string as returned by the function `type`, or a `Type` (Symbolic Math Toolbox) object. For example, rationalize the same expression leaving the subexpression `x^3` (of the type `"_power"`) unchanged:

```
rationalize(2*sqrt(3) + 0.5*x^3, StopOn = {"_power"})
```

$$X51 x^3 + \sqrt{3} X50, \{X50 = 2, X51 = 0.5\}$$

Rationalize the same expression including all subexpressions. Keep floating-point numbers, integers, and identifiers (do not replace them with generated variables):

```
rationalize(2*sqrt(3) + 0.5*x^3,  
           StopOn = {DOM_FLOAT, DOM_INT, DOM_IDENTITY})
```

$$0.5 x^3 + 2 X52, \{X52 = \sqrt{3}\}$$

Note that `StopOn` overwrites the default types with the types that you specify. If you want to add new types of subexpressions to the default ones, specify all the types explicitly:

```
rationalize(2*sqrt(3) + 0.5*x^3,  
           StopOn = {DOM_INT, DOM_IDENTITY, DOM_RAT, DOM_FLOAT})
```

$$0.5 x^3 + 2 X53, \{X53 = \sqrt{3}\}$$

```
rationalize(2*sqrt(3) + 0.5*x^3,  
           StopOn = {DOM_INT, DOM_IDENTITY,  
                    DOM_RAT, DOM_FLOAT,  
                    "_power"})
```



$$0.5 x^3 + 2 \sqrt{3}, \emptyset$$

The `StopOn` option also can accept a function as its value. The function must return `TRUE` or `FALSE`. For example, use generated variables to replace only subexpressions that contain `sin`. Keep all other subexpressions intact:

```
F := X -> not hastype(X, "sin");
rationalize(sin(x^2) + x^3 + exp(x) + 1/x, StopOn = F)
```

$$X54 + e^x + \frac{1}{x} + x^3, \{X54 = \sin(x^2)\}$$

## Example 8

Use the `FindRelations` option to detect algebraic dependencies between exponentials:

```
rationalize(exp(x/2) + exp(x/3), FindRelations = ["exp"])
```

$$X61^3 + X61^2, \{X61 = e^{\frac{x}{6}}\}$$

Detect algebraic dependencies for different powers of the same base by specifying the type `"_power"`:

```
rationalize(x^(3/2) + x^(7/4), FindRelations = ["_power"])
```

$$X65^7 + X65^6, \{X65 = x^{1/4}\}$$

Detect algebraic dependencies for trigonometric functions by specifying the type `"sin"` or `"cos"`:

```
rationalize(sin(x) + cos(x), FindRelations = ["sin"]);
rationalize(sin(x)^3 + cos(x)^3, FindRelations = ["cos"])
```

$$\frac{2 X68}{X68^2 + 1} - \frac{X68^2 - 1}{X68^2 + 1}, \{X68 = \tan\left(\frac{x}{2}\right)\}$$

$$\frac{8 X71^3}{(X71^2 + 1)^3} - \frac{(X71^2 - 1)^3}{(X71^2 + 1)^3}, \{X71 = \tan\left(\frac{x}{2}\right)\}$$

## Example 9

For nested exponentials, use the `Recursive` option to obtain a list of substitutions:

```
rationalize(exp(exp(x)), FindRelations = ["exp"], Recursive)
```

$$X72, [X72 = e^{X75}, X75 = e^x]$$

The option also works for trigonometric functions:

```
rationalize(sin(sin(x)), FindRelations = ["sin"], Recursive)
```

$$X76, [X76 = \sin(X77), X77 = \sin(x)]$$

## Example 10

The `ShowDependencies` option shows all original variables upon which each generated variable depends:

```
rationalize(sin(x)^3, ShowDependencies)
```

$$X78(x)^3, \{X78(x) = \sin(x)\}$$

## Parameters

### object

Any MuPAD object

## Options

### ApproximateFloats

When you use the `ApproximateFloats` option, the `rationalize` function replaces floating-point numbers with rational numbers. By default, `ApproximateFloats=FALSE`: the `rationalize` function replaces all floating-point numbers with the new variables. If you rationalize an expression using both `ApproximateFloats` and `StopOn` options, `StopOn` does not prevent rationalization of floating-point numbers in the specified subexpressions. If you rationalize an expression using both `ApproximateFloats` and `ReplaceTypes` options, `ApproximateFloats` does not apply to the types of subexpressions specified in `ReplaceTypes`. See “Example 2” on page 1-1707 (Symbolic Math Toolbox).

### DescendInto

When you use the `DescendInto` option, the `rationalize` function rationalizes all subexpressions of the specified types. You can specify the value of this option as a set (even if there is only one type) or a procedure that returns `TRUE` or `FALSE`. Each type can be

- A domain type (such as `DOM_INT`, `DOM_EXPR`, and so on)
- A string as returned by the function `type` (such as `"_plus"`, `"_mult"`, `"sin"`, and so on)
- A Type (Symbolic Math Toolbox) object (`Type::Boolean`, `Type::Equation`, and so on)

By default, the `rationalize` function rationalizes the following types of subexpressions: sums, products, bases of integer powers, lists, and sets. When you specify other types of subexpressions, `rationalize` uses them instead of the default types. (`DescendInto` overwrites the default types with the types that you specify.) If you want to extend the set of types of subexpressions retaining the default types, define the value of `DescendInto` as a procedure that specifies all default and additional types explicitly. See “Example 3” on page 1-1708 (Symbolic Math Toolbox).

### FindRelations

When you use the `FindRelations` option, the `rationalize` function detects algebraic dependencies for subexpressions of specified types. This option accepts the types of subexpressions in the form of a list. The following types are available: `"sin"`, `"cos"`,

"exp", and "\_power". By default, `rationalize` does not look for dependencies for irrational subexpressions: `FindRelations= []`.

### **MinimalPolynomials**

When you use the `MinimalPolynomials` option, the `rationalize` function returns the minimal polynomials of irrational expressions. The function returns the rationalized expression, the set of substitution equations, and minimal polynomials. By default, `MinimalPolynomials= FALSE`. See "Example 4" on page 1-1709 (Symbolic Math Toolbox).

### **Prefix**

Use the `Prefix` option to specify the prefix for new variables generated by the `rationalize` function. The value of this option must be a string. By default, `Prefix= "X"`. See "Example 5" on page 1-1709 (Symbolic Math Toolbox).

### **Recursive**

When you use the `Recursive` option, the `rationalize` function recursively rationalizes nested subexpressions, and returns a list of substitution equations. Each generated variable in the returned list can depend on other variables in the list. By default, `Recursive= FALSE`. See "Example 9" on page 1-1712 (Symbolic Math Toolbox).

### **ReplaceHardToEval**

When you use the `ReplaceHardToEval` option, the `rationalize` function replaces all limits, sums, and integrals by generated variables. Generally, this option allows you to avoid most expensive rationalizations of sums, limits, and integrals. By default, `ReplaceHardToEval= FALSE`. See "Example 6" on page 1-1709 (Symbolic Math Toolbox).

### **ReplaceTypes**

When you use the `ReplaceTypes` option, the `rationalize` function replaces all subexpressions of the specified types with generated variables. You can specify the value of this option as a set (even if there is only one type) or a procedure that returns `TRUE` or `FALSE`. Each type can be

- A domain type (such as `DOM_INT`, `DOM_EXPR`, and so on)
- A string as returned by the function `type` (such as `"_plus"`, `"_mult"`, `"sin"`, and so on)

- A Type (Symbolic Math Toolbox) object (Type::Boolean, Type::Equation, and so on)

This option allows you to specify and avoid most expensive rationalizations for your particular expression. If you use this option in combination with `ReplaceHardToEval`, the `rationalize` function uses generated variables to replace all limits, sums, integrals, and the types that you specify. If `ReplaceTypes` specifies the same type of subexpression as `DescendInto`, the `ReplaceTypes` option prevails. By default, `ReplaceTypes = {}`.

Alternatively, specify the value of this option as a function that returns TRUE or FALSE. See “Example 2” on page 1-1707 (Symbolic Math Toolbox).

### ShowDependencies

When you use the `ShowDependencies` option, the `rationalize` function replaces any irrational subexpression containing the identifiers `vars` with an expression of the form `newvar(vars)`, showing the dependencies of the generated variables on the original variables. By default, `ShowDependencies = FALSE`.

### StopOn

When you use the `StopOn` option, the `rationalize` function does not rationalize the specified types of subexpressions. You can specify the value of this option as a set (even if there is only one type) or a function that returns TRUE or FALSE. Each type can be

- A domain type (such as `DOM_INT`, `DOM_EXPR`, and so on)
- A string as returned by the function `type` (such as `"_plus"`, `"_mult"`, `"sin"`, and so on)
- A Type (Symbolic Math Toolbox) object (Type::Boolean, Type::Equation, and so on)

By default, the `rationalize` function does not rationalize or replace integers, rational numbers, and identifiers. When you specify other types of subexpressions, `rationalize` uses them instead of the default types. (`StopOn` overwrites the default types with the types that you specify.) If you want to extend the set of types of subexpressions retaining the default types, specify `StopOn = {DOM_INT, DOM_IDENT, DOM_RAT, extra types}`, where `extra types` are the additional types of subexpressions that you do not want to rationalize. See “Example 7” on page 1-1710 (Symbolic Math Toolbox).

If `StopOn` specifies the same type of subexpression as `DescendInto`, the `StopOn` option prevails.

## **StopOnConstants**

When you use the `StopOnConstants` option, the `rationalize` function does not rationalize the object of the type `Type::Constant`: numbers, strings, Boolean constants, `NIL`, `FAIL`, `PI` (Symbolic Math Toolbox), `EULER` (Symbolic Math Toolbox), and `CATALAN` (Symbolic Math Toolbox) in the set `Type::ConstantIdents`. By default, `StopOnConstants= FALSE`.

## **Return Values**

Sequence consisting of the rationalized object and a set of substitution equations. If you use the `Recursive` option, the `rationalize` function returns a list of substitution equations instead of a set. If you use the `MinimalPolynomials` option, the returned value has a third argument: the minimal polynomials.

## **See Also**

### **MuPAD Functions**

`indets` | `maprat` | `normal` | `rewrite` | `simplify` | `subs`

# Re

Real part of an arithmetical expression

## Syntax

$\text{Re}(z)$

$\text{Re}(L)$

## Description

$\text{Re}(z)$  returns the real part of  $z$ .

The intended use of `Re` is for constant arithmetical expressions (Symbolic Math Toolbox). Especially for numbers (Symbolic Math Toolbox), of type `DOM_INT`, `DOM_RAT`, `DOM_FLOAT`, or `DOM_COMPLEX`, the real part is computed directly and very efficiently.

`Re` can handle symbolic expressions. Properties of identifiers are taken into account. See `assume`. An identifier without any property is assumed to be complex. See “Example 2” on page 1-1718 (Symbolic Math Toolbox).

If `Re` cannot extract the whole real part of a symbolic expression  $z$ , then the returned expression contains symbolic `Re` and `Im` calls. In such cases, try using the `rectform` function. See “Example 3” on page 1-1719 (Symbolic Math Toolbox). Note that using `rectform` is computationally expensive.

The `Re` function is automatically mapped to all entries of container objects, such as arrays, lists, matrices, polynomials, sets, and tables.

## Environment Interactions

This function is sensitive to properties of identifiers set via `assume`.

## Examples

### Example 1

The real part of  $2e^{1+i}$  is:

```
Re(2*exp(1 + I))
```

```
2 cos(1) e
```

### Example 2

Re cannot extract the real part of symbolic expressions containing identifiers without a value. However, in some cases it can still simplify the input expression, as in the following two examples:

```
Re(u + v*I)
```

```
 $\Re(u) - \Im(v)$ 
```

```
Re(z + 2*I)
```

```
 $\Re(z)$ 
```

By default, identifiers without a value are assumed to represent arbitrary complex numbers. You can use `assume` to change this. The following command tells the system that `z` represents only real numbers:

```
assume(z, Type::Real):
```

```
Re(z + 2)
```

```
 $z + 2$ 
```

```
unassume(z)
```



### Example 3

If `Re` cannot extract the real part of a symbolic expression, try using the function `rectform`. It splits a complex expression  $z$  into its real and imaginary part and is more powerful than `Re`:

```
Re(exp(I*sin(z)));
r := rectform(exp(I*sin(z)))
```

$$\Re\left(e^{\sin(z) i}\right)$$

$$\cos(\cosh(\Im(z)) \sin(\Re(z))) e^{-\cos(\Re(z)) \sinh(\Im(z))}$$

$$+ \left(\sin(\cosh(\Im(z)) \sin(\Re(z))) e^{-\cos(\Re(z)) \sinh(\Im(z))}\right) i$$

Then use `Re(r)` to extract the real part of  $r$ :

```
Re(r)
```

$$\cos(\cosh(\Im(z)) \sin(\Re(z))) e^{-\cos(\Re(z)) \sinh(\Im(z))}$$

### Example 4

Symbolic expressions of type "Re" always have the property (Symbolic Math Toolbox) `Type::Real`, even if no identifier of the symbolic expression has a property:

```
is(Re(sin(2*x)), Type::Real)
```

```
TRUE
```

### Example 5

You can extend the functions `Re` and `Im` to their own special mathematical functions. See the "Algorithms" section. To do so, embed your mathematical function into a function

environment on page 7-25f and implement the behavior of the functions `Re` and `Im` for this function as the slots "Re" and "Im" of the function environment.

If a subexpression of the form `f(u, ..)` occurs in `z`, then `Re` and `Im` issue the call `f::Re(u, ..)` and `f::Im(u, ..)`, respectively, to the slot routine to determine the real and the imaginary part of `f(u, ..)`, respectively.

For example, extend the function `Re` for the sine function. Of course, the function environment `sin` already has a "Re" slot. Call your function environment `Sin` in order not to overwrite the existing system function `sin`:

```
Sin := funcenv(Sin):
Sin::Re := proc(u) // compute Re(Sin(u))
  local r, s;
begin
  r := Re(u);
  if r = u then
    return(Sin(u))
  elif not has(r, {hold(Im), hold(Re)}) then
    s := Im(u);
    if not has(s, {hold(Im), hold(Re)}) then
      return(Sin(r)*cosh(s))
    end_if
  end_if;
  return(FAIL)
end:
```

```
Re(Sin(2)), Im(Sin(3*I)), Re(Sin(2 + 3*I))
```

```
Sin(2),  $\Im(\text{Sin}(3i))$ , Sin(2) cosh(3)
```

The return value `FAIL` tells the function `Re` that `Sin::Re` was unable to determine the real part of the input expression. The result is then a symbolic `Re` call:

```
Re(2 + Sin(f(z)))
```

```
 $\Re(\text{Sin}(f(z))) + 2$ 
```

---

## Parameters

**z**

An arithmetical expression (Symbolic Math Toolbox)

**L**

A container object: an array on page 7-2, an harray on page 7-27, a list on page 7-41, a matrix on page 1-2045 (Symbolic Math Toolbox), a polynomial on page 1-1601, a set on page 7-50, or a table on page 1-2103.

## Return Values

arithmetical expression (Symbolic Math Toolbox) or a container object containing such expressions

## Overloaded By

**z**

## Algorithms

If a subexpression of the form  $f(u, \dots)$  occurs in  $z$  and  $f$  is a function environment on page 7-25, then `Re` attempts to call the slot "Re" of  $f$  to determine the real part of  $f(u, \dots)$ . In this way, you can extend the functionality of `Re` to your own special mathematical functions.

The slot "Re" is called with the arguments  $u, \dots$  of  $f$ . If the slot routine  $f::\text{Re}$  is not able to determine the real part of  $f(u, \dots)$ , then it must return `FAIL`.

If  $f$  does not have a slot "Re", or if the slot routine  $f::\text{Re}$  returns `FAIL`, then  $f(u, \dots)$  is replaced by the symbolic call  $\text{Re}(f(u, \dots))$  in the returned expression. See "Example 5" on page 1-1719 (Symbolic Math Toolbox).

Similarly, if an element  $d$  of a library domain (Symbolic Math Toolbox)  $T$  occurs as a subexpression of  $z$ , then  $\text{Re}$  attempts to call the slot "Re" of that domain with  $d$  as argument to compute the real part of  $d$ .

If the slot routine  $T : \text{Re}$  is unable to determine the real part of  $d$ , then it returns `FAIL`.

If  $T$  does not have a slot "Re", or if the slot routine  $T : \text{Re}$  returns `FAIL`, then  $d$  is replaced by the symbolic call  $\text{Re}(d)$  in the returned expression.

## See Also

### MuPAD Functions

`Im` | `abs` | `assume` | `conjugate` | `rectform` | `sign`

# Im

Imaginary part of an arithmetical expression

## Syntax

`Im(z)`

`Im(L)`

## Description

`Im(z)` returns the imaginary part of  $z$ .

The intended use of `Im` is for constant arithmetical expressions (Symbolic Math Toolbox). Especially for numbers (Symbolic Math Toolbox), of type `DOM_INT`, `DOM_RAT`, `DOM_FLOAT`, or `DOM_COMPLEX`, the imaginary part is computed directly and very efficiently.

`Im` can handle symbolic expressions. Properties of identifiers are taken into account. See `assume`. An identifier without any property is assumed to be complex. See “Example 2” on page 1-1724 (Symbolic Math Toolbox).

If `Im` cannot extract the whole imaginary part of  $z$ , then the returned expression contains symbolic `Re` and `Im` calls. In such cases, try using the `rectform` function. See “Example 3” on page 1-1725 (Symbolic Math Toolbox). Note that using `rectform` is computationally expensive.

The `Im` function is automatically mapped to all entries of container objects such as arrays, lists, matrices, polynomials, sets, and tables.

## Environment Interactions

This function is sensitive to properties of identifiers set via `assume`.

## Examples

### Example 1

The imaginary part of  $2 e^{1+i}$  is:

```
Im(2*exp(1 + I))
```

```
2 e sin(1)
```

### Example 2

Im cannot extract the imaginary part of symbolic expressions containing identifiers without a value. However, in some cases it can still simplify the input expression, as in the following two examples:

```
Im(u + v*I)
```

```
ℑ(u) + ℑ(v)
```

```
Im(z + 2)
```

```
ℑ(z)
```

By default, identifiers without a value are assumed to represent arbitrary complex numbers. You can use `assume` to change this. The following command tells the system that `z` represents only imaginary numbers:

```
assume(z, Type::Imaginary):
```

```
Im(z + 2*I)
```

```
2 - z i
```

```
unassume(z)
```

### Example 3

If `Im` cannot extract the imaginary part of a symbolic expression, try using the function `rectform`. It splits a complex expression  $z$  into its real and imaginary part and is more powerful than `Im`:

```
Im(exp(I*sin(z)));
r := rectform(exp(I*sin(z)))
```

$$\Im\left(e^{\sin(z) i}\right)$$

$$\cos(\cosh(\Im(z)) \sin(\Re(z))) e^{-\cos(\Re(z)) \sinh(\Im(z))} + \left(\sin(\cosh(\Im(z)) \sin(\Re(z))) e^{-\cos(\Re(z)) \sinh(\Im(z))}\right) i$$

Then use `Im(r)` to extract the imaginary part of  $r$ :

```
Im(r)
```

$$\sin(\cosh(\Im(z)) \sin(\Re(z))) e^{-\cos(\Re(z)) \sinh(\Im(z))}$$

### Example 4

Symbolic expressions of type "Im" always have the property (Symbolic Math Toolbox) `Type::Real`, even if no identifier of the symbolic expression has a property:

```
is(Im(sin(2*x)), Type::Real)
```

```
TRUE
```

### Example 5

You can extend the functions `Re` and `Im` to their own special mathematical functions. See the "Algorithms" section. To do so, embed your mathematical function into a function

environment on page 7-25f and implement the behavior of the functions `Re` and `Im` for this function as the slots "Re" and "Im" of the function environment.

If a subexpression of the form `f(u, ..)` occurs in `z`, then `Re` and `Im` issue the call `f::Re(u, ..)` and `f::Im(u, ..)`, respectively, to the slot routine to determine the real and the imaginary part of `f(u, ..)`, respectively.

For example, extend the function `Im` for the sine function. Of course, the function environment `sin` already has a "Im" slot. Call your function environment `Sin` in order not to overwrite the existing system function `sin`:

```
Sin := funcenv(Sin):
Sin::Im := proc(u) // compute Im(Sin(u))
  local r, s;
begin
  r := Re(u);
  if r = u then
    return(0)
  elif not has(r, {hold(Im), hold(Re)}) then
    s := Im(u);
    if not has(s, {hold(Im), hold(Re)}) then
      return(cos(r)*sinh(s))
    end_if
  end_if;
  return(FAIL)
end:
```

`Im(Sin(2)), Im(Sin(3*I)), Im(Sin(2 + 3*I))`

`0, sinh(3), cos(2) sinh(3)`

The return value `FAIL` tells the function `Im` that `Sin::Im` was unable to determine the imaginary part of the input expression. The result is then a symbolic `Im` call:

```
Im(2 + Sin(f(z)))
```

`ℑ(Sin(f(z)))`



---

## Parameters

**z**

An arithmetical expression (Symbolic Math Toolbox)

**L**

A container object: an array on page 7-2, an hfarray on page 7-27, a list on page 7-41, a matrix on page 1-2045 (Symbolic Math Toolbox), a polynomial on page 1-1601, a set on page 7-50, or a table on page 1-2103.

## Return Values

arithmetical expression (Symbolic Math Toolbox) or a container object containing such expressions

## Overloaded By

**z**

## Algorithms

If a subexpression of the form  $f(u, \dots)$  occurs in  $z$  and  $f$  is a function environment on page 7-25, then `Im` attempts to call the slot "Im" of  $f$  to determine the imaginary part of  $f(u, \dots)$ . In this way, you can extend the functionality of `Im` to your own special mathematical functions.

The slot "Im" is called with the arguments  $u, \dots$  of  $f$ . If the slot routine  $f::\text{Im}$  is not able to determine the imaginary part of  $f(u, \dots)$ , then it must return `FAIL`.

If  $f$  does not have a slot "Im", or if the slot routine  $f::\text{Im}$  returns `FAIL`, then  $f(u, \dots)$  is replaced by the symbolic call  $\text{Im}(f(u, \dots))$  in the returned expression. See "Example 5" on page 1-1725 (Symbolic Math Toolbox).

Similarly, if an element  $d$  of a library domain (Symbolic Math Toolbox)  $T$  occurs as a subexpression of  $z$ , then  $\text{Im}$  attempts to call the slot "Im" of that domain with  $d$  as argument to compute the imaginary part of  $d$ .

If the slot routine  $T : : \text{Im}$  is not able to determine the imaginary part of  $d$ , then it must return `FAIL`.

If  $T$  does not have a slot "Im", or if the slot routine  $T : : \text{Im}$  returns `FAIL`, then  $d$  is replaced by the symbolic call  $\text{Im}(d)$  in the returned expression.

## See Also

### MuPAD Functions

Re | abs | assume | conjugate | rectform | sign

# read

Search, read, and execute file

## Syntax

```
read(filename | n, <Quiet>, <Plain>, <Encoding = "encodingValue">)
```

## Description

`read(filename)` searches for the file in various folders:

- First, `filename` is concatenated to each folder given by the environment variable `READPATH`.
- Then the file name is interpreted as an absolute path name.
- Then the file name is interpreted as a relative pathname, i.e., relative to the “working folder.”
- Last, the file name is concatenated to the library path.

If a file can be opened with one of these names, then the file is read and executed with `fread`.

`read(filename, Encoding = "encodingValue")` uses the specified encoding for text files. For supported encodings, see “Options” on page 1-1733 (Symbolic Math Toolbox).

If the file is in gzip-compressed format and its name ends in “.gz”, it will be transparently uncompressed upon reading.

Note that the meaning of “working folder” depends on the operating system. On Microsoft Windows systems and on Mac OS X systems, the “working folder” is the folder where MATLAB is installed. On UNIX systems, it is the current working folder in which MATLAB was started. When started from a menu or desktop item, this is typically the user's home folder.

A path separator (“/”) is inserted as necessary when concatenating a given path and filename.

`read(n)` with a file descriptor `n` as returned by `fopen` is equivalent to the call `fread(n)`. When called with a file description, `read` does not automatically open and close the file. Use `fopen` and `fclose` to open and close the file. The `Encoding` option does not work with this syntax.

When you use the `read` command to read a file, the command evaluates all the statements in that file with the maximal substitution depth defined by `LEVEL`. The default value of `LEVEL` for interactive computations is 100. See “Example 3” on page 1-1731 (Symbolic Math Toolbox).

See the function `fread` for details about reading and executing the file's content and for a detailed description of the options `Plain` and `Quiet`.

When a file is read with `read`, the variable `FILEPATH` contains the path of the file.

## Examples

### Example 1

Create a new file in the system's temporary folder. The name of the temporary folder varies for different platforms. The `fopen` command with the `TempFile` option creates a file in any system's temporary folder (if such folder exists):

```
a := 3:  
b := 5:  
fid := fopen(TempFile, Write, Text):
```

Use the `write` command to store values `a` and `b` in the temporary file:

```
write(fid, a, b):
```

Use `fname` to return the name of the temporary file you created:

```
file := fname(fid):
```

After reading the file, the values of `a` and `b` are restored:

```
delete a, b:  
read(file):  
a, b
```

3, 5

Alternatively, use `fopen` to open the file and read its content:

```
delete a, b:
n := fopen(file):
read(n):
fclose(n):
a, b
```

3, 5

```
delete a, b, READPATH, n:
```

## Example 2

You can explicitly specify the folder and file names. The following example only works on systems like UNIX. To make it work on other operating systems, change the path names accordingly. First, use `write` to store values in the file `“testfile.mb”` in the `“/tmp”` folder:

```
a := 3:
b := 5:
write("/tmp/testfile.mb", a, b):
```

Now, define `“/tmp”` as the search folder and provide a path name relative to it. Note that the path separator `“/”` is inserted by `read`:

```
delete a, b:
READPATH := "/tmp":
read("testfile.mb"):
a, b
```

3, 5

## Example 3

The `read` command evaluates all the statements in a file it reads with the maximal substitution depth defined by `LEVEL`. For example, create and read a file that specifies the

value of the variable `a` by using another variable `b`. Use the `fopen` command with the `TempFile` option to create a new file in the system's temporary folder:

```
fid := fopen(TempFile, Write, Text):
```

Write the following statements to the file:

```
fprint(Unquoted, fid, "a := b^2: b := 5: c := a/3: delete a, b:");
```

Use `fname` to return the name of the temporary file you created. Use `fclose` to close the file:

```
file := fname(fid):  
fclose(fid)
```

Read the file. The `read` command evaluates the statements in the file recursively:

```
read(file):  
c
```

$$\frac{25}{3}$$

To suppress recursive evaluations, change the maximal substitution depth to 1:

```
delete c:  
LEVEL := 1:  
read(file):  
c
```

$$\frac{b^2}{3}$$

Restore the default value of `LEVEL` for further computations:

```
delete LEVEL
```

## Example 4

To specify the encoding to read data, use `Encoding`. The `Encoding` option applies only to text files that are opened using a file name and not a file descriptor. Open a file and write the statement `str = abcäöü` in the encoding "UTF-8":

```
fprint(Unquoted, Text, Encoding="UTF-8",  
      "read_test",  
      "str := \"abcäöü\"")
```

Specify the encoding to read the file. `read` returns the correct output:

```
read("read_test",Encoding="UTF-8"):  
"abcäöü"
```

If you do not specify an encoding, the default system encoding is used. Thus, your output might vary from that shown next. Characters unrecognized by the default system encoding are replaced by the default substitution character for that encoding:

```
read("read_test"):  
"abc        "
```

## Parameters

### **filename**

The name of a file: a character string on page 7-53

### **n**

A file descriptor provided by `fopen`: a positive integer

## Options

### **Plain**

Makes `read` use its own parser context

### **Quiet**

Suppresses output during execution of `read`

### **Encoding**

This option lets you specify the character encoding to use. The allowed encodings are:

"Big5"	"ISO-8859-1"	"windows-932"
"EUC-JP"	"ISO-8859-2"	"windows-936"
"GBK"	"ISO-8859-3"	"windows-949"
"KSC_5601"	"ISO-8859-4"	"windows-950"
"Macintosh"	"ISO-8859-9"	"windows-1250"
"Shift_JIS"	"ISO-8859-13"	"windows-1251"
"US-ASCII"	"ISO-8859-15"	"windows-1252"
"UTF-8"		"windows-1253"
		"windows-1254"
		"windows-1257"

The default encoding is system dependent. If you specify the encoding incorrectly, characters might read incorrectly. Characters unrecognized by the encoding are replaced by the default substitution character for the specified encoding.

Encodings not listed here can be specified but might not produce correct results.

## Return Values

Return value of the last statement of the file.

## See Also

### MuPAD Functions

FILEPATH | READPATH | WRITEPATH | fclose | finput | fname | fopen | fprintf | fread | ftextinput | import::readbitmap | import::readdata | input | pathname | print | protocol | readbytes | textinput | write | writebytes



# readbytes

Read binary data from a file

## Syntax

```
readbytes(filename | n, <m>, <format>, <BigEndian | LittleEndian>, <ReturnType = DOM_H
```

## Description

`readbytes` lets you read arbitrary files and interpret their contents as a sequence of numbers.

The results of `readbytes` depend on the interpretation of the binary data set by the `format` option. When reading a file, you can interpret it as a stream of `Byte`, `SignedByte`, `Short`, `SignedShort`, `Word`, `SignedWord`, `Float` or `Double`. These are standard formats that are used by many program packages to read data. See “Example 1” on page 1-1737 (Symbolic Math Toolbox).

This function is particularly useful when you work on data provided by or intended for external programs. For example, you can use it to implement encryption or compression algorithms in MuPAD. See “Example 2” on page 1-1738 (Symbolic Math Toolbox).

You can specify the file directly by its name. If a file name is specified, `readbytes` opens and closes the file automatically. If `READPATH` has no value, `readbytes` interprets the file name as a pathname relative to the “working directory.” Absolute path names are processed by `readbytes`, too.

---

**Note** The meaning of “working directory” depends on the operating system. On Microsoft Windows systems and on Mac OS X systems, the “working directory” is the folder where MuPAD is installed. On UNIX systems, it is the current working directory in which MuPAD was started.

---

If a file name is specified, each call to `readbytes` opens the file at the beginning. If the file was opened via `fopen`, subsequent calls of `readbytes` with the corresponding file

descriptor start at the point in the file that was reached by the last `readbytes` command. Hence, if you want to read a file by portions, you must open it with `fopen` and use the returned file descriptor instead of the filename. See “Example 3” on page 1-1738 (Symbolic Math Toolbox).

---

**Note** If you open the file by using `fopen`, be sure to pass the flag `Raw` to `fopen`. Otherwise, `readbytes` throws an error.

---

---

**Note** If the number of bytes in the file in a `readbytes` call is not a multiple of units of the specified format, the data are read up to the last complete number. The remaining bytes are ignored. See “Example 4” on page 1-1739 (Symbolic Math Toolbox).

---

Be sure to read the data in the appropriate way. You need to know the format used by the program which created the file.

If `readbytes` is used with the option `ReturnType = [DOM_HFARRAY, dim1, dim2, ...]`, the return value is a `DOM_HFARRAY` of the appropriate size. Here `dim1`, `dim2`, ... and positive integers which specifies the size of the dimensions of the array. If the file contains lesser values or the number of values to be read is limited, the not read elements of the array are initialized to 0.0. In other cases exactly the elements of the array are read. See “Example 6” on page 1-1740 (Symbolic Math Toolbox).

If an array of type `DOM_HFARRAY` with complex numbers is written to a file, then first the real parts of the elements are written and then the complex parts are written to the file. Because `readbytes` can only read real values, first create the real and then the complex part to reconstruct the complex array. See “Example 7” on page 1-1742 (Symbolic Math Toolbox).

## Environment Interactions

The function `readbytes` is sensitive to the environment variable `READPATH`. First, the file is searched in the “working directory.” If it cannot be found there, all paths in `READPATH` are searched.

## Examples

### Example 1

Write a sequence of numbers to the file `test.tst` with the default settings. Then, load them back in:

```
writebytes("test.tst", [42, 17, 1, 3, 5, 7, 127, 250]):
readbytes("test.tst")
```

```
[42, 17, 1, 3, 5, 7, 127, 250]
```

Read the above data with some other option: `SignedByte` interprets all values from 0 to 127 exactly as `Byte` does. Higher values  $x$ , however, are interpreted as  $x - 256$ . For example,  $250 - 256 = -6$ :

```
readbytes("test.tst", SignedByte)
```

```
[42, 17, 1, 3, 5, 7, 127, -6]
```

`Short` interprets two bytes to be one number. Therefore, the eight written bytes are interpreted as four numbers. For example, the first 2 bytes yield  $42 \cdot 2^8 + 17 = 10769$ :

```
readbytes("test.tst", Short)
```

```
[10769, 259, 1287, 32762]
```

With the flag `LittleEndian`, the byte order is reversed. For example, the first 2 bytes now yield  $17 \cdot 2^8 + 42 = 4394$ :

```
readbytes("test.tst", Short, LittleEndian)
```

```
[4394, 769, 1797, 64127]
```

`Word` interprets four bytes to be one number. Therefore, the eight written bytes give two numbers. The first 4 bytes yield  $10769 \cdot 2^{16} + 259 = 705757443$ :

```
readbytes("test.tst", Word)
```

```
[705757443, 84377594]
```

`Double` interprets eight bytes to represent one floating-point number. The interpretation is machine dependent and may be different for you:

```
readbytes("test.tst", Double)
```

```
[4.633737352 10-106]
```

## Example 2

Use `readbytes` and `writebytes` to encrypt the file created in the previous example with a simple “Caesar type encoding”: Any integer  $x$  (a byte) is replaced by  $x + 13 \bmod 256$ :

```
L := readbytes("test.tst");  
L := map(L, x -> (x + 13 mod 256));  
writebytes("test.tst", L):
```

Knowing the encryption and its key, you can successfully decrypt the file:

```
L := readbytes("test.tst")
```

```
[55, 30, 14, 16, 18, 20, 140, 7]
```

```
map(L, x -> (x - 13 mod 256))
```

```
[42, 17, 1, 3, 5, 7, 127, 250]
```

```
delete L:
```

## Example 3

Use `foopen` to write and read a file in portions:

```
n := fopen("test.tst", Write, Raw):
for i from 1 to 10 do writebytes(n, [i]) end_for:
fclose(n):
```

Equivalently, you can write all data in one go:

```
n := fopen("test.tst", Write, Raw):
writebytes(n, [i $ i = 1..10]):
fclose(n):
```

Read the data byte by byte:

```
n := fopen("test.tst", Read, Raw):
readbytes(n, 1), readbytes(n, 1), readbytes(n, 1);
fclose(n):
```

```
[1], [2], [3]
```

The next command reads in portions of 5 bytes each:

```
n := fopen("test.tst", Read, Raw):
readbytes(n, 5), readbytes(n, 5);
fclose(n):
```

```
[1, 2, 3, 4, 5], [6, 7, 8, 9, 10]
```

```
delete n, i:
```

## Example 4

Here is what happens if the number of bytes in the file does not match a multiple of units of the specified format. Because both `SignedShort` and `Float` consist of an even number of bytes, the trailing 5-th byte corresponding to 11 is ignored:

```
writebytes("test.tst", [42, 17, 7, 9, 11], Byte):
readbytes("test.tst", SignedShort),
readbytes("test.tst", Float)
```

```
[10769, 1801], [1.28810279 10-13]
```

## Example 5

Specify byte ordering by using `BigEndian` and `LittleEndian`:

```
writebytes("test.tst", [129, 255, 145, 171, 191, 253], Byte):  
L1 := readbytes("test.tst", Short, BigEndian)
```

```
[33279, 37291, 49149]
```

```
L2 := readbytes("test.tst", Short, LittleEndian)
```

```
[65409, 43921, 64959]
```

Look at the data in a binary representation. (See `numlib::g_adic` for details). The effect of using `LittleEndian` instead of `BigEndian` is to exchange the first 8 bits and the last 8 bits of each number:

```
map(L1, numlib::g_adic, 2)
```

```
[[1, 1, 1, 1, 1, 1, 1, 1, 1, 0, 0, 0, 0, 0, 0, 1], [1, 1, 0, 1, 0, 1, 0, 1, 1, 0, 0, 0, 1, 0, 0, 1],  
 [1, 0, 1, 1, 1, 1, 1, 1, 1, 1, 1, 1, 1, 1, 0, 1]]
```

```
map(L2, numlib::g_adic, 2)
```

```
[[1, 0, 0, 0, 0, 0, 0, 1, 1, 1, 1, 1, 1, 1, 1, 1], [1, 0, 0, 0, 1, 0, 0, 1, 1, 1, 0, 1, 0, 1, 0, 1],  
 [1, 1, 1, 1, 1, 1, 0, 1, 1, 0, 1, 1, 1, 1, 1, 1]]
```

```
delete L1, L2:
```

## Example 6

Read data from a file and create a `DOM_HFARRAY` with the data using the option `ReturnType`:

```
writebytes("test.tst",  
 [ 0.2703, 12.8317, -33.1531, 9999.9948, 0.2662, -14.3421,  
 1000.1801, 0.4521, -34.6787, -67.3549, 0.6818, 13], Double):  
readbytes("test.tst", ReturnType=[DOM_HFARRAY,2,6]);  
readbytes("test.tst", ReturnType=[DOM_HFARRAY,2,3,2]);
```

$$\begin{pmatrix} 0.2703 & 12.8317 & -33.1531 & 9999.9948 & 0.2662 & -14.3421 \\ 1000.1801 & 0.4521 & -34.6787 & -67.3549 & 0.6818 & 13.0 \end{pmatrix}$$

```
hfarray(1..2, 1..3, 1..2, [0.2703, 12.8317, -33.1531, 9999.9948, 0.2662, -\
14.3421, 1000.1801, 0.4521, -34.6787, -67.3549, 0.6818, 13.0])
```

If you try to read more elements, exactly the elements of the array are read.

```
readbytes("test.tst", ReturnType=[DOM_HFARRAY,2,4]);
readbytes("test.tst", 12, ReturnType=[DOM_HFARRAY,2,3]);
```

$$\begin{pmatrix} 0.2703 & 12.8317 & -33.1531 & 9999.9948 \\ 0.2662 & -14.3421 & 1000.1801 & 0.4521 \end{pmatrix}$$

$$\begin{pmatrix} 0.2703 & 12.8317 & -33.1531 \\ 9999.9948 & 0.2662 & -14.3421 \end{pmatrix}$$

If you read just a part of the array, the other elements are initialized with 0.0.

```
readbytes("test.tst", ReturnType=[DOM_HFARRAY,2,7]);
readbytes("test.tst", 4, ReturnType=[DOM_HFARRAY,2,6]);
```

$$\begin{pmatrix} 0.2703 & 12.8317 & -33.1531 & 9999.9948 & 0.2662 & -14.3421 & 1000.1801 \\ 0.4521 & -34.6787 & -67.3549 & 0.6818 & 13.0 & 0.0 & 0.0 \end{pmatrix}$$

$$\begin{pmatrix} 0.2703 & 12.8317 & -33.1531 & 9999.9948 & 0.0 & 0.0 \\ 0.0 & 0.0 & 0.0 & 0.0 & 0.0 & 0.0 \end{pmatrix}$$

If you try to read all the data from the file using the option `ReturnType` without a dimension for the `DOM_HFARRAY` a one dimensional array of the right size is created.

```
readbytes("test.tst", ReturnType=DOM_HFARRAY)
```

```
[[0.2703, 12.8317, -33.1531, 9999.9948, 0.2662, -14.3421, 1000.1801,  
  0.4521, -34.6787, -67.3549, 0.6818, 13.0]]
```

## Example 7

Write a DOM\_HFARRAY with complex numbers to a file and try to reconstruct it by reading the data.

```
A := hfarray(1..2, 1..3,  
            [[2342.133 + 56*I, -342.56, PI + I],  
             [-3*I, I^2 + I, 13]]);  
writebytes("test.tst", A);  
fd := fopen("test.tst", Read, Raw);  
B := readbytes(fd, ReturnType = [DOM_HFARRAY, 2, 3]);  
C := readbytes(fd, ReturnType = [DOM_HFARRAY, 2, 3]);  
bool(A = B + C*I);  
fclose(fd);
```

```
( 2342.133 + 56.0 i  -342.56  3.141592654 + 1.0 i )  
( -8.154845485  -1.0 + 1.0 i      13.0 )
```

```
( 2342.133  -342.56  3.141592654 )  
( -8.154845485  -1.0      13.0 )
```

```
( 56.0 0.0 1.0 )  
( 0.0 1.0 0.0 )
```

```
TRUE
```

```
delete A, B, C, fd;
```



## Parameters

### **filename**

The name of a file: a character string (Symbolic Math Toolbox)

### **n**

A file descriptor provided by `fopen`: a positive integer. The file must have been opened using the `fopen`-flag `Raw`.

### **m**

The number of values to be read or written: a positive integer.

### **format**

The format of binary data, specified as `Byte`, `SignedByte`, `Short`, `SignedShort`, `Word`, `SignedWord`, `Float`, and `Double`.

## Options

### **Byte, SignedByte, Short, SignedShort, SignedWord, Word, Double, Float**

The format of the binary data. The default format is `Byte`.

A byte is an 8-bit binary number. Therefore, a byte can have  $2^8$  different values. For `Byte`, these are the integers from 0 to 255. For `SignedByte`, they are the integers from -128 to 127.

With `Byte`, the data are read/written in 8-bit blocks, interpreted as unsigned bytes. When writing, the numbers are checked for being in the range from 0 to 255.

With `SignedByte`, the data are read or written using the 2-complement.

`Byte` is the default format.

A “short” is a 16-bit binary number (2 bytes). Therefore, a “short” can have  $2^{16}$  different values. For `Short`, these are the integers from 0 to 65536. For `SignedShort`, they are the integers from -32768 to 32767.

The semantics of `Short` or `SignedShort` is analogous to that of `Byte` or `SignedByte`, respectively.

A “word” is a 32-bit binary number (4 bytes). Therefore, a “word” can have  $2^{32}$  different values. For `Word`, these are the integers from 0 to 4294967296. For `SignedWord`, they are the integers from - 2147483648 to 2147483647.

The semantics of `Word` or `SignedWord` is analogous to that of `Byte` or `SignedByte`, respectively.

A “float” is a 32-bit representation of a real number (4 bytes). A “double” is a 64-bit representation of a real number (8 bytes).

---

**Note** Floating-point and double-precision values are read/written in the format of the machine/operating system MuPAD is currently running on. Therefore, the results may differ between different platforms.

---

Binary files containing floating-point numbers are, in general, not portable to other platforms.

See the flags `BigEndian` and `LittleEndian` for details on the byte ordering.

See “Example 1” on page 1-1737 (Symbolic Math Toolbox) for an overview over the different format options.

### **BigEndian, LittleEndian**

The byte ordering: either `BigEndian` or `LittleEndian`. The default ordering is `BigEndian`.

`BigEndian` and `LittleEndian` specify the order used to arrange the bytes for `Short`, `SignedShort`, `Word`, `SignedWord`, `Float`, and `Double`.

For all formats, the data are written in 8-bit blocks (bytes). This also includes the formats where a unit is longer than one byte (all formats but `Byte` and `SignedByte`). With `BigEndian`, the bytes with the most significant bits (“high bits”) are written first. With `LittleEndian`, the bytes with the least significant bits are written first.

If, for example, `Short` is selected, there are 16 bits that are to be written. If you pass `BigEndian`, first the byte with the bits for  $2^{15}$  to  $2^8$  and then the byte with the bits for  $2^7$  to  $2^0$  are written. If you specify `LittleEndian`, the order of the bytes is reversed.

`BigEndian` and `LittleEndian` have no effect if the formats `Byte` or `SignedByte` are specified.

`BigEndian` is the default byte order.

See “Example 5” on page 1-1740 (Symbolic Math Toolbox) for the effects of `BigEndian` and `LittleEndian`.

### **ReturnType**

Option, specified as `ReturnType = DOM_HFARRAY | DOM_LIST | [DOM_HFARRAY] | [DOM_HFARRAY, dim1, dim2, ...]` that sets the type of the return value.

If set to `DOM_LIST`, the return value is a list which contains the read data.

If set to `DOM_HFARRAY`, the return value is a one dimensional array which contains the read data.

If set to `[DOM_HFARRAY, dim1, dim2, ...]`, the return value is a (multidimensional) array and `dim1, dim2, ...` are positive integers which specifies the size of the dimensions of the array.

## **Return Values**

A list of MuPAD numbers (either integers or floating-point numbers) or an array of hardware floating-point values of type `DOM_HFARRAY`. Its type depends on the setting of the option `ReturnType`.

## **See Also**

### **MuPAD Functions**

`FILEPATH` | `READPATH` | `WRITEPATH` | `fclose` | `finput` | `fname` | `fopen` | `fprint` | `fread` | `ftextinput` | `import::readbitmap` | `import::readdata` | `pathname` | `print` | `protocol` | `read` | `write` | `writebytes`

## writebytes

Write binary data to a file

### Syntax

```
writebytes(filename | n, list | hfarray, <format>, <BigEndian | LittleEndian>, <Force>
```

### Description

`writebytes(file, list)` writes a list of MuPAD numbers to a file.

`writebytes(file, hfarray)` writes an array of type `DOM_HFARRAY` to a file.

`writebytes` lets you write arbitrary files and interpret their contents as a sequence of numbers.

The results of `writebytes` depend on the interpretation of the binary data set by the `format` option. When writing to a file, you can interpret it as a stream of `Byte`, `SignedByte`, `Short`, `SignedShort`, `Word`, `SignedWord`, `Float` or `Double`. These are standard formats used by many program packages to write data. See “Example 1” on page 1-1748 (Symbolic Math Toolbox).

This function is particularly useful when you work on data provided by or intended for external programs. For example, you can use it to implement encryption or compression algorithms in MuPAD. See “Example 2” on page 1-1749 (Symbolic Math Toolbox).

You can specify the file directly by its name. If a file name is specified, `writebytes` creates a new file or overwrites an existing file. If a file name is specified, `writebytes` also opens and closes the file automatically. If `WRITEPATH` has no value `writebytes` interprets the file name as a pathname relative to the “working directory.” Absolute path names are processed by `writebytes`, too.

---

**Note** The meaning of “working directory” depends on the operating system. On Microsoft Windows systems and on Mac OS X systems, the “working directory” is the folder where MuPAD is installed. On UNIX systems, it is the current working directory in

which MuPAD was started; when started from a menu or desktop item, this is typically the user's home directory.

---

If a file name is specified, each call to `writebytes` opens the file at the beginning. If the file was opened via `fopen`, subsequent calls of `writebytes` with the corresponding file descriptor start at the point in the file that was reached by the last `writebytes` command. Hence, if you want to write a file by portions, you must open it with `fopen` and use the returned file descriptor instead of the filename. See “Example 3” on page 1-1749 (Symbolic Math Toolbox).

---

**Note** If the file is to be opened via `fopen`, be sure to pass the flag `Raw` to `fopen`. Otherwise, `writebytes` throws an error.

---

Be sure to write the data in the appropriate way. You must know the format used by the program which will be reading the file.

When writing data via `writebytes`, each entry in the list is checked for whether it can be converted to the specified format. If this is not the case, `writebytes` throws an error. See “Example 4” on page 1-1750 (Symbolic Math Toolbox).

When writing an array of type `DOM_HFARRAY`, only `Double` is allowed as the binary format. If no format option is given such arrays are written as doubles. See “Example 7” on page 1-1752 (Symbolic Math Toolbox).

If an array of type `DOM_HFARRAY` with complex numbers is written to a file, then first the real parts of the elements are written and then the complex parts are written to the file. Because `readbytes` can only read real values, first one have to create the real and then the complex part to reconstruct the complex array. See “Example 9” on page 1-1752 (Symbolic Math Toolbox).

## Environment Interactions

The function `writebytes` is sensitive to the environment variable `WRITEPATH`. If this variable has a value, the file is created in the corresponding directory. Otherwise, the file is created in the “working directory.”

## Examples

### Example 1

Write a sequence of numbers to the file `test.tst` with the default settings. Then, load them back in:

```
writebytes("test.tst", [42, 17, 1, 3, 5, 7, 127, 250]):  
readbytes("test.tst")
```

```
[42, 17, 1, 3, 5, 7, 127, 250]
```

Read the above data with some other option: `SignedByte` interprets all values from 0 to 127 exactly as `Byte` does. Higher values  $x$ , however, are interpreted as  $x - 256$ . For example,  $250 - 256 = -6$ :

```
readbytes("test.tst", SignedByte)
```

```
[42, 17, 1, 3, 5, 7, 127, -6]
```

`Short` interprets two bytes to be one number. Therefore, the eight written bytes are interpreted as four numbers. For example, the first 2 bytes yield  $42 \cdot 2^8 + 17 = 10769$ :

```
readbytes("test.tst", Short)
```

```
[10769, 259, 1287, 32762]
```

With the flag `LittleEndian`, the byte order is reversed. For example, the first 2 bytes now yield  $17 \cdot 2^8 + 42 = 4394$ :

```
readbytes("test.tst", Short, LittleEndian)
```

```
[4394, 769, 1797, 64127]
```

`Word` interprets four bytes to be one number. Therefore, the eight written bytes give two numbers. The first 4 bytes yield  $10769 \cdot 2^{16} + 259 = 705757443$ :

```
readbytes("test.tst", Word)
```

```
[705757443, 84377594]
```

`Double` interprets eight bytes to represent one floating-point number. The interpretation is machine dependent and may be different for you:

```
readbytes("test.tst", Double)
```

```
[4.633737352 10-106]
```

## Example 2

Use `readbytes` and `writebytes` to encrypt the file created in the previous example with a simple “Caesar type encoding”: Any integer  $x$  (a byte) is replaced by  $x + 13 \bmod 256$ :

```
L := readbytes("test.tst");
L := map(L, x -> (x + 13 mod 256));
writebytes("test.tst", L):
```

Knowing the encryption and its key, you can successfully decrypt the file:

```
L := readbytes("test.tst")
```

```
[55, 30, 14, 16, 18, 20, 140, 7]
```

```
map(L, x -> (x - 13 mod 256))
```

```
[42, 17, 1, 3, 5, 7, 127, 250]
```

```
delete L:
```

## Example 3

Use `open` to write and read a file in portions:

```
n := fopen("test.tst", Write, Raw):
for i from 1 to 10 do writebytes(n, [i]) end_for:
fclose(n):
```

Equivalently, you can write all data in one go:

```
n := fopen("test.tst", Write, Raw):
writebytes(n, [i $ i = 1..10]):
fclose(n):
```

Read the data byte by byte:

```
n := fopen("test.tst", Read, Raw):
readbytes(n, 1), readbytes(n, 1), readbytes(n, 1);
fclose(n):
```

```
[1], [2], [3]
```

The next command reads in portions of 5 bytes each:

```
n := fopen("test.tst", Read, Raw):
readbytes(n, 5), readbytes(n, 5);
fclose(n):
```

```
[1, 2, 3, 4, 5], [6, 7, 8, 9, 10]
```

```
delete n, i:
```

## Example 4

An error is thrown if the data do not match the specified format. Here, -5 does not match Byte. This format does not include negative numbers:

```
writebytes("test.tst", [42, 17, -5, 7], Byte)
```

```
Error: Invalid argument. [writebytes]
```



## Example 5

Here is what happens if the number of bytes in the file does not match a multiple of units of the specified format. Because both `SignedShort` and `Float` consist of an even number of bytes, the trailing 5-th byte corresponding to 11 is ignored:

```
writebytes("test.tst", [42, 17, 7, 9, 11], Byte):
readbytes("test.tst", SignedShort),
readbytes("test.tst", Float)
```

```
[10769, 1801], [1.28810279 10-13]
```

## Example 6

Specify byte ordering by using `BigEndian` and `LittleEndian`:

```
writebytes("test.tst", [129, 255, 145, 171, 191, 253], Byte):
L1 := readbytes("test.tst", Short, BigEndian)
```

```
[33279, 37291, 49149]
```

```
L2 := readbytes("test.tst", Short, LittleEndian)
```

```
[65409, 43921, 64959]
```

Look at the data in a binary representation. (See `numlib::g_adic` for details). The effect of using `LittleEndian` instead of `BigEndian` is to exchange the first 8 bits and the last 8 bits of each number:

```
map(L1, numlib::g_adic, 2)
```

```
[[1, 1, 1, 1, 1, 1, 1, 1, 1, 0, 0, 0, 0, 0, 0, 1], [1, 1, 0, 1, 0, 1, 0, 1, 1, 0, 0, 0, 1, 0, 0, 1],
 [1, 0, 1, 1, 1, 1, 1, 1, 1, 1, 1, 1, 1, 1, 0, 1]]
```

```
map(L2, numlib::g_adic, 2)
```

```
[[1, 0, 0, 0, 0, 0, 0, 1, 1, 1, 1, 1, 1, 1, 1, 1], [1, 0, 0, 0, 1, 0, 0, 1, 1, 1, 0, 1, 0, 1, 0, 1],  
 [1, 1, 1, 1, 1, 1, 0, 1, 1, 0, 1, 1, 1, 1, 1, 1]]
```

```
delete L1, L2:
```

## Example 7

Write the elements of a `DOM_HFARRAY` to a file. All the elements are double-precision values, and `writebytes` does not allow writing the elements of the array in another format than `Double`.

```
A:=hfarray(1..2,1..6,  
  [ 0.2703, 12.8317, -33.1531, 9999.9948, 0.2662, -14.3421,  
  1000.1801, 0.4521, -34.6787, -67.3549, 0.6818, 13]):  
writebytes("test.tst", A):
```

But if we try to write the elements as bytes we will get an error.

```
writebytes("test.tst", A, Byte):
```

```
Error: Invalid argument. [writebytes]
```

```
delete A:
```

## Example 9

Write a `DOM_HFARRAY` with complex numbers to a file and try to reconstruct it by reading the data.

```
A := hfarray(1..2, 1..3,  
  [[2342.133 + 56*I, -342.56, PI + I],  
  [-3*E, I^2 + I, 13]]);  
writebytes("test.tst", A);  
fd := fopen("test.tst", Read, Raw):  
B := readbytes(fd, ReturnType = [DOM_HFARRAY, 2, 3]);  
C := readbytes(fd, ReturnType = [DOM_HFARRAY, 2, 3]);  
bool(A = B + C*I);  
fclose(fd):
```

$$\begin{pmatrix} 2342.133 + 56.0 i & -342.56 & 3.141592654 + 1.0 i \\ -8.154845485 & -1.0 + 1.0 i & 13.0 \end{pmatrix}$$

```
( 2342.133 -342.56 3.141592654
 -8.154845485 -1.0 13.0 )
```

```
( 56.0 0.0 1.0
 0.0 1.0 0.0 )
```

```
TRUE
```

```
delete A, B, C, fd:
```

## Example 10

Suppose you have a `DOM_HFARRAY` with entries which are integer numbers between -32768 and 32767 and we want to write this data as `SignedShort` to a file. If you try it without the option `Force`, you will get an error because a floating-point number of type `DOM_FLOAT` cannot be written as a `SignedShort`. With the option `Force`, `writebytes` tries to convert the floating-point number to a signed word and writes it in any case to the file.

```
A:=hfarray( 1..2,1..3, [[234,-32768,1],[32767,-12111,-3]]);
writebytes("test.tst", SignedShort, A):
```

```
( 234.0 -32768.0 1.0
 32767.0 -12111.0 -3.0 )
```

```
Error: Invalid argument. [writebytes]
```

```
writebytes("test.tst", SignedShort, Force, A):
l:= readbytes("test.tst", SignedShort);
op(A,i)-l[i] $i=1..6;
```

```
[234, -32768, 1, 32767, -12111, -3]
```

```
0.0, 0.0, 0.0, 0.0, 0.0, 0.0
```

`delete A, l:`

## Parameters

### **filename**

The name of a file: a character string (Symbolic Math Toolbox)

### **n**

A file descriptor provided by `fopen`: a positive integer. The file must have been opened using the `fopen-flag Raw`.

### **list**

A list of MuPAD numbers to be written to the file. The entries must match the specified format.

### **hffarray**

An array of type `DOM_HFARRAY`.

### **format**

The format of binary data, specified as `Byte`, `SignedByte`, `Short`, `SignedShort`, `Word`, `SignedWord`, `Float`, and `Double`.

## Options

### **Byte, SignedByte, Short, SignedShort, SignedWord, Word, Double, Float**

The format of the binary data. The default format is `Byte`.

A byte is an 8-bit binary number. Therefore, a byte can have  $2^8$  different values. For `Byte`, these are the integers from 0 to 255. For `SignedByte`, they are the integers from -128 to 127.

With `Byte`, the data are read/written in 8-bit blocks, interpreted as unsigned bytes. When writing, the numbers are checked for being in the range from 0 to 255.

With `SignedByte`, the data are read or written using the 2-complement.

`Byte` is the default format.

A “short” is a 16-bit binary number (2 bytes). Therefore, a “short” can have  $2^{16}$  different values. For `Short`, these are the integers from 0 to 65536. For `SignedShort`, they are the integers from - 32768 to 32767.

The semantics of `Short` or `SignedShort` is analogous to that of `Byte` or `SignedByte`, respectively.

A “word” is a 32-bit binary number (4 bytes). Therefore, a “word” can have  $2^{32}$  different values. For `Word`, these are the integers from 0 to 4294967296. For `SignedWord`, they are the integers from - 2147483648 to 2147483647.

The semantics of `Word` or `SignedWord` is analogous to that of `Byte` or `SignedByte`, respectively.

The format of the binary data. The default format is `Byte`.

A “float” is a 32-bit representation of a real number (4 bytes). A “double” is a 64-bit representation of a real number (8 bytes).

---

**Note** Floats and doubles are read/written in the format of the machine/operating system MuPAD is currently running on. Therefore, the results may differ between different platforms.

---

Binary files containing floating-point numbers are, in general, not portable to other platforms.

See the flags `BigEndian` and `LittleEndian` for details on the byte ordering.

See “Example 1” on page 1-1748 (Symbolic Math Toolbox) for an overview over the different format options.

### **BigEndian, LittleEndian**

The byte ordering: either `BigEndian` or `LittleEndian`. The default ordering is `BigEndian`.

`BigEndian` and `LittleEndian` specify the order in which the bytes are arranged for `Short`, `SignedShort`, `Word`, `SignedWord`, `Float`, and `Double`.

For all formats, the data are written in 8-bit blocks (bytes). This also includes the formats where a unit is longer than one byte (all formats but `Byte` and `SignedByte`). With `BigEndian`, the bytes with the most significant bits (“high bits”) are written first. With `LittleEndian`, the bytes with the least significant bits are written first.

If, for example, `Short` is selected, there are 16 bits that are to be written. If you pass `BigEndian`, first the byte with the bits for  $2^{15}$  to  $2^8$  and then the byte with the bits for  $2^7$  to  $2^0$  are written. If you specify `LittleEndian`, the order of the bytes is reversed.

`BigEndian` and `LittleEndian` have no effect if the formats `Byte` or `SignedByte` are specified.

`BigEndian` is the default byte order.

See “Example 6” on page 1-1751 (Symbolic Math Toolbox) for the effects of `BigEndian` and `LittleEndian`.

### **Force**

Write the binary data in any case even if the numbers does not match the given format.

If the option `Force` is set, data are written in the given format, e.g. `Byte` even if they does not have the right format. E.g. 100.00 is a `DOM_FLOAT` and normally `writebytes` only writes this data if the format is `Float` or `Double`. With the option `Force` the value is written as a `Byte`. Cf. “Example 10” on page 1-1753 (Symbolic Math Toolbox).

If the given value does not fit the given data format, the written value is not specified. E.g. 53425.00 written as a `Byte` can be 177 which is  $53425.00 \bmod 256$  or just 0. But for sure 100.00 is written as 100.

## **Return Values**

The void object `null()` of type `DOM_NULL`.

## See Also

### MuPAD Functions

FILEPATH | READPATH | WRITEPATH | fclose | finput | fname | fopen | fprintf | fread | ftextinput | import::readbitmap | import::readdata | pathname | print | protocol | read | readbytes | write

# repeatuntilend\_repeat\_repeat

“repeat” loop

## Syntax

```
repeat
  body
until condition end_repeat
_repeat(body, condition)
```

## Description

`repeat - end_repeat` is a loop that evaluates its body until a specified stopping criterion is satisfied.

In a `repeat` loop, first `body` and then `condition` are evaluated until `condition` evaluates to `TRUE`.

In contrast to the `while` loop, the body of a `repeat` loop is always evaluated at least once.

The body can consist of any number of statements which must be separated either by a colon `:` or a semicolon `;`. Only the last evaluated result inside the body (the return value of the loop) is printed on the screen. Use `print` to see intermediate results.

The Boolean expression `condition` must be reducible to either `TRUE` or `FALSE`. Internally, the condition is evaluated in the lazy evaluation context of the functions `_lazy_and` and `_lazy_or`.

The statements `next` and `break` can be used in `repeat` loops in the same way as in `for` loops.

The keyword `end_repeat` can be replaced by the keyword `end`.

The imperative form `repeat - end_repeat` is equivalent to corresponding call of the function `_repeat`. In most cases, the imperative form leads to simpler code.



The \$ operator is often a more elegant notation for loops.

\_repeat is a function of the system kernel.

## Examples

### Example 1

repeat loops do not show intermediate results of statements within a loop:

```
i := 1:
s := 0:
repeat
  s := s + i;
  i := i + 1;
until i >= 3
end_repeat
```

3

Above, only the return value of the loop is displayed. Use print to see intermediate results:

```
i := 1:
s := 0:
repeat
  print("intermediate sum" = s);
  s := s + i;
  i := i + 1;
  s
until i >= 3
end_repeat
```

"intermediate sum" = 0

"intermediate sum" = 1

3

```
delete i, s:
```

## Example 2

Express the same statements as a `repeat` loop and as an equivalent `while` loop. In more complicated cases, you might need additional initializations of variables:

```
i := 1:
repeat
  print(i);
  i := i + 1;
until i = 3 end:
```

1

2

```
i := 1:
while i < 3 do
  print(i);
  i := i + 1;
end:
```

1

2

```
delete i:
```

## Example 3

The Boolean expression `condition` must evaluate to `TRUE` or `FALSE`:

```
repeat
  condition := UNKNOWN;
  print(Condition = condition);
until condition
end_repeat:
```

```
Condition = UNKNOWN
```

Error: 'TRUE' or 'FALSE' expected. [repeat]

To avoid this error, change the stopping criterion to `condition <> TRUE`:

```
repeat
  condition := UNKNOWN;
  print(Condition = condition);
until condition = UNKNOWN
end_repeat:
```

```
Condition = UNKNOWN
```

```
delete condition:
```

## Example 4

You also can create a `repeat` loop by using the functional form `_repeat`:

```
hold(_repeat((statement1; statement2), condition))
```

```
repeat
  statement1;
  statement2
until condition end_repeat
```

## Parameters

### body

The body of the loop: an arbitrary sequence of statements

### condition

A Boolean expression on page 1-2180

## Return Values

Value of the last command executed in the body of the loop. If no command was executed, the value NIL is returned. If the body of a `while` loop is not evaluated due to a false condition, the void object of type `DOM_NULL` is returned.

## See Also

### MuPAD Functions

`$` | `_lazy_and` | `_lazy_or` | `break` | `for` | `next` | `while`

## Topics

“Loops” (Symbolic Math Toolbox)

# whileend\_while\_while

“while” loop

---

**Note** For the while loop in MATLAB®, see `while`.

---

## Syntax

```
while condition do
    body
end_while

_while(condition, body)
```

## Description

`while` - `end_while` represents a loop that evaluates its body while a specified condition holds true.

In a `while` loop, `condition` is evaluated before the body is executed for the first time. If `condition` evaluates to `TRUE`, the loop is entered and `body` and `condition` are evaluated until `condition` evaluates to `FALSE`.

The body can consist of any number of statements which must be separated either by a colon `:` or a semicolon `;`. Only the last evaluated result inside the body (the return value of the loop) is printed on the screen. Use `print` to see intermediate results.

The Boolean expression `condition` must be reducible to either `TRUE` or `FALSE`. Internally, the condition is evaluated in the lazy evaluation context of the functions `_lazy_and` and `_lazy_or`.

The statements `next` and `break` can be used in `while` loops in the same way as in `for` loops.

The keyword `end_while` can be replaced by the keyword `end`.

The imperative form `while - end_while` is equivalent to corresponding call of the function `_while`. In most cases, the imperative form leads to simpler code.

The `$` operator is often a more elegant notation for loops.

`_while` is a function of the system kernel.

## Examples

### Example 1

while loops do not show intermediate results of statements within a loop:

```
i := 1:
s := 0:
while i < 3 do
  s := s + i;
  i := i + 1;
end_while
```

3

Use `print` to see intermediate results:

```
i := 1:
s := 0:
while i < 3 do
  print("intermediate sum" = s);
  s := s + i;
  i := i + 1;
  s
end_while
```

"intermediate sum" = 0

"intermediate sum" = 1

3

```
delete i, s:
```

## Example 2

Express the same statements as a `repeat` loop and as an equivalent `while` loop. In more complicated cases, you might need additional initializations of variables:

```
i := 1:
repeat
  print(i);
  i := i + 1;
until i = 3 end:
```

1

2

```
i := 1:
while i < 3 do
  print(i);
  i := i + 1;
end:
```

1

2

```
delete i:
```

## Example 3

The Boolean expression `condition` must evaluate to `TRUE` or `FALSE`:

```
condition := UNKNOWN:
while not condition do
  print(Condition = condition);
  condition := TRUE;
end_while:
```

Error: 'TRUE' or 'FALSE' expected. [while]

To avoid this error, change the stopping criterion to `condition <> TRUE`:

```
condition := UNKNOWN;
while condition <> TRUE do
  print(Condition = condition);
  condition := TRUE;
end_while;
```

```
Condition = UNKNOWN
```

```
delete condition;
```

## Example 4

You also can create a `while` loop by using the functional form `_while`:

```
hold(_while(condition, (statement1; statement2)))
```

```
while condition do
  statement1;
  statement2
end_while
```

## Parameters

### **body**

The body of the loop: an arbitrary sequence of statements

### **condition**

A Boolean expression on page 1-2180



## Return Values

Value of the last command executed in the body of the loop. If no command was executed, the value NIL is returned. If the body of a `while` loop is not evaluated due to a false condition, the void object of type `DOM_NULL` is returned.

## See Also

### MuPAD Functions

`$` | `_lazy_and` | `_lazy_or` | `break` | `for` | `next` | `repeat`

## Topics

“Loops” (Symbolic Math Toolbox)

## rec

Domain of recurrence equations

## Syntax

`rec(eq, y(n), <cond>)`

## Description

`rec(eq, y(n))` creates an object of type `rec` representing a recurrence equation for the sequence `y(n)`.

The equation `eq` must involve only shifts `y(n + i)` with integer values of `i`; at least one such expression must be present in `eq`. An arithmetical expression (Symbolic Math Toolbox) `eq` is equivalent to the equation `eq = 0`.

Initial or boundary conditions `cond` must be specified as sets of equations of the form `{y(n0) = y0, y(n1) = y1, ...}` with arithmetical expressions (Symbolic Math Toolbox) `n0, n1, ...` that must not contain the identifier `n`, and arithmetical expressions (Symbolic Math Toolbox) `y0, y1, ...` that must not contain the identifier `y`.

The main purpose of the `rec` domain is to provide an environment for overloading (Symbolic Math Toolbox) the function `solve`. For a recurrence `r` of type `rec`, the call `solve(r)` returns a set representing an affine subspace of the complete solution space. Its only entry is an expression in `n` that may contain free parameters such as `C1, C2`, etc. See “Example 1” on page 1-1769 (Symbolic Math Toolbox), “Example 4” on page 1-1770 (Symbolic Math Toolbox), and “Example 5” on page 1-1770 (Symbolic Math Toolbox).

Currently only linear recurrences with coefficients that are rational functions of `n` can be solved. `solve` handles recurrences with constant coefficients, it finds hypergeometric solutions of first order recurrences, and polynomial solutions of higher order recurrences with non-constant coefficients.

`solve` is not always able to find the complete solution space. Cf. “Example 5” on page 1-1770 (Symbolic Math Toolbox). If `solve` cannot find a solution, then the `solve` call is

returned symbolically. For parametric recurrences, the output of `solve` may be a conditionally defined set of type `piecewise`. Cf. “Example 6” on page 1-1770 (Symbolic Math Toolbox).

## Examples

### Example 1

The first command defines the homogeneous first order recurrence equation

$y(n+1) = \frac{2(n+1)y(n)}{n}$  for the sequence  $y(n)$ . It is solved by a call to the `solve` function:

```
rec(y(n + 1) = 2*y(n)*(n + 1)/n, y(n))
```

$$\text{rec}\left(y(n+1) - \frac{2y(n)(n+1)}{n}, y(n), \emptyset\right)$$

```
solve(%)
```

$$\{2^n C_1 n\}$$

Thus, the general solution of the recurrence equation is  $y(n) = C_1 n 2^n$ , where  $C_1$  is an arbitrary constant.

### Example 2

In the next example, the homogeneous first order recurrence  $y(n+1) = 3(n+1)y(n)$  with the initial condition  $y(0) = 1$  is solved for the unknown sequence  $y(n)$ :

```
solve(rec(y(n + 1) = 3*(n + 1)*y(n), y(n), {y(0) = 1}))
```

$$\{3^n \Gamma(n+1)\}$$

Thus, the solution is  $y(n) = 3^n \Gamma(n+1) = 3^n n!$  for all integers  $n \geq 0$  (*gamma* is the gamma function on page 1-429 (Symbolic Math Toolbox)).

### Example 3

In the following example, the inhomogeneous second order recurrence  $y(n + 2) - 2y(n + 1) + y(n) = 2$  is solved for the unknown sequence  $y(n)$ . The initial conditions  $y(0) = -1$  and  $y(1) = m$  with some parameter  $m$  are taken into account by `solve`:

```
solve(rec(y(n + 2) - 2*y(n + 1) + y(n) = 2, y(n),  
        {y(0) = -1, y(1) = m}))
```

$$\{n^2 + m n - 1\}$$

### Example 4

We compute the general solution of the homogeneous second order recurrence  $y(n + 2) + 3y(n + 1) + 2y(n) = 0$ :

```
solve(rec(y(n + 2) + 3*y(n + 1) + 2*y(n), y(n)))
```

$$\{(-1)^n C7 + (-2)^n C6\}$$

Here,  $C6$  and  $C7$  are arbitrary constants.

### Example 5

For the following homogeneous third order recurrence with non-constant coefficients, the system only finds the polynomial solutions:

```
solve(rec(n*y(n + 3) = (n + 3)*y(n), y(n)))
```

$$\{C9 n\}$$

### Example 6

The following homogeneous second order recurrence with constant coefficients involves a parameter  $a$ . The solution set depends on the value of this parameter, and `solve` returns a `piecewise` object:

```
solve(rec(a*y(n + 2) = y(n), y(n)))
```

$$\begin{cases} \{0\} & \text{if } a = 0 \\ \left\{ \frac{C11}{a^{n/2}} + C10 \left(-\frac{1}{\sqrt{a}}\right)^n \right\} & \text{if } a \neq 0 \end{cases}$$

## Example 7

The following homogeneous second order recurrence with non-constant coefficients involves a parameter  $a$ . Although it has a polynomial solution for  $a = 2$ , the system does not recognize this:

```
solve(rec(n*y(n + 2) = (n + a)*y(n), y(n)))
```

$\{0\}$

## Parameters

**eq**

An equation or an arithmetical expression (Symbolic Math Toolbox)

**y**

The unknown function: an identifier on page 7-29

**n**

The index: an identifier

**cond**

A set of initial or boundary conditions

## Return Values

Object of type rec.

## Algorithms

For homogeneous recurrences with constant coefficients, `solve` computes the roots of the characteristic polynomial. If some of them cannot be given in explicit form, i.e., only by means of `RootOf`, then `solve` does not return a solution. Otherwise, the complete solution space is returned.

For first order homogeneous recurrences with nonconstant coefficients, `solve` returns the complete solution space if the coefficients of the recurrence can be factored into at most quadratic polynomials. Otherwise, `solve` does not return a solution.

For homogeneous recurrences of order at least two with nonconstant coefficients, `solve` finds the complete space of all *polynomial* solutions.

Currently, inhomogeneous recurrences can only be solved if they have a polynomial solution. The previous remarks apply.

For parametric recurrences, the system may not find solutions that are valid only for special values of the parameters. Cf. "Example 7" on page 1-1771 (Symbolic Math Toolbox).

## See Also

### MuPAD Functions

`ode` | `solve` | `sum`

# rectform

Rectangular form of a complex expression

## Syntax

`rectform(z)`

## Description

`rectform(z)` computes the rectangular form of the complex expression  $z$ , i.e., it splits  $z$  into  $z = \Re(z) + i \Im(z)$ .

`rectform(z)` tries to split  $z$  into its real and imaginary part and to return  $z$  in the form  $z = \Re(z) + i \Im(z)$ .

`rectform` works recursively, i.e., it first tries to split each subexpression of  $z$  into its real and imaginary part and then tackles  $z$  as a whole.

Use `Re` and `Im` to extract the real and imaginary parts, respectively, from the result of `rectform`. See “Example 1” on page 1-1775 (Symbolic Math Toolbox).

`rectform` is more powerful than a direct application of `Re` and `Im` to  $z$ . However, usually it is much slower. For constant arithmetical expressions (Symbolic Math Toolbox), it is therefore recommended to use the functions `Re` and `Im` directly. See “Example 2” on page 1-1775 (Symbolic Math Toolbox).

The main use of `rectform` is for symbolic expressions, and properties (Symbolic Math Toolbox) of identifiers are taken into account (see `assume`). An identifier without any property is assumed to be complex valued. See “Example 3” on page 1-1776 (Symbolic Math Toolbox).

If  $z$  is an array on page 7-2, a list on page 7-41, or a set on page 7-50, then `rectform` is applied to each entry of  $z$ .

If  $z$  is an `harray` on page 7-27, then `rectform` returns  $z$  unchanged.

If  $z$  is a polynomial (Symbolic Math Toolbox) or a series expansion, of type `Series::Puiseux` or `Series::gseries`, then `rectform` is applied to each coefficient of  $z$ .

See “Example 5” on page 1-1778 (Symbolic Math Toolbox).

The result  $r := \text{rectform}(z)$  is an element of the domain (Symbolic Math Toolbox) `rectform`. Such a domain element (Symbolic Math Toolbox) consists of three operands, satisfying the following equality:  $z = \text{op}(r, 1) + I*\text{op}(r, 2) + \text{op}(r, 3)$ . The first two operands are real arithmetical expressions, and the third operand is an expression that cannot be split into its real and imaginary part.

Sometimes `rectform` is unable to compute the required decomposition. Then it still tries to return some partial information by extracting as much as possible from the real and imaginary part of  $z$ . The extracted parts are stored in the first two operands, and the third operand contains the remainder, where no further extraction is possible. In extreme cases, the first two operands may even be zero. “Example 6” on page 1-1779 (Symbolic Math Toolbox) illustrates some possible cases.

Arithmetical operations with elements of the domain type `rectform` are possible. The result of an arithmetical operation is again an element of this domain (see “Example 4” on page 1-1777 (Symbolic Math Toolbox)).

Most MuPAD functions handling arithmetical expressions (Symbolic Math Toolbox) (e.g., `expand`, `normal`, `simplify` etc.) can be applied to elements of type `rectform`. They act on each of the three operands individually.

Use `expr` to convert the result of `rectform` into an element of a basic domain (Symbolic Math Toolbox). See “Example 4” on page 1-1777 (Symbolic Math Toolbox).

## Environment Interactions

The function is sensitive to properties (Symbolic Math Toolbox) of identifiers set via `assume`. See “Example 3” on page 1-1776 (Symbolic Math Toolbox).



## Examples

### Example 1

The rectangular form of  $\sin(z)$  for complex values  $z$  is:

```
delete z: r := rectform(sin(z))
```

$$\cosh(\Im(z)) \sin(\Re(z)) + (\cos(\Re(z)) \sinh(\Im(z))) i$$

The real and the imaginary part can be extracted as follows:

```
Re(r), Im(r)
```

$$\cosh(\Im(z)) \sin(\Re(z)), \cos(\Re(z)) \sinh(\Im(z))$$

The complex conjugate of  $r$  can be obtained directly:

```
conjugate(r)
```

$$\cosh(\Im(z)) \sin(\Re(z)) - (\cos(\Re(z)) \sinh(\Im(z))) i$$

### Example 2

The real and the imaginary part of a constant arithmetical expression can be determined by the functions `Re` and `Im`, as in the following example:

```
Re(ln(-4)) + I*Im(ln(-4))
```

$$\ln(4) + \pi i$$

In fact, they work much faster than `rectform`. However, they fail to compute the real and the imaginary part of arbitrary symbolic expressions, such as for the term  $e^{i\sin(z)}$ :

```
delete z: f := exp(I*sin(z)):
Re(f), Im(f)
```

$$\Re\left(e^{\sin(z) i}\right), \Im\left(e^{\sin(z) i}\right)$$

The function `rectform` is more powerful. It is able to split the expression above into its real and imaginary part:

```
r := rectform(f)
```

$$\begin{aligned} & \cos(\cosh(\Im(z)) \sin(\Re(z))) e^{-\cos(\Re(z)) \sinh(\Im(z))} \\ & + \left( \sin(\cosh(\Im(z)) \sin(\Re(z))) e^{-\cos(\Re(z)) \sinh(\Im(z))} \right) i \end{aligned}$$

Now we can extract the real and the imaginary part of `f`:

```
Re(r)
```

$$\cos(\cosh(\Im(z)) \sin(\Re(z))) e^{-\cos(\Re(z)) \sinh(\Im(z))}$$

```
Im(r)
```

$$\sin(\cosh(\Im(z)) \sin(\Re(z))) e^{-\cos(\Re(z)) \sinh(\Im(z))}$$

### Example 3

Identifiers without properties are considered to be complex variables:

```
delete z: rectform(ln(z))
```

$$\frac{\ln(\Im(z)^2 + \Re(z)^2)}{2} + \arg(\Im(z) i + \Re(z)) i$$

However, you can affect the behavior of `rectform` by attaching properties to the identifiers. For example, if `z` assumes only real negative values, the real and the imaginary part simplify considerably:

```
assume(z < 0): rectform(ln(z))
```

$$\ln(-z) + \pi i$$

### Example 4

We compute the rectangular form of the complex variable  $x$ :

```
delete x: a := rectform(x)
```

$$\Re(x) + \Im(x) i$$

Then we do the same for the real variable  $y$ :

```
delete y: assume(y, Type::Real): b := rectform(y)
```

$$y$$

```
domtype(a), domtype(b)
```

```
rectform, rectform
```

We have stored the results, i.e., the elements of domain type `rectform`, in the two identifiers `a` and `b`. We compute the sum of `a` and `b`, which is again of domain type `rectform`, i.e., it is already splitted into its real and imaginary part:

```
c := a + b
```

$$y + \Re(x) + \Im(x) i$$

```
domtype(c)
```

```
rectform
```

The result of an arithmetical operation between an element of domain type `rectform` and an arbitrary arithmetical expression is of domain type `rectform` as well:

```
delete z: d := a + 2*b + exp(z)
```

$$2 y + \Re(x) + \cos(\Im(z)) e^{\Re(z)} + \left( \Im(x) + \sin(\Im(z)) e^{\Re(z)} \right) i$$

`domtype(d)`

`rectform`

Use the function `expr` to convert an element of domain type `rectform` into an element of a basic domain:

`expr(d)`

$$2 y + \Im(x) i + \Re(x) + \cos(\Im(z)) e^{\Re(z)} + \sin(\Im(z)) e^{\Re(z)} i$$

`domtype(%)`

`DOM_EXPR`

## Example 5

`rectform` also works for polynomials on page 1-1601 and series expansions on page 1-461 (Symbolic Math Toolbox), namely individually on each coefficient:

```
delete x, y: p := poly(ln(-4) + y*x, [x]):
rectform(p)
```

$$\text{poly}((\Re(y) + \Im(y) i) x + \ln(4) + \pi i, [x])$$

Similarly, `rectform` works for lists on page 7-41, sets on page 7-50, or arrays on page 7-2, where it is applied to each individual entry:

```
a := array(1..2, [x, y]):
rectform(a)
```

$$(\Re(x) + \Im(x) i \ \Re(y) + \Im(y) i)$$

hfarrays are returned unchanged:

```
a := hfarray(1..2, [1.0, 2.0]):
rectform(a)
```

```
( 1.0 2.0 )
```

Note that `rectform` does not work directly for other basic data types. For example, if the input expression is a table on page 1-2103 of arithmetical expressions, then `rectform` responds with an error message:

```
a := table("1st" = x, "2nd" = y):
rectform(a)
```

```
Error: Arithmetical expression expected. [rectform::new]
```

Use `map` to apply `rectform` to the operands of such an object:

```
map(a, rectform)
```

```
-----
"1st" | ℑ(x) i + ℞(x)
"2nd" | ℑ(y) i + ℞(y)
```

## Example 6

This example illustrates the meaning of the three operands of an object returned by `rectform`.

We start with the expression  $x + \sin(y)$ , for which `rectform` is able to compute a complete decomposition into real and imaginary part:

```
delete x, y: r := rectform(x + sin(y))
```

```
℞(x) + cosh(ℑ(y)) sin(℞(y)) + (ℑ(x) + cos(℞(y)) sinh(ℑ(y))) i
```

The first two operands of `r` are the real and imaginary part of the expression, and the third operand is 0:

```
op(r)
```

$$\Re(x) + \cosh(\Im(y)) \sin(\Re(y)), \Im(x) + \cos(\Re(y)) \sinh(\Im(y)), 0$$

Next we consider the expression  $x + f(y)$ , where  $f(y)$  represents an unknown function in a complex variable. `rectform` can split  $x$  into its real and imaginary part, but fails to do this for the subexpression  $f(y)$ :

```
delete f: r := rectform(x + f(y))
```

$$\Re(x) + \Im(x) i + f(y)$$

The first two operands of the returned object are the real and the imaginary part of  $x$ , and the third operand is the remainder  $f(y)$ , for which `rectform` was not able to extract any information about its real and imaginary part:

```
op(r)
```

$$\Re(x), \Im(x), f(y)$$

```
Re(r), Im(r)
```

$$\Re(f(y)) + \Re(x), \Im(f(y)) + \Im(x)$$

Sometimes `rectform` is not able to extract any information about the real and imaginary part of the input expression. Then the third operand contains the whole input expression, possibly in a rewritten form, due to the recursive mode of operation of `rectform`. The first two operands are 0. Here is an example:

```
r := rectform(sin(x + f(y)))
```

$$\sin(\Im(x) i + \Re(x) + f(y))$$

```
op(r)
```

$$0, 0, \sin(\Re(x) + f(y) + \Im(x) i)$$

```
Re(r), Im(r)
```

$$\Re(\sin(\Re(x) + f(y) + \Im(x) i)), \Im(\sin(\Re(x) + f(y) + \Im(x) i))$$

## Example 7

Advanced users can extend `rectform` to their own special mathematical functions (see section "Backgrounds" below). To this end, embed your mathematical function into a function environment on page 7-25f and implement the behavior of `rectform` for this function as the "rectform" slot of the function environment.

If a subexpression of the form  $f(u, \dots)$  occurs in  $z$ , then `rectform` issues the call `f::rectform(u, ...)` to the slot routine to determine the rectangular form of  $f(u, \dots)$ .

For illustration, we show how this works for the sine function. Of course, the function environment `sin` already has a "rectform" slot. We call our function environment `Sin` in order not to overwrite the existing system function `sin`:

```
Sin := funcenv(Sin):
Sin::rectform := proc(u) // compute rectform(Sin(u))
  local r, a, b;
begin
  // recursively compute rectform of u
  r := rectform(u);

  if op(r, 3) <> 0 then
    // we cannot split Sin(u)
    new(rectform, 0, 0, Sin(u))
  else
    a := op(r, 1); // real part of u
    b := op(r, 2); // imaginary part of u
    new(rectform, Sin(a)*cosh(b), cos(a)*sinh(b), 0)
  end_if
end:
delete z: rectform(Sin(z))
```

$$\sin(\Re(z)) \cosh(\Im(z)) + (\cos(\Re(z)) \sinh(\Im(z))) i$$

If the `if` condition is true, then `rectform` is unable to split  $u$  completely into its real and imaginary part. In this case, `Sin::rectform` is unable to split `Sin(u)` into its real and imaginary part and indicates this by storing the whole expression `Sin(u)` in the third operand of the resulting `rectform` object:

```
delete f: rectform(Sin(f(z)))
```

```
Sin(f(z))
```

```
op(%)
```

```
0, 0, Sin(f(z))
```

## Parameters

**z**

An arithmetical expression (Symbolic Math Toolbox), a polynomial (Symbolic Math Toolbox), a series expansion, an array on page 7-2, an harray on page 7-27, a list on page 7-41, or a set on page 7-50

## Return Values

Element of the domain `rectform` if `z` is an arithmetical expression (Symbolic Math Toolbox), and an object of the same type as `z` otherwise.

## Function Calls

Calling an element of `rectform` as a function yields the object itself, regardless of the arguments. The arguments are *not* evaluated.

## Operations

You can apply (almost) any function to elements of `rectform` which transforms a complex-valued expression into a complex-valued expression.

For example, you may add or multiply those elements, or apply functions such as `expand` and `diff` to them. The result of such an operation, which is not explicitly overloaded by a method of `rectform` (see below), is an element of `rectform`.



This “automatic overloading” works as follows: Each argument of the operation, which is an element of `rectform`, is converted to an expression using the method `"expr"` (see below). Then, the operation is applied and the result is re-converted to an element of `rectform`.

Use the function `expr` to convert an element of `rectform` to an arithmetical expression (as an element of a kernel domain).

The functions `Re` and `Im` return the real and imaginary part of elements of `rectform`.

## Operands

An element  $z$  of `rectform` consists of three operands:

- 1 the real part of  $z$ ,
- 2 the imaginary part of  $z$ ,
- 3 the part of  $z$ , for that the real and imaginary part cannot be computed (possibly the integer 0, if there are not such subexpressions).

## Algorithms

If a subexpression of the form  $f(u, \dots)$  occurs in  $z$  and  $f$  is a function environment on page 7-25, then `rectform` attempts to call the slot `"rectform"` of  $f$  to determine the rectangular form of  $f(u, \dots)$ . In this way, you can extend the functionality of `rectform` to your own special mathematical functions.

The slot `"rectform"` is called with the arguments  $u, \dots$  of  $f$ . If the slot routine `f::rectform` is not able to determine the rectangular form of  $f(u, \dots)$ , then it should return `new(rectform(0,0,f(u, ...)))`. See “Example 7” on page 1-1781 (Symbolic Math Toolbox). If  $f$  does not have a slot `"rectform"`, then `rectform` returns the object `new(rectform(0,0,f(u, ...)))` for the corresponding subexpression.

Similarly, if an element  $d$  of a library domain (Symbolic Math Toolbox)  $T$  occurs as a subexpression of  $z$ , then `rectform` attempts to call the slot `"rectform"` of that domain with  $d$  as argument to compute the rectangular form of  $d$ .

If the slot routine `T::rectform` is not able to determine the rectangular form of  $d$ , then it should return `new(rectform(0,0,d))`.

If the domain  $T$  does not have a slot "rectform", then `rectform` returns the object `new(rectform(0,0,d))` for the corresponding subexpression.

## See Also

### MuPAD Functions

`Im` | `Re` | `abs` | `assume` | `collect` | `combine` | `conjugate` | `expand` | `normal` | `radsimp`  
| `rewrite` | `sign` | `simplify`

### Topics

"Manipulate Expressions" (Symbolic Math Toolbox)

"Choose Simplification Functions" (Symbolic Math Toolbox)

# rectangularPulse

Rectangular pulse function

## Syntax

`rectangularPulse(a, b, x)`

`rectangularPulse(x)`

## Description

`rectangularPulse(a, b, x)` represents the rectangular function.

`rectangularPulse(x)` is a shortcut for `rectangularPulse(-1/2, 1/2, x)`.

The rectangular function is also called the rectangle function, box function, Pi function, or gate function.

If  $a$  and  $b$  are variables or expressions with variables, `rectangularPulse` assumes that  $a < b$ . If  $a$  and  $b$  are numerical values, such that  $a > b$ , `rectangularPulse` throws an error.

If  $a < x < b$ , the rectangular pulse function equals 1. If  $x = a$  or  $x = b$ , the rectangular pulse function equals 1/2. Otherwise, it equals 0. See “Example 1” on page 1-1786 (Symbolic Math Toolbox) and “Example 2” on page 1-1786 (Symbolic Math Toolbox).

If  $a = b$ , `rectangularPulse` returns 0. See “Example 3” on page 1-1786 (Symbolic Math Toolbox).

`rectangularPulse(x)` is equivalent to `rectangularPulse(-1/2, 1/2, x)`. See “Example 4” on page 1-1786 (Symbolic Math Toolbox).

`rectangularPulse` also accepts infinities as its arguments. See “Example 7” on page 1-1788 (Symbolic Math Toolbox).

`rectangularPulse` and `rectpulse` are equivalent.

## Examples

### Example 1

Compute the rectangular pulse function for these input arguments:

```
[rectangularPulse(-1, 1, -2), rectangularPulse(-1, 1, -1),  
rectangularPulse(-1, 1, 0), rectangularPulse(-1, 1, 1),  
rectangularPulse(-1, 1, 2)]
```

```
[0, 1/2, 1, 1/2, 0]
```

### Example 2

If  $a < b$ , the rectangular pulse function for  $x = a$  and  $x = b$  equals  $1/2$ :

```
assume(a < b);  
[rectangularPulse(a, b, a), rectangularPulse(a, b, b)]
```

```
[1/2, 1/2]
```

### Example 3

For  $a = b$ , the rectangular pulse function returns 0:

```
rectangularPulse(a, a, x)
```

```
0
```

### Example 4

Use `rectangularPulse` with one input argument as a shortcut for computing `rectangularPulse(-1/2, 1/2, x)`:

```
rectangularPulse(x)
```

$$\text{rectangularPulse}\left(-\frac{1}{2}, \frac{1}{2}, x\right)$$

```
[rectangularPulse(-1), rectangularPulse(-1/2), rectangularPulse(0),  
rectangularPulse(1/2), rectangularPulse(1)]
```

$$\left[0, \frac{1}{2}, 1, \frac{1}{2}, 0\right]$$

### Example 5

Rewrite the rectangular pulse function in terms of the Heaviside step function:

```
rewrite(rectangularPulse(a, b, x), heaviside)
```

$$\text{heaviside}(x - a) - \text{heaviside}(x - b)$$

### Example 6

Plot the rectangular pulse function:

```
plot(rectangularPulse(x), x = -1..1)
```

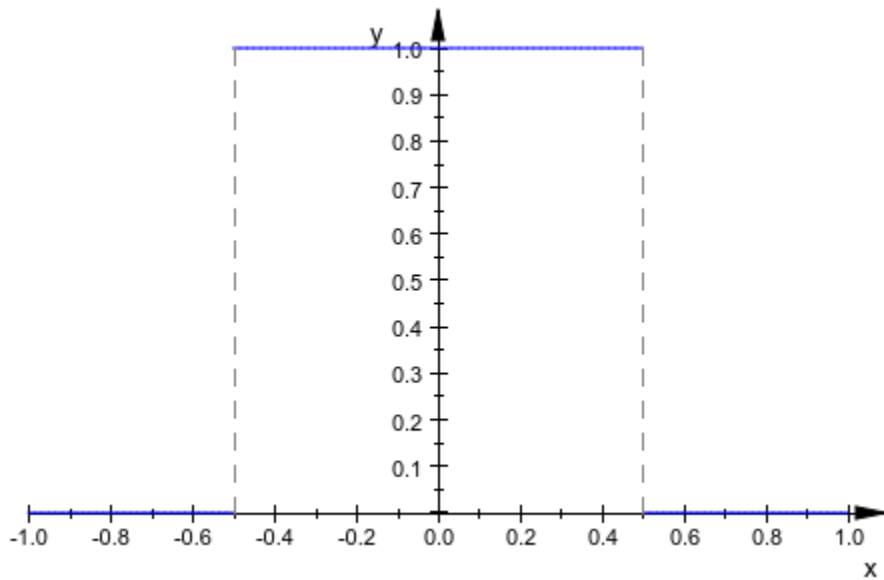

### Example 7

Plot the rectangular pulse function for which the argument  $b$  is a positive infinity:

```
plot(rectangularPulse(0, infinity, x))
```

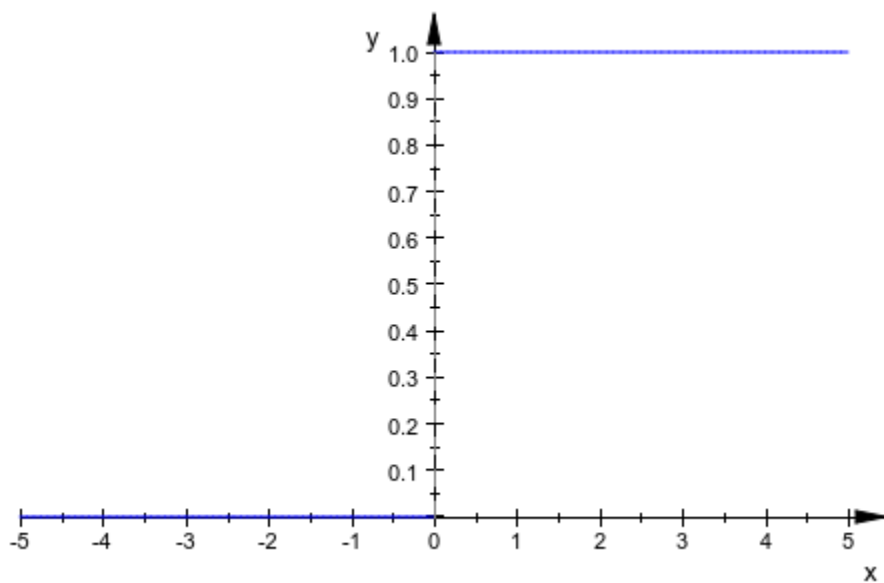

## Parameters

**a, b, x**

Arithmetical expressions. (Symbolic Math Toolbox)

## Return Values

Arithmetical expression.

## Overloaded By

x

## See Also

### MuPAD Functions

heaviside | piecewise | triangularPulse



# rectpulse

Rectangular pulse function

## Syntax

`rectpulse(a, b, x)`

`rectpulse(x)`

## Description

`rectpulse(a, b, x)` represents the rectangular pulse function.

`rectpulse(x)` is a shortcut for `rectpulse(-1/2, 1/2, x)`.

`rectpulse` and `rectangularPulse` are equivalent. These functions represent the rectangular pulse function. For details and examples, see `rectangularPulse`.

## Parameters

**a, b, x**

Arithmetical expressions. (Symbolic Math Toolbox)

## Return Values

Arithmetical expression.

## Overloaded By

x

## See Also

### **MuPAD Functions**

heaviside | piecewise | rectangularPulse | triangularPulse

## rem

Remainder after division

### Syntax

`rem(a,b)`

### Description

`rem(a,b)` finds the remainder after division. If  $b \neq 0$ , then  $\text{rem}(a,b) = a - \text{trunc}(a/b)*b$ . See “Example 1” on page 1-1793 (Symbolic Math Toolbox) and “Example 2” on page 1-1794 (Symbolic Math Toolbox).

If  $b = 0$  or  $b = \text{infinity}$  or  $b = -\text{infinity}$ , then `rem` returns undefined.

The `rem` function does not support complex numbers: all values must be real numbers.

### Examples

#### Example 1

Find the remainder after division in case both the dividend and divisor are integers.

Find the modulus after division for these numbers.

`rem(27, 4)`, `rem(27, -4)`, `rem(-27, 4)`, `rem(-27, -4)`

3, 3, -3, -3

## Example 2

Find the remainder after division in case the dividend is a rational number, and the divisor is an integer.

Find the remainder after division for these numbers.

`rem(22/3, 5), rem(1/2, -7), rem(27/6, -11)`

$\frac{7}{3}, \frac{1}{2}, \frac{9}{2}$

## Example 3

Find the remainder after division in case the dividend and divisor are floating-point numbers.

`rem(2.3, 0.2), rem(-4.5, 1.3), rem(2.7, 1.0)`

$0.1, -0.6, 0.7$

## Parameters

**a**

A real number

**b**

A real number

## Return Values

A number or an arithmetical expression (Symbolic Math Toolbox).

## Overloaded By

a, b

## See Also

### MuPAD Domains

Dom::IntegerMod

### MuPAD Functions

/ | IntMod | div | divide | frac | gcd | gcdex | igcd | igcdex | mod | modp | mods |  
powermod

## Topics

“Modular Arithmetic” (Symbolic Math Toolbox)

## reset

Re-initialize a session

### Syntax

`reset()`

### Description

`reset()` re-initializes a MuPAD session, so that the current session will behave like a freshly started MuPAD session.

`reset` deletes the values of all identifiers on page 7-29 and resets the environment variables to their default values. Finally, the initialization files `sysinit.mu` and `userinit.mu` are read again.

`reset` is permitted only at interactive level. Within a procedure on page 7-45, an error occurs.

### Examples

#### Example 1

`reset` deletes the values of all identifiers and resets environment variables to their default values:

```
a := 1: DIGITS := 5: reset(): a, DIGITS
```

```
a, 10
```

## Return Values

Void object `null()` of type `DOM_NULL`.

## See Also

### MuPAD Functions

`delete`

# return

Exit a procedure

## Syntax

`return(x)`

## Description

`return(x)` terminates the execution of a procedure and returns `x`.

Usually, MuPAD ends a procedure on page 7-45 when all statements of the procedure body were processed. In this case, the return value of the procedure is the result of the last statement that was executed.

Alternatively, the call `return(x)` inside a procedure leads to immediate exit from the procedure: `x` is evaluated and becomes the return value of the procedure. Execution proceeds after the point where the procedure was invoked.

`x` may be an expression sequence on page 1-88, i.e., calls such as `return(x1, x2, ...)` are allowed.

`return()` returns the void object of type `DOM_NULL`.

Note that `return` is a function, not a keyword. A statement such as `return x;` works in the programming language C, but causes a syntax error in MuPAD.

If called outside a procedure, `return(x)` just returns `x`.

## Examples

### Example 1

This example shows the implementation of a maximum function (which, in contrast to the system function `max`, accepts only two arguments). If `x` is larger than `y`, the value of `x` is



returned and the execution of the procedure `mymax` stops. Otherwise, `return(x)` is not called. Consequently, `y` is the last evaluated object defining the return value:

```
mymax := proc(x : Type::Real, y : Type::Real)
begin
  if x > y then
    return(x)
  end_if;
  y
end_proc;

mymax(3, 2), mymax(4, 5)
```

3, 5

```
delete mymax;
```

## Example 2

`return()` returns the void object:

```
f := x -> return(): type(f(anything))
```

DOM\_NULL

```
delete f;
```

## Example 3

If `return` is called on the interactive level, the evaluated arguments are returned:

```
x := 1: return(x, y)
```

1, y

```
delete x;
```

## Parameters

**x**

Any MuPAD object

## Return Values

X.

## See Also

**MuPAD Domains**

DOM\_PROC

**MuPAD Functions**

-> | proc

# revert

Revert polynomials, lists, character strings and tables, invert series expansions

## Syntax

```
revert(object)
```

## Description

`revert` reverses the ordering of the elements in a list and the ordering of characters in a string, as well as the ordering of the coefficients in a polynomial. For tables, it swaps indices and entries. For a series expansion, it returns the functional inverse.

`revert` is a general function to compute inverses with respect to functional composition, or to reverse the order of operands. This type of functionality may be extended to further types of objects via overloading.

Currently, the MuPAD library provides functionality for strings, polynomials, lists, and tables, where `revert` reverses the order of the elements, coefficients, or characters, respectively. In tables, entries are turned into indices and vice versa. E.g., `revert(table(x = y, 2 = 4))` yields the table `table(y = x, 4 = 2)`. For series expansions, the functional inverse is returned.

For all other types of MuPAD objects that do not overload `revert`, the symbolic expression `revert(object)` is returned.

## Examples

### Example 1

`revert` operates on lists and character strings:

```
revert([1, 2, 3, 4, 5])
```

[5, 4, 3, 2, 1]

`revert("nuf si DAPuM ni gnimmargorP")`

"Programming in MuPAD is fun"

revert operates on series:

`revert(series(sin(x), x)) = series(arcsin(x), x)`

$$x + \frac{x^3}{6} + \frac{3x^5}{40} + O(x^7) = x + \frac{x^3}{6} + \frac{3x^5}{40} + O(x^7)$$

revert operates on tables:

`t := table(): t[x] := 1: t[y] := 2: t[z] := 3:  
T := revert(t): T[1], T[2], T[3]`

x, y, z

Beware: if an entry is stored under several distinct indices, revert reduces the number of table operands:

`revert(table(x = 1, y = 1, z = 3))`

$\overline{1} \mid y$   
 $3 \mid z$

The functional inverse of the expansion of  $\exp$  around  $x = 0$  is the expansion of the inverse function  $\ln$  around  $x = \exp(0) = 1$ :

`revert(series(exp(x), x, 3)) = series(ln(x), x = 1, 2)`

$$x - 1 - \frac{(x-1)^2}{2} + O((x-1)^3) = x - 1 - \frac{(x-1)^2}{2} + O((x-1)^3)$$

`delete t, T:`

## Example 2

revert computes the reverse of a polynomial:

```
revert(poly(x^3 + 2*x + 5))
```

$$\text{poly}(5x^3 + 2x^2 + 1, [x])$$

The same works for multivariate polynomials, too:

```
revert(poly(x^3 + 2*x*y + 5*x + 6*y + 7))
```

$$\text{poly}(7x^3y + 6x^3 + 5x^2y + 2x^2 + y, [x, y])$$

We could have achieved the same by substituting all indeterminates by their inverses; however, revert works faster.

```
numer(evalp(poly(x^3 + 2*x*y + 5*x + 6*y + 7), x = 1/x, y = 1/y))
```

$$y + 5x^2y + 7x^3y + 2x^2 + 6x^3$$

## Example 3

For all other types of objects, a symbolic function call is returned:

```
revert(x + y)
```

$$\text{revert}(x + y)$$

The following series expansion is not of type `Series::Puisseux`. Instead, a generalized expansion of type `Series::gseries` is produced. Consequently, revert does not compute an inverse:

```
revert(series(exp(-x)/(1 + x), x = infinity, 3))
```

$$\text{revert}\left(\frac{e^{-x}}{x} - \frac{e^{-x}}{x^2} + \frac{e^{-x}}{x^3} + O\left(\frac{e^{-x}}{x^4}\right)\right)$$

## Parameters

### object

A polynomial on page 1-1601, a list on page 7-41, a character string on page 7-53, a table on page 1-2103, or a series expansion of type `Series::Puisseux`

## Return Values

Object of the same type as the input object, or a symbolic call of type "revert".

## Overloaded By

object

## See Also

### MuPAD Functions

`series` | `sort` | `substring`

# rewrite

Rewrite an expression

## Syntax

```
rewrite(f, target)
```

## Description

`rewrite(f, target)` transforms an expression `f` to a mathematically equivalent form, trying to express `f` in terms of the specified target function.

The target indicates the function that is to be used in the desired representation. Symbolic function calls in `f` are replaced by the target function if this is mathematically valid.

With the target `arg`, the function `ln(sign(x))` is rewritten as `arg(x)`.

With the target `exp`, all trigonometric and hyperbolic functions are rewritten in terms of `exp`. Further, the inverse functions as well as `arg` are rewritten in terms of `ln`.

With the target `sincos`, the functions `tan`, `cot`, `exp`, `sinh`, `cosh`, `tanh`, and `coth` are rewritten in terms of `sin` and `cos`.

With the target `sin`, the same is done as in the case of `sincos`. Additionally, `cos(x)2` is rewritten as `1 - sin(x)2`. This holds for the target `cos` analogously.

With the target `sinhcosh`, the functions `exp`, `tanh`, `coth`, `sin`, `cos`, `tan`, and `cot` are rewritten in terms of `sinh` and `cosh`. With the targets `sinh` and `cosh`, the same is done, and `cosh(x)2` is rewritten in terms of `sinh` (or `sinh(x)2` in terms of `cosh`, respectively.)

With the targets `arcsin`, `arccos`, `arctan`, and `arccot`, the logarithm, all inverse trigonometric functions, and all inverse hyperbolic functions are rewritten in terms of the target function.

With the targets `arcsinh`, `arccosh`, `arctanh`, and `arccoth`, the logarithm, all inverse hyperbolic functions and all inverse trigonometric functions are rewritten in terms of the target function.

With the target `lambertW`, the function `wrightOmega` is rewritten in terms of `lambertW`.

With the target `erf`, the functions `erfc`, `erfi`, and `dawson` are rewritten in terms of `erf`.

With the target `erfc`, the functions `erf`, `erfi`, and `dawson` are rewritten in terms of `erfc`.

With the target `erfi`, the functions `erf`, `erfc`, and `dawson` are rewritten in terms of `erfi`.

With the target `bernoulli`, the function `euler` is rewritten in terms of `bernoulli`.

With the target `diff`, symbolic calls of the differential operator `D` are rewritten in terms of symbolic calls of the function `diff`. E.g.,  $D(f)(x)$  is converted to `diff(f(x), x)`. A univariate expression  $D(f)(x)$  is rewritten if `x` is an identifier on page 7-29 or an indexed identifier on page 1-1017. A multivariate expression  $D([n1, n2, \dots], f)(x1, x2, \dots)$  is rewritten if `x1`, `x2` are *distinct* identifiers or indexed identifiers. Trying to rewrite a multivariate call  $D(f)(x1, x2, \dots)$  of the univariate derivative  $D(f)$  raises an error.

With the target `D`, symbolic `diff` calls are rewritten in terms of the differential operator `D`. Derivatives of univariate function calls such as `diff(f(x), x)` are rewritten as  $D(f)(x)$ . Derivatives of multivariate function calls are expressed via  $D([n1, n2, \dots], f)$ . E.g., `diff(f(x, y), x)` is rewritten as  $D([1], f)(x, y)$ .

With the target `andor`, the logical operators `xor`, `==>`, and `<=>` are rewritten in terms of `and`, `or`, and `not`.

With the targets `min` and `max`, expressions in `max` and `min` and, for real arguments, `abs` are rewritten in terms of the target function.

The targets `harmonic` and `psi` serve for rewriting symbolic calls of `psi` in terms of `harmonic` and vice versa.

With the target `inverf`, the function `inverfc(x)` is rewritten as `inverf(1 - x)`.

With the target `inverfc`, the function `inverf(x)` is rewritten as `inverfc(1 - x)`.



## Examples

### Example 1

This example demonstrates the use of rewrite:

```
rewrite(D(D(f))(x), diff)
```

$$\frac{\partial^2}{\partial x^2} f(x)$$

```
diff(f(x, x), x) = rewrite(diff(f(x, x), x), D)
```

$$\frac{\partial}{\partial x} f(x, x) = D_1(f)(x, x) + D_2(f)(x, x)$$

```
assume(n, Type::PosInt):
rewrite(fact(n), gamma), rewrite(gamma(n), fact);
delete n:
```

$$\Gamma(n+1), (n-1)!$$

```
rewrite(sign(x), heaviside), rewrite(heaviside(x), sign);
```

$$2 \text{ heaviside}(x) - 1, \frac{\text{sign}(x)}{2} + \frac{1}{2}$$

```
rewrite(heaviside(x), piecewise)
```

$$\begin{cases} \frac{1}{2} & \text{if } x = 0 \\ 1 & \text{if } 0 < x \\ 0 & \text{if } x < 0 \end{cases}$$

## Example 2

Trigonometric functions can be rewritten in terms of exp, sin, cos etc.:

```
rewrite(tan(x), exp), rewrite(cot(x), sincos),  
rewrite(sin(x), tan)
```

$$-\frac{e^{2xi} - i - i}{e^{2xi} + 1}, \frac{\cos(x)}{\sin(x)}, \frac{2 \tan(\frac{x}{2})}{\tan(\frac{x}{2})^2 + 1}$$

```
rewrite(arcsinh(x), ln)
```

$$\ln\left(x + \sqrt{x^2 + 1}\right)$$

## Example 3

Inverse trigonometric functions can be rewritten in terms of each other:

```
rewrite(arcsin(x), arctan)
```

$$2 \arctan\left(\frac{x}{\sqrt{1-x^2} + 1}\right)$$

The following result uses the function `signIm` (“sign of the imaginary part”) to make the formula valid throughout the complex plane (apart from the singularities at  $x = \pm\sqrt{-1}$ ):

```
rewrite(arctan(x), arcsin)
```

$$\text{signIm}(xi) \left( \frac{\pi}{2} - \arcsin\left(\frac{1}{\sqrt{x^2 + 1}}\right) \right)$$

## Parameters

**f**

An arithmetical or boolean expression (Symbolic Math Toolbox)

**target**

The target function to be used in the representation: one of `andor`, `arccos`, `arccosh`, `arccot`, `arccoth`, `arcsin`, `arcsinh`, `arctan`, `arctanh`, `arg`, `bernoulli`, `cos`, `cosh`, `cot`, `coth`, `diff`, `D`, `erf`, `erfc`, `erfi`, `exp`, `fact`, `gamma`, `harmonic`, `heaviside`, `inverf`, `inverfc`, `lambertW`, `ln`, `max`, `min`, `piecewise`, `psi`, `sign`, `sin`, `sincos`, `sinh`, `sinhcosh`, `tan`, or `tanh`

## Return Values

arithmetical expression (Symbolic Math Toolbox).

## Overloaded By

f

## See Also

### MuPAD Functions

`collect` | `combine` | `expand` | `factor` | `normal` | `partfrac` | `rationalize` | `rectform` | `simplify`

## Topics

“Manipulate Expressions” (Symbolic Math Toolbox)

“Choose Simplification Functions” (Symbolic Math Toolbox)

## RootOf

Set of roots of a polynomial

### Syntax

`RootOf(f, x)`

`RootOf(f)`

### Description

`RootOf(f, x)` represents the symbolic set of roots of the polynomial  $f(x)$  with respect to the indeterminate  $x$ .

`RootOf` serves as a symbolic representation of the zero set of a polynomial. Since it is generally impossible to represent the roots of a polynomial in terms of radicals, `RootOf` is often the only possible way to represent the roots symbolically. `RootOf` mainly occurs in the output of `solve` or related functions; see “Example 3” on page 1-1812 (Symbolic Math Toolbox).

The parameter  $f$  must be either a polynomial (Symbolic Math Toolbox), or an arithmetical expression (Symbolic Math Toolbox) representing a polynomial in  $x$ , or an equation  $p=q$ , where  $p$  and  $q$  are arithmetical expressions representing polynomials in  $x$ . In the latter case, `RootOf` represents the roots of  $p-q$  with respect to  $x$ .

The polynomial  $f$  need not be irreducible or even square-free. If  $f$  has multiple roots, `RootOf` represents each of the roots with its multiplicity.

If  $x$  is omitted, then  $f$  must be an arithmetical expression (Symbolic Math Toolbox) or polynomial equation containing exactly one indeterminate, and `RootOf` represents the roots with respect to this indeterminate.

$x$  need not be an identifier or indexed identifier: it may be any expression that is neither rational nor constant.

If  $f$  contains only one indeterminate, then you can apply `float` to the `RootOf` object to obtain a set of floating-point approximations for all roots; see “Example 3” on page 1-1812 (Symbolic Math Toolbox).

## Examples

### Example 1

Each of the following calls represents the roots of the polynomial  $x^3 - x^2$  with respect to  $x$ , i.e., the set  $\{0, 1\}$ :

`RootOf(x^3 - x^2, x), RootOf(x^3 = x^2, x)`

$\text{RootOf}(x^3 - x^2, x), \text{RootOf}(x^3 - x^2, x)$

`RootOf(x^3 - x^2), RootOf(x^3 = x^2)`

$\text{RootOf}(x^3 - x^2, x), \text{RootOf}(x^3 - x^2, x)$

`RootOf(poly(x^3 - x^2, [x]), x)`

$\text{RootOf}(x^3 - x^2, x)$

In general, however, `RootOf` is only used when no explicit symbolic representation of the roots is possible.

### Example 2

The first argument of `RootOf` may contain parameters:

`RootOf(y*x^2 - x + y^2, x)`

$\text{RootOf}(x^2 y - x + y^2, x)$

The set of roots of a polynomial is treated like an expression. For example, it may be differentiated with respect to a free parameter. The result is the set of derivatives of the roots; it is expressed in terms of `RootOf`, by giving a minimal polynomial:

```
diff(%, y)
```

$$\text{RootOf}(4x^2y^5 - x^2y^2 + 4xy^3 - x + y^4 + 2y, x)$$

For reducible polynomials, the result may be a multiple of the correct minimal polynomial.

### Example 3

`solve` returns `RootOf` objects when the roots of a polynomial cannot be expressed in terms of radicals:

```
solve(x^5 + x + 7, x)
```

$$\text{RootOf}(z^5 + z + 7, z)$$

You can apply the function `float` to obtain floating-point approximations of all roots:

```
float(%)
```

$$\{-1.410813851, -0.508469409 + 1.368616488i, -0.508469409 - 1.368616488i, 1.213876335 + 0.9241881109i, 1.213876335 - 0.9241881109i\}$$

### Example 4

The function `sum` is able to compute sums over all roots of a given polynomial:

```
sum(i^2, i = RootOf(x^3 + a*x^2 + b*x + c, x))
```

$$a^2 - 2b$$

```
sum(1/(z + i), i = RootOf(x^4 - y*x + 1, x))
```

$$\frac{4z^3 + y}{z^4 + yz + 1}$$

## Example 5

A `RootOf` object represents the set of all roots. One can address the individual roots via indexed calls:

```
RootOf(z^3 - 1, z)[i] $ i = 1..3
```

$$\text{RootOf}(z^3 - 1, z, 1), \text{RootOf}(z^3 - 1, z, 2), \text{RootOf}(z^3 - 1, z, 3)$$

```
float(RootOf(z^3 - 1, z)[i]) $ i = 1..3
```

$$1.0, -0.5 - 0.8660254038 i, -0.5 + 0.8660254038 i$$

## Parameters

**f**

A polynomial (Symbolic Math Toolbox), an arithmetical expression (Symbolic Math Toolbox) representing a polynomial in  $x$ , or a polynomial equation in  $x$

**x**

The indeterminate: typically, an identifier on page 7-29 or indexed identifier

## Return Values

Symbolic `RootOf` call, i.e., an expression on page 7-20 of type "RootOf".

## See Also

### **MuPAD Functions**

`isolate` | `numeric::polyroots` | `poly` | `solve`



# Rule

Defining equivalence rules for mathematical expressions

## Syntax

```
Rule(pattern, replacement, <conditions>)
```

```
Rule(procedure, <condProc>)
```

## Description

`Rule` is a data type. Each object of `Rule` - a rule - describes the equivalence between mathematical expressions. The arguments of a rule are two pattern expressions on page 1-1312, that are equivalent, and optional some conditions for the validity of the equivalence.

`Rule` can be applied to any expression, and returns an expression equivalent to the input, or `FAIL`.

Additionally, a rule can consist of a procedure that returns an equivalent expression to a given expression or `FAIL` *without* using the pattern matcher on page 1-1312.

Rules created with `Rule` are mainly used to build a rule base for the new `Simplify`. See the documentation of `Simplify` and “Example 8” on page 1-1822 (Symbolic Math Toolbox) for a real application of `Rule`. “Example 3” on page 1-1818 (Symbolic Math Toolbox) shows, how to implement rewriting rules via `Rule`.

All other examples are only given to explain the behavior of rules. In practice, single rules and their manual application is unusual.

There are two kinds of rules: Use the library pattern matcher to determine whether the rule is suitable, or use a user defined procedure to analyze a given expression and return an equivalent expression.

`Rule(pattern, replacement, conditions)` defines a rule that describes the equivalence of the expressions `pattern` and `replacement`.

When this rule is applied to a given expression `ex`, the pattern matcher on page 1-1312 is called with the arguments

```
match(ex, pattern, Cond = conditions)
```

and returns a set of replacements `S:={var = ex_var, ...}` for each variable `var` of `pattern`, and `ex_var` is the corresponding subexpression of `ex` (see `match` for detailed description).

In this case the result of the substitution `subs(replacement, S)` is returned as equivalent expression to `ex`.

The call to `match` can also return `FAIL`, when `ex` doesn't have the same structure as `pattern`. Then the return value of the rule application is `FAIL`, too.

See “Example 1” on page 1-1817 (Symbolic Math Toolbox) and “Example 2” on page 1-1817 (Symbolic Math Toolbox).

See `match` for the description of valid conditions.

Alternatively, a rule can consist of a procedure that is called with a given expression, and must return an equivalent expression or `FAIL`. The “pattern matcher” is not called.

`Rule(procedure, condProc)` defines such a rule that returns an equivalent expression to any given input as return value of `procedure` or `FAIL`.

The optional condition `condProc` must be a procedure, too. This procedure is called *before* the procedure that produces equivalent expressions, with a given expression `ex`. When the call `condProc(ex)` returns `TRUE`, then the return value of the call `procedure(ex)` is returned as the result of the application of the rule, otherwise `FAIL`.

With a rule that consists of a procedure, several relations `pattern <=> result` can be expressed. This is mostly more efficient, than using `match` for each equivalence.

See “Example 6” on page 1-1820 (Symbolic Math Toolbox) and “Example 7” on page 1-1821 (Symbolic Math Toolbox).

---

**Note** Rules with expressions as arguments must use identifiers that are protected from any assignment. Those identifiers must be of the form `#X`, where `X` can be any valid variable name. All variables that start with `#` in their names are protected by the kernel from any assignment.

---

## Examples

### Example 1

The first rule represents the simplification  $\sin(X)^2 + \cos(X)^2 = 1$ . The first argument of the rule is the expression  $\sin(X)^2 + \cos(X)^2$ . Each expression, which has the same structure, is found by `match`, and the second argument of the rule `1` is returned as result. There are no conditions for the validity of this equivalence. The identifiers used for defining the rule are write protected, because they have names beginning with `#`:

```
r := Rule(sin(`#X`)^2 + cos(`#X`)^2, 1):
Rule::apply(r, sin(2*x - 1)^2 + cos(2*x - 1)^2)
```

`1`

The next expression doesn't have the right form, the application of the rule fails:

```
Rule::apply(r, sin(2*x - 1)^2 + cos(2*x + 1)^2)
```

`FAIL`

### Example 2

The next rule represents the addition theorem  $\sin(X + Y) = \sin(X)\cos(Y) + \sin(Y)\cos(X)$ . The first argument of the rule is the expression  $\sin(X + Y)$ . Each expression that is a call to `sin` with a sum as argument, is identified by `match`, and the sum  $\sin(X)\cos(Y) + \sin(Y)\cos(X)$  is returned, where `X` and `Y` are replaced by the corresponding parts of the given expression. There are no conditions for the validity of this equivalence. The second part of the rule is prevented from evaluation with `hold`. The identifiers used for defining the rule are write protected, because they have names beginning with `#`:

```
r := Rule(sin(`#X` + `#Y`),
          hold(sin(`#X`)*cos(`#Y`) + sin(`#Y`)*cos(`#X`))):
Rule::apply(r, sin(tan(x) + tan(y)))
```

`cos(tan(x)) sin(tan(y)) + cos(tan(y)) sin(tan(x))`

The matcher identifies the difference of two expressions  $a$  and  $b$  as the sum  $a + -b$ , therefore also the following example works:

```
Rule::apply(r, sin(tan(x) - tan(y)))
```

```
cos(tan(y)) sin(tan(x)) - cos(tan(x)) sin(tan(y))
```

### Example 3

We define two rules based on the trigonometric identities  $\sin(x)^2 = 1 - \cos(x)^2$  and

$$\tan(x)^2 = \frac{1}{\cos(x)^2} - 1:$$

```
myrules := [Rule(sin(`#X`)^`#n`, (1 - cos(`#X`)^2)^(`#n`/2),
               {`#n` -> is(`#n`, Type::Even)}),
            Rule(tan(`#X`)^`#n`, (1/cos(`#X`)^2 - 1)^(`#n`/2),
               {`#n` -> is(`#n`, Type::Even)})
]:
```

We wish to apply these rules as rewriting rules to various expressions. We forward `Rule::apply` to all subexpressions of an expression via `misc::maprec`. For convenience, an interface function `myrewrite` is implemented that calls `misc::maprec`:

```
myrewrite:= proc(f, rules)
local _rewrite;
begin
  _rewrite:= proc(x)
local r, tmp;
begin
  for r in rules do
    tmp:= Rule::apply(r, x);
    if tmp <> FAIL then
      x:= tmp;
    end;
  end;
  return(x)
end;
misc::maprec(f, TRUE = _rewrite);
end:
```

Now we can call `myrewrite(f, myrules)` to apply the rewriting rules to an expression  $f$ :

```
f:= tan(x) + sin(2*x) - tan(y)^2*sin(x + 3)^6 + sin(x)^2 * tan(23)^4:
myrewrite(f, myrules);
```

$$\sin(2x) + \tan(x) + \left(\frac{1}{\cos(y)^2} - 1\right) (\cos(x+3)^2 - 1)^3 - \left(\frac{1}{\cos(23)^2} - 1\right)^2 (\cos(x)^2 - 1)$$

```
delete myrules, myrewrite, f:
```

## Example 4

Another rule represents the simplification  $\sin(X) = 0$ , which is only true, when  $X$  is an integer multiple of  $\text{PI}$ :

```
r := Rule(sin(`#X`), 0, {`#X` -> is(`#X`/PI, Type::Integer)}):
Rule::apply(r, sin(2*x*PI))
```

FAIL

In the last call, the argument of  $\sin$  doesn't have the necessary property, so the application of the rule fails.

After an assumption on page 1-265 to  $x$ , the expression has the right form:

```
assume(x, Type::Integer):
Rule::apply(r, sin(2*x*PI))
```

0

The next application of the rule checks a constant expression:

```
Rule::apply(r, sin(2*PI))
```

FAIL

Why FAIL? The problem is,  $\sin$  simplifies the constant input  $2*\text{PI}$  to  $0$  itself, so the rule gets  $0$  as input. However,  $0$  doesn't have the necessary form, so FAIL is returned.

## Example 5

Another rule represents the simplification  $\ln(\text{neg}^{\text{even}} r) = \text{even} \ln(-\text{neg}) + \ln(r)$ , which is only true, when `neg` is negative and `even` is an even number:

```
r := Rule(ln(`#Neg`#Even`*`#X`),
         `#Even`*ln(-`#Neg`) + ln(`#X`),
         {`#Neg` -> is(`#Neg`, Type::Negative) = TRUE,
          `#Even` -> is(`#Even`, Type::Even) = TRUE}):
delete e, n, x:
Rule::apply(r, ln(ne*x))
```

$$\ln(n^e x)$$

The rule application fails, because the variables doesn't have the necessary properties.

With an assumption `n` should be a negative variable and `e` should be even:

```
assume(n < 0): assume(e, Type::Even):
Rule::apply(r, ln(ne*x))
```

$$\ln(x) + e \ln(-n)$$

## Example 6

This rule represents the application of `rewrite` to an expression with the target `exp`, when the expression has subexpressions of type "sin" or "cos". The first argument of the rule is a procedure that calls `rewrite` with any expression and target `exp` and returns an expression equivalent to the input (because `rewrite` does it). The second argument is a procedure that checks, whether `sin` or `cos` is contained in the input expression:

```
r := Rule(X -> rewrite(X, exp), X -> has(X, sin) or has(X, cos)):
Rule::apply(r, sin(2*x - 1)^2 + cos(2*x - 1)^2)
```

$$\left(\frac{e^{-2xi+i}}{2} + \frac{e^{2xi-i}}{2}\right)^2 + \left(\frac{e^{-2xi+i}}{2}i - \frac{e^{2xi-i}}{2}i\right)^2$$

The next expression doesn't have `sin` or `cos`, so the application of the rule fails:

```
Rule::apply(r, tan(2*I*x))
```

FAIL

## Example 7

This rule represents the application of `rewrite` to an expression with several targets. The first argument of the rule is a procedure that applies `rewrite` to the given expression, with a target depending on the input. This rule doesn't have a condition procedure:

```
rewProc :=
  proc(ex)
  begin
    rewrite(ex, (if has(ex, exp) then
                  tan
                  elif has(ex, sin) or has(ex, cos) then
                  cot
                  elif has(ex, tan) or has(ex, cot) then
                  sincos
                  else
                  exp
                  end_if))
  end_proc:
r := Rule(rewProc):
Rule::apply(r, exp(2*x))
```

$$-\frac{\tan(x i) + i}{\tan(x i) - i}$$

The rule is applied again to the last result:

```
Rule::apply(r, %)
```

$$-\frac{\frac{\sin(x i)}{\cos(x i)} + i}{\frac{\sin(x i)}{\cos(x i)} - i}$$

The last result should be simplified back to the first expression:

```
Simplify(%)
```

$e^{2x}$

## Example 8

The new `Simplify` uses a rule base for applying a lot of rewriting rules for finding the simplest form of any given expression.

We want to rewrite only some powers and assume that all used variables are real (without using properties).

The list `PowerRules` consists of several rules. The procedure `powerRules` returns all this rules in a list.

Because of better readability, the names of the used identifiers are short and not protected names:

```
PowerRules :=
  [Rule(A^m*A^n, hold(A^(m + n))),
   Rule(A^m/A^n, hold(A^(m - n))),
   Rule(A^n*B^n, hold((A*B)^n)),
   Rule(A^n/B^n, hold((A/B)^n)),
   Rule(A^n/B^n, hold((B/A)^-n)),
   Rule((A^m)^n, hold(A^(m*n))]:
powerRules := proc()
  begin
    PowerRules
  end_proc:
```

`Simplify` is called with the option `SelectRules`, and expects a procedure that returns a list of rules, applicable to a given expression. In this case, all of the rules are returned in every case.

`Simplify` applies all rules to a given expression and also to rewritten results, and tries to find the easiest form of the expression with respect to the default valuation procedure `Simplify::complexity`.

Because of the argument `SelectRules = powerRules`, only the given rules are used by `Simplify`:

```
Simplify(T^(1/2)*(R*T)^(-1/2), SelectRules = powerRules)
```



$$\frac{1}{\sqrt{R}}$$

Other expressions cannot be simplified with the same rule base:

```
Simplify(sin(x)^2 + cos(x)^2, SelectRules = powerRules)
```

$$\cos(x)^2 + \sin(x)^2$$

```
delete r, x, powerRules, PowerRules:
```

## Parameters

### pattern

A MuPAD expression; all identifiers are used as pattern variables for the pattern matcher on page 1-1312

### replacement

A MuPAD expression with the same identifiers, as `pattern`; the replacement expression should be protected from evaluation with the function `hold`

### conditions

A set (of type `DOM_SET`) of procedures and expressions in the pattern variables, or the empty set (see `match` and option `Cond`)

### procedure

A MuPAD procedure that is called with an expression and must return an equivalent expression or `FAIL`

### condProc

A procedure that is called with an expression before `procedure`, and must return `TRUE`, when `procedure` should be called with the expression, otherwise `FAIL` is returned immediately

## See Also

### **MuPAD Functions**

Simplify | match

## save\_save

Save the state of an identifier

### Syntax

```
save x1, x2, ...  
_save(x1, x2, ...)
```

### Description

In a procedure, the statement “`save x;`” saves the state of the global identifier `x`.

The `save` statement saves the states of identifiers—i.e., their values and properties (Symbolic Math Toolbox) — during the execution of procedures on page 1-2014 (Symbolic Math Toolbox). The original state of the identifiers is restored when procedure execution is finished. This holds even when an error occurs.

The `save` statement is to be used only inside the body of a procedure. It cannot be called on the interactive level.

The arguments of the `save` statement are evaluated as usual. In the statement ‘`save x;`’, the symbol `x` must evaluate to an identifier `y`, say. It is the state of the identifier `y` that is saved.

The `save` statement is very similar to the `save` declaration for procedures on page 1-2014 (Symbolic Math Toolbox). The main difference to the declaration is that, in order to make the declaration, one has to know the names of the identifiers to be saved in advance. The `save` statement allows to save identifiers which are known only at runtime.

The `save` statement is usually used in order to temporarily change the properties of an identifier, for example by calling the function `assume`. Eventually, the original properties of the identifiers are restored even if an error occurs.

The statement ‘`save x1, x2, ...;`’ is equivalent to the function call `_save(x1, x2, ...)`.

## Examples

### Example 1

First, we define a property for the identifier `y`:

```
assume(y < 0)
```

The properties of the identifier stored in `x` are changed temporarily during the execution of the following procedure `p`:

```
p := proc(x : DOM_IDENT)
begin
  save x;
  assume(x > 0);
  is(x > 0)
end_proc:
```

From the procedure's result, we see that the properties of `y` were changed during the execution of `p`:

```
p(y)
```

```
TRUE
```

However, the original properties were restored after exiting `p`. The identifier `y` has its original properties:

```
is(y > 0), is(y < 0)
```

```
FALSE, TRUE
```

The restoration of the original properties is guaranteed even if some error occurs inside the procedure. The following procedure `q` raises an error after changing the identifier given by `x`:

```
q := proc(x : DOM_IDENT)
begin
  save x;
  assume(x > 0);
```

```
    error("some error")
end_proc:
q(y)
```

Error: some error [q]

Nevertheless, the original assumptions about y are restored:

```
is(y > 0), is(y < 0)
```

FALSE, TRUE

```
unassume(y): delete p, q:
```

## Parameters

$x_1, x_2, \dots$

Symbols evaluating to identifiers on page 7-29

## Return Values

Void object of type DOM\_NULL.

## See Also

### MuPAD Functions

proc

## select

Select operands

### Syntax

```
select(object, f, <p1, p2, ...>)
```

### Description

`select(object, f)` returns a copy of the object with all operands removed that do not satisfy a criterion defined by the procedure `f`.

`select` is a fast and handy function for picking out elements of lists, sets, tables etc. that satisfy a criterion set by the procedure `f`.

The function `f` must return a value that can be evaluated to one of the Boolean values `TRUE`, `FALSE`, or `UNKNOWN`. It may either return one of these values directly, or it may return an equation or an inequality that can be simplified to one of these values by the function `bool`.

Internally, the function `f` is applied to all operands on page 1-1493 `x` of the input object via the call `f(x, p1, p2, ...)`. If the result is not `TRUE`, this operand is removed. The original object is not modified in this process.

The output object is of the same type as the input object, i.e., a list yields a list, a set yields a set etc.

An input object that is an expression sequence on page 1-88 is not flattened (Symbolic Math Toolbox). Cf. "Example 2" on page 1-1830 (Symbolic Math Toolbox).

Also "atomic" objects such as numbers or identifiers can be passed to `select` as first argument. Such objects are handled like sequences with a single operand.

## Examples

### Example 1

select handles lists and sets. In the first example, we select all true statements from a list of logical statements. The result is again a list:

```
select([1 = 1, 1 = 2, 2 = 1, 2 = 2], bool)
```

```
[1 = 1, 2 = 2]
```

In the following example, we extract the subset of all elements that are recognized as zero by iszero:

```
select({0, 1, x, 0.0, 4*x}, iszero)
```

```
{0.0, 0}
```

select also works on tables:

```
T:= table(1 = "y", 2 = "n", 3 = "n", 4 = "y", 5 = "y");
select(T, has, "y")
```

```
1 | "y"
4 | "y"
5 | "y"
```

The following expression is a sum, i.e., an expression of type "`_plus`". We extract the sum of all terms that do not contain `x`:

```
select(x^5 + 2*x + y - 4, _not@has, x)
```

```
y - 4
```

We extract all factors containing `x` from the following product. The result is a product with exactly one factor, and therefore, is not of the syntactical type "`_mult`":

```
select(11*x^2*y*(1 - y), has, x)
```

$x^2$ 

delete T:

## Example 2

select works for expression sequences on page 1-88:

```
select((1, -4, 3, 0, -5, -2), testtype, Type::Negative)
```

 $-4, -5, -2$ 

The \$ on page 1-80 command generates such expression sequences on page 1-88:

```
select(i $ i = 1..20, isprime)
```

 $2, 3, 5, 7, 11, 13, 17, 19$ 

Atomic objects are treated as expression sequences of length one:

```
select(5, isprime)
```

 $5$ 

The following result is the void object null() of type DOM\_NULL:

```
domtype(select(6, isprime))
```

 $DOM\_NULL$ 

## Example 3

It is possible to pass an “anonymous procedure” to select. This allows to perform more complex actions with one call. In the following example, the command anames(All) returns a set of all identifiers that have a value in the current MuPAD session. The select statement extracts all identifiers beginning with the letter “h”:



```
select(anames(All), x -> expr2text(x)[1] = "h")
```

{has, harmonic, hastype, heaviside, help, hessian, h<sub>1</sub>farray, history, hold, htranspose, hull, hypergeom}

## Parameters

### object

A list on page 7-41, a set on page 7-50, a table on page 1-2103, an expression sequence on page 1-88, or an expression of type DOM\_EXPR

### f

A procedure returning a Boolean value on page 1-2180

### p1, p2, ...

Any MuPAD objects accepted by f as additional parameters

## Return Values

Object of the same type as the input object.

## Overloaded By

object

## See Also

### MuPAD Functions

map | op | split | zip

## series

Compute a generalized series expansion

### Syntax

```
series(f, x, <order>, <Left | Right | Real | Undirected>, <NoWarning>, <UseGseries>)
```

```
series(f, x = x0, <order>, <Left | Right | Real | Undirected>, <options>)
```

### Description

`series(f, x = x0)` computes the first terms of a series expansion of `f` with respect to the variable `x` around the point `x0`.

`series` tries to compute either the Taylor series, the Laurent series, the Puiseux series, or a generalized series expansion of `f` around `x = x0`. See `Series::gseries` for details on generalized series expansions.

The mathematical type of the series returned by `series` can be queried using the type expression `Type::Series`.

If `series` cannot compute a series expansion of `f`, a symbolic function call is returned. This is an expression of type "series". Cf. "Example 11" on page 1-1844 (Symbolic Math Toolbox).

Mathematically, the expansion computed by `series` is valid in some neighborhood of the expansion point in the complex plane. Usually, this is an open disc centered at `x0`. However, if the expansion point is a branch point, then the returned expansion may not approximate the function `f` for values of `x` close to the branch cut. Cf. "Example 12" on page 1-1844 (Symbolic Math Toolbox).

Using the options `Left` or `Right`, one can compute directed expansions that are valid along the real axis. With the option `Real`, a two-sided expansion along the real axis is computed. See "Example 5" on page 1-1837 (Symbolic Math Toolbox) and "Example 6" on page 1-1838 (Symbolic Math Toolbox).

If  $x_0$  is `infinity` or `-infinity`, then a directed series expansion along the real axis from the left to the positive real infinity or from the right to the negative real infinity, respectively, is computed. If  $x_0$  is `complexInfinity` and `dir` is not specified or `Undirected`, then an undirected series expansion around the complex infinity, i.e., the north pole of the Riemann sphere, is computed. Specifying  $x_0 = \text{infinity}$  is equivalent to  $x_0 = \text{complexInfinity}$  and `dir = Left`. Similarly,  $x_0 = -\text{infinity}$  is equivalent to  $x_0 = \text{complexInfinity}$  and `dir = Right`. Cf. “Example 7” on page 1-1838 (Symbolic Math Toolbox).

Such a series expansion is computed as follows: The series variable  $x$  in  $f$  is replaced by  $x = \frac{1}{u}$  (or  $x = -\frac{1}{u}$  for  $x_0 = -\text{infinity}$ ). Then, a series expansion of  $f$  around  $u = 0$  is computed. Finally,  $u = \frac{1}{x}$  (or  $u = -\frac{1}{x}$ , respectively) is substituted in the result.

Mathematically, the result of such a series expansion is a series in  $\frac{1}{x}$ . However, it may happen that the coefficients of the returned series depend on the series variable. See the corresponding paragraph below.

The number of requested terms for the expansion is the argument `order` if specified. Otherwise, the value of the environment variable `ORDER` is used. One can change the default value 6 by assigning a new value to `ORDER`.

The number of terms is counted from the lowest degree term on for finite expansion points, and from the highest degree term on for expansions around infinity, i.e., “order” has to be regarded as a “relative truncation order”.

`series` implements a limited amount of precision management to circumvent cancellation. If the number of terms of the computed expansion is less than `order`, a second series computation with a higher value of `order` is tried automatically, and the result of the latter is returned.

---

**Note** Nevertheless, the actual number of terms in the resulting series expansion may differ from the requested number of terms. See “Example 13” on page 1-1846 (Symbolic Math Toolbox) and “Example 15” on page 1-1847 (Symbolic Math Toolbox).

---

Taylor/Laurent/Puiseux expansions (all of domain type `Series::Puiseux`) can be restricted easily to an absolute order term by adding an appropriate 0 term. Cf. “Example 14” on page 1-1847 (Symbolic Math Toolbox).

Expansions of symbolic integrals can be computed. Cf. “Example 16” on page 1-1848 (Symbolic Math Toolbox).

If  $f$  is an expression of type `RootOf`, then `series` returns the set of all non-zero series solutions of the corresponding algebraic equation. Cf. “Example 9” on page 1-1840 (Symbolic Math Toolbox).

If `order` has the value `infinity`, then the system tries to convert the first argument into a formal infinite series, i.e., it computes a general formula for the  $n$ -th coefficient in the Taylor expansion of  $f$ . The result is an inactive on page 1-823 symbolic sum on page 1-1812 (Symbolic Math Toolbox) or a polynomial expression (Symbolic Math Toolbox). Cf. “Example 10” on page 1-1843 (Symbolic Math Toolbox).

If `series` returns a series expansion of domain type `Series::Puiseux`, it may happen that the “coefficients” of the returned series depend on the series variable. In this case, the expansion is not a proper Puiseux series in the mathematical sense. See “Example 7” on page 1-1838 (Symbolic Math Toolbox) and “Example 8” on page 1-1840 (Symbolic Math Toolbox). However, if the series variable is  $x$  and the expansion point is  $x_0$ , then the following is valid for each coefficient function  $c(x)$  and every positive  $\varepsilon$ :  $c(x)(x - x_0)^\varepsilon$

converges to zero and  $\frac{c(x)}{(x-x_0)^\varepsilon}$  is unbounded when  $x$  approaches  $x_0$ . Similarly, if the expansion point is *infinity*, then, for every positive  $\varepsilon$ ,  $\frac{c(x)}{x^\varepsilon}$  converges to zero and  $c(x)x^\varepsilon$  is unbounded when  $x$  approaches *infinity*.

The function returns a domain object that can be manipulated by the standard arithmetical operations. Moreover, the following methods are available: `ldegree` returns the exponent of the leading term; `Series::Puiseux::order` returns the exponent of the error term; `expr` converts to an arithmetical expression, removing the error term; `coeff(s, n)` returns the coefficient of the term of  $s$  with exponent  $n$ ; `lcoeff` returns the leading coefficient; `revert` computes the inverse with respect to composition; `diff` and `int` differentiate and integrate a series expansion, respectively; `map` applies a function to all coefficients. See the help pages for `Series::Puiseux` and `Series::gseries` for further details.

---

**Note** `series` works on a symbolic level and should not be called with arguments containing floating point arguments on page 7-23.

---

## Environment Interactions

The function is sensitive to the environment variable `ORDER`, which determines the default number of terms in series computations.

## Examples

### Example 1

We compute a series expansion of  $\sin(x)$  around  $x = 0$ . The result is a Taylor series:

```
s := series(sin(x), x)
```

$$x - \frac{x^3}{6} + \frac{x^5}{120} + O(x^7)$$

Syntactically, the result is an object of domain type `Series::Puisseux`:

```
domtype(s)
```

```
Series::Puisseux
```

The mathematical type of the series expansion can be queried using the type expression `Type::Series`:

```
testtype(s, Type::Series(Taylor))
```

```
TRUE
```

Various system functions are overloaded (Symbolic Math Toolbox) to operate on series objects. E.g., the function `coeff` can be used to extract the coefficients of a series expansion:

```
coeff(s, 5)
```

$$\frac{1}{120}$$

The standard arithmetical operators can be used to add or multiply series expansions:

```
s + 2*s, s*s
```

$$3x - \frac{x^3}{2} + \frac{x^5}{40} + O(x^7), x^2 - \frac{x^4}{3} + \frac{2x^6}{45} + O(x^8)$$

```
delete s:
```

## Example 2

This example computes the composition of `s` by itself, i.e. the series expansion of  $\sin(\sin(x))$ .

```
s := series(sin(x), x): s @ s = series(sin(sin(x)), x)
```

$$x - \frac{x^3}{3} + \frac{x^5}{10} + O(x^7) = x - \frac{x^3}{3} + \frac{x^5}{10} + O(x^7)$$

```
delete s:
```

## Example 3

We compute the series expansion of the tangent function around the origin in two ways:

```
series(sin(x), x) / series(cos(x), x) = series(tan(x), x)
```

$$x + \frac{x^3}{3} + \frac{2x^5}{15} + O(x^7) = x + \frac{x^3}{3} + \frac{2x^5}{15} + O(x^7)$$

```
bool(%)
```

```
TRUE
```

## Example 4

We compute a Laurent expansion around the point 1:

```
s := series(1/(x^2 - 1), x = 1)
```

$$\frac{1}{2(x-1)} - \frac{1}{4} + \frac{x-1}{8} - \frac{(x-1)^2}{16} + \frac{(x-1)^3}{32} - \frac{(x-1)^4}{64} + O((x-1)^5)$$

```
testtype(s, Type::Series(Taylor)),
testtype(s, Type::Series(Laurent))
```

FALSE, TRUE

## Example 5

Without an optional argument or with the option `Undirected`, the `sign` function is not expanded:

```
series(x*sign(x^2 + x), x) =
series(x*sign(x^2 + x), x, Undirected)
```

$$x \operatorname{sign}(x^2 + x) + O(x^7) = x \operatorname{sign}(x^2 + x) + O(x^7)$$

Some simplification occurs if one requests an expansion that is valid along the real axis only:

```
series(x*sign(x^2 + x), x, Real)
```

$$x \operatorname{sign}(x) + O(x^7)$$

The `sign` vanishes from the result if one requests a one-sided expansion along the real axis:

```
series(x*sign(x^2 + x), x, Right),
series(x*sign(x^2 + x), x, Left)
```

$$x + O(x^7), -x + O(x^7)$$

## Example 6

In MuPAD, the `heaviside` function is defined only on the real axis. Thus an undirected expansion in the complex plane does not make sense:

```
series(x*heaviside(x + 1), x)
```

Warning: Unable to find an undirected series expansion. Try the 'Left', 'Right', or 'Real' options.

```
series(x heaviside(x + 1), x)
```

After specifying corresponding options, the system computes an expansion along the real axis:

```
series(x*heaviside(x + 1), x, Real),  
series(x*heaviside(x + 1), x, Right)
```

```
 $x + O(x^7), x + O(x^7)$ 
```

At the point `I` in the complex plane, the function `heaviside` is not defined, and neither is a series expansion:

```
series(heaviside(x), x = I, Real)
```

```
series(heaviside(x), x = i, Real)
```

## Example 7

We compute series expansions around infinity:

```
s1 := series((x + 1)/(x - 1), x = complexInfinity)
```

```
 $1 + \frac{2}{x} + \frac{2}{x^2} + \frac{2}{x^3} + \frac{2}{x^4} + \frac{2}{x^5} + O\left(\frac{1}{x^6}\right)$ 
```

```
s2 := series(psi(x), x = infinity)
```



$$\ln(x) - \frac{1}{2x} - \frac{1}{12x^2} + \frac{1}{120x^4} + O\left(\frac{1}{x^6}\right)$$

```
domtype(s1), domtype(s2)
```

```
Series::Puisseux, Series::Puisseux
```

Although both expansions are of domain type `Series::Puisseux`, `s2` is not a Puiseux series in the mathematical sense, since the first term contains a logarithm, which has an essential singularity at infinity:

```
testtype(s1, Type::Series(Puisseux)),
testtype(s2, Type::Series(Puisseux))
```

```
TRUE, FALSE
```

```
coeff(s2)
```

$$\ln(x), -\frac{1}{2}, -\frac{1}{12}, 0, \frac{1}{120}$$

The following expansion is of domain type `Series::gseries`:

```
s3 := series(exp(x)/(1 - x), x = infinity, 4)
```

$$-\frac{e^x}{x} - \frac{e^x}{x^2} - \frac{e^x}{x^3} - \frac{e^x}{x^4} + O\left(\frac{e^x}{x^5}\right)$$

```
domtype(s3)
```

```
Series::gseries
```

```
delete s1, s2, s3:
```

## Example 8

Oscillating but bounded functions may appear in the “coefficients” of a series expansion as well:

```
s := series(sin(x + 1/x), x = infinity)
```

$$\sin(x) + \frac{\cos(x)}{x} - \frac{\sin(x)}{2x^2} - \frac{\cos(x)}{6x^3} + \frac{\sin(x)}{24x^4} + \frac{\cos(x)}{120x^5} + O\left(\frac{1}{x^6}\right)$$

```
domtype(s), testtype(s, Type::Series(Puiseux))
```

```
Series::Puiseux, FALSE
```

```
coeff(s, -1)
```

```
cos(x)
```

## Example 9

The algebraic equation  $y^5 - y - x = 0$  cannot be resolved in terms of radicals:

```
solve(y^5 - y - x, y)
```

```
RootOf(z5 - z - x, z)
```

However, `series` can compute all series solutions of this equation around  $x = 0$ :

```
series(%, x = 0)
```

$$\left\{ -x - x^5 + O(x^7), -1 + \frac{x}{4} + \sigma_5 + \sigma_1 + \sigma_4 + \frac{x^5}{4} + O(x^6), 1 + \frac{x}{4} - \sigma_5 + \sigma_1 - \sigma_4 + \frac{x^5}{4} + O(x^6), \right. \\ \left. -i + \frac{x}{4} - \sigma_3 - \sigma_1 + \sigma_2 + \frac{x^5}{4} + O(x^6), i + \frac{x}{4} + \sigma_3 - \sigma_1 - \sigma_2 + \frac{x^5}{4} + O(x^6) \right\}$$

where

$$\sigma_1 = \frac{5x^3}{32}$$

$$\sigma_2 = \frac{385x^4i}{2048}$$

$$\sigma_3 = \frac{5x^2i}{32}$$

$$\sigma_4 = \frac{385x^4}{2048}$$

$$\sigma_5 = \frac{5x^2}{32}$$

It may happen that the series solutions themselves are expressed in terms of RootOfs:

```
series(RootOf(y^5 -(x + 2*x^2)*y^3 - x^3*y^2
+ (x^3 + x^4)*y + x^4 + x^5, y), x)
```

$$\{-\sqrt{x} - \sigma_6 + \sigma_5 - \sigma_4 + \sigma_2 - \sigma_1 + \sigma_3, \sqrt{x} + \sigma_6 - \sigma_5 + \sigma_4 - \sigma_2 + \sigma_1 + \sigma_3\} \\ \cup \{x z + O(x^7) \mid z \in \text{RootOf}(z^3 - z^2 - 1, z^2)\}$$

where

$$\sigma_1 = \frac{7 x^{11/2}}{256}$$

$$\sigma_2 = \frac{5 x^{9/2}}{128}$$

$$\sigma_3 = O(x^{13/2})$$

$$\sigma_4 = \frac{x^{7/2}}{16}$$

$$\sigma_5 = \frac{x^{5/2}}{8}$$

$$\sigma_6 = \frac{x^{3/2}}{2}$$

The coefficients of the algebraic equation are allowed to be transcendental. They are internally converted into Puiseux series by `series`:

```
series(RootOf(y^3 - y - exp(x - 1) + 1, y), x = 1, 4)
```

$$\left\{ - (x-1) - \frac{(x-1)^2}{2} - \frac{7(x-1)^3}{6} + \sigma_1, 1 + \frac{x-1}{2} - \frac{(x-1)^2}{8} + \frac{5(x-1)^3}{24} + \sigma_1, \right. \\ \left. - 1 + \frac{x-1}{2} + \frac{5(x-1)^2}{8} + \frac{23(x-1)^3}{24} + \sigma_1 \right\}$$

where

$$\sigma_1 = O((x-1)^4)$$

An error occurs if some coefficient cannot be expanded into a Puiseux series:

```
series(RootOf(y^3 - y - exp(x), y), x = infinity)
```

Error: Unable to expand coefficients of 'RootOf(y^3 - y - exp(1/x), y)' into a series.

## Example 10

In this example, we compute a formula for the  $n$ -th coefficient  $a_n$  in the Taylor expansion

of the function  $e^{-x} = \sum_{n \geq 0} a_n x^n$  around zero, by specifying `infinity` as order. The result is a symbolic sum:

```
series(exp(-x), x, infinity)
```

$$\left( \sum_{k=1}^{\infty} \frac{(-1)^k x^k}{k \Gamma(k)} \right) + 1$$

If the input is a polynomial expression, then so is the output:

```
series(x^5 - 1, x = 1, infinity)
```

$$5(x-1) + 10(x-1)^2 + 10(x-1)^3 + 5(x-1)^4 + (x-1)^5$$

## Example 11

No asymptotic expansion exists for the Bessel J on page 1-319 function of unspecified index, and `series` returns a symbolic function call:

```
series(besselJ(k, x), x=infinity)
```

```
series( $J_k(x)$ ,  $x = \infty$ )
```

```
domtype(%), type(%)
```

```
DOM_EXPR, "series"
```

## Example 12

The branch cut of the logarithm on page 1-429 (Symbolic Math Toolbox) and the square root on page 1-2021 is the negative real axis. For a series expansion on the branch cut, `series` uses the function `signIm` to return an expansion that is valid in an open disc around the expansion point:

```
series(ln(x), x = -1, 3)
```

$$\pi \operatorname{signIm}(x) i - (x+1) - \frac{(x+1)^2}{2} - \frac{(x+1)^3}{3} + O((x+1)^4)$$

```
series(sqrt(x), x = -1, 3)
```

$$(-1)^{\frac{\operatorname{signIm}(x)}{2}} - \frac{(-1)^{\frac{\operatorname{signIm}(x)}{2}}}{2} (x+1) - \frac{(-1)^{\frac{\operatorname{signIm}(x)}{2}}}{8} (x+1)^2 + O((x+1)^3)$$

The situation is more intricate when the expansion point is a branch point. The following expansion of the function  $\arcsin(x + 1)$  is valid in an open disc around the branch point 0:

```
series(arcsin(x + 1), x, 4)
```

$$\frac{\pi}{2} - \sqrt{2} \sqrt{-x} - \frac{\sqrt{2} (-x)^{3/2}}{12} - \frac{3 \sqrt{2} (-x)^{5/2}}{160} - \frac{5 \sqrt{2} (-x)^{7/2}}{896} + O(x^{9/2})$$

However, the expansion of  $f = \ln(x + I*x^3)$  around the branch point 0 that is returned by `series` does not approximate  $f$  for values of  $x$  that are close to the negative real axis:

```
f := ln(x + I*x^3);
g := series(f, x, 4);
```

$$\ln(x^3 i + x)$$

$$\ln(x) + x^2 i + O(x^4)$$

```
DIGITS := 20;
float(subs([f, expr(g)], x = -0.01 + 0.0000001*I));
delete DIGITS;
```

$$[-4.605170178938091416 - 3.1415026535903362385 i, -4.605170183938091368 + 3.1416826535897835718 i]$$

The situation is similar for algebraic branch points:

```
f := sqrt(x + I*x^3);
g := series(f, x, 4);
```

$$\sqrt{x^3 i + x}$$

$$\sqrt{x} + \frac{x^{5/2} i}{2} + O(x^{9/2})$$

```
DIGITS := 20;
float(subs([f, expr(g)], x = -0.01 + 0.0000001*I));
delete DIGITS;
```

```
[0.0000044999999871937500725 - 0.1000000002512499991 i,  
 - 0.0000044999999906875 + 0.10000000012625 i]
```

```
delete f, g;
```

### Example 13

The first six terms, including zeroes, of the following two series expansions agree:

```
series(sin(tan(x)), x, 12);  
series(tan(sin(x)), x, 12);
```

$$x + \frac{x^3}{6} - \frac{x^5}{40} - \frac{55 x^7}{1008} - \frac{143 x^9}{3456} - \frac{968167 x^{11}}{39916800} + O(x^{13})$$

$$x + \frac{x^3}{6} - \frac{x^5}{40} - \frac{107 x^7}{5040} - \frac{73 x^9}{24192} + \frac{41897 x^{11}}{39916800} + O(x^{13})$$

If we want to compute the series expansion of the difference  $\sin(\tan(x)) - \tan(\sin(x))$ , cancellation happens and produces too few terms in the result. `series` detects this automatically and performs a second series computation with increased precision:

```
series(sin(tan(x)) - tan(sin(x)), x, 6)
```

$$-\frac{x^7}{30} - \frac{29 x^9}{756} - \frac{1913 x^{11}}{75600} + O(x^{13})$$

It may nevertheless happen that the result has too few terms; cf. “Example 15” on page 1-1847 (Symbolic Math Toolbox).

If rational exponents occur in the series expansion, then it may even happen that the result has more than the number of terms requested by the third argument:

```
series(x^2*exp(x) + x*sqrt(sin(x)), x, 3)
```

$$x^{3/2} + x^2 + x^3 - \frac{x^{7/2}}{12} + \frac{x^4}{2} + O(x^5)$$



## Example 14

series's control of the order term is based on the concept of 'relative order', counting the number of terms beginning with the lowest order that is present in the expansion. An 'absolute order' control can be achieved by simply adding an appropriate order term on page 1-1480 to restrict a result returned by series:

```
series(exp(x) + x*sqrt(sin(x)), x, 7)
```

$$1 + x + x^{3/2} + \frac{x^2}{2} + \frac{x^3}{6} - \frac{x^{7/2}}{12} + \frac{x^4}{24} + \frac{x^5}{120} + \frac{x^{11/2}}{1440} + \frac{x^6}{720} + O(x^7)$$

```
series(exp(x) + x*sqrt(sin(x)), x, 7) + O(x^4)
```

$$1 + x + x^{3/2} + \frac{x^2}{2} + \frac{x^3}{6} - \frac{x^{7/2}}{12} + O(x^4)$$

Note, however, that the series must have enough terms for the added order term to have any effect:

```
series(exp(x^2), x, 4)
```

$$1 + x^2 + \frac{x^4}{2} + O(x^6)$$

```
series(exp(x^2), x, 4) + O(x^8)
```

$$1 + x^2 + \frac{x^4}{2} + O(x^6)$$

## Example 15

If the specified order for the expansion is too small to compute the reciprocal (due to cancellation), series returns a symbolic call:

```
series(exp(x), x, 4)
```

$$1 + x + \frac{x^2}{2} + \frac{x^3}{6} + O(x^4)$$

```
series(1/(exp(x) - 1 - x - x^2/2 - x^3/6), x, 2)
```

$$\text{series}\left(-\frac{1}{x - e^x + \frac{x^2}{2} + \frac{x^3}{6} + 1}, x, 2\right)$$

After increasing the order, an expansion is computed, but possibly with fewer terms:

```
series(1/(exp(x) - 1 - x - x^2/2 - x^3/6), x, 3);  
series(1/(exp(x) - 1 - x - x^2/2 - x^3/6), x, 4)
```

$$\frac{24}{x^4} - \frac{24}{5x^3} + O\left(\frac{1}{x^2}\right)$$

$$\frac{24}{x^4} - \frac{24}{5x^3} + \frac{4}{25x^2} + \frac{12}{875x} + O(1)$$

## Example 16

`series` and `int` support each other. On the one hand, series expansions can be integrated:

```
int(series(1/(2 - x), x), x = 0..1)
```

$$\int_0^1 O(x^6) dx + \frac{1327}{1920}$$

On the other hand, `series` knows how to handle symbolic integrals:

```
int(x^x, x)
```

$$\int x^x dx$$

```
series(%, x = 0, 3)
```

$$x + x^2 \left( \frac{\ln(x)}{2} - \frac{1}{4} \right) + x^3 \left( \frac{\ln(x)^2}{6} - \frac{\ln(x)}{9} + \frac{1}{27} \right) + O(x^4)$$

```
int(exp(-x*sin(t)), t = 0.. x)
```

$$\int_0^x e^{-x \sin(t)} dt$$

```
series(%, x = 0)
```

$$x - \frac{x^3}{2} + \frac{5x^5}{24} + O(x^7)$$

```
int(cos((x*t^2 + x^2*t))^(1/3), t = 0..2)
```

$$\int_0^2 \cos(t^2 x + t x^2)^{1/3} dt$$

```
series(%, x)
```

$$2 - \frac{16x^2}{15} - \frac{4x^3}{3} - \frac{100x^4}{81} - \frac{16x^5}{9} + O(x^6)$$

## Example 17

Users can extend the power of `series` by implementing `series` attributes (slots on page 1-1980) for their own special mathematical functions.

We illustrate how to write such a series attribute, using the case of the exponential function. (Of course, this function already has a `series` attribute in MuPAD, which you can inspect via `expose(exp::series)`.) In order not to overwrite the already existing attribute, we work on a copy of the exponential function called `Exp`.

The `series` attribute must be a procedure with four arguments. This procedure is called whenever a series expansion of `Exp` with an arbitrary argument is to be computed. The first argument is the argument of `Exp` in the `series` call. The second argument is the series variable; the expansion point is always the origin 0; other expansion points are internally moved to the origin by a change of variables. The third and the fourth argument are identical with the `order` and the `dir` argument of `series`, respectively.

For example, the command `series(Exp(x^2 + 2), x, 5)` is internally converted into the call `Exp::series(x^2 + x, x, 5, Undirected)`. Here is an example of a `series` attribute for `Exp`.

```
// The series attribute for Exp. It handles the call
// series(Exp(f), x = 0, order, dir)
ExpSeries := proc(f, x, order, dir)
  local t, x0, s, r, i;
begin
  // Expand the argument into a series.
  t := series(f, x, order, dir);

  // Determine the order k of the lowest term in t, so that
  // t = c*x^k + higher order terms, for some non-zero c.
  k := ldegree(t);

  if k = FAIL then
    // t consists only of an error term 0(..)
    return(FAIL);

  elif k < 0 then
    // This corresponds to an expansion of exp around infinity,
    // which does not exist for the exponential
    // function, since it has an essential singularity. Thus we
    // return FAIL, which makes series return unevaluatedly. For
    // other special functions, you may add an asymptotic
    // expansion here.
    return(FAIL);

  else // k >= 0
    // This corresponds to an expansion of exp around a
    // finite point x0. We write t = x0 + y, where all
    // terms in y have positive order, use the
    // formula exp(x0 + y) = exp(x0)*exp(y) and compute
    // the series expansion of exp(y) as the functional
    // composition of the Taylor series of exp(x) around
    // x = 0 with t - x0. If your special function has
```

```

// any finite singularities, then they should be
// treated here.
x0 := coeff(t, x, 0);
s := Series::Puisseux::create(1, 0, order,
    [1/i! $ i = 0..(order - 1)], x, 0, dir);
return(Series::Puisseux::scalmult(s @ (t - x0), Exp(x0), 0))
end_if
end_proc:

```

This special function must be embedded in a function environment on page 7-25. The following command defines `Exp` as a function environment and lets the system function `exp` do the evaluation. The `subs` command applied on the result achieves that `Exp` with symbolic arguments is returned as `Exp` and not as `exp`.

```

Exp := funcenv(x -> subs(exp(x), hold(exp)=hold(Exp))):
Exp(1), Exp(-1.0), Exp(x^2 + x)

```

`Exp(1), 0.3678794412, Exp(x2 + x)`

`series` can already handle this “new” function, but it can only compute a Taylor expansion with symbolic derivatives:

```
ORDER := 3: series(Exp(x), x = 0)
```

$$1 + x \text{Exp}'(0) + \frac{x^2 \text{Exp}''(0)}{2} + O(x^3)$$

One can define the `series` attribute of `Exp` by assigning the procedure above to its `series` slot:

```
Exp::series := ExpSeries:
```

Now we can test the new attribute:

```
series(Exp(x^2 + x), x = 0) = series(exp(x^2 + x), x = 0)
```

$$1 + x + \frac{3x^2}{2} + O(x^3) = 1 + x + \frac{3x^2}{2} + O(x^3)$$

```
series(Exp(x^2 + x), x = 2) = series(exp(x^2 + x), x = 2)
```

$$\text{Exp}(6) + 5 \text{Exp}(6) (x - 2) + \frac{27 \text{Exp}(6) (x - 2)^2}{2} + O((x - 2)^3) =$$

$$e^6 + 5 e^6 (x - 2) + \frac{27 e^6 (x - 2)^2}{2} + O((x - 2)^3)$$

```
series(Exp(x^2 + x), x = 0, 1)
```

```
1 + O(x)
```

```
series(Exp(x^2 + x), x = infinity)
```

```
series(Exp(x^2 + x), x = ∞)
```

Another possibility to obtain series expansions of user-defined functions is to define the `diff` attribute of the corresponding function environment. This is used by `series` to compute a Taylor expansion when no `series` attribute exists. However, this only works when a Taylor expansion exists, whilst a `series` attribute can handle more general types of series expansions as well.

```
delete ExpSeries, Exp:
```

## Parameters

**f**

An arithmetical expression (Symbolic Math Toolbox) representing a function in  $x$

**x**

An identifier

**$x_0$**

The expansion point: an arithmetical expression (Symbolic Math Toolbox). If not specified, the default expansion point 0 is used.

**order**

The number of terms to be computed: a nonnegative integer or `infinity`. The default order is given by the environment variable `ORDER` (default value 6).

## Options

**Left, Real, Right, Undirected**

If no expansion exists that is valid in the complex plane, this argument can be used to request expansions that only need to be valid along the real line. The default is `Undirected`.

**NoWarning**

Suppresses warning messages printed during the series computation. This can be useful if `series` is called within user-defined procedures.

**UseGseries**

Option, specified as `UseGseries = b`

Use `Series::gseries` to compute the series. `b` must be `TRUE` or `FALSE`. Default is `TRUE`. Even if this option is set to `TRUE`, computing a `Puiseux` expansion will be attempted first.

## Return Values

If `order` is a nonnegative integer, then `series` returns either an object of the domain type `Series::Puiseux` or `Series::gseries`, an expression of type `"series"`, or, if `f` is a `RootOf` expression, a set of type `Type::Set`. If `order = infinity`, then `series` returns an arithmetical expression (Symbolic Math Toolbox).

## Overloaded By

`f`

## See Also

### MuPAD Functions

`0` | `ORDER` | `RootOf` | `Series::Puisseux` | `Series::gseries` | `Type::Series` | `asympt`  
| `limit` | `mtaylor` | `solve` | `taylor`

### Topics

“Compute Generalized Series” (Symbolic Math Toolbox)



# Si

Sine integral function

## Syntax

Si(x)

## Description

Si(x) represents the sine integral  $\int_0^x \frac{\sin(t)}{t} dt$ .

If x is a floating-point number, then Si(x) returns floating-point results. The special values Si(0) = 0, Si(∞) = π/2, and Si(-∞) = -π/2 are implemented. For all other arguments, Si returns symbolic function calls.

If x is a negative integer or a negative rational number, then Si(x) = -Si(-x). The Si function also uses this reflection rule when the argument is a symbolic product involving such a factor. See “Example 2” on page 1-1856 (Symbolic Math Toolbox).

The float attribute of Si is a kernel function, thus, floating-point evaluation is fast.

## Environment Interactions

When called with a floating-point argument, the functions are sensitive to the environment variable DIGITS which determines the numerical working precision.

## Examples

### Example 1

Most calls with exact arguments return themselves unevaluated:

`Si(0), Si(1), Si(sqrt(2)), Si(x + 1), Si(infinity)`

`0, Si(1), Si(sqrt(2)), Si(x + 1),  $\frac{\pi}{2}$`

To approximate exact results with floating-point numbers, use `float`:

`float(Si(1)), float(Si(sqrt(2)))`

`0.9460830704, 1.266192956`

Alternatively, use a floating-point value as an argument:

`Si(-5.0), Si(1.0), Si(2.0 + 10.0*I)`

`-1.549931245, 0.9460830704, 1187.409493 - 242.5252717 i`

## Example 2

For negative real numbers and products involving such numbers, `Si` applies the reflection rule  $\text{Si}(-x) = -\text{Si}(x)$ :

`Si(-3), Si(-3/7), Si(-sqrt(2)), Si(-x/7), Si(-0.3*x)`

`-Si(3), -Si( $\frac{3}{7}$ ), -Si(sqrt(2)), -Si( $\frac{x}{7}$ ), -Si(0.3 x)`

No such “normalization” occurs for complex numbers or arguments that are not products:

`Si(-3 - I), Si(3 + I), Si(x - 1), Si(1 - x)`

`Si(-3 - i), Si(3 + i), Si(x - 1), Si(1 - x)`

## Example 3

`diff`, `float`, `limit`, `series`, and other functions handle expressions involving `Si`:

`diff(Si(x), x, x, x), float(ln(3 + Si(sqrt(PI))))`

$$\frac{2 \sin(x)}{x^3} - \frac{\sin(x)}{x} - \frac{2 \cos(x)}{x^2}, 1.502020149$$

`limit(Si(2*x^2/(1+x)), x = infinity)`

$$\frac{\pi}{2}$$

`series(Si(x), x = 0)`

$$x - \frac{x^3}{18} + \frac{x^5}{600} + O(x^7)$$

`series(Si(x), x = infinity, 3)`

$$\frac{\pi}{2} - \frac{\cos(x)}{x} - \frac{\sin(x)}{x^2} + O\left(\frac{1}{x^3}\right)$$

## Parameters

**x**

An arithmetical expression (Symbolic Math Toolbox)

## Return Values

Arithmetical expression.

## Overloaded By

x

## Algorithms

$\text{Si}$ ,  $\text{Ssi}$ , and  $\text{Shi}$  are entire functions.

$\text{Ssi}(x) = \text{Si}(x) - \pi$  for all  $x$  in the complex plane.

$i \cdot \text{Si}(x) = \text{Shi}(i \cdot x)$  for all  $x$  in the complex plane.

Reference: M. Abramowitz and I. Stegun, "Handbook of Mathematical Functions", Dover Publications Inc., New York (1965).

## See Also

### MuPAD Functions

[Chi](#) | [Ci](#) | [Ei](#) | [Li](#) | [Shi](#) | [Ssi](#) | [int](#) | [sin](#)

# Ssi

Shifted sine integral function

## Syntax

`Ssi(x)`

## Description

`Ssi(x)` represents the shifted sine integral  $\text{Si}(x) - \frac{\pi}{2}$ .

The special values  $\text{Ssi}(0) = -\pi/2$ ,  $\text{Ssi}(\infty) = 0$ ,  $\text{Ssi}(-\infty) = -\pi$  are implemented.

If  $x$  is a negative integer or a negative rational number, then  $\text{Ssi}(x) = -\text{Ssi}(-x) - \pi$ . The `Ssi` function also uses this reflection rule when argument is a symbolic product involving such a factor. See “Example 2” on page 1-1860 (Symbolic Math Toolbox).

## Environment Interactions

When called with a floating-point argument, the functions are sensitive to the environment variable `DIGITS` which determines the numerical working precision.

## Examples

### Example 1

Most calls with exact arguments return themselves unevaluated:

`Ssi(0)`, `Ssi(1)`, `Ssi(sqrt(2))`, `Ssi(x + 1)`, `Ssi(infinity)`

$-\frac{\pi}{2}$ , `Ssi(1)`, `Ssi(sqrt(2))`, `Ssi(x + 1)`, `0`

To approximate exact results with floating-point numbers, use `float`:

```
float(Ssi(1)), float(Ssi(sqrt(2)))
-0.6247132564, -0.3046033712
```

Alternatively, use a floating-point value as an argument:

```
Ssi(-5.0), Ssi(1.0), Ssi(2.0 + 10.0*I)
-3.120727572, -0.6247132564, 1185.838696 - 242.5252717 i
```

## Example 2

For negative real numbers and products involving such numbers, `Ssi` applies the reflection rule  $Ssi(-x) = -Ssi(x) - \pi$ :

```
Ssi(-3), Ssi(-3/7), Ssi(-sqrt(2)), Ssi(-x/7), Ssi(-0.3*x)
-π - Ssi(3), -π - Ssi(3/7), -π - Ssi(√2), -π - Ssi(x/7), -Ssi(0.3 x) - 3.141592654
```

No such “normalization” occurs for complex numbers or arguments that are not products:

```
Ssi(- 3 - I), Ssi(3 + I), Ssi(x - 1), Ssi(1 - x)
Ssi(-3 - i), Ssi(3 + i), Ssi(x - 1), Ssi(1 - x)
```

## Example 3

`diff`, `float`, `limit`, `series`, and other functions handle expressions involving `Ssi`:

```
diff(Ssi(x), x, x, x), float(ln(3 + Ssi(sqrt(PI))))
2 sin(x) / x^3 - sin(x) / x - 2 cos(x) / x^2, 1.071568401
```

```
limit(Ssi(2*x^2/(1+x)), x = infinity)
```

0

```
series(Ssi(x), x = 0)
```

$$-\frac{\pi}{2} + x - \frac{x^3}{18} + \frac{x^5}{600} + O(x^6)$$

```
series(Ssi(x), x = infinity, 3)
```

$$-\frac{\cos(x)}{x} - \frac{\sin(x)}{x^2} + \frac{2 \cos(x)}{x^3} + O\left(\frac{1}{x^4}\right)$$

## Parameters

**x**

An arithmetical expression (Symbolic Math Toolbox)

## Return Values

Arithmetical expression.

## Overloaded By

x

## Algorithms

Si, Ssi, and Shi are entire functions.

$Ssi(x) = Si(x) - \pi$  for all  $x$  in the complex plane.

Reference: M. Abramowitz and I. Stegun, "Handbook of Mathematical Functions", Dover Publications Inc., New York (1965).

## **See Also**

### **MuPAD Functions**

Chi | Ci | Ei | Li | Shi | Si | int | sin



# Shi

Hyperbolic sine integral function

## Syntax

`Shi(x)`

## Description

`Shi(x)` represents the hyperbolic sine integral  $\int_0^x \frac{\sinh(t)}{t} dt$ .

If  $x$  is a floating-point number, then `Shi(x)` returns floating-point results. The special values `Shi(0) = 0`, `Shi(∞) = ∞`, `Shi(-∞) = -∞` are implemented. For all other arguments, `Shi` returns symbolic function calls.

If  $x$  is a negative integer or a negative rational number, then `Shi(x) = -Shi(-x)`. The `Shi` function also uses this reflection rule when the argument is a symbolic product involving such a factor. See “Example 2” on page 1-1864 (Symbolic Math Toolbox).

## Environment Interactions

When called with a floating-point argument, the functions are sensitive to the environment variable `DIGITS` which determines the numerical working precision.

## Examples

### Example 1

Most calls with exact arguments return themselves unevaluated:

`Shi(0)`, `Shi(1)`, `Shi(sqrt(2))`, `Shi(x + 1)`, `Shi(infinity)`

0, Shi(1), Shi( $\sqrt{2}$ ), Shi( $x + 1$ ),  $\infty$

To approximate exact results with floating-point numbers, use `float`:

```
float(Shi(1)), float(Shi(sqrt(2)))
```

1.057250875, 1.581104209

Alternatively, use a floating-point value as an argument:

```
Shi(-5.0), Shi(1.0), Shi(2.0 + 10.0*I)
```

-20.09321183, 1.057250875, -0.225644485 + 1.861300836 i

## Example 2

For negative real numbers and products involving such numbers, `Shi` applies the reflection rule  $\text{Shi}(-x) = -\text{Shi}(x)$ :

```
Shi(-3), Shi(-3/7), Shi(-sqrt(2)), Shi(-x/7), Shi(-0.3*x)
```

$-\text{Shi}(3)$ ,  $-\text{Shi}\left(\frac{3}{7}\right)$ ,  $-\text{Shi}(\sqrt{2})$ ,  $-\text{Shi}\left(\frac{x}{7}\right)$ ,  $-\text{Shi}(0.3 x)$

No such “normalization” occurs for complex numbers or arguments that are not products:

```
Shi(- 3 - I), Shi(3 + I), Shi(x - 1), Shi(1 - x)
```

$\text{Shi}(-3 - i)$ ,  $\text{Shi}(3 + i)$ ,  $\text{Shi}(x - 1)$ ,  $\text{Shi}(1 - x)$

## Example 3

`diff`, `float`, `limit`, `series`, and other functions handle expressions involving `Shi`:

```
diff(Shi(x), x, x, x), float(ln(3 + Shi(sqrt(PI))))
```

$$\frac{\sinh(x)}{x} - \frac{2 \cosh(x)}{x^2} + \frac{2 \sinh(x)}{x^3}, 1.631702794$$

`limit(Shi(2*I*x^2/(1+x)), x = infinity)`

$$\frac{\pi i}{2}$$

`series(Shi(x), x = 0)`

$$x + \frac{x^3}{18} + \frac{x^5}{600} + O(x^7)$$

`series(Shi(I*x), x = infinity, 3)`

$$\frac{\pi i}{2} - \frac{\cos(x) i}{x} - \frac{\sin(x) i}{x^2} + O\left(\frac{1}{x^3}\right)$$

## Parameters

**x**

An arithmetical expression (Symbolic Math Toolbox)

## Return Values

Arithmetical expression.

## Overloaded By

x

## Algorithms

$\text{Si}$ ,  $\text{Ssi}$ , and  $\text{Shi}$  are entire functions.

$i \cdot \text{Si}(x) = \text{Shi}(i \cdot x)$  for all  $x$  in the complex plane.

Reference: M. Abramowitz and I. Stegun, "Handbook of Mathematical Functions", Dover Publications Inc., New York (1965).

## See Also

### MuPAD Functions

$\text{Chi}$  |  $\text{Ci}$  |  $\text{Ei}$  |  $\text{Li}$  |  $\text{Si}$  |  $\text{Ssi}$  |  $\text{int}$  |  $\text{sin}$

# sign

Sign of a real or complex number

## Syntax

`sign(z)`

## Description

`sign(z)` returns the sign of the number  $z$ .

Mathematically, the sign of a complex number  $z \neq 0$  is defined as  $\frac{z}{|z|}$ . For real numbers, this reduces to 1 or -1.

`sign()` and `sign(0.0)` return 0. The user may redefine this value by a direct assignment, e.g.:

```
unprotect(sign): sign(0) := 1: protect(sign):
```

If the type of  $z$  is `DOM_INT`, `DOM_RAT`, or `DOM_FLOAT`, a fast kernel function is used to determine the sign. The return value is either -1, 0, or 1.

If the sign of the expression cannot be determined, a symbolic function call is returned. Certain simplifications are implemented. In particular, numerical factors of symbolic products are simplified. Cf. "Example 2" on page 1-1868 (Symbolic Math Toolbox).

The `expand` function rewrites the sign of a product to a product of signs. E.g., `expand(sign(x*y))` yields `sign(x)*sign(y)`. Cf. "Example 2" on page 1-1868 (Symbolic Math Toolbox).

For constant expressions such as `PI - sqrt(2)`, `exp(I*3) - I*sin(3)` etc., internal floating-point evaluation is used to determine, whether the expression represents a non-zero real number. If so, the sign -1 or 1 is returned. Internally, the floating-point approximation is checked for reliability. Cf. "Example 4" on page 1-1869 (Symbolic Math Toolbox).

## Environment Interactions

`sign` respects properties (Symbolic Math Toolbox) of identifiers. For real expressions, the result may depend on the value of the environment variable `DIGITS`.

### Examples

#### Example 1

We compute the sign of various real numbers and expressions:

```
sign(-8/3), sign(3.2), sign(exp(3) - sqrt(2)*PI), sign(0)
```

```
-1, 1, 1, 0
```

The sign of a complex number  $z$  is the complex number  $z/abs(z)$ :

```
sign(0.5 + 1.1*I), sign(2 + 3*I), sign(exp(sin(2 + 3*I)))
```

```
0.4138029443 + 0.9103664775 i, sqrt(13) * (2/13 + 3i/13), e^{cos(2) sinh(3) i}
```

#### Example 2

`sign` yields a symbolic, yet simplified, function call if identifiers are involved:

```
sign(x), sign(2*x*y), sign(2*x + y), sign(PI*exp(2 + y))
```

```
sign(x), sign(x y), sign(2 x + y), sign(e^{y+2})
```

In special cases, the `expand` function may provide further simplifications:

```
expand(sign(2*x*y)), expand(sign(PI*exp(2 + y)))
```

```
sign(x) sign(y), sign(e^y)
```

### Example 3

sign respects properties of identifiers:

```
sign(x + PI)
```

```
sign(x + π)
```

```
assume(x > -3): sign(x + PI)
```

```
1
```

```
unassume(x):
```

### Example 4

The following rational number approximates  $\pi$  to about 30 digits:

```
p:= 39269908169872415480783042291/125000000000000000000000000000000:
```

With the standard precision `DIGITS = 10`, the float test inside `sign` does not give a decisive answer, whether `p` is larger or smaller than  $\pi$ :

```
float(PI - p)
```

```
0.0
```

This result is subject to numerical roundoff and does not allow a conclusion on the sign of the number `PI - p`. The float test inside `sign` checks the reliability of floating-point approximations. In this case, no simplified result is returned:

```
sign(PI - p)
```

```
sign( $\pi - \frac{39269908169872415480783042291}{125000000000000000000000000000000}$ )
```

With increased `DIGITS`, a reliable decision can be taken:

```
DIGITS := 30: sign(PI - p)
```

- 1

delete p, DIGITS:

## Parameters

z

An arithmetical expression (Symbolic Math Toolbox)

## Return Values

Arithmetical expression.

## Overloaded By

z

## See Also

### MuPAD Functions

Im | Re | abs | conjugate



# signIm

Sign of the imaginary part of a complex number

## Syntax

signIm(z)

## Description

signIm(z) represents the sign of Im(z).

signIm(z) indicates whether the complex number z lies in the upper or in the lower half plane: signIm(z) yields 1 if Im(z) > 0, or if z is real and z < 0. At the origin: signIm(0)=0. For all other numerical arguments, -1 is returned. Thus, signIm(z)=sign(Im(z)) if z is not on the real axis.

If the position of the argument in the complex plane cannot be determined, then a symbolic call is returned. If appropriate, the reflection rule signIm(-x) = -signIm(x) is used.

The functions diff and series treat signIm as a constant function. Cf. "Example 2" on page 1-1873 (Symbolic Math Toolbox).

The following relation holds for arbitrary complex z and p:

$$(-z)^p = z^p \frac{1}{(-1)^{p \operatorname{signIm}(z)}}$$

Further, for arbitrary complex z:

$$\sqrt{z^2} = z \operatorname{signIm}(i z)$$

and

$$\ln(-z) = \ln(z) - \operatorname{signIm}(z) \pi i$$

## Environment Interactions

Properties (Symbolic Math Toolbox) of identifiers set via `assume` are taken into account.

### Examples

#### Example 1

For numerical values, the position in the complex plane can always be determined:

```
signIm(2 + I), signIm(- 4 - I*PI), signIm(0.3), signIm(-2/7),  
signIm(-sqrt(2) + 3*I*PI)
```

```
1, -1, -1, 1, 1
```

Symbolic arguments without properties lead to symbolic calls:

```
signIm(x), signIm(x - I*sqrt(2))
```

```
signIm(x), signIm(x -  $\sqrt{2}$  i)
```

Properties set via `assume` are taken into account:

```
assume(x, Type::Real): signIm(x - I*sqrt(2))
```

```
-1
```

```
assume(x > 0): signIm(x)
```

```
-1
```

```
assume(x < 0): signIm(x)
```

```
1
```

```
assume(x = 0): signIm(x)
```

0

`unassume(x):`

## Example 2

`signIm` is a constant function, apart from the jump discontinuities along the real axis. These discontinuities are ignored by `diff`:

`diff(signIm(z), z)`

0

Also `series` treats `signIm` as a constant function:

`series(signIm(z/(1 - z)), z = 0)`

$$-\text{signIm}\left(\frac{z}{z-1}\right) + O(z^6)$$

## Parameters

**z**

An arithmetical expression (Symbolic Math Toolbox) representing a complex number

## Return Values

Either  $\pm 1$ , 0, or a symbolic call of type "signIm".

## Overloaded By

**z**

## simplify

Simplify an expression

### Syntax

```
simplify(f, <target>, options)
```

```
simplify(L, <target>, options)
```

### Description

`simplify(f)` tries to simplify the expression `f` by applying term rewriting rules.

`simplify(f, target)` restricts the simplification to term rewriting rules applicable to one or more target functions.

---

**Note** The `cos`, `sin`, `exp`, `ln`, and `sqrt` targets has been removed. Use `simplify` function calls without these targets. Alternatively, use `radsimp` instead of `simplify` with the `sqrt` target.

---

The `simplify` function performs sequential simplifications. It applies a certain set of term-rewriting rules to the original expression, rewrites the expression according to these rules, takes the result, and applies the next set of term-rewriting rules. The `simplify` function assumes that the output of every rule is “simpler” than the input without further checks. Generally, this method is faster, but less reliable and controllable than the algorithm used by `Simplify`.

If you do not specify a target, `simplify` tries to simplify the whole expression. This first step includes rewriting of products of trigonometric and exponential terms. After that, the function tries to simplify the operands of the expression. If an expression contains special functions, MuPAD calls, the simplification methods available for these functions.

The call `simplify(L, target )` applies simplifications to the operands on page 1-1493 of the object `L`.

If you specify the `logic` target, the `simplify` function simplifies Boolean expressions. With the `logic` target, `simplify` does not use properties and assumptions (Symbolic Math Toolbox) specified for the terms of Boolean expressions.

If you specify the `condition` target, the `simplify` function simplifies Boolean expressions. With the `condition` target, `simplify` uses properties and assumptions (Symbolic Math Toolbox) specified for the terms of Boolean expressions.

## Environment Interactions

`simplify` reacts to properties (Symbolic Math Toolbox) of identifiers.

## Examples

### Example 1

Use the `simplify` function to simplify the following algebraic expressions:

```
simplify(exp(x)-exp(x/2)^2)
```

0

```
f := ln(x) + ln(3) - ln(3*x) + (exp(x) - 1)/(exp(x/2) + 1);  
simplify(f)
```

$e^{\frac{x}{2}} - 1$

### Example 2

To simplify Boolean expressions, use the `logic` target:

```
simplify((a and b) or (a and (not b)), logic)
```

a

### Example 3

Alternatively, to simplify Boolean expressions, use the `condition` target. With the `condition` target, `simplify` uses the properties and assumptions (Symbolic Math Toolbox) specified for the terms of Boolean expressions. With the `logic` target, `simplify` ignores those properties and assumptions:

```
simplify(x > x, condition), simplify(x > x, logic)
```

$\text{FALSE}, x < x$

### Example 4

The option `IgnoreAnalyticConstraints` allows you to get simpler results using a set of purely algebraic simplifications:

```
simplify(ln(x^2 + 2*x + 1) - ln(x + 1))
```

$\ln((x+1)^2) - \ln(x+1)$

```
simplify(ln(x^2 + 2*x + 1) - ln(x + 1), IgnoreAnalyticConstraints)
```

$\ln(x+1)$

If you use this option, the simplifier does not guarantee the equality of the initial expression and the result for all symbolic parameters.

### Example 5

To change the number of simplification steps, use the `Steps` option:

```
f := ((exp(-x*I)*I)/2 - (exp(x*I)*I)/2)/(exp(-x*I)/2 + exp(x*I)/2);  
simplify(f);  
simplify(f, Steps = 10);  
simplify(f, Steps = 50)
```

$$-\frac{e^{2xi}i-i}{e^{2xi}+1}$$

$$\frac{2i}{e^{2xi}+1} - i$$

$\tan(x)$

## Example 6

Your custom functions can have simplification attributes. For example, suppose you know that  $f$  is an additive function, but you do not know more about  $f$ . Therefore, you cannot compute the function value of at any point except zero, but you can use the additivity:

```
f := funcenv( x -> if iszero(x) then 0 else procname(x) end):
f::simplify := proc(F)
    local argument;
    begin
        argument := op(F,1);
        if type(argument) = "_plus" then
            map(argument, f)
        else
            F
        end
    end:
end:
```

```
f(x + 3*y) - f(3*y) = simplify(f(x + 3*y) - f(3*y))
```

$$f(x+3 y) - f(3 y) = f(x)$$

You can refine the simplification attribute of  $f$  further. For example, you can specify that it must turn  $f(3*y)$  into  $3*f(y)$ . The reverse rule (rewriting  $f(x) + f(y)$  as  $f(x + y)$ ) is not context-free. Therefore, you cannot implement the reverse rule in a simplification attribute.

## Parameters

### f

An arithmetical expression (Symbolic Math Toolbox)

### L

A container object: an array on page 7-2, an hfarray on page 7-27, a list on page 7-41, a matrix on page 1-2045 (Symbolic Math Toolbox), a polynomial on page 1-1601, a set on page 7-50, or a table on page 1-2103.

### target

One of the identifiers `unit`, `logic`, or `condition`

## Options

### IgnoreAnalyticConstraints

With this option the simplifier applies the following rules to expressions:

- $\ln(a) + \ln(b) = \ln(ab)$  for all values of  $a$  and  $b$ . In particular:

$$(a b)^c = e^{c \ln(ab)} = e^{c(\ln(a) + \ln(b))} = a^c b^c \text{ for all values of } a, b, \text{ and } c$$

- $\ln(a^b) = b \ln(a)$  for all values of  $a$  and  $b$ . In particular:

$$(a^b)^c = e^{b c \ln(a)} = e^{\ln(a)^{b c}} = a^{b c} \text{ for all values of } a, b, \text{ and } c$$

- If  $f$  and  $g$  are standard mathematical functions and  $f(g(x)) = x$  for all small positive numbers,  $f(g(x)) = x$  is assumed to be valid for all complex  $x$ . In Particular:

- $\ln(e^x) = x$
- $\arcsin(\sin(x)) = x$ ,  $\arccos(\cos(x)) = x$ ,  $\arctan(\tan(x)) = x$
- $\operatorname{arcsinh}(\sinh(x)) = x$ ,  $\operatorname{arccosh}(\cosh(x)) = x$ ,  $\operatorname{arctanh}(\tanh(x)) = x$
- $W_k(x e^x) = x$  for all values of  $k$

Using the `IgnoreAnalyticConstraints` option can give you simple results for expressions for which the direct use of the simplifier returns complicated results. With



this option the simplifier does not guarantee the equality of the initial expression and the result for all symbolic parameters. See “Example 4” on page 1-1876 (Symbolic Math Toolbox).

### **Seconds**

Limit the time allowed for the internal simplification process. The value denotes the maximal time in seconds. By default, the simplification time is unlimited.

### **Steps**

Terminate algebraic simplification after the specified number of simplification steps. The value must be a positive integer. the default number of simplification steps is 1.

## **Return Values**

Object of the same type as the input object  $f$  or  $L$ , respectively.

## **Overloaded By**

$f$ ,  $L$

## **See Also**

### **MuPAD Functions**

`Simplify` | `collect` | `combine` | `expand` | `factor` | `match` | `normal` | `radsimp` | `rectform` | `rewrite`

### **Topics**

“Use General Simplification Functions” (Symbolic Math Toolbox)

“Manipulate Expressions” (Symbolic Math Toolbox)

“If You Want to Simplify Results Further” (Symbolic Math Toolbox)

# Simplify

Simplify an expression

## Syntax

`Simplify(f)`

`Simplify(f, Steps = numberOfSteps)`

`Simplify(f, options)`

## Description

`Simplify(f)` applies term-rewriting rules to `f` and returns the simplest expression it can find.

The methods of searching for the simplest representation of an expression are different for `Simplify` and `simplify`. The `simplify` function performs a linear search trying to improve the result returned by the previous simplification step. The `Simplify` function uses the results returned by all previous simplification steps (the best-first search). The `simplify` function is faster. The `Simplify` function is slower, but more effective and more configurable.

The term “simplest” is defined as follows. One object is simpler than another if it has smaller *valuation*. If two objects have the same valuation, `Simplify` chooses the simpler object using internal heuristics. A valuation is a function that assigns a nonnegative real number to each MuPAD object. To override the default valuation used by `Simplify`, use the `Valuation` option. `Simplify` uses the valuation for the best-first search as for determining the best result at the final step. However, you can define a separate method for the final simplification step by using the `Criterion` option.

The simplification process consists of *steps*. In each step, `Simplify` performs one of the following kinds of tasks for `a := f` or some (previously obtained) object `a` equivalent to `f`. In each step, `Simplify` can produce new objects equivalent to `f` (results) or new tasks to do or both:

- Initial step: Find all *rules* for *a*. The `Simplify` function performs the search for all rules for every new object *a*. This search produces no new result.
- Rewriting step: Apply one rule to *a*. This step can either fail or produce an equivalent object as result.
- Subexpression step: Perform one step in simplifying an operand of *a*. Replace the operand with the returned result (if there are any results). This step can produce a new equivalent object.

Each open task has a priority that determines what to do next. Simplification terminates in any of the following cases:

- There are no more open tasks.
- `Simplify` reached the time limit specified by `Seconds`.
- `Simplify` performed the maximal number of simplification steps specified by `Steps`.
- `Simplify` returned the object specified by `Goal`.

`Simplify` always returns the “simplest” equivalent object found in all simplification steps unless you specify another `OutputType`.

Rules form a particular domain `Rule`. They consist of a pattern (left side), an expression (right side), and options.

MuPAD organizes rules for `Simplify` in *rule bases*. You can change the default rule base by using the `RuleBase` option. You also can define your own rule selection mechanism by using the `SelectRules` option.

Typically, `Simplify` applies the selected rules to the given object *a* as a whole. The following case is an exception from this rule. If the pattern of the rule and the object *a* are both a sum or a product, then `Simplify` applies the rule to each subsum or subproduct of *a* that has the same number of operands as the pattern.

By using the `ApplyRule` option, you can specify your own function that applies a particular rule to a particular object. Otherwise, `Simplify` uses a default method.

The application of a rule to an object *a* fails if the pattern does not match (see `match`) the object *a*. The performance of `Simplify` strongly depends on the number of successful matches. Therefore, if you specify your own rule base, it must dispose of non-matching rules before rule selection.

A simplification step for an operand works like a simplification step on simplifying  $f$ . The exceptions are as follows. Performing a simplification step for an operand, MuPAD does not apply certain rules (see the details on `SelectRules`).

MuPAD determines priorities of open tasks as follows. The priority of doing the initial step for an expression depends on the valuation of the expression. The priority of doing a simplification step on an operand depends on the ratio between the overall valuation of the expression and the valuation of the operand and the priority of the highest-rank task in the to-do list of the operand. Finally, the priority of applying a rule to an expression equals to the priority of the rule multiplied by the valuation of the expression.

The strategy determines the priority of a rule. See the `Strategy` option for details.

`Simplify` never uses the symmetry of mathematical equivalence of expressions. Therefore, you can use `Simplify` as a general rewriting system.

`Simplify` maps to lists, sets, and tables.

For domain elements  $d$ , `Simplify` can be overloaded in two ways. First, `Simplify` uses the slot `d::dom::Simplify`. If that slot does not exist, `Simplify` uses `d::dom::simplify`. If the slot that `Simplify` uses is not a list, `Simplify` calls the slot and accepts the result as simple (even if the valuation does not agree). In this case, `Simplify` does not apply any other rules to  $d$ . However, `Simplify` uses the valuation to decide whether it must replace a domain element that occurs as an operand in another object with its “simplified” version. If the slot is a list, its entries must be rules, and `Simplify` applies them according to their priority.

## Examples

### Example 1

The easiest way to use `Simplify` is to accept all defaults, and then plug in the expression you want to simplify:

```
Simplify(sin(x)^2 + cos(x)^2)
```

1

## Example 2

By default, `Simplify` returns only one expression that the function considers as simplest. To return a list of all equivalent expressions, use the `All` option:

```
Simplify(sin(x)^2 + cos(x)^2, All)
```

```
[1, cos(x)^2 + sin(x)^2]
```

## Example 3

The output of the previous example is short because as soon as the simplifier finds 1, it stops immediately. After that, the simplifier does not look for other equivalent expressions. In addition, the simplifier discards the equivalent expressions that are significantly more complicated than the best expression found earlier. You can switch off both mechanisms:

```
Simplify(sin(x)^2 + cos(x)^2, All, Discard = FALSE,  
        IsSimple = FALSE)
```

$$\left[ 1, \cos(x)^2 + \sin(x)^2, -\cos(x)^2 - \sin(x)^2 + 2, \sin(x)^2 + \sigma_5 + \frac{1}{2}, \cos(x)^2 - \sigma_5 + \frac{1}{2}, \right. \\ \left. -\cos(x)^2 + \sigma_5 + \frac{3}{2}, -\sin(x)^2 - \sigma_5 + \frac{3}{2}, \sigma_7 + \sigma_8, 2 - \sigma_8 - \sigma_7, \sigma_8 - \sigma_2 + \frac{1}{2}, \sigma_2 - \sigma_8 + \frac{3}{2}, \right. \\ \left. \sigma_2 + \sigma_7 + \frac{1}{2}, \frac{3}{2} - \sigma_7 - \sigma_2, \sigma_3 + \sigma_1, 2 - \sigma_1 - \sigma_3, \frac{1}{2} - \sigma_6 + \sigma_3 - \sigma_4, \sigma_4 + \sigma_6 - \sigma_3 + \frac{3}{2}, \right. \\ \left. \sigma_4 + \sigma_6 + \sigma_1 + \frac{1}{2}, \frac{3}{2} - \sigma_6 - \sigma_1 - \sigma_4, \frac{1}{\sigma_9} + \frac{2\sigma_{10}}{\sigma_9} + \frac{\sigma_{11}}{\sigma_9} \right]$$

where

$$\sigma_1 = \left( \frac{e^{-xi}}{2} - \frac{e^{xi}}{2} \right)^2$$

$$\sigma_2 = \frac{\tan(x)^2 - 1}{2(\tan(x)^2 + 1)}$$

$$\sigma_3 = \left( \frac{e^{-xi}}{2} + \frac{e^{xi}}{2} \right)^2$$

$$\sigma_4 = \frac{e^{-2xi}}{4}$$

$$\sigma_5 = \frac{\cos(2x)}{2}$$

$$\sigma_6 = \frac{e^{2xi}}{4}$$

$$\sigma_7 = \frac{(\sigma_{10} - 1)^2}{(\sigma_{10} + 1)^2}$$

$$\sigma_8 = \frac{4\sigma_{10}}{(\sigma_{10} + 1)^2}$$

$$\sigma_9 = \sigma_{11} + 2\sigma_{10} + 1$$

**1-1884**

$$\sigma_{10} = \tan\left(\frac{x}{2}\right)^2$$

## Example 4

By default, `Simplify` uses a valuation that favors expressions with fewer different irrational subexpressions. For example, `Simplify` assumes that an expression containing only  $\sin(x)$  or  $\cos(x)$  is simpler than an expression containing both:

```
Simplify(cos(x)*sin(x))
```

$$\frac{\sin(2x)}{2}$$

If you take the length as a complexity measure for expressions, `Simplify` returns another result:

```
Simplify(cos(x)*sin(x), Valuation = length)
```

$$\cos(x) \sin(x)$$

## Example 5

The default number of steps is 100. To change the maximal number of possible simplification steps, use the `Steps` option. For example, decrease (resulting in a speedup) and increase (resulting in a probably better simplification) the number of simplification steps:

```
f := ln(x) + ln(3) - ln(3*x) + (exp(x) - 1)/(exp(x/2) + 1):
Simplify(f, Steps = 8), Simplify(f, Steps = 120)
```

$$\frac{e^x}{e^{\frac{x}{2}} + 1} - \frac{1}{e^{\frac{x}{2}} + 1}, e^{\frac{x}{2}} - 1$$

```
delete f:
```

## Example 6

For many expressions, the default number of simplification steps does not allow the simplifier to find a good simplification:

`Simplify(e^(a* x *(a + 1) + b2* y *(y + b2* x* y)))`

$$e^{b2 y (y+b2 x y)+a x (a+1)}$$

Increasing this limit often helps:

`Simplify(e^(a* x *(a + 1) + b2* y *(y + b2* x* y)), Steps=125)`

$$e^{b2 (b2 x+1) y^2+a x (a+1)}$$

## Example 7

By default, simplification functions do not combine logarithms:

`Simplify(ln(x^3 - 1) - ln(x - 1))`

$$\ln(x^3 - 1) - \ln(x - 1)$$

Using the `IgnoreAnalyticConstraints` option, you often can get shorter results:

`Simplify(ln(x^3 - 1) - ln(x - 1), IgnoreAnalyticConstraints)`

$$\ln(x^2 + x + 1)$$

## Example 8

You can write the same expression in different coordinate systems. For example, use Cartesian and polar coordinates:

```
assume(x/r = cos(Symbol::theta)):
assumeAlso(y/r = sin(Symbol::theta)):
assumeAlso(r = sqrt(x^2+y^2)):
x/sqrt(x^2+y^2) + I*y/sqrt(x^2+y^2) = exp(I*Symbol::theta);
Simplify(%)
```



$$\frac{x}{\sqrt{x^2 + y^2}} + \frac{y i}{\sqrt{x^2 + y^2}} = e^{\theta i}$$

TRUE

## Example 9

The following expression is equivalent to  $\exp(x)$ :

$$a := -1/(\sin(1/2*I*x)^2 + 4*\sin(1/4*I*x)^4 - 4*\sin(1/4*I*x)^2 + 1)*(\sin(1/2*I*x)^2 - 4*I*\sin(1/2*I*x)*\sin(1/4*I*x)^2 + 2*I*\sin(1/2*I*x) - 4*\sin(1/4*I*x)^4 + 4*\sin(1/4*I*x)^2 - 1)$$

$$-\frac{\sigma_1^2 - 4\sigma_1 \sin\left(\frac{x i}{4}\right)^2 + 2\sigma_1 i - 4\sin\left(\frac{x i}{4}\right)^4 + 4\sin\left(\frac{x i}{4}\right)^2 - 1}{\sigma_1^2 + 4\sin\left(\frac{x i}{4}\right)^4 - 4\sin\left(\frac{x i}{4}\right)^2 + 1}$$

where

$$\sigma_1 = \sin\left(\frac{x i}{2}\right)$$

Simplify recognizes the equivalence of  $a$  and  $\exp(x)$  within 100 steps. To show how the function proves the equivalence at each step, use the `OutputType` option. Note that the proof returned by `Simplify` is not a proof in a strict mathematical sense. `Simplify` uses the rules from the default rule base:

```
Simplify(a, OutputType = "Proof")
```

Input was

```
-(sin((x*I)/2)^2 - 4*sin((x*I)/2)*sin((x*I)/4)^2*I + 2*sin((x*I)/2)*I - \
4*sin((x*I)/4)^4 + 4*sin((x*I)/4)^2 - 1)/(sin((x*I)/2)^2 + 4*sin((x*I)/4)^4 - \
4 - 4*sin((x*I)/4)^2 + 1)
```

Applying the rule

```
Simplify::combineSinCos
```

```
gives
  cos(x*I) - sin(x*I)*I
Applying the rule
  Simplify::expand
gives
  cosh(x) + sinh(x)
Applying the rule
  X -> rewrite(X, exp)
gives
  exp(x)
END OF PROOF
```

## Example 10

You also can use `Simplify` for experiments with formal grammars given by only a few rules. In this case, the better approach is not to use rule bases, but to use a `SelectRules` method that returns a list of all rules. The following example presents a general associative operator `?`. The example computes the number of all possible placements of parentheses. First, define the operator, and then attach it to a function that controls its output (see `funcenv`). Specify that the only applicable rule is the associative law. In the call to `Simplify`, set the number of steps to a very large value to perform a complete search. Note that most grammars produce infinitely many words and spend infinite time to finish a complete search:

```
_f := funcenv(() -> procname(args())):
operator("?", _f, Binary, 1000):
R := Rule((X ? Y) ? Z, X ? (Y ? Z)):
selectProc := () -> [R]:
S := Simplify(u ? v ? x ? y ? z, Steps = 10^10,
             SelectRules = selectProc, All):

PRETTYPRINT := FALSE:
print(Plain, S):
PRETTYPRINT := TRUE:
```

```
[u ? (v ? (x ? (y ? z))), u ? (v ? ((x ? y) ? z)), u ? ((v ? (x ? y)) ? z)\
, u ? (((v ? x) ? y) ? z), u ? ((v ? x) ? (y ? z)), (u ? (v ? x)) ? (y ? z)\
), ((u ? v) ? x) ? (y ? z), (u ? v) ? (x ? (y ? z)), (u ? v) ? ((x ? y) ? \
z), (u ? (v ? (x ? y))) ? z, (u ? ((v ? x) ? y)) ? z, ((u ? (v ? x)) ? y) \
? z, (((u ? v) ? x) ? y) ? z, ((u ? v) ? (x ? y)) ? z]
```

There are 14 possible ways of placing parentheses:

```
nops(S);
delete fout, _f, R, S, selectProc:
operator("?", Delete):
```

14

## Example 11

If you want to specify a larger set of rules, the best approach is to use your own rule base. A classic example is differentiation. Although a heuristic search must be slower than a simple recursive algorithm, this example is suitable for demonstrating some efficiency considerations. Start by defining a function environment `mydiff` that does not do anything:

```
mydiff := funcenv(mydiff):
mydiff::type := "mydiff"
```

"mydiff"

The goal of this definition is to show that MuPAD sorts rules in rule bases by the types of expressions to which MuPAD applies those rules. Therefore, `mydiff` gets its own type. Now, define a rule base `Myrules` with the usual differentiation rules. Do not use any additional rules:

```
Myrules := newDomain("Myrules"):
Myrules::mydiff :=
  [Rule(mydiff(f, x), 0, {(f, x) -> not has(f, x)}),
   Rule(mydiff(x, x), 1),
   Rule(mydiff(x^n, x), n*x^(n - 1)),
   Rule(mydiff(f*g, x), f*mydiff(g, x) + g*mydiff(f, x)),
   Rule(mydiff(f + g, x), mydiff(f, x) + mydiff(g, x))
  ]:
```

This rule base works for the expression  $x^2$ :

```
Simplify(mydiff(x^2, x), RuleBase = Myrules)
```

2 x

However, the rule base does not work for the following expression:

```
Simplify(mydiff(x + 3, x), RuleBase = Myrules)
```

```
mydiff(x + 3, x)
```

Try to improve that rule base. As a first step, increase the number of simplification steps. Increasing the number of steps does not help in this case:

```
Simplify(mydiff(x + 3, x), RuleBase = Myrules, Steps = 200)
```

```
mydiff(x + 3, x)
```

As a second step, take a closer look on the equivalent expressions returned by `Simplify`. Sometimes, `Simplify` finds the expected result, but does not return it because the valuation of the expected result is higher than the valuation of some other equivalent expression. For the expression  $x + 3$ , the `Simplify` function does not find the expected result:

```
l := Simplify(mydiff(x + 3, x), RuleBase = Myrules, All)
```

```
[ $\sigma_1$ , mydiff(x, x) + mydiff(3, x), (x + 3) mydiff(1, x) +  $\sigma_1$ , 2 (x + 3) mydiff(1, x) +  $\sigma_1$ ,  
3 (x + 3) mydiff(1, x) +  $\sigma_1$ , 4 (x + 3) mydiff(1, x) +  $\sigma_1$ , 5 (x + 3) mydiff(1, x) +  $\sigma_1$ ,  
6 (x + 3) mydiff(1, x) +  $\sigma_1$ , 7 (x + 3) mydiff(1, x) +  $\sigma_1$ , 8 (x + 3) mydiff(1, x) +  $\sigma_1$ ,  
9 (x + 3) mydiff(1, x) +  $\sigma_1$ , 10 (x + 3) mydiff(1, x) +  $\sigma_1$ , 11 (x + 3) mydiff(1, x) +  $\sigma_1$ ,  
12 (x + 3) mydiff(1, x) +  $\sigma_1$ , 13 (x + 3) mydiff(1, x) +  $\sigma_1$ , 14 (x + 3) mydiff(1, x) +  $\sigma_1$ ,  
15 (x + 3) mydiff(1, x) +  $\sigma_1$ , 16 (x + 3) mydiff(1, x) +  $\sigma_1$ , 17 (x + 3) mydiff(1, x) +  $\sigma_1$ ,  
18 (x + 3) mydiff(1, x) +  $\sigma_1$ , 19 (x + 3) mydiff(1, x) +  $\sigma_1$ , 20 (x + 3) mydiff(1, x) +  $\sigma_1$ ,  
21 (x + 3) mydiff(1, x) +  $\sigma_1$ , 22 (x + 3) mydiff(1, x) +  $\sigma_1$ , 23 (x + 3) mydiff(1, x) +  $\sigma_1$ ,  
24 (x + 3) mydiff(1, x) +  $\sigma_1$ , 25 (x + 3) mydiff(1, x) +  $\sigma_1$ , 26 (x + 3) mydiff(1, x) +  $\sigma_1$ ,  
27 (x + 3) mydiff(1, x) +  $\sigma_1$ , 28 (x + 3) mydiff(1, x) +  $\sigma_1$ , 29 (x + 3) mydiff(1, x) +  $\sigma_1$ ,  
30 (x + 3) mydiff(1, x) +  $\sigma_1$ , 31 (x + 3) mydiff(1, x) +  $\sigma_1$ ]
```

where

```
 $\sigma_1 = \text{mydiff}(x + 3, x)$ 
```

Note that the derivative of 1 appears in the result. Use the `OutputType` option, to check how `Simplify` manipulates the third term `l[3]` and how it proves the equivalence of input and output at each step:

```
Simplify(mydiff(x + 3, x), RuleBase = Myrules,
          Goal = 1[3],
          OutputType = "Proof")
```

```
Input was
  mydiff(x + 3, x)
Applying the rule
  mydiff(f*g, x) -> f*mydiff(g, x) + g*mydiff(f, x)
gives
  (x + 3)*mydiff(1, x) + mydiff(x + 3, x)
END OF PROOF
```

Now you can see that for each expression  $f$ , you must specify the rule for differentiating products because  $f = 1 f$ . Modify that rule:

```
(Myrules::mydiff)[4] := Rule(mydiff(f*g, x),
                             f*mydiff(g, x) + g*mydiff(f, x),
                             {(f, g) -> f <> 1 and g <> 1}):
```

The updated rule base works:

```
Simplify(mydiff(x + 3, x), RuleBase=Myrules, Remember=FALSE)
```

1

Use a few options to optimize the call to `Simplify`. As a first step, measure how many steps a typical example takes before returning the expected output:

```
Simplify(mydiff(5*x^4 + x^3 + x^2 + x + 1, x),
          RuleBase = Myrules,
          Steps = 2000,
          Goal = 20*x^3 + 3*x^2 + 2*x + 1,
          OutputType = "NumberOfSteps")
```

134

Avoid the application of the equality  $f = f + 0$ . Switch off the remember mechanism. When the remember mechanism works, `Simplify` ignores changes in the rule base:

```
Myrules::mydiff[5] := Rule(mydiff(f + g, x),
                           mydiff(f, x) + mydiff(g, x),
```

```
                {(f, g) -> f <> 0 and g <> 0}):  
Simplify(mydiff(5*x^4 + x^3 + x^2 + x + 1, x),  
         RuleBase = Myrules,  
         Steps = 2000,  
         Goal = 20*x^3 + 3*x^2 + 2*x + 1,  
         OutputType = "NumberOfSteps",  
         Remember = FALSE)
```

129

Next, try to change the valuation criteria. For example, use `length`:

```
Simplify(mydiff(5*x^4 + x^3 + x^2 + x + 1, x),  
         RuleBase = Myrules,  
         Steps = 2000,  
         Goal = 20*x^3 + 3*x^2 + 2*x + 1,  
         OutputType = "NumberOfSteps",  
         Valuation = length)
```

121

To optimize the call to `Simplify`, you also can specify your own simplification *strategy*. For example, the first rule seems to provide a very useful simplification whenever it applies. Therefore, assign a high priority to this rule by assuming that on average this rule simplifies its input to 0.03 of the original complexity:

```
Myrules::mydiff[1] := subsop(Myrules::mydiff[1],  
                            4 = table("MyStrategy" = 0.03));  
Simplify(mydiff(5*x^4 + x^3 + x^2 + x + 1, x),  
         RuleBase = Myrules,  
         Steps = 3000,  
         Goal = 20*x^3 + 3*x^2 + 2*x + 1,  
         OutputType = "NumberOfSteps",  
         Strategy = "MyStrategy")
```

124

When using the valuation `length`, you get the following result:

```
Simplify(mydiff(5*x^4 + x^3 + x^2 + x + 1, x),  
         RuleBase = Myrules,
```

```

Steps = 3000,
Goal = 20*x^3 + 3*x^2 + 2*x + 1,
OutputType = "NumberOfSteps",
Strategy = "MyStrategy",
Valuation = length)

```

## 125

When you use a matcher-based simplification, most of the rules do not match to most objects. Trying to match all rules to all objects produces many failing rewriting steps. The recommended approach is to discard these failing rules during the initial step. Discarding failing rules decreases the number of steps. It also increases the running time per step by a small amount. Defining a procedure instead of a list of rules can help you to discard the failing rules during an initial step. You can define the rules by using a pattern or a procedure as their first argument:

```

Myrules::mydiff :=
proc(df)
begin
  [if not has(op(df, 1), op(df, 2)) then
    Rule(X -> 0)
  else
    case type(op(df, 1))
    of "_plus" do
      Rule(X -> map(op(X, 1), mydiff, op(X, 2)));
      break
    of "_mult" do
      Rule(mydiff(f*g, x), f*mydiff(g, x) + g*mydiff(f, x));
      break
    of "_power" do
      Rule(X -> op(X, [1,2])*op(X, [1,1])^(op(X, [1,2]) - 1));
      break
    of DOM_IDENT do
      assert(op(df, 1) = op(df, 2));
      Rule(X -> 1);
      break
    otherwise
      null()
    end_case
  end_if]
end_proc:
Simplify(mydiff(5*x^4 + x^3 + x^2 + x + 1, x),
  RuleBase = Myrules,

```

```
Steps = 200,  
Goal = 20*x^3 + 3*x^2 + 2*x + 1,  
OutputType = "NumberOfSteps")
```

35

```
delete Myrules, mydiff:
```

## Parameters

**f**

Any object

## Options

**All**

When you use the All option, the Simplify function returns a list of all equivalent objects that the function can find. This syntax is a shortcut for `OutputType = "All"`.

**ApplyRule**Option, specified as `ApplyRule = applyFunction`

Specify the function `applyFunction` that Simplify calls every time when a rule R must be applied to an object `a`. Here, `applyFunction` must be a function of two arguments R (a rule) and `a` (an object). It must return the result of applying the rule R to an object `a`. If the rule is not applicable, the `applyFunction` function must return FAIL.

**Discard**Option, specified as `Discard = discardFunction`

Specify the function `discardFunction(newvalue, bestvalue)` that Simplify calls every time it finds a new object equivalent to `f`. Here `newvalue` is the valuation of the new object, and `bestvalue` is the minimal valuation among all equivalent objects that Simplify found earlier. If Boolean evaluation of the result produces TRUE, then Simplify discards the new object. By default, Simplify discards a result if its valuation



exceeds  $10 \times \text{current best valuation} + 1$ . To prevent the loss of results, switch this mechanism off: `Discard = FALSE`.

### Criterion

Option, specified as `Criterion = CriterionFunction`

Specify the function `CriterionFunction(a, vala)` that `Simplify` calls at the end of the computation to perform the final sorting of the results. For each result `a` and its valuation `vala`, `CriterionFunction(a, vala)` returns a number. `Simplify` uses that number to sort the results. By default, `Simplify` uses `vala` to sort the results.

### Goal

Option, specified as `Goal = a`

If the `Simplify` function finds the equivalent object `a`, stop the computation and return `a` even if this object is not the simplest equivalent expression found.

### IgnoreAnalyticConstraints

With this option the simplifier applies the following rules to expressions:

- $\ln(a) + \ln(b) = \ln(ab)$  for all values of  $a$  and  $b$ . In particular:

$$(ab)^c = e^{c \ln(ab)} = e^{c(\ln(a) + \ln(b))} = a^c b^c \text{ for all values of } a, b, \text{ and } c$$

- $\ln(a^b) = b \ln(a)$  for all values of  $a$  and  $b$ . In particular:

$$(a^b)^c = e^{b c \ln(a)} = e^{\ln(a)^{b c}} = a^{b c} \text{ for all values of } a, b, \text{ and } c$$

- If  $f$  and  $g$  are standard mathematical functions and  $f(g(x)) = x$  for all small positive numbers,  $f(g(x)) = x$  is assumed to be valid for all complex  $x$ . In particular:

- $\ln(e^x) = x$
- $\arcsin(\sin(x)) = x$ ,  $\arccos(\cos(x)) = x$ ,  $\arctan(\tan(x)) = x$
- $\operatorname{arcsinh}(\sinh(x)) = x$ ,  $\operatorname{arccosh}(\cosh(x)) = x$ ,  $\operatorname{arctanh}(\tanh(x)) = x$
- $W_k(x e^x) = x$  for all values of  $k$

With this option, the `Simplify` function can return simple results for expressions for which `Simplify` without this option returns more complicated results. With this option

the simplifier does not guarantee the equality of the initial expression and the result for all symbolic parameters. See “Example 7” on page 1-1886 (Symbolic Math Toolbox).

### **IsSimple**

Option, specified as `IsSimple = B`

Specify the function  $B(a)$  that the `Simplify` function calls for any expression  $a$  that is equivalent to any subexpression of the input. If the result of the call is `TRUE`, then the `Simplify` function does not simplify this subexpression any further.  $B$  must return `TRUE` or `FALSE` for every input.

### **KernelSteps**

Option, specified as `KernelSteps = n`

Limit the effort invested in one simplification step. Here  $n$  must be a positive integer. The default value is 100.

### **OutputType**

Option, specified as `OutputType = output`

Specify the type of return value. The value `output` must be one of the strings "All", "Best", "NumberOfSteps", or "Proof". This option makes `Simplify` return all results, the best result, the number of performed simplification steps, or a proof for the equivalence of the input and the best result. By default, `Simplify` returns the simplest result found.

Even if you specify the output type as "All", `Simplify` does not return any results discarded due to the `Discard` option. To get all results, set `Discard` to `FALSE`. See “Example 3” on page 1-1883 (Symbolic Math Toolbox).

If you set this option to "Proof", the `Simplify` function returns text displaying proof steps and lemmas. Proof steps state that  $f_{i-1}$  is equivalent to  $f_i$  for  $1 \leq i \leq n$ , where  $f_0 = f$  is the input and  $f_n$  is the result of the simplification. Each proof step is either a rule application or a lemma application. A rule application step shows that applying a rule to  $f_{i-1}$  gives  $f_i$ . A lemma application step shows that replacing some operand of  $f_{i-1}$  by an equivalent object gives  $f_i$ . A lemma consists of the statement that two objects are equivalent, a proof in the above sense, and the `END OF LEMMA` tag.

Technically, proofs are objects of the same type as the output of `expose`.

## Remember

Option, specified as `Remember = bool`

The `Remember` option switches the remember mechanism on and off. If you call `Simplify` with the same argument several times, the remember mechanism saves running time. If the argument of one call reappears as a subexpression in the argument of another call, the remember mechanism does not help to save time. By default, `bool` is `TRUE`.

## RuleBase

Option, specified as `RuleBase = base`

A rule base `base` is a domain that contains its rules for expressions of type `T` in its slot `slot(base, T)`. In addition, the following three slots can contain rules for a rule base: `base::All`, `base::Global`, and `base::Local`. The `base::All` slot contains generally applicable rules. The `base::Global` slot contains rules that the `Simplify` function applies only to expressions. `Simplify` does not apply the rules defined in `base::Global` within a subexpression step. The `base::Local` slot contains rules that the `Simplify` function applies only within a subexpression step. If no slots exist for the type of a given object, MuPAD does not generate any rules for that object. A slot of a rule base is a list of rules or a procedure that returns such a list for any given object of appropriate type. Any rule must be an object of type `Rule`. See the `Rule` help page for details. If you use your own `SelectRules`, you can ignore these conventions. See “Example 11” on page 1-1889 (Symbolic Math Toolbox).

## Seconds

Option, specified as `Seconds = t`

When you use the `Seconds` option, the `Simplify` function limits the time allowed for the internal simplification process. The value `t` is the maximal time in seconds. By default, the simplification process never terminates due to a time limitation: `t = infinity`.

## SelectRules

Option, specified as `SelectRules = selFunction`

When you use the `SelectRules` option, MuPAD lets you specify the function `selFunction(base, ex, global, strat)` that `Simplify` calls to obtain the rules applicable to `ex` in the rule base `base` for strategy `strat`. The boolean on page 1-2180

flag `global` indicates whether `ex` is the whole expression accepted by `Simplify` (`global = TRUE`) or a subexpression of the original expression (`global = FALSE`). Using the arguments given to `selFunction` is optional. For example, for small rule bases the easiest method is to return a list of all rules independent of the given expression. See “Example 10” on page 1-1888 (Symbolic Math Toolbox). However, returning a list of all rules can result in unnecessary rule applications. Applying each unnecessary rule returns `FAIL` and only affects the performance.

You can define any rule base and use any kind the rules. The only restriction is that `selFunction` must return a list of rules on page 1-1815.

### **Steps**

Option, specified as `Steps = numberOfSteps`

When you use the `Steps` option, the `Simplify` function terminates a simplification after `numberOfSteps` simplification steps. The default number of steps is 100.

### **StopIf**

Option, specified as `StopIf = B`

When you use the `StopIf` option, the `Simplify` function lets you specify the function `B(a)` that `Simplify` calls for any expression `a` that is equivalent to the original expression. If the result is `TRUE`, the simplification stops immediately, and the `Simplify` function returns the expression `a` as the simplest result regardless of its valuation. The specified function `B` must return `TRUE` or `FALSE` for any input.

### **Strategy**

Option, specified as `Strategy = strat`

When you use the `Strategy` option, the `Simplify` function lets you set the rule selection strategy. The value of `strat` must be a string. The `SelectRules` option uses `strat` as an argument that determines the priority for applying each rule.

By default, `Simplify` uses the strategy `"Default"`. The default rule base also uses the strategy `"Default"`.

If a particular rule does not recognize the strategy `strat`, the `Simplify` function uses the strategy `"Default"` to determine the priority of that rule. Finally, if no entry for the default strategy is available, the rule has the priority 1. In this case, expect an output to be as complicated as the input.

If you use the `IgnoreAnalyticConstraints`, `Simplify` uses the strategy that comes with that option instead of using the strategy "Default".

If `Simplify` uses a strategy, that strategy does not affect the valuation of results of rule applications.

## Valuation

Option, specified as `Valuation = valFunction`

When you use the `Strategy` option, the `Simplify` function lets you specify a function MuPAD uses for computing valuations of returned objects. `Simplify` computes the valuation for many intermediate results. Generally, to compute the valuation, `Simplify` evaluates each node of the expression tree. Therefore, the `Valuation` option can significantly affect the running time.

A good valuation is a compromise between context-free and maximum-type concepts. For a context-free valuation, both the operator of an expression and the valuations of the operands determine the valuation of the expression. For a maximum-type valuation, generally the valuation of an expression equals the maximum of valuations of its operands.

A typical context-free example is `length`. A typical maximum-type example is `X -> 2^nops(indets(X))`.

MuPAD offers a context-free valuation `Simplify::complexity`. This valuation favors usual operators like `exp` over unusual ones like `besselJ` and puts a penalty factor on arguments of unusual operators.

## Return Values

`Simplify` returns an object mathematically equivalent to the input. With the option `OutputType = "All"`, the `Simplify` function returns a list of all equivalent objects found during the simplification. With the option `OutputType = "NumberOfSteps"`, the function returns a positive integer. With the option `OutputType = "Proof"`, the function returns a string containing a proof of the equivalence of the input and the result.

## Overloaded By

f

## See Also

### **MuPAD Functions**

collect | combine | expand | factor | match | normal | radsimp | rectform |  
rewrite | simplify

## Topics

“Use General Simplification Functions” (Symbolic Math Toolbox)

“Manipulate Expressions” (Symbolic Math Toolbox)

“If You Want to Simplify Results Further” (Symbolic Math Toolbox)

# sin

Sine function

## Syntax

`sin(x)`

---

**Note** For sine in MATLAB®, see `sin`.

---

## Description

`sin(x)` represents the sine function.

Specify the argument  $x$  in radians, not in degrees. For example, use  $\pi$  to specify an angle of  $180^\circ$ .

All trigonometric functions are defined for complex arguments.

Floating-point values are returned for floating-point arguments. Floating-point intervals are returned for floating-point interval arguments. Unevaluated function calls are returned for most exact arguments.

Translations by integer multiples of  $\pi$  are eliminated from the argument. Further, arguments that are rational multiples of  $\pi$  lead to simplified results; symmetry relations are used to rewrite the result using an argument from the standard interval  $[0, \frac{\pi}{2})$ . Explicit expressions are returned for the following arguments:

$$0, \frac{\pi}{2}, \frac{\pi}{3}, \frac{\pi}{4}, \frac{\pi}{5}, \frac{2\pi}{5}, \frac{\pi}{6}, \frac{\pi}{8}, \frac{3\pi}{8}, \frac{\pi}{10}, \frac{3\pi}{10}, \frac{\pi}{12}, \frac{5\pi}{12}$$

See “Example 2” on page 1-1903 (Symbolic Math Toolbox).

The result is rewritten in terms of hyperbolic functions on page 1-1945, if the argument is a rational multiple of  $i$ . See “Example 3” on page 1-1904 (Symbolic Math Toolbox).

The functions `expand` and `combine` implement the addition theorems for the trigonometric functions. See “Example 4” on page 1-1904 (Symbolic Math Toolbox).

The trigonometric functions do not respond to properties set via `assume`. Use `simplify` to take such properties into account. See “Example 4” on page 1-1904 (Symbolic Math Toolbox).

Use `rewrite` to rewrite expressions in terms of a specific target function. For example, you can rewrite expressions involving the sine function in terms of other trigonometric functions and vice versa. See “Example 5” on page 1-1905 (Symbolic Math Toolbox).

The inverse function is implemented by `arcsin`. See “Example 6” on page 1-1906 (Symbolic Math Toolbox).

The float attributes are kernel functions, thus, floating-point evaluation is fast.

## Environment Interactions

When called with a floating-point argument, `sin` is sensitive to the environment variable `DIGITS` which determines the numerical working precision.

## Examples

### Example 1

Call `sin` with the following exact and symbolic input arguments:

`sin(PI)`, `sin(1)`, `sin(5 + I)`, `sin(PI/2)`, `sin(PI/11)`, `sin(PI/8)`

`0`, `sin(1)`, `sin(5 + i)`, `1`, `sin( $\frac{\pi}{11}$ )`,  `$\frac{\sqrt{2 - \sqrt{2}}}{2}$`

`sin(-x)`, `sin(x + PI)`, `sin(x^2 - 4)`

`$-\sin(x)$` ,  `$-\sin(x)$` ,  `$\sin(x^2 - 4)$`

Floating point values are computed for floating-point arguments:



$\sin(123.4), \sin(5.6 + 7.8*I), \sin(1.0/10^{20})$

$-0.7693905459, -770.3354317 + 946.4236495 i, 1.0 \cdot 10^{-20}$

Floating point intervals are computed for interval arguments:

$\sin(0...1), \sin(20...30), \sin(0...5)$

$0.0 \dots 0.8414709849, -1.0 \dots 1.0, -1.0 \dots 1.0$

## Example 2

Some special values are implemented:

$\sin(\pi/10), \sin(2\pi/5), \sin(123/8\pi), \sin(-\pi/12)$

$\frac{\sqrt{5}}{4} - \frac{1}{4}, \frac{\sqrt{2} \sqrt{\sqrt{5}+5}}{4}, -\frac{\sqrt{\sqrt{2}+2}}{2}, \frac{\sqrt{2}}{4} - \frac{\sqrt{6}}{4}$

Translations by integer multiples of  $\pi$  are eliminated from the argument:

$\sin(x + 10\pi), \sin(3 - \pi), \sin(x + \pi), \sin(2 - 10^{100}\pi)$

$\sin(x), -\sin(3), -\sin(x), \sin(2)$

All arguments that are rational multiples of  $\pi$  are transformed to arguments from the interval  $[0, \frac{\pi}{2})$ :

$\sin(4/7\pi), \sin(-20\pi/9), \sin(123/11\pi), \sin(-\pi/13)$

$\sin\left(\frac{3\pi}{7}\right), -\sin\left(\frac{2\pi}{9}\right), -\sin\left(\frac{2\pi}{11}\right), -\sin\left(\frac{\pi}{13}\right)$

### Example 3

Arguments that are rational multiples of  $I$  are rewritten in terms of hyperbolic functions on page 1-1945:

```
sin(5*I), sin(5/4*I), sin(-3*I)
```

$$\sinh(5) i, \sinh\left(\frac{5}{4}\right) i, -\sinh(3) i$$

For other complex arguments, use `expand` to rewrite the result:

```
sin(5*I + 2*PI/3), sin(PI/4 - 5/4*I), sin(-3*I + PI/2)
```

$$\sin\left(\frac{2\pi}{3} + 5i\right), \sin\left(\frac{\pi}{4} - \frac{5i}{4}\right), \sin\left(\frac{\pi}{2} - 3i\right)$$

```
expand(sin(5*I + 2*PI/3)),  
expand(sin(5/4*I - PI/4)),  
expand(sin(-3*I + PI/2))
```

$$\frac{\sqrt{3} \cosh(5)}{2} - \frac{\sinh(5) i}{2}, -\frac{\sqrt{2} \cosh\left(\frac{5}{4}\right)}{2} + \frac{\sqrt{2} \sinh\left(\frac{5}{4}\right) i}{2}, \cosh(3)$$

### Example 4

The `expand` function implements the addition theorems:

```
expand(sin(x + PI/2)), expand(sin(x + y))
```

$$\cos(x), \cos(x) \sin(y) + \cos(y) \sin(x)$$

The `combine` function uses these theorems in the other direction, trying to rewrite products of trigonometric functions:

```
combine(sin(x)*sin(y), sincos)
```

$$\frac{\cos(x - y)}{2} - \frac{\cos(x + y)}{2}$$

The trigonometric functions do not immediately respond to properties set via `assume`:

```
assume(n, Type::Integer):
sin(n*PI), sin((2*n + 1)*PI/2)
```

$$\sin(\pi n), \sin\left(\frac{\pi(2n+1)}{2}\right)$$

Use `simplify` to take such properties into account:

```
simplify(sin(n*PI)),
simplify(sin((2*n + 1)*PI/2))
```

$$0, (-1)^n$$

```
assume(n, Type::Odd):
sin(n*PI + x), simplify(sin(n*PI + x))
```

$$\sin(x + \pi n), -\sin(x)$$

```
y := sin(x + n*PI) + sin(x - n*PI);
simplify(y)
```

$$\sin(x + \pi n) + \sin(x - \pi n)$$

$$-2 \sin(x)$$

```
delete n, y
```

## Example 5

Use `rewrite` to obtain a representation in terms of a specific target function:

```
rewrite(sin(x)*exp(2*I*x), exp);
rewrite(sin(x), cot)
```

$$e^{2xi} \left( \frac{e^{-xi}i}{2} - \frac{e^{xi}i}{2} \right)$$

$$\frac{2 \cot\left(\frac{x}{2}\right)}{\cot\left(\frac{x}{2}\right)^2 + 1}$$

## Example 6

The inverse function is implemented as `arcsin`:

```
sin(arcsin(x)),  
arcsin(sin(x))
```

```
x, arcsin(sin(x))
```

Note that `arcsin(sin(x))` does not necessarily yield `x` because `arcsin` produces

values with real parts in the interval  $\left[-\frac{\pi}{2}, \frac{\pi}{2}\right]$ :

```
arcsin(sin(3)), arcsin(sin(1.6 + I))
```

```
 $\pi - 3, 1.541592654 - 1.0 i$ 
```

## Example 7

`diff`, `float`, `limit`, `taylor` and other system functions handle expressions involving the trigonometric functions:

```
diff(sin(x^2), x), float(sin(3)*cot(5 + I))
```

```
 $2 x \cos(x^2), -0.01668502608 - 0.1112351327 i$ 
```

```
limit(sin(x)/x, x = 0)
```

```
1
```

```
taylor(sin(x), x = 0)
```

$$x - \frac{x^3}{6} + \frac{x^5}{120} + O(x^7)$$

## Parameters

**x**

An arithmetical expression (Symbolic Math Toolbox) or a floating-point interval on page 7-33

## Return Values

Arithmetical expression or a floating-point interval

## Overloaded By

x

## See Also

### **MuPAD Functions**

arccos | arccot | arccsc | arcsec | arcsin | arctan | cos | cot | csc | sec | tan

## **COS**

Cosine function

### **Syntax**

`cos(x)`

### **Description**

`cos(x)` represents the cosine function.

Specify the argument  $x$  in radians, not in degrees. For example, use  $\pi$  to specify an angle of  $180^\circ$ .

All trigonometric functions are defined for complex arguments.

Floating-point values are returned for floating-point arguments. Floating-point intervals are returned for floating-point interval arguments. Unevaluated function calls are returned for most exact arguments.

Translations by integer multiples of  $\pi$  are eliminated from the argument. Further, arguments that are rational multiples of  $\pi$  lead to simplified results; symmetry relations are used to rewrite the result using an argument from the standard interval  $[0, \frac{\pi}{2})$ . Explicit expressions are returned for the following arguments:

$$0, \frac{\pi}{2}, \frac{\pi}{3}, \frac{\pi}{4}, \frac{\pi}{5}, \frac{2\pi}{5}, \frac{\pi}{6}, \frac{\pi}{8}, \frac{3\pi}{8}, \frac{\pi}{10}, \frac{3\pi}{10}, \frac{\pi}{12}, \frac{5\pi}{12}$$

See “Example 2” on page 1-1910 (Symbolic Math Toolbox).

The result is rewritten in terms of hyperbolic functions on page 1-1945, if the argument is a rational multiple of  $i$ . See “Example 3” on page 1-1910 (Symbolic Math Toolbox).

The functions `expand` and `combine` implement the addition theorems for the trigonometric functions. See “Example 4” on page 1-1911 (Symbolic Math Toolbox).

The trigonometric functions do not respond to properties set via `assume`. Use `simplify` to take such properties into account. See “Example 4” on page 1-1911 (Symbolic Math Toolbox).

Use `rewrite` to rewrite expressions in terms of a specific target function. For example, you can rewrite expressions involving the cosine function in terms of other trigonometric functions and vice versa. See “Example 5” on page 1-1912 (Symbolic Math Toolbox).

The inverse function is implemented as `arccos`. See “Example 6” on page 1-1913 (Symbolic Math Toolbox).

The float attributes are kernel functions, thus, floating-point evaluation is fast.

## Environment Interactions

When called with a floating-point argument, the functions are sensitive to the environment variable `DIGITS` which determines the numerical working precision.

## Examples

### Example 1

Call `cos` with the following exact and symbolic input arguments:

`cos(PI)`, `cos(1)`, `cos(5 + I)`, `cos(PI/2)`, `cos(PI/11)`, `cos(PI/8)`

$$-1, \cos(1), \cos(5 + i), 0, \cos\left(\frac{\pi}{11}\right), \frac{\sqrt{\sqrt{2} + 2}}{2}$$

`cos(-x)`, `cos(x + PI)`, `cos(x^2 - 4)`

$$\cos(x), -\cos(x), \cos(x^2 - 4)$$

Floating-point values are computed for floating-point arguments:

`cos(123.4)`, `cos(5.6 + 7.8*I)`, `cos(1.0/10^20)`

$$-0.6387786689, 946.4239673 + 770.3351731 i, 1.0$$

Floating-point intervals are computed for interval arguments:

$$\cos(0...1), \cos(20...30), \cos(0...3)$$

$$0.5403023058 ... 1.0, -1.0 ... 1.0, -0.9899924967 ... 1.0$$

## Example 2

Some special values are implemented:

$$\cos(\pi/10), \cos(2\pi/5), \cos(123/8\pi), \cos(-\pi/12)$$

$$\frac{\sqrt{2} \sqrt{\sqrt{5} + 5}}{4}, \frac{\sqrt{5}}{4} - \frac{1}{4}, -\frac{\sqrt{2 - \sqrt{2}}}{2}, \frac{\sqrt{2}}{4} + \frac{\sqrt{6}}{4}$$

Translations by integer multiples of  $\pi$  are eliminated from the argument:

$$\cos(x + 10\pi), \cos(3 - \pi), \cos(x + \pi), \cos(2 - 10^{100}\pi)$$

$$\cos(x), -\cos(3), -\cos(x), \cos(2)$$

All arguments that are rational multiples of  $\pi$  are transformed to arguments from the interval  $[0, \frac{\pi}{2})$ :

$$\cos(4/7\pi), \cos(-20\pi/9), \cos(123/11\pi), \cos(-\pi/13)$$

$$-\cos\left(\frac{3\pi}{7}\right), \cos\left(\frac{2\pi}{9}\right), -\cos\left(\frac{2\pi}{11}\right), \cos\left(\frac{\pi}{13}\right)$$

## Example 3

Arguments that are rational multiples of  $I$  are rewritten in terms of hyperbolic functions on page 1-1945:



`cos(5*I), cos(5/4*I), cos(-3*I)`

$\cosh(5), \cosh\left(\frac{5}{4}\right), \cosh(3)$

For other complex arguments, use `expand` to rewrite the result:

`cos(5*I + 2*PI/3), cos(PI/4 - 5/4*I), cos(-3*I + PI/2)`

$\cos\left(\frac{2\pi}{3} + 5i\right), \cos\left(\frac{\pi}{4} - \frac{5i}{4}\right), \cos\left(\frac{\pi}{2} - 3i\right)$

`expand(cos(5*I + 2*PI/3)),`  
`expand(cos(5/4*I - PI/4)),`  
`expand(cos(-3*I + PI/2))`

$-\frac{\cosh(5)}{2} - \frac{\sqrt{3} \sinh(5) i}{2}, \frac{\sqrt{2} \cosh\left(\frac{5}{4}\right)}{2} + \frac{\sqrt{2} \sinh\left(\frac{5}{4}\right) i}{2}, \sinh(3) i$

## Example 4

The `expand` function implements the addition theorems:

`expand(cos(x + PI/2)), expand(cos(x + y))`

$-\sin(x), \cos(x) \cos(y) - \sin(x) \sin(y)$

The `combine` function uses these theorems in the other direction, trying to rewrite products of trigonometric functions:

`combine(cos(x)*cos(y), sincos)`

$\frac{\cos(x - y)}{2} + \frac{\cos(x + y)}{2}$

The trigonometric functions do not immediately respond to properties set via `assume`:

```
assume(n, Type::Integer):  
cos(n*PI), cos((n + 1/2)*PI)
```

$$\cos(\pi n), \cos\left(\pi\left(n + \frac{1}{2}\right)\right)$$

Use `simplify` to take such properties into account:

```
simplify(cos(n*PI)),  
simplify(cos((n + 1/2)*PI))
```

$$(-1)^n, 0$$

```
assume(n, Type::Even):  
cos(n*PI + x), simplify(cos(n*PI + x))
```

$$\cos(x + \pi n), \cos(x)$$

```
y := cos(x + n*PI) + cos(x - n*PI);  
simplify(y)
```

$$\cos(x + \pi n) + \cos(x - \pi n)$$

$$2 \cos(x)$$

```
delete n, y
```

## Example 5

Use `rewrite` to obtain a representation in terms of a specific target function:

```
rewrite(cos(x)*exp(2*I*x), exp);  
rewrite(cos(x), tan)
```

$$e^{2xi} \left( \frac{e^{-xi}}{2} + \frac{e^{xi}}{2} \right)$$

$$-\frac{\tan\left(\frac{x}{2}\right)^2 - 1}{\tan\left(\frac{x}{2}\right)^2 + 1}$$

## Example 6

The inverse function is implemented as `arccos`:

```
cos(arccos(x)),
arccos(cos(x))
```

```
x, arccos(cos(x))
```

Note that `arccos(cos(x))` does not necessarily yield `x` because `arccos` produces values with real parts in the interval  $[0, \pi]$ :

```
arccos(cos(4)), arccos(cos(3.2 + I))
```

```
2 π - 4, 3.083185307 - 1.0 i
```

## Example 7

`diff`, `float`, `limit`, `taylor` and other system functions handle expressions involving the trigonometric functions:

```
diff(cos(x^2), x), float(cos(3)*tan(5 + I))
```

```
-2 x sin(x^2), 0.1842469864 - 1.228331193 i
```

```
limit((1 - cos(x))/x^2, x = 0)
```

```
 $\frac{1}{2}$ 
```

```
taylor(cos(x), x = 0)
```

$$1 - \frac{x^2}{2} + \frac{x^4}{24} + O(x^6)$$

## Parameters

x

An arithmetical expression (Symbolic Math Toolbox) or a floating-point interval on page 7-33

## Return Values

Arithmetical expression or a floating-point interval

## Overloaded By

x

## See Also

### MuPAD Functions

arccos | arccot | arccsc | arcsec | arcsin | arctan | cot | csc | sec | sin | tan

# tan

Tangent function

## Syntax

`tan(x)`

## Description

`tan(x)` represents the tangent function  $\sin(x)/\cos(x)$ .

Specify the argument  $x$  in radians, not in degrees. For example, use  $\pi$  to specify an angle of  $180^\circ$ .

All trigonometric functions are defined for complex arguments.

Floating-point values are returned for floating-point arguments. Floating-point intervals are returned for floating-point interval arguments. Unevaluated function calls are returned for most exact arguments.

Translations by integer multiples of  $\pi$  are eliminated from the argument. Further, arguments that are rational multiples of  $\pi$  lead to simplified results; symmetry relations are used to rewrite the result using an argument from the standard interval  $[0, \frac{\pi}{2})$ . Explicit expressions are returned for the following arguments:

$$0, \frac{\pi}{2}, \frac{\pi}{3}, \frac{\pi}{4}, \frac{\pi}{5}, \frac{2\pi}{5}, \frac{\pi}{6}, \frac{\pi}{8}, \frac{3\pi}{8}, \frac{\pi}{10}, \frac{3\pi}{10}, \frac{\pi}{12}, \frac{5\pi}{12}$$

See "Example 2" on page 1-1917 (Symbolic Math Toolbox).

The result is rewritten in terms of hyperbolic functions on page 1-1945, if the argument is a rational multiple of  $i$ . See "Example 3" on page 1-1918 (Symbolic Math Toolbox).

The functions `expand` and `combine` implement the addition theorems for the trigonometric functions. See "Example 4" on page 1-1918 (Symbolic Math Toolbox).

The trigonometric functions do not respond to properties set via `assume`. Use `simplify` to take such properties into account. See “Example 4” on page 1-1918 (Symbolic Math Toolbox).

Use `rewrite` to rewrite expressions in terms of a specific target function. For example, you can rewrite expressions involving the tangent function in terms of other trigonometric functions and vice versa. See “Example 5” on page 1-1919 (Symbolic Math Toolbox).

The inverse function is implemented as `arctan`. See “Example 6” on page 1-1920 (Symbolic Math Toolbox).

The float attributes are kernel functions, thus, floating-point evaluation is fast.

## Environment Interactions

When called with a floating-point argument, the functions are sensitive to the environment variable `DIGITS` which determines the numerical working precision.

## Examples

### Example 1

Call `tan` with the following exact and symbolic input arguments:

`tan(0)`, `tan(1)`, `tan(5 + I)`, `tan(PI)`, `tan(PI/11)`, `tan(PI/8)`

`0`, `tan(1)`, `tan(5 + i)`, `0`, `tan( $\frac{\pi}{11}$ )`,  `$\sqrt{2} - 1$`

`tan(-x)`, `tan(x + PI)`, `tan(x^2 - 4)`

`$-\tan(x)$` ,  `$\tan(x)$` ,  `$\tan(x^2 - 4)$`

Floating-point values are computed for floating-point arguments:

`tan(123.4)`, `tan(5.6 + 7.8*I)`, `tan(1.0/10^20)`

$$1.204471257, -0.0000003287740833 + 0.9999999318 i, 1.0 \cdot 10^{-20}$$

Floating-point intervals are computed for interval arguments:

$$\tan(0 \dots 1), \tan(-1/2 \dots 1/2), \tan(0 \dots 5)$$

$$0.0 \dots 1.557407725, -0.5463024899 \dots 0.5463024899, \text{RD\_NINF} \dots \text{RD\_INF}$$

For intervals containing discontinuities, the result is a union of intervals:

$$\tan(1 \dots 2);$$

$$\tan(-\pi/2 \dots 0)$$

$$\text{RD\_NINF} \dots -2.185039863 \cup 1.557407724 \dots \text{RD\_INF}$$

$$\text{RD\_NINF} \dots 1.387778781 \cdot 10^{-17} \cup 1.747888503 \cdot 10^{17} \dots \text{RD\_INF}$$

## Example 2

Some special values are implemented:

$$\tan(\pi/10), \tan(2\pi/5), \tan(123/8\pi), \tan(-\pi/12)$$

$$\frac{\sqrt{5} \sqrt{5-2\sqrt{5}}}{5}, \frac{\sqrt{2} \sqrt{5+10} (\sqrt{5}+1)}{4}, \sqrt{2}+1, \sqrt{3}-2$$

Translations by integer multiples of  $\pi$  are eliminated from the argument:

$$\tan(x + 10\pi), \tan(3 - \pi), \tan(x + \pi), \tan(2 - 10^{100}\pi)$$

$$\tan(x), \tan(3), \tan(x), \tan(2)$$

All arguments that are rational multiples of  $\pi$  are transformed to arguments from the interval  $[0, \frac{\pi}{2})$ :

`tan(4/7*PI), tan(-20*PI/9), tan(123/11*PI), tan(-PI/13)`

$$-\tan\left(\frac{3\pi}{7}\right), -\tan\left(\frac{2\pi}{9}\right), \tan\left(\frac{2\pi}{11}\right), -\tan\left(\frac{\pi}{13}\right)$$

### Example 3

Arguments that are rational multiples of I are rewritten in terms of hyperbolic functions on page 1-1945:

`tan(5*I), tan(5/4*I), tan(-3*I)`

$$\tanh(5) i, \tanh\left(\frac{5}{4}\right) i, -\tanh(3) i$$

For other complex arguments, use `expand` to rewrite the result:

`tan(5*I + 2*PI/3), tan(PI/4 - 5/4*I), tan(-3*I + PI/2)`

$$\tan\left(\frac{2\pi}{3} + 5i\right), \tan\left(\frac{\pi}{4} - \frac{5i}{4}\right), \tan\left(\frac{\pi}{2} - 3i\right)$$

`expand(tan(5*I + 2*PI/3)),`  
`expand(tan(5/4*I - PI/4)),`  
`expand(tan(-3*I + PI/2))`

$$\frac{-\sqrt{3} + \tanh(5) i}{1 + \sqrt{3} \tanh(5) i}, \frac{\tanh\left(\frac{5}{4}\right) i}{1 + \tanh\left(\frac{5}{4}\right) i} - \frac{1}{1 + \tanh\left(\frac{5}{4}\right) i}, -\frac{i}{\tanh(3)}$$

### Example 4

The `expand` function implements the addition theorems:

`expand(tan(x + PI/2)), expand(tan(x + y))`

$$-\frac{1}{\tan(x)}, -\frac{\tan(x) + \tan(y)}{\tan(x) \tan(y) - 1}$$



The trigonometric functions do not immediately respond to properties set via `assume`:

```
assume(n, Type::Integer):
tan(n*PI)
```

$$\tan(\pi n)$$

Use `simplify` to take such properties into account:

```
simplify(tan(n*PI))
```

$$0$$

```
assume(n, Type::Integer):
tan(n*PI + x), simplify(tan(n*PI + x))
```

$$\tan(x + \pi n), \tan(x)$$

```
y := tan(x + n*PI) + tan(x - n*PI);
simplify(y)
```

$$\tan(x + \pi n) + \tan(x - \pi n)$$

$$2 \tan(x)$$

```
delete n, y
```

## Example 5

Use `rewrite` to obtain a representation in terms of a specific target function:

```
rewrite(tan(x)*exp(2*I*x), sincos);
rewrite(cos(x), tan)
```

$$\frac{\sin(x) (\cos(2x) + \sin(2x) i)}{\cos(x)}$$

$$-\frac{\tan\left(\frac{x}{2}\right)^2 - 1}{\tan\left(\frac{x}{2}\right)^2 + 1}$$

### Example 6

The inverse function is implemented as `arctan`:

```
tan(arctan(x)),
arctan(tan(x))
```

```
x, arctan(tan(x))
```

Note that `arctan(tan(x))` does not necessarily yield `x` because `arctan` produces

values with real parts in the interval  $\left[-\frac{\pi}{2}, \frac{\pi}{2}\right]$ :

```
arctan(tan(3)), arctan(tan(1.6 + I))
```

```
3 - pi, -1.541592654 + 1.0 i
```

### Example 7

`diff`, `float`, `limit`, `taylor` and other system functions handle expressions involving the trigonometric functions:

```
diff(tan(x), x), float(tan(3)*cos(5 + I))
```

```
tan(x)^2 + 1, -0.06239456413 - 0.1606398264 i
```

```
limit(x*sin(x)/tan(x^2), x = 0)
```

```
1
```

```
taylor(tan(x), x = 0)
```

$$x + \frac{x^3}{3} + \frac{2x^5}{15} + O(x^7)$$

## Parameters

**x**

An arithmetical expression (Symbolic Math Toolbox) or a floating-point interval on page 7-33

## Return Values

Arithmetical expression or a floating-point interval

## Overloaded By

**x**

## See Also

### **MuPAD Functions**

arccos | arccot | arccsc | arcsec | arcsin | arctan | cos | cot | csc | sec | sin

## CSC

Cosecant function

## Syntax

`csc(x)`

## Description

`csc(x)` represents the cosecant function  $1/\sin(x)$ .

Specify the argument  $x$  in radians, not in degrees. For example, use  $\pi$  to specify an angle of  $180^\circ$ .

All trigonometric functions are defined for complex arguments.

Floating-point values are returned for floating-point arguments. Floating-point intervals are returned for floating-point interval arguments. Unevaluated function calls are returned for most exact arguments.

Translations by integer multiples of  $\pi$  are eliminated from the argument. Further, arguments that are rational multiples of  $\pi$  lead to simplified results; symmetry relations are used to rewrite the result using an argument from the standard interval  $[0, \frac{\pi}{2})$ . Explicit expressions are returned for the following arguments:

$$0, \frac{\pi}{2}, \frac{\pi}{3}, \frac{\pi}{4}, \frac{\pi}{5}, \frac{2\pi}{5}, \frac{\pi}{6}, \frac{\pi}{8}, \frac{3\pi}{8}, \frac{\pi}{10}, \frac{3\pi}{10}, \frac{\pi}{12}, \frac{5\pi}{12}$$

See “Example 2” on page 1-1924 (Symbolic Math Toolbox).

The result is rewritten in terms of hyperbolic functions on page 1-1945, if the argument is a rational multiple of  $\pi$ . See “Example 3” on page 1-1925 (Symbolic Math Toolbox).

The functions `expand` and `combine` implement the addition theorems for the trigonometric functions. See “Example 4” on page 1-1925 (Symbolic Math Toolbox).

The trigonometric functions do not respond to properties set via `assume`. Use `simplify` to take such properties into account. See “Example 4” on page 1-1925 (Symbolic Math Toolbox).

`csc(x)` is immediately rewritten as  $1/\sin(x)$ . To rewrite the cosecant function in terms of other target functions, use `rewrite`. For example, you can rewrite expressions involving the cosecant function in terms of other trigonometric functions and vice versa. See “Example 5” on page 1-1927 (Symbolic Math Toolbox).

The inverse function is implemented by `arccsc`. See “Example 6” on page 1-1927 (Symbolic Math Toolbox).

The float attributes are kernel functions, thus, floating-point evaluation is fast.

## Environment Interactions

When called with a floating-point argument, the functions are sensitive to the environment variable `DIGITS` which determines the numerical working precision.

## Examples

### Example 1

Call `csc` with the following exact and symbolic input arguments. The cosecant function is rewritten in terms of the sine function.

`csc(-PI/2)`, `csc(1)`, `csc(5 + I)`, `csc(PI/2)`, `csc(PI/11)`, `csc(PI/8)`

$$-1, \frac{1}{\sin(1)}, \frac{1}{\sin(5+i)}, 1, \frac{1}{\sin(\frac{\pi}{11})}, \frac{2}{\sqrt{2-\sqrt{2}}}$$

`csc(-x)`, `csc(x + PI)`, `csc(x^2 - 4)`

$$-\frac{1}{\sin(x)}, -\frac{1}{\sin(x)}, \frac{1}{\sin(x^2-4)}$$

Floating-point values are computed for floating-point arguments:

`csc(123.4), csc(5.6 + 7.8*I), csc(1.0/10^20)`

`-1.299730033, -0.0005173041673 - 0.0006355528745 i, 1.0 1020`

Floating-point intervals are computed for interval arguments:

`csc(-3...-1), csc(1/2...3/2), csc(PI/8...7*PI/8)`

`-7.086167396 ... -1.0, 1.002511304 ... 2.085829643, 1.0 ... 2.61312593`

For intervals containing discontinuities, the result is a union of intervals:

`csc(-1...1);  
csc(-PI...0)`

`RD_NINF ... -1.188395105 ∪ 1.188395105 ... RD_INF`

`RD_NINF ... -1.0 ∪ 1.44115188 1017 ... RD_INF`

## Example 2

Some special values are implemented:

`csc(PI/10), csc(2*PI/5), csc(123/8*PI), csc(-PI/12)`

$$\frac{1}{\frac{\sqrt{5}}{4} - \frac{1}{4}}, \frac{2\sqrt{2}}{\sqrt{\sqrt{5}+5}}, -\frac{2}{\sqrt{\sqrt{2}+2}}, \frac{1}{\frac{\sqrt{2}}{4} - \frac{\sqrt{6}}{4}}$$

Translations by integer multiples of  $\pi$  are eliminated from the argument:

`csc(x + 10*PI), csc(3 - PI), csc(x + PI), csc(2 - 10^100*PI)`

$$\frac{1}{\sin(x)}, -\frac{1}{\sin(3)}, -\frac{1}{\sin(x)}, \frac{1}{\sin(2)}$$

All arguments that are rational multiples of  $\pi$  are transformed to arguments from the interval  $[0, \frac{\pi}{2}]$ :

`csc(4/7*PI), csc(-20*PI/9), csc(123/11*PI), csc(-PI/13)`

$$\frac{1}{\sin\left(\frac{3\pi}{7}\right)}, -\frac{1}{\sin\left(\frac{2\pi}{9}\right)}, -\frac{1}{\sin\left(\frac{2\pi}{11}\right)}, -\frac{1}{\sin\left(\frac{\pi}{13}\right)}$$

### Example 3

Arguments that are rational multiples of  $I$  are rewritten in terms of hyperbolic functions on page 1-1945:

`csc(5*I), csc(5/4*I), csc(-3*I)`

$$-\frac{i}{\sinh(5)}, -\frac{i}{\sinh\left(\frac{5}{4}\right)}, \frac{i}{\sinh(3)}$$

For other complex arguments, use `expand` to rewrite the result:

`csc(5*I + 2*PI/3), csc(PI/4 - 5/4*I), csc(-3*I + PI/2)`

$$\frac{1}{\sin\left(\frac{2\pi}{3} + 5i\right)}, \frac{1}{\sin\left(\frac{\pi}{4} - \frac{5i}{4}\right)}, \frac{1}{\sin\left(\frac{\pi}{2} - 3i\right)}$$

`expand(csc(5*I + 2*PI/3)),`  
`expand(csc(5/4*I - PI/4)),`  
`expand(csc(-3*I + PI/2))`

$$-\frac{1}{-\frac{\sqrt{3}\cosh(5)}{2} + \frac{\sinh(5)i}{2}}, -\frac{1}{\frac{\sqrt{2}\cosh\left(\frac{5}{4}\right)}{2} - \frac{\sqrt{2}\sinh\left(\frac{5}{4}\right)i}{2}}, \frac{1}{\cosh(3)}$$

### Example 4

The `expand` function implements the addition theorems:

```
expand(csc(x + PI/2)), expand(csc(x + y))
```

$$\frac{1}{\cos(x)}, \frac{1}{\cos(x) \sin(y) + \cos(y) \sin(x)}$$

The `combine` function uses these theorems in the other direction, trying to rewrite products of trigonometric functions:

```
combine(1/(csc(x)*csc(y)), sincos)
```

$$\frac{\cos(x - y)}{2} - \frac{\cos(x + y)}{2}$$

The trigonometric functions do not immediately respond to properties set via `assume`:

```
assume(n, Type::Integer):
csc((n + 1/2)*PI)
```

$$\frac{1}{\sin(\pi (n + \frac{1}{2}))}$$

Use `simplify` to take such properties into account:

```
simplify(csc((n + 1/2)*PI))
```

$$(-1)^n$$

```
assume(n, Type::Even):
csc(n*PI + x), simplify(csc(n*PI + x))
```

$$\frac{1}{\sin(x + \pi n)}, \frac{1}{\sin(x)}$$

```
y := csc(x + n*PI) + csc(x - n*PI);
simplify(y)
```

$$\frac{1}{\sin(x + \pi n)} + \frac{1}{\sin(x - \pi n)}$$



$$\frac{2}{\sin(x)}$$

delete n, y

## Example 5

csc(x) is immediately rewritten as 1/sin(x):

csc(x)

$$\frac{1}{\sin(x)}$$

Use rewrite to obtain a representation in terms of a specific target function:

```
rewrite(csc(x)*exp(2*I*x), exp);
rewrite(csc(x), cot)
```

$$\frac{e^{2xi}}{\frac{e^{-xi}}{2} - \frac{e^{xi}}{2}}$$

$$\frac{\cot\left(\frac{x}{2}\right)^2 + 1}{2 \cot\left(\frac{x}{2}\right)}$$

## Example 6

The inverse function is implemented as arccsc:

```
csc(arccsc(x)),
arccsc(csc(x))
```

$x, \arcsin(\sin(x))$

Note that  $\text{arccsc}(\csc(x))$  is rewritten as  $\arcsin(\sin(x))$  and does not necessarily yield  $x$  because  $\arcsin$  produces values with real parts in the interval  $\left[-\frac{\pi}{2}, \frac{\pi}{2}\right]$ :

```
arccsc(csc(3)), arccsc(csc(1.6 + I))
```

$$\pi - 3, 1.541592654 - 1.0 i$$

## Example 7

`diff`, `float`, `limit`, `series` and other system functions handle expressions involving the trigonometric functions:

```
diff(csc(x), x), float(csc(3)*cot(5 + I))
```

$$-\frac{\cos(x)}{\sin(x)^2}, -0.8378180345 - 5.585535189 i$$

```
limit(1/(x*csc(x)), x = 0)
```

$$1$$

```
series(csc(x), x = 0)
```

$$\frac{1}{x} + \frac{x}{6} + \frac{7x^3}{360} + O(x^5)$$

## Parameters

**x**

An arithmetical expression (Symbolic Math Toolbox) or a floating-point interval on page 7-33

## Return Values

Arithmetical expression or a floating-point interval

## Overloaded By

x

## See Also

### **MuPAD Functions**

arccos | arccot | arccsc | arcsec | arcsin | arctan | cos | cot | sec | sin | tan

## sec

Secant function

## Syntax

`sec(x)`

## Description

`sec(x)` represents the secant function  $1/\cos(x)$ .

Specify the argument  $x$  in radians, not in degrees. For example, use  $\pi$  to specify an angle of  $180^\circ$ .

All trigonometric functions are defined for complex arguments.

Floating-point values are returned for floating-point arguments. Floating-point intervals are returned for floating-point interval arguments. Unevaluated function calls are returned for most exact arguments.

Translations by integer multiples of  $\pi$  are eliminated from the argument. Further, arguments that are rational multiples of  $\pi$  lead to simplified results; symmetry relations are used to rewrite the result using an argument from the standard interval  $[0, \frac{\pi}{2})$ . Explicit expressions are returned for the following arguments:

$$0, \frac{\pi}{2}, \frac{\pi}{3}, \frac{\pi}{4}, \frac{\pi}{5}, \frac{2\pi}{5}, \frac{\pi}{6}, \frac{\pi}{8}, \frac{3\pi}{8}, \frac{\pi}{10}, \frac{3\pi}{10}, \frac{\pi}{12}, \frac{5\pi}{12}$$

See “Example 2” on page 1-1932 (Symbolic Math Toolbox).

The result is rewritten in terms of hyperbolic functions on page 1-1945, if the argument is a rational multiple of  $\pi$ . See “Example 3” on page 1-1933 (Symbolic Math Toolbox).

The functions `expand` and `combine` implement the addition theorems for the trigonometric functions. See “Example 4” on page 1-1933 (Symbolic Math Toolbox).

The trigonometric functions do not respond to properties set via `assume`. Use `simplify` to take such properties into account. See “Example 4” on page 1-1933 (Symbolic Math Toolbox).

`sec(x)` is immediately rewritten as  $1/\cos(x)$ . To rewrite the secant function in terms of other target functions, use `rewrite`. For example, you can rewrite expressions involving the secant function in terms of other trigonometric functions and vice versa. See “Example 5” on page 1-1935 (Symbolic Math Toolbox).

The inverse function is implemented as `arcsec`. See “Example 6” on page 1-1935 (Symbolic Math Toolbox).

The float attributes are kernel functions, thus, floating-point evaluation is fast.

## Environment Interactions

When called with a floating-point argument, the functions are sensitive to the environment variable `DIGITS` which determines the numerical working precision.

## Examples

### Example 1

Call `sec` with the following exact and symbolic input arguments. The secant function is rewritten in terms of the cosine function.

`sec(0)`, `sec(1)`, `sec(5 + I)`, `sec(PI)`, `sec(PI/11)`, `sec(PI/8)`

$$1, \frac{1}{\cos(1)}, \frac{1}{\cos(5+i)}, -1, \frac{1}{\cos(\frac{\pi}{11})}, \frac{2}{\sqrt{\sqrt{2}+2}}$$

`sec(-x)`, `sec(x + PI)`, `sec(x^2 - 4)`

$$\frac{1}{\cos(x)}, -\frac{1}{\cos(x)}, \frac{1}{\cos(x^2-4)}$$

Floating-point values are computed for floating-point arguments:

`sec(123.4), sec(5.6 + 7.8*I), sec(1.0/10^20)`

`-1.565487467, 0.0006355530012 - 0.0005173039231 i, 1.0`

Floating-point intervals are computed for interval arguments:

`sec(-1...1), sec(-4...-2), sec(3*PI/4...5*PI/4)`

`1.0 ... 1.850815718, -2.402997962 ... -1.0, -1.414213563 ... -1.0`

For intervals containing discontinuities, the result is a union of intervals:

`sec(-3*PI/2...3*PI/2);  
sec(-PI/2...0)`

`RD_NINF ... -1.0 ∪ 1.0 ... RD_INF`

`-RD_INF...-1.74788503e17 union 1.0 ...RD_INF`

## Example 2

Some special values are implemented:

`sec(PI/10), sec(2*PI/5), sec(123/8*PI), sec(-PI/12)`

$$\frac{2\sqrt{2}}{\sqrt{\sqrt{5}+5}}, \frac{1}{\frac{\sqrt{5}}{4}-\frac{1}{4}}, -\frac{2}{\sqrt{2}-\sqrt{2}}, \frac{1}{\frac{\sqrt{2}}{4}+\frac{\sqrt{6}}{4}}$$

Translations by integer multiples of  $\pi$  are eliminated from the argument:

`sec(x + 10*PI), sec(3 - PI), sec(x + PI), sec(2 - 10^100*PI)`

$$\frac{1}{\cos(x)}, -\frac{1}{\cos(3)}, -\frac{1}{\cos(x)}, \frac{1}{\cos(2)}$$

All arguments that are rational multiples of  $\pi$  are transformed to arguments from the interval  $[0, \frac{\pi}{2})$ :

$\sec(4/7*\text{PI}), \sec(-20*\text{PI}/9), \sec(123/11*\text{PI}), \sec(-\text{PI}/13)$

$$-\frac{1}{\cos\left(\frac{3\pi}{7}\right)}, \frac{1}{\cos\left(\frac{2\pi}{9}\right)}, -\frac{1}{\cos\left(\frac{2\pi}{11}\right)}, \frac{1}{\cos\left(\frac{\pi}{13}\right)}$$

### Example 3

Arguments that are rational multiples of I are rewritten in terms of hyperbolic functions on page 1-1945:

$\sec(5*I), \sec(5/4*I), \sec(-3*I)$

$$\frac{1}{\cosh(5)}, \frac{1}{\cosh\left(\frac{5}{4}\right)}, \frac{1}{\cosh(3)}$$

For other complex arguments, use `expand` to rewrite the result:

$\sec(5*I + 2*\text{PI}/3), \sec(\text{PI}/4 - 5/4*I), \sec(-3*I + \text{PI}/2)$

$$\frac{1}{\cos\left(\frac{2\pi}{3} + 5i\right)}, \frac{1}{\cos\left(\frac{\pi}{4} - \frac{5i}{4}\right)}, \frac{1}{\cos\left(\frac{\pi}{2} - 3i\right)}$$

`expand(sec(5*I + 2*PI/3)),`  
`expand(sec(5/4*I - PI/4)),`  
`expand(sec(-3*I + PI/2))`

$$-\frac{1}{\frac{\cosh(5)}{2} + \frac{\sqrt{3}\sinh(5)i}{2}}, \frac{1}{\frac{\sqrt{2}\cosh\left(\frac{5}{4}\right)}{2} + \frac{\sqrt{2}\sinh\left(\frac{5}{4}\right)i}{2}}, -\frac{i}{\sinh(3)}$$

### Example 4

The `expand` function implements the addition theorems:

`expand(sec(x + PI/2)), expand(sec(x + y))`

$$-\frac{1}{\sin(x)}, \frac{1}{\cos(x)\cos(y) - \sin(x)\sin(y)}$$

The `combine` function uses these theorems in the other direction, trying to rewrite products of trigonometric functions:

```
combine(1/(sec(x)*sec(y)), sincos)
```

$$\frac{\cos(x - y)}{2} + \frac{\cos(x + y)}{2}$$

The trigonometric functions do not immediately respond to properties set via `assume`:

```
assume(n, Type::Integer):
sec(n*PI)
```

$$\frac{1}{\cos(\pi n)}$$

Use `simplify` to take such properties into account:

```
simplify(sec(n*PI))
```

$$(-1)^n$$

```
assume(n, Type::Even):
sec(n*PI + x), simplify(sec(n*PI + x))
```

$$\frac{1}{\cos(x + \pi n)}, \frac{1}{\cos(x)}$$

```
y := sec(x + n*PI) + sec(x - n*PI);
simplify(y)
```

$$\frac{1}{\cos(x + \pi n)} + \frac{1}{\cos(x - \pi n)}$$



$$\frac{2}{\cos(x)}$$

delete n, y

### Example 5

sec(x) is immediately rewritten as 1/cos(x):

sec(x)

$$\frac{1}{\cos(x)}$$

Use rewrite to obtain a representation in terms of a specific target function:

```
rewrite(sec(x)*exp(2*I*x), exp);
rewrite(sec(x), tan)
```

$$\frac{e^{2xi}}{\frac{e^{-xi}}{2} + \frac{e^{xi}}{2}}$$

$$-\frac{\tan\left(\frac{x}{2}\right)^2 + 1}{\tan\left(\frac{x}{2}\right)^2 - 1}$$

### Example 6

The inverse functions is implemented as arcsec:

```
sec(arcsec(x)),
arcsec(sec(x))
```

```
x, arccos(cos(x))
```

Note that  $\text{arcsec}(\sec(x))$  is rewritten as  $\arccos(\cos(x))$  and does not necessarily yield  $x$  because  $\arccos$  produces values with real parts in the interval  $[0, \pi]$ :

```
arcsec(sec(4)), arcsec(sec(3.2 + I))
```

```
2 π - 4, 3.083185307 - 1.0 i
```

## Example 7

`diff`, `float`, `limit`, `taylor` and other system functions handle expressions involving the trigonometric functions:

```
diff(sec(x), x), float(sec(3)*csc(5 + I))
```

```
 $\frac{\sin(x)}{\cos(x)^2}, 0.6496711338 + 0.146364012 i$ 
```

```
limit((1 - 1/sec(x))/x^2, x = 0)
```

```
 $\frac{1}{2}$ 
```

```
taylor(sec(x), x = 0)
```

```
 $1 + \frac{x^2}{2} + \frac{5x^4}{24} + O(x^6)$ 
```

## Parameters

**x**

An arithmetical expression (Symbolic Math Toolbox) or a floating-point interval on page 7-33

## Return Values

Arithmetical expression or a floating-point interval

## Overloaded By

x

## See Also

### **MuPAD Functions**

arccos | arccot | arccsc | arcsec | arcsin | arctan | cos | cot | csc | sin | tan

# cot

Cotangent function

## Syntax

`cot(x)`

## Description

`cot(x)` represents the cotangent function  $\cos(x)/\sin(x)$ .

Specify the argument  $x$  in radians, not in degrees. For example, use  $\pi$  to specify an angle of  $180^\circ$ .

All trigonometric functions are defined for complex arguments.

Floating-point values are returned for floating-point arguments. Floating-point intervals are returned for floating-point interval arguments. Unevaluated function calls are returned for most exact arguments.

Translations by integer multiples of  $\pi$  are eliminated from the argument. Further, arguments that are rational multiples of  $\pi$  lead to simplified results; symmetry relations are used to rewrite the result using an argument from the standard interval  $[0, \frac{\pi}{2})$ . Explicit expressions are returned for the following arguments:

$$0, \frac{\pi}{2}, \frac{\pi}{3}, \frac{\pi}{4}, \frac{\pi}{5}, \frac{2\pi}{5}, \frac{\pi}{6}, \frac{\pi}{8}, \frac{3\pi}{8}, \frac{\pi}{10}, \frac{3\pi}{10}, \frac{\pi}{12}, \frac{5\pi}{12}$$

See “Example 2” on page 1-1940 (Symbolic Math Toolbox).

The result is rewritten in terms of hyperbolic functions on page 1-1945, if the argument is a rational multiple of  $\pi$ . See “Example 3” on page 1-1941 (Symbolic Math Toolbox).

The functions `expand` and `combine` implement the addition theorems for the trigonometric functions. See “Example 4” on page 1-1941 (Symbolic Math Toolbox).

The trigonometric functions do not respond to properties set via `assume`. Use `simplify` to take such properties into account. See “Example 4” on page 1-1941 (Symbolic Math Toolbox).

Use `rewrite` to rewrite expressions in terms of a specific target function. For example, you can rewrite expressions involving the cotangent function in terms of other trigonometric functions and vice versa. See “Example 5” on page 1-1942 (Symbolic Math Toolbox).

The inverse function is implemented as `arccot`. See “Example 6” on page 1-1943 (Symbolic Math Toolbox).

The float attributes are kernel functions, thus, floating-point evaluation is fast.

## Environment Interactions

When called with a floating-point argument, the functions are sensitive to the environment variable `DIGITS` which determines the numerical working precision.

## Examples

### Example 1

Call `cot` with the following exact and symbolic input arguments:

```
cot(PI/2), cot(1), cot(5 + I), cot(3*PI/2), cot(PI/11), cot(PI/8)
```

$$0, \cot(1), \cot(5 + i), 0, \cot\left(\frac{\pi}{11}\right), \sqrt{2} + 1$$

```
cot(-x), cot(x + PI), cot(x^2 - 4)
```

$$-\cot(x), \cot(x), \cot(x^2 - 4)$$

Floating-point values are computed for floating-point arguments:

```
cot(123.4), cot(5.6 + 7.8*I), cot(1.0/10^20)
```

0.8302398206, -0.0000003287741281 - 1.000000068 i, 1.0 10<sup>20</sup>

Floating-point intervals are computed for interval arguments:

`ccot(1...2), cot(PI/4...3*PI/4), cot(0...PI)`

`ccot(1.0 ... 2.0), -1.000000001 ... 1.000000001, RD_NINF ... RD_INF`

For intervals containing discontinuities, the result is a union of intervals:

`cot(2...4);  
cot(-PI...-5/2)`

`RD_NINF ... -0.4576575543 ∪ 0.5498750851 ... RD_INF`

`RD_NINF ... -1.154569628 1017 ∪ 1.338648128 ... RD_INF`

## Example 2

Some special values are implemented:

`cot(PI/10), cot(2*PI/5), cot(123/8*PI), cot(-PI/12)`

$\sqrt{2} \sqrt{5+5}, \frac{\sqrt{5} \sqrt{5-2} \sqrt{5}}{5}, \sqrt{2}-1, -\sqrt{3}-2$

Translations by integer multiples of  $\pi$  are eliminated from the argument:

`cot(x + 10*PI), cot(3 - PI), cot(x + PI), cot(2 - 10^100*PI)`

`cot(x), cot(3), cot(x), cot(2)`

All arguments that are rational multiples of  $\pi$  are transformed to arguments from the interval  $[0, \frac{\pi}{2})$ :

`cot(4/7*PI), cot(-20*PI/9), cot(123/11*PI), cot(-PI/13)`

$$-\cot\left(\frac{3\pi}{7}\right), -\cot\left(\frac{2\pi}{9}\right), \cot\left(\frac{2\pi}{11}\right), -\cot\left(\frac{\pi}{13}\right)$$

### Example 3

Arguments that are rational multiples of I are rewritten in terms of hyperbolic functions on page 1-1945:

`cot(5*I), cot(5/4*I), cot(-3*I)`

$$-\coth(5) i, -\coth\left(\frac{5}{4}\right) i, \coth(3) i$$

For other complex arguments, use `expand` to rewrite the result:

`cot(5*I + 2*PI/3), cot(PI/4 - 5/4*I), cot(-3*I + PI/2)`

$$\cot\left(\frac{2\pi}{3} + 5i\right), \cot\left(\frac{\pi}{4} - \frac{5i}{4}\right), \cot\left(\frac{\pi}{2} - 3i\right)$$

`expand(cot(5*I + 2*PI/3)),`  
`expand(cot(5/4*I - PI/4)),`  
`expand(cot(-3*I + PI/2))`

$$-\frac{-1 + \frac{\sqrt{3}\coth(5)i}{3}}{\frac{\sqrt{3}}{3} + \coth(5)i}, -\frac{\coth\left(\frac{5}{4}\right)i}{1 + \coth\left(\frac{5}{4}\right)i} + \frac{1}{1 + \coth\left(\frac{5}{4}\right)i}, \frac{i}{\coth(3)}$$

### Example 4

The `expand` function implements the addition theorems:

`expand(cot(x + PI/2)), expand(cot(x + y))`

$$-\frac{1}{\cot(x)}, \frac{\cot(x)\cot(y) - 1}{\cot(x) + \cot(y)}$$

The trigonometric functions do not immediately respond to properties set via `assume`:

```
assume(n, Type::Integer):  
cot((n + 1/2)*PI)
```

$$\cot\left(\pi\left(n + \frac{1}{2}\right)\right)$$

Use `simplify` to take such properties into account:

```
simplify(cot((n + 1/2)*PI))
```

0

```
assume(n, Type::Integer):  
cot(n*PI + x), simplify(cot(n*PI + x))
```

$\cot(x + \pi n), \cot(x)$

```
y := cot(x + n*PI) + cot(x - n*PI);  
simplify(y)
```

$\cot(x + \pi n) + \cot(x - \pi n)$

$2 \cot(x)$

```
delete n, y
```

## Example 5

Use `rewrite` to obtain a representation in terms of a specific target function:

```
rewrite(cot(x)*exp(2*I*x), sincos), rewrite(sin(x), cot)
```

$$\frac{\cos(x) (\cos(2x) + \sin(2x) i)}{\sin(x)}, \frac{2 \cot\left(\frac{x}{2}\right)}{\cot\left(\frac{x}{2}\right)^2 + 1}$$



## Example 6

The inverse function is implemented as `asrccot`:

```
cot(arccot(x)),
arccot(cot(x))
```

```
x, arccot(cot(x))
```

Note that `arccot(cot(x))` does not necessarily yield `x` because `arccot` produces values with real parts in the interval  $[0, \pi]$ :

```
arccot(cot(4)), arccot(cot(3.2 + I))
```

```
4 - pi, 0.05840734641 + 1.0 i
```

## Example 7

`diff`, `float`, `limit`, `taylor` and other system functions handle expressions involving the trigonometric functions:

```
diff(cot(x), x), float(sin(3)*cot(5 + I))
```

```
-cot(x)2 - 1, -0.01668502608 - 0.1112351327 i
```

```
limit(cot(PI/2 - x)/x, x = 0)
```

```
1
```

```
taylor(tan(x), x = 0)
```

```
x + x3/3 + 2x5/15 + O(x7)
```

## Parameters

**x**

An arithmetical expression (Symbolic Math Toolbox) or a floating-point interval on page 7-33

## Return Values

Arithmetical expression or a floating-point interval

## Overloaded By

**x**

## See Also

### **MuPAD Functions**

`arccos` | `arccot` | `arccsc` | `arcsec` | `arcsin` | `arctan` | `cos` | `csc` | `sec` | `sin` | `tan`

# sinh

Hyperbolic sine function

## Syntax

`sinh(x)`

## Description

`sinh(x)` represents the hyperbolic sine function. This function is defined for complex arguments.

Floating-point values are returned for floating-point arguments. Floating-point intervals are returned for floating-point interval arguments. Unevaluated function calls are returned for most exact arguments.

Arguments that are integer multiples of  $\frac{i\pi}{2}$  lead to simplified results. If the argument involves a negative numerical factor of `Type::Real`, then symmetry relations are used to make this factor positive. See “Example 2” on page 1-1946 (Symbolic Math Toolbox).

The special values  $\sinh(0) = 0$ ,  $\sinh(\infty) = \infty$ , and  $\sinh(-\infty) = -\infty$  are implemented.

The functions `expand` and `combine` implement the addition theorems for the hyperbolic functions. See “Example 3” on page 1-1947 (Symbolic Math Toolbox).

You can rewrite other hyperbolic functions in terms of `sinh` and `cosh`. For example, `csch(x)` is rewritten as  $1/\sinh(x)$ . Use `expand` or `rewrite` to rewrite expressions involving `tanh` and `coth` in terms of `sinh` and `cosh`. See “Example 4” on page 1-1948 (Symbolic Math Toolbox).

The inverse function is implemented by `arcsinh`. See “Example 5” on page 1-1948 (Symbolic Math Toolbox).

The float attributes are kernel functions, thus, floating-point evaluation is fast.

## Environment Interactions

When called with a floating-point argument, the functions are sensitive to the environment variable DIGITS which determines the numerical working precision.

## Examples

### Example 1

Call `sinh` with the following exact and symbolic input arguments:

`sinh(I*PI), sinh(1), sinh(5 + I), sinh(PI), sinh(1/11), sinh(8)`

`0, sinh(1), sinh(5 + i), sinh(π), sinh( $\frac{1}{11}$ ), sinh(8)`

`sinh(x), sinh(x + I*PI), sinh(x^2 - 4)`

`sinh(x), -sinh(x), sinh(x2 - 4)`

Floating-point values are computed for floating-point arguments:

`sinh(1.234), sinh(5.6 + 7.8*I), sinh(1.0/10^20)`

`1.571908059, 7.295385512 + 135.018091 i, 1.0 10-20`

Floating-point intervals are computed for interval arguments:

`sinh(-1...1), sinh(0...1/2)`

`-1.175201194 ... 1.175201194, 0.0 ... 0.5210953055`

### Example 2

Simplifications are implemented for arguments that are integer multiples of  $\frac{i\pi}{2}$ :

```
assume(n in Z_)
```

```
simplify(sinh(n*I*PI))
```

$$0$$

```
simplify(sinh((n - 1/2)*I*PI))
```

$$(-1)^{n-\frac{1}{2}}$$

```
delete n
```

Negative real numerical factors in the argument are rewritten via symmetry relations:

```
sinh(-5), sinh(-3/2*x), sinh(-x*PI/12), sinh(-12/17*x*y*PI)
```

$$-\sinh(5), -\sinh\left(\frac{3x}{2}\right), -\sinh\left(\frac{\pi x}{12}\right), -\sinh\left(\frac{12\pi xy}{17}\right)$$

### Example 3

The `expand` function implements the addition theorems:

```
expand(sinh(x + PI*I)), expand(sinh(x + y))
```

$$-\sinh(x), \cosh(x) \sinh(y) + \cosh(y) \sinh(x)$$

The `combine` function uses these theorems in the other direction, trying to rewrite products of hyperbolic functions:

```
combine(sinh(x)*sinh(y), sinhcosh)
```

$$\frac{\cosh(x+y)}{2} - \frac{\cosh(x-y)}{2}$$

## Example 4

Use `rewrite` to obtain a representation in terms of a specific target function:

```
rewrite(sinh(x)*exp(2*x), sinhcosh);  
rewrite(sinh(x), tanh)
```

$$\sinh(x) (\cosh(2x) + \sinh(2x))$$

$$-\frac{2 \tanh\left(\frac{x}{2}\right)}{\tanh\left(\frac{x}{2}\right)^2 - 1}$$

```
rewrite(sinh(x)*coth(y), exp);  
rewrite(exp(x), sinhcosh)
```

$$-\frac{\left(\frac{e^{-x}}{2} - \frac{e^x}{2}\right) (e^{2y} + 1)}{e^{2y} - 1}$$

$$\cosh(x) + \sinh(x)$$

## Example 5

The inverse function is implemented as `arcsinh`:

```
sinh(arcsinh(x)),  
arcsinh(sinh(x))
```

$$x, \operatorname{arcsinh}(\sinh(x))$$

Note that `arcsinh(sinh(x))` does not necessarily yield `x` because `arcsinh` produces

values with imaginary parts in the interval  $\left[-\frac{\pi}{2}, \frac{\pi}{2}\right]$ :

```
arcsinh(sinh(3)), arcsinh(sinh(1.6 + 100*I))
```

3, 1.6 – 0.5309649149 i

## Example 6

diff, float, limit, taylor, series and other system functions handle expressions involving the hyperbolic functions:

```
diff(sinh(x^2), x), float(sinh(3)*coth(5 + I))
```

$2 x \cosh(x^2)$ , 10.01749636 – 0.0008270853591 i

```
limit(x*sinh(x)/tanh(x^2), x = 0)
```

1

```
taylor(sinh(x), x = 0)
```

$x + \frac{x^3}{6} + \frac{x^5}{120} + O(x^7)$

```
series((tanh(sinh(x)) - sinh(tanh(x)))/sinh(x^7), x = 0)
```

$-\frac{1}{30} + \frac{29 x^2}{756} - \frac{1913 x^4}{75600} + O(x^6)$

## Parameters

**x**

An arithmetical expression (Symbolic Math Toolbox) or a floating-point interval on page 7-33

## **Return Values**

Arithmetical expression or a floating-point interval

## **Overloaded By**

x

## **See Also**

### **MuPAD Functions**

arccosh | arccoth | arccsch | arcsech | arcsinh | arctanh | cosh | coth | csch |  
sech | tanh



# cosh

Hyperbolic cosine function

## Syntax

`cosh(x)`

## Description

`cosh(x)` represents the hyperbolic cosine function. This function is defined for complex arguments.

Floating-point values are returned for floating-point arguments. Floating-point intervals are returned for floating-point interval arguments. Unevaluated function calls are returned for most exact arguments.

Arguments that are integer multiples of  $\frac{i\pi}{2}$  lead to simplified results. If the argument involves a negative numerical factor of `Type::Real`, then symmetry relations are used to make this factor positive. See “Example 2” on page 1-1952 (Symbolic Math Toolbox).

The special values  $\cosh(0) = 1$ ,  $\cosh(\infty) = \infty$ , and  $\cosh(-\infty) = \infty$  are implemented.

The functions `expand` and `combine` implement the addition theorems for the hyperbolic functions. See “Example 3” on page 1-1953 (Symbolic Math Toolbox).

You can rewrite other hyperbolic functions in terms of `sinh` and `cosh`. For example, `sech(x)` is rewritten as  $1/\cosh(x)$ . Use `expand` or `rewrite` to rewrite expressions involving `tanh` and `coth` in terms of `sinh` and `cosh`. See “Example 4” on page 1-1953 (Symbolic Math Toolbox).

The inverse function is implemented by `arccosh`. See “Example 5” on page 1-1954 (Symbolic Math Toolbox).

The float attributes are kernel functions, thus, floating-point evaluation is fast.

## Environment Interactions

When called with a floating-point argument, the functions are sensitive to the environment variable DIGITS which determines the numerical working precision.

## Examples

### Example 1

Call `cosh` with the following exact and symbolic input arguments:

`cosh(I*PI)`, `cosh(1)`, `cosh(5 + I)`, `cosh(PI)`, `cosh(1/11)`, `cosh(8)`

$-1$ ,  $\cosh(1)$ ,  $\cosh(5 + i)$ ,  $\cosh(\pi)$ ,  $\cosh\left(\frac{1}{11}\right)$ ,  $\cosh(8)$

`cosh(x)`, `cosh(x + I*PI)`, `cosh(x^2 - 4)`

$\cosh(x)$ ,  $-\cosh(x)$ ,  $\cosh(x^2 - 4)$

Floating-point values are computed for floating-point arguments:

`cosh(1.234)`, `cosh(5.6 + 7.8*I)`, `cosh(1.0/10^20)`

1.863033802, 7.295585032 + 135.0143985 i, 1.0

Floating-point intervals are computed for interval arguments:

`cosh(-1...1)`, `cosh(0...1/2)`

1.0 ... 1.543080635, 1.0 ... 1.127625966

### Example 2

Simplifications are implemented for arguments that are integer multiples of  $\frac{i\pi}{2}$ :

```
assume(n in Z_)
simplify(cosh(n*I*PI))
```

$$(-1)^n$$

```
simplify(cosh((n - 1/2)*I*PI))
```

$$0$$

```
delete n
```

Negative real numerical factors in the argument are rewritten via symmetry relations:

```
cosh(-5), cosh(-3/2*x), cosh(-x*PI/12), cosh(-12/17*x*y*PI)
```

$$\cosh(5), \cosh\left(\frac{3x}{2}\right), \cosh\left(\frac{\pi x}{12}\right), \cosh\left(\frac{12 \pi x y}{17}\right)$$

### Example 3

The `expand` function implements the addition theorems:

```
expand(cosh(x + PI*I)), expand(cosh(x + y))
```

$$-\cosh(x), \cosh(x) \cosh(y) + \sinh(x) \sinh(y)$$

The `combine` function uses these theorems in the other direction, trying to rewrite products of hyperbolic functions:

```
combine(cosh(x)*cosh(y), sinhcosh)
```

$$\frac{\cosh(x - y)}{2} + \frac{\cosh(x + y)}{2}$$

### Example 4

Use `rewrite` to obtain a representation in terms of a specific target function:

```
rewrite(cosh(x)*exp(2*x), sinhcosh);
rewrite(cosh(x), coth)
```

$$\cosh(x) (\cosh(2x) + \sinh(2x))$$

$$\frac{\coth\left(\frac{x}{2}\right)^2 + 1}{\coth\left(\frac{x}{2}\right)^2 - 1}$$

```
rewrite(cosh(x)*tanh(y), exp);
rewrite(exp(x), sinhcosh)
```

$$\frac{\left(\frac{e^{-x}}{2} + \frac{e^x}{2}\right) (e^{2y} - 1)}{e^{2y} + 1}$$

$$\cosh(x) + \sinh(x)$$

## Example 5

The inverse function is implemented as `arccosh`:

```
cosh(arccosh(x)),
arccosh(cosh(x))
```

$$x, \operatorname{arccosh}(\cosh(x))$$

Note that `arccosh(cosh(x))` does not necessarily yield `x`, because `arccosh` produces

values with imaginary parts in the interval  $\left[-\frac{\pi}{2}, \frac{\pi}{2}\right]$ :

```
arccosh(cosh(3)), arccosh(cosh(1.6 + 100*I))
```

$$3, 1.6 - 0.5309649149 i$$

## Example 6

`diff`, `float`, `limit`, `taylor`, `series` and other system functions handle expressions involving the hyperbolic functions:

```
diff(cosh(x^2), x), float(cosh(3)*coth(5 + I))
```

$$2 x \sinh(x^2), 10.06728155 - 0.0008311958272 i$$

```
limit(cosh(sin(x)/x), x = 0)
```

$$\frac{e^{-1}}{2} + \frac{e}{2}$$

```
taylor(cosh(x), x = 0)
```

$$1 + \frac{x^2}{2} + \frac{x^4}{24} + O(x^6)$$

```
series(cosh(1/x), x = 0, Right)
```

$$\frac{e^{\frac{1}{x}}}{2} + \frac{e^{-\frac{1}{x}}}{2}$$

## Parameters

**x**

An arithmetical expression (Symbolic Math Toolbox) or a floating-point interval on page 7-33

## Return Values

Arithmetical expression or a floating-point interval

## Overloaded By

x

## See Also

### MuPAD Functions

arccosh | arccoth | arccsch | arcsech | arcsinh | arctanh | coth | csch | sech |  
sinh | tanh

# tanh

Hyperbolic tangent function

## Syntax

`tanh(x)`

## Description

`tanh(x)` represents the hyperbolic tangent function,  $\sinh(x)/\cosh(x)$ . This function is defined for complex arguments.

Floating-point values are returned for floating-point arguments. Floating-point intervals are returned for floating-point interval arguments. Unevaluated function calls are returned for most exact arguments.

The hyperbolic tangent function equals 0 at the points  $i\pi n$ , where  $n$  is an integer. The

hyperbolic tangent function has singularities at the points  $\frac{\pi i}{2} + \pi i n$ , where  $n$  is an integer. If the argument involves a negative numerical factor of `Type::Real`, then symmetry relations are used to make this factor positive. See “Example 2” on page 1-1958 (Symbolic Math Toolbox).

The special values  $\tanh(0) = 0$ ,  $\tanh(\infty) = 1$ , and  $\tanh(-\infty) = -1$  are implemented.

The functions `expand` and `combine` implement the addition theorems for the hyperbolic functions. See “Example 3” on page 1-1959 (Symbolic Math Toolbox).

Use `expand` or `rewrite` to rewrite expressions involving `tanh` and `coth` in terms of `sinh` and `cosh`. See “Example 4” on page 1-1959 (Symbolic Math Toolbox).

The inverse function is implemented as `arctanh`. See “Example 5” on page 1-1960 (Symbolic Math Toolbox).

The float attributes are kernel functions, thus, floating-point evaluation is fast.

## Environment Interactions

When called with a floating-point argument, the functions are sensitive to the environment variable DIGITS which determines the numerical working precision.

## Examples

### Example 1

Call `tanh` with the following exact and symbolic input arguments:

`tanh(I*PI), tanh(1), tanh(5 + I), tanh(PI), tanh(1/11), tanh(8)`

`0, tanh(1), tanh(5 + i), tanh( $\pi$ ), tanh( $\frac{1}{11}$ ), tanh(8)`

`tanh(x), tanh(x + I*PI), tanh(x^2 - 4)`

`tanh(x), tanh(x), tanh( $x^2 - 4$ )`

Floating-point values are computed for floating-point arguments:

`tanh(1.234), tanh(5.6 + 7.8*I), tanh(1.0/10^20)`

`0.8437356626, 1.00002719 + 0.000002946969262 i, 1.0 10-20`

Floating-point intervals are computed for interval arguments:

`tanh(-1...1), tanh(0...1/2)`

`-0.761594156 ... 0.761594156, 0.0 ... 0.4621171573`

### Example 2

The hyperbolic tangent function equals 0 at the points  $i\pi n$  where  $n$  is an integer:



```
assume(n in Z_)
simplify(tanh(n*I*PI))
```

0

```
delete n
```

Negative real numerical factors in the argument are rewritten via symmetry relations:

```
tanh(-5), tanh(-3/2*x), tanh(-x*PI/12), tanh(-12/17*x*y*PI)
```

$$-\tanh(5), -\tanh\left(\frac{3x}{2}\right), -\tanh\left(\frac{\pi x}{12}\right), -\tanh\left(\frac{12 \pi x y}{17}\right)$$

### Example 3

The `expand` function implements the addition theorems:

```
expand(tanh(x + PI*I)), expand(tanh(x + y))
```

$$\tanh(x), \frac{\tanh(x) + \tanh(y)}{\tanh(x) \tanh(y) + 1}$$

### Example 4

Use `rewrite` to obtain a representation in terms of a specific target function:

```
rewrite(tanh(x)*tanh(2*x), sinhcosh), rewrite(sinh(x), tanh)
```

$$\frac{\sinh(2x) \sinh(x)}{\cosh(2x) \cosh(x)}, -\frac{2 \tanh\left(\frac{x}{2}\right)}{\tanh\left(\frac{x}{2}\right)^2 - 1}$$

```
rewrite(tanh(x)*sinh(y), exp), rewrite(exp(x), tanh)
```

$$-\frac{\left(\frac{e^{-y}}{2} - \frac{e^y}{2}\right) \left(e^{2x} - 1\right)}{e^{2x} + 1}, -\frac{\tanh\left(\frac{x}{2}\right) + 1}{\tanh\left(\frac{x}{2}\right) - 1}$$

### Example 5

The inverse function is implemented as `arctanh`:

```
tanh(arctanh(x)),
arctanh(tanh(x))
```

```
x, arctanh(tanh(x))
```

Note that `arctanh(tanh(x))` does not necessarily yield `x`, because `arctanh` produces

values with imaginary parts in the interval  $\left[-\frac{\pi}{2}, \frac{\pi}{2}\right]$ :

```
arctanh(tanh(3)), arctanh(tanh(1.6 + 100*I))
```

```
3, 1.6 - 0.5309649149 i
```

### Example 6

`diff`, `float`, `limit`, `taylor`, `series`, and other system functions handle expressions involving the hyperbolic functions:

```
diff(tanh(x), x), float(cosh(3)*tanh(5 + I))
```

```
1 - tanh(x)^2, 10.06804239 + 0.0008312586448 i
```

```
limit(x*sinh(x)/tanh(x^2), x = 0)
```

```
1
```

```
taylor(tanh(x), x = 0)
```

$$x - \frac{x^3}{3} + \frac{2x^5}{15} + O(x^7)$$

`series(tanh(x), x = infinity)`

$$1 - 2e^{-2x} + 2e^{-4x} - 2e^{-6x} + 2e^{-8x} - 2e^{-10x} + O(e^{-12x})$$

## Parameters

**x**

An arithmetical expression (Symbolic Math Toolbox) or a floating-point interval on page 7-33

## Return Values

Arithmetical expression or a floating-point interval

## Overloaded By

x

## See Also

### MuPAD Functions

arccosh | arccoth | arccsch | arcsech | arcsinh | arctanh | cosh | coth | csch | sech | sinh

## csch

Hyperbolic cosecant function

### Syntax

`csch(x)`

### Description

`csch(x)` represents the hyperbolic cosecant function,  $1/\sinh(x)$ . This function is defined for complex arguments.

Floating-point values are returned for floating-point arguments. Floating-point intervals are returned for floating-point interval arguments. Unevaluated function calls are returned for most exact arguments.

The hyperbolic cosecant function simplifies to  $(-1)^{n+1/2}$  at the points  $\frac{\pi i}{2} + \pi i n$ , where  $n$  is an integer. The hyperbolic cosecant function has singularities at the points  $i\pi n$ , where  $n$  is an integer. If the argument involves a negative numerical factor of `Type::Real`, then symmetry relations are used to make this factor positive. See “Example 2” on page 1-1964 (Symbolic Math Toolbox).

The functions `expand` and `combine` implement the addition theorems for the hyperbolic functions. See “Example 3” on page 1-1964 (Symbolic Math Toolbox).

`csch(x)` is rewritten as  $1/\sinh(x)$ . Use `expand` or `rewrite` to rewrite expressions involving `csch` in terms of other functions. See “Example 4” on page 1-1965 (Symbolic Math Toolbox).

The inverse function is implemented as `arccsch`. See “Example 5” on page 1-1965 (Symbolic Math Toolbox).

The float attributes are kernel functions, thus, floating-point evaluation is fast.

## Environment Interactions

When called with a floating-point argument, the functions are sensitive to the environment variable DIGITS which determines the numerical working precision.

## Examples

### Example 1

Call csch with the following exact and symbolic input arguments:

```
csch(I*PI/2), csch(1), csch(5 + I), csch(PI), csch(1/11), csch(8)
```

$$-i, \frac{1}{\sinh(1)}, \frac{1}{\sinh(5+i)}, \frac{1}{\sinh(\pi)}, \frac{1}{\sinh(\frac{1}{11})}, \frac{1}{\sinh(8)}$$

```
csch(x), csch(x + I*PI), csch(x^2 - 4)
```

$$\frac{1}{\sinh(x)}, -\frac{1}{\sinh(x)}, \frac{1}{\sinh(x^2 - 4)}$$

Floating-point values are computed for floating-point arguments:

```
csch(1.234), csch(5.6 + 7.8*I), csch(1.0/10^20)
```

$$0.6361695229, 0.0003990232783 - 0.007384854606 i, 1.0 \cdot 10^{-20}$$

Floating-point intervals are computed for interval arguments:

```
csch(-1...-1/2), csch(1...10)
```

$$-1.919034752 \dots -0.8509181282, 0.00009079985971 \dots 0.8509181283$$

For functions with discontinuities, evaluation over an interval can return in a union of intervals:

```
csch(-1...1)
```

```
RD_NINF ... -0.8509181282 ∪ 0.8509181282 ... RD_INF
```

## Example 2

The hyperbolic cosecant function equals simplifies to  $(-1)^{n+1/2}$  at the points  $\frac{\pi i}{2} + \pi i n$ , where  $n$  is an integer:

```
assume(n in Z_)
```

```
simplify(csch((n - 1/2)*I*PI))
```

$$(-1)^{n+\frac{1}{2}}$$

```
delete n
```

Negative real numerical factors in the argument are rewritten via symmetry relations:

```
csch(-5), csch(-3/2*x), csch(-x*PI/12), csch(-12/17*x*y*PI)
```

$$-\frac{1}{\sinh(5)}, -\frac{1}{\sinh\left(\frac{3x}{2}\right)}, -\frac{1}{\sinh\left(\frac{\pi x}{12}\right)}, -\frac{1}{\sinh\left(\frac{12 \pi x y}{17}\right)}$$

## Example 3

The expand function implements the addition theorems:

```
expand(csch(x + PI*I)), expand(csch(x + y))
```

$$-\frac{1}{\sinh(x)}, \frac{1}{\cosh(x) \sinh(y) + \cosh(y) \sinh(x)}$$

## Example 4

$\text{csch}(x)$  is automatically rewritten as  $1/\sinh(x)$ :

`csch(x)`

$$\frac{1}{\sinh(x)}$$

Use `rewrite` to obtain a representation in terms of other target functions:

`rewrite(csch(x)*exp(2*x), sinhcosh), rewrite(csch(x), exp)`

$$\frac{\cosh(2x) + \sinh(2x)}{\sinh(x)}, -\frac{1}{\frac{e^{-x}}{2} - \frac{e^x}{2}}$$

`rewrite(csch(x)*coth(y), sincos), rewrite(csch(x), tanh)`

$$-\frac{\cos(yi)}{\sin(xi)\sin(yi)}, -\frac{\tanh\left(\frac{x}{2}\right)^2 - 1}{2 \tanh\left(\frac{x}{2}\right)}$$

## Example 5

The inverse function is implemented as `arccsch`:

`csch(arccsch(x)),  
arccsch(csch(x))`

$$x, \operatorname{arcsinh}(\sinh(x))$$

Note that `arccsch(csch(x))` does not necessarily yield  $x$ , because `arccsch` produces

values with imaginary parts in the interval  $\left[-\frac{\pi}{2}, \frac{\pi}{2}\right]$ :

`arccsch(csch(3)), arccsch(csch(1.6 + 100*I))`

3, 1.6 – 0.5309649149 i

## Example 6

diff, float, limit, taylor, series, and other system functions handle expressions involving the hyperbolic functions:

`diff(csch(x), x), float(csch(3)*coth(5 + I))`

$-\frac{\cosh(x)}{\sinh(x)^2}, 0.09981779753 - 0.000008241364501 i$

`limit(x*csch(x)/cosh(x^2), x = 0)`

1

`taylor(1/csch(x), x = 0)`

$x + \frac{x^3}{6} + \frac{x^5}{120} + O(x^7)$

`series(csch(x), x = 0)`

$\frac{1}{x} - \frac{x}{6} + \frac{7x^3}{360} + O(x^5)$

## Parameters

**x**

An arithmetical expression (Symbolic Math Toolbox) or a floating-point interval on page 7-33



## Return Values

Arithmetical expression or a floating-point interval

## Overloaded By

x

## See Also

### **MuPAD Functions**

arccosh | arccoth | arccsch | arcsech | arcsinh | arctanh | cosh | coth | sech |  
sinh | tanh

## sech

Hyperbolic secant function

### Syntax

`sech(x)`

### Description

`sech(x)` represents the hyperbolic secant function,  $1/\cosh(x)$ . This function is defined for complex arguments.

Floating-point values are returned for floating-point arguments. Floating-point intervals are returned for floating-point interval arguments. Unevaluated function calls are returned for most exact arguments.

The hyperbolic secant function simplifies to  $(-1)^n$  at the points  $i\pi n$ , where  $n$  is an integer.

The hyperbolic secant function has singularities at the points  $\frac{\pi i}{2} + \pi i n$ , where  $n$  is an integer. If the argument involves a negative numerical factor of  $\frac{\pi i}{2}$ , then symmetry relations are used to make this factor positive. See “Example 2” on page 1-1970 (Symbolic Math Toolbox).

The functions `expand` and `combine` implement the addition theorems for the hyperbolic functions. See “Example 3” on page 1-1970 (Symbolic Math Toolbox).

`sech(x)` is rewritten as  $1/\cosh(x)$ . Use `expand` or `rewrite` to rewrite expressions involving `sech` in terms of other functions. See “Example 4” on page 1-1970 (Symbolic Math Toolbox).

The inverse function is implemented as `arcsech`. See “Example 5” on page 1-1971 (Symbolic Math Toolbox).

The float attributes are kernel functions, thus, floating-point evaluation is fast.

## Environment Interactions

When called with a floating-point argument, the functions are sensitive to the environment variable DIGITS which determines the numerical working precision.

## Examples

### Example 1

Call sech with the following exact and symbolic input arguments:

```
sech(I*PI), sech(1), sech(5 + I), sech(PI), sech(1/11), sech(8)
```

$$-1, \frac{1}{\cosh(1)}, \frac{1}{\cosh(5+i)}, \frac{1}{\cosh(\pi)}, \frac{1}{\cosh(\frac{1}{11})}, \frac{1}{\cosh(8)}$$

```
sech(x), sech(x + I*PI), sech(x^2 - 4)
```

$$\frac{1}{\cosh(x)}, -\frac{1}{\cosh(x)}, \frac{1}{\cosh(x^2 - 4)}$$

Floating-point values are computed for floating-point arguments:

```
sech(1.234), sech(5.6 + 7.8*I), sech(1.0/10^20)
```

$$0.5367589139, 0.0003990558905 - 0.007385054221 i, 1.0$$

Floating-point intervals are computed for interval arguments:

```
sech(-1...1), sech(1...10)
```

$$0.6480542736 \dots 1.0, 0.00009079985933 \dots 0.6480542737$$

## Example 2

The hyperbolic secant function equals simplifies to  $(-1)^n$  at the points  $i\pi n$ , where  $n$  is an integer:

```
assume(n in Z_)
simplify(sech(n*I*PI))
```

$$(-1)^n$$

```
delete n
```

Negative real numerical factors in the argument are rewritten via symmetry relations:

```
sech(-5), sech(-3/2*x), sech(-x*PI/12), sech(-12/17*x*y*PI)
```

$$\frac{1}{\cosh(5)}, \frac{1}{\cosh\left(\frac{3x}{2}\right)}, \frac{1}{\cosh\left(\frac{\pi x}{12}\right)}, \frac{1}{\cosh\left(\frac{12 \pi x y}{17}\right)}$$

## Example 3

The expand function implements the addition theorems:

```
expand(sech(x + PI*I)), expand(sech(x + y))
```

$$-\frac{1}{\cosh(x)}, \frac{1}{\cosh(x) \cosh(y) + \sinh(x) \sinh(y)}$$

## Example 4

$\text{sech}(x)$  is automatically rewritten as  $1/\cosh(x)$ :

```
sech(x)
```

$$\frac{1}{\cosh(x)}$$

Use `rewrite` to obtain a representation in terms of other target functions:

```
rewrite(sech(x)*exp(2*x), sinhcosh), rewrite(sech(x), tanh)
```

$$\frac{\cosh(2x) + \sinh(2x)}{\cosh(x)}, \quad -\frac{\tanh\left(\frac{x}{2}\right)^2 - 1}{\tanh\left(\frac{x}{2}\right)^2 + 1}$$

```
rewrite(sinh(x)*sech(y), exp), rewrite(sech(x), coth)
```

$$-\frac{\frac{e^{-x}}{2} - \frac{e^x}{2}}{\frac{e^{-y}}{2} + \frac{e^y}{2}}, \quad \frac{\coth\left(\frac{x}{2}\right)^2 - 1}{\coth\left(\frac{x}{2}\right)^2 + 1}$$

## Example 5

The inverse function is implemented as `arcsech`:

```
sech(arcsech(x)),  
arcsech(sech(x))
```

```
x, arccosh(cosh(x))
```

Note that `arcsech(sech(x))` does not necessarily yield `x`, because `arcsech` produces

values with imaginary parts in the interval  $\left[-\frac{\pi}{2}, \frac{\pi}{2}\right]$ :

```
arcsech(sech(3)), arcsech(sech(1.6 + 100*I))
```

```
3, 1.6 - 0.5309649149 i
```

## Example 6

`diff`, `float`, `limit`, `taylor`, `series`, and other system functions handle expressions involving the hyperbolic functions:

```
diff(sech(x), x), float(sech(3)*coth(5 + I))
```

$$-\frac{\sinh(x)}{\cosh(x)^2}, 0.09932417394 - 0.000008200608923 i$$

```
limit(1/sech(sin(x)/x), x = 0)
```

$$\frac{e^{-1}}{2} + \frac{e}{2}$$

```
taylor(1/sech(x), x = 0)
```

$$1 + \frac{x^2}{2} + \frac{x^4}{24} + O(x^6)$$

```
series(sech(x), x = 0)
```

$$1 - \frac{x^2}{2} + \frac{5x^4}{24} + O(x^6)$$

## Parameters

**x**

An arithmetical expression (Symbolic Math Toolbox) or a floating-point interval on page 7-33

## Return Values

Arithmetical expression or a floating-point interval

## Overloaded By

x

## See Also

### MuPAD Functions

arccosh | arccoth | arccsch | arcsech | arcsinh | arctanh | cosh | coth | csch |  
sinh | tanh

## coth

Hyperbolic cotangent function

### Syntax

`coth(x)`

### Description

`coth(x)` represents the hyperbolic cotangent function,  $\cosh(x)/\sinh(x)$ . This function is defined for complex arguments.

Floating-point values are returned for floating-point arguments. Floating-point intervals are returned for floating-point interval arguments. Unevaluated function calls are returned for most exact arguments.

The hyperbolic cotangent function equals 0 at the points  $\frac{\pi i}{2} + \pi i n$ , where  $n$  is an integer.

The hyperbolic tangent function has singularities at the points  $i\pi n$ , where  $n$  is an integer. If the argument involves a negative numerical factor of `Type::Real`, then symmetry relations are used to make this factor positive. See “Example 2” on page 1-1976 (Symbolic Math Toolbox).

The special values  $\coth(\infty) = 1$  and  $\coth(-\infty) = -1$  are implemented.

The functions `expand` and `combine` implement the addition theorems for the hyperbolic functions. Cf. “Example 3” on page 1-1976 (Symbolic Math Toolbox).

Use `expand` or `rewrite` to rewrite expressions involving `tanh` and `coth` in terms of `sinh` and `cosh`. See “Example 4” on page 1-1976 (Symbolic Math Toolbox).

The inverse function is implemented as `arccoth`. See “Example 5” on page 1-1977 (Symbolic Math Toolbox).

The float attributes are kernel functions, thus, floating-point evaluation is fast.



## Environment Interactions

When called with a floating-point argument, the functions are sensitive to the environment variable DIGITS which determines the numerical working precision.

## Examples

### Example 1

Call `coth` with the following exact and symbolic input arguments:

```
coth(I*PI/2), coth(1), coth(5 + I), coth(PI), coth(1/11), coth(8)
```

```
0, coth(1), coth(5 + i), coth(π), coth(1/11), coth(8)
```

```
coth(x), coth(x + I*PI), coth(x^2 - 4)
```

```
coth(x), coth(x), coth(x^2 - 4)
```

Floating-point values are computed for floating-point arguments:

```
coth(1.234), coth(5.6 + 7.8*I), coth(1.0/10^20)
```

```
1.185205325, 0.9999728112 - 0.000002946809015 i, 1.0 1020
```

Floating-point intervals are computed for interval arguments:

```
coth(-1...-1/2), coth(1...10)
```

```
-2.163953414 ... -1.313035285, 1.000000004 ... 1.313035286
```

For functions with discontinuities, evaluation over an interval can return a union of intervals:

```
coth(-1...1)
```

RD\_NINF ... - 1.313035285 ∪ 1.313035285 ... RD\_INF

## Example 2

The hyperbolic cotangent function equals 0 at the points  $\frac{\pi i}{2} + \pi i n$ , where  $n$  is an integer:

```
assume(n in Z_)
simplify(coth((n - 1/2)*I*PI))
```

0

```
delete n
```

Negative real numerical factors in the argument are rewritten via symmetry relations:

```
coth(-5), coth(-3/2*x), coth(-x*PI/12), coth(-12/17*x*y*PI)
```

$-\coth(5), -\coth\left(\frac{3x}{2}\right), -\coth\left(\frac{\pi x}{12}\right), -\coth\left(\frac{12 \pi x y}{17}\right)$

## Example 3

The expand function implements the addition theorems:

```
expand(coth(x + PI*I)), expand(coth(x + y))
```

$\coth(x), \frac{\coth(x) \coth(y) + 1}{\coth(x) + \coth(y)}$

## Example 4

Use rewrite to obtain a representation in terms of a specific target function:

```
rewrite(coth(x)*exp(2*x), sinhcosh), rewrite(sinh(x), coth)
```

$$\frac{\cosh(x) (\cosh(2x) + \sinh(2x))}{\sinh(x)}, \frac{2 \coth\left(\frac{x}{2}\right)}{\coth\left(\frac{x}{2}\right)^2 - 1}$$

`rewrite(sinh(x)*coth(y), exp), rewrite(exp(x), coth)`

$$-\frac{\left(\frac{e^{-x}}{2} - \frac{e^x}{2}\right) (e^{2y} + 1)}{e^{2y} - 1}, \frac{\coth\left(\frac{x}{2}\right) + 1}{\coth\left(\frac{x}{2}\right) - 1}$$

## Example 5

The inverse function is implemented as `arccoth`:

`coth(arccoth(x)),`  
`arccoth(coth(x))`

`x, arccoth(coth(x))`

Note that `arccoth(coth(x))` does not necessarily yield `x`, because `arccoth` produces

values with imaginary parts in the interval  $\left[-\frac{\pi}{2}, \frac{\pi}{2}\right]$ :

`arccoth(coth(3)), arccoth(coth(1.6 + 100*I))`

`3, 1.6 - 0.5309649149 i`

## Example 6

`diff`, `float`, `limit`, `taylor`, `series`, and other system functions handle expressions involving the hyperbolic functions:

`diff(coth(x), x), float(sinh(3)*coth(5 + I))`

`1 - coth(x)^2, 10.01749636 - 0.0008270853591 i`

```
limit(x*coth(x)/cosh(x^2), x = 0)
```

1

```
taylor(1/coth(x), x = 0)
```

$$x - \frac{x^3}{3} + \frac{2x^5}{15} + O(x^7)$$

```
series(coth(x), x = 0)
```

$$\frac{1}{x} + \frac{x}{3} - \frac{x^3}{45} + O(x^5)$$

```
series(coth(x), x = infinity)
```

$$1 + 2e^{-2x} + 2e^{-4x} + 2e^{-6x} + 2e^{-8x} + 2e^{-10x} + O(e^{-12x})$$

## Parameters

**x**

An arithmetical expression (Symbolic Math Toolbox) or a floating-point interval on page 7-33

## Return Values

Arithmetical expression or a floating-point interval

## Overloaded By

x

## See Also

### MuPAD Functions

arccosh | arccoth | arccsch | arcsech | arcsinh | arctanh | cosh | csch | sech |  
sinh | tanh

## slot

Method or entry of a domain or a function environment

### Syntax

```
d::n
```

```
slot(d, "n")
```

```
d::n := v
```

```
slot(d, "n", v)
```

```
object::dom
```

```
slot(object, "dom")
```

### Description

`d::n` returns the value of the slot named "n" of the object `d`.

`d::n := v` creates or changes the slot "n". The value `v` is assigned to the slot.

The function `slot` is used for defining methods and entries of data types (domains (Symbolic Math Toolbox)) or for defining attributes of function environments on page 7-25. Such methods, entries, or attributes are called *slots*. They allow to overload system functions by user defined domains and function environments. See the "Background" section below for further information.

Any MuPAD object has a special slot named "dom". It holds the domain the object belongs to: `slot(object, "dom")` is equivalent to `domtype(object)`. The value of this special slot cannot be changed. Cf. "Example 1" on page 1-1982 (Symbolic Math Toolbox).

Apart from the special slot "dom", only domains (Symbolic Math Toolbox) and function environments on page 7-25 may have further slots.

The call `slot(d, "n")` is equivalent to `d::n`. It returns the value of the slot.

The call `slot(d, "n", v)` returns the object `d` with an added or changed slot "n" bearing the value `v`.

For a *function environment* `d`, the call `slot(d, "n", v)` returns `d` with the changed slot "n" and changes the function environment `d` as a side-effect. This is the so-called "reference effect" of function environments. Cf. "Example 2" on page 1-1982 (Symbolic Math Toolbox).

For a *domain* `d`, however, the call `slot(d, "n", v)` modifies `d` as a side-effect and returns the domain. This is the so-called "reference effect" of domains. Cf. "Example 3" on page 1-1983 (Symbolic Math Toolbox).

If a non-existing slot is accessed, FAIL is returned as the value of the slot. Cf. "Example 4" on page 1-1983 (Symbolic Math Toolbox).

The `::`-operator is a shorthand notation to access a slot.

The expression `d::n`, when not appearing on the left hand side of an assignment, is equivalent to `slot(d, "n")`.

The command `d::n := v` assigns the value `v` to the slot "n" of `d`. This assignment is almost equivalent to changing or creating a slot via `slot(d, "n", v)`. Note the following subtle semantical difference between these assignments: in `d::n := v`, the identifier `d` is evaluated with level 1, i.e., the slot "n" is attached to the *value* of `d`. In `slot(d, "n", v)`, the identifier `d` is *fully evaluated*. See "Example 6" on page 1-1984 (Symbolic Math Toolbox).

With `delete d::n` or `delete slot(d, "n")`, the slot "n" of the function environment or the domain `d` is deleted. Cf. "Example 5" on page 1-1983 (Symbolic Math Toolbox). The special slot "dom" cannot be deleted.

The first argument of `slot` is not flattened (Symbolic Math Toolbox). This allows to access the slots of expression sequences on page 1-88 and `null()` objects. Cf. "Example 7" on page 1-1985 (Symbolic Math Toolbox).

For domains, there is a special mechanism to create new values for slots on demand. If a non existing slot is read, the method "make\_slot" of the domain is called in order to create the slot. If such a method does not exist, FAIL is returned. Cf. "Example 8" on page 1-1985 (Symbolic Math Toolbox).

## Examples

### Example 1

Every object has the slot "dom":

```
x::dom = domtype(x),  
slot(45, "dom") = domtype(45),  
sin::dom = domtype(sin)
```

```
DOM_IDENT = DOM_IDENT, DOM_INT = DOM_INT,  
DOM_FUNC_ENV = DOM_FUNC_ENV
```

### Example 2

Here we access the existing "float" slot of the function environment `sin` implementing the sine function. The float slot is again a function environment and may be called like any MuPAD function. Note, however, the different functionality: in contrast to `sin`, the float slot always tries to compute a floating-point approximation:

```
s := sin::float: s(1), sin(1)
```

```
0.8414709848, sin(1)
```

With the following commands, `s` becomes the function environment `sin` apart from a changed "float" slot. The `slot` call has no effect on the original `sin` function because `slot` returns a copy of the function environment:

```
s := funcenv(sin):  
s::float := x -> float(x - x^3/3!):  
s(PI/3) = sin(PI/3), s::float(1) <> sin::float(1)
```

```
 $\frac{\sqrt{3}}{2} = \frac{\sqrt{3}}{2}, 0.8333333333 \neq 0.8414709848$ 
```

```
delete s:
```



### Example 3

If you are using the `slot` function to change slot entries in a domain, you must be aware that you are modifying the domain:

```
old_one := Dom::Float::one
```

```
1.0
```

```
newDomFloat := slot(Dom::Float, "one", 1):  
newDomFloat::one, Dom::Float::one
```

```
1, 1
```

We restore the original state:

```
slot(Dom::Float, "one", old_one): Dom::Float::one
```

```
1.0
```

```
delete old_one, newDomFloat:
```

### Example 4

The function environment `sin` does not contain a "sign" slot. So accessing this slot yields FAIL:

```
slot(sin, "sign"), sin::sign
```

```
FAIL, FAIL
```

### Example 5

We define a function environment for a function computing the logarithm to the base 3:

```
log3 := funcenv(x -> log(3, x)):
```

If the function `info` is to give some information about `log3`, we have to define the "info" slot for this function:

```
log3::info := "log3 -- the logarithm to the base 3":  
info(log3)
```

```
log3 -- the logarithm to the base 3
```

The `delete` statement is used for deleting a slot:

```
delete log3::info: info(log3)
```

```
log3(x) -- a library procedure [try ?log3 for help]
```

It is not possible to delete the special slot "dom":

```
delete log3::dom
```

```
Error: Invalid argument. [delete]
```

```
delete log3:
```

## Example 6

Here we demonstrate the subtle difference between the `slot` function and the use of the `::`-operator in assignments. The following call adds a "xyz" slot to the domain `DOM_INT` of integer numbers:

```
delete b: d := b: b := DOM_INT: slot(d, "xyz", 42):
```

The slot "xyz" of `DOM_INT` is changed, because `d` is fully evaluated with the result `DOM_INT`. Hence, the slot `DOM_INT::xyz` is set to 42:

```
slot(d, "xyz"), slot(DOM_INT, "xyz")
```

```
42, 42
```

Here is the result when using the `::`-operator: `d` is only evaluated with level 1, i.e., it is evaluated to the identifier `b`. However, there is no slot `b::xyz`, and an error occurs:

```
delete b: d := b: b := DOM_INT: d::xyz := 42
```

```
Error: Unknown slot 'd::xyz'. [slot]
```

```
delete b, d:
```

## Example 7

The first argument of `slot` is not flattened (Symbolic Math Toolbox). This allows access to the slots of expression sequences and `null()` objects:

```
slot((a, b), "dom") = (a,b)::dom,
slot(null(), "dom") = (null())::dom
```

```
DOM_EXPR = DOM_EXPR, DOM_NULL = DOM_NULL
```

## Example 8

We give an example for the use of the function `make_slot`. The element `undefined` of the domain `stdlib::Undefined` represents an undefined value. Any function `f` should yield `f(undefined) = undefined`. Inside the implementation of `stdlib::Undefined`, we find:

```
undef := newDomain("stdlib::Undefined"):
undefined := new(undef):
undef::func_call := proc() begin undefined end_proc;
undef::make_slot := undef::func_call:
```

The following mechanism takes place automatically for a function `f` that is overloadable by its first argument: in the call `f(undefined)`, it is checked whether the slot `undef::f` exists. If this is not the case, the `make_slot` function creates this slot “on the fly”, producing the value `undefined`. Thus, via overloading, `f(undefined)` returns the value `undefined`.

## Example 9

The following example is rather advanced and technical. It demonstrates overloading of the `slot` function to implement slot access and slot assignments for other objects than domains (`DOM_DOMAIN`) or function environments (`DOM_FUNC_ENV`). The following

example defines the slots "numer" and "denom" for rational numbers. The domain DOM\_RAT of such numbers does not have slots "numer" and "denom":

```
domtype(3/4)
```

```
DOM_RAT
```

```
slot(3/4, "numer")
```

```
Error: Unknown slot '(3/4)::numer'. [slot]
```

We can change DOM\_RAT, however. For this, we have to unprotect on page 1-2213DOM\_RAT temporarily:

```
unprotect(DOM_RAT):
DOM_RAT::slot :=
  proc(r : DOM_RAT, n : DOM_STRING, v=null(): DOM_INT)
    local i : DOM_INT;
  begin
    i := contains(["numer", "denom"], n);
    if i = 0 then
      error("Unknown slot \"\".expr2text(r).\"::\".n.\"\"")
    end;
    if args(0) = 3 then
      subsop(r, i = v)
    else
      op(r, i)
    end
  end_proc;
```

Now, we can access the operands of rational numbers, which are the numerator and the denominator respectively, via our new slots:

```
slot(3/4, "numer"), (3/4)::numer,
slot(3/4, "denom"), (3/4)::denom
```

```
3, 3, 4, 4
```

```
a := 3/4: slot(a, "numer", 7)
```

```
 $\frac{7}{4}$ 
```

```
a::numer := 11: a
```

$$\frac{11}{4}$$

We restore the original behavior:

```
delete DOM_RAT::slot, a: protect(DOM_RAT, Error):
```

## Parameters

**d**

A domain (Symbolic Math Toolbox) or a function environment on page 1-1642 (Symbolic Math Toolbox)

**n**

The name of the slot: an identifier on page 7-29

**v**

The new value of the slot: an arbitrary MuPAD object

**object**

An arbitrary MuPAD object

## Return Values

`slot(d, "n")` returns the value of the slot; `slot(d, "n", v)` returns the object `d` with the added or changed slot; `slot(object, "dom")` returns the domain type of the object.

## Overloaded By

**d**

## Algorithms

Overloading of system functions by domain elements is typically implemented as follows. If a library function `f`, say, is to be overloadable by user defined data types, a code segment as indicated by the following lines is appropriate. It tests whether the domain `x::dom` of the argument `x` contains a method `f`. If this is the case, this domain method is called:

```
f:= proc(x)
  begin
    // check if f is overloaded by x
    if x::dom::f <> FAIL then
      // use the method of the domain of x
      return(x::dom::f(args()))
    else
      // execute the code for the function f
    endif
  end_proc:
```

By overloading the function `slot`, slot access and slot assignment can be implemented for other objects than domains or function environments. Cf. “Example 9” on page 1-1985 (Symbolic Math Toolbox).

In principle, the name `n` of a slot may be an arbitrary MuPAD object. Note, however, that the `::`-operator cannot access slots defined by `slot(d, n, v)` if the the name `n` is not a string.

Strings may be used in conjunction with the `::`-operator: the calls `d::"n"` and `d::n` are equivalent.

## See Also

### **MuPAD Domains**

`DOM_DOMAIN` | `DOM_FUNC_ENV`

### **MuPAD Functions**

`funcenv` | `newDomain` | `slotAssignCounter`

# slotAssignCounter

Counts slot assignments

## Syntax

```
slotAssignCounter(key)
```

## Description

`slotAssignCounter(key)` returns the number of `slot` assignments with the key `key` since the initialization of the counter. The counter for `key` is initialized with 0 on the first call of `slotAssignCounter(key)`. Previous assignments with the key `key` are not counted.. This function serves a highly technical purpose. Usually, there should be no need for a user to call this function.

`slotAssignCounter` only counts assignments to slots of domains on page 7-8 and function environments on page 7-25.

`slotAssignCounter` was introduced as a dependency check function for `prog::remember`. See “Example 2” on page 1-1990 (Symbolic Math Toolbox).

## Examples

### Example 1

We initialize slot assignment counting of the slot "foo":

```
slotAssignCounter("foo")
```

0

Then we define a function `f` with a slot "foo":

```
f := funcenv(f):  
f::foo := bar:
```

Now the counter has the value 1:

```
slotAssignCounter("foo")
```

1

## Example 2

Here we define a recursing function `foo` which overloads for domain elements. The function remembers computed values with `prog::remember`:

```
foo := x -> (if x::dom::foo <> FAIL then return(x::dom::foo(x)) end_if;  
            if x = op(x) then procname(x) else map(x, foo) end_if):  
foo := prog::remember(foo):
```

Then we define a domain `bar` which does not overload the slot "foo":

```
bar := newDomain("bar"):  
bar::new := x -> new(bar, x):  
bar::print := x -> hold(bar)(extop(x)):  
bar::op := id:  
foo(bar(2))
```

`foo(bar(2))`

Now we add a "foo" slot to `bar`:

```
bar::foo := x -> 4:  
foo(bar(2))
```

`foo(bar(2))`

The new slot was not used, because `foo` took the result from its remember table. If we use a dependency function with `slotAssignCounter` in `prog::remember`, we can make `foo` aware of changes in "foo"-slots of other functions and domains:

```
foo := x -> (if x::dom::foo <> FAIL then return(x::dom::foo(x)) end_if;  
            if x = op(x) then x else map(x, foo) end_if):
```



```
foo := prog::remember(foo, () -> slotAssignCounter("foo")):  
foo(bar(2));  
bar::foo := x -> 5:  
foo(bar(2))
```

4

5

```
delete foo, bar:
```

## Parameters

### key

Any MuPAD object

## Return Values

Non-negative number of type DOM\_INT.

## See Also

### MuPAD Functions

prog::remember | slot

# **solve**

Solve equations and inequalities

---

**Note** For the `solve` function in MATLAB®, see `solve`.

---

## **Syntax**

```
solve(eq, x, options)
solve(eq, x = a .. b, options)
solve(eq, vars, options)
solve(eq, options)
solve(eqs, x, options)
solve(eqs, vars, options)
solve(eqs, options)
solve(ODE)
solve(REC)
```

## **Description**

`solve(eq, x)` returns the set of all complex solutions of an equation or inequality `eq` with respect to `x`.

`solve(eq, x = a..b)` returns the set of all solutions in the closed interval `Dom::Interval([a, b])`.

`solve(eq, vars)` solves an equation for the variables `vars`.

`solve(eqs, x)` solves a system `eqs` for the variable `x`.

`solve(eqs, vars)` solves a system `eqs` of equations for the variables `vars`.

The `solve` function provides a unified interface to a variety of specialized solvers. See [Choosing a Solver](#) (Symbolic Math Toolbox).

If you do not specify indeterminates for which you want to solve an equation, inequality or system, the solver uses a set of all indeterminates. Indeterminates must be identifiers or indexed identifiers. You cannot use mathematical constants, such as `PI` (Symbolic Math Toolbox), `EULER` (Symbolic Math Toolbox), and so on, as indeterminates. The solver discards indeterminates that appear only inside function names or indices. See “[Example 12](#)” on page 1-2001 (Symbolic Math Toolbox).

If you specify a list of indeterminates for which you want to solve an equation, an inequality, or a system, the solver sorts the components of the resulting solution vectors according to the order of the indeterminates that you used. If you specify indeterminates as a set, MuPAD can change the order of the indeterminates.

`solve(eq, vars)` is equivalent to `solve([eq], vars)`.

The solver can return the following types of sets:

- Finite sets (type `DOM_SET`).
- Symbolic calls to `solve`.
- Zero sets of polynomials (type `RootOf`). The solver returns a set of this type if it cannot solve an equation explicitly in terms of radicals. The solver also can return this type of set when you use the `MaxDegree` option.
- Set-theoretic expressions, such as `"_union"`, `"_intersect"`, and `"_minus"`.
- Symbolic calls to `solveLib::Union`. These calls represent unions over parametrized systems of sets.
- The  $\mathbb{C}$ ,  $\mathbb{R}$ ,  $\mathbb{Q}$ , and  $\mathbb{Z}$  (type `solveLib::BasicSet`) sets.
- Intervals (type `Dom::Interval`).
- Image sets of functions (type `Dom::ImageSet`).
- Piecewise objects in which every branch defines a set of one of the valid types (type `piecewise`).

MuPAD can use sets of these types, excluding intervals and basic sets, to represent sets of vectors (for solutions of systems). When solving a system, MuPAD also can return a solution in the form  $S^n$  (the  $n$ -fold cartesian power of the set  $S$  of scalars). Here  $S$  is a set of any type returned by `solve`.

For returned solution sets, you can use the set-theoretic operations, such as `intersect`, `union`, and `minus`. Also, you can use pointwise-defined arithmetical operations, such as

`+`, `*`, and so on. To extract elements of a set, use the `solveLib::getElement` function. To test whether the solution set returned by `solve` is finite, use the function `solveLib::isFinite`. See “Example 2” on page 1-1995 (Symbolic Math Toolbox)

For systems, the solver returns a set of vectors or a set of lists of equations. To specify that the solver must return a set of vectors, use the `VectorFormat` option. See “Example 10” on page 1-2000 (Symbolic Math Toolbox).

By default, `solve(eq, x)` returns only the solutions consistent with the properties on page 1-265 of `x`. To ignore the properties of `x`, use the `IgnoreProperties` option. This option is helpful when you solve a system of equations for more than one variable. See “Example 13” on page 1-2002 (Symbolic Math Toolbox).

An inequality  $a \leq b$  or  $a < b$  holds only when both sides represent real numbers. In particular,  $a = b$  does not imply that  $a \leq b$  for complex numbers.

You can write custom domains for equations of special types, and then overload `solve` for these domains. MuPAD uses this feature for differential and recurrence equations. See the `ode`, `ode::solve`, and `rec` help pages.

The `solve` function is a symbolic solver. If you want to use numeric methods, see the `numeric::solve` help page for available options and examples.

If the input contains floating-point numbers, the solver replaces them by approximate rational values. The accuracy of these approximate values depends on the environment variable `DIGITS`. If `solve` finds a solution, MuPAD internally calls the `float` function for that solution, and then returns the result. If the symbolic solver returns `unevaluated`, MuPAD calls `numeric::solve`. See “Example 16” on page 1-2003 (Symbolic Math Toolbox).

If a numerator contains a factored polynomial with the multiplicities greater than 1, the solver does not check the multiple roots for zeros in the denominator. See “Example 17” on page 1-2003 (Symbolic Math Toolbox).

## Environment Interactions

`solve` reacts to properties (Symbolic Math Toolbox) of identifiers.

## Examples

### Example 1

Solve the following equation. Typically, for equations with a finite number of solutions, the solver returns a set of the `DOM_SET` type:

```
S := solve(x^4 - 5*x^2 + 6*x = 2, x)
```

$$\{1, -\sqrt{3}-1, \sqrt{3}-1\}$$

Assign individual solutions to variables by indexing into S:

```
sol1 := S[1]
```

$$1$$

### Example 2

The solver can also return an infinite discrete set of solutions:

```
S := solve(sin(x*PI/7) = 0, x)
```

$$\{7k \mid k \in \mathbb{Z}\}$$

To select the solutions in a particular finite interval, find the intersection of the solution set with the interval:

```
S intersect Dom::Interval(-22, 22)
```

$$\{-21, -14, -7, 0, 7, 14, 21\}$$

Alternatively, specify the interval when calling the solver. For example, compute the solutions in the interval `[- 22, 22]`:

```
solve(sin(x*PI/7) = 0, x = -22..22)
```

$$\{-21, -14, -7, 0, 7, 14, 21\}$$

delete S:

### Example 3

Use the `solve` function to solve inequalities. Typically, the solution set of an inequality is an interval on page 7-225 or a union of intervals:

`solve(x^2 > 5, x)`

$$(-\infty, -\sqrt{5}) \cup (\sqrt{5}, \infty)$$

### Example 4

Solve the following inequality. The solution includes the set of all complex numbers, excluding  $\sqrt{7}$  and  $-\sqrt{7}$ :

`solve(x^2 <> 7, x)`

$$\mathbb{C} \setminus \{\sqrt{7}, -\sqrt{7}\}$$

### Example 5

The solver can return a solution as a union of an infinite family of sets. The `solveLib::Union` function represents such infinite unions in MuPAD:

`solve(sin(x)*cos(x) > 1/4, x, Real)`

$$\bigcup_{k \in \mathbb{Z}} \left( \frac{\pi}{12} + \pi k, \frac{5\pi}{12} + \pi k \right)$$

## Example 6

If an equation contains symbolic parameters, the solver returns a piecewise on page 1-1275 (Symbolic Math Toolbox) solution. For example, solve the quadratic equation  $ax^2 + bx + c = 0$ :

```
S := solve(a*x^2 + b*x + c, x)
```

$$\left\{ \begin{array}{ll} \left\{ -\frac{b+\sigma_1}{2a}, -\frac{b-\sigma_1}{2a} \right\} & \text{if } a \neq 0 \\ \left\{ -\frac{c}{b} \right\} & \text{if } a = 0 \wedge b \neq 0 \\ \mathbb{C} & \text{if } a = 0 \wedge b = 0 \wedge c = 0 \\ \emptyset & \text{if } a = 0 \wedge b = 0 \wedge c \neq 0 \end{array} \right.$$

where

$$\sigma_1 = \sqrt{b^2 - 4ac}$$

Now, evaluate the solution assuming that  $a$  is not equal to 0:

```
assume(a <> 0): S
```

$$\left\{ -\frac{b + \sqrt{b^2 - 4ac}}{2a}, -\frac{b - \sqrt{b^2 - 4ac}}{2a} \right\}$$

```
delete S: unassume(a):
```

## Example 7

By default, the solver tries to find all possible solutions. The following inequality has both real and complex solutions. For example,  $x = \sqrt[4]{\frac{3}{4} + \frac{i}{2}}$  is one of the solutions. The solver cannot find a closed-form representation of all possible solutions:

```
solve(x + 1/x > 0, x)
```

$$\text{solve}\left(0 < x + \frac{1}{x}, x\right)$$

With the `Real` option, the solver computes only real solutions. The closed-form representation of all real solutions of that equation is an interval of all real numbers from 0 to infinity:

$$\text{solve}(x + 1/x > 0, x, \text{Real})$$

$$(0, \infty)$$

### Example 8

Solve this equation. By default, the solver returns a complete, but rather long and complicated solution:

$$\text{solve}(x^{(7/2)} + 1/x^{(7/2)} = 1, x)$$

$$\left\{ \frac{1}{\sigma_1}, \frac{1}{\sigma_2}, \frac{e^{\frac{4\pi i}{7}}}{\sigma_1}, \frac{e^{\frac{4\pi i}{7}}}{\sigma_2}, -\frac{e^{\frac{3\pi i}{7}}}{\sigma_1}, -\frac{e^{\frac{3\pi i}{7}}}{\sigma_2} \right\}$$

where

$$\sigma_1 = \left(\frac{1}{2} - \frac{\sqrt{3}i}{2}\right)^{2/7}$$

$$\sigma_2 = \left(\frac{1}{2} + \frac{\sqrt{3}i}{2}\right)^{2/7}$$

Using `IgnoreAnalyticConstraints`, you often can get simpler results:

$$\text{solve}(x^{(7/2)} + 1/x^{(7/2)} = 1, x, \text{IgnoreAnalyticConstraints})$$

$$\left\{ \frac{1}{\left(\frac{1}{2} - \frac{\sqrt{3}i}{2}\right)^{2/7}}, \frac{1}{\left(\frac{1}{2} + \frac{\sqrt{3}i}{2}\right)^{2/7}} \right\}$$



Using this option, you also can get wrong results:

```
solve(arcsin(x) = C, x, IgnoreAnalyticConstraints) assuming C > 10
```

$$\{\sin(C)\}$$

Always check the results obtained with this option:

```
testeq(arcsin(sin(C)), C)
```

$$\text{FALSE}$$

The IgnoreAnalyticConstraints option also can lead to incomplete results:

```
solve(x^(5/2) = 1, x)
```

$$\left\{1, -\frac{\sqrt{5}}{4} - \frac{1}{4} - \frac{\sqrt{2}\sqrt{5-\sqrt{5}}i}{4}, -\frac{\sqrt{5}}{4} - \frac{1}{4} + \frac{\sqrt{2}\sqrt{5-\sqrt{5}}i}{4}\right\}$$

```
solve(x^(5/2) = 1, x, IgnoreAnalyticConstraints)
```

$$\{1\}$$

## Example 9

With the IgnoreAnalyticConstraints option, the solver can multiply both sides of an equation by any expression, except 0. In the following example, the solver multiplies both sides of the equation by  $\sqrt{x}\sqrt{y}$ . The solver does not consider the special case  $x = y = 0$ :

```
solve(1/sqrt(x) = 1/sqrt(y), IgnoreAnalyticConstraints)
```

$$\{[x = z, y = z]\}$$

The result is not valid for  $x = y = 0$ .

## Example 10

When you solve a system of equations, MuPAD tries to represent the solutions as a set of lists of substitutions:

```
solve([x^2 + y = 1, x + y^2 = 1], [x, y])
```

$$\left\{ [x=0, y=1], [x=1, y=0], \left[ x = -\frac{\sqrt{5}}{2} - \frac{1}{2}, y = -\frac{\sqrt{5}}{2} - \frac{1}{2} \right], \left[ x = \frac{\sqrt{5}}{2} - \frac{1}{2}, y = \frac{\sqrt{5}}{2} - \frac{1}{2} \right] \right\}$$

If you use the `VectorFormat` option, MuPAD returns a solution as a set of vectors:

```
solve([x^2 + y = 1, x + y^2 = 1], [x, y], VectorFormat)
```

$$\left\{ \begin{pmatrix} 1 \\ 0 \end{pmatrix}, \begin{pmatrix} 0 \\ 1 \end{pmatrix}, \begin{pmatrix} -\frac{\sqrt{5}}{2} - \frac{1}{2} \\ -\frac{\sqrt{5}}{2} - \frac{1}{2} \end{pmatrix}, \begin{pmatrix} \frac{\sqrt{5}}{2} - \frac{1}{2} \\ \frac{\sqrt{5}}{2} - \frac{1}{2} \end{pmatrix} \right\}$$

Right sides of the returned substitutions can contain generated identifiers. In this case, substituting each of these identifiers with a complex number gives a solution of the system. You can obtain all solutions by substituting generated identifiers with all complex numbers:

```
sys:= [x + y + z = 2, x + y^2 + z^2 = 4]:
solve(sys, [x, y, z])
```

$$\{ [x = \frac{3}{2} - \sigma_1 - z1, y = \sigma_1 + \frac{1}{2}, z = z1], [x = \sigma_1 - z1 + \frac{3}{2}, y = \frac{1}{2} - \sigma_1, z = z1] \}$$

where

$$\sigma_1 = \frac{\sqrt{-4z1^2 + 4z1 + 9}}{2}$$

If you use the `VectorFormat` option, the solver returns a solution as an infinite set of vectors, in the usual mathematical notation:

`solve(sys, [x, y, z], VectorFormat); delete sys:`

$$\left\{ \left( \begin{array}{c} \sigma_1 - z1 + \frac{3}{2} \\ \frac{1}{2} - \sigma_1 \\ z1 \end{array} \right) \middle| z1 \in \mathbb{C} \right\} \cup \left\{ \left( \begin{array}{c} \frac{3}{2} - \sigma_1 - z1 \\ \sigma_1 + \frac{1}{2} \\ z1 \end{array} \right) \middle| z1 \in \mathbb{C} \right\}$$

where

$$\sigma_1 = \frac{\sqrt{-4z1^2 + 4z1 + 9}}{2}$$

## Example 11

You can specify the variable, for which you want to solve an equation, as a list of one entry. In this case, the solver returns the solution using the output format typically used for systems:

`solve(x = x, x), solve(x = x, [x])`

$$\mathbb{C}, \{[x = z]\}$$

## Example 12

If you do not specify indeterminates (the variables for which you want to solve an equation), the solver uses the set of all indeterminates that it can find in that equation:

`solve(x^2 = 3)`

$$\{[x = \sqrt{3}], [x = -\sqrt{3}]\}$$

The solver does not regard operators and indices as indeterminates. Therefore, the solver does not treat  $f$  and  $y$  as indeterminates in the following equation:

`solve(f(x[y]) = 7)`

$$\text{solve}([f(x_y) = 7], [x_y])$$

### Example 13

If you set an assumption on the variable for which you want to solve an equation, the solver returns only the results compatible with that assumption. For example, assume that  $x$  represents a real positive number. Then, solve the following equation:

```
assume(x, Type::Positive): solve(x^4 = 1, x)
```

```
{1}
```

Without that assumption, the solver returns all complex solutions:

```
unassume(x): solve(x^4 = 1, x)
```

```
{-1, 1, -i, i}
```

### Example 14

To obtain the multiplicities of the roots of a polynomial, use the `Multiple` option. For example, the polynomial  $x^3 + 2x^2 + x$  has two roots. The multiplicity of  $x = -1$  is 2. The multiplicity of  $x = 0$  is 1:

```
solve(x^3 + 2*x^2 + x, x, Multiple)
```

```
{[-1, 2], [0, 1]}
```

### Example 15

Suppose, you want to solve the following system of equations for two variables,  $x$  and  $y$ . Suppose, you want to avoid backward substitutions while solving this system. To disable backward substitutions, use the option `BackSubstitution = FALSE`. Specify the list of variables so that  $x$  appears to the right of  $y$ . Now, the solution for the variable  $y$  can contain the variable  $x$ :

```
solve({x^2 + y = 1, x - y = 2}, [y, x], BackSubstitution = FALSE)
```

```
{[y = x - 2, x = - $\frac{\sqrt{13}}{2}$  -  $\frac{1}{2}$ ], [y = x - 2, x =  $\frac{\sqrt{13}}{2}$  -  $\frac{1}{2}$ ]}
```

```
solve({x^2 + y = 1, x - y = 2}, {x, y})
```

$$\left\{ \left[ x = -\frac{\sqrt{13}}{2} - \frac{1}{2}, y = -\frac{\sqrt{13}}{2} - \frac{5}{2} \right], \left[ x = \frac{\sqrt{13}}{2} - \frac{1}{2}, y = \frac{\sqrt{13}}{2} - \frac{5}{2} \right] \right\}$$

If MuPAD cannot express the result as a set of lists, then `BackSubstitution` has no effect:

```
solve({x^2 + y = 1, x - y = 2}, [y, x],
BackSubstitution = FALSE, MaxDegree = 1)
```

$$\left( \frac{y}{x} \right) \in \left\{ \left( \frac{x-2}{z1} \right) \mid z1 \in \text{RootOf}(z^2 + z - 3, z) \right\}$$

## Example 16

If the input contains floating-point numbers, MuPAD uses the symbolic solver `solve`, and then calls the `float` function for the obtained solution:

```
solve(x^3 + 3.0*x + 1, x)
```

$$\{-0.3221853546, 0.1610926773 + 1.75438096 i, 0.1610926773 - 1.75438096 i\}$$

If the symbolic solver fails to solve such equation or system, MuPAD calls the numeric solver `numeric::solve`:

```
solve({sin(x) + 1/2*cos(sqrt(2)*y) = 1, cos(x) + sin(y) = 0.1}, {x, y})
```

$$\{[x = 0.7780082473, y = -0.6589827125]\}$$

The numeric solver can return an incomplete set of solutions. For details, see the `numeric::solve` help page.

## Example 17

If a numerator contains a factored polynomial with the multiplicities greater than 1, the solutions might give zeros in a denominator:

```
solve((x - 1)^2/(x - 1) = 0, x)
```

$\{1\}$

To eliminate these solutions, expand a numerator:

```
f := expand((x - 1)^2): solve(f/(x - 1) = 0, x)
```

$\emptyset$

### Example 18

You can use the `solve` function to solve Diophantine equations. For example, solve the following linear Diophantine equation:

```
S := solve(30*x + 56*y = 2, [x, y], Domain = Z_)
```

$$\begin{pmatrix} x \\ y \end{pmatrix} \in \left\{ \begin{pmatrix} -28k - 13 \\ 15k + 7 \end{pmatrix} \mid k \in \mathbb{Z} \right\}$$

### Example 19

You can use the `solve` function to solve equation given in the form of memberships. For example, solve the following equation:

```
solve(x^2 in Z_, x)
```

$$\{\sqrt{k} \mid k \in \mathbb{Z}\} \cup \{-\sqrt{k} \mid k \in \mathbb{Z}\}$$

### Example 20

You can solve an equation with symbolic parameters, thus finding its general solution. Then you can evaluate the solution for any particular values of parameters or plot the solution with respect to the parameter values.

Solve this equation:

```
S := solve(x^5 + a = 1, x, Real)
```

$$\left\{ -|a-1|^{1/5} \operatorname{sign}(a-1) \right\}$$

Plot the result for the values  $-10 < a < 10$ :

```
plot(S, a = -10..10)
```

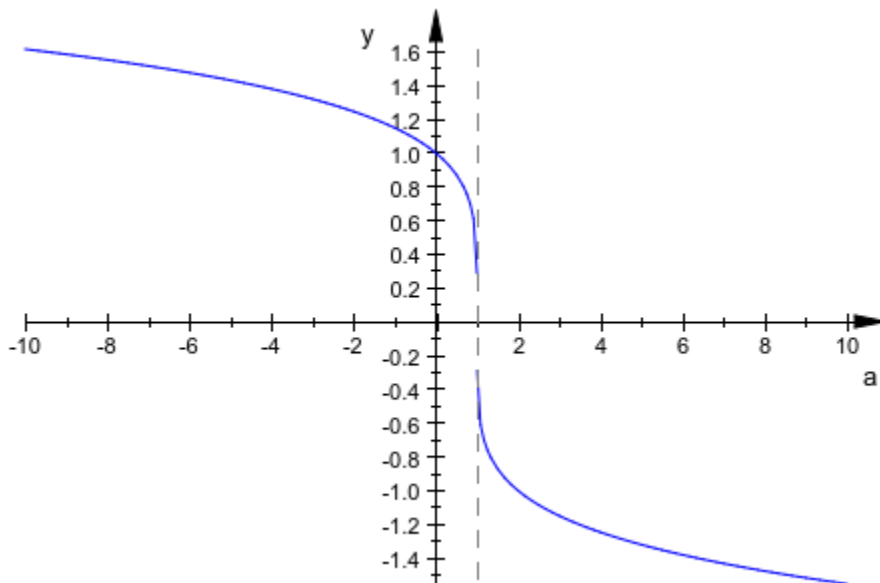

Evaluate the result for  $a = 5$  using the operator `|` or its functional form `evalAt`:

```
S | a = 5
```

$$\left\{ -4^{1/5} \right\}$$

Approximate the result with a floating-point value using `float`:

```
float(%)
```

$\{-1.319507911\}$

## Parameters

### **eq**

A single equation or an inequality of type "`_equal`", "`_less`", "`_leequal`", or "`_unequal`", or an equation in the form of membership (`_in`). Alternatively, any Boolean expression composed of equations or inequalities by the operators "`_and`", "`_or`", and "`_not`". Also, the solver accepts an arithmetical expression (Symbolic Math Toolbox) and regards such expression as an equation without the right side. (Internally, the solver assumes that the right side is equal to 0.)

### **x**

The indeterminate for which you solve an equation, an inequality of a system: an identifier on page 7-29 or an indexed identifier on page 1-1017

### **a, b**

Arithmetical expressions (Symbolic Math Toolbox)

### **vars**

A nonempty set or list of indeterminates for which you solve an equation, an inequality, or a system

### **eqs**

A set, list, array, or table of equations, inequalities, arithmetical expressions, or any combination of these objects. The solver regards expressions as equations without the right side. (Internally, the solver assumes that the right side is equal to 0.)

### **ODE**

An ordinary differential equation: an object of the `ode` type.

### **REC**

A recurrence equation: an object of the `rec` type.



## Options

### MaxDegree

Option, specified as `MaxDegree = n`

Do not use explicit formulas that involve radicals when solving polynomial equations of degree larger than  $n$ . Here  $n$  is a positive integer. By default,  $n = 2$ .

This option enables and disables the use of explicit formulas for the roots of polynomials. This option does not affect other methods, such as factorization. For polynomial equations, the given maximal degree  $n$  refers to the factors of the polynomials, not to the input polynomial.

When you solve a fifth- or higher-order polynomial equation, the solver might be unable to return the solution explicitly. In general, there are no explicit expressions for the roots of polynomials of degrees higher than 4. Setting the `MaxDegree` option to 4 or a higher value makes no difference.

### BackSubstitution

Option, specified as `BackSubstitution = b`

Enable or disable backward substitutions when solving algebraic systems. The value  $b$  must be `TRUE` or `FALSE`. By default,  $b = \text{TRUE}$ .

`BackSubstitution` only affects the results returned as sets of lists.

### Multiple

With this option, `solve` returns a set of type `Dom::Multiset`, indicating the multiplicity of polynomial roots.

The solver ignores this option if the input is not a polynomial expression or equation, or if the solution is of the `RootOf` type.

### VectorFormat

Return a set of vectors when solving a system of equations for a list of variables.

## PrincipalValue

With this option, the solver returns only one solution. The solver returns this solution as a set with one element. If an equation does not have a solution, the solver returns an empty set.

If the solver cannot find any solution and cannot prove that solutions do not exist, it returns an unresolved symbolic call to `solve`. For example, if the set of solutions is a piecewise on page 1-1275 (Symbolic Math Toolbox) function, and there are no elements that belongs to all cases, the solver cannot find a solution.

You also can use this option to solve equations for more than one variable. In this case, the solver returns a set that contains one list. This nested structure represents a solution vector.

## Domain

Option, specified as `Domain = d`

Return the set of all solutions that are elements of `d`. Here `d` must represent a subset of the complex numbers (for example, real numbers `Dom::Real` or integers `Dom::Integer`). Alternatively, `d` can be a domain over which you can factor polynomials (for example, `d` can be a finite field). In this case, you can use this option only when solving polynomial equations. Without this option, the solver returns all solutions in the set of complex numbers.

You can solve an equation or a system over the following domains:

- Subsets of the set of complex numbers `C_`.
- Domains over which you can factor polynomials. You can use these domains only when solving polynomial equations.

A subset of `C_` is any kind of set returned by `solve`. Instead of `C_`, `R_`, `Q_`, and `Z_`, you also can use the corresponding domains of the domains package `Dom::Complex`, `Dom::Real`, `Dom::Rational`, and `Dom::Integer`.

You can overload the solver for your custom domains by adding the `domsolve` method to those domains. If this method does not exist, MuPAD uses the `solve_eq` method to solve equations. The `solve_eq` method does not accept systems as arguments. Finally, if the `solve_eq` method does not exist, MuPAD uses the `solve_poly` method to solve polynomials. The `solve_poly` method accepts only polynomials as first arguments. This

method regards any first argument of `solve` that cannot be converted to a polynomial as illegal.

The calling syntax for the `domsolve`, `solve_eq`, and `solve_poly` methods is `domsolve(eq, var, options)`. Here `var` is the same argument as in `solve`, and `options` is a table of options. For the `domsolve` method, `eq` is also the same as in `solve`. For the `solve_eq` method, `eq` must be an arithmetical expression. For `solve_poly`, `eq` must be a polynomial on page 1-1601.

You cannot solve equations and systems in more than one variable over domains.

### **IgnoreProperties**

Include solutions that are not consistent with the properties of the variable `x`.

### **Real**

Return only the solutions for which every subexpression of `eq` represents a real number. Also, assume that every subexpression independent of `x` represents a real number.

With this option, the solver assumes that every subexpression independent of `x` represents a real number. In particular, the solver assumes that all symbolic parameters are real. When you use `Real`, the solver returns only the solutions for which every subexpression of `eq` is real. See “Example 7” on page 1-1997 (Symbolic Math Toolbox).

When you use this option, MuPAD restricts the domain of every function to real numbers. For example, it does not support the logarithms of negative numbers. For all returned solutions `x`, the input is defined over the real numbers.

This option is particularly useful for solving inequalities. Inequalities hold only when both sides represent real values.

This option does not affect some systems.

### **IgnoreSpecialCases**

If a solution requires case analysis, ignore cases for which one or more parameters in the equation are supposed to be an element of a comparatively small set (for example, with this option, MuPAD can ignore a membership in a fixed finite set or a set of integers  $\mathbb{Z}$ ).

With this option, the solver tries to reduce the number of branches in piecewise on page 1-1275 (Symbolic Math Toolbox) objects. MuPAD finds equations and memberships in

comparatively small sets. First, MuPAD tries to prove such equations and memberships by using the property mechanism. If the property mechanism proves an equation or a membership is true, MuPAD keeps that statement. Otherwise, MuPAD can replace that statement with the value FALSE. For example, if the property mechanism cannot prove that a denominator is equal to zero, MuPAD regards this denominator as nonzero. This option can significantly reduce the number of piecewise objects in a solution.

### **IgnoreAnalyticConstraints**

Apply purely algebraic simplifications to expressions and equations. With this option, the solver applies the following rules to the expressions on both sides of an equation:

- $\ln(a) + \ln(b) = \ln(ab)$  for all values of  $a$  and  $b$ . In particular:

$$(ab)^c = e^{c \ln(ab)} = e^{c(\ln(a) + \ln(b))} = a^c b^c \text{ for all values of } a, b, \text{ and } c.$$

- $\ln(a^b) = b \ln(a)$  for all values of  $a$  and  $b$ . In particular:

$$(a^b)^c = e^{bc \ln(a)} = e^{\ln(a)^{bc}} = a^{bc} \text{ for all values of } a, b, \text{ and } c.$$

- If  $f$  and  $g$  are standard mathematical functions and  $f(g(x)) = x$  for all small positive numbers,  $f(g(x)) = x$  is assumed to be valid for all complex  $x$ . In particular:

- $\ln(e^x) = x$ .
- $\arcsin(\sin(x)) = x$ ,  $\arccos(\cos(x)) = x$ ,  $\arctan(\tan(x)) = x$ .
- $\operatorname{arcsinh}(\sinh(x)) = x$ ,  $\operatorname{arccosh}(\cosh(x)) = x$ ,  $\operatorname{arctanh}(\tanh(x)) = x$ .
- $W_k(x e^x) = x$  for all values of  $k$ .

- The solver can multiply both sides of an equation by any expression except 0.
- The solutions of polynomial equations must be complete.

Using this option, you can get simpler solutions for equations for which the direct call of the solver returns complicated results. Note that with this option the solver does not verify the correctness and completeness of the result. See “Example 8” on page 1-1998 (Symbolic Math Toolbox) and “Example 9” on page 1-1999 (Symbolic Math Toolbox).

### **DontRewriteBySystem**

Do not transform an equation to an equivalent system of equations. This option decreases the running time. With this option, the solver cannot solve some equations.

This option does not allow the solver to replace an equation with the equivalent system of equations. Typically, MuPAD replaces an equation by an equivalent system of equations when solving equations with nested roots. Solving the resulting system can be slow. Use this option to improve performance of the solver. When you use `DontRewriteBySystem`, the solver cannot solve some of the equations that it can solve without this option.

### **NoWarning**

Suppress all warning messages.

## **Return Values**

If  $x$  is an identifier, `solve(eq, x)` returns an object that represents a mathematical set (see the “Details” section). If  $x$  is a set or a list, or if you omit  $x$ , a call to `solve` returns a set of lists. Each list consists of equations. The left side of each equation is one of the variables for which you solve an equation, an inequality of a system. In this case, `solve` also can return an expression of the form  $x \text{ in } S$ , where  $x$  is a list of variables, and  $S$  is a set of vectors. When you solve a system providing the list of variables and the `VectorFormat` option, the solver returns a set of vectors.

## **Overloaded By**

`eq`

## **See Also**

### **MuPAD Functions**

`RootOf` | `isolate` | `linsolve` | `numeric::linsolve` | `numeric::solve`

### **Topics**

“Solve Algebraic Equations and Inequalities” (Symbolic Math Toolbox)

“Solve Algebraic Systems” (Symbolic Math Toolbox)

“Solve Ordinary Differential Equations and Systems” (Symbolic Math Toolbox)

## sort

Sort a list

### Syntax

```
sort(list, <f>)
```

### Description

`sort(list)` returns a sorted copy of the list.

`sort` sorts the list in ascending order.

If you do not specify a procedure `f`, the `sort` command uses the following rules for sorting the lists:

- The command sorts a list of real numbers (`Type::Real`) numerically.
- The command sorts a list of character strings alphabetically.
- The command sorts an outer list containing inner lists with numeric first entries by these numeric first entries. See “Example 4” on page 1-2015 (Symbolic Math Toolbox).
- In all other cases, the command sorts a list according to the internal order: `sort(list)` is equivalent to `sort(list, sysorder)`. All MuPAD sessions use the same internal order. Between different versions of MuPAD, internal order might change.

When you sort strings, uppercase letters have a preference over lowercase letters. For example, `Z` appears before `abc`.

You can specify a procedure `f` to define the sorting criteria. `sort` calls the procedure `f` for every pair of the entries of the list. `f` must return a Boolean expression that the `bool` command can evaluate to `TRUE` or `FALSE`. If for the pair of entries the procedure `f(x, y)` returns `TRUE`, the sorted list displays `x` to the left of `y`. Otherwise, `x` appears to the right of `y`. The entries of the sorted list `L := sort(list, f)` satisfy `bool(f(L[i], L[j])) = TRUE` for `i < j`.

If two entries of a list are equal by the sorting criteria `f`, the `sort` command can swap these entries. For example, if you sort polynomials by their degrees, the `sort` command can return the polynomials with the same degree in the order different from their order in the input.

`sort` can be overloaded by kernel domains (Symbolic Math Toolbox). For example, use the function `DOM_SET::sort` to sort sets on page 7-50. See “Example 3” on page 1-2014 (Symbolic Math Toolbox)

The average runtime to sort a list containing  $n$  entries is  $O(n \log(n))$ .

## Examples

### Example 1

The `sort` command sorts real numbers (type `Type::Real`) numerically:

```
sort([4, -1, 2/3, 0.5])
```

$$\left[-1, 0.5, \frac{2}{3}, 4\right]$$

The `sort` command sorts strings alphabetically:

```
sort(["chip", "alpha", "Zip"])
```

$$["Zip", "alpha", "chip"]$$

If a list contains other types of objects the `sort` command sorts a list according to the internal order. The command also applies internal order to sort the lists with mixed types of entries:

```
sort([4, -1, 2/3, 0.5, "alpha"])
```

$$\left[-1, 0.5, \frac{2}{3}, 4, \text{"alpha"}\right]$$

```
sort([4, -1, 2/3, 0.5, I])
```

```
[-1, 0.5, 2/3, 4, i]
```

## Example 2

Define your own criteria to sort a list. For example, sort the entries by their absolute values:

```
sort([-2, 1, -3, 4], (x, y) -> abs(x) < abs(y))
```

```
[1, -2, -3, 4]
```

## Example 3

When sorting sets, the `sort` command returns a list as a result:

```
sort({3, 12, 5, 30, 6, 43})
```

```
[3, 5, 6, 12, 30, 43]
```

The sorted set is equivalent to the corresponding sorted list:

```
bool(sort({3, 12, 5, 30, 6, 43}) = sort([3, 12, 5, 30, 6, 43]))
```

```
TRUE
```

To sort other data types, implement a `sort-slot` for them:

```
unprotect(DOM_INT):  
DOM_INT::sort :=  
proc(n)  
  local str, i;  
begin  
  str := expr2text(n);  
  text2expr(_concat(op(sort([str[i] $ i = 1..length(str)]))))  
end:  
sort(1703936)
```



133679

```
delete DOM_INT::sort: protect(DOM_INT):
```

## Example 4

If the list contains lists as entries, and all the inner lists start with numbers, the `sort` command uses these numbers to sort the outer list:

```
sort([[10 - i, i*x^i] $ i = 1..9])
```

```
[[1, 9 x^9], [2, 8 x^8], [3, 7 x^7], [4, 6 x^6], [5, 5 x^5], [6, 4 x^4], [7, 3 x^3], [8, 2 x^2], [9, x]]
```

Compare the sorted list with the internal order of its entries:

```
sort([[10 - i, i*x^i] $ i = 1..9], sysorder)
```

```
[[8, 2 x^2], [7, 3 x^3], [6, 4 x^4], [5, 5 x^5], [4, 6 x^6], [3, 7 x^7], [2, 8 x^8], [1, 9 x^9], [9, x]]
```

## Parameters

### **list**

A list on page 7-41 of arbitrary MuPAD objects

### **f**

A procedure on page 1-1654 defining the ordering

## Return Values

List.

## **Overloaded By**

list

## **See Also**

### **MuPAD Functions**

prog::sort | sysorder

# split

Split an object

## Syntax

```
split(object, f, <p1, p2, ...>)
```

## Description

`split(object, f)` splits the object into a list of three objects. The first list entry is an object consisting of those operands of the input object that satisfy a criterion defined by the procedure `f`. The second list entry is built from the operands that violate the criterion. The third list entry is built from the operands for which it is unknown whether the criterion is satisfied.

The function `f` must return a value that can be evaluated to one of the Boolean values `TRUE`, `FALSE`, or `UNKNOWN`. It may either return one of these values directly, or it may return an equation or an inequality that can be simplified to one of these values by the function `bool`.

The function `f` is applied to all operands on page 1-1493x of the input object via the call `f(x, p1, p2, ...)`. Depending on the result `TRUE`, `FALSE`, or `UNKNOWN`, this operand is inserted into the first, the second, or the third output object, respectively.

The output objects are of the same type as the input object, i.e., a list is split into three lists, a set into three sets, a table into three tables etc.

If the input object is an expression sequence, then neither the input sequence nor the output (a list containing three sequences) are flattened (Symbolic Math Toolbox).

Also “atomic” objects such as numbers or identifiers can be passed to `split` as first argument. Such objects are handled like sequences with a single operand.

## Examples

### Example 1

The following command checks which of the integers in the list are prime:

```
split([1, 2, 3, 4, 5, 6, 7, 8, 9, 10], isprime)
```

```
[[2, 3, 5, 7], [1, 4, 6, 8, 9, 10], []]
```

The return value is a list of three lists. The first list contains the prime numbers, the second list contains all other numbers. The third list is empty, because for any number of the input list, it can be decided whether it is prime or not.

### Example 2

With the optional arguments `p1`, `p2`, ... one can use functions that need more than one argument. For example, `contains` is a handy function to be used with `split`. The following call splits a list of sets into those sets that contain `x` and those that do not:

```
split([a, x, b], [a], [1, x], contains, x)
```

```
[[a, b, x], [1, x], [a], []]
```

The elements of the returned list are of type `DOM_LIST`, because the given expression was a list. If the given expression is of another type, e.g., `DOM_SET`, also the elements of the result are of type `DOM_SET`, too:

```
split({a, x, b}, {a}, {1, x}, contains, x)
```

```
[[{1, x}, {a, b, x}], {{a}}, ∅]
```

### Example 3

We use the function `is` to split an expression sequence on page 1-88 into sub-sequences. This function returns `UNKNOWN` if it cannot derive the queried property:

```
split((-2, -1, a, 0, b, 1, 2), is, Type::Positive)
```

```
[1, 2, -2, -1, 0, a, b]
```

## Example 4

We split a table of people marked as male or female:

```
people := table("Tom" = "m", "Rita" = "f", "Joe" = "m"):
[male, female, dummy] := split(people, has, "m"):
```

male

"Joe"	"m"
"Tom"	"m"

female

"Rita"	"f"
--------	-----

dummy

└

```
delete people, male, female, dummy:
```

## Parameters

### object

A list on page 7-41, a set on page 7-50, a table on page 1-2103, an expression sequence on page 1-88, or an expression of type DOM\_EXPR

### f

A procedure returning a Boolean value on page 1-2180

**p1, p2, ...**

Any MuPAD objects accepted by `f` as additional parameters

## **Return Values**

List with three objects of the same type as the input object.

## **Overloaded By**

object

## **See Also**

### **MuPAD Functions**

`map` | `op` | `select` | `zip`

# sqrt

Square root function

## Syntax

`sqrt(z)`

## Description

`sqrt(z)` represents the square root of  $z$ .

$x = \sqrt{z}$  represents the solution of  $x^2 = z$  that has a nonnegative real part. In particular, it represents the positive root for real positive  $z$ . For real negative  $z$ , it represents the complex root with positive imaginary part.

A floating-point result is returned for floating-point arguments. Note that the branch cut is chosen as the negative real semi-axis. The values returned by `sqrt` jump when crossing this cut. Cf. “Example 2” on page 1-2022 (Symbolic Math Toolbox).

Certain simplifications of the argument may occur. In particular, positive integer factors are extracted from some symbolic products. Cf. “Example 3” on page 1-2023 (Symbolic Math Toolbox).

Note that  $\sqrt{z}$  cannot be simplified to  $x$  for all complex numbers (e.g.,  $\sqrt{x^2} = -x$  for real  $x < 0$ ). Cf. “Example 4” on page 1-2023 (Symbolic Math Toolbox).

Mathematically, `sqrt(z)` coincides with  $z^{1/2} = \text{\_power}(z, 1/2)$ . However, `sqrt` provides more simplifications than `\_power`. Cf. “Example 5” on page 1-2023 (Symbolic Math Toolbox).

## Environment Interactions

When called with a floating-point argument, the function is sensitive to the environment variable `DIGITS` which determines the numerical working precision.

## Examples

### Example 1

We demonstrate some calls with exact and symbolic input data:

`sqrt(2), sqrt(4), sqrt(36*7), sqrt(127)`

$$\sqrt{2}, 2, 6\sqrt{7}, \sqrt{127}$$

`sqrt(1/4), sqrt(1/2), sqrt(3/4), sqrt(25/36/7), sqrt(4/127)`

$$\frac{1}{2}, \frac{\sqrt{2}}{2}, \frac{\sqrt{3}}{2}, \frac{5\sqrt{7}}{42}, \frac{2\sqrt{127}}{127}$$

`sqrt(-4), sqrt(-1/2), sqrt(1 + I)`

$$2i, \frac{\sqrt{2}i}{2}, \sqrt{1+i}$$

`sqrt(x), sqrt(4*x^(4/7)), sqrt(4*x/3), sqrt(4*(x + I))`

$$\sqrt{x}, 2x^{2/7}, \sqrt{\frac{4x}{3}}, 2\sqrt{x+i}$$

### Example 2

Floating point values are computed for floating-point arguments:

`sqrt(1234.5), sqrt(-1234.5), sqrt(-2.0 + 3.0*I)`

$$35.13545218, 35.13545218i, 0.8959774761 + 1.674149228i$$

A jump occurs when crossing the negative real semi axis:

`sqrt(-4.0), sqrt(-4.0 + I/10^100), sqrt(-4.0 - I/10^100)`



$$2.0 i, 2.5 10^{-101} + 2.0 i, 2.5 10^{-101} - 2.0 i$$

### Example 3

The square root of symbolic products involving positive integer factors is simplified:

`sqrt(20*x*y*z)`

$$2 \sqrt{5} \sqrt{x y z}$$

### Example 4

Square roots of squares are not simplified, unless the argument is real and its sign is known:

`sqrt(x^2*y^4)`

$$\sqrt{x^2 y^4}$$

`assume(x > 0): sqrt(x^2*y^4)`

$$x \sqrt{y^4}$$

`assume(x < 0): sqrt(x^2*y^4)`

$$-x \sqrt{y^4}$$

### Example 5

`sqrt` provides more simplifications than the `_power` function:

`sqrt(4*x), (4*x)^(1/2) = _power(4*x, 1/2)`

$$2 \sqrt{x}, \sqrt{4x} = \sqrt{4x}$$

## Parameters

`z`

An arithmetical expression (Symbolic Math Toolbox)

## Return Values

Arithmetical expression.

## Overloaded By

`z`

## See Also

### MuPAD Functions

`_power` | `isqrt` | `numlib::issqr` | `surd`

# strmatch

Match pattern in character string

## Syntax

```
strmatch(text, pattern, <Index>, <ReturnMatches>, <All>)
```

## Description

`strmatch(text, pattern)` checks whether `text` matches the regular expression `pattern`.

`strmatch` performs regular expression matching on strings, via the ICU library. The pattern can contain wildcards forming a perl-compatible regular expression. In these expressions, most characters represent themselves. For example, "a" matches "a". For the list of exceptions, see "Algorithms" on page 1-2038 (Symbolic Math Toolbox).

The library `stringlib` provides more functions for handling strings. For details, see "Operations on Strings" (Symbolic Math Toolbox).

## Examples

### Example 1

Most characters simply match themselves:

```
s := "Hamburg": strmatch(s, "Hamburg")
```

**TRUE**

`strmatch` typically matches substrings:

```
strmatch(s, "Ham"), strmatch(s, "burg")
```

TRUE, TRUE

```
strmatch("Ham", "Hamburg")
```

FALSE

delete s:

## Example 2

A dot (.) is a placeholder for any character except "\n":

```
strmatch("abcd", "a.c"), strmatch("ab\ncd", "ab.")
```

TRUE, FALSE

To match an actual dot, use "\\ .":

```
strmatch("abcd", "a\\.c"),  
strmatch("a.cd", "a\\.c")
```

FALSE, TRUE

A dot, like all special characters, has its special role only in the second argument of `strmatch`:

```
strmatch("a.c", "abc")
```

FALSE

With the `s` modifier, you can use a dot to match newlines:

```
strmatch("abcd", "(?s)a.c"), strmatch("ab\ncd", "(?s)ab.")
```

TRUE, TRUE

A dot matches only a single character:

```
strmatch("abcd", "a.d"), strmatch("abcd", "a.b")
```

```
FALSE, FALSE
```

### Example 3

By default, `strmatch` only checks for a match and returns a Boolean value:

```
strmatch("aaaba", "a"), strmatch("aaaba", "c")
```

```
TRUE, FALSE
```

To return the first place where a match occurs, use `Index`:

```
strmatch("aaaba", "a", Index),  
strmatch("aaaba", "c", Index)
```

```
[1, 1], FALSE
```

To return the matched substrings, use `ReturnMatches`. This option is helpful when you match complicated expressions.

```
strmatch("aaaba", "a", ReturnMatches),  
strmatch("aaaba", "c", ReturnMatches)
```

```
"a", FALSE
```

To find more than one match, use `All`:

```
strmatch("aaaba", "a", All),  
strmatch("aaaba", "c", All)
```

```
{"a"}, ∅
```

This expression has several matches because a dot matches any character:

```
strmatch("aaaba", "a.", All)
```

```
 {"aa", "ab"}
```

All implies ReturnMatches unless you also use Index:

```
strmatch("aaaba", "a", All, Index)
```

```
 {[1, 1], [2, 2], [3, 3], [5, 5]}
```

Combine all three options:

```
strmatch("aaaba", "a", All, Index, ReturnMatches)
```

```
 {[1, 1, "a"], [2, 2, "a"], [3, 3, "a"], [5, 5, "a"]}
```

## Example 4

By default, `strmatch` matches substrings. To look only for matches at the beginning and end of the string, use the caret (^) and dollar (\$) characters, respectively:

```
strmatch("abcd", "a"),  
strmatch("abcd", "c"),  
strmatch("abcd", "d"),  
strmatch("abcd", "abcd")
```

```
 TRUE, TRUE, TRUE, TRUE
```

```
strmatch("abcd", "^a"),  
strmatch("abcd", "^c"),  
strmatch("abcd", "^d"),  
strmatch("abcd", "^abcd")
```

```
 TRUE, FALSE, FALSE, TRUE
```

```
strmatch("abcd", "a$"),  
strmatch("abcd", "c$"),  
strmatch("abcd", "d$"),  
strmatch("abcd", "abcd$")
```

FALSE, FALSE, TRUE, TRUE

```
strmatch("abcd", "^a$"),  
strmatch("abcd", "^c$"),  
strmatch("abcd", "^d$"),  
strmatch("abcd", "^abcd$")
```

FALSE, FALSE, FALSE, TRUE

Using the `m` modifier, you can change the meaning from the beginning or end of a string to the beginning or end of a line:

```
s := "ab\n cd":  
strmatch(s, "b$"),  
strmatch(s, "(?m)b$")
```

FALSE, TRUE

## Example 5

Specify alternative patterns to match by using the vertical bar (`|`):

```
strmatch("abcd", "abc|xyz")
```

TRUE

```
strmatch("abcd", "a|f|j")
```

TRUE

`strmatch` treats all characters between the vertical bars as one of the alternative patterns. To limit the extent of alternatives, use parentheses:

```
strmatch("abcd", "ab(c|xy)z"),  
strmatch("abcd", "ab(c|xy)(z|d)")
```

FALSE, TRUE

When you use the `ReturnMatches` option, `strmatch` returns the substrings matched by each pair of parentheses:

```
strmatch("abcd", "ab(c|xy)(z|d)", ReturnMatches)

["abcd", "c", "d"]
```

With alternatives, `strmatch` can find several matches:

```
strmatch("abracadabra", "a(b|c|d)", All)

{"ab", "b", ["ac", "c"], ["ad", "d"]}
```

To group alternatives without returning matches, use `(?:...)`:

```
strmatch("abracadabra", "a(?:b|c|d)", All)

{"ab", "ac", "ad"}
```

To match for the characters `|`, `(`, and `)`, use `\\` before the character when you specify the pattern to match:

```
strmatch("ab(c)d", "\\((c|d)\\)", ReturnMatches)

["(c)", "c"]
```

## Example 6

Use a question mark (`?`) to indicate that a subexpression (a single character or a group of characters in parentheses or brackets) is optional:

```
strmatch("abcd", "abc?d"),
strmatch("abd", "abc?d")

TRUE, TRUE
```

Use an asterisk (`*`) to indicate that a subexpression can be repeated an arbitrary number of times, including zero:



```
strmatch("abcd", "a.*d"),
strmatch("abcd", "a.*c")
```

TRUE, TRUE

Use a plus sign (+) to indicate that a subexpression can be repeated an arbitrary number of times, excluding zero:

```
strmatch("abcd", "a.+d"),
strmatch("abcd", "a.+b")
```

TRUE, FALSE

When you use the asterisk or the plus sign in the pattern to match, `strmatch` finds the first match going from left to right, and then returns the longest substring that satisfies the matching pattern:

```
strmatch("abracadabra", "a.*a", ReturnMatches)
```

"abracadabra"

By appending another question mark, you can switch the asterisk and plus sign to “non-greedy” matching:

```
strmatch("abracadabra", "a.*?a", ReturnMatches)
```

"abra"

This does not return the shortest match (which would have been "aca" or "ada"). The call returns the first match looking from left to right from the starting position.

## Example 7

Use curly braces to specify a number of repetitions of a subexpression:

```
strmatch("abracadabra", "(a(b|c|d)){2}"),
strmatch("abracadabra", "(a(b|c|d)){3}"),
strmatch("abracadabra", "(a(b|c|d)){4}")
```

TRUE, TRUE, FALSE

These repetitions must be adjacent:

```
strmatch("abracadabra", "(abr){2}")
```

FALSE

To get nonadjacent repetitions, use ".\*". This combination means "anything without newlines".

```
strmatch("abracadabra", "(abr.*){2}")
```

TRUE

## Example 8

To indicate a range of possible repetitions, use a comma inside curly braces. For example, select the expressions representing binary numbers with three to five digits:

```
select(["11001", "1100111", "11", "11021"], strmatch, "^(0|1){3,5}$")
```

["11001"]

Here {3, 5} specifies the range. You can omit the second number to remove the upper bound. For example, {3, } indicates that there must be three or more repetitions.

The following regular expression checks whether there is an "a" followed by at least three letters "b" followed by a "c" somewhere in the input string:

```
strmatch("abcd", "ab{3,}c"),  
strmatch("abbbcd", "ab{3,}c"),  
strmatch("abcdabbbc", "ab{3,}c")
```

FALSE, TRUE, TRUE

By default, when `strmatch` looks for repetitions, it returns the longest matching substring. Use a question mark to return the first match instead of the longest one:

```
strmatch("abcdabcdabcd", "a.{2,8}d", ReturnMatches),
strmatch("abcdabcdabcd", "a.{2,8}?d", ReturnMatches)
```

```
"abcdabcd", "abcd"
```

## Example 9

Characters enclosed in brackets ([ ]) form a "character class", which matches any of the characters in the class. This behavior is similar to an alternation between these characters.

```
strmatch("abc", "ab[cde]"),
strmatch("abd", "ab[cde]"),
strmatch("aba", "ab[cde]")
```

```
TRUE, TRUE, FALSE
```

Inside character classes, special characters are completely different. Dots, asterisks, plus and dollar signs, parentheses, and curly braces match themselves, but a character class starting with a caret is "negated" and matches any character *not* listed:

```
strmatch("abcd", "[^ab]", All)
```

```
{"c", "d"}
```

If a caret is not the first character in a class, then it represents itself:

```
strmatch("x^2", "[*^]2")
```

```
TRUE
```

If a dash (-) is not the first character in a class (apart from the caret), then it specifies a range of characters. Thus, to find a number with at least five digits, you can specify the pattern as follows:

```
strmatch("x = 123456...", "[0-9]{5,}", ReturnMatches)
```

```
"123456"
```

The exact meaning of a range depends on the language settings of your computer. Technically, it depends on the "collating", which can be different for the same language on different versions of the same operating system. For example, "[a-z]" can match only lowercase ASCII characters on one computer, while on the second one it also matches the uppercase characters from A through Y, and on the third one includes the uppercase characters from B through Z. For this reason, the best practice is using the named character classes instead:

```
strmatch("some words", "[[:word:]]+", All)

{"some", "words"}
```

## Example 10

Some character classes have a short form, such as "\\x", where x is w, W, s, S, d, or D. The uppercase letters mean the negation of the lowercase letters.

```
strmatch("abcd", "\\w"),
strmatch("abcd", "\\W"),
strmatch("abcd", "\\d"),
strmatch("abcd", "\\D")

TRUE, FALSE, FALSE, TRUE
```

Here, negation means that a character does not match whatever is negated:

```
strmatch("abcd 1", "\\w"),
strmatch("abcd 1", "\\W"),
strmatch("abcd 1", "\\d"),
strmatch("abcd 1", "\\D")

TRUE, TRUE, TRUE, TRUE
```

Use "\\b" to look for words starting with an a. The pattern "\\b" is a zero-width expression matching the place between a "word" and the spaces surrounding it (or the beginning and end of string).

```
strmatch("abc cbd cba (aa) b", "\\ba\\w*", All)
```

```
{ "aa", "abc" }
```

You can also use "\\b" to match the end of a word:

```
strmatch("abc cbd cba (aa) b", "\\w*a\\b", All)
```

```
{ "aa", "cba" }
```

## Example 11

You can change the behavior of `strmatch` with modifier flags. For example, the `i` modifier enables case-insensitive matching. (The precise effects of case-insensitive matching depend on your language settings, for example, most English computers do not treat the German umlauts `ä` and `Ä` as being the same up to case.) To enable case-insensitive matching for the whole expression, prefix it with "(?i)":

```
strmatch("ABC", "(?i)ab")
```

```
TRUE
```

To limit the effect of the modifier to some part of the expression, use "(?i:...)":

```
strmatch("ABC", "(?i:a)b"),
strmatch("abc", "(?i:a)b"),
strmatch("Abc", "(?i:a)b")
```

```
FALSE, TRUE, TRUE
```

## Example 12

`strmatch` with `ReturnMatches` or `All` (without `Index`) returns the matched substrings. You can also return parts of those substrings. For example, extract all function names from this expression. To identify function names, note that an opening parenthesis or a space and an opening parenthesis follows every function name.

```
s := "f(sin (x) + abc + def(x))":
strmatch(s, "\\b\\w+\\s*\\(", All)
```

```
 {"def", "f", "sin" }
```

To extract the function names themselves, use this command:

```
map(strmatch(s, "\\b(\\w+)\\s*\\(", All), op, 2)
```

```
 {"def", "f", "sin" }
```

Regular expressions can contain zero-width assertions. These assertions ensure that something does or does not follow, without actually including it or moving the conceptual pointer behind it. Therefore, the more efficient approach is to wrap the corresponding expression in "(?=...)":

```
strmatch(s, "\\b\\w+(?=\\s*\\(", All)
```

```
 {"def", "f", "sin" }
```

### Example 13

Regular expressions can also make zero-width assertions with respect to the preceding text. Such assertions must have a fixed width. For example, extract the amount of money mentioned in this string:

```
s := "In March 2005, we've spent $1192.23 on light.":  
strmatch(s, "(?<=\\$)\\d+(?:\\.\\d\\d)?", All)
```

```
 {"1192.23" }
```

### Example 14

To detect the positions of the matches in the input string, use the `Index` option. The returned list contains two numbers: the beginning and end of the match.

```
strmatch("abc", "b", Index)
```

```
 [2, 2]
```

If no match is found, `strmatch` returns `FALSE`:

```
strmatch("abc", "d", Index)
```

```
FALSE
```

If you use both `Index` and `ReturnMatches`, then `strmatch` returns indices followed by the matched subexpressions:

```
strmatch("abc", "b.", ReturnMatches, Index)
```

```
[2, 3, "bc"]
```

## Example 15

If you use `All`, then the return value is a set:

```
strmatch("abc", ".", All),  
strmatch("abc", ".", Index, All),  
strmatch("abc", ".", ReturnMatches, All)
```

```
{"a", "b", "c"}, {[1, 1], [2, 2], [3, 3]}, {"a", "b", "c"}
```

## Parameters

**text, pattern**

character strings on page 7-53

## Options

**Index**

Return the position of the match. If there are no matches, `strmatch` returns `FALSE`. Otherwise, it returns the position of the match as a list of two integers, `[i, j]`, such that `text[i..j]` is the matched substring.

## ReturnMatches

Return the matched substrings. If the regular expression contains groups (subexpressions in parentheses), then `strmatch` returns lists containing the matched substring and the strings matched by the groups, in order of opening parentheses.

## All

Return all matches that `strprint` can find. By default, `strmatch` returns only the first match. If you do not use `Index`, then the `All` option also implies `ReturnMatches`.

## Return Values

Without options, `TRUE` or `FALSE` is returned. With `Index`, a list of two nonnegative integers or `FALSE` is returned. With option `ReturnMatches`, a string or a list of strings is returned, depending on whether the pattern contains groups. With both `Index` and `ReturnMatches`, a list starting with the indices of the match, followed by the string or strings of `ReturnMatches`, is returned. With option `All`, a set is returned.

## Overloaded By

`pattern, text`

## Algorithms

- A dot (.) matches any character, except "\n". With the `s` modifier, a dot matches any character. See “Example 2” on page 1-2026 (Symbolic Math Toolbox).
- A caret (^) matches the beginning of a line. A dollar (\$) matches the end of a line. Typically, ^ and \$ mark the beginning and end of the string, but with the `m` modifier they also can appear after or before a "\n". See “Example 4” on page 1-2028 (Symbolic Math Toolbox).
- A pattern enclosed in parentheses (()) is considered “grouped.”
- A vertical bar (|) between two characters or groups (sub-regexes) lets you specify alternative matching patterns. Any one of the alternatives matching is sufficient. See “Example 5” on page 1-2029 (Symbolic Math Toolbox).



- A sub-regex followed by a number  $n$  enclosed in  $\{ \}$  must match exactly  $n$  times.

A sub-regex followed by  $\{n, \}$  must match at least  $n$  times.

A sub-regex followed by  $\{n, m\}$  must match at least  $n$  and at most  $m$  times.

In any other context,  $\{$  and  $\}$  are treated as normal characters.

See “Example 7” on page 1-2031 (Symbolic Math Toolbox).

- Following a sub-regex, a question mark ( $?$ ) works as  $\{0, 1\}$ , making the sub-regex optional.

A plus sign ( $+$ ) in this context works as  $\{1, \}$  and allows an arbitrary positive number of repetitions.

An asterisk after an expression is equivalent to  $\{0, \}$  and allows an arbitrary number of repetitions, including zero.

See “Example 6” on page 1-2030 (Symbolic Math Toolbox).

- By default,  $\{n, \}$  and its three shorthand forms match as many characters as possible. By following them with another question mark (for example, “ $a(b[cd])\{2, \}?bd$ ”, “ $(0|1)^*?12$ ”), you can specify that `strmatch` must return the lowest number of characters consistent with the remainder of the pattern.
- While a backslash (which must be typed as “ $\backslash$ ”) escapes any special character (including itself), it makes some characters following it special. See “Example 10” on page 1-2034 (Symbolic Math Toolbox).
  - “ $\backslash w$ ” matches a “word” character (alphanumeric or underline).
  - “ $\backslash W$ ” matches a character not matched by “ $\backslash w$ ”.
  - “ $\backslash s$ ” matches a white-space character (space, or tabulator, or, if the `s` modifier is active, also an end-of-line character).
  - “ $\backslash S$ ” matches a character not matched by “ $\backslash s$ ”.
  - “ $\backslash d$ ” matches a digit.
  - “ $\backslash D$ ” matches a nondigit.
  - “ $\backslash b$ ” matches the place between a word character and a nonword character, for example, the place where a word starts or ends.
  - “ $\backslash B$ ” is also zero-width, but matches those places where “ $\backslash b$ ” does not.

- "\\A" and "\\Z" match at the beginning and end of the string, respectively. "\\Z" ignores a "\\n" at the end of the string; "\\z" behaves like "\\Z", but does not ignore a trailing "\\n".
- '\\X' matches a grapheme cluster. For example, the letter ā is a grapheme cluster: it consists of a and ̄. '\\X' lets you access ā as one entity.
- Characters enclosed between [ and ] form a character class. See “Example 9” on page 1-2033 (Symbolic Math Toolbox).

A character class starting with ^ is negated, and matches all the characters not listed. The symbol ^ at any other place in the character class has no special meaning.

Inside a character class, the special characters, except for a hyphen, do not have any special meaning. If a hyphen (-) is not the first character, then it creates a range of characters. The language settings of your operating system (technically speaking, the current locale) affect how `strmatch` interprets this range. Likely, in every language setting "[0-9]" represents any digit.

To specify character classes independent of language settings, use named access to POSIX character classes:

- "[[:digit:]]" for any digit.
- "[[:alpha:]]" for characters (the language settings define what makes a character).
- "[[:alnum:]]" for alphanumerical characters.
- "[[:word:]]" for alphanumerical characters plus the underline (\_).
- "[[:punct:]]" for punctuation characters, such as a dot or a comma.
- "[[:ascii:]]" for characters in the ASCII range (decimal codes 32 through 127).
- "[[:blank:]]" for horizontal spaces, such as [ \t].
- "[[:space:]]" for spaces, including end-of-line.
- "[[:cntrl:]]" for control characters, such as newlines. Note that you cannot type most control characters in MuPAD, but they can occur in strings read from files.
- "[[:graph:]]" for the class of alphanumeric or punctuation characters, that is, characters with visual graphical representation.
- "[[:print:]]" is equivalent to "[[:graph:]]". It adds the space character to the graph class.

- "[[:lower:]]" and "[[:upper:]]" for the characters that your language settings consider lowercase and uppercase letters. For example, a German system is more likely to know about ä being a lowercase letter than a U.S. system.
- "[[:xdigit:]]" matches hexadecimal digits. It is equivalent to [0123456789aAbBcCdDeEfF].

You combine these classes with one another or add characters from one class to another class. For example, you can match septendecimal digits with "[[:xdigit:]gG]".

You can negate posix character classes using a caret. For example, "[[:^digit:]]" matches nondigits. This is equivalent to "[^[:digit:]]", but "[0[:^digit:]]" to allow any nondigit or zero is more difficult to express otherwise.

- Groups starting with ( ? have special meanings:
  - Groups starting with (?: behave like other groups, but do not create output matches for the ReturnMatches option.
  - "(?#text)" is a comment and effectively ignored.
  - Groups starting with (?X:, where X is one of i, m, s, x, locally apply modifiers:
    - i causes all pattern matching to be case-insensitive (as defined by the system's locale).
    - m causes a "multiline" match, where ^ and \$ match after/before "\n" characters in the string.
    - s makes the dot match newlines.
    - x allows perl-style comments in the pattern. In this case, strmatch ignores spaces in most contexts. The # characters start comments that extend to the end of the line.

When using these options in an outer group, you can disable them by preceding them with a minus sign, as in "(?-i:aB)".

- The string "(?X)", where X is one of the characters listed above, switches the corresponding setting on up to the end of the enclosing group.
- (?= starts a positive zero-width lookahead assertion. This is a zero-width item (and therefore does not add something to the output) that matches if its contents match at the current position. See "Example 12" on page 1-2035 (Symbolic Math Toolbox).

- (?! starts a zero-width negative look-ahead assertion. It behaves almost identical to (?= except it matches if and only if (?= does not.
- (?<= starts a positive zero-width look-behind assertion, which is like (?=, but looking in the other direction. Look-behind assertions must have a fixed width. See “Example 13” on page 1-2036 (Symbolic Math Toolbox).
- (?<! starts a negative zero-width look-behind assertion, which matches if and only if a (?<= at the same place does not match.

## See Also

### MuPAD Functions

`_concat` | `length` | `stringlib::contains` | `stringlib::maskMeta` |  
`stringlib::pos` | `substring`

# strprint

Print into string

## Syntax

```
strprint(<All>, <Unquoted>, <NoNL>, <KeepOrder>, object1, object2, ...)
```

## Description

`strprint(objects)` returns the string `print(objects)` would display on the screen.

`strprint` returns a string that contains the output `print` would have sent to the screen for the same arguments. This string contains `\n` characters if the output would have consisted of multiple lines.

On Windows systems, each `\n` is preceded by `\r`, because that is the traditional end-of-line combination since that is the end-of-line combination inherited from CP/M. The examples in this documentation assume a system like UNIX. Also note that with Typesetting activated, `\r`, `\n`, `\t`, and `\b` will not be displayed in a string.

All options and dependencies on variables are interpreted as described in the documentation of `print`. Especially, this means `PRETTYPRINT` affects the output of `strprint`. Overloading of `print` is taken into account. See `?print` for details.

## Environment Interactions

`strprint` is sensitive to the environment variables `DIGITS`, `PRETTYPRINT`, and `TEXTWIDTH`, and to the output preferences `Pref::floatFormat`, `Pref::keepOrder`, and `Pref::trailingZeroes`.

## Examples

### Example 1

The string returned by `strprint`, when printed with option `Unquoted`, yields the same output as the operands would have in the first place:

```
s := strprint(a*x^2-7):  
print(Unquoted, s)
```

```
      2  
a x  - 7
```

This can be used to combine multiple outputs:

```
s1 := strprint(a*x^2-7):  
s2 := _concat("-" $ TEXTWIDTH)."\n":  
s3 := strprint(sin(1/x)):  
print(Unquoted, s1.s2.s3)
```

```
      2  
a x  - 7
```

```
-----  
  / 1 \  
sin| - |  
  \ x /
```

In the example above, you can see that the output of `strprint` does not contain the spaces usually used for centering. The output in the first example was centered, because it used only a fraction of the text width on page 1-243 (Symbolic Math Toolbox), while the string `s1.s2.s3` in the second example spans the whole width of the line and is therefore printed flush left.

### Example 2

For demonstrative purposes, let us write a domain that puts an expression into a box. We make use of the fact that `strprint` returns strings starting with a newline, of output `::fence` and of indexed assignment on page 1-1017 to strings:

```
domain box  
  print := proc(e)
```

```

        local ex, str, w;
        save TEXTWIDTH;
    begin
        if TEXTWIDTH > 15 then
            TEXTWIDTH := TEXTWIDTH - 4;
        end_if;
        ex := extop(e, 1);
        str := strprint(All, ex);
        w := str[5]+4;
        str := output::fence("| ", " |",
                            "\n".str[1]."\n",
                            str[5], str[6]+1);
        str[1..w] := "+"._concat("-"$w-2)."+";
        str[-w-1..-2] := "+"._concat("-"$w-2)."+";
        str;
    end_proc;

    new := x -> new(dom, x);
end_domain

print(Plain, box(a), box(sin(1/x)))

```

```

+----+ +-----+
| a |, | sin | - | |
+----+ | \ x / |
      +-----+

```

```

print(Plain, box(box(hold(E=m*c^2)))

```

```

+-----+
| +-----+ |
| |          2 | |
| | E = m c | |
| +-----+ |
+-----+

```

### Example 3

As a last example, we implement a print-method for matrices over  $\mathbb{Z}_5$ :

```

M5 := Dom::Matrix(Dom::IntegerMod(5))

```

`Dom::Matrix(Dom::IntegerMod(5))`

The standard output function simply puts “mod 5” behind every entry, inherited from the output method of `Dom::IntegerMod(5)`:

```
A := M5([[1,2,3,4],[5,6,7,8],[-2,-3,0,1]])
```

$$\begin{pmatrix} 1 \text{ mod } 5 & 2 \text{ mod } 5 & 3 \text{ mod } 5 & 4 \text{ mod } 5 \\ 0 \text{ mod } 5 & 1 \text{ mod } 5 & 2 \text{ mod } 5 & 3 \text{ mod } 5 \\ 3 \text{ mod } 5 & 2 \text{ mod } 5 & 0 \text{ mod } 5 & 1 \text{ mod } 5 \end{pmatrix}$$

We now replace this method:

```
M5::print := proc(A)
    local str, h1, w1, h, w, b;
    begin
        [str, h1, w1, h, w, b] := strprint(All, expr(A));
        _concat(str, " " $ w, "[mod 5]");
    end_proc;
```

```
print(A):
```

```
/ 1, 2, 3, 4 \
| 0, 1, 2, 3 |
\ 3, 2, 0, 1 /
      [mod 5]
```

Alternatively, we can set the `[mod 5]` right beneath the brackets:

```
M5::print := proc(A)
    local str;
    begin
        str := strprint(expr(A));
        str[-1..-1] := " [mod 5]";
        str
    end_proc;
```

```
print(A):
```



```

/ 1, 2, 3, 4 \
| 0, 1, 2, 3 |
\ 3, 2, 0, 1 / [mod 5]

```

## Parameters

**object<sub>1</sub>, object<sub>2</sub>, ...**

Any MuPAD objects

## Options

### All

When the option `All` is given, `strprint` returns additional information on the string generated by printing. More specifically, it returns a list consisting of

- 1 the formatted string,
- 2 the height (in characters) of the first line,
- 3 the width of the first line,
- 4 the height of the complete string,
- 5 the width of the complete string,
- 6 the baseline, counted from top to bottom.

“Example 2” on page 1-2044 (Symbolic Math Toolbox) contains sample code that makes use of this information.

### Unquoted

Display character strings without quotation marks and with expanded control characters `'\n'`, `'\t'`, and `'\b'`.

### NoNL

Like `Unquoted`, but no newline is put at the end. `PRETTYPRINT` is implicitly set to `FALSE`.

### **KeepOrder**

Display operands of sums (of type "\_plus") always in the internal order.

## **Return Values**

DOM\_STRING or a list of a DOM\_STRING and five integers.

## **Overloaded By**

## **See Also**

### **MuPAD Functions**

doprint | expose | expr2text | fprint | funcenv | output::fence | print

# subs

Substitute into an object

## Syntax

```
subs(f, old = new, <Unsimpified>)
subs(f, old1 = new1, old2 = new2, ..., options)
subs(f, [old1 = new1, old2 = new2, ...], options)
subs(f, {old1 = new1, old2 = new2, ...}, options)
subs(f, table(old1 = new1, old2 = new2, ...), options)
subs(f, s1, s2, ..., options)
```

## Description

`subs(f, old = new)` searches `f` for operands matching `old`, and replaces `old` with `new`. See “Example 1” on page 1-2050 (Symbolic Math Toolbox).

`subs` does not replace subexpressions. For example, `subs(a + b + c, b + c = d)` does not replace `b + c`. Instead, use `subsex`. For details, see “Example 8” on page 1-2055 (Symbolic Math Toolbox).

The `subs` function returns a modified copy of the object. The function does not change the object itself.

By default, the `subs` function does not evaluate the result of a substitution. To enforce evaluation of all modified subexpressions, use the `EvalChanges` option. Also, you can reevaluate the whole returned result by using the `eval` function. Evaluation of the returned result is slower and less efficient than evaluation of the modified subexpressions. See “Example 3” on page 1-2051 (Symbolic Math Toolbox) and “Example 4” on page 1-2052 (Symbolic Math Toolbox).

The call `subs(f, old1 = new1, old2 = new2, ...)` applies the specified substitutions in a sequence from left to right (sequential substituton). This call applies

each substitution (except for the first substitution) to the result of the previous substitution. See “Example 5” on page 1-2053 (Symbolic Math Toolbox).

The call `subs(f, [old1 = new1, old2 = new2, ...])` applies all specified substitutions to the operands of the original input object `f` (parallel substitution). This call does not use the results of any previous substitutions. If you specify multiple substitutions of the same operand, this call computes only the first substitution. Specifying substitutions by lists, sets, or tables invokes parallel substitution. See “Example 6” on page 1-2053 (Symbolic Math Toolbox).

The call `subs(f, s1, s2, ...)` is a general form of substitution that can combine sequential and parallel substitutions. This call is equivalent to `subs(... subs(subs(f, s1), s2), ...)`. MuPAD treats each substitution step as a sequential or a parallel substitution depending on the form of the parameters `s1, s2, ...`. See “Example 7” on page 1-2054 (Symbolic Math Toolbox).

You can use `subs` to replace operands of expression sequences on page 1-88. The `subs` function does not flatten (Symbolic Math Toolbox) such objects. See “Example 9” on page 1-2056 (Symbolic Math Toolbox).

If you do not specify substitutions, `subs` returns the original expression without modifications. For example, `subs(f)` returns `f`.

## Examples

### Example 1

Use the `subs` function to substitute the operands in the following expressions:

```
subs(a + b*a, a = 4)
```

$4b + 4$

```
subs([a * (b + c), sin(b + c)], b + c = a)
```

$[a^2, \sin(a)]$

## Example 2

When replacing the sine function in an expression, use the `hold` command to prevent the evaluation of the identifier `sin`:

```
subs(sin(x), hold(sin) = cos);
domtype(hold(sin))
```

$\cos(x)$

DOM\_IDENT

Otherwise, MuPAD replaces `sin` by its value. The function environment (see `funcenv`) defines the value of `sin`:

```
subs(sin(x), sin = cos);
domtype(sin)
```

$\sin(x)$

DOM\_FUNC\_ENV

Inside the expression `sin(x)`, the 0-th operand `sin` is the identifier, not the function environment:

```
domtype(op(sin(x), 0))
```

DOM\_IDENT

## Example 3

The `subs` function evaluates the original expression, performs a substitution, but does not evaluate the modified expression:

```
subs(y^2 + sin(x), x = PI)
```

$y^2 + \sin(\pi)$

To evaluate the modified subexpression, use the `EvalChanges` option:

```
subs(y^2 + sin(x), x = PI, EvalChanges)
```

$y^2$

Alternatively, use the `eval` function to evaluate the result returned by `subs`:

```
S := subs(y^2 + sin(x), x = PI):  
eval(S)
```

$y^2$

## Example 4

The `subs` function with the `EvalChanges` option returns the same results as the evaluation of the whole expression:

```
eval(subs(sin(x + 3 - PI)*numeric::int(_plus(sin(k/y) $ k = 1..5),  
                                         y = 0..1), x=-3));  
subs(sin(x + 3 - PI)*numeric::int(_plus(sin(k/y) $ k = 1..5),  
                                     y = 0..1), x = -3, EvalChanges)
```

0

0

The evaluation of the returned result is slower and less efficient than the evaluation of the modified subexpressions:

```
time(eval(subs(sin(x + 3 - PI)*numeric::int(_plus(sin(k/y) $ k = 1..5),  
                                             y = 0..1), x = -3)));  
time(subs(sin(x + 3 - PI)*numeric::int(_plus(sin(k/y) $ k = 1..5),  
                                         y = 0..1), x = -3, EvalChanges))
```

12218.75

6265.625

## Example 5

The following call results in the sequential substitution  $x \rightarrow y \rightarrow z$ :

```
subs(x^3 + y*z, x = y, y = z)
```

$$z^3 + z^2$$

## Example 6

The `subs` function lets you use sequential and parallel substitutions. For example, substitute the operand in the following expressions sequentially:

```
subs(a^2 + b^3, a = b, b = a)
```

$$a^3 + a^2$$

```
subs(a^2 + b^3, b = a, a = b)
```

$$b^3 + b^2$$

For the same expression, parallel substitution swaps the identifiers:

```
subs(a^2 + b^3, [a = b, b = a])
```

$$a^3 + b^2$$

In the following call, the substitution of  $y + x$  for  $a$  yields the intermediate result  $y + 2*x$ . From there, the substitution of  $z$  for  $x$  results in  $y + 2 z$ :

```
subs(a + x, a = x + y, x = z)
```

$$y + 2 z$$

Parallel substitution produces a different result. The following call substitutes  $a$  with  $x + y$ . Simultaneously, this call substitutes the operand  $x$  of *the original expression*  $a + x$  with  $z$ :

```
subs(a + x, [a = x + y, x = z])
```

$x + y + z$

If you specify the substitutions using a set of a table of equations, the `subs` function also performs a parallel substitution:

```
subs(a + x, {a = x + y, x = z})
```

$x + y + z$

```
T := table(): T[a] := x + y: T[x] := z: T
```

$a$	$x + y$
$x$	$z$

```
subs(a + x, T)
```

$x + y + z$

```
delete T:
```

## Example 7

You can combine sequential and parallel substitutions:

```
subs(a + x, {a = x + y, x = z}, x = y)
```

$2y + z$



## Example 8

The `subs` function replaces only those operands that the `op` function can return. The following expression contains the subexpression  $x + y$  as the operand `op(f, [1, 2])`:

```
f := sin(z*(x + y)): op(f, [1, 2]);
```

$$x + y$$

Consequently, the `subs` function replaces this subexpression:

```
subs(f, x + y = z)
```

$$\sin(z^2)$$

Syntactically, the following sum does not contain the subexpression  $x + y$ . Therefore, the `subs` function does not replace it:

```
subs(x + y + z, x + y = z)
```

$$x + y + z$$

In contrast to `subs`, the `subsex` function finds and replaces partial sums and products:

```
subsex(x + y + z, x + y = z)
```

$$2z$$

```
subs(a*b*c, a*c = 5), subsex(a*b*c, a*c = 5)
```

$$a b c, 5 b$$

```
delete f:
```

For details on substitution functions in MuPAD, please see “Modify Subexpressions” (Symbolic Math Toolbox). For details on expression trees, please see “Visualize Expression Trees” (Symbolic Math Toolbox).

## Example 9

You can substitute operands of expression sequences on page 1-80. Enclose sequences in parentheses:

```
subs((a, b, a*b), a = x)
```

$x, b, b x$

## Example 10

The `Unsimplified` option suppresses simplification:

```
subs(a + b + 2, a = 1, b = 0, Unsimplified)
```

$1 + 0 + 2$

## Example 11

If you try to substitute something in a domain (Symbolic Math Toolbox), MuPAD ignores the substitution. For example, define a new domain on page 1-1422 with the methods "foo" and "bar":

```
mydomain := newDomain("Test"):
mydomain::foo := x -> 4*x:
mydomain::bar := x -> 4*x^2:
```

Now try to replace every number 4 inside the domain with the number 3:

```
mydomain := subs(mydomain, 4 = 3):
```

That substitution does not have any effect:

```
mydomain::foo(x), mydomain::bar(x)
```

$4 x, 4 x^2$

To substitute objects in a domain method, you must substitute in the individual methods:

```
mydomain::foo := subs(mydomain::foo, 4 = 3):
mydomain::bar := subs(mydomain::bar, 4 = 3):
mydomain::foo(x), mydomain::bar(x)
```

$$3x, 3x^2$$

```
delete mydomain:
```

## Parameters

**f**

An arbitrary MuPAD object

**old, old<sub>1</sub>, old<sub>2</sub>, ...**

Arbitrary MuPAD objects

**new, new<sub>1</sub>, new<sub>2</sub>, ...**

Arbitrary MuPAD objects

**s<sub>1</sub>, s<sub>2</sub>, ...**

Either equations on page 1-19 `old = new`, or lists on page 7-41 or sets on page 7-41 of such equations, or tables on page 1-2103 whose entries are interpreted as such equations.

## Options

### EvalChanges

After substitution, evaluate all modified subexpressions.

By default, the `subs` function does not evaluate the modified object. The `EvalChanges` option enforces the evaluation of all modified subexpressions. See “Example 3” on page 1-2051 (Symbolic Math Toolbox) and “Example 4” on page 1-2052 (Symbolic Math Toolbox).

## **Unimplified**

Do not simplify the result of a substitution.

As the last step of a substitution, MuPAD automatically simplifies (but does not evaluate) the modified object. The `Unimplified` option suppresses the final simplification. See “Example 10” on page 1-2056 (Symbolic Math Toolbox).

## **Return Values**

Copy of the input object with replaced operands.

## **Overloaded By**

f

## **See Also**

### **MuPAD Functions**

`evalAt` | `extnops` | `extop` | `extsubsop` | `has` | `map` | `match` | `op` | `subsex` | `subsop`

# subset\_subset\_notsubset

Relation “is a subset of”

## Syntax

A subset B

`_subset(A, B)`

not A subset B

`_notsubset(A, B)`

## Description

A subset B represents the expression  $A \subset B$ .

A is a subset of B if  $x \in A \Rightarrow x \in B$ .

The function `_notsubset` exists for typesetting purposes. It is returned as the result of negating a subset expression. See “Example 4” on page 1-2060 (Symbolic Math Toolbox).

If called with symbolic arguments (anything but sets), these functions return a symbolic expression of type `_in` on page 1-1006 or the unevaluated input.

## Examples

### Example 1

When called with two sets, these functions return a Boolean value on page 1-2180:

```
{1} subset {1,2,3},  
{ } subset {1},
```

```
{1} subset {1},  
{1} subset {}
```

TRUE, TRUE, TRUE, FALSE

## Example 2

Note: identifiers in sets are not assumed to be place-holders. See ?= for details on syntactic equality.

```
{x} subset {1,2}
```

FALSE

## Example 3

If one of the arguments is not a set, these functions return an equivalent symbolic expression:

```
{1} subset A, A subset {1}
```

$1 \in A, A \subset \{1\}$

## Example 4

For “pretty typesetting”, the negation of `subset` is implemented in a special function environment on page 1-1642 (Symbolic Math Toolbox):

```
not A subset B
```

$A \not\subset B$

```
type(%)
```

"\_notsubset"

## Parameters

A, B

MuPAD expressions

## Return Values

TRUE, FALSE, or an expression.

## Overloaded By

A, B

## See Also

### **MuPAD Functions**

in | intersect | minus | union

## subsex

Extended substitution

### Syntax

```
subsex(f, old = new, <Unsimpified>)
subsex(f, old1 = new1, old2 = new2, ..., <Unsimpified>)
subsex(f, [old1 = new1, old2 = new2, ...], <Unsimpified>)
subsex(f, {old1 = new1, old2 = new2, ...}, <Unsimpified>)
subsex(f, table(old1 = new1, old2 = new2, ...), <Unsimpified>)
subsex(f, s1, s2, ..., <Unsimpified>)
```

### Description

`subsex(f, old = new)` returns a copy of the object `f` in which all expressions matching `old` are replaced by the value `new`.

`subsex` returns a modified copy of the object, but does not change the object itself.

`subsex(f, old = new)` searches `f` for subexpressions matching `old`. Each such subexpression is replaced by `new`.

Unlike the `subs` function, `subsex` replaces “incomplete” subexpressions. For example, `subsex(a + b + c, b + c = d)` replaces `b + c` but `subs(a + b + c, b + c = d)` does not replace `b + c`. In general, combinations of the operands of the `n`-ary “operators” `+`, `*`, `and`, `_exprseq`, `intersect`, `or`, `_lazy_and`, `_lazy_or`, and `union` can be replaced. In particular, partial sums and partial products can be replaced. Note that these operations are assumed to be commutative, e.g., `subsex(a*b*c, a*c = new)` does replace the partial product `a*c` by `new`. See “Example 1” on page 1-2063 (Symbolic Math Toolbox) and “Example 2” on page 1-2064 (Symbolic Math Toolbox). However, the advantage of `subs` over `subsex` is that `subs` is much faster.

`subsex` additionally replaces powers with the same base, if the exponent of the expression is an integer multiple of the replacement power, e.g. like in `subsex(a^4,`



$a^2 = \text{new}$ ). This rule also matches inverted expressions like in `subsex(1/sqrt(x), sqrt(x)=new)`, which is internally equivalent to `subsex(x^(-1/2), x^(1/2)=new)`. Cf. “Example 3” on page 1-2064 (Symbolic Math Toolbox).

The call `subsex(f, old1 = new1, old2 = new2, ...)` invokes a “sequential substitution”. See the `subs` help page for details.

The call `subsex(f, [old1 = new1, old2 = new2, ...])` invokes a “parallel substitution”. See the `subs` help page for details.

The call `subsex(f, s1, s2, ...)` describes the most general form of substitution which may combine sequential and parallel substitutions. This call is equivalent to `subsex(... subsex(subsex(f, s1), s2), ...)`. Depending on the form of `s1, s2, ...`, sequential or parallel substitutions are carried out in each step. An example can be found on the `subs` help page.

After substitution, the result is not evaluated. Use the function `eval` to enforce evaluation. Cf. “Example 5” on page 1-2066 (Symbolic Math Toolbox).

Operands of expression sequences on page 1-88 can be replaced by `subsex`. Such objects are not flattened (Symbolic Math Toolbox). Cf. “Example 6” on page 1-2066 (Symbolic Math Toolbox).

The call `subsex(f)` is allowed; it returns `f` without modifications.

## Examples

### Example 1

We demonstrate some simple substitutions; `subsex` finds and replaces partial sums and products:

```
subsex(a + b + c, a + c = x)
```

$$b + x$$

```
subsex(a*b*c, a*c = x)
```

$$b x$$

```
subsex(a * (b + c) + b + c, b + c = a)
```

$$a^2 + a$$

```
subsex(a + b*c*d + b*d, b*d = c);
```

$$c^2 + c + a$$

## Example 2

We replace subexpressions inside a symbolic union on page 1-1996 (Symbolic Math Toolbox) of sets:

```
subsex(a union b union c, a union b = w)
```

$$c \cup w$$

The same can be achieved by using the functional equivalent `_union` of the operator `union`:

```
subsex(_union(a, b, c), _union(a, b) = w)
```

$$c \cup w$$

For details on substitution functions in MuPAD, please see “Modify Subexpressions” (Symbolic Math Toolbox). For details on expression trees, please see “Visualize Expression Trees” (Symbolic Math Toolbox).

## Example 3

`subsex` replaces powers with with the same base, if the exponent of the expression is an integer multiple of the replacement power:

```
subsex(1/a^4, a^2 = X)
```

$$\frac{1}{X^2}$$

This holds even for exponents which are expressions:

```
subsex(1/a^(6*x), a^(2*x) = X)
```

$$\frac{1}{X^3}$$

$1/\sqrt{x}$  is internally  $x^{(-1/2)}$ , so the replacement of  $\sqrt{x}$  which is internally  $x^{(1/2)}$  works, too:

```
subsex(1/sqrt(n), sqrt(n) = X)
```

$$\frac{1}{X}$$

#### Example 4

`subsex` is often useful to convert the output of one command into a form required by the next one. As an example, we compute the Laplace transform on page 1-1193 of the two-dimensional ODE

$$x'(t) = x(t) + 2 y(t), x(0) = 1,$$

$$y'(t) = 5 x(t) + 2 y(t), y(0) = -2,$$

and transform the result into a form suitable for calling `solve` by replacing the unknown Laplace transforms by symbolic names:

```
xfrm1 := laplace(x'(t) = x(t) + 2*y(t), t, s);
xfrm2 := laplace(y'(t) = 5*x(t) + 2*y(t), t, s)
```

$$s \operatorname{laplace}(x(t), t, s) - x(0) = \operatorname{laplace}(x(t), t, s) + 2 \operatorname{laplace}(y(t), t, s)$$

$$s \operatorname{laplace}(y(t), t, s) - y(0) = 5 \operatorname{laplace}(x(t), t, s) + 2 \operatorname{laplace}(y(t), t, s)$$

For readability, we give names to both substitutions:

```
sub_x := laplace(x(t),t,s) = X:
sub_y := laplace(y(t),t,s) = Y:

Leqn1 := subs(xfrm1, sub_x, sub_y, x(0) = 1);
Leqn2 := subs(xfrm2, sub_x, sub_y, y(0) = -2)
```

$$X s - 1 = X + 2 Y$$

$$Y s + 2 = 5 X + 2 Y$$

```
solve({Leqn1, Leqn2}, {X, Y})
```

$$\left\{ \begin{array}{ll} \emptyset & \text{if } s^2 = 3s + 8 \\ \left\{ \left[ X = -\frac{s-6}{-s^2+3s+8}, Y = \frac{2s-7}{-s^2+3s+8} \right] \right\} & \text{if } s^2 \neq 3s + 8 \end{array} \right.$$

### Example 5

The result of `subsex` is not evaluated. In the following call, the identifier `sin` is not replaced by its value, i.e., by the procedure defining the behavior of the system's sine function. Consequently, `sin(2*PI)` is not simplified to 0 by this procedure:

```
subsex(sin(2*x*y), x*y = PI)
```

$$\sin(2 \pi)$$

The function `eval` enforces evaluation:

```
eval(subsex(sin(2*x*y), x*y = PI))
```

$$0$$

### Example 6

Operands of expression sequences on page 1-80 can be substituted. Note that sequences need to be enclosed in brackets:

```
subsex((a, b, a*b*c), a*b = x)
```

*a, b, c x*

## Example 7

The option `Unsimplified` suppresses simplification:

```
subsex(2 + a + b, a + b = 0, Unsimplified)
```

*2 + 0*

## Parameters

**f**

An arbitrary MuPAD object

**old, old<sub>1</sub>, old<sub>2</sub>, ...**

Arbitrary MuPAD objects

**new, new<sub>1</sub>, new<sub>2</sub>, ...**

Arbitrary MuPAD objects

**s<sub>1</sub>, s<sub>2</sub>, ...**

Either equations on page 1-19 `old = new`, or lists on page 7-41 or sets on page 7-41 of such equations, or tables on page 1-2103 whose entries are interpreted as such equations.

## Options

**Unsimplified**

Prevents simplification of the returned object after substitution

As the last step of a substitution, the modified object is simplified (however, not evaluated). This option suppresses this final simplification. See “Example 7” on page 1-2067 (Symbolic Math Toolbox).

## Return Values

Copy of the input object with replaced operands.

## Overloaded By

f

## See Also

### MuPAD Functions

`evalAt` | `extnops` | `extop` | `extsubsop` | `has` | `map` | `match` | `op` | `subs` | `subsop`

# subsop

Replace operands

## Syntax

```
subsop(object, i1 = new1, i2 = new2, ..., <Unsimpified>)
```

## Description

`subsop` returns a modified copy of the object, but does not change the object itself.

`subsop(object, i = new)` replaces the operand `op(object, i)` by `new`. Operands are specified in the same way as with the function `op`: `i` may be an integer or a list of integers. E.g., `subsop(object, [j, k] = new)` replaces the suboperand `op(op(object, j), k)`. Cf. “Example 2” on page 1-2070 (Symbolic Math Toolbox). In contrast to `op`, ranges on page 1-16 cannot be used in `subsop` to specify more than one operand to replace. Several substitution equations have to be specified instead.

If several operands are to be replaced, the specified substitutions are processed in sequence from left to right. Each substitution is carried out and the result is processed further with the next substitution. The intermediate objects are not simplified.

The result of `subsop` is not evaluated further. It can be evaluated via the function `eval`. Cf. “Example 3” on page 1-2071 (Symbolic Math Toolbox).

Operands of expression sequences can be replaced by `subsop`. Such objects are not flattened (Symbolic Math Toolbox).

Note that the order of the operands may change by replacing operands and evaluating the result. Cf. “Example 4” on page 1-2071 (Symbolic Math Toolbox).

FAIL is returned if an operand cannot be accessed.

Substitution via `subsop` is faster than via `subs` or `subsex`.

The call `subsop(object)` is allowed; it returns the object without modifications.

## Examples

### Example 1

We demonstrate how to replace one or more operands of an expression:

```
x := a + b: subsop(x, 2 = c)
```

*a + c*

```
subsop(x, 1 = 2, 2 = c)
```

*c + 2*

Also the 0-th operand of an expression (the “operator”) can be replaced:

```
subsop(x, 0 = _mult)
```

*a b*

The variable x itself was not affected by the substitutions:

```
x
```

*a + b*

```
delete x:
```

### Example 2

The following call specifies the suboperand c by a list of integers:

```
subsop([a, b, f(c)], [3, 1] = x)
```

*[a, b, f(x)]*



### Example 3

This example demonstrates the effect of simplification. The following substitution replaces the first operand `a` by `2`. The result simplifies to `3`:

```
subsop(a + 1, 1 = 2)
```

`3`

The option `Unimplified` suppresses the simplification:

```
subsop(a + 1, 1 = 2, Unimplified)
```

`2 + 1`

The next call demonstrates the difference between *simplification* and *evaluation*. After substitution of `PI` for `x`, the identifier `sin` is not evaluated, i.e., the body of the system function `sin` is not executed:

```
subsop(sin(x), 1 = PI)
```

`sin(π)`

Evaluation of `sin` simplifies the result:

```
eval(%)
```

`0`

### Example 4

The order of operands may change by substitutions. Substituting `z` for the identifier `b` changes the internal order of the terms in `x`:

```
x := a + b + c: op(x)
```

`a, b, c`

```
x := subsop(x, 2 = z): op(x)
```

```
a, c, z
```

```
delete x:
```

## Parameters

### **object**

Any MuPAD object

**i<sub>1</sub>, i<sub>2</sub>, ...**

Integers or lists on page 7-41 of integers

**new<sub>1</sub>, new<sub>2</sub>, ...**

Arbitrary MuPAD objects

## Options

### **Unsimplified**

As the last step of a substitution, the modified object is simplified (however, not evaluated). This option suppresses this final simplification. Cf. "Example 3" on page 1-2071 (Symbolic Math Toolbox).

## Return Values

Input object with replaced operands or FAIL.

## Overloaded By

object

## Algorithms

For overloading `subsop`, it is sufficient to handle the cases `subsop(object)` and `subsop(object, i = new)`.

The case where the position of the operand to be replaced is given by a list is always handled recursively: First, `op` is called with the list bar the last element to find the object to substitute in (using the overloading of `op` if present, storing all the intermediate results), then the substitution is performed on that sub-object (using the overloading of `subsop` of the form `subsop(subobj, i = new)`). The result is substituted into the last-but-one result of the recursive `op` call, again respecting any overloading of `subsop`, and so on up to the front of the list.

## See Also

### MuPAD Functions

`extnops` | `extop` | `extsubsop` | `map` | `match` | `op` | `subs` | `subsex`

# substring

Extract a substring from a string

## Syntax

```
substring(string, i)
```

```
substring(string, i, l)
```

```
substring(string, i .. j)
```

## Description

`substring(string, i)` returns the *i*-th character of a string.

`substring(string, i, l)` returns the substring of length *l* starting with the *i*-th character of the string.

`substring(string, i..j)` returns the substring consisting of the characters *i* through *j*, inclusive.

The empty string "" is returned if the length  $l = 0$  is specified.

`substring` is considered obsolete. You should use index access on page 1-1017 to strings instead.

## Examples

### Example 1

We extract individual characters from a string:

```
substring("123456789", i) $ i = 1..9
```

```
"1", "2", "3", "4", "5", "6", "7", "8", "9"
```

Substrings of various lengths are extracted:

```
substring("123456789", 1, 2), substring("123456789", 4, 4)
```

```
"12", "4567"
```

Substrings of length 0 are empty strings:

```
substring("123456789", 4, 0)
```

```
""
```

Ranges may be used to specify the substrings:

```
substring("123456789", 1..9)
```

```
"123456789"
```

## Example 2

The following `while` loop removes all trailing blank characters from a string:

```
string := "MuPAD      " :  
while substring(string, length(string)) = " " do  
  string := substring(string, 1..length(string) - 1)  
end_while
```

```
"MuPAD"
```

## Parameters

### `string`

A nonempty character string on page 7-53

### `i`

An integer between 1 and `length(string)`

**`l`**

An integer between 1 and `length(string)`

**`j`**

An integer between `i` and `length(string)`

## **Return Values**

Character string

## **See Also**

### **MuPAD Functions**

`length` | `stringlib::subs` | `strmatch`

## **\_subtract**

Subtract expressions

### **Syntax**

`_subtract(x, y)`

### **Description**

`_subtract(x, y)` subtracts  $y$  from  $x$ .

The difference operator `-` does not call `_subtract(x, y)`. The difference  $x - y$  is equivalent to  $x + (-y) = \text{\_plus}(x, \text{\_negate}(y))$ .

To implement the slot `d : \_subtract` for your domain  $d$ , use the following convention:

- If both  $x$  and  $y$  are elements of  $d$ , the slot must return an appropriate difference of type  $d$ .
- If  $x$  or  $y$  is not an element of  $d$  and cannot be converted to an element of  $d$ , the slot must return FAIL.
- If  $x$  or  $y$  is not an element of  $d$ , but can be converted to type  $d$ , use the following approach. This object must be converted to an element of  $d$  only if the mathematical semantics is obvious to all users of  $d$ , including the users who treat this domain as a "black box". For example, you can regard integers as rational numbers because of the natural mathematical embedding, but you must make sure that all users are aware of this approach. Otherwise, the "`\_subtract`" method must return FAIL instead of using implicit conversions. If you use implicit conversions for the elements of your domain, document these conversions.

In the MuPAD standard installation, most of the library domains comply with this convention.

`\_subtract` can subtract polynomials of the `DOM_POLY` type from a polynomial of the same type. The polynomials must have the same indeterminates and the same coefficient ring.

`_subtract` can subtract finite sets from a finite set. For finite sets  $X$  and  $Y$ , the difference is the set  $\{x - y \mid x \in X, y \in Y\}$ .

## Examples

### Example 1

Compute the difference of the following arithmetical expressions by using the `_subtract` method. Then, compute the difference of the same expressions by using the difference operator:

```
_subtract(x, y), x - y
```

```
x - y, x - y
```

Although both `_subtract` and the difference operator return the same result for these expressions, the `_subtract` call is not equivalent to `x - y`:

```
type(hold(x - y)), type(hold(_subtract(x, y)))
```

```
"_plus", "_subtract"
```

### Example 2

Use the `_subtract` function when combining the following lists:

```
zip([a, b, c, d], [1, 2, 3, 4], _subtract)
```

```
[a - 1, b - 2, c - 3, d - 4]
```



## Parameters

`x, y`

arithmetical expressions (Symbolic Math Toolbox), polynomials on page 1-431 (Symbolic Math Toolbox) of type `DOM_POLY`, or sets on page 7-50

## Return Values

arithmetical expression (Symbolic Math Toolbox), a polynomial on page 1-431 (Symbolic Math Toolbox), or a set on page 7-50.

## Overloaded By

`x, y`

## See Also

### MuPAD Functions

`*` | `+` | `-` | `/` | `Pref::keepOrder` | `^` | `_invert` | `poly`

## sum

Definite and indefinite summation

---

**Note** For the sum function in MATLAB<sup>®</sup>, see `sum`.

---

## Syntax

`sum(f, i)`

`sum(f, i = a .. b)`

`sum(f, i = RootOf(p, x))`

## Description

`sum(f, i)` computes a symbolic antidifference of  $f(i)$  with respect to  $i$ .

`sum(f, i = a .. b)` tries to find a closed form representation of the sum  $\sum_{i=a}^b f(i)$ .

`sum` serves for simplifying *symbolic* sums (the discrete analog of integration). It should *not* be used for simply adding a finite number of terms: if  $a$  and  $b$  are integers of type `DOM_INT`, the call `_plus(f $ i = a .. b)` gives the desired result, while `sum(f, i = a .. b)` may return unevaluated. `expand` may be used to sum such an unevaluated finite sum. See “Example 3” on page 1-2082 (Symbolic Math Toolbox).

`sum(f, i)` computes the indefinite sum of  $f$  with respect to  $i$ . This is an expression  $g$  such that  $f(i) = g(i + 1) - g(i)$ .

It is implicitly assumed that  $i$  runs through integers only.

`sum(f, i = a .. b)` computes the definite sum with  $i$  running from  $a$  to  $b$ .

If  $a$  and  $b$  are numbers, then they must be integers.

If  $b - a$  is a nonnegative integer, then the explicit sum  $f(a) + f(a + 1) + \dots + f(b)$  is returned, provided that this sum has no more than 1000 terms.

`sum(f, i = RootOf(p, x))` computes the sum with  $i$  extending over all roots of the polynomial  $p$  with respect to  $x$ .

If  $f$  is a rational function of  $i$ , a closed form of the sum will be found.

See “Example 2” on page 1-2082 (Symbolic Math Toolbox).

The system returns a symbolic call of `sum` if it cannot compute a closed form representation of the sum.

Infinite symbolic sums without symbolic parameters can be evaluated numerically via `float` or `numeric::sum`. Cf. “Example 4” on page 1-2084 (Symbolic Math Toolbox).

## Examples

### Example 1

We compute some indefinite sums:

`sum(1/(i^2 - 1), i)`

$$-\frac{1}{2(i-1)} - \frac{1}{2i}$$

`sum(1/i/(i + 2)^2, i)`

$$\frac{\psi'(i+2)}{2} - \frac{1}{4i+4} - \frac{1}{4i}$$

`sum(binomial(n + i, i), i)`

$$\begin{cases} 0 & \text{if } n = -1 \\ \frac{i \binom{i+n}{i}}{n+1} & \text{if } n \neq -1 \end{cases}$$

We compute some definite sums. Note that  $\pm\infty$  are valid boundaries:

```
sum(1/(i^2 + 21*i), i = 1..infinity)
```

$$\frac{18858053}{108636528}$$

```
sum(1/i, i = a .. a + 3)
```

$$\psi(a+4) - \psi(a)$$

```
expand(%)
```

$$\frac{1}{a+1} + \frac{1}{a+2} + \frac{1}{a+3} + \frac{1}{a}$$

## Example 2

We compute some sums over all roots of a polynomial:

```
sum(i^2, i = RootOf(x^3 + a*x^2 + b*x + c, x))
```

$$a^2 - 2b$$

```
sum(1/(z + i), i = RootOf(x^4 - y*x + 1, x))
```

$$\frac{4z^3 + y}{z^4 + yz + 1}$$

## Example 3

sum can compute finite sums if indefinite summation succeeds:

```
sum(1/(i^2 + i), i = 1..100)
```

$$\frac{100}{101}$$



However, if one of the boundaries is symbolic, then `_plus` cannot be used:

```
_plus(1/(i^2 + i) $ i = 1..n)
```

$$\text{\_plus}\left(\frac{1}{i^2 + i} \text{ \$ } i = 1..n\right)$$

```
_plus(binomial(n, i) $ i = 0..n)
```

$$\text{\_plus}\left(\binom{n}{i} \text{ \$ } i = 0..n\right)$$

```
sum(1/(i^2 + i), i = 1..n), sum(binomial(n, i), i = 0..n)
```

$$\frac{n}{n+1}, 2^n$$

## Example 4

The following infinite sum cannot be computed symbolically:

```
sum(ln(i)/i^5, i = 1..infinity)
```

$$\sum_{i=1}^{\infty} \frac{\ln(i)}{i^5}$$

We obtain a floating-point approximation via `float`:

```
float(%)
```

**0.02857378051**

Alternatively, the function `numeric::sum` can be used directly. This is usually much faster than applying `float`, since it avoids the overhead of `sum` attempting to compute a symbolic representation:

```
numeric::sum(ln(i)/i^5, i = 1..infinity)
```

0.02857378051

## Parameters

**f**

An arithmetical expression (Symbolic Math Toolbox) depending on **i**

**i**

The summation index: an identifier on page 7-29 or indexed identifier on page 1-1017

**a, b**

The boundaries: arithmetical expressions (Symbolic Math Toolbox)

**p**

A polynomial (Symbolic Math Toolbox) of type `DOM_POLY` or a polynomial expression (Symbolic Math Toolbox)

**x**

An indeterminate of **p**

## Return Values

arithmetical expression (Symbolic Math Toolbox).

## Algorithms

The function `sum` implements Abramov's algorithm for rational expressions, Gosper's algorithm for hypergeometric expressions, and Zeilberger's algorithm for the definite summation of holonomic expressions.

## See Also

### MuPAD Functions

+ | `_plus` | `int` | `numeric::sum` | `product` | `rec` | `sum::addpattern`

### Topics

"Compute Symbolic Sums" (Symbolic Math Toolbox)

"Approximate Sums Numerically" (Symbolic Math Toolbox)



# sum::addpattern

Add patterns for definite and indefinite summation

## Syntax

```
sum::addpattern(pat, k, res, <[var, ...], <[cond, ...]>>)
```

```
sum::addpattern(pat, k = a .. b, res, <[var, ...], <[cond, ...]>>)
```

## Description

`sum::addpattern(pat, k, res)` teaches `sum` to make use of  $\sum_k \text{pat} = \text{res}$ .

`sum::addpattern(pat, k=a..b, res)` teaches `sum` that  $\sum_{x=a}^b \text{pat} = \text{res}$ .

A part of a computer algebra system's summation abilities stems from mathematical pattern matching. The MuPAD pattern matcher can be extended at runtime with `sum::addpattern`.

For definite summation, each bound is either an arithmetical expression which may contain pattern variables, or an identifier which can be used as a variable in the result and condition terms.

Users can include pattern variables and conditions on these by giving additional arguments. These conditions, as well as the result, are protected from premature evaluation, i.e., it is not necessary to write `hold( _not @ iszero )(a^2-b)`, a simple `not iszero(a^2-b)` suffices.

The difference between `not iszero(a^2-b)` and `a^2-b <> 0` when given as a condition is that the latter takes into account assumptions on the identifiers encountered, while the first does not. Cf. "Example 4" on page 1-2090 (Symbolic Math Toolbox).

Patterns introduced by `sum::addpattern` are also used in recursive calls of `sum` and are automatically extended to include simple applications of summation by change of variables. Cf. "Example 1" on page 1-2088 (Symbolic Math Toolbox).

## Environment Interactions

Calling `sum::addpattern` changes the expressions returned by future calls to `sum`.

### Examples

#### Example 1

Not surprisingly, MuPAD does not know how to do an indefinite summation with the function `foo`:

```
sum(foo(n), n)
```

$$\sum_n \text{foo}(n)$$

We add a pattern for this function:

```
sum::addpattern(foo(k), k, bar(k))
```

```
sum(foo(n), n)
```

$$\text{bar}(n)$$

Note that this pattern is also used indirectly:

```
sum(foo(k+3), k)
```

$$\text{bar}(k + 3)$$

#### Example 2

Definite sums can be added similarly:

```
sum::addpattern(foo(k), k=1..infinity, bar(k))
```

```
sum(foo(k), k=1..infinity)
```

$$\text{bar}(k)$$

The above pattern will also match this definite sum with different bounds:

$$\text{sum}(\text{foo}(k), k=3..infinity)$$

$$\text{bar}(k) - \text{foo}(2) - \text{foo}(1)$$

Note that this pattern is also used indirectly:

$$\text{sum}(\text{foo}(k)+1/k^3, k=1..infinity)$$

$$\zeta(3) + \text{bar}(k)$$

The bounds may also be variables occurring in the pattern or the result:

$$\text{sum}::\text{addpattern}(\text{foo}(k,a), k=0..a, \text{bar}(a), [a])$$

$$\text{sum}(\text{foo}(k,7), k=0..7)$$

$$\text{bar}(7)$$

### Example 3

The name of the summation variable used in the call to `sum::addpattern` does not restrict later calls to `sum`:

$$\text{sum}::\text{addpattern}(x^{(2*i+1)}/(2*i+1), i=0..infinity, \\ \text{piecewise}([\text{abs}(x) < 1, \\ \text{arccoth}(x) + \text{PI}/2*\text{sqrt}(-1/x^2)*x]), \\ [x])$$

$$\text{sum}(x^{(2*n+1)}/(2*n+1), n=0..infinity)$$

$$\left\{ \begin{array}{l} \text{arccoth}(x) + \frac{\pi x \sqrt{-\frac{1}{x^2}}}{2} \text{ if } |x| < 1 \end{array} \right.$$

## Example 4

Conditions are checked using `is` and therefore react to assumptions:

```
sum::addpattern(binomial(-1/2, k)*x^(2*k^2 + 1)/(2*k + 1),  
                k = 0..infinity, arcsinh(x),  
                [x], [abs(x) < 1])
```

```
sum(binomial(-1/2, k)*x^(2*k^2 + 1)/(2*k + 1),  
    k = 0..infinity) assuming -1 < x < 1
```

$\operatorname{arcsinh}(x)$

```
sum(binomial(-1/2, k)*x^(2*k^2 + 1)/(2*k + 1),  
    k = 0..infinity) assuming x > 1
```

$$\sum_{k=0}^{\infty} \frac{x^{2k^2+1} \binom{-\frac{1}{2}}{k}}{2k+1}$$

If MuPAD cannot decide whether the conditions are satisfied, a piecewise defined object is returned:

```
sum(binomial(-1/2, k) * x^(2*k^2+1)/(2*k+1),  
    k = 0..infinity)
```

$\{ \operatorname{arcsinh}(x) \text{ if } |x| < 1$

If either the conditions are not satisfied or substituting the values into the result yields an error, the pattern is ignored. There is no need to include a condition to guard against an error, MuPAD simply computes the sum as usual:

```
sum::addpattern(c^k, k=0..n, (c^n-1)/(c-1), [c]);  
sum(1^k, k=0..n)
```

$n + 1$

## Parameters

### **pat**

The pattern to match: an arithmetical expression (Symbolic Math Toolbox) in  $k$ .

### **k**

The summation index: an identifier on page 7-29.

### **a .. b**

The boundaries for a definite summation: arithmetical expressions (Symbolic Math Toolbox) or identifiers.

### **res**

The pattern for the result of the summation: an arithmetical expression

### **var, ...**

“pattern variables”: placeholders in **pat** and **res**, i.e., identifiers on page 7-29 or indexed identifiers on page 1-1017. They do not represent themselves but almost arbitrary MuPAD expressions not containing  $k$ . You may restrict them by the conditions in the 5th parameter.

### **cond, ...**

Conditions on the pattern variables

## Return Values

Object of type `DOM_NULL`

## See Also

### **MuPAD Functions**

`sum`

## surd

N -th root

### Syntax

`surd(x, n)`

### Description

For a complex number  $x$  and integer  $n$ , `surd(x, n)` returns the  $n$ -th root of  $x$  whose (complex) argument is closest to that of  $x$ .

If  $x$  is a positive real number, `surd(x, n)` coincides with  $x^{1/n}$ . If  $x$  is a negative real number and  $n$  is odd, then `surd(x, n)` coincides with  $-|x|^{1/n}$ .

`surd(x, n)` returns that complex solution  $y$  of  $y^n = x$  with polar angle closest to that of  $x$ ; among two equally distant  $y$ 's, the one with smaller argument is chosen. In contrast,  $x^{1/n}$  represents the solution with the smallest absolute value of the polar angle in the range  $(-\pi, \pi]$ .

If  $n$  is a numerical value, it must be a non-zero integer. If it is symbolic, it is understood to represent a non-zero integer.

`surd(x, 2)` is mathematically equivalent to `sqrt(x)`. Unlike `sqrt`, however, `surd` may return an unevaluated symbolic call.

### Environment Interactions

When called with a floating-point argument, the function is sensitive to the environment variable `DIGITS` which determines the numerical working precision.

## Examples

### Example 1

If  $n$  is odd and  $x$  is real, then  $\text{surd}(x, n)$  is real, too. On the other hand,  $x^{(1/n)}$  is not real if  $x$  is negative:

`surd(-27, 3), surd(-27.0, 3), (-27)^(1/3), (-27.0)^(1/3)`

$-3, -3.0, 3(-1)^{1/3}, 1.5 + 2.598076211i$

### Example 2

`surd` may be called with symbolic arguments:

`surd(3, n)`

$3^{1/n}$

Sometimes, `surd` returns an unevaluated function call:

`surd(x, 3), surd(x, n^2 + n)`

$\sqrt[3]{x}, \sqrt[n^2+n]{x}$

## Parameters

**x**

An arithmetical expression (Symbolic Math Toolbox)

**n**

An arithmetical expression (Symbolic Math Toolbox)

## **Return Values**

Arithmetical expression.

## **See Also**

### **MuPAD Functions**

`_power` | `sqrt`



# sysname

Name of the operating system

## Syntax

```
sysname(<Arch>)
```

## Description

`sysname()` returns information on the operating system on which MuPAD is currently executed. It can return one of the following strings:

- "UNIX" for UNIX operating systems including Mac OS X and Linux,
- "MSDOS" for MS-DOS® operating systems including Microsoft Windows,

`sysname(Arch)` returns a more specific name of the operating system as a character string.

## Examples

### Example 1

On a 64-bit Microsoft Windows operating system, `sysname` returns the following values:

```
sysname(), sysname(Arch)
```

```
"MSDOS", "win64"
```

On a 32-bit Microsoft Windows operating system, `sysname(Arch)` returns:

```
sysname(Arch)
```

```
"win32"
```

## Example 2

On a 64-bit Linux operating system, `sysname` returns the following values:

```
sysname(), sysname(Arch)
```

```
"UNIX", "glnxa64"
```

## Example 3

On a 64-bit Apple Macintosh operating system, `sysname` returns the following values:

```
sysname(), sysname(Arch)
```

```
"UNIX", "maci64"
```

## Options

### Arch

Makes `sysname` return more specific information on the architecture

## Return Values

character string on page 7-53.

## See Also

### MuPAD Functions

`system`

# sysorder

Compare objects according to the internal order

## Syntax

```
sysorder(object1, object2)
```

## Description

`sysorder(object1, object2)` returns `TRUE` if the MuPAD internal order of `object1` is less than or equal to the order of `object2`. Otherwise, `FALSE` is returned.

---

**Note** The exceptions are domains on page 7-8.

---

One should not try and use the internal order to sort objects according to specific criteria. E.g., it does not necessarily reflect the natural ordering of numbers or strings. Further, the internal order may differ between different MuPAD versions.

The only feature one may rely upon is its uniqueness. Cf. “Example 2” on page 1-2098 (Symbolic Math Toolbox).

## Examples

### Example 1

We give some examples how `sysorder` behaves in the current MuPAD version. For numbers, the internal order is equal to the natural order:

```
sysorder(3, 4) = bool(3 <= 4),  
sysorder(45, 33) = bool(45 <= 33),  
sysorder(0, 4) = bool(0 <= 4)
```

`TRUE = TRUE, FALSE = FALSE, TRUE = TRUE`

```
sysorder(1/3, 1/4) = bool(1/3 <= 1/4),  
sysorder(-4, 2) = bool(-4 <= 2),  
sysorder(-4, -2) = bool(-4 <= -2)
```

FALSE = FALSE, TRUE = TRUE, TRUE = TRUE

## Example 2

We give a simple application of `sysorder`. Suppose, we want to implement a function `f`, say, whose only known property is its skewness  $f(-x) = -f(x)$ . Expressions involving `f` should be simplified automatically, e.g.,  $f(x) + f(-x)$  should yield zero for any argument `x`. To achieve this, we use `sysorder` to decide, whether a call `f(x)` should return `f(x)` or `-f(-x)`:

```
f := proc(x) begin  
  if sysorder(x, -x) then  
    return(-procname(-x))  
  else return(procname(x))  
  end_if;  
end_proc;
```

For numerical arguments, `f` prefers to rewrite itself with positive arguments:

```
f(-3), f(3), f(-4.5), f(4.5), f(-2/3), f(2/3)
```

$-f(3), f(3), -f(4.5), f(4.5), -f\left(\frac{2}{3}\right), f\left(\frac{2}{3}\right)$

For other arguments, the result is difficult to predict:

```
f(x), f(-x), f(sqrt(2) + 1), f(-sqrt(2) - 1)
```

$-f(-x), f(-x), f(\sqrt{2} + 1), -f(\sqrt{2} + 1)$

With this implementation, expressions involving `f` simplify automatically:

```
f(x) + f(-x) - f(3)*f(x) + f(-3)*f(-x) + sin(f(7)) + sin(f(-7))
```

0

`delete f:`

## Parameters

`object1, object2`

Arbitrary MuPAD objects

## Return Values

TRUE or FALSE.

## See Also

### MuPAD Functions

`_less` | `listlib::removeDupSorted` | `sort`

## system

Execute a command of the operating system

### Syntax

`! command`

`system(command)`

### Description

`system("command")` executes a command of the operating system or a program, respectively.

`!command` is equivalent to `system("command");`; note that `!command` will suppress output of its return value.

The syntax `!command` is allowed during interactive input only, not when reading MuPAD input from a file. `!` must be the first character on the input line.

`system` is not available in all MuPAD versions. If not available, a call to `system` results in the following error message:

```
Error: Function not available for this client [system].
```

`system("command")` sends the command to the operating system. E.g., this command may start another application program on the computer. The return value 0 indicates that the command was executed successfully. Otherwise, an integer error code is returned which depends on the operating system and the command.

If the called command writes output to `stderr` on UNIX systems, the output will go to the MuPAD `stderr`. Outputs on the standard output channel will be inserted in the command's output, but are not accessible programmatically.

## Examples

### Example 1

On a UNIX system, the `date` command is executed. The command output is printed to the screen, the error code 0 for successful execution is returned to the MuPAD session:

```
errorcode := system("date");  
Fri Sep 29 14:42:13 MEST 2000  
errorcode  
0
```

Now the `date` command is called with the command line option `' +%m'` in order to display the current month only:

```
errorcode := system("date +%m");  
09
```

Missing the prefix `' +'` in the command line option of `date`, `date` and therefore `system` returns an error code. Note that the error output goes to `stderr`:

```
system("date '%m'")  
1
```

```
delete errorcode:
```

### Example 2

The output of a program started with the `system` command cannot be accessed in MuPAD directly, but it can be redirected into a file and then be read using the `read` or `ftextinput` command:

```
system("echo communication example > comm_file");  
ftextinput("comm_file")
```

```
"communication example"
```

```
system("rm -f comm_file");
```

## Parameters

### **command**

A command of the operating system or a name of a program as a MuPAD character string on page 7-53

## Return Values

"error code": an integer.

## See Also

### **MuPAD Functions**

sysname



# table

Create a table

## Syntax

```
table()
```

```
table(index1 = entry1, index2 = entry2, ..., <default>)
```

```
table(<list>, <set>, <tab>, ..., <default>)
```

## Description

`table()` creates a new empty table.

`table(index1 = entry1, index2 = entry2, ...)` creates a new table with the given indices and entries.

In MuPAD, tables are the most flexible objects for storing data. In contrast to arrays on page 1-652 (Symbolic Math Toolbox) or lists on page 7-41, arbitrary MuPAD objects can be used as indices. Indexed access to table entries is fast and nearly independent of the size of the table. Thus, tables are suitable containers for large data.

For a table on page 1-2103T, say, an indexed call `T[index]` returns the corresponding entry. If no such entry exists, the default value of the table is returned, if the table has one. If no default value has been set and, the indexed expression `T[index]` is returned symbolically.

An indexed assignment of the form `T[index] := entry` adds a new entry to an existing table `T` or overwrites an existing entry associated with the index.

`table` can be used to create tables from other tables, lists on page 7-41 or sets on page 7-50 of equations. Cf. "Example 2" on page 1-2105 (Symbolic Math Toolbox).

`table` is used for the explicit creation of a table. There also is the following mechanism for creating a table implicitly.

If the value of an identifier  $T$ , say, is neither a table on page 1-2103 nor an array on page 7-2 nor an hfarray on page 7-27 nor a list on page 7-41, then an indexed assignment  $T[\text{index}] := \text{entry}$  is equivalent to  $T := \text{table}(\text{index} = \text{entry})$ . I.e., implicitly, a new table with one entry is created. Cf. “Example 3” on page 1-2106 (Symbolic Math Toolbox).

If the value of  $T$  was either a table or an array or an hfarray or a list, then the indexed assignment only inserts a new entry without changing the type of  $T$  implicitly.

Table entries can be deleted with the function `delete`. Cf. “Example 4” on page 1-2106 (Symbolic Math Toolbox).

## Examples

### Example 1

The following call creates a table with two entries:

```
T := table(a = 13, c = 42)
```

$$\begin{array}{c|c} a & 13 \\ \hline c & 42 \end{array}$$

The data may be accessed via indexed calls. Note the symbolic result for the index  $b$  which does not have a corresponding entry in the table:

```
T[a], T[b], T[c]
```

$$13, T_b, 42$$

Entries of a table may be changed via indexed assignments:

```
T[a] := T[a] + 10: T
```

$$\begin{array}{c|c} a & 23 \\ \hline c & 42 \end{array}$$

Expression sequences on page 1-88 may be used as indices or entries, respectively. Note, however, that they have to be enclosed in brackets when using them as input parameters for table:

```
T := table((a, b) = "hello", a + b = (50, 70))
```

$a + b$	50, 70
$a, b$	"hello"

```
T[a + b]
```

50, 70

Indexed access does not require additional brackets:

```
T[a, b] := T[a, b]." world": T
```

$a + b$	50, 70
$a, b$	"hello world"

```
delete T:
```

## Example 2

A table can be created from other tables, lists on page 7-41 or sets on page 7-50:

```
table(table(a = 1, b = 2),
      {a = 3, c = 4},
      [b = 5, e = 6])
```

$a$	3
$b$	5
$c$	4
$e$	6

Please note that a set has no order of operands. When a set contains several values under the same index, the table entry is chosen “randomly”:

```
table({a = 3, a = 4});  
table({a = 4, a = 3})
```

$$\overline{a|4}$$
$$\overline{a|3}$$

### Example 3

Below, a new table is created implicitly by an indexed assignment using an identifier T without a value:

```
delete T: T[4] := 7: T
```

$$\overline{4|7}$$

```
delete T:
```

### Example 4

Use `delete` to delete entries:

```
T := table(a = 1, b = 2, (a, b) = (1, 2))
```

$$\overline{\begin{array}{l|l} a & 1 \\ b & 2 \\ a, b & 1, 2 \end{array}}$$

```
delete T[b], T[a, b]: T
```

$$\overline{a|1}$$

```
delete T:
```

## Example 5

One of the uses of tables is to count the number of occurrences of some objects. In this situation, an implementation not using default values would have to look like this:

```
T := table():
L := [1,2,3,a,b,c,a,b,a]:
for i in L do
  if contains(T, i) then
    T[i] := T[i] + 1;
  else
    T[i] := 1;
  end_if;
end_for:
T
```

1	1
2	1
3	1
a	3
b	2
c	1

Note the test whether  $T[i]$  has already been set. If it has not, we cannot use its previous value, because that would remain symbolic:

```
T := table():
T[a] := T[a] + 1:
T
```

a	$T_a + 1$
---	-----------

By creating  $T$  as `table(0)` instead of `table()`, we can tell MuPAD to regard  $T[i]$  as  $0$  if it has not been told anything else and the code from above becomes substantially shorter and, much more important, much easier to read:

```
T := table(0):
L := [1,2,3,a,b,c,a,b,a]:
for i in L do
  T[i] := T[i] + 1;
end_for:
T
```

1	1
2	1
3	1
a	3
b	2
c	1

A slightly more complicated version counting all identifiers in an expression:

```
ex := sin(a*x+b)-cos(c+x):
cnt := table(0):
misc:=maprec(ex,
  {DOM_IDENT} = (x -> (cnt[x] := cnt[x]+1; x))):
cnt
```

_mult	2
_plus	3
a	1
b	1
c	1
cos	1
sin	1
x	2

## Parameters

**index<sub>1</sub>, index<sub>2</sub>, ...**

The indices: arbitrary MuPAD objects

**entry<sub>1</sub>, entry<sub>2</sub>, ...**

The corresponding entries: arbitrary MuPAD objects

**list**

A list of equations

**set**

A set of equations

**tab**

A table

**default**

The default value: A MuPAD object which is not an equation, a list, a set, nor a table

## Return Values

Object of type DOM\_TABLE.

## See Also

**MuPAD Domains**

DOM\_ARRAY | DOM\_HFARRAY | DOM\_LIST | DOM\_TABLE

**MuPAD Functions**

\_assign | \_index | array | assignElements | delete | hfarray | indexval

# taylor

Compute a Taylor series expansion

## Syntax

```
taylor(f, x, <order>, <mode>)
```

```
taylor(f, x = x0, <order>, <mode>)
```

```
taylor(f, x, <AbsoluteOrder = order>)
```

```
taylor(f, x = x0, <AbsoluteOrder = order>)
```

```
taylor(f, x, <RelativeOrder = order>)
```

```
taylor(f, x = x0, <RelativeOrder = order>)
```

## Description

`taylor(f, x = x0)` computes the first terms of the Taylor series of `f` with respect to the variable `x` around the point `x0`.

If `taylor` finds the corresponding Taylor series, the result is a series expansion of domain type `Series::Puiseux`. Use `expr` to convert it to an arithmetical expression of domain type `DOM_EXPR`. See “Example 1” on page 1-2111 (Symbolic Math Toolbox).

If a Taylor series does not exist or if `taylor` cannot find it, then `taylor` throws an error. See “Example 2” on page 1-2112 (Symbolic Math Toolbox) and “Example 3” on page 1-2113 (Symbolic Math Toolbox).

Mathematically, the expansion computed by `taylor` is valid in some open disc around the expansion point in the complex plane.

If `x0` is `complexInfinity`, then an expansion around the complex infinity, i.e., the north pole of the Riemann sphere, is computed. If `x0` is `infinity` or `-infinity`, a directed series expansion valid along the real axis is computed.



Such an expansion is computed as follows: The series variable  $x$  in  $f$  is replaced by

$x = \pm \frac{1}{x}$ . Then a directed series expansion at  $u = 0$  from the right is computed. If  $x0 = \text{complexInfinity}$ , then an undirected expansion around  $u = 0$  is computed. Finally,

$u = \pm \frac{1}{x}$  is substituted in the result.

Mathematically, the result of an expansion around `complexInfinity` or `±infinity` is a power series in  $\frac{1}{x}$ . See “Example 4” on page 1-2113 (Symbolic Math Toolbox).

With the default mode `RelativeOrder`, the number of requested terms for the expansion is `order` if specified. If no `order` is specified, the value of the environment variable `ORDER` used. You can change the default value 6 by assigning a new value to `ORDER`.

The number of terms is counted from the lowest degree term on for finite expansion points, and from the highest degree term on for expansions around infinity, i.e., “`order`” has to be regarded as a “relative truncation order”.

If `AbsoluteOrder` is specified, `order` represents the truncation order of the series (i.e., the  $x$  power in the Big-Oh term).

`taylor` uses the more general series function `series` to compute the Taylor expansion. See the corresponding help page for `series` for details about the parameters and the data structure of a Taylor series expansion.

## Environment Interactions

The function is sensitive to the environment variable `ORDER`, which determines the default number of terms in series computations.

## Examples

### Example 1

Compute a Taylor series around the default point 0:

```
s := taylor(exp(x^2), x)
```

$$1 + x^2 + \frac{x^4}{2} + O(x^6)$$

The result of `taylor` is of the following domain type:

`domtype(s)`

`Series::Puisseux`

If you apply the function `expr` to a series, the result is an arithmetical expression without the order term:

`expr(s)`

$$\frac{x^4}{2} + x^2 + 1$$

`domtype(%)`

`DOM_EXPR`

`delete s:`

## Example 2

A Taylor series expansion of  $f(x) = \frac{1}{x^2-1}$  around  $x = 1$  does not exist. Therefore, `taylor` throws an error:

`taylor(1/(x^2 - 1), x = 1)`

Error: Unable to compute Taylor expansion of '1/(x^2 - 1)'. Try 'series' for a more general expansion.

Call `series` to compute a more general series expansion. A Laurent expansion does exist:

`series(1/(x^2 - 1), x = 1)`

$$\frac{1}{2(x-1)} - \frac{1}{4} + \frac{x-1}{8} - \frac{(x-1)^2}{16} + \frac{(x-1)^3}{32} - \frac{(x-1)^4}{64} + O((x-1)^5)$$

### Example 3

If `taylor` cannot find a Taylor series expansion, it also throws an error.

```
taylor(psi(1/x), x = 0)
```

Error: Unable to compute Taylor expansion of 'psi(1/x)'. Try 'series' with the 'Left',

Call `series` with the optional argument. In this case, `series` returns a more general type of expansion. In cases where `series` cannot find a series expansion, it returns the symbolic function call.

```
series(psi(1/x), x = 0, Right)
```

$$-\ln(x) - \frac{x}{2} - \frac{x^2}{12} + \frac{x^4}{120} + O(x^6)$$

### Example 4

This is an example of a directed Taylor expansion along the real axis around infinity:

```
taylor(exp(1/x), x = infinity)
```

$$1 + \frac{1}{x} + \frac{1}{2x^2} + \frac{1}{6x^3} + \frac{1}{24x^4} + \frac{1}{120x^5} + O\left(\frac{1}{x^6}\right)$$

In fact, this is even an undirected expansion:

```
taylor(exp(1/x), x = complexInfinity)
```

$$1 + \frac{1}{x} + \frac{1}{2x^2} + \frac{1}{6x^3} + \frac{1}{24x^4} + \frac{1}{120x^5} + O\left(\frac{1}{x^6}\right)$$

## Parameters

**f**

An arithmetical expression (Symbolic Math Toolbox) representing a function in  $x$

**x**

An identifier on page 7-29 or an indexed identifier on page 1-1017

**x0**

The expansion point: an arithmetical expression. Also expressions involving `infinity` or `complexInfinity` are accepted.

If not specified, the default expansion point 0 is used.

**order**

The truncation order (in conjunction with `AbsoluteOrder`) or, in conjunction with `RelativeOrder`, the number of terms to be computed, respectively. A nonnegative integer; the default order is given by the environment variable `ORDER` (default value 6).

**mode**

One of the flags `AbsoluteOrder` or `RelativeOrder`. The default is `RelativeOrder`.

## Options

**AbsoluteOrder**

With this flag, the integer value `order` is the truncation order of the computed series (i.e., the exponent of  $x$  in the Big-Oh term).

**RelativeOrder**

With this flag, the exponents of  $x$  in the computed series range from some leading order  $v$  to the highest exponent  $v + \text{order} - 1$  (i.e., the exponent of  $x$  in the Big-Oh term is  $v + \text{order}$ ). In this case, `order` essentially is the “number of  $x$  powers” in the computed series if the series involves all integer powers of  $x$ .

## Return Values

Object of domain type `Series::Puisseux` or a symbolic expression of type "taylor".

## Overloaded By

f

## See Also

### MuPAD Functions

0 | `Series::Puisseux` | `Type::Series` | `asympt` | `diff` | `limit` | `mtaylor` | `series`

## Topics

"Compute Taylor Series for Univariate Expressions" (Symbolic Math Toolbox)

"O-term (The Landau Symbol)" (Symbolic Math Toolbox)

## tbl2text

Concatenate the strings in a table

### Syntax

```
tbl2text(strtab)
```

### Description

tbl2text concatenates all entries of a table of character strings.

The table must be indexed by 1, 2, 3 etc. All entries must be character strings. They are concatenated in the order of their indices.

tbl2text restores strings split by text2tbl.

### Examples

#### Example 1

A character string can be created from an arbitrary number of table entries:

```
tbl2text(table(1 = "Hell", 2 = "o", 3 = " ", 4 = "world."))
```

```
"Hello world."
```

### Parameters

**strtab**

A table on page 1-2103 of character strings on page 7-53

## Return Values

Character string.

## See Also

### MuPAD Functions

`_concat` | `coerce` | `expr2text` | `int2text` | `text2expr` | `text2list` | `text2tbl`

# tcoeff

Trailing coefficient of a polynomial

## Syntax

```
tcoeff(p, <order>)
```

```
tcoeff(f, <vars>, <order>)
```

## Description

`tcoeff(p)` returns the trailing coefficient of the polynomial `p`.

The returned coefficient is “trailing” with respect to the lexicographical ordering, unless a different ordering is specified via the argument `order`. Cf. “Example 1” on page 1-2118 (Symbolic Math Toolbox).

A polynomial expression `f` is first converted to a polynomial with the variables given by `vars`. If no variables are given, they are searched for in `f`. See `poly` about details of the conversion. The result is returned as polynomial expression. FAIL is returned if `f` cannot be converted to a polynomial. Cf. “Example 3” on page 1-2119 (Symbolic Math Toolbox).

The result of `tcoeff` is not fully evaluated. Evaluation can be enforced by the function `eval`. Cf. “Example 2” on page 1-2119 (Symbolic Math Toolbox).

## Examples

### Example 1

We demonstrate how various orderings influence the result:

```
p := poly(5*x^2*y^3 + 4*x^3*y*z + 3*x*y^4*z, [x, y, z]):  
tcoeff(p), tcoeff(p, DegreeOrder), tcoeff(p, DegInvLexOrder)
```

```
3, 5, 4
```



The following call uses the reverse lexicographical order on page 7-309 on 3 indeterminates:

```
tcoeff(p, Dom::MonomOrdering(RevLex(3)))
```

```
4
```

```
delete p:
```

## Example 2

The result of tcoeff is not fully evaluated:

```
p := poly(27*x^2 + a*x, [x]): a := 5:
tcoeff(p), eval(tcoeff(p))
```

```
a, 5
```

```
delete p, a:
```

## Example 3

The expression  $1/x$  may not be regarded as polynomial:

```
lterm(1/x)
```

```
FAIL
```

## Parameters

**p**

A polynomial (Symbolic Math Toolbox) of type DOM\_POLY

**f**

A polynomial expression (Symbolic Math Toolbox)

**vars**

A list on page 7-41 of indeterminates of the polynomial: typically, identifiers on page 7-29 or indexed identifiers on page 1-1017

**order**

The term ordering: either `LexOrder`, or `DegreeOrder`, or `DegInvLexOrder`, or a user-defined term ordering of type `Dom::MonomOrdering`. The default is the lexicographical ordering `LexOrder`.

## Return Values

Element of the coefficient domain of the polynomial or `FAIL`.

## Overloaded By

`p`

## See Also

**MuPAD Functions**

`coeff` | `collect` | `degree` | `degreevec` | `ground` | `lcoeff` | `ldegree` | `lmonomial` | `lterm` | `monomials` | `nterms` | `nthcoeff` | `nthmonomial` | `nthterm` | `poly` | `poly2list`

# testargs

Decide whether procedure arguments should be tested

## Syntax

```
testargs()
```

```
testargs(b)
```

## Description

Inside a procedure, `testargs` indicates whether the procedure should check its arguments.

Checking the input parameters of a procedure may be costly. For this reason, most functions of the MuPAD libraries are implemented according to the following philosophy:

If a procedure is called on the interactive level, i.e., if its parameters are supplied interactively by the user, then the parameters should be checked. If the input parameters do not comply with the documented specification of the procedure, then appropriate error messages should be returned to notify the user of wrong usage.

If the procedure is called by another procedure, then no check of the parameters should be performed to improve efficiency. The calling procedure is supposed to make sure that appropriate parameters are passed.

`testargs` is the tool to check whether the arguments should be tested: called inside the body of a procedure, `testargs()` returns `TRUE` if the procedure was called on the interactive level. Otherwise, it returns `FALSE`.

`testargs` has two modes. In the “standard mode”, its functionality is as described above. In the “argument checking mode”, the call `testargs()` always returns `TRUE`. This supports the debugging of procedures: any function using `testargs` checks its parameters and returns useful error messages if called in an inappropriate way.

The call `testargs(TRUE)` switches to the “argument checking mode”, i.e., parameter testing is switched on globally.

The call `testargs(FALSE)` switches to the “standard mode”, i.e., parameter testing is used only on the interactive level.

The call `testargs(b)` returns the previously set value.

`testargs` should not be used to change the behavior of a function other than performing type-checks, since the user may have switched to “argument checking mode”.

Checking the input parameters of a procedure can also be controlled with the function `Pref::typeCheck`.

## Examples

### Example 1

The following example demonstrates how `testargs` should be used inside a procedure. The function `p` is to generate a sequence of `n` zeroes; its argument should be a positive integer:

```
p := proc(n)
begin
  if testargs() then
    if not testtype(n, Type::PosInt) then
      error("expecting a positive integer");
    end_if;
  end_if;
  return(0 $ n)
end_proc;
```

Its argument is checked when `p` is called on the interactive level:

```
p(13/2)
```

```
Error: expecting a positive integer [p]
```

Calling `p` from within a procedure with an inappropriate parameter does not invoke the argument testing. The following strange output is caused by the attempt to evaluate `0 $ n`:

```
f := proc(n) begin p(n) end_proc: f(13/2)
```

0 \$  $\frac{13}{2}$

We switch on the “argument checking mode” of `testargs`:

```
testargs(TRUE):
```

Now also a non-interactive call to `p` produces an informative error message:

```
f(13/2)
```

```
Error: expecting a positive integer [p]
```

We clean up, restoring the “standard mode” of `testargs`:

```
testargs(FALSE): delete f, g:
```

## Parameters

**b**

TRUE or FALSE

## Return Values

TRUE or FALSE.

## See Also

### MuPAD Functions

`Pref::typeCheck` | `proc` | `testtype`

## testeq

Check the mathematical equivalence of expressions

### Syntax

```
testeq(ex1, options)
```

```
testeq(ex1, ex2, options)
```

### Description

`testeq(ex1, ex2)` checks whether the expressions `ex1` and `ex2` are mathematically equivalent.

`testeq(ex1, ex2)` returns `TRUE` if the difference `ex1 - ex2` can be simplified to zero.

`testeq` returns `FALSE` if `ex1` and `ex2` attain different values for at least one choice of variables contained in them.

By default, `testeq` performs five random tests. If randomly chosen values of the variables are inconsistent with the assumptions on these variables or the test returns the value `undefined`, the `testeq` function performs an additional test. The number of additional tests cannot exceed the number of initial tests. By default, the maximal total number of tests is 10. See “Example 4” on page 1-2126 (Symbolic Math Toolbox).

If the equivalence of `ex1` and `ex2` cannot be decided, `testeq` returns `UNKNOWN`.

If only one expression is passed to `testeq`, it is checked whether this expression is equivalent to zero.

`testeq` uses `Simplify(ex1 - ex2)` and `is(ex1 - ex2 = 0)` to determine its result. The result `UNKNOWN` can be caused by weaknesses of `Simplify` and `is`.

Using the options, the simplification process can be made stronger at the cost of increased run time.

## Examples

### Example 1

Check the mathematical equivalence of expressions:

```
testeq(sin(x)^2, 1 - cos(x)^2)
```

TRUE

```
testeq(sin(2*x), 2*sin(x)*cos(x))
```

TRUE

```
testeq((cos(a) + sin(a))^2, 2*(cos(PI/4 - a)^2))
```

TRUE

In order to be equivalent, two expressions must be equivalent for all values their variables can attain. For certain values of the parameter  $a$  the following two expressions are equivalent, but for other values they are not; therefore, they are not equivalent:

```
testeq((cos(a) + sin(a))^2, 3*(cos(PI/4 - a)^2))
```

FALSE

### Example 2

Applying `expand` and `rewrite` to an expression always produces an equivalent expression. However, with the default setting of 100 steps for the internal simplification procedure, the equivalence is not recognized in the following example:

```
f:= exp(arcsin(I*sin(x))):  
g:= rewrite(expand(f), ln):  
testeq(f, g)
```

UNKNOWN

After 1000 steps, however, the expressions are recognized as being equivalent:

```
testeq(f, g, Steps = 1000);  
delete f, g;
```

TRUE

### Example 3

When trying to prove the equivalence of two expressions, the `testeq` command runs random tests before applying `IgnoreAnalyticConstraints`. If tests for random values of identifiers show that expressions are not equivalent, `testeq` disregards the `IgnoreAnalyticConstraints` option and returns FALSE:

```
testeq(x^(ln(a))*x^(ln(b)) = x^(ln(a*b)),  
       IgnoreAnalyticConstraints)
```

FALSE

If, for a given number of attempts, random tests do not find the inequality between expressions, `testeq` applies the `IgnoreAnalyticConstraints` option:

```
testeq(ln(a) + ln(b) = ln(a*b), IgnoreAnalyticConstraints)
```

TRUE

By default, random tests check the equality of expressions for five random sets of values of identifiers. Increasing the number of attempts can prove inequality:

```
testeq(ln(a) + ln(b) = ln(a*b), NumberOfRandomTests = 10,  
       IgnoreAnalyticConstraints)
```

FALSE

### Example 4

When `testeq` performs tests, it takes into account the assumptions on variables that you specify:



```
testeq(x, abs(x)) assuming x > 0
```

TRUE

If `testeq` chooses values of the variables that are inconsistent with the assumptions on these variables, it performs an additional test. The number of tests cannot exceed  $2n$ , where  $n$  is the original number of tests defined by the `NumberOfRandomTests` option. If `testeq` performs  $2n$  tests and all values of the variables are inconsistent with the assumptions on the variables, `testeq` returns UNKNOWN:

```
testeq(x, abs(x)) assuming x^2 + x + 7 = x^13 + 11
```

UNKNOWN

For this particular assumption, MuPAD cannot find a closed-form expression to substitute for  $x$ :

```
solve(x^2 + x + 7 = x^13 + 11, x)
```

$\text{RootOf}(z^{13} - z^2 - z + 4, z)$

Therefore, increasing the number of tests does not help `testeq` decide if the expressions are equivalent:

```
testeq(x, abs(x), NumberOfRandomTests = 100)
    assuming x^2 + x + 7 = x^13 + 11
```

UNKNOWN

## Parameters

**ex1, ex2**

Any MuPAD expressions

## Options

### Steps

Option, specified as `Steps = n`

This option is directly passed to `Simplify` and determines the maximum number of steps allowed for the internal simplification process. The default value of `n` is `100`. Increasing the number of steps can give you a simpler result, often at the costs of increased runtime. For details, see the `Simplify` help page.

### Seconds

Option, specified as `Seconds = t`

This option is directly passed to `Simplify` and sets a time limit `t` in seconds for the internal simplification process. The default setting is `infinity`, i.e., the simplification process will not terminate due to a time limitation, but due to other internal stopping criteria. See the documentation of `Simplify` for details.

### RuleBase

Option, specified as `RuleBase = base`

This option is directly passed to `Simplify` and determines the rule base that is used for the internal simplification process. See the documentation of `Simplify` for details.

The default value of `base` is `Simplify`.

The advanced user can specify her own rule base (see `Simplify`). This allows the construction of specialized and fast tests for special classes of expressions.

### NumberOfRandomTests

Option, specified as `NumberOfRandomTests = n`

This option determines the number of times `testeq` tries to disprove the equivalence of `ex1` and `ex2` by plugging in some random values for all identifiers.

The default value of `n` is 5. If randomly chosen values of the variables are inconsistent with the assumptions on these variables or the test returns the value `undefined`, the `testeq` function performs an additional test. The total number of tests does not exceed `2n`. See “Example 4” on page 1-2126 (Symbolic Math Toolbox).

## **IgnoreAnalyticConstraints**

This option applies purely algebraic simplifications to expressions `ex1` and `ex2`. For the list of rules, see the documentation of `Simplify`. These simplification rules are not generally valid.

Note that random tests have higher priority than `IgnoreAnalyticConstraints`. When trying to prove the equivalence of two expressions, the `testeq` command runs random tests before applying the `IgnoreAnalyticConstraints` option. If random tests prove the expressions are not equivalent, `testeq` returns the value `FALSE`. See “Example 3” on page 1-2126 (Symbolic Math Toolbox).

## **Return Values**

`TRUE`, `FALSE`, or `UNKNOWN`

## **See Also**

### **MuPAD Functions**

`Simplify` | `is` | `simplify`

## **Topics**

“Test Results” (Symbolic Math Toolbox)

# testtype

Syntactical type checking

## Syntax

```
testtype(object, T)
```

## Description

`testtype(object, T)` checks whether the object is syntactically of type T.

The type object T may be either a domain type such as `DOM_INT`, `DOM_EXPR` etc., a string as returned by the function `type`, or a Type (Symbolic Math Toolbox) object. The latter are probably the most useful predefined values for the argument T.

---

**Note** `testtype` performs a purely syntactical check. Use `is` for semantical checks taking into account properties on page 1-265 of identifiers!

---

See the Algorithms section below for details on the overloading mechanism.

## Examples

### Example 1

The following call tests, whether the first argument is an expression. Expressions are basic objects of domain type `DOM_EXPR`:

```
testtype(x + y, DOM_EXPR)
```

```
TRUE
```

The `type` function distinguishes expressions. The corresponding type string is a valid type object for `testtype`:

```
type(x + y), testtype(x + y, "_plus")  
  
"_plus", TRUE
```

The following call tests, whether the first argument is an integer by querying, whether it is of domain type `DOM_INT`:

```
testtype(7, DOM_INT)  
  
TRUE
```

Note that `testtype` performs a purely syntactical test. Mathematically, the integer 7 is a rational number. However, the domain type `DOM_RAT` does not encompass `DOM_INT`:

```
testtype(7, DOM_RAT)  
  
FALSE
```

The Type (Symbolic Math Toolbox) library provides more flexible type objects. E.g., `Type::Rational` represents the union of `DOM_INT` and `DOM_RAT`:

```
testtype(7, Type::Rational)  
  
TRUE
```

The number 7 matches other types as well:

```
testtype(7, Type::PosInt), testtype(7, Type::Prime),  
testtype(7, Type::Numeric), testtype(7, Type::Odd)  
  
TRUE, TRUE, TRUE, TRUE
```

## Example 2

Subtypes of expressions can be specified via character strings:

```
type(f(x)), type(sin(x))  
  
"function", "sin"  
  
testtype(sin(x), "function"), testtype(sin(x), "sin"),  
testtype(sin(x), "cos")  
  
TRUE, TRUE, FALSE
```

### Example 3

We demonstrate how to implement a customized type object “div3” which is to represent integer multiples of 3. One has to create a new domain with a “testtypeDom” attribute on page 1-1980:

```
div3 := newDomain("divisible by 3?):  
div3::testtypeDom := x -> testtype(x/3, Type::Integer):
```

Via overloading, the command `testtype(object, div3)` calls this slot:

```
testtype(5, div3), testtype(6, div3), testtype(sin(1), div3)  
  
FALSE, TRUE, FALSE
```

```
delete div3:
```

## Parameters

### object

Any MuPAD object

### T

A type object

## Return Values

TRUE or FALSE.

## Overloaded By

object, T

## Algorithms

Overloading of `testtype` works as follows: First, it is checked whether `domtype(object) = T` or `type(object) = T` holds. If so, `testtype` returns TRUE.

Next, the method "`testtype`" of the domain `object::dom` is called with the arguments `object`, `T`. If this method returns a result other than `FAIL`, then `testtype` returns this value.

If the method `object::dom::testtype` does not exist or if this method returns `FAIL`, then overloading by the second argument is used:

- If `T` is a domain, then the method "`testtypeDom`" of `T` is called with the arguments `object`, `T`.
- If `T` is not a domain, then the method "`testtypeDom`" of `T::dom` is called with the arguments `object`, `T`.

## See Also

### MuPAD Functions

`coerce` | `domtype` | `hastype` | `is` | `type`

## text2expr

Convert a character string to an expression

### Syntax

```
text2expr(text)
```

### Description

`text2expr(text)` interprets the character string `text` as MuPAD input and generates the corresponding object.

The `text` must correspond to syntactically correct MuPAD input. Otherwise, `text2expr` produces an error. Typically, strings created from MuPAD objects via `expr2text` can be reconverted to corresponding objects.

The object is returned without being further evaluated. Evaluation can be enforced using the function `eval`.

The `text` does not need to be terminated with a ";" or a ":" character, respectively.

`text` cannot refer to local variables of an enclosing procedure by their name. The text is parsed as if entered interactively. Cf. "Example 4" on page 1-2136 (Symbolic Math Toolbox).

### Examples

#### Example 1

A character string is converted to a simple expression. The newly created expression is not evaluated automatically:

```
text2expr("21 + 21")
```



$21 + 21$ 

It may be evaluated via `eval`:

```
eval(%)
```

 $42$ 

## Example 2

A character string is converted to a statement sequence:

```
text2expr("x:= 3; x + 2 + 1"); eval(%)
```

```
(x := 3;  
x + 2 + 1)
```

 $6$ 

```
x
```

 $3$ 

```
delete x:
```

## Example 3

A matrix is converted to a string:

```
matrix([[a11, a12], [a21, a22]])
```

$$\begin{pmatrix} a_{11} & a_{12} \\ a_{21} & a_{22} \end{pmatrix}$$

```
expr2text(%)
```

```
"matrix([[a11, a12], [a21, a22]])"
```

The string is reconverted to a matrix:

```
text2expr(%)
```

```
( a11 a12 )  
 ( a21 a22 )
```

```
eval(%)
```

```
( a11 a12 )  
 ( a21 a22 )
```

## Example 4

`text2expr` will not create a `DOM_VAR` of an enclosing procedure from its name:

```
a := "global identifier";  
g := proc()  
  local a;  
  begin  
    a := "local variable";  
    print(a);  
    print(eval(text2expr("a")));  
  end_proc;  
g();
```

```
"local variable"
```

```
"global identifier"
```

## Parameters

**text**

A character string on page 7-53

## Return Values

MuPAD object.

## See Also

### **MuPAD Functions**

coerce | expr2text | input | int2text | tbl2text | text2int | text2list |  
text2tbl

## text2int

Convert a character string to an integer

### Syntax

```
text2int(text, <b>)
```

### Description

`text2int(text, b)` converts a character string corresponding to an integer in *b*-adic representation to an integer of type `DOM_INT`.

It must consist of the first *b* characters in `0, 1, ..., 9, A, B, ..., Z, a, b, ..., z`. The letters are used to represent the *b*-adic digits larger than 9.

For bases larger than 10 but smaller than 37 the letters are not case sensitive. The lower case letters *a, b, ..., z* are accepted:  $a = A = 10, \dots, z = Z = 35$ .

`text2int` is the inverse of `int2text`.

### Examples

#### Example 1

Relative to the default base 10, `text2int` provides a mere datatype conversion from `DOM_STRING` to `DOM_INT`:

```
text2int("123"), text2int("-45678")
```

```
123, -45678
```

## Example 2

The characters of the input string are interpreted as digits with respect to the specified base, the return value is a standard MuPAD integer represented with respect to the decimal system. The following example converts integers from the base 2 and 16, respectively, to the base 10:

```
text2int("101", 2), text2int("101", 16)
```

5, 257

The digit "3" does not exist in a binary representation:

```
text2int("103", 2)
```

Error: Invalid argument. [text2int]

## Example 3

For bases larger than 10 but smaller than 37, the letters are not case-sensitive:

```
text2int("3B9ACA00", 16), text2int("Z", 36) = text2int("z", 36)
```

1000000000, 35 = 35

For bases larger than 37 however, the case makes a difference:

```
text2int("Z", 62) <> text2int("z", 62)
```

35 ≠ 61

## Parameters

**text**

A character string on page 7-53

**b**

The base: an integer between 2 and 62. The default base is 10.

## **Return Values**

Integer.

## **See Also**

### **MuPAD Functions**

`coerce` | `expr2text` | `genpoly` | `int2text` | `numlib::g_adic` | `tbl2text` | `text2expr` | `text2list` | `text2tbl`

# text2list

Split a character string into a list of substrings

## Syntax

```
text2list(text, separators, <Cyclic>)
```

## Description

`text2list` splits a character string into a list of substrings, using the strings in the list `separators` as delimiters. `text2list` returns a list containing the substrings.

Without the option `Cyclic`, the text is split as follows. The first occurrence of one of the delimiters in `separators` is located in `text`. If no delimiter is found, the full text is returned as the only substring. Otherwise, the substring up to the delimiter defines the first substring. The delimiter is the second substring. The remaining text is processed as above until there are no more characters left. The result does not depend on the order of the delimiters.

With the option `Cyclic`, the first delimiter in `separators` is used to identify the first substring. The delimiter itself is the second substring. Then the second delimiter in `separators` is used to identify the third substring, and so on. After using the last delimiter of the list, the first one is used again, until the whole text is processed or until the current delimiter is not found in the remaining text. The result depends on the order of the delimiters.

`text2list` is a function of the system kernel.

## Examples

### Example 1

Call `text2list` with and without the option `Cyclic`:

```
text2list("This is a simple example!", ["is", "mp"])  
  
["Th", "is", " ", "is", " a si", "mp", "le exa", "mp", "le!"]  
  
text2list("This is a simple example!", ["is", "mp"], Cyclic)  
  
["Th", "is", " is a si", "mp", "le example!"]
```

## Parameters

### **text**

The text to be analyzed: a character string on page 7-53

### **separators**

Delimiters: a list on page 7-41 of character strings. The empty string "" is not accepted as a delimiter.

## Options

### **Cyclic**

The delimiter list is used cyclically

## Return Values

List of character strings.

## See Also

### **MuPAD Functions**

`coerce` | `expr2text` | `int2text` | `tbl2text` | `text2expr` | `text2int` | `text2tbl`



# text2tbl

Split a character string into a table of substrings

## Syntax

```
text2tbl(text, separators, <Cyclic>)
```

## Description

`text2tbl` splits a character string into a table of substrings, using the strings in the list `separators` as delimiters. `text2tbl` returns a table, using the indices 1, 2, 3, and so on.

Without the option `Cyclic`, the text is split as follows. The first occurrence of one of the delimiters in `separators` is located in `text`. If no delimiter is found, the full text is returned as the only substring. Otherwise, the substring up to the delimiter defines the first substring. The delimiter is the second substring. The remaining text is processed as above until there are no more characters left. The result does not depend on the order of the delimiters.

With the option `Cyclic`, the first delimiter in `separators` is used to identify the first substring. The delimiter itself is the second substring. Then the second delimiter in `separators` is used to identify the third substring, and so on. After using the last delimiter of the list, the first one is used again, until the whole text is processed or until the current delimiter is not found in the remaining text. The result depends on the order of the delimiters.

`tbl2text` restores strings split by `text2tbl`.

`text2tbl` is a function of the system kernel.

## Examples

### Example 1

Call `text2tbl` with and without the option `Cyclic`:

```
text2tbl("This is a simple example!", ["is", "mp"])
```

1	"Th"
2	"is"
3	" "
4	"is"
5	" a si"
6	"mp"
7	"le exa"
8	"mp"
9	"le!"

```
text2tbl("This is a simple example!", ["is", "mp"], Cyclic)
```

1	"Th"
2	"is"
3	" is a si"
4	"mp"
5	"le example!"

## Parameters

### **text**

The text to be analyzed: a character string on page 7-53

### **separators**

Delimiters: a list on page 7-41 of character strings. The empty string "" is not accepted as a delimiter.

## Options

### Cyclic

The delimiter list is used cyclically.

## Return Values

Table of character strings.

## See Also

### MuPAD Functions

`coerce` | `expr2text` | `int2text` | `tbl2text` | `text2expr` | `text2int` | `text2list`

## textInput

Interactive input of text

### Syntax

```
textInput(<prompt1>)
```

```
textInput(<prompt1>, x1, <prompt2>, x2, ...)
```

### Description

`textInput` allows interactive input of text.

`textInput()` displays the prompt “Please enter text:” and waits for input by the user. The input is converted to a character string, which is returned as the function's return value.

`textInput(prompt1)` uses the character string `prompt1` instead of the default prompt “Please enter text:”.

`textInput(prompt1 x1)` converts the input to a character string and assigns this string to the identifier or local variable `x1`. The default prompt is used, if no prompt string is specified.

Several input values can be read with a single `textInput` command. Each identifier in the sequence of arguments makes `textInput` return a prompt, waiting for input to be assigned to the identifier or variable. A character string preceding the identifier or variable in the argument sequence replaces the default prompt. Cf. “Example 3” on page 1-2147 (Symbolic Math Toolbox). Arguments that are neither prompt strings nor identifiers or variables are ignored.

The input may extend over several lines. In the output string, MuPAD uses the character `\n` (carriage return) to separate lines.

Input characters with a leading `\` are not interpreted as control characters, but as two separate characters.

The identifiers or variables x1 etc. may have values. These are overwritten by textinput.

## Examples

### Example 1

The default prompt is displayed, the input is converted to a character string and returned:

```
textinput()
```

```
Please enter text input: << myinput >>
```

```
"myinput"
```

### Example 2

A user-defined prompt is used, the input is assigned to the identifier x:

```
textinput("enter your name: ", x)
```

```
enter your name: << Turing >>
```

```
"Turing"
```

```
x
```

```
"Turing"
```

```
delete x:
```

### Example 3

If several values are to be read, separate prompts can be defined for each value:

```
textinput("She: ", hername, "He: ", hisname)
```

```
She: << Bonnie >> He: <<
Clyde >>
```

```
"Clyde"
```

```
hername, hisname
```

```
"Bonnie", "Clyde"
```

```
delete hername, hisname:
```

## Parameters

**prompt1, prompt2, ...**

Input prompts: character strings on page 7-53

**x1, x2, ...**

identifiers on page 7-29 or local variables on page 7-56

## Return Values

Last input, converted to a character string.

## See Also

### MuPAD Functions

`finput` | `fname` | `fprint` | `fread` | `ftextinput` | `import::readbitmap` |  
`import::readdata` | `input` | `print` | `read` | `text2expr` | `write`

# TEXTWIDTH

Maximum number of characters in an output line

## Description

The environment variable TEXTWIDTH determines the maximum number of characters in one line of screen output.

Possible values: Positive integer smaller than  $2^{31}$ .

Output is broken into several lines if it needs more than TEXTWIDTH characters per line.

Deletion via the statement `delete TEXTWIDTH` resets TEXTWIDTH to its default value. Executing the function `reset` also restores the default value.

The minimal value of TEXTWIDTH is 10.

TEXTWIDTH is set to its maximum value  $2^{31} - 1$  when printing to a text file using `fprint`. Thus, no additional line breaks occur in the output.

TEXTWIDTH does not influence the typesetting of expressions which is available for some user interfaces of MuPAD.

TEXTWIDTH is set to the new number of available columns every time the console is resized.

## Examples

### Example 1

Set the maximum number of characters in one line of screen output to 15:

```
TEXTWIDTH := 15:
```

Restore TEXTWIDTH to its default value:

```
delete TEXTWIDTH
```

## Example 2

The following procedure adds empty characters to produce output that is flushed right:

```
myprint := proc(x) local l; begin
    if domtype(x) <> DOM_STRING then
        x := expr2text(x);
    end_if;
    l := length(x);
    print(Unquoted, _concat(" " $ TEXTWIDTH - l, x))
end_proc;
```

```
myprint("hello world"): myprint(30!): myprint("bye bye"):
```

hello world

26525285981219105863630848000000

bye bye

```
delete myprint:
```

## See Also

### MuPAD Functions

PRETTYPRINT | fprintf | print

## Topics

“Set Line Length in Plain Text Outputs” (Symbolic Math Toolbox)



# theta

Theta series

## Syntax

theta(x)

## Description

theta(x) represents the value of the theta series  $\sum_{n=-\infty}^{\infty} e^{-\pi x n^2}$ .

The theta series converges for all complex numbers x with positive real part.

Floating-point results are computed for floating-point arguments. For other arguments, the function returns symbolically with the imaginary part of complex numbers normalized to lie between zero and 2.

## Environment Interactions

When called with a floating-point argument, the function is sensitive to the environment variable DIGITS which determines the numerical working precision.

## Examples

### Example 1

The theta series takes on large values for small positive arguments. Small values are taken on near  $I$ :

```
theta(0.001), theta(0.001 + I)
```

31.6227766, 5.092623095  $10^{-340}$

## Example 2

Since the theta series is  $(2i)$ -periodic, the imaginary part of complex arguments may be reduced:

```
theta(7 + 5*I)
```

theta(7 + i)

For exact or symbolic arguments, a symbolic call is returned:

```
theta(3), theta(x)
```

theta(3), theta(x)

## Parameters

**x**

An arithmetical expression (Symbolic Math Toolbox)

## Return Values

Arithmetical expression

## See Also

### MuPAD Functions

dedekindEta | zeta

# rtime

Measure real time

## Syntax

```
rtime()
```

```
rtime(a1, a2, ...)
```

## Description

`rtime()` returns the real time that elapsed since the start of the current MuPAD session. It is measured in milliseconds.

`rtime(a1, a2, ...)` returns the real time needed to evaluate all arguments.

The result of `rtime` is the real time. Thus, `rtime` can be used to measure the total time spent by the MuPAD process as well as by external processes spawned from inside the MuPAD session. Note that an interactive call of `rtime()` is not very useful because the idle time is included. However, `rtime(a1, a2, ...)` often yields a useful and more realistic timing than `time(a1, a2, ...)` if the evaluation of the arguments spawns external processes. For example, it can be useful for measuring time for numerical computations because some routines of the `numeric` library call external numerical tools using hardware floats.

If there are no running external processes besides MuPAD, the timings returned by `rtime(a1, a2, ...)` and `time(a1, a2, ...)` roughly coincide.

On computers without “time-sharing”, such as the Macintosh computer, real time and CPU time roughly coincide.

`rtime` is a function of the system kernel.

## Examples

### Example 1

Use `rtime` to compute the elapsed hours, minutes and seconds since this session was started:

```
t := rtime()/1000:
h := trunc(t/3600):
m := trunc(t/60 - h*60):
s := trunc(t - m*60 - h*3600):

print(Unquoted, "This session is running for " .
      h . " hours, " .
      m . " minutes and " .
      s . " seconds.")
```

```
This
session is running for 0 hours, 0 minutes and 10 seconds.
```

```
delete t, h, m, s:
```

## Parameters

`a1, a2, ...`

Arbitrary MuPAD objects

## Return Values

Nonnegative integer giving the elapsed time in milliseconds.

## See Also

### MuPAD Functions

`prog::profile | time`

## **Topics**

"Measure Time" (Symbolic Math Toolbox)

# time

Measure CPU time

## Syntax

```
time()
```

```
time(a1, a2, ...)
```

## Description

`time()` returns the total CPU time that was spent by the current MuPAD process. It is measured in in milliseconds.

`time(a1, a2, ...)` returns the CPU time needed by the current MuPAD process to evaluate all arguments.

The result of `time()` comprises all computation time spent by the MuPAD process. This includes the time for system initialization and reading input (parsing). However, it excludes the time spent by other external processes, even if they were spawned from inside the MuPAD session or if they were started by a `system` command. Further, in an interactive session, the idle time between the execution of MuPAD commands is excluded.

If there are no running external process besides MuPAD, the timings returned by `rtime(a1, a2, ...)` and `time(a1, a2, ...)` roughly coincide.

The time returned by `time` is computed in a system-dependent way, usually counting the number of clock ticks of the system clock. Hence, the result is a multiple of the system's time unit and cannot be more precise than one such unit. The time unit is 10 milliseconds for many UNIX systems.

On computers without “time-sharing”, such as the Macintosh computer, real time and CPU time roughly coincide.

`time` is a function of the system kernel.

## Examples

### Example 1

Do a time measurement and assign the computed value to an identifier at the same time. Note that the assignment needs extra parenthesis when passed as argument:

```
time((a := int(exp(x)*sin(x), x)))
```

```
464.029
```

```
a
```

$$-\frac{e^x (\cos(x) - \sin(x))}{2}$$

```
delete a:
```

Alternatively, measure time for groups of statements as follows:

```
t0 := time():
command1
command2
...
time() - t0
```

### Example 2

To obtain a more convenient output, multiply the measured time by the appropriate time unit:

```
time(isprime(2^1000000000 - 1))*unit::msec
```

```
280.018 msec
```

Alternatively, use `stringlib::formatTime`:

```
stringlib::formatTime(time(isprime(2^1000000000 - 1)))
```

"0.280017 seconds"

## Parameters

**a1, a2, ...**

Arbitrary MuPAD objects

## Return Values

Nonnegative integer giving the elapsed time in milliseconds.

## See Also

### **MuPAD Functions**

`prog::profile | rtime`

## Topics

"Measure Time" (Symbolic Math Toolbox)



# transpose

Transpose of a matrix

---

**Note** For the `transpose` function in MATLAB<sup>®</sup>, see `transpose`.

---

## Syntax

`transpose(A)`

## Description

`transpose(A)` returns the transpose  $A^t$  of the matrix  $A$ . The transpose of the  $m \times n$  matrix  $A$  is the  $n \times m$  matrix  $B$  such that  $B_{i,j} = A_{j,i}$ .

If the input is a matrix of category `Cat::Matrix`, then internally `linalg::transpose` computes the result. For arrays and `hfarrays`, `transpose` uses other routines.

If the argument does not evaluate to a matrix of one of these types, the transpose is the input itself.

## Examples

### Example 1

Compute the transpose of the following real matrix. For real matrices, the Hermitian transpose coincides with the transpose:

```
A := matrix([[1, 2], [3, PI]])
```

$$\begin{pmatrix} 1 & 2 \\ 3 & \pi \end{pmatrix}$$

```
transpose(A) = htranspose(A)
```

$$\begin{pmatrix} 1 & 3 \\ 2 & \pi \end{pmatrix} = \begin{pmatrix} 1 & 3 \\ 2 & \pi \end{pmatrix}$$

In general, this does not hold for complex matrices:

```
A := matrix([[1, I, 3 + I], [PI*I, 4, 5]])
```

$$\begin{pmatrix} 1 & i & 3+i \\ \pi i & 4 & 5 \end{pmatrix}$$

```
transpose(A) <> htranspose(A)
```

$$\begin{pmatrix} 1 & \pi i \\ i & 4 \\ 3+i & 5 \end{pmatrix} \neq \begin{pmatrix} 1 & -\pi i \\ -i & 4 \\ 3-i & 5 \end{pmatrix}$$

```
delete A:
```

## Example 2

If the input does not evaluate to a matrix, then the transpose is the input itself:

```
transpose(A) + 2*transpose(B)
```

$$A + 2 B$$

## Parameters

**A**

An object of the category `Cat::Matrix`, a two-dimensional array, or a two-dimensional `hfarray`.

## Return Values

Object of the same domain type as A.

## Overloaded By

A

## See Also

### MuPAD Functions

`htranspose` | `linalg::htranspose` | `linalg::transpose`

## Topics

“Transpose Matrices” (Symbolic Math Toolbox)

# httranspose

Hermitian transpose of a matrix

## Syntax

httranspose(A)

## Description

httranspose(A) returns the Hermitian transpose  $A^H$  of the matrix  $A$  (the complex conjugate of the transpose of  $A$ ). The Hermitian transpose of the  $m \times n$  matrix  $A$  is the

$n \times m$  matrix  $B$  with  $B_{i,j} = \overline{A_{j,i}}$ .

If the input is a matrix of category `Cat::Matrix`, then internally `linalg::httranspose` computes the result. For arrays and `hfarrays`, `httranspose` uses other routines.

If the argument does not evaluate to a matrix of one of these types, the transpose is the conjugate of the input.

## Examples

### Example 1

Compute the transpose of the following real matrix. For real matrices, the Hermitian transpose coincides with the transpose:

```
A := matrix([[1, 2], [3, PI]])
```

$$\begin{pmatrix} 1 & 2 \\ 3 & \pi \end{pmatrix}$$

```
transpose(A) = httranspose(A)
```

$$\begin{pmatrix} 1 & 3 \\ 2 & \pi \end{pmatrix} = \begin{pmatrix} 1 & 3 \\ 2 & \pi \end{pmatrix}$$

In general, this does not hold for complex matrices:

```
A := matrix([[1, I, 3 + I], [PI*I, 4, 5]])
```

$$\begin{pmatrix} 1 & i & 3+i \\ \pi i & 4 & 5 \end{pmatrix}$$

```
transpose(A) <> htranspose(A)
```

$$\begin{pmatrix} 1 & \pi i \\ i & 4 \\ 3+i & 5 \end{pmatrix} \neq \begin{pmatrix} 1 & -\pi i \\ -i & 4 \\ 3-i & 5 \end{pmatrix}$$

```
delete A:
```

## Example 2

Compute the product  $A^H A$  of a matrix given by a hardware float array. This data type allows matrix multiplication using the operator \*:

```
A := hffarray(1..2, 1..3, [[1, I, 3], [PI*I, 4, 5 + I]])
```

$$\begin{pmatrix} 1.0 & 1.0 i & 3.0 \\ 3.141592654 i & 4.0 & 5.0 + 1.0 i \end{pmatrix}$$

```
AH:= htranspose(A)
```

$$\begin{pmatrix} 1.0 & -3.141592654 i \\ -1.0 i & 4.0 \\ 3.0 & 5.0 - 1.0 i \end{pmatrix}$$

The product  $A^H A$  is Hermitian:

`AH*A = htranspose(AH*A)`

$$\begin{pmatrix} 10.8696044 & -11.56637061 i & 6.141592654 - 15.70796327 i \\ 11.56637061 i & 17.0 & 20.0 + 1.0 i \\ 6.141592654 + 15.70796327 i & 20.0 - 1.0 i & 35.0 \end{pmatrix} = \begin{pmatrix} 10.8696044 & -11.56637061 i & 6.141592654 - 15.70796327 i \\ 11.56637061 i & 17.0 & 20.0 + 1.0 i \\ 6.141592654 + 15.70796327 i & 20.0 - 1.0 i & 35.0 \end{pmatrix}$$

delete A, AH:

### Example 3

If the input does not evaluate to a matrix, then the transpose is the conjugate of the input:

`htranspose(A) + 2*htranspose(B)`

$$\bar{A} + 2\bar{B}$$

## Parameters

**A**

An object of the category `Cat::Matrix`, a two-dimensional array, or a two-dimensional `harray`.

## Return Values

Object of the same domain type as A.

## Overloaded By

A

## See Also

### MuPAD Functions

`linalg::htranspose` | `linalg::transpose` | `transpose`

## Topics

“Transpose Matrices” (Symbolic Math Toolbox)

## traperror

Trap errors

### Syntax

```
traperror(object)
```

```
traperror(object, t)
```

```
traperror(object, MaxSteps = s)
```

### Description

`traperror(object)` traps errors produced by the evaluation of `object`.

`traperror(object, t)` does the same. Moreover, it stops the evaluation if it is not finished after a real time of `t` seconds.

`traperror` traps errors caused by the evaluation of the object. Syntactical errors, i.e., errors on parsing the object, cannot be caught. The same holds true for fatal errors causing the termination of MuPAD.

`traperror` returns the error code 0 if no error happened. The error code is 1320 if the given time limit `t` is exceeded (“Execution time exceeded”) and 1321 if the given number of “execution steps” is exceeded. The error code is 1028 if the error was raised by the command `error`.

If `traperror` is called with a numerical second argument, this number is taken as a time limit, measured in seconds, of “process time” (see the documentation of the `time` function for a discussion of this term).

When using the option `MaxSteps = s`, the caller sets a time limit which is not system-dependent, but rather measured in terms of MuPAD evaluation steps.

The number `s` does *not* refer directly to evaluation steps, but rather to a fixed (large) number of steps which may change from one MuPAD release to the next, but is fixed



within one release. The number `s` is twice the number of outputs caused by `Pref::report(9)` for a calculation using the maximum time allowed.

If `traperror` has no time limit set and an “Execution time exceeded” error is raised by an enclosing `traperror(..., t)` command, then this error is not trapped by the inner `traperror`. It is trapped by the `traperror` call that has set the time limit. Cf. “Example 5” on page 1-2169 (Symbolic Math Toolbox).

The object can be an assignment which, for syntactical reasons, must be enclosed in additional brackets. The following code fragment demonstrates a typical application of `traperror`:

```
if traperror((x := SomeErrorProneFunction())) = 0 then
    DoSomethingWith(x);
else RespondToTheError();
end_if;
```

Use `lasterror` to reproduce the trapped error.

## Examples

### Example 1

Errors that happen during the execution of kernel functions have various error codes, depending on the problem. E.g., “Division by zero” produces the error code 1025:

```
y := 1/x: traperror(subs(y, x = 0))
```

```
1025
```

```
lasterror()
```

```
Error: Division by zero. [_power]
```

### Example 2

All errors raised using the function `error` have the error code 1028. Errors during the execution of library functions are of this kind:

```
traperror(error("My error!"))
```

```
1028
```

```
lasterror()
```

```
Error: My error!
```

### Example 3

We try to factor a polynomial, but give up after ten seconds:

```
traperror(factor(x^1000 + 4*x + 1), 10)
```

```
1320
```

```
lasterror()
```

```
Error: Execution time exceeded; Evaluating:  
faclib::univ_mod_gcd
```

### Example 4

For use inside other routines, it is preferable to use `MaxSteps` instead of a time limit, to achieve consistent results across slower and faster machines:

```
traperror(factor(x^1000 + 4*x + 1), MaxSteps=10)
```

```
1321
```

```
lasterror()
```

```
Error: Execution MaxSteps exceeded [traperror];  
Evaluating: faclib::ddf
```

Note that evaluation steps may take vastly different amounts of time, so even on the same machine, different expressions evaluated with the same value of `MaxSteps` may be terminated after very different lengths of time:

```
time(traperror(factor(x^1000 + 4*x + 1), MaxSteps=1));
time(traperror(while TRUE do 1 end_while, MaxSteps=1));
time(traperror(int(1/sqrt(1/r-1/r0), r=0..r0), MaxSteps=1))
```

```
2204
```

```
40
```

```
468
```

## Example 5

Here we have two nested `traperror` calls. The inner call contains an unterminated loop and the outer call has a time limit of 2 seconds. When the execution time is exceeded, this special error is not trapped by the inner `traperror` call. Because of the error, `print(1)` is never executed:

```
traperror((traperror((while TRUE do 1 end)); print(1)), 2)
```

```
1320
```

```
lasterror()
```

```
Error: Execution time exceeded.
```

## Parameters

### object

Any MuPAD object

### t

The time limit: a positive integer

**s**

The execution limit: a positive integer

## **Return Values**

Nonnegative integer.

## **See Also**

### **MuPAD Functions**

`error` | `getlasterror` | `lasterror`

# triangularPulse

Triangular pulse function

## Syntax

`triangularPulse(a, b, c, x)`

`triangularPulse(a, c, x)`

## Description

`triangularPulse(a, b, c, x)` represents the triangular function.

`triangularPulse(a, c, x)` is a shortcut for `triangularPulse(a, (a + c)/2, c, x)`.

`triangularPulse(x)` is a shortcut for `triangularPulse(-1, 0, 1, x)`.

`triangularPulse` represents the triangular pulse function. This function is also called the triangle function, hat function, tent function, or sawtooth function.

If  $a$ ,  $b$ , and  $c$  are variables or expressions with variables, `triangularPulse` assumes that  $a \leq b \leq c$ . If  $a$ ,  $b$ , and  $c$  are numerical values that do not satisfy this condition, `triangularPulse` throws an error.

If  $a < x < b$ , the triangular function equals  $(x - a)/(b - a)$ . If  $b < x < c$ , the triangular function equals  $(c - x)/(c - b)$ . Otherwise, it equals 0. See “Example 1” on page 1-2172 (Symbolic Math Toolbox) and “Example 2” on page 1-2172 (Symbolic Math Toolbox).

If  $a = b$  or  $b = c$ , the triangular function can be expressed in terms of the rectangular function. See “Example 3” on page 1-2173 (Symbolic Math Toolbox).

If  $a = b = c$ , `triangularPulse` returns 0. See “Example 4” on page 1-2173 (Symbolic Math Toolbox).

`triangularPulse(x)` is equivalent to `triangularPulse(-1, 0, 1, x)`. See “Example 5” on page 1-2173 (Symbolic Math Toolbox).

`triangularPulse(a, c, x)` is equivalent to `triangularPulse(a, (a + c)/2, c, x)`. See “Example 6” on page 1-2174 (Symbolic Math Toolbox).

`triangularPulse` also accepts infinities as its arguments. See “Example 9” on page 1-2175 (Symbolic Math Toolbox).

`triangularPulse` and `tripulse` are equivalent.

## Examples

### Example 1

Compute the triangular pulse function for these input arguments:

```
[triangularPulse(-2, 0, 2, -3),  
 triangularPulse(-2, 0, 2, -1/2),  
 triangularPulse(-2, 0, 2, 0),  
 triangularPulse(-2, 0, 2, 3/2),  
 triangularPulse(-2, 0, 2, 3)]
```

```
[0, 3/4, 1, 1/4, 0]
```

### Example 2

Compute the triangular pulse function for  $a < x < b$ :

```
triangularPulse(a, b, c, x) assuming a < x < b
```

```

$$\frac{a-x}{a-b}$$

```

Compute the triangular pulse function for  $b < x < c$ :

```
triangularPulse(a, b, c, x) assuming b < x < c
```

$$-\frac{c-x}{b-c}$$

### Example 3

Compute the triangular pulse function for  $a = b$  and  $c = b$ :

`triangularPulse(b, b, c, x)` assuming  $b < c$

$$-\frac{(c-x) \text{rectangularPulse}(b, c, x)}{b-c}$$

`triangularPulse(a, b, b, x)` assuming  $a < b$

$$\frac{(a-x) \text{rectangularPulse}(a, b, x)}{a-b}$$

### Example 4

For  $a = b = c$ , the triangular pulse function returns 0:

`triangularPulse(a, a, a, x)`

$$0$$

### Example 5

Use `triangularPulse` with one input argument as a shortcut for computing `triangularPulse(-1, 0, 1, x)`:

`triangularPulse(x)`

$$\text{triangularPulse}(-1, 0, 1, x)$$

`[triangularPulse(-10),  
triangularPulse(-3/4),`

```
triangularPulse(0),  
triangularPulse(2/3),  
triangularPulse(1)]
```

$$\left[0, \frac{1}{4}, 1, \frac{1}{3}, 0\right]$$

## Example 6

Use `triangularPulse` with three input arguments as a shortcut for computing `triangularPulse(a, (a + c)/2, c, x)`:

```
triangularPulse(a, c, x)
```

$$\text{triangularPulse}\left(a, \frac{a}{2} + \frac{c}{2}, c, x\right)$$

```
[triangularPulse(-10, 10, 3),  
triangularPulse(-1/2, -1/4, -2/3),  
triangularPulse(2, 4, 3),  
triangularPulse(2, 4, 6),  
triangularPulse(-1, 4, 0)]
```

$$\left[\frac{7}{10}, 0, 1, 0, \frac{2}{5}\right]$$

## Example 7

Rewrite the triangular pulse function in terms of the Heaviside step function:

```
rewrite(triangularPulse(a, b, c, x), heaviside)
```

$$\frac{\text{heaviside}(x-a)(a-x)}{a-b} - \frac{\text{heaviside}(x-b)(a-x)}{a-b} - \frac{\text{heaviside}(x-b)(c-x)}{b-c} \\ + \frac{\text{heaviside}(x-c)(c-x)}{b-c}$$



## Example 8

Plot the triangular pulse function:

```
plot(triangularPulse(x), x = -2..2)
```

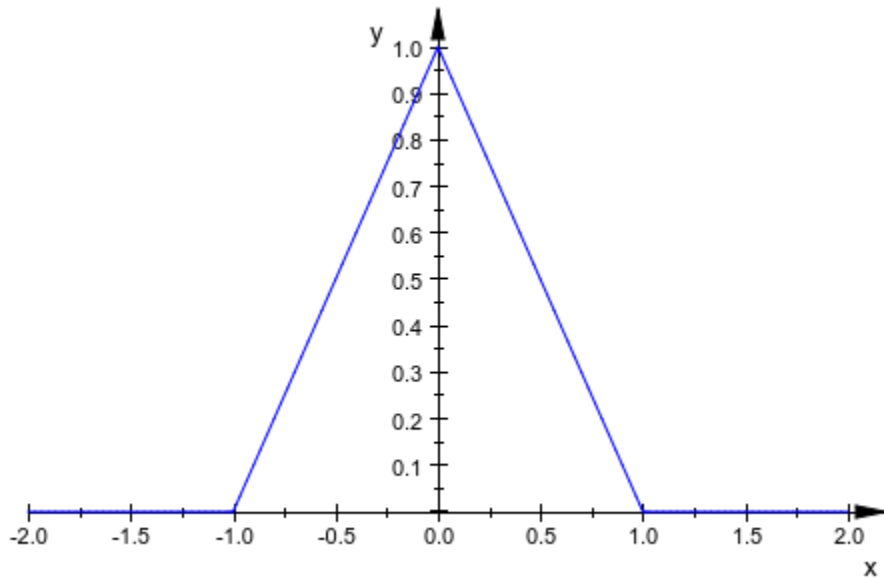

## Example 9

Plot the triangular pulse function for which the argument c is a positive infinity:

```
plot(triangularPulse(-1, 1, infinity, x))
```



## Parameters

**a, b, c, x**

Arithmetical expressions (Symbolic Math Toolbox).

## Return Values

Arithmetical expression.

## Overloaded By

x

## See Also

### MuPAD Functions

heaviside | piecewise | rectangularPulse

# tripulse

Triangular pulse function

## Syntax

`tripulse(a, b, c, x)`

`tripulse(a, c, x)`

## Description

`tripulse(a, b, c, x)` represents the triangular function.

`tripulse(a, c, x)` is a shortcut for `tripulse(a, (a + c)/2, c, x)`.

`tripulse(x)` is a shortcut for `tripulse(-1, 0, 1, x)`.

`tripulse` and `triangularPulse` are equivalent. These functions represent the triangular pulse function. For details and examples, see `triangularPulse`.

## Parameters

**a, b, c, x**

Arithmetical expressions (Symbolic Math Toolbox).

## Return Values

Arithmetical expression.

## Overloaded By

x

## See Also

### MuPAD Functions

heaviside | piecewise | rectangularPulse | triangularPulse

# TRUE

Boolean constant TRUE

## Description

MuPAD uses a three state logic with the Boolean constants TRUE, FALSE, and UNKNOWN.

The Boolean constants TRUE, FALSE, UNKNOWN are of domain type DOM\_BOOL.

See and, or, not on page 1-131 for the logical rules of the MuPAD three state logic.

Boolean constants are returned by system functions such as `bool` and `is`. These functions evaluate Boolean expressions such as equations on page 1-19 and inequalities on page 1-30.

## Examples

### Example 1

The Boolean constants may be combined via and, or, and not:

```
(TRUE and (not FALSE)) or UNKNOWN
```

```
TRUE
```

### Example 2

The function `bool` serves for reducing Boolean expressions such as equations or inequalities to one of the Boolean constants:

```
bool(x = x and 2 < 3 and 3 <> 4 or UNKNOWN)
```

```
TRUE
```

The function `is` evaluates symbolic Boolean expressions with properties on page 1-265:

```
assume(x > 2): is(x^2 > 4), is(x^3 < 0), is(x^4 > 17)
```

TRUE, FALSE, UNKNOWN

```
unassume(x):
```

### Example 3

Boolean constants occur in the conditional part of program control structures such as `if`, `repeat`, or `while` statements. The following loop searches for the smallest Mersenne prime larger than 500 (see `numLib::mersenne` for details). The function `isprime` returns TRUE if its argument is a prime, and FALSE otherwise. Once a Mersenne prime is found, the `while`-loop is interrupted by the `break` statement:

```
p := 500:
while TRUE do
  p := nextprime(p + 1):
  if isprime(2^p - 1) then
    print(p);
    break;
  end_if;
end_while:
```

521

Note that the conditional part of `if`, `repeat`, and `while` statements must evaluate to TRUE or FALSE. Any other value leads to an error:

```
if UNKNOWN then "true" else "false" end_if
```

```
Error: Unable to evaluate to Boolean. [if]
```

```
delete p:
```

## See Also

### **MuPAD Domains**

DOM\_BOOL

### **MuPAD Functions**

FALSE | UNKNOWN | \_lazy\_and | \_lazy\_or | and | bool | if | is | not | or | repeat | while



# FALSE

Boolean constant FALSE

## Description

MuPAD uses a three state logic with the Boolean constants TRUE, FALSE, and UNKNOWN.

The Boolean constants TRUE, FALSE, UNKNOWN are of domain type DOM\_BOOL.

See and, or, not on page 1-131 for the logical rules of the MuPAD three state logic.

Boolean constants are returned by system functions such as `bool` and `is`. These functions evaluate Boolean expressions such as equations on page 1-19 and inequalities on page 1-30.

## Examples

### Example 1

The Boolean constants may be combined via and, or, and not:

```
(TRUE and (not FALSE)) or UNKNOWN
```

```
TRUE
```

### Example 2

The function `bool` serves for reducing Boolean expressions such as equations or inequalities to one of the Boolean constants:

```
bool(x = x and 2 < 3 and 3 <> 4 or UNKNOWN)
```

```
TRUE
```

The function `is` evaluates symbolic Boolean expressions with properties on page 1-265:

```
assume(x > 2): is(x^2 > 4), is(x^3 < 0), is(x^4 > 17)
```

**TRUE, FALSE, UNKNOWN**

```
unassume(x):
```

### Example 3

Boolean constants occur in the conditional part of program control structures such as `if`, `repeat`, or `while` statements. The following loop searches for the smallest Mersenne prime larger than 500 (see `numLib::mersenne` for details). The function `isprime` returns `TRUE` if its argument is a prime, and `FALSE` otherwise. Once a Mersenne prime is found, the `while`-loop is interrupted by the `break` statement:

```
p := 500:
while TRUE do
  p := nextprime(p + 1):
  if isprime(2^p - 1) then
    print(p);
    break;
  end_if;
end_while:
```

**521**

Note that the conditional part of `if`, `repeat`, and `while` statements must evaluate to `TRUE` or `FALSE`. Any other value leads to an error:

```
if UNKNOWN then "true" else "false" end_if
```

```
Error: Unable to evaluate to Boolean. [if]
```

```
delete p:
```

## See Also

### MuPAD Domains

DOM\_BOOL

### MuPAD Functions

TRUE | UNKNOWN | \_lazy\_and | \_lazy\_or | and | bool | if | is | not | or | repeat | while

## UNKNOWN

Boolean constant UNKNOWN

### Description

MuPAD uses a three state logic with the Boolean constants TRUE, FALSE, and UNKNOWN.

The Boolean constants TRUE, FALSE, UNKNOWN are of domain type DOM\_BOOL.

See and, or, not on page 1-131 for the logical rules of the MuPAD three state logic.

Boolean constants are returned by system functions such as `bool` and `is`. These functions evaluate Boolean expressions such as equations on page 1-19 and inequalities on page 1-30.

### Examples

#### Example 1

The Boolean constants may be combined via and, or, and not:

```
(TRUE and (not FALSE)) or UNKNOWN
```

```
TRUE
```

#### Example 2

The function `bool` serves for reducing Boolean expressions such as equations or inequalities to one of the Boolean constants:

```
bool(x = x and 2 < 3 and 3 <> 4 or UNKNOWN)
```

```
TRUE
```

The function `is` evaluates symbolic Boolean expressions with properties on page 1-265:

```
assume(x > 2): is(x^2 > 4), is(x^3 < 0), is(x^4 > 17)
```

TRUE, FALSE, UNKNOWN

```
unassume(x):
```

### Example 3

Boolean constants occur in the conditional part of program control structures such as `if`, `repeat`, or `while` statements. The following loop searches for the smallest Mersenne prime larger than 500 (see `numLib::mersenne` for details). The function `isprime` returns TRUE if its argument is a prime, and FALSE otherwise. Once a Mersenne prime is found, the `while`-loop is interrupted by the `break` statement:

```
p := 500:
while TRUE do
  p := nextprime(p + 1):
  if isprime(2^p - 1) then
    print(p);
    break;
  end_if;
end_while:
```

521

Note that the conditional part of `if`, `repeat`, and `while` statements must evaluate to TRUE or FALSE. Any other value leads to an error:

```
if UNKNOWN then "true" else "false" end_if
```

```
Error: Unable to evaluate to Boolean. [if]
```

```
delete p:
```

## See Also

### **MuPAD Domains**

DOM\_BOOL

### **MuPAD Functions**

FALSE | TRUE | \_lazy\_and | \_lazy\_or | and | bool | if | is | not | or | repeat | while

# type

Type of an object

## Syntax

```
type(object)
```

## Description

`type(object)` returns the type of the object.

If `object` is not an expression of domain (Symbolic Math Toolbox) type `DOM_EXPR`, then `type(object)` is equivalent to `domtype(object)`, i.e., `type` returns the domain type of the object.

If `object` is an expression of domain type `DOM_EXPR`, then its type is determined by its 0-th operand (the "operator"). If the operator has a "type" slot, then `type` returns this value, which usually is a string. If the operator has no "type" slot, then `type` returns the string "function".

In contrast to most other functions, `type` does not flatten (Symbolic Math Toolbox) arguments that are expression sequences on page 1-88. Cf. "Example 4" on page 1-2190 (Symbolic Math Toolbox).

## Examples

### Example 1

If an object is not an expression, its type equals its domain type:

```
type(3)
```

```
DOM_INT
```

## Example 2

The operator of a sum is `_plus`; the type slot of that operator is `"_plus"`:

```
type(x + y*z)
```

```
"_plus"
```

`type` evaluates its argument: thereby, the difference of `x` and `y` becomes the sum of `x` and `(-1)*y`. Its type is not `"_subtract"`, but `"_plus"`:

```
type(x - y)
```

```
"_plus"
```

## Example 3

If the operator of an expression is not a function environment having a type slot, the expression is of type `"function"`:

```
type(f(2))
```

```
"function"
```

## Example 4

The following call to `type` is *not* regarded as a call with two arguments, because expression sequences in the argument are not flattened (Symbolic Math Toolbox):

```
type((2, 3))
```

```
"_exprseq"
```



## Parameters

**object**

Any MuPAD object

## Return Values

Domain type of type `DOM_DOMAIN` or a character string.

## Overloaded By

object

## See Also

### **MuPAD Functions**

coerce | domtype | hastype | testtype

## unassume

Delete the properties of an identifier

### Syntax

```
unassume(x)
```

### Description

`unassume(x)` deletes the properties of the identifier `x`.

`unassume` serves for deleting properties (Symbolic Math Toolbox) of identifiers set via `assume`. See “Properties” (Symbolic Math Toolbox) for a description of the property mechanism.

If `x` is a list or a set of identifiers, then the properties of all specified identifiers are deleted.

The command `delete x` deletes the value and the properties of the identifier `x`.

### Examples

#### Example 1

Properties are attached to the identifiers `x` and `y`:

```
assume(x > 0): assume(y < 0): getprop(x), getprop(y)
```

```
(0, ∞), (-∞, 0)
```

```
sign(x), sign(y)
```

```
1, -1
```

unassume or delete deletes the properties:

```
unassume(x): delete y: getprop(x), getprop(y)
```

**C, C**

```
sign(x), sign(y)
```

**sign(x), sign(y)**

The properties of several identifiers can be deleted simultaneously by passing a list or a set to unassume:

```
assume(x > y): unassume([x, y]): getprop(x), getprop(y)
```

**C, C**

## Parameters

**x**

An identifier on page 7-29 or a list on page 7-41 or a set on page 7-50 of identifiers

## Return Values

Void object null().

## See Also

### MuPAD Functions

assume | delete | getprop | is

# undefined

Undefined value

## Description

undefined indicates results of mathematically undefined operations.

MuPAD uses the special value `undefined` to indicate the results of operations that are not defined in mathematics.

You can use the `undefined` value as an input. Arithmetical operations involving `undefined` also return `undefined`. Multiplying infinities by 0 returns `undefined`.

For floating-point values, MuPAD uses the special value `RD_NAN` instead of `undefined`. If you use typeset mode, MuPAD displays `RD_NAN` as NaN in output regions. Multiplying infinities `RD_INF` and `RD_NINF` by 0 returns `RD_NAN`.

## Examples

### Example 1

Perform the following operations with infinities. MuPAD returns the `undefined` value for these operations:

```
0*infinity, infinity - infinity, infinity/infinity
```

```
undefined, undefined, undefined
```

### Example 2

Compute the limit of the sine function at infinity. Since this limit does not exist (is not mathematically defined), MuPAD returns `undefined`:

```
limit(sin(x), x = infinity)
```

undefined

### Example 3

Multiply infinities by 0:

`infinity*0, -infinity*0`

undefined, undefined

`RD_INF*0, RD_NINF*0`

NaN, NaN

## See Also

### MuPAD Functions

FAIL

### Topics

“Mathematical Constants Available in MuPAD” (Symbolic Math Toolbox)

# unit

Units of measurement

---

**Note** For units in MATLAB®, see “Units of Measurement Tutorial” (Symbolic Math Toolbox).

---

## Syntax

`unit::n`

## Description

`unit::n` represents the unit of measurement *n*, where *n* follows commonly used names. For example, the units `unit::m`, `unit::meter`, and `unit::metre` all represent the physical unit *meter*. These `unit` objects are domain objects (Symbolic Math Toolbox) of domain type (Symbolic Math Toolbox) `unit`. You can use these units in arithmetical expressions as symbolic identifiers. For example, `3*unit::m^2`. You must use units consistently in expressions, and you must specify units for unknown variables so that the variables themselves are dimensionless. For details, see “Example 3” on page 1-2198 (Symbolic Math Toolbox).

Expressions containing units are not combined or simplified automatically. Use `simplify` or `Simplify` to simplify expressions containing units. Use `unit::convert` to convert between units.

For a list of all implemented units, see “List of Units” on page 1-2201 (Symbolic Math Toolbox).

## Examples

### Example 1

Create an expression using different units of length. The common names of units work as expected.

```
27*unit::cm + 30*unit::mm
```

27 cm + 30 mm

Because MuPAD does not simplify this expression automatically, use the `simplify` function to simplify the expression.

```
simplify(%)
```

30 cm

Simplify an expression involving several different units.

```
simplify(1234*unit::g + 1.234*unit::kg*unit::m^2/unit::inch^2)
```

1913937.825 g

### Example 2

Convert between any two units using `unit::convert`.

Convert ounce to kilograms. `unit::convert` returns an exact conversion. Use `float` to obtain a floating-point result.

```
unit::convert(unit::ounce, unit::kilogram)
```

$\frac{45359237 \text{ kg}}{1600000000}$

```
float(%)
```

0.02834952312 kg

Use `unit::convert` to convert between units that are not of the same type. For example, convert Newton-meter, which is a unit of torque, to Watts, which is a unit of power.

```
unit::convert(1.23*unit::Nm, unit::W)
```

1.23 W s

Rewrite the target unit, Newton-meter, in terms of a composite expression in grams, centimeters, and milliseconds.

```
unit::convert(unit::Nm, unit::g*unit::cm^2/unit::ms^2)
```

$10 \frac{\text{cm}^2 \text{g}}{\text{ms}^2}$

Try to convert kg inch<sup>2</sup>/mm to cm. `unit::convert` has no effect on units it cannot convert.

```
unit::convert(1.23*unit::kg*unit::inch^2/unit::mm, unit::cm)
```

79.35468 cm kg

### Example 3

For numerical computations, explicitly specify units such that the variables themselves are dimensionless. If you apply units inconsistently, you might not get the desired result.

Demonstrate this issue by omitting the unit for an unknown variable in an expression. Substitute for the variable with a number and evaluate the expression using `float`. The `float` function cannot evaluate the expression.

```
L := 1*unit::m:  
y := 0.1*unit::m:  
f := y - x*cos(L/x):  
float(subs(f, x = 1/PI))
```



0.1 m - 0.3183098862 cos(3.141592654 m)

Evaluate the expression by specifying units consistently. Now, the unknown variable  $x$  is dimensionless.

```
f := y - x*unit::m*cos(L/(x*unit::m)):
float(subs(f, x = 1/PI))
```

0.4183098862 m

## Example 4

Add new units using `unit::newUnit`.

Add a velocity unit to the `unit` domain.

```
unit::newUnit(SpeedOfLight = 300000*unit::km/unit::s)
```

SpeedOfLight

You can use the unit `unit::SpeedOfLight` like any other unit. Use `unit::SpeedOfLight` to define another velocity unit.

```
unit::newUnit(Warp9 = 1.516*unit::SpeedOfLight)
```

Warp9

Convert 123.4 miles per hour into the new speed units.

```
unit::convert(123.4*unit::mile/unit::hour, unit::SpeedOfLight)
```

0.0000001838824533 SpeedOfLight

```
unit::convert(123.4*unit::mile/unit::hour, unit::Warp9)
```

0.0000001212944943 Warp9

## Example 5

Use the conversion methods to convert between different systems of units.

Use `unit::convert2SIunits` to convert a mass expressed in non-metric units to SI units.

```
mass := 2*unit::cal*unit::ms^2/unit::inch^2 - 45*unit::carat
```

$$2 \frac{\text{cal}_T \text{ms}^2}{\text{inch}^2} - 45 \text{ ct}$$

```
unit::convert2SIunits(mass)
```

$$\frac{64179 \text{ kg}}{16129000}$$

```
delete mass:
```

Convert a temperature of 20 degrees Celsius into the Fahrenheit temperature scale using `unit::Celsius2Fahrenheit`.

```
unit::Celsius2Fahrenheit(20)
```

68

## Example 6

You can use most functions such as `diff`, `factor`, and `normal` with `unit`. These functions treat units like ordinary symbolic identifiers.

Use `diff`, `factor`, and `normal` with `unit`.

```
diff(x/unit::m*exp(-x^2/unit::m^2), x)
```

$$e^{-x^2 \frac{1}{m^2}} \frac{1}{m} - 2 x^2 e^{-x^2 \frac{1}{m^2}} \frac{1}{m^3}$$

```
factor(%)
```

$$-\frac{2x^2 - m^2}{e^{\frac{x^2}{m^2}}} \frac{1}{m^3}$$

```
normal((4*unit::m^2 - a^2*unit::m^2)/(2*unit::m - a*unit::m))
```

$$2m + am$$

## Parameters

**n**

The name of the physical unit. Expand the following list for all implemented units. You can represent a unit by multiple names. For example, you can represent a meter by `unit::m`, `unit::meter`, and `unit::metre`.

## List of Units

### Length —

- am, f (= Fermi = fermi), XU (= Xu = xu = XE), pm
- Ao (= Angstroem = angstroem = Angstrom = angstrom)
- nm (= nanometer)
- My (= micron = micrometer)
- mm (= millimeter), cm (= centimeter)
- dm (= decimeter), m (= meter)
- dam, hm, km (= kilometer), Mm, Gm, Tm, Pm, Em
- pt (= point), inch
- ft (= foot), ft\_US (= foot\_US)
- yd (= yard), mile, nmile, inm (= INM)

- AU (= AE), ly (= lightyear = Lj = lj), pc (= parsec)
- ch, fm (= fathom), fur (= furlong), gg, hand
- li (= link), line, mil, rod (= perch = pole), span

**Mass —**

- ag, fg, pg, ng, mcg (= mcgram = microgram)
- mg (= milligram), cg, dg, g (= gram), hg
- kg (= kilogram), Mg, Gg, Tg, Pg, Eg
- t, kt, Mt, ct (= carat = Kt = Karat = karat)
- oz (= ounce)
- lb (= pound), stone, cwt (= sh\_cwt)
- cwt\_UK (= long\_cwt = gross\_cwt), tn (= ton = short\_ton), ton\_UK
- long\_ton (= gross\_ton), slug, gr, dr, quarter, cental

**Time —**

- as, fs, ps, ns (= nsec = nanosec = nanosecond)
- mcsec (= mcsecond = microsec = microsecond)
- ms (= msec = millisec = millisecond), cs, ds
- s (= sec = second), das, hs, ks
- Ms, Gs, Ts, Es, Ps, min (= minute = Minute)
- h (= hour), d (= day)
- week, month
- year

**Temperature —**

- K (= kelvin = Kelvin), Fahrenheit (= fahrenheit), Celsius (= celsius)
- Rankine (= rankine), Reaumur (= reaumur)

**Plain Angle —**

- degree , rad (= radian)

**Solid Angle —**

- sr (= steradian)

**Data Size, Storage Capacity —**

- bit (= Bit), kbit (= kBit), Mbit (= MBit), Gbit (= GBit), Tbit (= TBit)
- byte (= Byte), kbyte (= kByte), Mbyte (= MByte), Gbyte (= GByte)
- Tbyte (= TByte)

**Data Rate (Bits per Second) —**

- bps

**Signal Rate (= Frequency) —**

- Bd (= Baud = baud)

**Velocity —**

- knot, knot\_UK, mach

**Acceleration —**

- Gal, gn

**Force —**

- aN, fN, nN, pN, mcN, mN, cN, dN, N (= Newton = newton), daN, hN, kN, MN, GN
- TN, PN, EN, p (= pond = Pond), kp (= kilopond = Kilopond), dyn, pdl, lbf
- ozf, tonf

**Torque —**

- aNm, fNm, pNm, nNm, mcNm, mNm, cNm, dNm, Nm (= Newtonmeter = newtonmeter)
- daNm, hNm, kNm, MNm, GNm, TNm, PNm, ENm, kpm

**Angular Momentum —**

- aNms, fNms, pNms, nNms, mcNms, mNms, cNms, dNms
- Nms (= Newtonmetersec = newtonmetersec)

- daNms, hNms, kNms, MNms, GNms, PNms, ENms, TNms

**Energy, Work —**

- aJ (= aWs), fJ (= fWs), pJ (= pWs), nJ (= nWs), mcJ (= mcWs = microWs)
- mJ (= mJoule = mjoule = mWs), cJ (= cWs), dJ (= dWs)
- J (= Joule = joule = Ws), daJ (= daWs), hJ (= hWs)
- kJ (= kJoule = kjoule = kW), MJ (= MJoule = Mjoule = MWs)
- GJ (= GWs), TJ (= TWs), PJ (= PWs), EJ (= EWs), Wh, kWh, MWh, GWh
- cal (= Calory = calory), kcal, aeV, feV, peV, neV, mceV, meV, ceV, deV, eV
- daeV, heV, keV, MeV, GeV, TeV, PeV, EeV, PSh, erg, Btu, therm

**Power —**

- aW, fW, pW, nW, mcW (= mcWatt = mcwatt = microW = microWatt = microwatt)
- mW (= mWatt = mwatt), cW, dW, W (= Watt = watt), daW, hW
- kW (= kWatt = kwatt), MW (= MWatt = Mwatt), GW (= GWatt = Gwatt)
- TW, PW, EW, hp (= bhp)

**Frequency —**

- aHz, fHz, pHz, nHz, mcHz, mHz, cHz, dHz, Hz (= Hertz = hertz), daHz, hHz
- kHz (= kHertz = khertz), MHz (= MHertz = Mhertz)
- GHz (= GHertz = Ghertz), THz, PHz, EHz

**Pressure, Stress —**

- aPa, fPa, pPa, nPa, mcPa, mPa, cPa, dPa, Pa (= Pascal = pascal)
- daPa, hPa (= hPascal = hpascal), kPa, MPa, GPa, TPa, PPa, EPa
- mcbar (= mcBar = microbar = microBar), mbar (= mBar), bar (= Bar)
- kbar (= kBar), at (= ata = atu), atm, mmH<sub>2</sub>O (= mmWS), mH<sub>2</sub>O (= mWS)
- inH<sub>2</sub>O, ftH<sub>2</sub>O, mmHg, mHg, inHg, psi, Torr

**Area —**

- a (= are = Ar), ac (= acre), b (= barn), ha (= hectare)

- ro (= rood), township, circ\_mil, circ\_inch

#### **Volume —**

- al, fl, pl, nl, mcl, ml, cl, dl, l (= Liter = liter = Litre = litre), dal
- hl, kl, Ml, Gl, Tl, Pl, El, gal (= gallon), gal\_UK, barrel, bu\_UK, chaldron
- pottle, pint\_UK, pk\_UK, qt\_UK, gill, gill\_UK, floz, floz\_UK, fldr, fldr\_UK
- minim, minim\_UK, liq\_qt, liq\_pt, dry\_bu, dry\_pk, bbl, dry\_gal, dry\_qt, dry\_pt

#### **European Currency —**

- cent (= Cent), EUR (= EURO = Euro), ATS, DEM (= DM), BEF, ESP, FIM, FRF, LUF
- NLG, PTE, IEP, ITL

#### **Molecular Substance —**

- fmol, amol, pmol, nmol, mcmol (= mMol = micromol = microMol)
- mmol (= mMol), cmol, dmol, mol (= Mol), damol, hmol, kmol (= kMol), Mmol
- Gmol, Tmol, Pmol, Emol

#### **Electric Current, Amperage —**

- aA, fA, pA, nA (= nAmpere = nampere)
- mcA (= microA = microAmpere = microampere), mA (= mAmpere = mampere)
- cA, dA, A (= ampere = Ampere), daA, hA, kA (= kAmpere = kampere), MA, GA
- TA, PA, EA, Bi (= Biot = biot), Gb (= Gilbert = gilbert)

#### **Electric Voltage —**

- aV, fV, pV, nV (= nanoV = nVolt = nvolt)
- mcV (= microV = mCVolt = mcvolt), mV (= mVolt = mvolt), cV, dV
- V (= Volt = volt), daV, hV
- kV (= kVolt = kvolt)
- MV (= MVolt = Mvolt), GV (= GVolt = Gvolt), TV, PV, EV

**Electric Resistance —**

- a0hm (= aohm), f0hm (= fohm), p0hm (= pohm), n0hm (= nohm)
- mc0hm (=mcohm = micro0hm = microohm)
- m0hm (= mohm = milli0hm = milliohm), d0hm (= dohm), c0hm (= coh)
- 0hm (= ohm), da0hm (= daohm), h0hm (= hohm), k0hm (= kohm), M0hm (= Mohm)
- G0hm (= Gohm), T0hm (= Tohm), P0hm (= Pohm), E0hm (= Eohm)

**Electric Charge —**

- aC, fC, pC, nC, mcC, mC, cC, dC, C (= Coulomb = coulomb), daC, hC, kC, MC, GC, TC
- PC, EC

**Electric Capacity —**

- aF, fF, pF (= pFarad = pfarad), nF (= nFarad = nfarad)
- mcF (= mcFarad = mcfarad = microF = microFarad = microfarad)
- mF (= mFarad = mfarad), cF, dF, F (= Farad = farad), daF, hF
- kF (= kFarad = kfarad) , MF, GF, TF, PF, EF

**Electric Conductance —**

- S (= Siemens = siemens)

**Magnetic Inductance —**

- H (= Henry = henry)

**Magnetic Flux Density, Magnetic Inductivity —**

- T (= Tesla = tesla), G (= Gauss = gauss)

**Magnetic Flux —**

- Wb (= Weber = weber), M (= Maxwell = maxwell)

**Magnetic Field Strength —**

- 0e (= Oersted = oersted)



**Magnetomotive Force (= Electric Current) —**

- Gb (= Gilbert = gilbert)

**Luminous Intensity —**

- fcd, acd, pcd, ncd, mccd, mcd, ccd, dcd, cd (= candela = Candela), dacd, hcd
- kcd, Mcd, Gcd, Tcd, Pcd, Ecd, HK, IK

**Luminance —**

- sb (= stilb), asb (= apostilb)

**Luminous Flux —**

- lm (= lumen)

**Illuminance —**

- lx (= lux), ph (= phot), nx

**Radiation —**

- langley

**Radioactivity —**

- aBq, fBq, pBq, nBq, mCBq, mBq, cBq, dBq, Bq (= Becquerel = becquerel), daBq
- hBq, kBq, MBq, GBq, TBq, PBq, EBq, Ci (= Curie)

**Equivalent Dosage —**

- aSv, fSv, pSv, nSv, mCSv, mSv, cSv, dSv
- Sv (= Sievert = sievert), daSv, hSv, kSv, MSv, GSv, TSv, PSv, ESv
- arem, frem, prem, nrem, mcrem, mrem, crem, drem
- rem (= Rem), darem, hrem, krem, Mrem, Grem, Trem, Prem, Erem

**Absorbed Dosage —**

- aGy, fGy, pGy, nGy, mcGy, mGy, cGy, dGy, Gy (= Gray = gray), daGy, hGy, kGy, MGy, GGy

- TGy, PGy, EGy, rd

**Ionizing Dosage —**

- R (= Roentgen)

**Lens Power —**

- dpt (= diopter = dioptre)

**Dynamic Viscosity —**

- P (= Poise)

**Kinematic Viscosity —**

- St (= Stokes)

**Mass Per Length —**

- tex, den (= denier)

## Methods

**convert — Convert between units**

`unit::convert(x, targetunit)` converts all units in the arithmetical expression `x` to the `targetunit` if possible. The `targetunit` can be a unit (such as `unit::m`) or an arithmetical expression (such as `unit::km/unit::s`). In the second case, `convert` rewrites `x` in terms of the units found in `targetunit`. See “Example 2” on page 1-2197 (Symbolic Math Toolbox).

**convert2SIunits — Rewrite to SI units**

`unit::convert2SIunits(x)` rewrites all units in the arithmetical expression `x` in terms of corresponding SI base units. See “Example 5” on page 1-2200 (Symbolic Math Toolbox).

**display — Format for output**

`unit::display(x)` formats the displayed output of the arithmetical expression `x` such that the units appear as a separate factor at the end of each term.

**findUnits — Find all units in expression**

`unit::findUnits(x)` returns the set of all units found in the arithmetical expression `x`.

**newUnit — Define a new unit**

`unit::newUnit(newname = f*oldunit)` creates a unit addressed by `unit::newname`. The name `newname` must be an identifier. The new unit is declared as a multiple `f` of one or more pre-existing units `oldunit`, where `f` is a number. See “Example 4” on page 1-2199 (Symbolic Math Toolbox).

**simplify — Combine units of the same type**

`unit::simplify(x)` combines all units of the same type in the arithmetical expression `x` to one unit of that type found in `x`. See “Example 1” on page 1-2197 (Symbolic Math Toolbox).

The following methods convert a numeric temperature value to the same temperature in another temperature scale. The name of a method describes the temperature scales that the method converts between. For example, `Celsius2Fahrenheit` converts a temperature in Celsius to the same temperature in Fahrenheit. See “Example 5” on page 1-2200 (Symbolic Math Toolbox).

- `Celsius2Fahrenheit`
- `Celsius2Kelvin`
- `Celsius2Rankine`
- `Celsius2Reaumur`
- `Fahrenheit2Celsius`
- `Fahrenheit2Kelvin`
- `Fahrenheit2Rankine`
- `Fahrenheit2Reaumur`
- `Kelvin2Fahrenheit`
- `Kelvin2Celsius`
- `Kelvin2Rankine`
- `Kelvin2Reaumur`
- `Rankine2Fahrenheit`
- `Rankine2Kelvin`

- Rankine2Celsius
- Rankine2Reaumur
- Reaumur2Fahrenheit
- Reaumur2Kelvin
- Reaumur2Rankine
- Reaumur2Celsius

## See Also

### **MuPAD Functions**

Simplify | `simplify`

### **External Websites**

The International System of Units (SI)

# universe

Set-theoretical universe

## Description

universe represents the set-theoretical universe of all objects.

universe is the only element of the domain `stdlib::Universe`.

The standard set operations such as union on page 1-1081, intersection on page 1-1074 and subtraction on page 1-1078 can be used with universe.

## Examples

### Example 1

We show some basic set operations involving universe:

```
universe union {a}
```

```
universe
```

```
universe intersect {a}
```

```
{a}
```

```
{a} minus universe
```

```
∅
```

## See Also

### **MuPAD Domains**

DOM\_SET

### **MuPAD Functions**

intersect | minus | union

# unprotect

Remove protection of identifiers

## Syntax

```
unprotect(x)
```

## Description

`unprotect(x)` removes any write protection of the identifier `x`.

`unprotect(x)` is equivalent to `protect(x, ProtectLevelNone)`.

`unprotect` does not evaluate its argument. Cf. “Example 2” on page 1-2214 (Symbolic Math Toolbox).

## Examples

### Example 1

`unprotect` allows to assign values to system functions:

```
unprotect(sign): sign(x) := 1
```

```
1
```

However, we strongly advise not to change identifiers protected by the system. We undo the previous assignment:

```
delete sign(x): protect(sign, ProtectLevelError):
```

## Example 2

`unprotect` does not evaluate its argument. Here the identifier `x` is unprotected and not its value `y`:

```
x := y: protect(y): unprotect(x): y := 1
```

```
Warning: Protected variable 'y' is overwritten. [_assign]
```

```
|
```

```
Warning: Protected variable  
'y' overwritten. [_assign]
```

```
|
```

```
unprotect(y): delete x, y:
```

## Example 3

The identifier `a` is protected with various levels. `unprotect` returns the previous protection level:

```
protect(a):  
unprotect(a)
```

```
ProtectLevelWarning
```

```
protect(a, ProtectLevelError):  
unprotect(a)
```

```
ProtectLevelError
```

At this place, `a` is not protected:

```
unprotect(a)
```

```
ProtectLevelNone
```



## Parameters

**x**

An identifier on page 7-29

## Return Values

Previous protection level of **x**: either `ProtectLevelError` or `ProtectLevelWarning` or `ProtectLevelNone` (see `protect`).

## See Also

### **MuPAD Functions**

`protect`

## use

Use library functions by a short name

## Syntax

```
use(L, <Alias>, f1, f2, ...)
```

```
use(L, <Alias>)
```

## Description

`use(L, f)` 'exports' the public function `L :: f` of the library `L` to the global namespace such that it can be accessed as `f` without the prefix `L`.

`use(L)` exports all public functions of the library `L`.

The standard way of accessing the function `f` from the library `L` is via `L :: f`. When the function `f` is *exported*, you can call it simply as `f`. Technically, exporting means that the global identifier `f` is assigned the value `L :: f`. Alternatively, when the option `Alias` is used, an `alias` is created.

Undoing the export of the library function `f` means that the value of the global identifier `f` is deleted. Afterwards, the library function is available only as `L :: f`.

`use(L, f1, f2, ...)` exports the specified functions `f1`, `f2`, ... of the library `L`. If one of the identifiers already has a value, the corresponding function is not exported. Instead, `use` prints a warning.

If one of the identifiers is not the name of a public library function, `use` throws an error.

A function that is already exported cannot be exported the second time.

`use` evaluates its first argument `L`, but it does not evaluate the remaining arguments `f1`, `f2`, ....

The `info` function displays the interface functions and the exported functions of a library.

Some libraries have functions that are always exported. You cannot undo the export for these functions. The function `append` from the library `listlib` is such an example.

## Environment Interactions

When a function is exported, it is assigned to the corresponding global identifier. When you undo the export, the corresponding identifier is deleted.

## Examples

### Example 1

Export the function `invphi` of the library `numlib` (Symbolic Math Toolbox), and then undo the export:

```
numlib::invphi(4!)
```

```
[35, 39, 45, 52, 56, 70, 72, 78, 84, 90]
```

```
use(numlib, invphi):
```

```
invphi(4!)
```

```
[35, 39, 45, 52, 56, 70, 72, 78, 84, 90]
```

```
unuse(numlib, invphi):
```

```
invphi(4!)
```

```
invphi(24)
```

Export all functions of the library `numlib` (Symbolic Math Toolbox):

```
use(numlib):  
invphi(100)
```

Warning: Identifier 'divisors' is not exported because it already has a value. [use]

Warning: Identifier 'contfrac' is not exported because it already has a value. [use]

[101, 125, 202, 250]

Here, `use` issues warnings because `contfrac` and `divisors` are already available as global functions. For example, there is the global `contfrac` function that uses `numlib::contfrac` for numerical arguments. Undo the export of the `numlib` functions.

```
unuse(numlib):  
invphi(100)
```

invphi(100)

## Example 2

`use` issues a warning if a function cannot be exported since the corresponding identifier already has a value:

```
invphi := 17:  
use(numlib, invphi)
```

Warning: Identifier 'invphi' is not exported because it already has a value. [use]

## Parameters

**L**

The library: a domain (Symbolic Math Toolbox)

**f1, f2, ...**

Public functions of L: identifiers on page 7-29

## Options

### Alias

Use `alias(f = L::f)` to create an alias `f` for `L::f` rather than exporting `L::f` by the assignment `f:= L::f`.

## Return Values

Void object `null()` of type `DOM_NULL`.

## Algorithms

The names of the functions of a library `L` are stored in the set `L::interface`. This set is used by the function `info` and for exporting.

The names of functions exported from a library `L` are stored in the set `L::_exported`.

## See Also

### MuPAD Functions

`:=` | `alias` | `delete` | `info` | `unuse`

### Topics

“Avoid Name Conflicts Between MuPAD Objects and Library Functions” (Symbolic Math Toolbox)

## unuse

Undo export of library function

### Syntax

```
unuse(L, f1, f2, ...)
```

```
unuse(L)
```

### Description

`unuse(L, f)` is used to undo the export of the function `L :: f` of the library `L`, so that it is no longer available as `f`.

`unuse(L)` is used to undo the export of all previously exported functions of the library `L`.

The standard way of accessing the function `f` from the library `L` is via `L :: f`. When the function `f` is *exported*, you can call it simply as `f`. Technically, exporting means that the global identifier `f` is assigned the value `L :: f`. Alternatively, when the option `Alias` is used, an `alias` is created.

Undoing the export of the library function `f` means that the value of the global identifier `f` is deleted. Afterwards, the library function is available only as `L :: f`.

`unuse(L, f1, f2, ...)` is used to undo the export of the specified functions `f1`, `f2`, ... of the library `L`. `unuse` evaluates its first argument `L`, but it does not evaluate the remaining arguments `f1`, `f2`, .... Thus, you do not need to use `hold` to protect functions from being evaluated.

The function `info` displays the interface functions and the exported functions of a library.

Some libraries have functions that are always exported. You cannot undo the export for these functions. The function `append` from the library `listlib` is such an example.

## Environment Interactions

When a function is exported, it is assigned to the corresponding global identifier. When you undo the export, the corresponding identifier is deleted.

### Examples

#### Example 1

Export the function `invphi` of the library `numlib` (Symbolic Math Toolbox), and then undo the export:

```
numlib::invphi(4!)
```

```
[35, 39, 45, 52, 56, 70, 72, 78, 84, 90]
```

```
use(numlib, invphi):
```

```
invphi(4!)
```

```
[35, 39, 45, 52, 56, 70, 72, 78, 84, 90]
```

```
unuse(numlib, invphi):
```

```
invphi(4!)
```

```
invphi(24)
```

Export all functions of the library `numlib` (Symbolic Math Toolbox):

```
use(numlib):  
invphi(100)
```

```
Warning: Identifier 'divisors' is not exported because it already has a value. [use]
```

```
Warning: Identifier 'contfrac' is not exported because it already has a value. [use]
```

[101, 125, 202, 250]

Here, `use` issues warnings because `contfrac` and `divisors` are already available as global functions. For example, there is the global `contfrac` function that uses `numlib::contfrac` for numerical arguments. Undo the export of the `numlib` functions.

```
unuse(numlib):  
invphi(100)
```

`invphi(100)`

## Parameters

**L**

The library: a domain (Symbolic Math Toolbox)

**f1, f2, ...**

Public functions of L: identifiers on page 7-29

## Return Values

Void object `null()` of type `DOM_NULL`.

## Algorithms

The names of the functions of a library L are stored in the set `L::interface`. This set is used by the function `info` and for exporting.

The names of functions exported from a library L are stored in the set `L::_exported`.



## See Also

### MuPAD Functions

`:=` | `alias` | `delete` | `info` | `use`

### Topics

"Use the MuPAD Libraries" (Symbolic Math Toolbox)

# val

Value of an object

## Syntax

`val(object)`

## Description

`val(object)` replaces every identifier in `object` by its value.

`val` does not perform any simplification of the result.

If the result of `val` is a set, duplicate elements are removed from that set.

`val` does not work recursively, i.e., if the value of an identifier in turn contains identifiers, then these are not replaced by their values. See “Example 3” on page 1-2225 (Symbolic Math Toolbox).

`val` does not flatten (Symbolic Math Toolbox) its argument. Hence, an expression sequence is accepted as argument. Cf. “Example 2” on page 1-2225 (Symbolic Math Toolbox).

## Examples

### Example 1

`val` replaces identifiers by their values, but does not call arithmetical functions such as `_plus`:

```
a := 0: val(a*b + 4 + 0)
```

```
0 b + 4 + 0
```

Duplicate elements in sets are removed:

```
a := b: val({a, b, a*0})
```

```
{b, 0 b}
```

```
delete a:
```

## Example 2

val does not flatten (Symbolic Math Toolbox) its argument, nor does it remove void objects of type DOM\_NULL:

```
a := null(): val((a, null()))
```

```
null(), null()
```

However, it is not legal to pass several arguments:

```
val(a, null())
```

```
Error: Invalid number of arguments. [val]
```

```
delete a:
```

## Example 3

val does not recursively substitute values for the identifiers:

```
delete a, b: a := b: b := c: val(a)
```

```
b
```

## Parameters

### object

Any MuPAD object

## **Return Values**

“evaluated” object.

## **See Also**

### **MuPAD Functions**

LEVEL | MAXLEVEL | eval | hold | level

# vectorPotential

Vector potential of a three-dimensional vector field

## Syntax

`vectorPotential(j, [x1, x2, x3], <Test>)`

## Description

`vectorPotential(j, x)` returns the vector potential of the vector field  $\vec{j}(\vec{x})$  with

respect to  $\vec{x}$ . This is a vector field  $\vec{v}$  with  $\text{curl}_{\vec{v}}(\vec{x}) = \vec{j}$ .

The vector potential of a vector function  $j$  exists if and only if the divergence of  $j$  is zero. It is uniquely determined.

If the vector potential of  $j$  does not exist, then `vectorPotential` returns `FALSE`.

If  $j$  is a vector then the component ring of  $j$  must be a field (i.e., a domain of category `Cat::Field`) for which definite integration can be performed.

If  $j$  is given as a list of three arithmetical expressions, then `vectorPotential` returns a vector of the domain `Dom::Matrix()`.

## Examples

### Example 1

We check if the vector function  $\vec{j}(x, y, z) = \left(x^2 y, -\frac{y^2 x}{2}, -x y z\right)$  has a vector potential:

```
delete x, y, z:
vectorPotential(
```

```
[x^2*y, -1/2*y^2*x, -x*y*z], [x, y, z], Test  
)
```

TRUE

The answer is yes, so let us compute the vector potential of  $\vec{j}$ :

```
vectorPotential(  
  [x^2*y, -1/2*y^2*x, -x*y*z], [x, y, z]  
)
```

$$\begin{pmatrix} -\frac{xy^2z}{2} \\ -x^2yz \\ 0 \end{pmatrix}$$

We check the result:

```
curl(%, [x, y, z])
```

$$\begin{pmatrix} x^2y \\ -\frac{xy^2}{2} \\ -xyz \end{pmatrix}$$

## Example 2

The vector function  $\vec{j} = (x^2, 2y, z)$  does not have a vector potential:

```
vectorPotential([x^2, 2*y, z], [x, y, z])
```

FALSE

## Parameters

**j**

A list of three arithmetical expressions, or a 3-dimensional vector (i.e., a  $3 \times 1$  or  $1 \times 3$  matrix of a domain of category `Cat::Matrix`)

**$x_1, x_2, x_3$**

(indexed) identifiers

## Options

### Test

Check whether the vector field `j` has a vector potential and return `TRUE` or `FALSE`, respectively.

## Return Values

Vector with three components, i.e., an  $3 \times 1$  or  $1 \times n$  matrix of a domain of category `Cat::Matrix`, or a boolean value.

## See Also

### MuPAD Functions

`curl` | `divergence` | `gradient` | `laplacian` | `potential`

## version

Version number of the MuPAD library

### Syntax

```
version()
```

### Description

`version()` returns the version number of the installed MuPAD library.

The call `Pref::kernel()` returns the version number of the installed MuPAD kernel.

The version numbers of the kernel and the library may differ: `version` refers to the library, whereas the call `Pref::kernel()` returns the version number of the kernel.

### Examples

#### Example 1

The version of this MuPAD library is:

```
version()
```

```
[8, 1, 0]
```

### Return Values

Version number: a list of three nonnegative integers.



## See Also

### **MuPAD Functions**

`Pref::kernel | buildnumber`

## warning

Print a warning message

### Syntax

```
warning(message)
```

### Description

`warning(message)` prints the message with the prefix “Warning:”.

`warning` may be used to print information about potential problems in an algorithm. E.g., it is used in `limit` to provide hints.

### Examples

#### Example 1

A warning:

```
warning("You should not do this!");
```

```
Warning: You should not do this!
```

#### Example 2

This example shows a simple procedure which divides two numbers. If the second argument is omitted, a warning is printed and the computation continues:

```
mydivide := proc(x, y)
begin
  if args(0) < 2 then
    warning("Denominator not given, using 1.");
```

```
    y := 1;  
  end_if:  
  x/y  
end_proc:  
mydivide(10)
```

Warning: Denominator not given, using 1. [mydivide]

10

## Parameters

### message

A character string on page 7-53

## Return Values

Void object of type DOM\_NULL.

## See Also

### MuPAD Functions

error | print

## whittakerM

The Whittaker M function

### Syntax

`whittakerM(a, b, z)`

### Description

`whittakerM` returns the Whittaker M function,  $M_{a,b}(z)$ .

The Whittaker functions  $M_{a,b}(z)$  and  $W_{a,b}(z)$  are linearly independent solutions of the following differential equation:

$$\frac{d^2w}{dz^2} + \left( -\frac{1}{4} + \frac{a}{z} + \frac{\frac{1}{4} - b^2}{z^2} \right) w = 0$$

The Whittaker M function is defined via the confluent hypergeometric function

${}_pF_q(a, b, z) = \Phi(a, b, z)$  as follows:

$$M_{a,b}(z) = e^{-z/2} z^{b+1/2} \Phi\left(b - a + \frac{1}{2}, 1 + 2b, z\right)$$

The Whittaker M function is defined for complex arguments  $a$ ,  $b$ , and  $z$ .

For most of the values of the parameters, an unevaluated function call is returned. See “Example 1” on page 1-2235 (Symbolic Math Toolbox).

Explicit symbolic expressions are returned for some particular values of the parameters. See “Example 2” on page 1-2236 (Symbolic Math Toolbox).

---

**Note** MuPAD defines  ${}_1F_1(a, a, z) = e^z$  for all complex numbers  $a$ . As a consequence, the MuPAD whittakerM function differs from the corresponding function in M. Abramowitz

and I. A. Stegun, "Handbook of Mathematical Functions" when  $b - a + \frac{1}{2}$  and  $1 + 2b$  are

negative integers and  $b - a + \frac{1}{2} \geq 1 + 2b$ . Some of the formulas in Chapter 13 of the "Handbook of Mathematical Functions" do not hold for the MuPAD whittakerM with such arguments. See "Example 4" on page 1-2237 (Symbolic Math Toolbox).

---

## Environment Interactions

When called with floating-point arguments, these functions are sensitive to the environment variable DIGITS which determines the numerical working precision.

## Examples

### Example 1

For exact or symbolic arguments, whittakerM returns unevaluated calls:

```
whittakerM(a, b, x);
whittakerM(-3/2, 1/2, 1)
```

$$M_{a,b}(x)$$

$$M_{-\frac{3}{2}, \frac{1}{2}}(1)$$

For floating-point arguments, whittakerM returns floating-point results:

```
whittakerM(-2, 0.5, -50),
whittakerM(-3/2, 1/2, 1.0)
```

```
0.00000001666553264, 2.03036659
```

## Example 2

For some specific values of the parameters, `whittakerM` returns explicit expressions:

```
whittakerM(0, b, x);  
whittakerM(-3/2, 1/2, 0);  
whittakerM(-3/2, 0, x)
```

$$4^b \sqrt{x} \Gamma(b+1) I_b\left(\frac{x}{2}\right)$$

0

$$\sqrt{x} e^{\frac{x}{2}} (x+1)$$

## Example 3

`diff`, `float`, `limit`, `series` and other functions handle expressions involving the Whittaker M function:

```
diff(whittakerM(a, b, z), z)
```

$$\frac{M_{a+1,b}(z) (a+b+\frac{1}{2})}{z} - \left(\frac{a}{z} - \frac{1}{2}\right) M_{a,b}(z)$$

```
float(whittakerM(-3/2, 1/2, 1))
```

2.03036659

```
series(whittakerM(-3/2, 1/2, x), x)
```

$$x + \frac{3x^2}{4} + \frac{11x^3}{48} + \frac{17x^4}{384} + \frac{19x^5}{3072} + \frac{25x^6}{36864} + O(x^7)$$

## Example 4

For some values of the input parameters, recurrence and differential relations in Chapter 13 of M. Abramowitz and I. A. Stegun, "Handbook of Mathematical Functions" do not hold for the MuPAD `whittakerM` functions. For example, Formula 13.4.32

$$z \frac{\partial}{\partial z} M_{a,b}(z) = \left(\frac{z}{2} - a\right) M_{a,b}(z) + \left(a + b + \frac{1}{2}\right) M_{a+1,b}(z)$$

is not satisfied for  $a = 0$  and  $b = -3/2$ :

```
expand(x*diff(whittakerM(0, -3/2, x), x) <>
      x/2*whittakerM(0, -3/2, x) -
      whittakerM(1, -3/2, x))
```

$$-\frac{e^{-\frac{x}{2}}}{2} - \frac{x e^{-\frac{x}{2}}}{4} - \frac{e^{-\frac{x}{2}}}{x} \neq \frac{e^{-\frac{x}{2}}}{2} + \frac{x e^{-\frac{x}{2}}}{4} - \frac{e^{-\frac{x}{2}}}{x}$$

## Parameters

**a, b, z**

Arithmetical expressions (Symbolic Math Toolbox)

## Return Values

Arithmetical expression.

## Overloaded By

z

## See Also

### MuPAD Functions

hypergeom | kummerU | whittakerW



# whittakerW

The Whittaker W function

## Syntax

whittakerW(a, b, z)

## Description

whittakerW returns the Whittaker W function  $W_{a,b}(z)$ .

The Whittaker functions  $M_{a,b}(z)$  and  $W_{a,b}(z)$  are linearly independent solutions of the following differential equation:

$$\frac{d^2w}{dz^2} + \left( -\frac{1}{4} + \frac{a}{z} + \frac{\frac{1}{4} - b^2}{z^2} \right) w = 0$$

The Whittaker W function is defined via the confluent hypergeometric Kummer U function  $U(a, b, z)$  as follows:

$$W_{a,b}(z) = e^{-z/2} z^{b+1/2} U\left(b - a + \frac{1}{2}, 1 + 2b, z\right)$$

The WhittakerW function is defined for complex arguments a, b, and z.

For most of the values of the parameters, an unevaluated function call is returned. See “Example 1” on page 1-2240 (Symbolic Math Toolbox).

Explicit symbolic expressions are returned for some particular values of the parameters. See “Example 2” on page 1-2240 (Symbolic Math Toolbox).

## Environment Interactions

When called with floating-point arguments, these functions are sensitive to the environment variable DIGITS which determines the numerical working precision.

## Examples

### Example 1

For exact or symbolic arguments, `whittakerW` returns unevaluated calls:

```
whittakerW(a, b, x);  
whittakerW(-3/2, 1/2, 1)
```

$$W_{a,b}(x)$$

$$W_{-\frac{3}{2}, \frac{1}{2}}(1)$$

For floating-point arguments, `whittakerW` returns floating-point results:

```
whittakerW(2, 0.5, -5),  
whittakerW(-3/2, 1/2, 0.0)
```

426.3872886, 0.7522527781

### Example 2

For some specific values of the parameters, `whittakerW` returns explicit expressions:

```
whittakerW(0, b, x);  
whittakerW(-3/2, 1/2, 0);  
whittakerW(-3/2, 0, x);  
whittakerW(a, -a + 1/2, x)
```

$$\frac{x^{b+\frac{1}{2}} K_b\left(\frac{x}{2}\right)}{x^b \sqrt{\pi}}$$

$$\frac{4}{3 \sqrt{\pi}}$$

$$\sqrt{x} e^{-\frac{x}{2}} (e^x \operatorname{Ei}(1, x) + x e^x \operatorname{Ei}(1, x) - 1)$$

$$x^{1-a} x^{2a-1} e^{-\frac{x}{2}}$$

### Example 3

diff, float, limit, series, and other functions handle expressions involving the Whittaker W function:

`diff(whittakerW(a, b, z), z)`

$$-\left(\frac{a}{z} - \frac{1}{2}\right) W_{a,b}(z) - \frac{W_{a+1,b}(z)}{z}$$

`float(whittakerW(-3/2, 1/2, 0))`

0.7522527781

`series(whittakerW(-3/2, 1/2, x), x, 2)`

$$\frac{4}{3 \sqrt{\pi}} + x \left( \frac{2 (\operatorname{EULER} - 2 \ln(2) + \ln(x) + \frac{5}{3})}{\sqrt{\pi}} - \frac{2}{3 \sqrt{\pi}} \right) + O(x^2)$$

## Parameters

**a, b, z**

Arithmetical expressions (Symbolic Math Toolbox)

## Return Values

Arithmetical expression.

## Overloaded By

**z**

## See Also

### **MuPAD Functions**

`hypergeom` | `kummerU` | `whittakerM`

# wrightOmega

The Wright  $\omega$  function

## Syntax

wrightOmega(x)

## Description

$\omega(x)$  is defined in terms of Lambert's W function on page 1-1189 as

$$\omega(x) = W_{\left[ \frac{\Im(x) - \pi}{i\pi} \right]}(e^x)$$

For  $x \neq t - i\pi$  with  $t \leq -1$ ,  $y = \omega(x)$  is a solution of the equation  $y + \ln(y) = x$ . The complete solution set of this equation is

$$y = \begin{cases} \emptyset & \text{if } \Re(x) \leq -1 \wedge \Im(x) = -\pi \\ \{\omega(x), \omega(x - 2\pi i)\} & \text{if } \Re(x) \leq -1 \wedge \Im(x) = \pi \\ \{\omega(x)\} & \text{otherwise} \end{cases}$$

A floating-point value is computed if the argument is a floating point value. Unevaluated symbolic calls are returned for most exact arguments. For some special cases explicit symbolic representations are returned.

## Environment Interactions

When called with a floating-point argument, the function is sensitive to the environment variable DIGITS which determines the numerical working precision.

## Examples

### Example 1

Most calls with exact arguments return themselves unevaluated:

```
wrightOmega(1/2); wrightOmega(I*PI);
```

$$\omega\left(\frac{1}{2}\right)$$

$$\omega(\pi i)$$

Some special arguments return explicit symbolic representations:

```
wrightOmega(-1+I*PI); wrightOmega(ln(2)+6*PI*I);
```

$$-1$$

$$W_3(2)$$

If the argument is a floating-point value, then a floating-point result will be returned:

```
wrightOmega(0.5)
```

$$0.7662486082$$

## Parameters

**x**

An arithmetical expression (Symbolic Math Toolbox), the “argument”

## Return Values

Arithmetical expression

## See Also

### **MuPAD Functions**

`lambertW`

## write

Write values of variables into file

### Syntax

```
write(<Bin | Text>, <Encoding = "encodingValue">, filename, <x1, x2, ...>)
```

```
write(<Encoding = "encodingValue">, n, <x1, x2, ...>)
```

### Description

`write` serves for storing information from the current MuPAD session in a file. The file contains the values of identifiers of the current session. These identifiers are assigned the stored values when this file is read into another MuPAD session via the function `read`.

`write(filename, x1, x2, ...)` stores the current values of the identifiers  $x_1, x_2$  etc. to the file `filename`.

`write(filename)` stores the values of all identifiers defined in the current session to the file `filename`.

`write(n)` and `write(n, x1, x2, ...)` store the data in the file associated with the file descriptor `n`.

`write(..., Encoding = "encodingValue", ...)` stores the current values of identifiers in the specified encoding only when writing in `Text` mode. For the supported encodings, see “Options” on page 1-2251 (Symbolic Math Toolbox). You can use this option with any of the previously specified syntaxes.

If the file is specified by its name, `write` creates a new file or overwrites an existing file; `write` opens and closes the file automatically.

If `WRITEPATH` does not have a value, `write` interprets the file name as a pathname relative to the “working folder”.

Note that the meaning of “working folder” depends on the operating system. On Microsoft Windows systems and on Mac OS X systems, the “working folder” is the folder



where MATLAB is installed. On UNIX systems, it is the current working folder in which MATLAB was started. When started from a menu or desktop item, this is typically the user's home folder.

Also absolute path names are processed by `write`.

Instead of a file name, also a file descriptor of a file opened via `fopen` can be used. See “Example 2” on page 1-2248 (Symbolic Math Toolbox). In this case, the data written by `write` are appended to the corresponding file. The file is not closed automatically by `write` and must be closed by a subsequent call to `fclose`.

Note that `fopen(filename)` opens the file in read-only mode. A subsequent `write` command to this file causes an error. Use the `Write` or `Append` option of `fopen` to open the file for writing.

The file descriptor 0 represents the screen.

`write` stores procedures with the option `noExpose` in encrypted format.

---

**Note** `write` stores the *values* of the given identifiers, not *their full evaluation*! See “Example 3” on page 1-2249 (Symbolic Math Toolbox).

---

## Environment Interactions

The function is sensitive to the environment variable `WRITEPATH`. If this variable has a value, the file is created in the corresponding folder. Otherwise, the file is created in the “working folder.”

## Examples

### Example 1

The variable `a` and its value `b + 1` are stored in a file named `test`:

```
a := b + 1;
fid := fopen(TempFile, Write, Text);
write(fid, a);
```

Use `fname` to return the name of the temporary file you created:

```
file := fname(fid):
```

The content of this file is displayed via `ftextInput`:

```
ftextInput(file)
```

```
"a := hold(_plus)(hold(b), 1):"
```

Delete the value of `a`. Reading the file `test` restores the previous value:

```
delete a:  
read(file):  
a
```

```
b + 1
```

For identifiers that have no value, `write` writes a `delete` command to the file:

```
delete a:  
write(Text, 0, a):  
  
delete a:
```

## Example 2

The file `test` is opened for writing using the MuPAD binary format:

```
fid := fopen(TempFile):  
file := fname(fid):  
n := fopen(file, Write)
```

```
17
```

This number is the descriptor of the file and can be used in a write command:

```
a := b + 1:  
write(n, a):  
fclose(n):
```

```
delete a:
read(file):
a
```

$b + 1$

Clean up:

```
delete n, a:
```

### Example 3

The value  $b + 1$  is assigned to the identifier  $a$ . After assigning the value 2 to  $b$ , complete evaluation of  $a$  yields 3:

```
a := b + 1:
b := 2:
a
```

3

Note, however, that the value of  $a$  is the expression  $b + 1$ . This value is stored by a `write` command:

```
fid := fopen(TempFile, Write, Text):
write(fid, a):
file := fname(fid):
ftextinput(file)
```

`"a := hold(_plus)(hold(b), 1):"`

Consequently, this value is restored after reading the file into a MuPAD session:

```
delete a, b:
read(file):
a
```

$b + 1$

```
delete a:
```

## Example 4

`write`, when writing binary format, can store procedures with the option `noExpose` set. They are encrypted before writing:

```
f := proc(a)
  option noExpose;
begin
  print(a, a^2, a*a);
end_proc;

write("hidden_proc.mb", f):

delete f:

read("hidden_proc.mb"):

f(-2...3);
expose(f)
```

```
-2.0 ... 3.0, 0.0 ... 9.0, -6.0 ... 9.0
```

```
proc(a)
  name f;
  option noDebug, noExpose;
begin
  /* Hidden */
end_proc
```

This is the intention behind option `noExpose`: You can develop code you wish not to publish, then include `option noExpose` in your sources, rerun your tests, use `write` to write a binary version of your library and distribute that.

## Example 5

To specify the encoding to write data, use `Encoding`. The `Encoding` option applies only to text files that are opened using a file name and not a file descriptor. Write the value of the identifier `a:="abcäöü"` into a temporary file in the encoding "UTF-8":

```
a:="abcäöü":
write(Text,Encoding="UTF-8","write_test",a):
```

Specify the correct encoding to read the file:

```
read("write_test", Encoding="UTF-8")
```

```
"abcäöü"
```

If you do not specify an encoding, the default system encoding is used. Thus, your output might vary from that shown next. Characters unrecognized by the default system encoding are replaced by the default substitution character for that encoding:

```
a:="abcäöü":
write(Text, "write_test", a):
read("write_test")
```

```
"abc"
```

## Parameters

### filename

The name of a file: a character string on page 7-53

$x_1, x_2, \dots$

identifiers on page 7-29

$n$

A file descriptor provided by `fopen`: a nonnegative integer

## Options

### Bin, Text

With `Bin`, the data are stored in the MuPAD binary format. With `Text`, standard ASCII format is used. The default is `Bin`.

In ASCII format, assignments of the form `identifier := hold(value):` or `delete identifier:` are written into the file. See “Example 1” on page 1-2247 (Symbolic Math Toolbox).

## Encoding

This option lets you specify the character encoding to use. The allowed encodings are:

"Big5"	"ISO-8859-1"	"windows-932"
"EUC-JP"	"ISO-8859-2"	"windows-936"
"GBK"	"ISO-8859-3"	"windows-949"
"KSC_5601"	"ISO-8859-4"	"windows-950"
"Macintosh"	"ISO-8859-9"	"windows-1250"
"Shift_JIS"x	"ISO-8859-13"	"windows-1251"
"US-ASCII"	"ISO-8859-15"	"windows-1252"
"UTF-8"		"windows-1253"
		"windows-1254"
		"windows-1257"

The default encoding is system dependent. If you specify the encoding incorrectly, characters might read incorrectly. Characters unrecognized by the encoding are replaced by the default substitution character for the specified encoding.

Encodings not listed here can be specified but might not produce correct results.

## Return Values

Void object of type `DOM_NULL`.

## See Also

### **MuPAD Functions**

READPATH | WRITEPATH | doprint | fclose | finput | fname | fopen | fprintf | fread  
| ftextinput | import::readbitmap | import::readdata | pathname | print |  
protocol | read

## zeta

The Riemann zeta function

### Syntax

`zeta(z)`

`zeta(z, n)`

### Description

`zeta(z)` represents the Riemann zeta function  $\zeta(z) = \sum_{k=1}^{\infty} \frac{1}{k^z}$ .

`zeta(z, n)` represents the n-th derivative  $\sum_{k=1}^{\infty} \frac{(-\ln(k))^n}{k^z}$  of the zeta function.

The series converge only if the real part of  $z$  is greater than 1. The definition of the zeta function is extended to the entire complex plane, except for a simple pole  $z = 1$ , by analytic continuation.

The calls `zeta(z)` and `zeta(z, 0)` are equivalent.

A floating-point result is returned for floating-point arguments  $z$ .

The following special exact values are implemented:

$$\zeta(0) = -\frac{1}{2}, \quad \zeta(0, 1) = -\frac{\ln(\pi)}{2} - \frac{\ln(2)}{2},$$

$$\zeta(z) = 0 \text{ for even integers } z < 0,$$

$$\zeta(z) = -\frac{\text{bernoulli}(1-z)}{1-z} \text{ for odd integers } z \text{ satisfying } -\text{Pref}::\text{autoExpansionLimit}() \leq z < 0,$$

$$\zeta(z) = \frac{(2\pi)^z |\text{bernoulli}(z)|}{2z!} \text{ for even integers } z \text{ satisfying } 0 \leq z \leq \text{Pref}::\text{autoExpansionLimit}(),$$



$\zeta(\infty) = 1$ ,  $\zeta(\infty, n) = 0$  for  $n > 0$ .

`zeta` returns a symbolic function call, if the argument does not evaluate to one of the above numbers.

---

**Note** Floating point evaluation is rather slow for large values of  $n$ . Further, for large  $n$ , evaluation for  $\Re(z) < 0$  is much slower than the evaluation for  $\Re(z) \geq 0$ .

---

## Environment Interactions

When called with a floating-point argument  $z$ , the function is sensitive to the environment variable DIGITS which determines the numerical working precision.

## Examples

### Example 1

We demonstrate some calls with exact and symbolic input data:

`zeta(-6), zeta(-5), zeta(-4), zeta(-3), zeta(-2), zeta(-1)`

$$0, -\frac{1}{252}, 0, \frac{1}{120}, 0, -\frac{1}{12}$$

`zeta(0), zeta(2), zeta(3), zeta(4), zeta(5), zeta(6), zeta(7)`

$$-\frac{1}{2}, \frac{\pi^2}{6}, \zeta(3), \frac{\pi^4}{90}, \zeta(5), \frac{\pi^6}{945}, \zeta(7)$$

`zeta(1/2), zeta(1 + I), 1), zeta(z^2 - I, 2)`

$$\zeta\left(\frac{1}{2}\right), \zeta'(1 + i), \zeta''(z^2 - i)$$

Here are some values of the derivative of the zeta function:

```
zeta(0, 1), zeta(infinity, 1)
```

$$-\frac{\ln(2)}{2} - \frac{\ln(\pi)}{2}, 0$$

Floating point values are computed for floating-point arguments:

```
zeta(-1001.0), zeta(12.3, 1), zeta(0.5 + 14.13472514*I, 2)
```

$$-1.348590824 \cdot 10^{1771}, -0.0001389996909, -0.614409794 - 0.2297836439 i$$

zeta has a pole at the point  $z = 1$ :

```
zeta(1)
```

```
Error: Singularity. [zeta]
```

## Example 2

Looking for nontrivial roots of the Zeta function, we plot the function  $f(z) = |\zeta(z)|$  along the “critical line” of complex numbers with real part  $\frac{1}{2}$ :

```
plotfunc2d(abs(zeta(1/2 + y*I)), y = 0..30,  
           Mesh = 500,  
           AxesTitles = ["y", "|zeta|"])
```

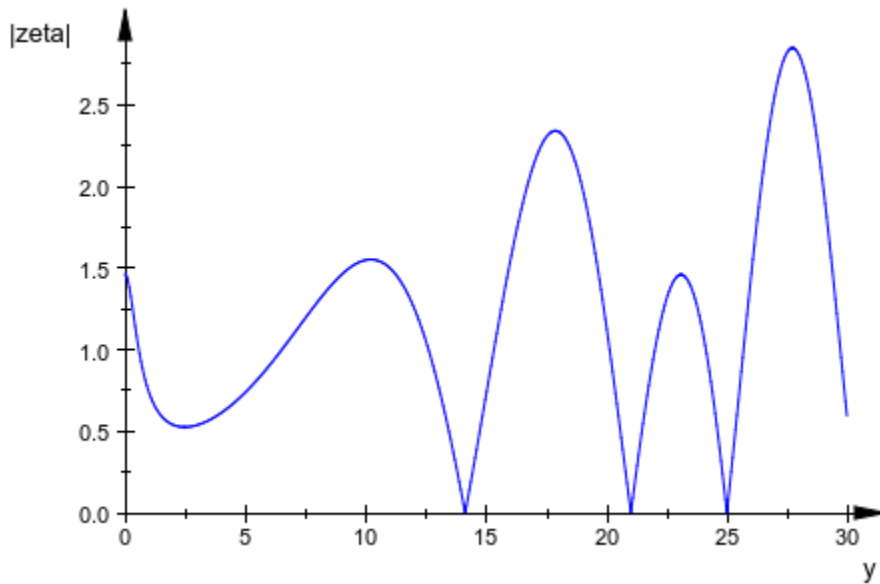

The following calls search for numerical roots along the critical line:

```
numeric::solve(zeta(1/2 + I*y), y = 10..20),
numeric::solve(zeta(1/2 + I*y), y = 20..22),
numeric::solve(zeta(1/2 + I*y), y = 22..26)
```

```
{14.13472514}, {21.02203964}, {25.01085758}
```

## Parameters

**z**

An arithmetical expression (Symbolic Math Toolbox)

**n**

An arithmetical expression (Symbolic Math Toolbox) representing a nonnegative integer

## **Return Values**

Arithmetical expression.

## **Overloaded By**

z

## **See Also**

### **MuPAD Functions**

bernoulli

# zip

Combine lists

## Syntax

```
zip(list1, list2, f)
```

```
zip(list1, list2, f, default)
```

## Description

`zip(list1, list2, f)` combines two lists via a function `f`. It returns a list whose  $i$ -th entry is `f(list1[i], list2[i])`. Its length is the minimum of the lengths of the two input lists.

`zip(list1, list2, f, default)` returns a list whose length is the maximum of the lengths of the two input lists. The shorter list is padded with the `default` value.

If `f` produces the void object of type `DOM_NULL`, then this element is removed from the resulting list.

`zip` is recommended for fast manipulation of lists. It is a function of the system kernel.

## Examples

### Example 1

The fastest way of adding the entries of two lists is to 'zip' them via the function `_plus`:

```
zip([a, b, c, d], [1, 2, 3, 4], _plus)
```

```
[a+1, b+2, c+3, d+4]
```

If the input lists have different lengths, then the shorter list determines the length of the returned list:

```
zip([a, b, c, d], [1, 2], _plus)
```

```
[a + 1, b + 2]
```

The longer list determines the length of the returned list if a value for padding the shorter list is provided:

```
zip([a, b, c, d], [1, 2], _plus, 17)
```

```
[a + 1, b + 2, c + 17, d + 17]
```

## Parameters

**list1, list2**

lists on page 7-41 of arbitrary MuPAD objects

**f**

Any MuPAD object. Typically, a function (Symbolic Math Toolbox) of two arguments.

**default**

Any MuPAD object

## Return Values

List.

## Overloaded By

list1, list2

## See Also

### MuPAD Functions

map | op | select | split

## ztrans

Z transform

### Syntax

`ztrans(f, k, z)`

### Description

`ztrans(f, k, z)` computes the Z transform of the expression  $f = f(k)$  with respect to the index  $k$  at the point  $z$ .

The Z transform  $F(z)$  of the function  $f(k)$  is defined as follows:

$$F(z) = \sum_{k=0}^{\infty} \frac{f(k)}{z^k}$$

If `ztrans` cannot find an explicit representation of the transform, it returns an unevaluated function call. See “Example 4” on page 1-2264 (Symbolic Math Toolbox).

If  $f$  is a matrix, `ztrans` applies the Z transform to all components of the matrix.

To compute the inverse Z transform, use `iztrans`.

### Examples

#### Example 1

Compute the Z transform of these expressions:

`ztrans(1/k!, k, z)`

$$e^{\frac{1}{z}}$$



`ztrans(sin(k), k, z)`

$$\frac{z \sin(1)}{z^2 - 2 \cos(1) z + 1}$$

## Example 2

Compute the Z transform of this expression and then simplify the result:

`ztrans(cos(a*k + b), k, z)`

$$\frac{z \cos(b) (z - \cos(a))}{z^2 - 2 \cos(a) z + 1} - \frac{z \sin(a) \sin(b)}{z^2 - 2 \cos(a) z + 1}$$

`Simplify(%)`

$$-\frac{z (\cos(a - b) - z \cos(b))}{z^2 - 2 \cos(a) z + 1}$$

## Example 3

Compute the Z transform of this expression with respect to the variable k:

`F := ztrans(2*k + 3, k, z)`

$$\frac{3 z}{z - 1} + \frac{2 z}{(z - 1)^2}$$

Evaluate the Z transform of the expression at the points  $z = 2a + 3$  and  $z = 1 + i$ . You can evaluate the resulting expression F using `|` (or its functional form `evalAt`):

`F | z = 2*a + 3`

$$\frac{3 (2 a + 3)}{2 a + 2} + \frac{2 (2 a + 3)}{(2 a + 2)^2}$$

Also, you can evaluate the Z transform at a particular point directly:

```
ztrans(2*k + 3, k, 1 + I)
```

$$1 - 5i$$

### Example 4

If `ztrans` cannot find an explicit representation of the transform, it returns an unevaluated call:

```
ztrans(f(k), k, z)
```

$$ztrans(f(k), k, z)$$

`iztrans` returns the original expression:

```
iztrans(%, z, k)
```

$$f(k)$$

### Example 5

Compute the following Z transforms that involve Kronecker's Delta function and the Heaviside function:

```
ztrans(f(k)*kroneckerDelta(k, 1) +  
      g(k)*kroneckerDelta(k, -5), k, z)
```

$$\frac{f(1)}{z}$$

```
ztrans(binomial(k, 2)*heaviside(5 - k), k, z)
```

$$\frac{z}{(z-1)^3} + \frac{5}{z^5} + \frac{6z - \frac{z^6}{(z-1)^3} + 3z^2 + z^3}{z^5}$$

Simplify the last expression using `simplify`:

```
simplify(%)
```

$$\frac{z^3 + 3z^2 + 6z + 5}{z^5}$$

## Example 6

Compute the Z transforms of this expression that involves the Heaviside function:

```
ztrans(heaviside(k - 3), k, z)
```

$$\frac{\frac{1}{z-1} + \frac{1}{2}}{z^3}$$

Note that MuPAD uses the value `heaviside(0) = 1/2`. You can define a different value for `heaviside(0)`:

```
unprotect(heaviside):
heaviside(0) := 1:
```

For better performance, MuPAD remembers the previously computed value of the Z transform. To force the system to recalculate the transform, clear its remember table:

```
ztrans(Remember, Clear):
```

For details about the remember mechanism, see Remember Mechanism (Symbolic Math Toolbox).

Defining a different value for `heaviside(0)` produces a different value of the Z transform:

```
ztrans(heaviside(k - 3), k, z)
```

$$\frac{\frac{1}{z-1} + 1}{z^3}$$

For further computations, restore the original value:

```
heaviside(0) := 1/2:  
protect(heaviside):
```

## Example 7

Compute the Z transforms of these expressions:

```
ztrans(k*f(k), k, z)
```

$$-z \frac{\partial}{\partial z} \text{ztrans}(f(k), k, z)$$

```
ztrans(f(k + 1), k, z)
```

$$z \text{ztrans}(f(k), k, z) - z f(0)$$

## Parameters

**f**

Arithmetical expression or matrix on page 1-2045 (Symbolic Math Toolbox) of such expressions

**k**

Identifier on page 7-29 or indexed identifier on page 1-1017

**z**

Arithmetical expression representing the evaluation point

## Return Values

Arithmetical expression or unevaluated function call of type `ztrans`. An explicit result can be a `piecewise` object. If the first argument is a matrix, the result is returned as a matrix.

## Overloaded By

f

## See Also

### MuPAD Functions

iztrans | iztrans::addpattern | ztrans::addpattern

## Topics

“Z-Transforms” (Symbolic Math Toolbox)

## ztrans::addpattern

Add patterns for the Z transform

### Syntax

`ztrans::addpattern(pat, k, z, res, <vars, <conds>>)`

### Description

`ztrans::addpattern(pat, k, z, res)` teaches `ztrans` to return

$$\text{ztrans}(\text{pat}, k, z) = \sum_{k=0}^{\infty} \frac{\text{pat}}{z^k} = \text{res}.$$

The `ztrans` function uses a set of patterns for computing Z transforms. You can extend the set by adding your own patterns. To add a new pattern to the pattern matcher, use `ztrans::addpattern`. MuPAD does not save custom patterns permanently. The new patterns are available in the *current* MuPAD session only.

Variable names that you use when calling `ztrans::addpattern` can differ from the names that you use when calling `ztrans`. See “Example 2” on page 1-2269 (Symbolic Math Toolbox).

You can include a list of free parameters and a list of conditions on these parameters. These conditions and the result are protected from premature evaluation. This means that you can use `not iszero(a^2 - b)` instead of `hold( _not @ iszero )(a^2 - b)`.

The following conditions treat assumptions on identifiers differently:

- `a^2 - b <> 0` takes into account assumptions on identifiers.
- `not iszero(a^2 - b)` disregards assumptions on identifiers.

See “Example 3” on page 1-2270 (Symbolic Math Toolbox).

## Environment Interactions

Calling `ztrans::addpattern` changes the expressions returned by future calls to `ztrans`.

## Examples

### Example 1

Compute the Z transform of the function `foo`. By default, MuPAD does not have a pattern for this function:

```
ztrans(foo(k), k, z)
```

$$ztrans(foo(k), k, z)$$

Add a pattern for the Z transform of `foo` using `ztrans::addpattern`:

```
ztrans::addpattern(foo(k), k, z, bar(z)):
```

Now `ztrans` returns the Z transform of `foo`:

```
ztrans(foo(k), k, z)
```

$$bar(z)$$

After you add a new transform pattern, MuPAD can use that pattern indirectly:

```
ztrans(foo(k + 3), k, z)
```

$$z^3 bar(z) - z foo(2) - z^2 foo(1) - z^3 foo(0)$$

### Example 2

Define the Z transform of `foo(x)` using the variables `x` and `y` as parameters:

```
ztrans::addpattern(x, x, y, y/(y^2-2*y+1)):
```

The `ztrans` function recognizes the added pattern even if you use other variables as parameters:

```
ztrans(s, s, t)
```

$$\frac{t}{t^2 - 2t + 1}$$

### Example 3

Use assumptions when adding this pattern for the Z transform:

```
ztrans::addpattern(F00(x*k), k, z, sin(1/(x - 1/2))*BAR(z),
                  [x], [abs(x) < 1]):
ztrans(F00(x*k), k, z) assuming -1 < x < 1
```

$$\sin\left(\frac{1}{x - \frac{1}{2}}\right) \text{BAR}(z)$$

If  $|x| \geq 1$ , you cannot apply this pattern:

```
ztrans(F00(x*k), k, z) assuming x >= 1
```

$$\text{ztrans}(\text{FOO}(k \ x), k, z)$$

If MuPAD cannot determine whether the conditions are satisfied, it returns a `piecewise` object:

```
ztrans(F00(x*k), k, z)
```

$$\left\{ \sin\left(\frac{1}{x - \frac{1}{2}}\right) \text{BAR}(z) \text{ if } |x| < 1 \right.$$

Note that the resulting expression defining the Z transform of  $F00(x*k)$  implicitly assumes that the value of  $x$  is not  $1/2$ . A strict definition of the pattern is:

```
ztrans::addpattern(BAR(x*k), k, z, sin(1/(x - 1/2))*F00(z),
                  [x], [abs(x) < 1, x <> 1/2]):
```



If either the conditions are not satisfied or substituting the values into the result gives an error, `ztrans` ignores the pattern. For this particular pattern, you can omit specifying the assumption  $x \neq 1/2$ . If  $x = 1/2$ , MuPAD throws an internal “Division by zero.” error and ignores the pattern:

```
ztrans(F00(s/2), s, t)
```

```
ztrans(FOO( $\frac{s}{2}$ ), s, t)
```

## Parameters

### **pat**

Arithmetical expression (Symbolic Math Toolbox) in the variable `k` representing the pattern to match

### **k**

Identifier on page 7-29 or indexed identifier on page 1-1017 used as a variable in the pattern

### **z**

Identifier on page 7-29 or indexed identifier on page 1-1017 used as a variable in the result

### **res**

Arithmetical expression in the variable `k` representing the pattern for the result of the transformation

### **vars**

List of identifiers on page 7-29 or indexed identifiers on page 1-1017 used as “pattern variables” (placeholders in `pat` and `res`). You can use pattern variables as placeholders for almost arbitrary MuPAD expressions not containing `k` or `z`. You can restrict them by conditions given in the optional parameter `conds`.

**conds**

List of conditions on the pattern variables

**Return Values**

Object of type DOM\_NULL

**See Also**

**MuPAD Functions**

iztrans | iztrans::addpattern | ztrans

**Topics**

“Use Custom Patterns for Transforms” (Symbolic Math Toolbox)

# adt - Abstract Datatypes

---

## adt::Heap

Abstract data type “Heap”

### Syntax

```
adt::Heap()
```

### Description

adt::Heap implements the abstract data type “Heap”.

A “heap” or “priority queue” is a data type that stores a collection of elements. Elements can be compared and the minimal element can be read and deleted from the heap.

In adt::Heap, each element is associated with a comparison key, typically a real number. The keys must be comparable with one another using <.

To get access to the largest element in an adt::Heap, you can simply negate the comparison keys.

adt::Heap returns a function environment on page 7-25. This object has slots “insert”, “nops”, “min\_pair”, “min\_element”, and “delete\_min” which allow operations on the heap. See the examples.

adt::Heap does not allow access to other elements than the minimal one.

### Examples

#### Example 1

adt::Heap() creates an empty heap:

```
h := adt::Heap()
```

```
adt::Heap(...)
```

The slot "nops" of h shows the number of elements in the heap:

```
h::nops()
```

```
0
```

`h::insert` is the method to insert new elements. It expects two arguments: the comparison key and the data. For now, we simply insert some numbers, so we repeat the number in both arguments:

```
h::insert(3,3):
```

```
h::insert(1,1):
```

```
h::insert(2,2):
```

```
h::nops()
```

```
3
```

When retrieving the elements with `h::delete_min`, we see that they are returned in increasing order:

```
h::delete_min(), h::delete_min(), h::delete_min()
```

```
1, 2, 3
```

The heap is now empty:

```
h::nops()
```

```
0
```

Calling `delete_min` on an empty heap returns FAIL:

```
h::delete_min()
```

```
FAIL
```

### Algorithms

`adt::Heap` uses a complete binary tree stored in a list on page 7-41. Insertions operate in expected constant time, with a worst case time logarithmic in the number of elements in the heap. For "`delete_min`", both the average and the worst-case running time are  $O(\log n)$ , with  $n$  the size of the heap.

### See Also

#### MuPAD Functions

`adt::Queue` | `adt::Stack` | `adt::Tree`

## adt::Queue

Abstract data type “Queue”

### Syntax

```
adt::Queue(queue)
```

### Description

adt::Queue implements the abstract data type “Queue”. To create a queue, an expression sequence of any MuPAD objects can be given to initialize the queue, otherwise an empty queue is built.

---

**Note** The methods of all abstract data types must be called especially and will result changing the object itself as side effect.

---

With `Q := adt::Queue()` an empty queue is built and assigned to the variable `Q`.

Every queue will be displayed as `Queue` followed by a number. This name is generated by `genident`.

---

**Note** *All following methods changes the value of Q itself.* A new assignment to the variable (in this example `Q`) is not necessary, in contrast to all other MuPAD functions and data types.

---

The methods `clear`, `dequeue`, `empty`, `enqueue`, `front`, `length`, `reverse` are available for handling with queues.

## Examples

### Example 1

Create a new queue with strings as arguments.

```
Q := adt::Queue("1", "2", "3", "4")
```

```
Queue1
```

Show the length of the queue.

```
Q::length()
```

```
4
```

Fill up the queue with a new element. The queue will be changed by the method, no new assignment to Q is necessary!

```
Q::enqueue("5")
```

```
"5"
```

Show the front of the queue. This method does not change the queue.

```
Q::front(), Q::front()
```

```
"1", "1"
```

After twice getting an element of the queue, the third element is the new front of the queue, and the length is 3.

```
Q::dequeue(), Q::dequeue(), Q::front(), Q::length()
```

```
"1", "2", "3", 3
```

Now revert the queue. The last element will be the first element.



```
Q::reverse(): Q::front()
```

```
"5"
```

Enlarge the queue with "2".

```
Q::enqueue("2"):
Q::empty()
```

```
FALSE
```

Finally collect all elements of the queue in the list assigned to ARGS, until the queue is empty.

```
ARGS := []:
while not Q::empty() do ARGS := append(ARGS, Q::dequeue()) end:
ARGS
```

```
["5", "4", "3", "2"]
```

## Parameters

### queue

An expression sequence on page 1-88 of objects to initialize the queue

## Methods

### clear — Clear the queue

```
clear()
```

### dequeue — Get an element from the queue

```
dequeue()
```

**empty — Is the queue empty**

empty()

**enqueue — Fill up the queue**

enqueue(x)

**front — Front of the queue**

front()

**length — Length of the queue**

length()

**reverse — Revert the queue**

reverse()

# adt::Stack

Abstract datatype “Stack”

## Syntax

```
adt::Stack(stack)
```

## Description

`adt::Stack` implements the abstract data type “Stack.” To create a stack, an expression sequence of any MuPAD objects can be given to initialize the stack, otherwise an empty stack is built.

---

**Note** The methods `adt::Stack`, like those of all abstract data types, change their argument as a side effect.

---

With `S := adt::Stack()` an empty stack is built and assigned to the variable `S`.

---

**Note** *All following methods change the value of `S` itself.* A new assignment to the variable (in this example `S`) is not necessary, in contrast to most other MuPAD functions and data types.

---

The stacks created in a session are named `Stack1`, `Stack2`, ... and printed as such.

## Examples

### Example 1

We create an empty stack, and fill it with some values:

```
S := adt::Stack();  
S::push(a): S::push(b): S::push(c):
```

*Stack1*

The stack now contains 3 elements:

```
S::nops()
```

*3*

The top of the stack is the last valued pushed:

```
S::top()
```

*c*

Now, we fetch successively the values contains in S; they come back in reversed order:

```
S::pop();  
S::pop();  
S::pop()
```

*c*

*b*

*a*

Now, the stack is empty. Trying to pop again an element from it results in a FAIL value being returned:

```
S::pop()
```

*FAIL*

## Parameters

### **stack**

An expression sequence on page 1-88 of objects to initialize the stack

## Return Values

Object of the domain `adt::Stack`

## Methods

**S::empty** — **I the stack empty**

S::empty()

**S::nops** — **Size of the stack**

S::nops()

**S::depth** — **Depth of the stack**

S::depth()

**S::top** — **Top element of the stack**

S::top()

**S::push** — **Push an element on the stack**

S::push(x)

**S::pop** — **Pop an element from the stack**

S::pop()

**S::reverse** — **Revert the stack**

S::reverse()

**S :: copy — Copy of the stack**

S :: copy()

# adt::Tree

Abstract data type "Tree"

## Syntax

```
adt::Tree(tree)
```

## Description

adt::Tree implements the abstract data type "Tree".

A tree must be given as a special MuPAD list. The first object of the list is the root of the tree. All further objects are leaves or subtrees of the tree. A subtree is again a special list (as described), and any other MuPAD object will be interpreted as leaf of the tree (see "Example 1" on page 2-14 (Symbolic Math Toolbox)).

A tree can be used to display data in tree structure using the function `output::tree` (or the method "print" of a tree). The nodes and leaves of the tree will be printed on page 1-1636 by MuPAD when the tree will be displayed.

A tree can also be used as datatype to keep and handle any MuPAD data.

---

**Note** The methods of all abstract data types must be called especially and will result changing the object itself as side effect.

---

`T := adt::Tree([_plus, 3, 4, [_mult, 5, 3], 1])` builds a tree and assigns it to the variable T.

Every tree will be displayed as Tree followed by a number. This name is generated by `genident`.

To display the content of a tree, the function `expose` or the method "print" of the tree itself must be used.

**Note** *All following methods changes the value of T itself.* A new assignment to the variable (in this example T) is not necessary, in contrast to all other MuPAD functions and data types.

---

The methods `nops`, `op`, `expr`, `print`, `indent`, `chars` are now available for handling with trees.

## Examples

### Example 1

Creating a simple tree with only two leaves. To access and display a tree it must be assigned to a variable:

```
T := adt::Tree(["ROOT", "LEFT", "RIGHT"])
```

Tree1

The tree will only be printed by its name. To display the tree, the function `expose` or the method `"print"` of the tree must be used:

```
T::print()
```

```
ROOT
|
+-- LEFT
|
`-- RIGHT
```

```
expose(T)
```

```
ROOT
|
+-- LEFT
|
`-- RIGHT
```

The next tree contains two subtrees as leaves:



```
T := adt::Tree(["ROOT", ["LRROOT", "LLEFT", "LRIGHT"],
               ["RRROOT", "RLEFT", "RRIGHT"]]);
T::print()
```

```
ROOT
|
+-- LRROOT
|   |
|   +-- LLEFT
|   |
|   \-- LRIGHT
|
\-- RRROOT
    |
    +-- RLEFT
    |
    \-- RRIGHT
```

## Example 2

Get the operands of a tree: Also a subtree can be an operand:

```
T := adt::Tree(["ROOT", ["LRROOT", "LLEFT", "LRIGHT"],
               "MIDDLE",
               ["RRROOT", "RLEFT", "RRIGHT"]]);
T::op()
```

```
Tree4, "MIDDLE", Tree5
```

Use `expose` to display subtrees:

```
map(%, expose)
```

```
LRROOT                                RRROOT
|                                     |
+-- LLEFT , "MIDDLE", +-- RLEFT
|                                     |
\-- LRIGHT                            \-- RRIGHT
```

Get all operands including the root:

```
T::op(0..T::nops())
```

"ROOT", Tree6, "MIDDLE", Tree7

Access to various operands:

```
T::op(0);
T::op(2..3);
T::op([1, 2])
```

"ROOT"

"MIDDLE", Tree9

"LRIGHT"

### Example 3

The default characters are [ "|", "+", "-", ,, " " ]:

```
T := adt::Tree(["ROOT", ["LROOT", "LLEFT", "LRIGHT"],
               ["RRROOT", "RLEFT", "RRIGHT"]]);
T::print()
```

```

ROOT
|
+-- LROOT
|   |
|   +-- LLEFT
|   |
|   \-- LRIGHT
|
\-- RRROOT
    |
    +-- RLEFT
    |
    \-- RRIGHT

```

The characters can be changed:

```
T::chars(["|", "|", "_", "|", " "]):
T::print()
```

```
ROOT
|
|_ LRROOT
|   |
|   |_ LLEFT
|   |_ LRIGHT
|_ RRROOT
|   |
|   |_ RLEFT
|   |_ RRIGHT
```

#### Example 4

A tree visualizes the structure of an expression:

```
T:= adt::Tree([_plus, [_power, [sin, x], 2], [_power, [cos, x], 2]]):
T::print()
```

```
_plus
|
+--- _power
|   |
|   +--- sin
|   |   |
|   |   |_ x
|   |   |
|   |   |_ 2
|   |
|   |_ 2
|
--- _power
|   |
|   +--- cos
|   |   |
|   |   |_ x
|   |   |
|   |   |_ 2
```

A tree can be converted to a MuPAD expression:

```
T::expr(), simplify(T::expr())
```

```
cos(x)2 + sin(x)2, 1
```

## Parameters

### **tree**

The tree, given as a special list (see details)

## Methods

### **nops — Number of operands**

```
nops()
```

In this example T has 4 operands, the numbers 3, 4, 1 and the subtree  
adt::Tree([\_mult, 5, 3]).

### **op — Operand of a tree**

```
op(<n>)
```

T::op(n) returns the specified operands of the tree. n can be a number between 0 and T::nops() (0 gives the root of the tree), a sequence i . . j (to return the ith to jth operand), or a list to specify operands of subtrees (exactly as for the kernel function op). T::op() returns all operands except the 0-th as expression sequence. See “Example 2” on page 2-15 (Symbolic Math Toolbox).

### **expr — Convert a tree to an expression**

```
expr()
```

### **print — Display a tree**

```
print()
```

**indent** — Indent width of each operand

indent(<n>)

**chars** — Indent width of each operand

chars(<list>)

## See Also

**MuPAD Functions**

output::tree



# Ax - Axioms

---

## **Ax::canonicalOrder**

Axiom of canonically ordered sets

### **Description**

`Ax::canonicalOrder` states that a domain has an order `< (_less)` which is defined by the canonical order of the MuPAD expressions.

This implies that the order of two elements is defined by the system function `_less`.



# Ax::canonicalRep

Axiom of canonical representation

## Description

Ax::canonicalRep states that domain elements are canonically represented, i.e. that each element of the domain has only one unique expression which represents it.

This axiom implies that for an abelian monoid the axiom Ax::normalRep also holds. This is not enforced by the category but must be stated by the implementor of a domain.

## Ax::canonicalUnitNormal

Axiom of canonical unit normals

### Description

Ax::canonicalUnitNormal states that the method "unitNormal" of an integral domain (category `Cat::IntegralDomain`) returns a unique unit normal.

This means that for each non-zero element  $x$  of the integral domain there exists a unique associate among the associate class of  $x$ , i.e. for any  $x$  and  $y$  of a domain `dom` of category `Cat::IntegralDomain` where `dom::associates(x, y)` returns `TRUE` the equation `dom::equal(dom::unitNormal(x), dom::unitNormal(y)) = TRUE` must hold.

Note that this axiom does not imply that the unit normals are canonically represented. The unit normals of  $x$  and  $y$  must be mathematically equal in the sense of the method "equal", they need not be structurally equal as MuPAD objects.

# Ax::closedUnitNormals

Axiom of closed unit normals

## Description

Ax::closedUnitNormals states that the unit normals of an integral domain are closed under multiplication, i.e., that  $\text{dom}::\text{equal}(x, \text{dom}::\text{unitNormal}(a) * \text{dom}::\text{unitNormal}(b)) = \text{TRUE}$  implies  $\text{dom}::\text{equal}(x, \text{dom}::\text{unitNormal}(x)) = \text{TRUE}$  for all elements  $x, a$  and  $b$  of the domain  $\text{dom}$ .

This axiom may be used only in conjunction with the axiom Ax::canonicalUnitNormal. If an integral domain has no unique unit normals, this axiom may not be stated.

## **Ax::efficientOperation**

Axiom of efficient operations

### **Syntax**

`Ax::efficientOperation(oper)`

### **Description**

`Ax::efficientOperation(oper)` states that operation `oper` can be performed efficiently.

The string `oper` must be the name of the operation's slot in the domain stating the axiom. Examples are `"_mult"`, `"_invert"` or `"_divide"`.

### **Parameters**

**oper**

A string which defines the efficient operation.

## Ax::indetElements

Axiom that indeterminates may be elements

### Description

Ax::indetElements states that there exist domain elements that may also be regarded as being transcendental over the domain.

Ax::indetElements has no mathematical meaning: elements of a ring are always algebraic (of degree 1) over the ring. However, since there are domains in MuPAD that comprise all MuPAD identifiers, insisting on this viewpoint would mean that polynomials over such domains could not be constructed. Hence MuPAD allows the user to regard an identifier as being transcendental over the set of all identifiers.

## **Ax::normalRep**

Axiom of normal representation

### **Description**

`Ax::normalRep` states that an abelian monoid has a canonical representation of its zero element, i.e., that there is only one unique expression to represent zero.

If the axiom `Ax::normalRep` holds for a domain `dom`, one may test for zero by comparing an element with `dom::zero` using the system function `_equal`.

# Ax::noZeroDivisors

Axiom of rings with no zero divisor

## Description

Ax::noZeroDivisors states that a ring without a unit has no zero divisors, i.e., that the product of two non-zero elements is never zero.

Note that an integral domain implicitly has no zero divisors.

## Ax::systemRep

Axiom of façade domains

### Description

`Ax::systemRep` states that domain elements are represented by elements of built-in domains.

There are principally two ways to represent the elements of a domain: On the one hand the elements may be created explicitly by the system function `new`, on the other hand one may use the built-in (or basic) domains of MuPAD (like `DOM_INT`) to represent the elements.

Domains which don't create elements of their own but use elements of basic domains instead are called *façade domains*.

The usage of basic domains for the representation has the advantage that system functions may be used directly as methods of the domain without the overhead caused by overloading and procedure calls. But it has some severe limitations, see the domain `Dom::Expression` for details.

The axiom `Ax::systemRep` is used to state that the elements of a domain are represented by basic domains and are not created by `new`.



# Cat - Categories

---

## Cat::BaseCategory

Base category

### Description

`Cat::BaseCategory` is the most general super-category of all categories defined by the `Cat` (Symbolic Math Toolbox) package. Any domain in the `Dom` (Symbolic Math Toolbox) package is of this category.

The methods defined by `Cat::BaseCategory` are related to type conversion and equality testing, they are not related to an algebraic structure.

### Methods

#### Basic Methods

**convert** — Convert into this domain

`convert(x)`

**convert\_to** — Convert to certain type

`convert_to(x, T)`

**equal** — Test for equality

`equal(x, y)`

Note that this method does *not* overload the function `_equal`, i.e. the `=` operator. The function `_equal` cannot be overloaded.

**expr** — Convert into expression

`expr(x)`

## Conversion Methods

### **coerce** — Coerce into this domain

`coerce(x)`

The implementation provided tries to convert `x` into an element of this domain by first calling `dom::convert(x)` and then, if this fails, `x::dom::convert_to(x, dom)`; it returns `FAIL` if both methods fail.

### **equiv** — Test for equivalence

`equiv(x, y)`

The implementation provided tries to convert `x` and `y` into elements of this domain and then calls `dom::equal` with these elements. It returns `FAIL` if the conversion fails or the equality test returns `UNKNOWN`.

### **new** — Create element of this domain

`new(x)`

Given a domain `D`, an expression of the form `D(x, ...)` results in a call of the form `D::new(x, ...)`.

The implementation provided here tries to convert `x` by calling `dom::convert(x)` and returns the result. It raises an error if `dom::convert` returns `FAIL`.

### **print** — Return expression to print an element

`print(x)`

Please do *not* print directly in this method by calling the function `print` for example!

The implementation provided here is `dom::expr`.

### **testtype** — Test type of object

`testtype(x, T)`

This method must return `TRUE` if it can decide that `x` is of type `T`, `FALSE` if it can decide that `x` is not of type `T` and `FAIL` if it can not decide the test.

This method is called in three different situations: Either if the argument  $x$  is of this domain, or if  $T$  is this domain, or if  $T$  is an element of this domain. Thus the following three situations can arise:

- $x$  is an element of the current domain.

In this case it must be tested if  $x$  may be regarded as an element of the type  $T$ , which may either be a domain or type expression. By default, this is only true if the domain type of  $x$  is  $T$ , or if  $T$  is a domain constructor for which  $x :: \text{dom} :: \text{hasProp}(x, T)$  is `TRUE`. In particular,  $x$  is, by default, not of type  $T$  if  $T$  is a type of the Type (Symbolic Math Toolbox) library.

- $T$  is the current domain.

In this case it must be tested if  $x$  may be regarded as an element of this domain. By the default implementation provided, this is `TRUE` only if the domain type of  $x$  is `dom`.

- $T$  is an element of the current domain.

In this case  $T$  is regarded as a type expression. The default implementation provided returns `TRUE` if the domain type of  $x$  is  $T$ , and `FAIL` if not. A special rule holds if  $T$  is a façade domain: in that case, `coerce(x, T)` is called, if this is successful `TRUE` is returned and `FAIL` if not.

## Technical Methods

### **new\_extelement — Create element of kernel or façade domain**

`new_extelement(x, ...)`

When an expression `new(D, x, ...)` is evaluated and  $D$  is a domain with method `"new_extelement"`, then `D :: new_extelement(D, x, ...)` is evaluated and returned as result.

Kernel or façade domains must define this method because otherwise the function `new` would return a “container” element of  $D$  rather than a “raw” element as intended.

The implementation provided here returns the result of `D :: new(x, ...)`.

# Cat::AbelianGroup

Category of Abelian groups

## Description

Cat::AbelianGroup represents the category of Abelian groups.

A Cat::AbelianGroup is an Abelian monoid with cancellation law where the operation + is invertible.

## Categories

Cat::CancellationAbelianMonoid

## Methods

### Basic Methods

**\_negate** — Return opposite

\_negate(x)

### Mathematical Methods

**equal** — Test for equality

equal(x, y)

**intmult** — Return integer multiple

intmult(x, n)

**`_subtract` – Subtract two elements**

`_subtract(x, y)`

# Cat::AbelianMonoid

Category of Abelian monoids

## Description

`Cat::AbelianMonoid` represents an Abelian monoid.

An `Cat::AbelianMonoid` is an Abelian semi-group with a neutral element `dom::zero` according to the operation `+` (`_plus`).

Use the axiom `Ax::normalRep` to state that zero is always represented in a unique way (i.e. canonically).

If an Abelian monoid has not the axiom `Ax::normalRep` then `dom::zero` is only one possible representation of the neutral element. An Abelian semi-group must at least have the method `"iszero"` to test for zero in such a case.

## Axioms

If the domain has `Ax::canonicalRep`, then `Ax::normalRep`.

## Categories

`Cat::AbelianSemiGroup`

## Entries

"zero"	Must hold the neutral element according to the operation <code>+</code> .
--------	---

## Methods

### Mathematical Methods

**intmult** — Return integer multiple

`intmult(x, n)`

**iszero** — Test if element is zero

`iszero(x)`



# Cat::AbelianSemiGroup

Category of Abelian semi-groups

## Description

Cat::AbelianSemiGroup represents the category of Abelian semi-groups where the operation is written as addition. Hence an Cat::AbelianSemiGroup is a set with an associative and commutative operation + (\_plus).

Note that non-Abelian semi-groups with operation \* have category Cat::SemiGroup.

## Categories

Cat::BaseCategory

## Methods

### Basic Methods

**\_plus** — Return the sum of its arguments

\_plus(x, ...)

### Mathematical Methods

**intmult** — Return integer multiple

intmult(x, n)

## **Cat::Algebra**

Category of associative algebras

### **Syntax**

`Cat::Algebra(R)`

### **Description**

`Cat::Algebra(R)` represents the category of associative algebras over the commutative ring  $R$ .

A `Cat::Algebra(R)` is a module over a commutative ring  $R$  which also is a ring.

### **Categories**

`Cat::Ring`, `Cat::Module(R)`

### **Parameters**

**R**

A domain which is a commutative ring. The algebra will be an algebra over this ring.

# Cat::CancellationAbelianMonoid

Category of abelian monoids with cancellation

## Description

Cat::CancellationAbelianMonoid represents the category of Abelian monoids with cancellation.

A Cat::CancellationAbelianMonoid is an Abelian monoid where the cancellation law holds according to the operation  $+$ , i.e.  $a + b = a + c$  implies  $b = c$ .

## Categories

Cat::AbelianMonoid

## Methods

### Basic Methods

**\_subtract** — Subtract two elements

\_subtract(x, y)

### Mathematical Methods

**equal** — Test for equality

equal(x, y)

The method "iszero" is used to test for zero.

**\_negate** — Negate element

`_negate(x)`

**intmult** — Return integer multiple

`intmult(x, n)`

# Cat::CommutativeRing

Category of commutative rings

## Description

Cat::CommutativeRing represents the category of commutative rings.

A Cat::CommutativeRing is a ring with unit `dom::one` where the multiplication `* (_mult)` is commutative. It is also a right module over itself.

This implementation additionally assumes that the elements are always constant with respect to differentiation and derivatives. One must re-implement the methods "diff" and "D" if this assumption is false.

## Categories

Cat::Ring, Cat::RightModule(dom)

## Methods

### Mathematical Methods

**diff** — Differentiate element

diff(x, <v, ...>)

**D** — Return derivative

D(l, x)

## Cat::DifferentialRing

Category of ordinary differential rings

### Description

Cat::DifferentialRing represents the category of ordinary differential rings.

A Cat::DifferentialRing is a commutative ring with a single derivation operator  $D$ .

A derivation is a linear operator with product rule, i.e.  $(f g)' = f' g + f g'$  holds for all  $f$  and  $g$ .

### Categories

Cat::PartialDifferentialRing

### Methods

#### Basic Methods

**D** — Return derivative

`D(f)`

**diff** — Differentiation with respect to a variable

`diff(f, x)`

# Cat::EntireRing

Category of entire rings

## Description

Cat::EntireRing represents the category of entire rings.

An Cat::EntireRing is a ring with unit "one" which has no zero divisors: Given non-zero ring elements  $a$  and  $b$  the product  $a$  times  $b$  is never zero.

## Axioms

Ax::noZeroDivisors

## Categories

Cat::Ring, Cat::RightModule(dom)

## **Cat::EuclideanDomain**

Category of Euclidean domains

### **Description**

`Cat::EuclideanDomain` represents the category of Euclidean domains.

A `Cat::EuclideanDomain` is a principal ideal domain with an “Euclidean degree” function `euclideanDegree` and operations `quo` and `rem` computing the Euclidean quotient and Euclidean remainder.

The Euclidean degree returns nonnegative integers such that for each non-zero  $x$  and  $y$  there exist  $s$  and  $r$  such that  $x = ys + r$  and either the Euclidean degree of  $r$  is less than that of  $s$  or  $r$  is zero.

In addition  $s$  is equal to `quo(x, y)` and  $r$  is equal to `rem(x, y)`.

### **Categories**

`Cat::PrincipalIdealDomain`

### **Methods**

#### **Basic Methods**

**euclideanDegree** — Return Euclidean degree

`euclideanDegree(x)`

**divide** — Division with remainder

`divide(x, y)`



## Mathematical Methods

### **`_divide` — Exact division**

`_divide(x, y)`

### **`gcd` — Greatest common divisor**

`gcd(x, ...)`

### **`gcdex` — Extended greatest common divisor**

`gcdex(x, y)`

### **`idealGenerator` — Generator of finitely generated ideal**

`idealGenerator(x, ...)`

### **`quo` — Euclidean quotient**

`quo(x, y)`

The default implementation provided here uses the basic method "divide".

### **`rem` — Euclidean remainder**

`rem(x, y)`

The default implementation provided here uses the basic method "divide".

## Cat::FactorialDomain

Category of factorial domains

### Description

`Cat::FactorialDomain` represents the category of factorial domains (i.e., unique factorization domains).

A `Cat::FactorialDomain` is an integral domain with gcd where an unique factorization can be computed.

The factorization methods are named "factor" and "sqrfree" and must return elements of the domain `Factored` over this domain.

### Categories

`Cat::GcdDomain`

### Methods

#### Basic Methods

**factor** — Unique factorization

`factor(x)`

See `Factored` for details about the representation of the factorization.

## Mathematical Methods

**irreducible** — Test if element is irreducible

`irreducible(x)`

**sqrfree** — Square-free factorization

`sqrfree(x)`

See `Factored` for details about the representation of the factorization.

The default implementation provided here uses the method "`factor`" and therefore may be very inefficient.

## Cat::Field

Category of fields

### Description

`Cat::Field` represents the category of fields.

A `Cat::Field` is a factorial domain, an Euclidean domain and a skew field. As a Euclidean domain, it has a commutative multiplication `* (_mult)` and as a skew field, the multiplication is invertible.

Many of the methods defined for factorial and Euclidean domains are trivial for a field.

### Axioms

`Ax::canonicalUnitNormal`, `Ax::closedUnitNormals`

### Categories

`Cat::EuclideanDomain`, `Cat::FactorialDomain`, `Cat::SkewField`

### Methods

#### Mathematical Methods

**associates** — Test for associate elements

`associates(x, y)`

**\_divide** — Exact division

`_divide(x, y)`

**divide** — Division with remainder

divide(x, y)

**divides** — Test if division is exact

divides(x, y)

**euclideanDegree** — Return Euclidean degree

euclideanDegree(x)

**factor** — Unique factorization

factor(x)

**gcd** — Greatest common divisor

gcd(x, ...)

**irreducible** — Test if element is irreducible

irreducible(x)

**isUnit** — Test if element is an unit

isUnit(x)

**quo** — Return Euclidean quotient

quo(x, y)

**rem** — Return Euclidean remainder

rem(x, y)

**sqrfree** — Square-free factorization

sqrfree(x)

**unitNormal** — Unit normal form

unitNormal(x)

**unitNormalRep — Unit normal representation**

unitNormalRep(x)

# Cat::FiniteCollection

Category of finite collections

## Description

`Cat::FiniteCollection` represents the category of finite collections, i.e., the category of “universal” bags.

A finite collection is a data structure where each element represents a finite bag of “things” of any type.

The elements are numbered  $1, \dots, \text{nops}(c)$ , where  $\text{nops}(c)$  is the number of elements in the bag.

## Categories

`Cat::BaseCategory`

## Methods

### Basic Methods

**`_index`** — Return element given its index

`_index(x, i)`

**`map`** — Map function on elements

`map(x, f, <a, ...>)`

**`nops`** — Return number of elements

`nops(x)`

### **op — Return certain elements**

`op(x)`

`op(x, i)`

Must return the *i*-th element of *x* or FAIL if an element with the given index does not exist.

Operand ranges or paths need not be handled by this method because they are handled directly by `op`.

### **set\_index — Change element with given index**

`set_index(x, i, v)`

Overloads the function `_assign` with an `_index` expression on the left hand side. The result is assigned to *x*.

### **subs — Substitute in elements**

`subs(x, e = f)`

### **subsop — Substitute operands**

`subsop(x, i = v)`

## **Technical Methods**

### **mapCanFail — Map function on elements**

`mapCanFail(x, f, <a, ...>)`

### **testEach — Test each element with a predicate**

`testEach(x, f, <a, ...>)`

### **testOne — Test if element exists fulfilling a predicate**

`testOne(x, f, <a, ...>)`



# Cat::GcdDomain

Category of integral domains with gcd

## Description

`Cat::GcdDomain` represents the category of integral domains with a gcd.

A `Cat::GcdDomain` is an integral domain where the greatest common divisor of two elements can be computed by the method "gcd".

## Categories

`Cat::IntegralDomain`

## Methods

### Basic Methods

**gcd** — Greatest common divisor

`gcd(x, ...)`

The method must satisfy the following conditions:

- 1 `x` and `y` must divide `dom::gcd(x,y)`,
- 2 if `z` divides both `x` and `y`, then `z` must divide `dom::gcd(x,y)`,
- 3 if a domain has the axiom `Ax::canonicalUnitNormal` then `dom::gcd(x,y)` must be equal to `dom::unitNormal(dom::gcd(x,y))`.

Remember that `x` divides `y` if `_divide(x,y)` does not return FAIL.

## **Mathematical Methods**

**lcm — Least common multiple**

$\text{lcm}(x, \dots)$

# Cat::Group

Category of groups

## Description

Cat::Group represents the category of groups.

A Cat::Group is a (potentially non-Abelian) monoid where the group operation \* (\_mult) is invertible.

## Categories

Cat::Monoid

## Methods

## Mathematical Methods

**\_divide — Return quotient**

\_divide(x, y)

## Cat::HomogeneousFiniteCollection

Category of homogeneous finite collections

### Syntax

`Cat::HomogeneousFiniteCollection(T)`

### Description

`Cat::HomogeneousFiniteCollection(T)` represents the category of homogeneous finite collections (i.e. bags) of elements of the domain T.

A `Cat::HomogeneousFiniteCollection` is a finite collection where each element of the collection must be from the same domain T.

### Categories

`Cat::FiniteCollection`

If T is a `Cat::OrderedSet`, then `Cat::OrderedSet`.

### Parameters

T

A domain which must be from the category `Cat::BaseCategory`. Only elements of this domain may be contained in the collection.

### Entries

"elemDom"	The parameter domain T.
-----------	-------------------------

## Methods

### Mathematical Methods

**`_less` – Compare two elements**

`_less(x, y)`

Returns TRUE if x is less than y.

The collections x and y are ordered by the lexical ordering of their elements.

## Cat::HomogeneousFiniteProduct

Category of homogeneous finite products

### Syntax

`Cat::HomogeneousFiniteProduct(T)`

### Description

`Cat::HomogeneousFiniteProduct(T)` represents the category of homogeneous finite products of elements of the domain `T`.

A `Cat::HomogeneousFiniteProduct(T)` is a homogeneous finite collection where each collection has the same number of elements of the domain `T`.

The number of elements must be given by the entry "`card`", which must be defined by domains of this category. It is not given as a category parameter simply because it is not needed. Thus no unnecessary instances of the category are created.

One could principally implement all the algebraic operations here, but they will be slow if the methods "`_index`" and "`set_index`" are slow, which most often will be the case. So we avoid the work and let the domain implementors do it.

### Categories

`Cat::HomogeneousFiniteCollection(T)`

If `T` is a `Cat::DifferentialRing`, then `Cat::DifferentialRing`.

If `T` is a `Cat::PartialDifferentialRing`, then `Cat::PartialDifferentialRing`.

If `T` is a `Cat::CommutativeRing`, then `Cat::CommutativeRing`.

If `T` is a `Cat::SkewField`, then `Cat::SkewField`.

If `T` is a `Cat::Ring`, then `Cat::Ring`.

If T is a `Cat::Rng`, then `Cat::Rng`.

If T is a `Cat::AbelianGroup`, then `Cat::AbelianGroup`.

If T is a `Cat::CancellationAbelianMonoid`, then `Cat::CancellationAbelianMonoid`.

If T is a `Cat::AbelianMonoid`, then `Cat::AbelianMonoid`.

If T is a `Cat::AbelianSemiGroup`, then `Cat::AbelianSemiGroup`.

If T is a `Cat::Group`, then `Cat::Group`.

If T is a `Cat::Monoid`, then `Cat::Monoid`.

If T is a `Cat::SemiGroup`, then `Cat::SemiGroup`.

If T is a `Cat::CommutativeRing`, then `Cat::Algebra(T)`.

If T is a `Cat::Ring`, then `Cat::LeftModule(T)`.

If T is a `Cat::Ring`, then `Cat::RightModule(T)`.

## Parameters

T

A domain which must be from the category `Cat::BaseCategory`. This defines the domain of the products elements.

## Entries

"card"	Must hold the number of elements of a collection.
"characteristic"	Defined if T is a ring: In this case the characteristic of the product domain is the same as that of T.

## Methods

### Basic Methods

**zip** — Combine elements

`zip(x, y, f)`

**zipCanFail** — Combine elements, may fail

`zipCanFail(x, y, f)`

### Access Methods

**nops** — Return number of elements

`nops(x)`



# Cat::IntegralDomain

Category of integral domains

## Description

`Cat::IntegralDomain` represents the category of integral domains.

A `Cat::IntegralDomain` is a commutative and entire ring which has a “partial” division method `_divide`: If `b` divides `a` then `dom::_divide(a,b)` must return the quotient, otherwise FAIL. The result of the method `_divide` must be unique.

Use the axiom `Ax::canonicalUnitNormal` to state in addition that there exists a canonical unit normal form for each element of the ring. If a ring has the axiom `Ax::canonicalUnitNormal` the method `unitNormal` must return the unique unit normal for a ring element. If the axiom is not valid the method may return any associate.

Use the axiom `Ax::closedUnitNormals` in addition to state that the unit normals which are computed by the method `unitNormal` are closed under multiplication, i.e. that the product of two unit normals returns a unit normal.

These two axioms are not implicitly valid for an `Cat::IntegralDomain` because there are integral domains for which one can't compute a canonical unit normal for each element.

## Categories

`Cat::EntireRing`, `Cat::CommutativeRing`, `Cat::Algebra(dom)`

## Methods

### Basic Methods

#### **`_divide`** — Return quotient

`_divide(x, y)`

The result must be unique:

- 1 the product  $y * \text{dom} :: \_divide(x, y)$  must be equal to  $x$  provided that  $y$  is not zero and  $y$  divides  $x$ ,
- 2 if  $x$  is equal to  $y * z$  then  $y$  must divide  $x$ .

It is an error if  $y$  is zero.

#### **`isUnit`** — Test if element is a unit

`isUnit(x)`

#### **`unitNormal`** — Return an associate

`unitNormal(x)`

If the ring has the axiom `Ax :: canonicalUnitNormal` the method must return the unique unit normal of  $x$ .

An implementation is provided if the ring has *not* the axiom `Ax :: canonicalUnitNormal`: In this case simply  $x$  is returned.

### Mathematical Methods

#### **`associates`** — Test if elements are associates

`associates(x, y)`

#### **`divides`** — Test if elements divides another

`divides(x, y)`

**unitNormalRep — Return the unit normal representation**`unitNormalRep(x)`

If the ring has the axiom `Ax::canonicalUnitNormal` the method must return the unique unit normal of `x`. The default implementation uses the method "unitNormal" to compute the unit normal `n` in this case.

If the ring does not have the axiom `Ax::canonicalUnitNormal` the method simply returns `[x, dom::one, dom::one]`.

## Cat::LeftModule

Category of left R -modules

### Syntax

`Cat::LeftModule(R)`

### Description

`Cat::LeftModule(R)` represents the category of left R-modules.

A `Cat::LeftModule(R)` is an Abelian group together with a `rng R` (a ring without unit) and a left multiplication `* (_mult)`.

The left multiplication is an operation taking an element of `rng R` and a module element and returning a module element.

Given ring elements  $a, b$  and module elements  $x, y$  the following 3 distributive laws must hold:

- 1**  $(a b) x = a (b x),$
- 2**  $(a + b) x = a x + b x,$
- 3**  $a (x + y) = a x + a y.$

Beware: The operation of a non-Abelian semi-group is also written as `* (_mult)`. The method `"_mult"` must handle the situation if a left module is also a non-Abelian semi-group. In such a case it must both implement the group operation and the left multiplication by elements of the `rng`.

### Categories

`Cat::AbelianGroup`

## Parameters

**R**

A domain which must be from the category `Cat :: Rng`.

## Methods

### Basic Methods

**`_mult`** — Left multiplication by a rng element

`_mult(r, x)`

## Cat::Matrix

Category of matrices

### Syntax

Cat::Matrix(R)

### Description

Cat::Matrix(R) represents the category of matrices over the rng R.

A Cat::Matrix(R) is a matrix of arbitrary dimension over a component ring R.

In the following description of the methods, we use the following notations for a matrix  $A$  from a domain of category Cat::Matrix(R):

$nrows(A)$  denotes the number of rows and  $ncols(A)$  the number of columns of  $A$ .

Further on, a *row index* is an integer ranges from 1 to  $nrows(A)$ , and a *column index* is an integer ranges from 1 to  $ncols(A)$ .

### Categories

Cat::BaseCategory

### Parameters

R

A domain which must be from the category Cat::Rng (a ring without unit).

## Entries

"coeffRing"	is set to R.
-------------	--------------

## Methods

### Basic Methods

#### **`_index` — Matrix indexing**

`_index(A, i, j)`

#### **`matdim` — Matrix dimension**

`matdim(A)`

#### **`new` — Matrix definition**

`new(m, n)`

Of course, this method may implement further possibilities to create matrices (for example, see the method "new" of the domain constructor `Dom::Matrix`).

#### **`set_index` — Setting matrix components**

`set_index(A, i, j, x)`

## Mathematical Methods

#### **`_negate` — Negate a matrix**

`_negate(A)`

#### **`_plus` — Add matrices**

`_plus(A1, A2, ...)`

The matrices must be of the same domain type, otherwise FAIL is returned.

**\_subtract — Subtract two matrices**`_subtract(A, B)`**equal — Test on equality of matrices**`equal(A, B)`**identity — Identity matrix**`identity(n)`

It only exists if R is of category `Cat :: Ring`, i.e., a ring with unit.

**iszero — Test on zero matrices**`iszero(A)`

Note that there may be more than one representation of the zero matrix of a given dimension if R does not have the axiom `Ax :: canonicalRep`.

**transpose — Transpose of a matrix**`transpose(A)`

## Access Methods

**col — Extracting columns**`col(A, c)`**concatMatrix — Horizontal concatenation of matrices**`concatMatrix(A, B)`

An error message is issued if the two matrices do not have the same number of rows.

**delCol — Deleting columns**`delCol(A, c)`

If A only consists of one column then NIL is returned.



**delRow — Deleting rows**`delRow(A, r)`

If A only consists of one row then NIL is returned.

**row — Extracting rows**`row(A, r)`**setCol — Replacing columns**`setCol(A, c, v)`**setRow — Replacing rows**`setRow(A, r, v)`**stackMatrix — Appending of matrices vertically**`stackMatrix(A, B)`

An error message is issued if the two matrices do not have the same number of columns.

**swapCol — Swapping matrix columns**`swapCol(A, c1, c2)`**swapRow — Swapping matrix rows**`swapRow(A, r1, r2)`

# Cat::Module

Category of R-modules

## Syntax

`Cat::Module(R)`

## Description

`Cat::Module(R)` represents the category of R-modules.

A `Cat::Module(R)` is a left and right R-module over a commutative ring R.

Right and left multiplications must be both implemented by the method `"_mult"`.

## Categories

`Cat::LeftModule(R)`, `Cat::RightModule(R)`

## Parameters

**R**

A domain which must be from the category `Cat::CommutativeRing`.

# Cat::Monoid

Category of monoids

## Description

Cat::Monoid represents the category of monoids.

Cat::Monoid is a non-Abelian semi-group with a neutral element one (dom::one) according to the group operation \* (\_mult).

## Categories

Cat::SemiGroup

## Entries

"one"	Must hold the neutral element according to the operation *.
-------	---

## Methods

### Basic Methods

**\_invert** — Return inverse

\_invert(x)

## **Mathematical Methods**

**isone** — Test if element is one

`isone(x)`

**\_power** — Raise to the nth power

`_power(x, n)`

This implementation does “repeated squaring”.

# Cat::OrderedSet

Category of ordered sets

## Description

Cat::OrderedSet represents the category of ordered sets.

An Cat::OrderedSet is a set with a (complete) order relation `< (_less)`.

Use the axiom `Ax::canonicalOrder` to state that elements of a domain are canonically ordered as MuPAD expressions (i.e. ordered with respect to the kernel function `_less`).

## Categories

Cat::BaseCategory

## Methods

### Basic Methods

**`_less` — Compare if element is less**

`_less(x, y)`

An implementation is provided if this domain has axiom `Ax::canonicalOrder`.

### Mathematical Methods

**`_leequal` — Compare if element is less or equal**

`_leequal(x, y)`

The implementation provided uses the methods "`_less`" and "`equal`".

**max** — Return maximum

`max(x, ...)`

**min** — Return minimum

`min(x, ...)`

**sort** — Sort list of elements

`sort(l)`

# Cat::PartialDifferentialRing

Category of partial differential rings

## Description

Cat::PartialDifferentialRing represents the category of partial differential rings.

A Cat::PartialDifferentialRing is a commutative ring with a finite set of derivation operators  $D_i$ .

A derivation is a linear operator with product rule, i.e.  $D_i(f * g)$  equals  $D_i(f) * g + f * D_i(g)$  for all  $f$  and  $g$ .

For many partial differential rings the derivations are differentiations with respect to some indeterminates. Thus in order to support a natural notion it is also supposed that a method "diff" exists, such that `diff(f, x)` returns the partial derivation of  $f$  with respect to the indeterminate  $x$ .

## Categories

Cat::CommutativeRing

## Methods

### Basic Methods

**D** — Return derivative

`D(l, x)`

**diff** — Return partial derivative

`diff(x, <v, ...>)`

## Cat::Polynomial

Category of multivariate polynomials

### Syntax

`Cat::Polynomial(R)`

### Description

`Cat::Polynomial(R)` represents the category of multivariate polynomials over  $R$ .

A `Cat::Polynomial(R)` is a multivariate polynomial ring over a commutative coefficient ring  $R$ .

### Axioms

If  $R$  has `Ax::canonicalUnitNormal`, then `Ax::canonicalUnitNormal`.

If  $R$  has `Ax::closedUnitNormals`, then `Ax::closedUnitNormals`.

### Categories

`Cat::PartialDifferentialRing`, `Cat::Algebra(R)`

If  $R$  is a `Cat::FactorialDomain`, then `Cat::FactorialDomain`.

If  $R$  is a `Cat::GcdDomain`, then `Cat::GcdDomain`.

If  $R$  is a `Cat::IntegralDomain`, then `Cat::IntegralDomain`.



## Parameters

R

A domain which must be from the category `Cat::CommutativeRing`.

## Entries

"coeffRing"	The coefficient ring R.
"characteristic"	The characteristic of this domain, which is the same as that of the ring R.

## Methods

### Basic Methods

#### **coeff — Return coefficients**

`coeff(p)`

`coeff(p, x, n)`

`coeff(p, n)`

Must return the coefficient of  $x^n$  of  $p$ , which is a polynomial in the remaining indeterminates.

Must return the coefficient of  $x^n$  of  $p$ , where  $x$  is the main variable of  $p$ .

#### **degree — Return total degree**

`degree(p)`

`degree(p, x)`

Must return the degree of  $p$  with respect to the indeterminate  $x$ .

### **degreevec — Return degree vector**

degreevec(p)

### **evalp — Evaluate at a point**

evalp(p, x = v, ...)

More than one evaluation point may be given. The result must be a polynomial in the remaining indeterminates or an element of R.

### **indets — Return indeterminates**

indets(p)

### **lcoeff — Return leading coefficient**

lcoeff(p)

### **lmonomial — Return leading monomial**

lmonomial(p)

### **lterm — Return leading term**

lterm(p)

### **mainvar — Return main variable**

mainvar(p)

### **mapcoeffs — Map coefficients**

mapcoeffs(p, f, <a, ...>)

### **multcoeffs — Multiply coefficients**

multcoeffs(p, c)

### **nterms — Return number of terms**

nterms(p)

**nthcoeff** — Return n-th coefficient

`nthcoeff(p, n)`

**nthmonomial** — Return n-th monomial

`nthmonomial(p, n)`

**nthterm** — Return n-th term

`nthterm(p, n)`

**tcoeff** — Return trailing coefficient

`tcoeff(p)`

**unitNormal** — Return unit normal

`unitNormal(p)`

An implementation is provided if R has the axiom `Ax::canonicalUnitNormal`: In this case `p` is multiplied by an unit of R such that the leading coefficient has unit normal representation in R.

**unitNormalRep** — Return unit normal representation

`unitNormalRep(p)`

An implementation is provided if R has the axiom `Ax::canonicalUnitNormal`.

## Mathematical Methods

**content** — Return content

`content(p)`

**isUnit** — Test if element is a unit

`isUnit(p)`

**primpart — Return primitive part**

primpart(p)

**poly2list — Convert into a list**

poly2list(p)

**solve — Solve polynomial equation**

solve(p, x, <opt, ...>)

solve(p, x = T, <opt, ...>)

solve(p)

Solves the polynomial equation  $p = 0$  with respect to  $x$  over the domain  $T$ . See the function `solve` for details about the optional arguments `opt, ...`.

The polynomial  $p$  must be univariate. Solves the polynomial equation  $p = 0$  with respect to the indeterminate of  $p$  over the domain  $R$ .

# Cat::PrincipalIdealDomain

Category of principal ideal domains

## Description

Cat::PrincipalIdealDomain represents the category of principal ideal domains.

A Cat::PrincipalIdealDomain is an integral domain with gcd where each ideal is principal. Note that the method "idealGenerator" has to find generators for finitely generated ideals only.

## Categories

Cat::GcdDomain

## Methods

### Basic Methods

**idealGenerator** — Return generator of ideal

idealGenerator(x, ...)

## Cat::QuotientField

Category of quotient fields

### Syntax

Cat::QuotientField(R)

### Description

Cat::QuotientField(R) represents the category of quotient fields over R.

A Cat::QuotientField is the field of fractions over the integral domain R.

### Categories

Cat::Field, Cat::Algebra(R)

If R has Cat::OrderedSet, then Cat::OrderedSet.

### Parameters

R

A domain which must be from the category Cat::IntegralDomain.

### Entries

"characteristic"	The characteristic of this domain, which is the same as that of R.
------------------	--

## Methods

### Basic Methods

**denom** — Return denominator

denom(x)

**numer** — Return numerator

numer(x)

### Mathematical Methods

**equal** — Test for equality

equal(x, y)

**iszero** — Test for zero

iszero(x)

**\_less** — Test if element is less

\_less(x, y)

**retract** — Return retracted element

retract(x)

The default implementation uses the method "`_divide`" to divide numerator and denominator.

## Cat::RightModule

Category of right R-modules

### Syntax

`Cat::RightModule(R)`

### Description

`Cat::RightModule(R)` represents the category of right R-modules.

A `Cat::RightModule` is an Abelian group together with a ring  $R$  and a right multiplication `* (_mult)`.

The right multiplication is an operation taking an element of ring  $R$  and a module element and returning a module element.

Given ring elements  $a, b$  and module elements  $x, y$  the following 3 distributive laws must hold:

- 1**  $x(ab) = (xa)b,$
- 2**  $x(a + b) = xa + xb,$
- 3**  $(x + y)a = xa + ya.$

Beware: The operation of a non-Abelian semi-group is also written as `* (_mult)`. The method `"_mult"` must handle the situation if a right module is also a non-Abelian semi-group. In such a case it must both implement the group operation and the right multiplication by elements of the ring.

### Categories

`Cat::AbelianGroup`



## Parameters

**R**

A domain which must be from the category `Cat::Ring`.

## Methods

### Basic Methods

**`_mult`** — Right multiplication by a ring element

`_mult(x, r)`

## Cat::Ring

Category of rings

### Description

`Cat::Ring` represents the category of rings.

A `Cat::Ring` is a ring with a unit `dom::one`, i.e., an Abelian group according to the operation `+_plus` and a non-Abelian monoid according to the operation `*_mult` where in addition the two distributive laws  $a(b + c) = ab + ac$  and  $(a + b)c = ac + bc$  hold.

A `Cat::Ring` is also a left module over itself. The left multiplication of the module is also written as `*_mult`.

Note that a ring without unit is a `Cat::Rng`.

### Categories

`Cat::Rng`, `Cat::Monoid`, `Cat::LeftModule(dom)`

### Entries

"characteristic"	Must hold the characteristic of this ring.
------------------	--

## Cat::Rng

Category of rings without unit

### Description

`Cat::Rng` represents the category of rings without unit.

A `Cat::Rng` is a ring without a unit, i.e. an Abelian group according to the operation `+` (`_plus`) and a non-Abelian semi-group according to the operation `*` (`_mult`) where in addition the two distributive laws  $a(b + c) = ab + ac$  and  $(a + b)c = ac + bc$  hold.

Use the axiom `Ax::noZeroDivisors` to state that there are no zero divisors according to `*`, i.e. that the product of non-zero elements never is zero.

### Categories

`Cat::AbelianGroup`, `Cat::SemiGroup`

## Cat::SemiGroup

Category of semi-groups

### Description

Cat::SemiGroup represents the category of semi-groups.

A Cat::SemiGroup represents the category of non-Abelian semi-groups, where the group operation is written as multiplication. Hence a Cat::SemiGroup is a set with an associative operation \* (\_mult).

Note that Abelian semi-groups with operation + have category Cat::AbelianSemiGroup.

### Categories

Cat::BaseCategory

### Methods

#### Basic Methods

**\_mult — Return product**

\_mult(x, ...)

#### Mathematical Methods

**\_power — Return integer power**

\_power(x, n)

# Cat::Set

Category of sets of complex numbers

## Description

`Cat::Set` represents the category of subsets of the complex numbers.

Sets of this category allow set-theoretic operations as well as pointwise arithmetical operations.

The main feature of `Cat::Set` is a particular overloading mechanism. It provides n-ary operators that can handle operands from different domains of category `Cat::Set`, as well as mixed input where some operands are of types not belonging to `Cat::Set`. *Hence, in the methods of `Cat::Set`, operands of arbitrary type are allowed.*

There are three kinds of operators: n-ary (associative and commutative), binary (not assumed to be commutative), and unary (mapping a function). `Cat::Set` provides generic methods for generating these kinds of operators, and uses them to define default methods overloading the common set-theoretic and arithmetical functions.

By default, any operation of sets is defined, but returns unevaluated since the arithmetical or set-theoretic expression cannot be simplified. Each domain of type `Cat::Set` must provide particular slots and tables in order to achieve simplifications in certain special cases.

Arithmetical operations are defined pointwise. It is not an error if some operation is not defined for all elements of a set.

`Cat::Set` is mainly used by domains of sets returned by `solve`.

## Categories

`Cat::BaseCategory`

## Methods

### Mathematical Methods

**commassop** — Return an n-ary commutative and associative operator for sets

`commassop(operatorname)`

The returned procedure first sorts its operands (which it may do because of commutativity). Those operands not belonging to a domain of category `Cat : Set` are handled by the usual overloading mechanism, i.e. by the slot `operatorname` of one of their domains. Out of the others, several operands belonging to the same domain are handled by the slot `"homog".operatorname` of that domain. Finally, the returned method tries to combine each possible pair of operands. If they are from the same domain, `"bin".operatorname` is called for them. The following is done if the operands are from different domains: let `T1` and `T2` be their types; then their `"inhomog".operatorname` slots are used. If such a slot exists in the domain `T1`, it must contain a table indexed by possible types `T2`, and the entry at that index must be a procedure that carries out the operation for exactly two arguments, the first being a `T1`, the second being a `T2`. Conversely, if such a slot exists in the domain `T2`, it must contain a table indexed by possible types `T1`, and the entry at that index must be a procedure that carries out the operation for exactly two arguments, the first being a `T2`, the second being a `T1`.

The slot `"homog".operatorname`, or a table entry in the slot `"inhomog".operatorname`, may return `FAIL` in order to indicate that it could not simplify its input; if they are missing, this indicates that a simplification is generally not possible for input of this type. In these cases, the returned procedure proceeds by trying to combine another two of the given arguments.

A slot `"bin".operatorname` usually won't exist, except for the case that there is no `"homog".operatorname`; usually the latter can also take care for the case of exactly two operands.

The whole process is repeated over and over until no new simplifications occur or only one operand is left. If no more simplifications occur, an unevaluated call to the operator is returned, the arguments being all remaining operands that could not be combined further.

**binop — Return a binary operator for sets**

```
binop(operatorname)
```

The returned procedure uses the slot `"bin".operatorname` of its first argument if both arguments are of the same type. Otherwise it uses the slot `"inhomogleft".operatorname` of its first argument; if that fails, it uses the slot `"inhomogright".operatorname` of its second argument; each of these slots, if it exists, must contain tables, indexed by the type of the other argument, such that `slot(T1, "inhomogleft".operatorname)[T2]` and `slot(T2, "inhomogright".operatorname)[T1]` carry out the operation for objects of type T1 and T2, in this order.

No commutativity of the operation is assumed.

If the slots or table entries do not exist or return FAIL, an unevaluated call to the operator is returned.

**homogassop — Return an n-ary operator for sets belonging to the same domain**

```
homogassop(operatorname)
```

**\_union — Union of sets**

```
_union(S1, ...)
```

**\_intersect — Intersection of sets**

```
_intersect(S1, ...)
```

**\_plus — Set of sums of set elements**

```
_plus(S1, ...)
```

The sum of sets is computed by the commutative-associative operator generated by `"commassop"`, using the slots `"homog_plus"` and `"inhomog_plus"` of the domains of its operands.

**\_mult — Set of product of set elements**

```
_mult(S1, ...)
```

The product of sets is computed by the commutative-associative operator generated by "commassop", using the slots "homog\_mult" and "inhomog\_mult" of the domains of its operands.

### **\_minus — Set of subtractions**

`_minus(S1, S2)`

### **\_power — Pointwise power**

`_power(S1, S2)`

The power of sets is computed by the binary operator generated by "binop", using the slots "homog\_power", "inhomogleft\_power", and "inhomogright\_power" of its operands.

### **map — Map an operation to a set**

`map(S, f)`

By overloading this method in a particular domain, the behavior of sets changes whenever a special function is applied to them.



# Cat::SkewField

Category of skew fields

## Description

Cat::SkewField represents the category of skew fields (division rings).

A Cat::SkewField represents a ring with unit where each non-zero element is invertible. This structure is also called division ring in the literature.

## Categories

Cat::Ring

## Cat::SquareMatrix

Category of square matrices

### Syntax

`Cat::SquareMatrix(R)`

### Description

`Cat::SquareMatrix(R)` represents the category of square matrices over the rng  $R$ .

A `Cat::SquareMatrix(R)` represents the rng (ring without unit) of square matrices over the coefficient domain  $R$ .

### Categories

`Cat::Rng`, `Cat::Matrix(R)`

If  $R$  has `Cat::Ring`, then `Cat::Ring`.

### Parameters

$R$

A domain which must be from the category `Cat::Rng`.

### Entries

"characteristic"	Defined if $R$ is a ring: In this case the characteristic of the matrix domain is the same as that of $R$ .
------------------	---

# Cat::UnivariatePolynomial

Category of univariate polynomials

## Syntax

Cat::UnivariatePolynomial(R)

## Description

Cat::UnivariatePolynomial(R) represents the category of univariate polynomials over R.

A Cat::UnivariatePolynomial(R) is a univariate polynomial over the commutative ring R.

## Categories

Cat::Polynomial(R), Cat::DifferentialRing

If R has Cat::Field, then Cat::EuclideanDomain.

## Parameters

**R**

A domain which must be from the category Cat::CommutativeRing.

## Methods

### Basic Methods

#### **pdivide — Pseudo-divide polynomials**

pdivide(p, q)

Must return a sequence (b, s, r) of a ring element b and polynomials s and r such that  $multcoeffs(p, b) = s q + r$  holds with  $b = lcoeff(q)^{degree(p) - degree(q) + 1}$ .

#### **pquo — Return pseudo-quotient**

pquo(p, q)

#### **prem — Return pseudo-remainder**

prem(p, q)

# Cat::VectorSpace

Category of vector spaces

## Syntax

```
Cat::VectorSpace(F)
```

## Description

`Cat::VectorSpace(F)` represents the category of vector spaces over the field `F`.

A vector space is an Abelian group with an operation `+` (`_plus`).

The scalar product has to be implemented via the method `"_mult"`. Other kinds of multiplication are not defined.

## Categories

```
Cat::Module(F)
```

## Parameters

**F**

A domain which must be from the category `Cat::Field`.

## Methods

### Basic Methods

**`_mult`** — Return scalar product

`_mult(c, x)`

`_mult(x, c)`

Must return the scalar product of `x` and `c`.

# combinat - Combinatorics

---

## combinat::bell

Bell numbers

### Syntax

```
combinat::bell(n)
```

```
combinat::bell(expression)
```

### Description

`combinat::bell(n)` computes the  $n$ -th Bell number.

The  $n$ -th Bell number is defined by the exponential generating function:

$$e^{e^x - 1} = \sum_{n=0}^{\infty} \frac{\text{bell}(n)}{n!} x^n$$

Often another definition is used. The  $n$ -th Bell number is the number of different ways of partitioning the set  $\{1, 2, \dots, n\}$  into disjoint nonempty subsets, and  $\text{bell}(0)$  is defined to be 1.

Bell numbers are computed using the formula:

- $\text{bell}(0) = 1$

$$\text{bell}(n+1) = \sum_{i=0}^n \binom{n}{i} \text{bell}(i) \text{ for } n > 0$$

### Examples

#### Example 1

The third Bell number is 5:



```
combinat::bell(3)
```

```
5
```

This means that you can partition the set  $\{1, 2, 3\}$  into disjoint subsets in 5 different ways. These are  $\{\{1, 2, 3\}\}$ ,  $\{\{1\}, \{2, 3\}\}$ ,  $\{\{2\}, \{1, 3\}\}$ ,  $\{\{3\}, \{1, 2\}\}$ , and  $\{\{1\}, \{2\}, \{3\}\}$ . Or, that you can write  $105 = 3 \cdot 5 \cdot 7$  as 5 different products. These are  $105 = 3 \cdot 35 = 5 \cdot 21 = 7 \cdot 15 = 3 \cdot 5 \cdot 7$ .

## Example 2

If one uses a wrong argument, an error message is returned.

```
combinat::bell(3.4)
```

```
Error: Nonnegative integer expected. [combinat::bell]
```

## Example 3

It can be useful to return the unevaluated function call.

```
a := combinat::bell(x);  
x := 4;  
a ;  
delete(a);
```

```
combinat::bell(x)
```

```
4
```

```
15
```

## Parameters

**n**

Nonnegative integer

**expression**

An expression of type `Type::Arithmetical` which must be a nonnegative integer if it is a number.

## Return Values

Positive integer value if `n` was a nonnegative integer. Otherwise `combinat::bell` returns the unevaluated function call.

# combinat::cartesianProduct

Cartesian product

## Syntax

```
combinat::cartesianProduct(S1, ...)
```

## Description

`combinat::cartesianProduct(S1, ...)` returns the cartesian product of the sets or lists  $S_1, \dots$  as a list of lists.

The cartesian product of  $S_1$  through  $S_n$  consists of all lists of length  $n$  whose  $i$ -th entry is an operand of the set or list  $S_i$ , for  $1 \leq i \leq n$ .

Any integer  $k$  among the arguments is identified with the set of the first  $k$  positive integers.

The ordering of the output is unspecified.

## Examples

### Example 1

The following calls are equivalent:

```
combinat::cartesianProduct({1, 2}, {a, b}),  
combinat::cartesianProduct(2, [b, a])
```

```
[[1, a], [2, a], [1, b], [2, b]], [[1, b], [2, b], [1, a], [2, a]]
```

## **Parameters**

**S1**

Set, list, or nonnegative integer

## **Return Values**

List of lists, each of them having as many operands as there were arguments passed to `combinat::cartesianProduct`.

# combinat::catalan

Catalan numbers

## Syntax

```
combinat::catalan(n)
```

## Description

`combinat::catalan(n)` returns the  $n$ -th Catalan number.

The Catalan numbers are ubiquitous in combinatorics. For example, `combinat::catalan(n)` counts the Dyck words of size  $n$ , the ordered trees with  $n$  nodes, the binary trees with  $n+1$  nodes, the complete binary trees with  $2n+1$  nodes, the standard tableaux with two rows of size  $n$ , the triangulations of a regular  $n+2$ -gon, or the non-crossing partitions of  $\{1, 2, \dots, n\}$ .

`combinat::catalan(n)` is calculated using the formula

$$\text{catalan}(n) = \frac{1}{n+1} \binom{2n}{n}$$

## Examples

### Example 1

We compute the first Catalan numbers:

```
combinat::catalan(n) $ n = 0..6
```

```
1, 1, 2, 5, 14, 42, 132
```

## Example 2

If one uses a wrong argument, an error message is returned

```
combinat::catalan(-1)
```

```
Error: Invalid object '-1'. Type of argument number 1 must be 'Type::NonNegInt'.  
Evaluating: combinat::catalan
```

## Parameters

**n**

Nonnegative integer

## Return Values

Positive integer.

# combinat::choose

Subsets of a given size

## Syntax

```
combinat::choose(S, k)
```

## Description

`combinat::choose(S, k)` returns all subsets of  $S$  that have exactly  $k$  elements.

If  $S$  is an integer, it represents the set of the first  $S$  positive integers.

## Examples

### Example 1

There are three subsets of a three-element set that have exactly two elements:

```
combinat::choose({a, b, c}, 2)
```

```
{a, b}, {a, c}, {b, c}
```

## Parameters

**S**

Set or nonnegative integer

**k**

Nonnegative integer

## **Return Values**

Sequence of sets.



# combinat::compositions

Compositions of an integer

## Syntax

```
combinat::compositions(n, <MinPart = k>, <MaxPart = l>, <Length = m>)
```

## Description

`combinat::compositions(n)` returns all compositions of the nonnegative integer  $n$ .

A *composition* of a nonnegative integer  $n$  is a list of positive integers with total sum  $n$ .

## Examples

### Example 1

We output all compositions of the integer 4:

```
combinat::compositions(4)
```

```
[[4], [3, 1], [2, 2], [2, 1, 1], [1, 3], [1, 2, 1], [1, 1, 2], [1, 1, 1, 1]]
```

### Example 2

It is possible to output only the compositions of a certain length:

```
combinat::compositions(4, Length=2)
```

```
[[3, 1], [2, 2], [1, 3]]
```

### Example 3

The options `MinPart` and `MaxPart` can be used to set constraints on the sizes of all parts. Using `MaxPart`, you can select compositions having only small entries. This is the list of the compositions of 4 with all parts at most 2:

```
combinat::compositions(4, MaxPart=2)

[[2, 2], [2, 1, 1], [1, 2, 1], [1, 1, 2], [1, 1, 1, 1]]
```

`MinPart` is complementary to `MaxPart` and selects compositions having only large parts (it takes a non-negative value). This is the list of the compositions of 4 with all parts at least 2:

```
combinat::compositions(4, MinPart=2)

[[4], [2, 2]]
```

By default, the parts of a composition have to be positive. This can be changed using the option `MinPart`. In the following example, the options `Length` and `MinPart` are combined together to obtain the list of the compositions of 4 with 3 nonnegative parts:

```
combinat::compositions(4, Length=3, MinPart=0)

[[4, 0, 0], [3, 1, 0], [3, 0, 1], [2, 2, 0], [2, 1, 1], [2, 0, 2], [1, 3, 0], [1, 2, 1], [1, 1, 2],
 [1, 0, 3], [0, 4, 0], [0, 3, 1], [0, 2, 2], [0, 1, 3], [0, 0, 4]]
```

If no length is given, `MinPart=0` is not allowed.

## Parameters

**n**

Nonnegative integer

## Options

### **MinPart**

Option, specified as `MinPart = k`

Return only compositions consisting of integers greater or equal than  $k$ . The option `MinPart = 0` is only allowed if also the option `Length` is given. Default is 1.

### **MaxPart**

Option, specified as `MaxPart = l`

Return only compositions consisting of integers less or equal than  $l$ .

### **Length**

Option, specified as `Length = m`

Return only compositions consisting of exactly  $m$  integers.

## **combinat::modStirling**

Modified Stirling numbers

### **Syntax**

```
combinat::modStirling(q, n, k)
```

### **Description**

`combinat::modStirling` computes the modified Stirling numbers.

`combinat::modStirling(q, n, k)` takes the elementary symmetric polynomial in  $n$  variables of degree  $k$  and evaluates it for the values  $q + 1, \dots, q + n$ . Note that  $k$  must not be greater than  $n$ .

### **Examples**

#### **Example 1**

```
combinat::modStirling(2,4,2)
```

119

### **Parameters**

**q**

The argument: an integer

**n**

The number of variables: a nonnegative integer

**k**

The degree: a nonnegative integer

## **Return Values**

Positive integer.

## combinat::partitions

Partitions of an integer

### Syntax

```
combinat::partitions(n)
```

### Description

`cominat::partitions(n)` returns the number of partitions of the integer  $n$ .

A *partition* of a nonnegative integer  $n$  is a non-increasing list of positive integers with total sum  $n$ .

### Examples

#### Example 1

There are 5 partitions of 4:

```
combinat::partitions(4)
```

5

### Parameters

**n**

Nonnegative integer

## Algorithms

Counting is done efficiently with Euler's pentagonal formula for small values of  $n$  and Hardy-Ramanujan-Rademacher's formula otherwise.

## combinat::permute

Permutations of a list

### Syntax

```
combinat::permute(l, <Duplicate>)
```

```
combinat::permute(n, <Duplicate>)
```

### Description

For a list  $l$ , the call `combinat::permute(l)` returns all permutations of  $l$ .

For an integer  $n$ , the call `combinat::permute(n)` returns all permutations of the list  $[1, \dots, n]$ .

A permutation of a list is a list that contains the same elements, and each of them the same number of times, as the original list.

Equivalently, a permutation of a list  $l$  of  $n$  elements is any  $f(l)$  where  $f$  is an element of the symmetric group `Dom::SymmetricGroup(n)`. Different  $f$  may produce the same  $f(l)$ ; with the option `Duplicate`, every permutation is listed as many times as it occurs in that way; without that option, every permutation is listed only once.

### Examples

#### Example 1

There are six permutations of three letters:

```
combinat::permute([a, b, c])
```

```
[[b, c, a], [c, b, a], [a, c, b], [c, a, b], [a, b, c], [b, a, c]]
```



To permute the first three integers, the following syntax is also possible:

```
combinat::permute(3)
```

```
[[2, 3, 1], [3, 2, 1], [1, 3, 2], [3, 1, 2], [1, 2, 3], [2, 1, 3]]
```

If some list entry occurs several times, the number of permutations decreases:

```
combinat::permute([a, a, b])
```

```
[[a, b, a], [b, a, a], [a, a, b]]
```

However, the same permutation is listed as often as it can be obtained by applying different elements of the symmetric group  $S_3$  if the option `Duplicate` is given.

```
combinat::permute([a, a, b], Duplicate)
```

```
[[a, b, a], [b, a, a], [a, b, a], [b, a, a], [a, a, b], [a, a, b]]
```

We could have achieved the same by permuting three different symbols and then setting two of them equal:

```
subs(combinat::permute([a, b, c]), c=a)
```

```
[[b, a, a], [a, b, a], [a, a, b], [a, a, b], [a, b, a], [b, a, a]]
```

## Parameters

**l**

List

**n**

Positive integer

## **Options**

### **Duplicate**

List every permutation as often as it can be produced in different ways by applying some bijective mapping (element of the symmetric group) to the original list.

# combinat::powerset

Subsets of a set

## Syntax

```
combinat::powerset(S)
```

## Description

If  $S$  is a set, `combinat::powerset(S)` returns the set of all subsets of  $S$ . If  $l$  is a list, `combinat::powerset(l)` returns the set of all sublists of  $l$ .

The powerset of a list  $l$  is the set of all lists that can be obtained by deleting some elements of  $l$  and leaving the others in order.

`combinat::powerset` has been overloaded for multisets of type `Dom::Multiset`. The powerset of a multiset  $S$  consists of all multisets that contain only elements occurring also in  $S$ , each of them at most as many times as it occurs in  $S$ .

## Examples

### Example 1

Given a finite set, `combinat::powerset` returns the powerset (set of all subsets) of the input:

```
combinat::powerset({a, b, c})
```

```
{∅, {c}, {a}, {b}, {b, c}, {a, b}, {a, c}, {a, b, c}}
```

The same works for multisets:

```
combinat::powerset(Dom::Multiset(a, a, b))
```

$$\{\emptyset, \{[a, 1]\}, \{[a, 2]\}, \{[b, 1]\}, \{[a, 1], [b, 1]\}, \{[a, 2], [b, 1]\}\}$$

## Example 2

The powerset of a list  $\mathfrak{l}$  of pairwise different elements is the same as the powerset of the set of these elements, except that it consists of lists in which the order of elements is the same as in  $\mathfrak{l}$ :

```
combinat::powerset([c, a, b])
```

$$\{\[], [a], [b], [c], [a, b], [c, a], [c, b], [c, a, b]\}$$

In general, the powerset of a list  $\mathfrak{l}$  is the same as the powerset of the multiset of its elements, except that it consists of lists in which the original order is preserved:

```
combinat::powerset([a, b, a])
```

$$\{\[], [a], [b], [a, a], [a, b], [b, a], [a, b, a]\}$$

## Parameters

**s**

Set

**l**

List

# combinat::stirling1

Stirling numbers of the first kind

## Syntax

```
combinat::stirling1(n, k)
```

## Description

`combinat::stirling1(n, k)` computes the Stirling numbers of the first kind.

Let  $S(n, k)$  be the number of permutations of  $n$  symbols that have exactly  $k$  cycles. Then `combinat::stirling1(n, k)` computes  $(-1)^{(n+k)} S(n, k)$ .

Let  $S_1(n, k)$  be the Stirling number of the first kind, then we have:

$$\sum_{k=0}^n S_1(n, k) x^k = x(x-1)\dots(x-n+1)$$

## Examples

### Example 1

Let us have a look what's the result of  $x(x-1)(x-2)(x-3)(x-4)(x-5)$  written as a sum.

```
expand(x*(x-1)*(x-2)*(x-3)*(x-4)*(x-5))
```

$$x^6 - 15x^5 + 85x^4 - 225x^3 + 274x^2 - 120x$$

Now let us “prove” the formula mentioned in the “Details” section by calculating the proper Stirling numbers:

```
combinat::stirling1(6,1);  
combinat::stirling1(6,2);  
combinat::stirling1(6,3);  
combinat::stirling1(6,4);  
combinat::stirling1(6,5);  
combinat::stirling1(6,6)
```

- 120

274

- 225

85

- 15

1

## Example 2

```
combinat::stirling1(3,-1)
```

Error: Nonnegative integers expected. [combinat::stirling1]

## Parameters

**n, k**

Nonnegative integers

## **Return Values**

Integer.

## **References**

J.J. Rotman, An Introduction to the Theory of Groups, 3rd Edition, Wm. C. Brown Publishers, Dubuque, 1988

## combinat::stirling2

Stirling numbers of the second kind

### Syntax

```
combinat::stirling2(n, k)
```

### Description

`combinat::stirling2(n, k)` computes the number of ways of partitioning a set of  $n$  elements into  $k$  non-empty subsets.

`combinat::stirling2(n, k)` is calculated using the formula

$$\text{stirling2}(n, k) = \frac{1}{k!} \left( \sum_{j=0}^k (-1)^{k-j} \binom{k}{j} j^n \right)$$

### Examples

#### Example 1

One can partition the set  $\{1, 2, 3\}$  into  $\{1, 2, 3\} = \{1, 2\} \cup \{3\} = \{1, 3\} \cup \{2\} = \{2, 3\} \cup \{1\}$

```
combinat::stirling2(3,2)
```

3

#### Example 2

```
combinat::stirling2(3)
```



Error: Two arguments expected. [combinat::stirling2]

## Parameters

**n, k**

Nonnegative integers

## Return Values

Nonnegative integer.

## **combinat::subwords**

Subwords of a word

### **Syntax**

```
combinat::subwords(w)
```

### **Description**

The function `combinat::subwords(w)` returns a list of all subwords (sublists) of the list `w`.

A subword of a word `w` is a word obtained by deleting the letters at some of the positions in `w`. A subword is generated as many times as it appears in the word.

To obtain each subword only once, `combinat::powerset` should be used.

### **Examples**

#### **Example 1**

There are 8 subwords of the word `[a, b, c]`:

```
combinat::subwords([a, b, c])
```

```
[[], [a], [b], [a, b], [c], [a, c], [b, c], [a, b, c]]
```

## Parameters

**w**

List



# **daetools - Analyze and Reduce Differential Algebraic Equations (DAEs)**

---

## daetools::findDecoupledBlocks

Search for decoupled blocks in systems of equations

### Syntax

```
[eqsBlocks, varsBlocks] := daetools::findDecoupledBlocks(eqs, vars)
```

### Description

`[eqsBlocks, varsBlocks] := daetools::findDecoupledBlocks(eqs, vars)` identifies subsets (blocks) of equations that can be used to define subsets of variables. The number of variables `vars` must coincide with the number of equations `eqs`.

The  $i$ th block is the set of equations determining the variables in `vars[varsBlocks[i]]`. The variables in `vars[varsBlocks[1], ..., varsBlocks[i-1]]` are determined recursively by the previous blocks of equations. After you solve the first block of equations for the first block of variables, the second block of equations, given by `eqs[eqsBlocks[2]]`, defines a decoupled subset of equations containing only the subset of variables given by the second block of variables `vars[varsBlock[2]]`, plus the variables from the first block (these variables are known at this time). Thus, if a nontrivial block decomposition is possible, you can split the solution process for a large system of equations involving many variables into several steps, where each step involves a smaller subsystem.

The number of blocks is `nops(eqsBlocks)`. It coincides with `nops(varsBlocks)`. If `nops(eqsBlocks) = nops(varsBlocks) = 1`, then a nontrivial block decomposition of the equations is not possible.

The implemented algorithm requires that for each variable in `vars` there must be at least one matching equation in `eqs` involving this variable. The same equation cannot also be matched to another variable. If the system does not satisfy this condition, then `daetools::findDecoupledBlocks` throws an error. In particular, `daetools::findDecoupledBlocks` requires that `nops(eqs) = nops(vars)`.

## Examples

### Example 1

Compute a block lower triangular decomposition of a symbolic system of differential algebraic equations (DAEs).

Create the following system of four differential algebraic equations. Here, the expressions  $x_1(t)$ ,  $x_2(t)$ ,  $x_3(t)$ , and  $x_4(t)$  represent the state variables of the system. The system also contains symbolic parameters  $c_1$ ,  $c_2$ ,  $c_3$ ,  $c_4$ , and the expressions  $f(t, x, y)$  and  $g(t, x, y)$ .

```
eqs := [c1*diff(x1(t),t) + c2*diff(x3(t),t) = c3*f(t,x1(t),x3(t)),
        c2*diff(x1(t),t) + c1*diff(x3(t),t) = c4*g(t,x3(t),x4(t)),
        x1(t) = g(t,x1(t),x3(t)),
        x2(t) = f(t,x3(t),x4(t))]:
vars:= [x1(t), x2(t), x3(t), x4(t)]:
```

Use `daetools::findDecoupledBlocks` to find the block structure of the system.

```
[eqsBlocks, varsBlocks] := daetools::findDecoupledBlocks(eqs, vars)
```

```
[[[1, 3], [2], [4]], [[1, 3], [4], [2]]]
```

The first block contains two equations in two variables.

```
eqs[eqsBlocks[1]]
```

$$\left[ c_1 \frac{\partial}{\partial t} x_1(t) + c_2 \frac{\partial}{\partial t} x_3(t) = c_3 f(t, x_1(t), x_3(t)), x_1(t) = g(t, x_1(t), x_3(t)) \right]$$

```
vars[varsBlocks[1]]
```

```
[x1(t), x3(t)]
```

After you solve this block for the state variables  $x_1(t)$ ,  $x_3(t)$ , you can solve the next block of equations. This block consists of one equation.

```
eqs[eqsBlocks[2]]
```

$$\left[ c2 \frac{\partial}{\partial t} x1(t) + c1 \frac{\partial}{\partial t} x3(t) = c4 g(t, x3(t), x4(t)) \right]$$

This block involves one variable.

```
vars[varsBlocks[2]]
```

```
[x4(t)]
```

After you solve the equation from block 2 for the state variable  $x4(t)$ , the remaining block of equations `eqs[eqsBlocks[3]]` defines the remaining variable `vars[varsBlocks[3]]`.

```
eqs[eqsBlocks[3]];
vars[varsBlocks[3]]
```

```
[x2(t) = f(t, x3(t), x4(t))]
```

```
[x2(t)]
```

Find the permutations that convert the system to a block lower triangular form.

```
eqsPerm := [op(eqsBlocks[i]) $ i = 1..nops(eqsBlocks)];
varsPerm := [op(varsBlocks[i]) $ i = 1..nops(varsBlocks)]
```

```
[1, 3, 2, 4]
```

```
[1, 3, 4, 2]
```

Convert the system to a block lower triangular system of equations.

```
eqs := eqs[eqsPerm];
vars := vars[varsPerm]
```



$$\left[ \begin{array}{l} c1 \frac{\partial}{\partial t} x1(t) + c2 \frac{\partial}{\partial t} x3(t) = c3 f(t, x1(t), x3(t)), \\ x1(t) = g(t, x1(t), x3(t)), c2 \frac{\partial}{\partial t} x1(t) + c1 \frac{\partial}{\partial t} x3(t) = c4 g(t, x3(t), x4(t)), \\ x2(t) = f(t, x3(t), x4(t)) \end{array} \right]$$

$$[x1(t), x3(t), x4(t), x2(t)]$$

Find the incidence matrix of the resulting system. The incidence matrix shows that the system of permuted equations has three diagonal blocks of size 2-by-2, 1-by-1, and 1-by-1.

`daetools::incidenceMatrix(eqs, vars)`

$$\begin{pmatrix} 1 & 1 & 0 & 0 \\ 1 & 1 & 0 & 0 \\ 1 & 1 & 1 & 0 \\ 0 & 1 & 1 & 1 \end{pmatrix}$$

## Parameters

### **eqs**

A list or a vector of equations or expressions in the state variables `vars` and their derivatives. Expressions represent equations with 0 right side.

### **vars**

A list or a vector of identifiers or expressions, such as `[x1(t), x2(t)]`.

## Return Values

A nested list of integers representing permutations required to convert the original system `eqs, vars` to a block lower triangular form.

## See Also

### MuPAD Functions

daetools::incidenceMatrix | daetools::isLowIndexDAE |  
daetools::massMatrixForm | daetools::reduceDAEIndex |  
daetools::reduceDAEToODE | daetools::reduceDifferentialOrder |  
daetools::reduceRedundancies

**Introduced in R2014b**

# daetools::incidenceMatrix

Find incidence matrix of system of equations

## Syntax

```
A := daetools::incidenceMatrix(eqs,vars)
```

## Description

`A := daetools::incidenceMatrix(eqs,vars)` for  $m$  equations `eqs` and  $n$  variables `vars` returns an  $m$ -by- $n$  matrix  $A$ , where  $A[i,j] = 1$  if `eqs[i]` contains `vars[j]` or any derivative of `vars[j]`. All other elements of  $A$  are 0s.

## Examples

### Example 1

Find the incidence matrix of a system of five equations in five variables.

Create the following vector `eqs` containing five symbolic differential equations.

```
eqs := [diff(y1(t),t) = y2(t),  
        diff(y2(t),t) = c1*y1(t) + c3*y3(t),  
        diff(y3(t),t) = y2(t) + y4(t),  
        diff(y4(t),t) = y3(t) + y5(t),  
        diff(y5(t),t) = y4(t)]:
```

Create the vector of variables. Here, `c1` and `c3` are symbolic parameters (not variables) of the system.

```
vars := [y1(t), y2(t), y3(t), y4(t), y5(t)]:
```

Find the incidence matrix  $A$  for the equations `eqs` with respect to the variables `vars`.

```
A := daetools::incidenceMatrix(eqs, vars)
```

$$\begin{pmatrix} 1 & 1 & 0 & 0 & 0 \\ 1 & 1 & 1 & 0 & 0 \\ 0 & 1 & 1 & 1 & 0 \\ 0 & 0 & 1 & 1 & 1 \\ 0 & 0 & 0 & 1 & 1 \end{pmatrix}$$

## Parameters

### **eqs**

A list or a vector of equations or expressions in the state variables `vars` and their derivatives. Expressions represent equations with 0 right side.

### **vars**

A list or a vector of identifiers or expressions, such as  $[x_1(t), x_2(t)]$ .

## Return Values

A matrix of 1s and 0s.

## See Also

### **MuPAD Functions**

`daetools::findDecoupledBlocks` | `daetools::isLowIndexDAE` |  
`daetools::massMatrixForm` | `daetools::reduceDAEIndex` |  
`daetools::reduceDAEToODE` | `daetools::reduceDifferentialOrder` |  
`daetools::reduceRedundancies`

### **Introduced in R2014b**

## daetools::isLowIndexDAE

Check if differential index of system equations is lower than 2

### Syntax

```
daetools::isLowIndexDAE(eqs, vars)
```

### Description

`daetools::isLowIndexDAE(eqs, vars)` checks if the system `eqs` of first-order semilinear differential algebraic equations (DAEs) has a low differential index. If the differential index of the system is 0 or 1, `isLowIndexDAE` returns TRUE. If the differential index of `eqs` is higher than 1, then `daetools::isLowIndexDAE` returns FALSE.

The number of equations `eqs` must match the number of variables `vars`.

### Examples

#### Example 1

Check if a system of first-order semilinear DAEs has a low (0 or 1) differential index.

Create the following system of two differential algebraic equations. Here,  $x(t)$  and  $y(t)$  are the state variables of the system.

```
eqs := [diff(x(t),t) = x(t) + y(t), x(t)^2 + y(t)^2 = 1];
vars := [x(t), y(t)]
```

$$\left[ \frac{\partial}{\partial t} x(t) = x(t) + y(t), x(t)^2 + y(t)^2 = 1 \right]$$

$[x(t), y(t)]$

Use `daetools::isLowIndexDAE` to check the differential order of the system. The differential order of this system is 1. For systems of index 0 and 1, `daetools::isLowIndexDAE` returns TRUE.

```
daetools::isLowIndexDAE(eqs, vars)
```

TRUE

## Example 2

Check if the following DAE system has a low or high differential index. If the index is higher than 1, then use `daetools::reduceDAEIndex` to reduce it.

Create the following system of two differential algebraic equations. Here,  $x(t)$ ,  $y(t)$ , and  $z(t)$  are the state variables of the system.

```
eqs := [diff(x(t),t) = x(t) + z(t),  
        diff(y(t),t) = f(t),  
        x(t) = y(t)];
```

```
vars := [x(t), y(t), z(t)]
```

$$\left[ \frac{\partial}{\partial t} x(t) = x(t) + z(t), \frac{\partial}{\partial t} y(t) = f(t), x(t) = y(t) \right]$$

$[x(t), y(t), z(t)]$

Use `daetools::isLowIndexDAE` to check the differential index of the system. For this system, `daetools::isLowIndexDAE` returns FALSE. This means that the differential index of the system is 2 or higher.

```
daetools::isLowIndexDAE(eqs, vars)
```

FALSE

Use `daetools::reduceDAEIndex` to rewrite the system so that the differential index is 1. The new system has one additional state variable,  $Dyt(t)$ .

```
[newEqs, newVars, transform, oldIndex] :=
  daetools::reduceDAEIndex(eqs, vars):
```

```
newEqs;
newVars
```

$$[x'(t) - x(t) - z(t), \text{Dyt}(t) - f(t), x(t) - y(t), x'(t) - \text{Dyt}(t)]$$

$$[x(t), y(t), z(t), \text{Dyt}(t)]$$

daetools::reduceDAEIndex also returns the differential index of the original system.

```
oldIndex
```

```
2
```

Check if the differential order of the new system is lower than 2.

```
daetools::isLowIndexDAE(newEqs, newVars)
```

```
TRUE
```

## Parameters

### eqs

A list or a vector of equations or expressions in the state variables vars and their derivatives. Expressions represent equations with 0 right side.

### vars

A list or a vector of identifiers or expressions, such as [x1(t), x2(t)].

## Return Values

TRUE or FALSE.

## See Also

### MuPAD Functions

daetools::findDecoupledBlocks | daetools::incidenceMatrix |  
daetools::massMatrixForm | daetools::reduceDAEIndex |  
daetools::reduceDAEToODE | daetools::reduceDifferentialOrder |  
daetools::reduceRedundancies

**Introduced in R2014b**



# daetools::massMatrixForm

Extract mass matrix and right side of semilinear system of differential algebraic equations

## Syntax

```
MF := daetools::massMatrixForm(eqs,vars)
```

## Description

MF := daetools::massMatrixForm(eqs,vars) returns a list containing the mass matrix M and the right side of equations F of a semilinear system of first-order differential algebraic equations (DAEs). Algebraic equations in eqs that do not contain any derivatives of the variables in vars correspond to empty rows of the mass matrix M.

The mass matrix M and the right side of equations F refer to the form  $M(t, x(t))x'(t) = F(t, x(t))$ .

## Examples

### Example 1

Convert a semilinear system of differential algebraic equations to mass matrix form.

Create the following system of differential algebraic equations. Here,  $x_1(t)$  and  $x_2(t)$  represent state variables of the system. The system also contains symbolic parameters  $r$  and  $m$ , and the parameter  $f(t, x_1(t), x_2(t))$ .

```
eqs :=
[m*x2(t)*diff(x1(t), t) + m*t*diff(x2(t), t) = f(t, x1(t), x2(t)),
 x1(t)^2 + x2(t)^2 = r^2];
```

```
vars := [x1(t), x2(t)];
```

$$\left[ m t \frac{\partial}{\partial t} x_2(t) + m x_2(t) \frac{\partial}{\partial t} x_1(t) = f(t, x_1(t), x_2(t)), x_1(t)^2 + x_2(t)^2 = r^2 \right]$$

$[x1(t), x2(t)]$ 

Find the mass matrix form of this system.

```
MF := daetools::massMatrixForm(eqs, vars):  
M := MF[1];  
F := MF[2]
```

$$\begin{pmatrix} m & x2(t) & m t \\ 0 & & 0 \end{pmatrix}$$

$$\begin{pmatrix} f(t, x1(t), x2(t)) \\ r^2 - x1(t)^2 - x2(t)^2 \end{pmatrix}$$

## Parameters

### eqs

A list or a vector of equations or expressions in the state variables `vars` and their derivatives. Expressions represent equations with 0 right side.

### vars

A list or a vector of identifiers or expressions, such as  $[x1(t), x2(t)]$ .

## Return Values

A list of two matrices. The first entry is the mass matrix. The number of rows is the number of equations in `eqs`, and the number of columns is the number of variables in `vars`. The second entry is an  $n$ -by-1 matrix of the right side of equations, where  $n$  is the number of equations `eqs`.

## See Also

### MuPAD Functions

daetools::findDecoupledBlocks | daetools::incidenceMatrix |  
daetools::isLowIndexDAE | daetools::reduceDAEIndex |  
daetools::reduceDAEToODE | daetools::reduceDifferentialOrder |  
daetools::reduceRedundancies

**Introduced in R2014b**

## daetools::reduceDAEIndex

Convert system of first-order differential algebraic equations to equivalent system of differential index 1

### Syntax

```
[newEqs,newVars,R,oldIndex] := daetools::reduceDAEIndex(eqs,vars)
```

### Description

[newEqs,newVars,R,oldIndex] := daetools::reduceDAEIndex(eqs,vars) converts a high-index system of first-order differential algebraic equations eqs to an equivalent system newEqs of differential index 1. The daetools::reduceDAEIndex function keeps the original equations and variables and introduces new variables and equations. It also returns the matrix R that expresses the new variables in newVars as derivatives of the original variables vars and the differential index oldIndex of the original system of DAEs, eqs.

After conversion, daetools::reduceDAEIndex checks the differential index of the new system by calling daetools::isLowIndexDAE. If the index of newEqs is 2 or higher, then daetools::reduceDAEIndex issues a warning.

The implementation of daetools::reduceDAEIndex uses the Pantelides algorithm. This algorithm reduces higher-index systems to lower-index systems by selectively adding differentiated forms of the original equations. The Pantelides algorithm can underestimate the differential index of a new system, and therefore, can fail to reduce the differential index to 1. In this case, daetools::reduceDAEIndex issues a warning and returns the value of oldIndex as UNKNOWN. The daetools::reduceDAEtoODE function uses more reliable, but slower Gaussian elimination. Note that daetools::reduceDAEtoODE requires the DAE system to be semilinear.

## Examples

### Example 1

Reduce the differential index of a system that contains two second-order differential algebraic equations. Because the equations are second-order equations, first use `reduceDifferentialOrder` to rewrite the system to a system of first-order DAEs.

Create the following system of two second-order DAEs. Here,  $x(t)$ ,  $y(t)$ , and  $F(t)$  are state variables of the system.

```
eqs := [diff(x(t), t, t) = -F(t)*x(t),
        diff(y(t), t, t) = -F(t)*y(t) - g,
        x(t)^2 + y(t)^2 = r^2];
vars := [x(t), y(t), F(t)]
```

$$\left[ \frac{\partial^2}{\partial t^2} x(t) = -F(t) x(t), \frac{\partial^2}{\partial t^2} y(t) = -g - F(t) y(t), x(t)^2 + y(t)^2 = r^2 \right]$$

$[x(t), y(t), F(t)]$

Rewrite this system so that all equations become first-order differential equations. The `daetools::reduceDifferentialOrder` function replaces the second-order DAE by two first-order expressions by introducing the new variables  $Dxt(t)$  and  $Dyt(t)$ .

```
[eqs, vars, R] := daetools::reduceDifferentialOrder(eqs, vars):
newEquations = eqs;
newVariables = vars;
relations = R
```

$$\text{newEquations} = [Dxt'(t) + F(t) x(t), Dyt'(t) + g + F(t) y(t), -r^2 + x(t)^2 + y(t)^2, \\ Dxt(t) - x'(t), Dyt(t) - y'(t)]$$

$\text{newVariables} = [x(t), y(t), F(t), Dxt(t), Dyt(t)]$

$$\text{relations} = [\text{Dxt}(t) = x'(t), \text{Dyt}(t) = y'(t)]$$

Use `daetools::reduceDAEIndex` to rewrite the system so that the differential index is 1.

```
[eqs,vars,R,originalIndex] := daetools::reduceDAEIndex(eqs,vars):
newEquations = eqs;
newVariables = vars;
relations = R;
originalDAEIndex = originalIndex
```

$$\begin{aligned} \text{newEquations} = & [\text{Dxtt}(t) + F(t) x(t), g + \text{Dytt}(t) + F(t) y(t), -r^2 + x(t)^2 + y(t)^2, \\ & \text{Dxt}(t) - \text{Dxtl}(t), \text{Dyt}(t) - \text{Dytl}(t), 2 \text{Dxtl}(t) x(t) + 2 \text{Dytl}(t) y(t), \\ & 2 y(t) \text{Dytl}'(t) + 2 \text{Dytl}(t)^2 + 2 \text{Dxtl}(t)^2 + 2 \text{Dxtlt}(t) x(t), \text{Dxtt}(t) - \text{Dxtlt}(t), \\ & \text{Dytt}(t) - \text{Dytl}'(t), \text{Dytl}(t) - y'(t)] \end{aligned}$$

$$\text{newVariables} = [x(t), y(t), F(t), \text{Dxt}(t), \text{Dyt}(t), \text{Dytt}(t), \text{Dxtt}(t), \text{Dxtl}(t), \text{Dytl}(t), \text{Dxtlt}(t)]$$

$$\begin{aligned} \text{relations} = & [\text{Dytt}(t) = \text{Dytl}'(t), \text{Dxtt}(t) = \text{Dxt}'(t), \text{Dxtl}(t) = x'(t), \text{Dytl}(t) = y'(t), \\ & \text{Dxtlt}(t) = x''(t)] \end{aligned}$$

$$\text{originalDAEIndex} = 3$$

Use `daetools::reduceRedundancies` to shorten the system.

```
[eqs,vars,solvedEquations,
constantVariables,
replacedVariables,
otherEquations] := daetools::reduceRedundancies(eqs,vars):
newEquations = eqs;
newVariables = vars;
```

```
newEquations = [Dxtt(t) + F(t) x(t), g + Dytt(t) + F(t) y(t), -r^2 + x(t)^2 + y(t)^2,
  2 Dxt(t) x(t) + 2 Dyt(t) y(t), 2 Dxt(t)^2 + 2 Dyt(t)^2 + 2 Dxtt(t) x(t) + 2 Dytt(t) y(t),
  Dytt(t) - Dyt'(t), Dyt(t) - y'(t)]
```

```
newVariables = [x(t), y(t), F(t), Dxt(t), Dyt(t), Dytt(t), Dxtt(t)]
```

## Parameters

### eqs

A list or a vector of equations or expressions in the state variables `vars` and their derivatives. Expressions represent equations with 0 right side.

### vars

A list or a vector of identifiers or expressions, such as `[x1(t), x2(t)]`.

## Return Values

A nested list containing the following four lists: a list of new equations, a list of new variables, a list of relations between new and original variables, and the differential index of the original DAE system. If `daetools::reduceDAEIndex` fails to reduce the differential index to 1, then it issues a warning and returns `UNKNOWN` instead of the differential index of the original DAE system.

## See Also

### MuPAD Functions

```
daetools::findDecoupledBlocks | daetools::incidenceMatrix |
daetools::isLowIndexDAE | daetools::massMatrixForm |
daetools::reduceDAEToODE | daetools::reduceDifferentialOrder |
daetools::reduceRedundancies
```

**Introduced in R2014b**



## daetools::reduceDAEToODE

Convert system of first-order quasilinear differential algebraic equations to equivalent system of differential index 0

### Syntax

```
[newEqs,constraintEqs,oldIndex] = daetools::reduceDAEToODE(eqs,vars)
```

### Description

[newEqs,constraintEqs,oldIndex] := daetools::reduceDAEToODE(eqs,vars) converts a high-index system of first-order semilinear algebraic equations eqs to an equivalent system of ordinary differential equations, newEqs. It also returns a vector of constraint equations and the differential index oldIndex of the original system of semilinear DAEs, eqs.

The differential index of the new system is 0, that is, the Jacobian of newEqs with respect to the derivatives of the variables in vars is invertible.

The implementation of daetools::reduceDAEToODE is based on Gaussian elimination. This algorithm is more reliable than the Pantelides algorithm used by daetools::reduceDAEIndex, but it can be much slower.

The number of equations eqs must coincide with the number of variables vars.

## Examples

### Example 1

Check if a DAE system has a low (0 or 1) or high (>1) differential index. If the index is higher than 1, then first try to reduce the index by using daetools::reduceDAEIndex and then by using daetools::reduceDAEToODE.

Create the following system of differential algebraic equations. Here,  $x_1(t)$ ,  $x_2(t)$ , and  $x_3(t)$  represent state variables of the system. The system also contains the expressions  $q_1(t)$ ,  $q_2(t)$ , and  $q_3(t)$  that do not represent state variables.

```
eqs := [diff(x2(t),t) = q1(t) - x1(t),
        diff(x3(t),t) = q2(t) - 2*x2(t) - t*(q1(t)-x1(t)),
        q3(t) - t*x2(t) - x3(t) = 0];
vars := [x1(t), x2(t), x3(t)]
```

$$\left[ \begin{array}{l} \frac{\partial}{\partial t} x_2(t) = q_1(t) - x_1(t), \quad \frac{\partial}{\partial t} x_3(t) = q_2(t) - 2 x_2(t) - t (q_1(t) - x_1(t)), \\ q_3(t) - x_3(t) - t x_2(t) = 0 \end{array} \right]$$

$[x_1(t), x_2(t), x_3(t)]$

Use `daetools::isLowIndexDAE` to check the differential index of the system. For this system, `daetools::isLowIndexDAE` returns `FALSE`. This means that the differential index of the system is 2 or higher.

```
daetools::isLowIndexDAE(eqs, vars)
```

`FALSE`

Use `daetools::reduceDAEIndex` as your first attempt to rewrite the system so that the differential index is 1. For this system, `daetools::reduceDAEIndex` issues a warning because it cannot reduce the differential index of the system to 0 or 1.

```
[newEqs, newVars, R, oldIndex] :=
  daetools::reduceDAEIndex(eqs, vars):
```

```
newEquations = newEqs;
newVariables = newVars;
relations = R;
originalIndex = oldIndex
```

Warning: Index of reduced DAEs is larger than 1. [`daetools::reduceDAEIndex`]

```
newEquations = [x2'(t) - q1(t) + x1(t), Dx3t(t) - q2(t) + 2 x2(t) + t (q1(t) - x1(t)),
  q3(t) - x3(t) - t x2(t), q3'(t) - t x2'(t) - x2(t) - Dx3t(t)]
```

```
newVariables = [x1(t), x2(t), x3(t), Dx3t(t)]
```

```
relations = [Dx3t(t) = x3'(t)]
```

```
originalIndex = UNKNOWN
```

If `daetools::reduceDAEIndex` cannot reduce the semilinear system so that the index is 0 or 1, try using `daetools::reduceDAEToODE`. This function can be much slower, therefore it is not recommended as a first choice.

```
[newEqs, constraintEqs, oldIndex] :=
  daetools::reduceDAEToODE(eqs, vars):
```

```
ODEs = eqs;
constraintEquations = constraintEqs;
originalIndex = oldIndex
```

```
ODEs = [  $\frac{\partial}{\partial t} x2(t) = q1(t) - x1(t), \frac{\partial}{\partial t} x3(t) = q2(t) - 2 x2(t) - t (q1(t) - x1(t)),$ 
   $q3(t) - x3(t) - t x2(t) = 0$  ]
```

```
constraintEquations = [q2'(t) - q3''(t) - q1(t) + x1(t), x3(t) - q3(t) + t x2(t),
  q3'(t) - q2(t) + x2(t)]
```

```
originalIndex = 3
```

## Parameters

### **eqs**

A list or a vector of equations or expressions in the state variables `vars` and their derivatives. Expressions represent equations with 0 right side.

### **vars**

A list or a vector of identifiers or expressions, such as  $[x_1(t), x_2(t)]$ .

## Return Values

A nested list containing the following three lists: a list of ordinary differential equations, a list of constraint equations encountered during system reduction, and the differential index of the original DAE system.

## See Also

### **MuPAD Functions**

`daetools::findDecoupledBlocks` | `daetools::incidenceMatrix` |  
`daetools::isLowIndexDAE` | `daetools::massMatrixForm` |  
`daetools::reduceDAEIndex` | `daetools::reduceDifferentialOrder` |  
`daetools::reduceRedundancies`

### **Introduced in R2014b**

# daetools::reduceDifferentialOrder

Reduce systems of higher-order differential equations to systems of first-order differential equations

## Syntax

```
[newEqs,newVars,R] := daetools::reduceDifferentialOrder(eqs,vars)
```

## Description

[newEqs,newVars,R] := daetools::reduceDifferentialOrder(eqs,vars) rewrites a system of higher-order differential equations `eqs` as a system of first-order differential equations `newEqs` by substituting derivatives in `eqs` with new variables. It also returns the matrix `R` that expresses the new variables in `newVars` as derivatives of the original variables `vars`. Here, `newVars` consists of the original variables `vars` augmented with these new variables.

## Examples

### Example 1

Reduce a system containing a second- and a third-order expression to a system containing only first-order DAEs, and return a matrix that expresses the variables generated by `daetools::reduceDifferentialOrder` via the original variables of this system.

Create the following system of differential equations, which includes a second- and a third-order expression. Here,  $x(t)$  and  $y(t)$  are state variables of the system.

```
eqs := [diff(x(t),t,t) = diff(f(t),t,t,t),
        diff(y(t),t,t,t) = diff(f(t),t,t)];
vars := [x(t), y(t)]
```

$$\left[ \frac{\partial^2}{\partial t^2} x(t) = \frac{\partial^3}{\partial t^3} f(t), \frac{\partial^3}{\partial t^3} y(t) = \frac{\partial^2}{\partial t^2} f(t) \right]$$

$$[x(t), y(t)]$$

Rewrite this system so that all equations become first-order differential equations. The `daetools::reduceDifferentialOrder` function replaces the higher-order DAE with first-order equations by introducing the new variables `Dxt(t)`, `Dyt(t)`, and `Dytt(t)`. This function returns a nested list containing the following three lists: a list of new equations, a list of new variables, and a list of relations between the new and the original variables. Display `newEqs`, `newVars`, and `R` separately.

```
[newEqs, newVars, R] :=
  daetools::reduceDifferentialOrder(eqs, vars):

newEqs;
newVars;
R
```

$$[Dxt'(t) - f'''(t), Dytt'(t) - f''(t), Dxt(t) - x'(t), Dyt(t) - y'(t), Dytt(t) - Dyt'(t)]$$

$$[x(t), y(t), Dxt(t), Dyt(t), Dytt(t)]$$

$$[Dxt(t) = x'(t), Dyt(t) = y'(t), Dytt(t) = y''(t)]$$

## Parameters

### **eqs**

A list or a vector of equations or expressions in the state variables `vars` and their derivatives. Expressions represent equations with 0 right side.

### **vars**

A list or a vector of identifiers or expressions, such as `[x1(t), x2(t)]`.

## Return Values

A nested list containing the following three lists: a list of new equations, a list of new variables, and a list of relations between the new and the original variables.

## See Also

### MuPAD Functions

daetools::findDecoupledBlocks | daetools::incidenceMatrix |  
daetools::isLowIndexDAE | daetools::massMatrixForm |  
daetools::reduceDAEIndex | daetools::reduceDAEtoODE |  
daetools::reduceRedundancies

**Introduced in R2014b**

## daetools::reduceRedundancies

Simplify system of first-order differential algebraic equations by eliminating redundant equations and variables

### Syntax

```
[newEqs,  
 newVars,  
 solvedEquations,  
 constantVariables,  
 replacedVariables,  
 otherEquations  
] := daetools::reduceRedundancies(eqs, vars)
```

### Description

```
[newEqs, newVars, solvedEquations, constantVariables,  
 replacedVariables, otherEquations] :=  
daetools::reduceRedundancies(eqs, vars) eliminates simple equations from the  
system of first-order differential algebraic equations eqs. It returns a list of remaining  
equations, a list of remaining variables, and four more lists containing information on the  
eliminated equations and variables. For details, see “Return Values” on page 6-31  
(Symbolic Math Toolbox).
```

### Examples

#### Example 1

Use `daetools::reduceRedundancies` to simplify a system of five differential algebraic equations in four variables to a system of two equations in two variables.

Create the following system of five differential algebraic equations for four state variables:  $x_1(t)$ ,  $x_2(t)$ ,  $x_3(t)$ , and  $x_4(t)$ . This system also contains symbolic parameters  $a_1$ ,  $a_2$ ,  $a_3$ ,  $a_4$ ,  $b$ ,  $c$ , and a parameter function  $f(t)$  that is not a state variable.



```

eqs := [a1*diff(x1(t),t)+a2*diff(x2(t),t) = b*x4(t),
        a3*diff(x2(t),t)+a4*diff(x3(t),t) = c*x4(t),
        x1(t) = 2*x2(t),
        x4(t) = f(t),
        f(t) = sin(t)];
vars := [x1(t), x2(t), x3(t), x4(t)]

```

$$\left[ a_1 \frac{\partial}{\partial t} x_1(t) + a_2 \frac{\partial}{\partial t} x_2(t) = b x_4(t), a_3 \frac{\partial}{\partial t} x_2(t) + a_4 \frac{\partial}{\partial t} x_3(t) = c x_4(t), x_1(t) = 2 x_2(t), \right. \\ \left. x_4(t) = f(t), f(t) = \sin(t) \right]$$

$[x_1(t), x_2(t), x_3(t), x_4(t)]$

Use `daetools::reduceRedundancies` to eliminate redundant equations and corresponding state variables.

```

[newEqs, newVars,
 solvedEquations,
 constantVariables,
 replacedVariables,
 otherEquations
] := daetools::reduceRedundancies(eqs, vars):

```

Display the new equations and new variables.

```

newEqs;
newVars

```

$$\left[ a_1 x_1'(t) - b f(t) + \frac{a_2 x_1'(t)}{2}, \frac{a_3 x_1'(t)}{2} + a_4 x_3'(t) - c f(t) \right]$$

$[x_1(t), x_3(t)]$

Display the equations that `daetools::reduceRedundancies` used to replace those state variables from `vars` that do not appear in `newEqs`.

```

solvedEquations

```

$$[x1(t) - 2 x2(t), x4(t) - f(t)]$$

Display those state variables from `vars` that `daetools::reduceRedundancies` replaced by constant values.

`constantVariables`

$$[x4(t) = f(t)]$$

Display those state variables from `vars` that `daetools::reduceRedundancies` replaced by expressions in terms of other variables.

`replacedVariables`

$$\left[ x2(t) = \frac{x1(t)}{2} \right]$$

Display those equations from `eqs` that do not contain any of the state variables `vars`.

`otherEquations`

$$[f(t) - \sin(t)]$$

## Parameters

### `eqs`

A list or a vector of equations or expressions in the state variables `vars` and their derivatives. Expressions represent equations with 0 right side.

### `vars`

A list or a vector of identifiers or expressions, such as `[x1(t), x2(t)]`.

## Return Values

A nested list containing the following lists:

- A list of new equations
- A list of those variables that remain in the new DAE system
- A list of equations that do not appear in `newEqs`
- A list of equations  $[y1 = \text{value1}(t), y2 = \text{value2}(t), \dots]$  defining those of the variables  $[y1, y2, \dots]$  (contained in the original equations `eqs` and the original `vars`) that were eliminated from `eqs`. In `newEqs`, they are replaced by the values.
- A list of equations  $[y1 = Y1(t, x, \text{diff}(x, t), \dots), y2 = Y2(t, x, \text{diff}(x, t), \dots), \dots]$  defining those of the variables  $[y1, y2, \dots]$  (in the original `vars`) that were eliminated in terms of the variables that are still in `newVars`. (Typically, equations involving only two variables are used to eliminate one of the variables.)
- A list of equations that do not contain any of the variables. These equations do not appear in `newEqs`.

## See Also

### MuPAD Functions

`daetools::findDecoupledBlocks` | `daetools::incidenceMatrix` |  
`daetools::isLowIndexDAE` | `daetools::massMatrixForm` |  
`daetools::reduceDAEIndex` | `daetools::reduceDAEtoODE` |  
`daetools::reduceDifferentialOrder`

**Introduced in R2014b**



# Dom - Domains

---

## DOM\_ARRAY

(symbolic, multidimensional) arrays

### Description

DOM\_ARRAY is a multidimensional container type, storing arbitrary MuPAD objects at integer indices.

Arrays are a fundamental data type in many programming languages: For a fixed number of indices (“dimensions”), for each index an integer from a fixed range, an array provides space to store an arbitrary piece of data at this combination.

### Function Calls

Using an array as a function symbol creates the list obtained by using each array entry as a function symbol for the operands used, i.e., `array(1..2, [f, g])(x, y)` results in `array(1..2, [f(x, y), g(x, y)])`.

### Operations

As with any container, the most important operation on an array is reading and writing its entries, which is performed by indexed access, on page 1-1017 as in `A[1, 2]` or `B[1, 3, 2] := exp(x)`. Trying to access an element outside the boundaries of an array raises an error.

The function `map` applies some function or transformation to each element of an array, returning an array of the same format as its input, with the results of the calls as its entries.

If `A` is an array, `nops(A)` returns the number of elements in `A`.

## Operands

If  $A$  is an array, the 0th operand of  $A$ ,  $\text{op}(A, 0)$ , will be the sequence starting with the number of dimensions (an integer  $n$ ) followed by  $n$  ranges of integers, which denote the acceptable ranges of indices for each dimension, including both numbers listed in the range.

For  $1 \leq i \leq \text{nops}(A)$ , the  $i$ th operand of  $A$  is the  $i$ th entry of  $A$ , in the lexicographic order of indices.

Uninitialized entries of arrays will be displayed symbolically while still in the array. When being accessed by `op` or indexed access, `NIL` is returned.

## Output

One-dimensional arrays are displayed as row vectors, two-dimensional arrays as matrices. Higher-dimensional arrays are written in functional form, using the `index = value` notation, and do not have a typesetting version. This also causes typesetting to be disabled for any surrounding expression in the same output.

## Element Creation

The primary way of creating arrays is the function `array`. Beside that, obviously, `coerce` can convert a number of data types, such as matrices on page 1-1340 into arrays and a number of MuPAD functions, especially in the `numeric` library, return arrays.

## See Also

### MuPAD Domains

`DOM_HFARRAY` | `DOM_LIST` | `DOM_TABLE`

### MuPAD Functions

`array` | `matrix`

## **DOM\_BOOL**

Boolean constants

### **Description**

DOM\_BOOL is the data type of the truth values TRUE, FALSE, and UNKNOWN.

MuPAD uses a three-valued logic system, with these values (constants) TRUE, FALSE, and UNKNOWN.

### **Function Calls**

Using a Boolean constant as a function returns that constant unchanged. The arguments of the call are *not* evaluated.

### **Operations**

The most important operations on Boolean values are the logical operators and, not, or, xor, ==>, <=>, and using them in conditions of if or piecewise.

### **Operands**

Boolean constants are atomic.

### **Output**

TRUE is displayed as *TRUE*, FALSE is displayed as *FALSE*, and UNKNOWN is shown as *UNKNOWN*.



## Element Creation

The three constants can be types in as shown above. Additionally, many MuPAD functions returns Boolean values, the most generic/prominent two being `bool` and `is`.

## See Also

### MuPAD Functions

`bool` | `if` | `is`

## DOM\_COMPLEX

(Simple) Complex Numbers

### Description

DOM\_COMPLEX is the type of complex numbers with integer, rational, or floating-point components.

Complex numbers of type DOM\_COMPLEX have two operands, their real and imaginary part. These are objects of type DOM\_FLOAT, DOM\_INT, or DOM\_RAT. Complex numbers with other components (such as  $\sqrt{2} + i\pi$ ) are not of domain type DOM\_COMPLEX, but DOM\_EXPR.

### Function Calls

Calling a complex number as a function returns that number unchanged. The arguments of the call are *not* evaluated.

### Operations

Most MuPAD functions operate on complex numbers. Use Re and Im to access the real and imaginary part, respectively.

### Operands

Every object of type DOM\_COMPLEX has two operands, the real and the imaginary part.

### Output

Objects of type DOM\_COMPLEX are essentially written as expressions in rectangular form. The imaginary unit is displayed as *I*.

## Element Creation

Complex numbers can be constructed by typing in the corresponding expression, such as  $3+4*I$ . The keyword for typing the imaginary unit  $I$  is  $I$  (a capital letter  $i$ ).

## See Also

### MuPAD Domains

DOM\_FLOAT | DOM\_INT | DOM\_RAT

## DOM\_DOMAIN

Data type of data types

### Description

DOM\_DOMAIN is the data type of datatypes.

Each MuPAD object has a unique data type. Since a data type is a MuPAD object, too, it must itself have a data type; the data type comprising all data types (including itself) is DOM\_DOMAIN.

There are two kinds of elements of DOM\_DOMAIN: data types of the kernel, and data types defined in the library or by the user (*domains*). Objects that have a data type of the latter kind are called *domain elements*.

A data type has the same internal structure as a table on page 1-2103; its entries are called slots on page 1-1980. One particular slot is the *key*; no two different data types can have the same key. Most of the other slots determine how arguments of that data type are handled by functions.

Once a user-defined domain has been constructed, it cannot be destroyed.

### Examples

#### Example 1

Our first example stems from ethnology: some languages in Polynesia do not have words for numbers greater than three; every integer greater than three is denoted by the word “many”. Hence two plus two does not equal four but “many”. We are going to implement a domain for this kind of integers; in other words, we are going to implement a data type for the finite set  $\{1, 2, 3, \text{many}\}$ .

```
S := newDomain("Polynesian integer")
```

Polynesian integer

At this point, we have defined a new data type: a MuPAD object can be a Polynesian integer now. No operations are available yet; the domain consists of its key only:

```
op(S)
```

```
"key" = "Polynesian integer"
```

Even though there are no methods for input and output of domain elements yet, Polynesian integers can be entered and displayed right now. You have to use the function `new` for defining domain elements:

```
x := new(S, 5)
```

```
new(Polynesian integer, 5)
```

Now, `x` is a Polynesian integer:

```
type(x)
```

```
Polynesian integer
```

Of course, MuPAD cannot know what meaning a Polynesian integer has and what its internal structure should be. The arguments of the call to the function `new` are just stored as the zeroth, first, etc. operand of the domain element, without checking them. You may call `new` with as many arguments as you want:

```
new(S, 1, 2, 3, 4); op(%)
```

```
new(Polynesian integer, 1, 2, 3, 4)
```

```
1, 2, 3, 4
```

`new` cannot know that Polynesian integers should have exactly one operand and that we want `5` to be replaced by `many`. To achieve this, we implement our own method `"new"`; this also allows us to check the argument. We have one more problem: domain methods should refer to the domain; but they should not depend on the fact that the domain is currently stored in `S`. For this purpose, MuPAD has a special local variable `dom` that always refers to the domain a procedure belongs to:

```
S::new :=  
proc(i : Type::PosInt)  
begin  
  if args(0) <> 1 then  
    error("There must be exactly one argument")  
  end_if;  
  if i > 3 then  
    new(dom, hold(many))  
  else  
    new(dom, i)  
  end_if  
end_proc:
```

A function call to the domain such as  $S(5)$  now implicitly calls the "new" method:

```
S(5)
```

```
new(Polynesian integer, many)
```

```
S("nonsense")
```

```
Error: Invalid object "nonsense". Type of argument number 1 must be 'Type::PosInt'.  
Evaluating: S::new
```

In the next step, we define our own output method. A Polynesian integer  $i$ , say, shall not be printed as `new(Polynesian integer, i)`, only its internal value 1, 2, 3, or many shall appear on the screen. Note that this value is the first operand of the data structure:

```
S::print :=  
proc(x)  
begin  
  op(x, 1)  
end_proc:  
S(1), S(2), S(3), S(4), S(5)
```

```
1, 2, 3, many, many
```

By now, the input and output of elements of  $S$  have been defined. It remains to define how the functions and operators of MuPAD should react to Polynesian integers. This is done by *overloading* them. However, it is not necessary to overload each of the thousands of functions of MuPAD; for some of them, the default behavior is acceptable. For example, expression manipulation functions leave domain elements unaltered:

```
x := S(5): expand(x), simplify(x), combine(x); delete x:
```

many, many, many

Arithmetical operations handle domain elements like identifiers; they automatically apply the associative and commutative law for addition and multiplication:

```
(S(3) + S(2)) + S(4)
```

2 + 3 + many

In our case, this is not what we want. So we have to overload the operator `+`. Operators are overloaded by overloading the corresponding “underline-functions”; hence, we have to write a method “`_plus`”:

```
S::_plus :=
proc()
local argv;
begin
  argv := map([args()], op, 1);
  if has(argv, hold(many)) then
    new(dom, hold(many))
  else
    dom(_plus(op(argv)))
  end_if
end_proc:
```

Now, the sum of Polynesian integers calls this slot:

```
S(1) + S(2), S(2) + S(3) + S(7)
```

3, many

Deleting the identifier `S` does not destroy our domain. It can still be reconstructed using `newDomain`.

```
delete S:
op(newDomain("Polynesian integer"))
```

```
"key" = "Polynesian integer", "new" = proc S::new(i) ... end, "print" = proc S::print(x) ... end,  
"_plus" = proc S::_plus() ... end
```

## Example 2

We could now give a similar example for more advanced Polynesian mathematics with numbers up to ten, say. This leads to the question whether it is necessary to enter all the code again and again whenever we decide to count a bit farther. It is not; this is one of the advantages of *domain constructors*. A domain constructor may be regarded as a function that returns a domain depending on some input parameters. It has several additional features. Firstly, the additional keywords `category` and `axiom` are available for specifying the mathematical structure of the domain; in our case, we have the structure of a commutative semigroup where different domain elements have different mathematical meanings (we call this a domain with a canonical representation). Secondly, an initialization part may be defined that is executed exactly once for every domain returned by the constructor; it should at least check the parameters passed to the constructor. Each domain created in such a way may inherit methods from other domains, and it must at least inherit the methods of `Dom::BaseDomain`.

```
domain CountingUpTo(n : Type::PosInt)  
  inherits Dom::BaseDomain;  
  category Cat::AbelianSemiGroup;  
  axiom Ax::canonicalRep;  
  
  new := proc(x : Type::PosInt)  
  begin  
    if args(0) <> 1 then  
      error("There must be exactly one argument")  
    end_if;  
    if x > n then  
      new(dom, hold(many))  
    else  
      new(dom, x)  
    end_if  
  end_proc;  
  
  print := proc(x) begin op(x, 1) end_proc;  
  
  _plus := proc() local argv;  
  begin
```



```

    argv:= map([args()], op, 1);
    if has(argv, hold(many)) then
        new(dom, hold(many))
    else
        dom(_plus(op(argv)))
    end_if
end_proc;

// initialization part
begin
    if args(0) <> 1 then
        error("Wrong number of arguments")
    end_if;
end:

```

Now, `CountingUpTo` is a domain constructor:

```
type(CountingUpTo)
```

### DomainConstructor

We have defined the domain constructor `CountingUpTo`, but we have not created a domain yet. This is done by calling the constructor:

```
CountingUpToNine := CountingUpTo(9);
CountingUpToTen := CountingUpTo(10)
```

```
CountingUpTo(9)
```

```
CountingUpTo(10)
```

We are now able to create, output, and manipulate domain elements as in the previous example:

```
x := CountingUpToNine(3): y := CountingUpToNine(7):
x, x + x, y, x + y, y + y
```

```
3, 6, 7, many, many
```

```
x := CountingUpToTen(3): y := CountingUpToTen(7):  
x, x + x, y, x + y, y + y
```

3, 6, 7, 10, many

```
delete CountingUpToNine, CountingUpToTen, CountingUpTo, x, y:
```

No domain constructor with the same name may be used again during the same session.

### Example 3

Suppose that your domain does not really depend on a parameter, but that you need some of the other features of domain constructors. Then you may define a domain constructor `dc`, say, that is called without parameters. From such a domain constructor, you can construct exactly one domain `dc()`. Instead of defining the constructor via `domain dc() ... end` first and then using `d := dc()` to construct the domain `d`, say, you may directly enter `domain d ... end`, thereby saving some work.

Continuing the previous examples, suppose that we want to count up to three, knowing that we never want to count farther. However, we want to declare our domain to be an Abelian semigroup with a canonical representation of the elements. This is not possible with a construction of the domain using `newDomain` as in “Example 1” on page 7-8 (Symbolic Math Toolbox): we have to use the keyword `domain` (Symbolic Math Toolbox). You will notice at once that the following source code is almost identical to the one in the previous example—we just removed the dependence on the parameter `n`.

```
domain CountingUpToThree  
  
inherits Dom::BaseDomain;  
category Cat::AbelianSemiGroup;  
axiom Ax::canonicalRep;  
  
new := proc(x : Type::PosInt)  
begin  
  if args(0) <> 1 then  
    error("There must be exactly one argument")  
  end_if;  
  if x > 3 then  
    new(dom, hold(many))  
  else  
    new(dom, x)
```

```

    end_if
end_proc;

print := proc(x) begin op(x, 1) end_proc;

_plus := proc() local argv;
begin
  argv:= map([args()], op, 1);
  if has(argv, hold(many)) then
    new(dom, hold(many))
  else
    dom(_plus(op(argv)))
  end_if
end_proc;

end:

```

Now, `CountingUpToThree` is a domain and not a domain constructor:

```
type(CountingUpToThree)
```

## DOM\_DOMAIN

You may use this domain in the same way as `CountingUpTo(3)` in “Example 2” on page 7-12 (Symbolic Math Toolbox).

## Function Calls

When called as a function, the data type creates a new object of this data type out of the arguments of the call. E.g., the call `DOM_LIST(1, 2, x)` generates the list `[1, 2, x]` of domain type `DOM_LIST` (although, in this case, you probably prefer to type in `[1, 2, x]` directly which results in the same object). It depends on the particular type which arguments are admitted here.

In the case of a domain, the “new” method of that domain is called.

## Operations

You can obtain the slots of a domain using `slot`. The function `slot` can also be used on the left hand side of an assignment to define new slots, or to re-define existing slots. Use `delete` to delete slots.

## Operands

A data type consists of an arbitrary number of equations (objects of type "equal"). If  $a = b$  is among these equations, we say that the *slot* of the data type equals  $b$ . By convention,  $a$  is usually a string. Each domain has at least one slot indexed by "key".

## Element Creation

The names of the data types provided by the MuPAD kernel are of the form `DOM_XXX`, such as `DOM_ARRAY`, `DOM_HFARRAY`, `DOM_IDENT`, `DOM_INT`, `DOM_LIST`, `DOM_TABLE` etc.

You can create further data types using the function `newDomain` (cf. "Example 1" on page 7-8 (Symbolic Math Toolbox)) or via the keyword `domain` (Symbolic Math Toolbox) (cf. "Example 3" on page 7-14 (Symbolic Math Toolbox)).

You can also create new data types by calling a *domain constructor*. Various pre-defined domain constructors can be found in the library `Dom` (Symbolic Math Toolbox). You can also define your own domain constructors using the keyword `domain` (Symbolic Math Toolbox). Cf. "Example 2" on page 7-12 (Symbolic Math Toolbox).

The domain type (data type) of any MuPAD object can be queried by the function `domtype`.

## Algorithms

Only one domain with a given key may exist. If it is stored in two variables  $S$  and  $T$ , say, assigning or deleting a slot `slot(S, a)` implicitly also changes `slot(T, a)` (reference effect). This also holds if  $a = \text{"key"}$ .

---

**Note** You get no warning even if T is protected.

---

## **DOM\_EXEC**

Kernel functions

### **Description**

Objects of type `DOM_EXEC` represent kernel functions implemented in C++.

Unlike functions defined at the library level (which are stored in objects of type `DOM_PROC`), functions defined in C++ in the MuPAD kernel are represented by objects of type `DOM_EXEC`.

Users normally need not care about `DOM_EXECs` except for the cases where explicitly testing the `domtype` of arguments; in those cases, `DOM_EXEC` should often be treated identically to `DOM_PROC`.

Most kernel functions are actually stored inside function environments of type `DOM_FUNC_ENV`, and therefore, you can see `DOM_EXEC` only when explicitly accessing the first or second operand of those function environments.

### **Function Calls**

An object of type `DOM_EXEC` essentially represents a function; using it in this way calls the corresponding function.

### **Operands**

The operands of a `DOM_EXEC` are used internally, may change at any time and remain undocumented.

## See Also

### **MuPAD Domains**

DOM\_FUNC\_ENV | DOM\_PROC

## DOM\_EXPR

Type of “general expressions”

### Description

DOM\_EXPR is the data type of symbolic function calls. This includes expressions such as  $a + b$  which is internally stored as `_plus(a, b)`.

In MuPAD, non-atomic symbolic expressions which are not elements of special domains have type DOM\_EXPR.

Objects of type DOM\_EXPR have a 0th operand which contains the functor (the function symbol, the  $f$  in  $f(x)$ ). This operand is not counted in the result of `nops`. The subsequent operands can be of arbitrary type (although most functions will limit the number and type of operands when evaluated).

The 0th operand of a DOM\_EXPR will be a procedure or function environment only in exceptional circumstances. In usual circumstances, expressions only have expressions, domain elements, or identifiers as their 0th operands.

### Examples

#### Example 1

Function calls are of type DOM\_EXPR:

```
domtype(sin(x))
```

```
DOM_EXPR
```

The 0th operand of a function call is the function symbol:

```
op(sin(x), 0)
```

```
sin
```



This operand is taken into account neither by `nops` nor by `op` if called with one argument:

```
nops(sin(x)), op(sin(x))
```

```
1, x
```

## Function Calls

The effect of using an expression of type `DOM_EXPR` as a function to call depends on the 0th operand of the expression. For many system functions, the result is that of using all operands of the expression as functions, passing the *unevaluated* arguments. (These functions may in turn evaluate their arguments.)

## Operations

Most MuPAD functions (documented as accepting “arithmetical expressions”) are built to work on elements of type `DOM_EXPR`.

Often, the operands of an expression will be expressions themselves. This creates a so-called “expression tree” which can be visualized using `prog::exprtree`.

## Operands

All expressions are internally represented as function calls. The 0th operand is the function symbol of this call.

## Evaluation

Evaluating an expression results in calling the 0th operand as a function. For library functions without option `hold`, the operands are evaluated first.

## See Also

### **MuPAD Domains**

DOM\_BOOL | DOM\_FLOAT | DOM\_IDENT | DOM\_INT | DOM\_INTERVAL | DOM\_LIST |  
DOM\_POLY | DOM\_RAT | DOM\_SET | DOM\_TABLE

### **MuPAD Functions**

prog::exptree

# DOM\_FLOAT

Real Floating Point Numbers

## Description

DOM\_FLOAT is the type of (arbitrary precision) real floating-point numbers.

Apart from exact symbolic calculations, MuPAD can also compute numerical approximations with arbitrary precision.

MuPAD uses the values RD\_INF and RD\_NINF for real positive and negative infinities in floating-point intervals.

MuPAD uses the value RD\_NAN to indicate undefined values in floating-point intervals. If you use typeset mode (Symbolic Math Toolbox), MuPAD displays this value as NaN in output regions.

## Function Calls

Calling a floating-point number as a function returns the number unchanged. The arguments of the call are *not* evaluated.

## Operations

Just about any arithmetical operation can be performed with floating-point numbers.

## Operands

DOM\_FLOATs are atomic.

## Output

The output format of `DOM_FLOAT` depends on the setting of `Pref::floatFormat` and is documented there.

## Element Creation

Floating point numbers are typed in with an optional sign (an arbitrary number of + and - signs), an optional integer part (consisting of digits), a decimal point (irrespective of locale settings of the operating system, MuPAD always expects a decimal point), a fractional part (one or more decimal digits) and optionally a decimal shift, written as the letter e followed by an optionally signed integer.

The decimal shift is interpreted as a power of ten, i.e., `6.022e23` is the Avogadro number  $6.022 \cdot 10^{23}$ .

Additionally, the function `float` and most calls to functions of the `numeric` library create floating-point numbers as well.

## See Also

### MuPAD Domains

`DOM_COMPLEX` | `DOM_INTERVAL` | `DOM_RAT`

### MuPAD Functions

`DIGITS` | `float`

# DOM\_FUNC\_ENV

Data type of function environments

## Description

DOM\_FUNC\_ENV is the data type of function environments.

MuPAD uses function environments (domain type DOM\_FUNC\_ENV) to integrate functions into the system. All MuPAD library functions and most kernel functions are implemented as function environments.

A function environment stores special function attributes (slots) in an internal table. When an overloadable system function, such as `diff`, `expand`, or `float`, encounters an object of type DOM\_FUNC\_ENV, it searches the function environment for a corresponding slot.

## Operands

A function environment consists of three operands. The first operand is a procedure that computes the return value of a function call. The second operand is a procedure for printing a symbolic function call on the screen. The third operand is a table that specifies how the system functions handle symbolic function calls.

## Element Creation

`funcenv` and `fp::unapply` (or its equivalent `-->`) create function environments of type DOM\_FUNC\_ENV.

## See Also

### MuPAD Domains

DOM\_EXEC | DOM\_PROC

**MuPAD Functions**  
fp::unapply | funcenv

# DOM\_HFARRAY

Hardware floating-point arrays

## Description

DOM\_HFARRAY is a multidimensional container type, storing hardware floating-point numbers at integer indices.

Unlike generic arrays, on page 7-2 objects of type DOM\_HFARRAY are containers of hardware floating-point numbers, real or complex. They take up considerably less space than the corresponding arrays of software floats (DOM\_FLOAT) would, but the range of hardware floating-point numbers is much more limited.

## Function Calls

Using an hf-array as the symbol of a function call returns that hf-array unchanged. The arguments of the call are not evaluated.

## Operations

Read and write access to an hf-array is performed using indexed access, as in `A[1]`, which automatically converts between hardware and software floats. Trying to write a value which cannot be converted into a hardware float into an hf-array causes an error to be raised, as does accessing an element out of bounds.

The function `map` applies some function or transformation to each element of an hf-array, returning an hf-array of the same format as its input, with the results of the calls as its entries. If a result cannot be converted to a hardware float, an error is raised.

If `A` is an hf-array, `nops(A)` returns the number of elements in `A`.

Basic arithmetic works on hf-arrays: Addition and subtraction of hf-arrays of identical format combines the containers element-wise, addition and subtraction of constants is applied to the main diagonal. For two-dimensional hf-arrays, multiplication performs

matrix multiplication. Division is possible for completeness, but should be avoided, as it numerically inverts the dividend first, and this is hardly ever the algorithmically “right” way to handle a numerical problem.

## Operands

If  $A$  is an hf-array, the 0th operand of  $A$ ,  $op(A, 0)$ , will be the sequence starting with the number of dimensions (an integer  $n$ ) followed by  $n$  ranges of integers, which denote the acceptable ranges of indices for each dimension, including both numbers listed in the range.

For  $1 \leq i \leq nops(A)$ , the  $i$ th operand of  $A$  is the  $i$ th entry of  $A$ , in the lexicographic order of indices.

## Output

One-dimensional hf-arrays are displayed as row vectors, two-dimensional hf-arrays as matrices. Higher-dimensional hf-arrays are written in functional form, writing the entries as a flat list, and do not have a typesetting version. This also causes typesetting to be disabled for any surrounding expression in the same output.

## Element Creation

The primary way of creating hf-arrays is the function `hfarray`. Other important functions (optionally) returning hardware float arrays include several functions of the `numeric` library and `import::readbitmap`.

## See Also

### **MuPAD Domains**

`DOM_ARRAY` | `DOM_LIST` | `DOM_TABLE`

### **MuPAD Functions**

`float` | `hfarray`



# DOM\_IDENT

Symbolic Identifiers

## Description

DOM\_IDENT is the data type of symbolic identifiers, used for example for indeterminates.

To perform symbolic computations, it is often necessary to represent indeterminates, which may or may not carry assumptions on page 1-265. These indeterminates (which in some contexts may also be bound identifiers and which may also be assigned on page 1-257 specific values) are called “identifiers” in MuPAD and have the domain type DOM\_IDENT.

## Function Calls

Calling a DOM\_IDENT as a function creates a DOM\_EXPR. If the identifier has a value, the evaluation of that DOM\_EXPR may result in an arbitrary value.

## Operations

Identifiers are valid arithmetical expressions (Symbolic Math Toolbox), so most MuPAD functions happily accept identifiers.

To get and analyze the name of an identifier, you can use `coerce(identifier, DOM_STRING)` and look at the resulting string. (The call `"" . identifier` returns the same string and is shorter to type.)

## Operands

Identifiers are atomic.

## Output

Identifiers are displayed with their names, with the following special cases in typesetting:

- Underscores (`_`) in the middle of identifiers cause subscripting: `x_2` is displayed as  $x_2$ .
- Certain constructs of the form ``&...`` in identifiers are replaced by special typeset characters. For example, ``&alpha;&rarr`` is displayed as  $\vec{\alpha}$ . To generate these identifiers, we suggest using the Symbol (Symbolic Math Toolbox) library, which would use `Symbol::accentRightArrow(Symbol::alpha)` for the example above.

## Element Creation

A sequence of characters, underscores and digits which does not start with a digit is considered an identifier. Examples: `x`, `x0`, `t_0`.

Additionally, an arbitrary string of characters enclosed in 'backticks' `` `` is also an identifier. Examples: ``x+y``, ``a plus 1``. If the string of characters between the back ticks is a valid identifier already, this input form creates the same identifier as the one without the backticks.

## See Also

### MuPAD Domains

`DOM_EXPR` | `DOM_VAR`

### MuPAD Functions

`genident` | `indets`

# DOM\_INT

Integers

## Description

DOM\_INT is the domain of integer constants such as 42 or - 56412564156717653. The size of integers is limited to  $2^{21} - 1$  in absolute value.

## Function Calls

Calling an integer as a function returns that integer unchanged. The arguments are *not* evaluated.

## Operations

Integers are arithmetical expressions (Symbolic Math Toolbox) and thus accepted by almost every MuPAD function.

To represent an integer in a basis different from 10, please use `int2text`.

## Operands

Integers are atomic.

## Element Creation

Integers are given by an optional sign (an arbitrarily long string of + and - signs) and a sequence of decimal digits. Apart from this direct input method, many MuPAD commands such as `text2int` return integers.

## **See Also**

### **MuPAD Domains**

DOM\_FLOAT | DOM\_RAT

# DOM\_INTERVAL

Floating point intervals

## Description

Object of type `DOM_INTERVAL` represents an interval of complex numbers. Either border may be *infinity* or  $-\infty$ . The borders are represented by floating point numbers (`DOM_FLOAT`).

Objects of type `DOM_INTERVAL` represent numerical enclosures of rectangles in the complex plane or finite unions thereof. Numerical enclosures of real intervals are an important special case.

Because an element of type `DOM_INTERVAL` contains floating-point numbers of type `DOM_FLOAT`, its exact value depends on the value of the environment variable `DIGITS` at the time of creation.

The result of all arithmetical operations on elements of type `DOM_INTERVAL` is rounded outwards, that is, the resulting (union of) rectangle(s) is *guaranteed* to contain the exact result. If the result interval is purely real, the lower bound of the result is guaranteed to be no larger than the exact value of the exact result, while the upper value of the result is guaranteed to be no smaller than the exact value. The exact values may not be representable as floating-point numbers. In this case, the result of a single operation such as `+` or `*` is the smallest representable interval containing the exact result. In other words, operations on `DOM_INTERVAL` are locally optimal.

Note that the representation of an element of `DOM_INTERVAL` on the screen is generated with outward rounding, too. This may lead to “apparent overestimation,” as you can see in “Example 1” on page 7-34 (Symbolic Math Toolbox).

For generating matrix or polynomial rings over floating-point intervals, use the façade domain `Dom::FloatIV`.

## Examples

### Example 1

An interval of type `DOM_INTERVAL` can only hold floating-point numbers, which are internally stored as binary numbers. For this reason, it cannot hold symbolic expressions as its operands:

```
iv := hull(PI)
```

```
3.141592653 ... 3.141592654
```

This intervals certainly does contain  $\pi$ . However, the value printed on the screen does not accurately describe the interval generated, as you can see when you print the same interval with a larger value of `DIGITS`:

```
DIGITS := 15: iv; delete DIGITS:
```

```
3.14159265358979 ... 3.1415926535898
```

In the first output, it looked as if the difference between the two borders (the width of the interval) was  $10^{-8}$ , while in the latter output we can see that it is at most  $10^{-13}$ . Actually, the difference is even smaller:

```
op(iv,2) - op(iv,1)
```

```
6.938893904 10-18
```

This rounding does not take place for symbolic values which can be represented exactly in both the internal (binary) and the on-screen (decimal) format:

```
iv := hull(1); op(iv,2) - op(iv,1)
```

```
1.0 ... 1.0
```

```
0.0
```

However, floating-point values in the input are assumed to be approximations up to the current computing precision:

```
iv := hull(1.0); op(iv,2) - op(iv,1)
```

```
0.9999999999 ... 1.000000001
```

```
5.204170428 10-18
```

## Example 2

If you convert `infinity` or `-infinity` into an interval of type `DOM_INTERVAL`, the resulting interval will contain the corresponding floating-point infinity, which are displayed as `RD_INF` or `RD_NINF`, respectively:

```
hull(infinity), hull(-infinity)
```

```
2.098578716 10323228496 ... RD_INF, RD_NINF ... -2.098578716 10323228496
```

Since the range of floating-point numbers is limited, also conversion of finite values may generate floating-point infinities. The exact limit of floating-point numbers may change from one MuPAD version to the next. Currently, the following command exceeds the representable range::

```
hull(exp(10^9))
```

```
2.098578716 10323228496 ... RD_INF
```

As for calculating with intervals with infinities as their borders, note that any multiplication where one factor is exactly zero and the other factor contains either infinity results in the interval encompassing the whole real axis:

```
(0...0) * (1e30...infinity)
```

```
RD_NINF ... RD_INF
```





```
DIGITS:=10:
(1+1e-18) - hull(1.0)
```

```
- 5.204170428 10-18 ... 5.204170428 10-18
```

```
sin(hull(1e42))
```

```
- 1.0 ... 1.0
```

```
DIGITS:=50:
sin(hull(1e42))
```

```
-0.79299795477606165563526882849270558686988301102149 ... -0.7929979547760611145353957196966059781899098036684
```

So, in the latter case we know that the first 17 digits are correct and that the 18th digit is 3, 4, or 5.

## Function Calls

The result of a call to an interval is the interval itself, regardless of the arguments. The arguments are not evaluated.

## Operations

You can access the borders of an interval using `op`. See below for the details.

Intervals can be viewed as sets, and the corresponding functions `union`, `intersect`, and `minus` work on intervals, too.

As of version 2.5, MuPAD implements the following operations on elements of type `DOM_INTERVAL`:

- The basic arithmetical operations: `+`, `-`, `*`, `/`, `^`, `sqrt`.
- The trigonometric functions and their inverses: `sin`, `cos`, `tan`, `sec`, `csc`, `cot`, `arcsin`, `arccos`, `arctan`, `arccsc`, `arccot`.

- The exponential function on page 1-428 (Symbolic Math Toolbox) and the logarithm on page 1-429 (Symbolic Math Toolbox).
- The hyperbolic functions and their inverses: `sinh`, `cosh`, `tanh`, `sech`, `csch`, `coth`, `arcsinh`, `arccosh`, `arctanh`, `arccsch`, `arccoth`.
- The functions `Re`, `Im` (real- and imaginary part), `abs`, `sign` and `arg` (the 'argument' = polar angle of a complex number).
- For real intervals, `gamma` and `beta`.
- `ceil`, `floor`, `trunc`, `round`.

For legal combinations of arguments, all computations are carried out in interval arithmetics, see "Example 4" on page 7-36 (Symbolic Math Toolbox).

## Operands

The operands of an interval depend on its value:

- An interval of type `DOM_INTERVAL` may be a union of rectangles in the complex plane. In this case, the 0th operand is the identifier `union`, while the remaining operands are the corresponding rectangles, which are of type `DOM_INTERVAL`.
- Rectangles with non-zero imaginary part, which are not unions, have two operands of type `DOM_INTERVAL`: Their real and imaginary parts, both of which are real intervals.
- Real intervals, i.e., non-union rectangles with vanishing imaginary part, have two operands, their left and right borders.

## Output

A real interval is displayed in the form "left . . . right", where "left" and "right" are the borders of the interval, printed as floating-point numbers.

A complex interval is displayed as "(real part) + (imaginary part) \* I", with the real and imaginary part displayed as real intervals.

A union of rectangles is displayed as "interval union interval", with the intervals inside written as specified above.

The output of an interval depends on the environment variable `DIGITS` as well as on the preference settings `Pref::floatFormat` and `Pref::trailingZeroes`.

Note that the borders are rounded outwards for printing. “Example 1” on page 7-34 (Symbolic Math Toolbox) shows how this effects the output.

## Element Creation

Elements of type DOM\_INTERVAL can be constructed in the following ways:

- With the function `hull`:

```
hull(PI, -3, 1/2), hull(1/3)
```

```
- 3.0 ... 3.141592654, 0.3333333333 ... 0.3333333334
```

- With the operator `...` (which in turn calls `hull`):

```
1 ... 4+I
```

```
1.0 ... 4.0 + 0.0 ... 1.0 i
```

- The function `interval` creates elements of type DOM\_INTERVAL as well, but may return expressions:

```
interval(x^2+sin(1))
```

```
 $x^2 + 0.8414709848 \dots 0.8414709849$ 
```

Note that floating-point values on page 7-23 in the input of `hull` or `interval` are considered to be approximations, even if the value displayed in the decimal system can be represented exactly in the internal binary format. This is because `hull` cannot decide whether, for example, 0.25 has actually been typed in as such or if it should have been some  $0.25 + \epsilon$ . If you want zero-width intervals, use a rational number as input which can be represented exactly in binary:

## Algorithms

Intervals of type `DOM_INTERVAL` are always interpreted as *closed* intervals, i.e., the endpoints belong to the set. It is reasonable not to have open intervals included, since most operations will enlarge the resulting interval anyway (although only marginally so).

# DOM\_LIST

Lists of Objects

## Description

Lists (of domain type `DOM_LIST`) are ordered collections of an arbitrary number of arbitrary MuPAD objects, except for sequences and the null object.

In MuPAD, the mathematical construct of an  $n$ -tuple is implemented as the data type `DOM_LIST`. Lists consist of an arbitrary (finite) number of arbitrary objects, with the exception of expression sequences on page 1-88, which are split into their operands when placed into a list.

Unlike sets on page 7-50, lists can contain multiple copies of the same element. The order of elements in a list is preserved.

Lists can be empty.

## Examples

### Example 1

To create a list for our first example, we use the operator `$`:

```
L := [x_.i $ i=1..10]
```

```
[x1, x2, x3, x4, x5, x6, x7, x8, x9, x10]
```

This list contains 10 elements:

```
nops(L)
```

```
10
```

The fifth element of the list is  $x_5$  and the list of elements from  $x_3$  through  $x_6$  can also be accessed very easily:

`L[5], L[3..6]`

`$x_5, [x_3, x_4, x_5, x_6]$`

To change an element of the list, we use the indexed form on the left hand side of an assignment:

`L[5] := 5`

`5`

`L`

`$[x_1, x_2, x_3, x_4, 5, x_6, x_7, x_8, x_9, x_{10}]$`

Note that this assignment only changes L, not  $x_5$ :

`x_5`

`$x_5$`

Likewise, we can change a sublist by assigning another list to it. This may change the length of the list:

`L[3..6] := [1, 2]`

`[1, 2]`

`nops(L), L`

`8,  $[x_1, x_2, 1, 2, x_7, x_8, x_9, x_{10}]$`

## Function Calls

Using a list as a function symbol creates the list obtained by using each list element as a function symbol for the operands used, i.e.,  $[f, g](x, y)$  results in  $[f(x, y), g(x, y)]$ .

## Operations

Assuming that  $L$  is a list, the number of elements in  $L$  can be determined by calling `nops(L)`.

Individual elements of the list are accessed in the form  $L[1]$ ,  $L[2]$  etc. when counting from the beginning or  $L[-1]$ ,  $L[-2]$  etc. when counting from the end. Trying to access an element “outside” the list or  $L[0]$  raises an error.

Continuous sub-lists can be extracted by using a range on page 1-16 in an indexed access:  $L[2..4]$  returns the list  $[L[2], L[3], L[4]]$ ;  $L[2..-2]$  returns the list  $L$  without its first and last element.

Both forms of indexed access can also be used as the left hand side of an assignment, cf. “Example 1” on page 7-41 (Symbolic Math Toolbox).

Lists can be concatenated with the dot operator, as in  $L1 . L2$  or its functional form, `_concat`.

The function `contains` finds the first occurrence of a given MuPAD object in a list. `select` and `split` can be used to extract those elements from a list fulfilling an arbitrary predicate.

Lists can be sorted with `sort` or `prog::sort`.

The function `map` applies a function to all elements of a list, returning the list of results. To combine two lists element-wise with some function, use `zip`.

Assigning a list to a list of identifiers is possible and results in a simultaneous assignment, cf. `?_assign`.

### Operands

The operands of a list are its elements.

### Element Creation

The most direct way of creating a list is to place a sequence of MuPAD objects (separated by commas) between rectangular brackets, as in `[1, 2, 3]`.

### See Also

#### **MuPAD Domains**

`DOM_ARRAY` | `DOM_HFARRAY` | `DOM_SET`



# DOM\_PROC

Data type of procedures

## Description

DOM\_PROC is the data type of procedures.

MuPAD procedures belong to the kernel domain DOM\_PROC.

You can enclose procedures of type DOM\_PROC into function environments of type DOM\_FUNC\_ENV.

## Element Creation

proc and its equivalent -> create procedures of type DOM\_PROC.

## See Also

### **MuPAD Domains**

DOM\_PROC\_ENV

### **MuPAD Functions**

funcenv | proc

## DOM\_PROC\_ENV

Data type of procedure environments

### Description

Procedure environments are mostly ephemeral objects and are only rarely seen by the user (and even more rarely useful to examine). A procedure environment represents a procedure that is currently being executed: formal parameters and local variables have values.

Procedure environments do rarely become visible, and you do not need to manipulate them directly. They serve only one purpose: if a procedure is generated inside another procedure, variable names in the body of the inner procedure that are not declared local there refer to names in the outer procedure, provided they are declared local in the outer procedure. (See the Programming Manual for more information on the scoping rules for MuPAD.) Consequently, the inner procedure must contain information on the current values of local variables of the outer procedure. Hence, the status of the outer procedure is encoded into an object of type `DOM_PROC_ENV`, and that object is stored in the returned procedure as its twelfth operand.

You never need to generate objects of this type. There are no operations available.

### Examples

#### Example 1

The only occasion on which you should come across a procedure environment is the following: an outer procedure returns an inner procedure depending on formal parameters or local variables of the outer procedure:

```
outer :=  
proc(x)  
option escape;  
begin  
  /* inner procedure to return : */  
  y -> x + y
```

```
end_proc:  
add5 := outer(5)
```

$y \rightarrow x + y$

In spite of the (slightly confusing) output, `x` has a special meaning here: it points to the parameter `x` of `outer`. That parameter currently has the value 5 and won't be changed any more. To be able to access that value, the particular instance of `outer` in the status of being executed has to be stored in `add5`:

```
expr2text(op(add5, 12))  
  
"DOM_PROC_ENV(0x1f9d904)"
```

## Operands

The number of operands of a procedure environment depends on the number of local and saved variables of the outer procedure. Details about the operands remain undocumented.

## Algorithms

The integers appearing in the output of objects of type `DOM_PROC_ENV` have no mathematical meaning; they denote positions in memory.

## DOM\_RAT

Rational Numbers

### Description

DOM\_RAT is the data type of rational numbers.

### Examples

#### Example 1

The operands of a rational number are its numerator and denominator:

`op(2/3)`

2, 3

When substituting an operand, the resulting DOM\_RAT is again normalized:

`subsop(2/3, 2=6)`

$\frac{1}{3}$

### Function Calls

Using a rational number as a function returns that number unchanged. The function arguments are *not* evaluated.

## Operations

Rational numbers are arithmetical expressions (Symbolic Math Toolbox) and therefore valid inputs to most MuPAD functions.

The numerator and denominator of a rational number can be accessed using `numerator` and `denominator` or by using `op` directly.

Elements of `DOM_RAT` are always normalized, cf. “Example 1” on page 7-48 (Symbolic Math Toolbox).

## Operands

A rational number has two operands, which are integers: Its numerator and its denominator.

## Element Creation

The division of two integers on page 7-31 results in an integer or a rational number.

## See Also

### MuPAD Domains

`DOM_COMPLEX` | `DOM_FLOAT` | `DOM_INT` | `Dom::Rational`

## DOM\_SET

Sets of Objects

### Description

Set of type DOM\_SET can store an arbitrary finite number of arbitrary MuPAD objects, except for sequences and the null object.

In MuPAD, finite sets are implemented with the data type DOM\_SET. Sets are unordered collections of arbitrary objects, with identical objects appearing only once. Sequences on page 1-88 (objects separated by commas) are “flattened” when put into a set, i.e., instead of the sequence, its elements are placed into the set. The null object on page 1-1473 is treated as the empty sequence, i.e., it does not result in an element in the set.

Sets can be empty. The empty set is displayed as  $\emptyset$ .

### Function Calls

Using a set as a function symbol creates the set obtained by using each element as a function symbol for the operands used, i.e.,  $\{f, g\}(x, y)$  results in  $\{f(x, y), g(x, y)\}$ .

### Operations

Assuming that  $S$  is a set, the number of elements in  $S$  can be obtained by calling `nops(S)`.

Individual elements of the set can be obtained in two subtly different ways:

- 1 Using an indexed access, as in `S[2]`, returns the  $n$ -th element of the set, counted in the order as the set appears on the screen. This is a potentially slow operation, since it requires determining that order for each access, i.e., sorting the set.

Negative indices are accepted, counting from the end of the sequence of elements. Trying to access an element “outside” the set or `S[0]` raises an error.

- 2 Using `op`, as in `op(S, 2)`, returns the  $n$ -th element of the set, counted in the internal order. This is a fast operation ( $O(n)$  to get the  $n$ -th element, irrespective of the size of  $S$ ), but the internal order of two mathematically identical sets can be completely different and almost any operation changing a set can completely change its internal order, so no assumptions should be made.

Both of these ways also accept ranges on page 1-16 as indices. `S[2..4]` returns the set  $\{S[2], S[3], S[4]\}$ , while `op(S, 2..4)` returns the sequence `op(S, 2)`, `op(S, 3)`, `op(S, 4)`.

To iterate over all elements of a set in no particular order, using `map` or the `$` operator is highly superior to using a `for`-loop with either of the above element access methods. If a `for`-loop is required, you should use the form `for s in S`, which has linear complexity as well.

The usual set operations are provided as infix operations: `union`, `minus`, `intersect`.

To change an element of a set, the preferred method is to remove it using `minus` and adding a new one using `union`. It is also possible to replace an element with `subsop`; replacing an element with `null()` deletes it from the set. (Note that `subsop` does not do a side-effect assignment.)

The function `contains` checks for occurrence of a given MuPAD object in a set; see also the `in` operator for the same purpose, but with different evaluation semantics. `select` and `split` can be used to extract those elements from a set fulfilling an arbitrary predicate.

To get a list of the elements of a set, use `coerce`. To get such a list with the elements ordered in the same way as printed on the screen, use `DOM_SET::sort(S)`.

## Operands

The operands of a set are its elements, in the internal order. (See above for details.)

## Output

Sets are ordered for the output.

## Element Creation

The most direct way of creating a set is to place a sequence of MuPAD objects (separated by commas) between curly brackets, as in  $\{1, 2, 3\}$ .

## See Also

### **MuPAD Domains**

`DOM_LIST` | `Dom::ImageSet` | `Dom::Multiset`



# DOM\_STRING

Texts (character strings)

## Description

Texts (which are not really “mathematical objects”, but useful to the programmer) in MuPAD are of domain type `DOM_STRING`.

MuPAD can manipulate texts (strings of characters). These are primarily used for output and data input.

## Examples

### Example 1

As far as `op` is concerned, a string cannot be dissected:

```
s := "this is a string":  
op(s, 1), op(s, 2)
```

```
"this is a string", FAIL
```

To access individual characters or substrings, use indexed access:

```
s[1], s[6..7]
```

```
"t", "is"
```

Assigning to a substring may change the length of a string:

```
s[6..7] := "changes";  
s
```

```
"changes"
```

"this changes a string"

## Function Calls

Using a string as a function returns the string unchanged. The arguments are *not* evaluated.

## Operations

Strings can be concatenated using the dot operator or its functional equivalent, `_concat`.

The length of a string can be obtained using `length`.

Substrings and individual characters (which are strings of length 1) can be accessed using `substring` or indexed access, with indices starting at 1 and negative indices counting from the end of the string: `s[1]`, `s[3..-2]`. It is also possible to perform an indexed assignment to a string, cf. "Example 1" on page 7-53 (Symbolic Math Toolbox).

To convert a string into the MuPAD expression that would be obtained by using the string as an input, use `text2expr`. For simple MuPAD expressions, it is possible to get a string that evaluates to that expression using `expr2text`. Expressions that are not convertible in this way include all expressions containing local variables on page 7-56 set with option `escape`. Also, expressions involving floating point numbers on page 7-23 usually will change when being converted to strings and back.

## Operands

Strings are atomic, i.e., they have exactly one operand, the string itself.

## Output

The output form of strings is very similar to their input form. When typesetting, spaces at the beginning and the end of strings are ignored and multiple adjacent blanks as well as newlines are collapsed to a single space.

## Element Creation

A string is created by enclosing characters in a pair of typewriter quotes: `"this is a string"`. The following special sequences are supported (but see below for the typeset output; these are useful only for non-typeset output):

- `"\n"` denotes an end-of-line character.
- `"\b"` is almost identical to `"\n"`, except that for “pretty-printing” it encodes the baseline of the current object.
- `"\t"` is a tabulator.
- `"\""` encodes a backslash.

See the documentation of `print` for details.

## DOM\_VAR

Local Variables in Procedures

### Description

Local variables (variables in the programming sense, with “lexical scoping”) are of domain type `DOM_VAR`.

When writing MuPAD functions, often intermediate results need to be stored and retrieved. Like most programming languages, MuPAD offers “local variables” for this purpose. These local variables do not conflict with global identifiers on page 7-29 of the same name nor with other local variables of the same name used at other places.

Local variables use “lexical scoping”, i.e., they can be used in all program code that is written inside the body of the procedure declaring the local variable. Note that returning anything with a reference to a local variable requires the use of `option escape` in the procedure definition on page 1-1654.

### Operations

Local variables can be assigned values and these values can later be retrieved.

### Element Creation

Local variables are created by using either the special names `dom` or `procname` or one of the names declared with the keyword `local` inside a procedure definition on page 1-1654.

### See Also

#### **MuPAD Domains**

`DOM_IDENT` | `DOM_PROC` | `DOM_PROC_ENV`

**MuPAD Functions**  
context | proc

## Dom::AlgebraicExtension

Simple algebraic field extensions

### Syntax

#### Domain Creation

`Dom::AlgebraicExtension(F, f)`

`Dom::AlgebraicExtension(F, f, x)`

`Dom::AlgebraicExtension(F, f1 = f2)`

`Dom::AlgebraicExtension(F, f1 = f2, x)`

#### Element Creation

`Dom::AlgebraicExtension(F, f)(g)`

`Dom::AlgebraicExtension(F, f)(rat)`

### Description

#### Domain Creation

For a given field  $F$  and a polynomial  $f \in F[x]$ , `Dom::AlgebraicExtension(F, f, x)` creates the residue class field  $F[x]/\langle f \rangle$ .

`Dom::AlgebraicExtension(F, f1=f2, x)` does the same for  $f = f_1 - f_2$ .

`Dom::AlgebraicExtension(F, f, x)` creates the field  $F[x]/\langle f \rangle$  of residue classes of polynomials modulo  $f$ . This field can also be written as  $F[x]/\langle f \rangle$ , the field of residue classes of rational functions modulo  $f$ .

The parameter  $x$  may be omitted if  $f$  is a univariate polynomial or a polynomial expression that contains exactly one indeterminate; it is then taken to be the indeterminate occurring in  $f$ .

The field  $F$  must have normal representation on page 3-8.

$f$  must not be a constant polynomial.

$f$  must be irreducible; this is *not* checked.

$f$  may be a polynomial over a coefficient ring different from  $F$ , or multivariate; however, it must be possible to convert it to a univariate polynomial over  $F$ . See “Example 2” on page 7-60 (Symbolic Math Toolbox).

## Element Creation

`Dom::AlgebraicExtension(F, f)(g)` creates the residue class of  $g$  modulo  $f$ .

If `rat` has numerator and denominator  $p$  and  $q$ , respectively, then `Dom::AlgebraicExtension(F, f)(rat)` equals `Dom::AlgebraicExtension(F, f)(p)` divided by `Dom::AlgebraicExtension(F, f)(q)`.

## Superdomain

`Dom::BaseDomain`

## Axioms

If  $F$  has `Ax::canonicalRep`, then `Ax::canonicalRep`.

## Categories

`Cat::Field`, `Cat::Algebra(F)`, `Cat::VectorSpace(F)`

If  $F$  is a `Cat::DifferentialRing`, then `Cat::DifferentialRing`.

If  $F$  is a `Cat::PartialDifferentialRing`, then `Cat::PartialDifferentialRing`.

## Examples

### Example 1

We adjoin a cubic root  $\alpha$  of 2 to the rationals.

```
G := Dom::AlgebraicExtension(Dom::Rational, alpha^3 = 2)
```

```
Dom::AlgebraicExtension(Dom::Rational, alpha^3 - 2 = 0, alpha)
```

The third power of a cubic root of 2 equals 2, of course.

```
G(alpha)^3
```

```
2
```

The trace of  $\alpha$  is zero:

```
G::conjTrace(G(alpha))
```

```
0
```

You can also create random elements:

```
G::random()
```

```
2 - 814 alpha^2 - 65 alpha + 824
```

### Example 2

The ground field may be an algebraic extension itself. In this way, it is possible to construct a tower of fields. In the following example, an algebraic extension is defined using a primitive element  $\alpha$ , and the primitive element  $\beta$  of a further extension is defined in terms of  $\alpha$ . In such cases, when a minimal equation contains more than one identifier, a third argument to `Dom::AlgebraicExtension` must be explicitly given.



```
F := Dom::AlgebraicExtension(Dom::Rational, alpha^2 = 2):
G := Dom::AlgebraicExtension(F, bet^2 + bet = alpha, bet)
```

```
Dom::AlgebraicExtension(Dom::AlgebraicExtension(Dom::Rational, alpha^2 - 2 =
0, alpha), -alpha + bet + bet^2 = 0, bet)
```

### Example 3

We want to define an extension of the field of fractions of the ring of bivariate polynomials over the rationals.

```
P:= Dom::DistributedPolynomial([x, y], Dom::Rational):
F:= Dom::Fraction(P):
K:= Dom::AlgebraicExtension(F, alpha^2 = x, alpha)
```

```
Dom::AlgebraicExtension(Dom::Fraction(Dom::DistributedPolynomial([x,
y], Dom::Rational, LexOrder)), -x + alpha^2 = 0, alpha)
```

Now  $K = \mathcal{Q}[\sqrt{x}, y]$ . Of course, the square root function has the usual derivative; note that

$\frac{1}{\sqrt{x}}$  can be expressed as  $\frac{\alpha}{x}$ :

```
diff(K(alpha), x)
```

$$\frac{\alpha}{2x}$$

On the other hand, the derivative of  $\sqrt{x}$  with respect to  $y$  is zero, of course:

```
diff(K(alpha), y)
```

$$0$$

We must not use  $D$  here. This works only if we start our construction with a ring of univariate polynomials:

```
P:= Dom::DistributedPolynomial([x], Dom::Rational):
F:= Dom::Fraction(P):
K:= Dom::AlgebraicExtension(F, alpha^2 = x, alpha):
D(K(alpha))
```

$$\frac{\alpha}{2x}$$

## Parameters

### F

The ground field: a domain of category `Cat::Field`

### f, f1, f2

Polynomials or polynomial expressions

### x

Identifier

### g

Element of the residue class to be defined: polynomial over F in the variable x, or any object convertible to such.

### rat

Rational function that belongs to the residue class to be defined: expression whose numerator and denominator can be converted to polynomials over F in the variable x. The denominator must not be a multiple of f.

## Entries

"zero"	the zero element of the field extension
"one"	the unit element of the field extension

"groundField"	the ground field of the extension
"minpoly"	the minimal polynomial $f$
"deg"	the degree of the extension, i.e., of $f$
"variable"	the unknown of the minimal polynomial $f$
"characteristic"	the characteristic, which always equals the characteristic of the ground field. This entry only exists if the characteristic of the ground field is known.
"degreeOverPrimeField"	the dimension of the field when viewed as a vector space over the prime field. This entry only exists if the ground field is a prime field, or its degree over its prime field is known.

## Methods

### Mathematical Methods

#### **`_plus` — Sum of field elements**

`_plus(a, ...)`

This method overloads the function `_plus` of the system kernel.

#### **`_mult` — Product of field elements**

`_mult(a, ...)`

This method overloads the function `_mult` of the system kernel.

#### **`_power` — Raise to the $n$ th power**

Inherited from `Cat::Monoid`.

#### **`_negate` — Negate a field element**

`_negate(a)`

This method overloads the function `_negate` of the system kernel.

**`_subtract` — Difference of field elements**

`_subtract(a, b)`

This method overloads the function `_subtract` of the system kernel.

**`equal` — Test for mathematical equality**

Inherited from `Dom::BaseDomain`.

**`equiv` — Test for equivalence**

Inherited from `Cat::BaseCategory`.

**`iszero` — Test whether a field element is zero.**

`iszero(a)`

This method overloads the function `iszero`.

**`isone` — Test if element is one**

Inherited from `Cat::Monoid`.

**`isUnit` — Test if element is an unit**

Inherited from `Cat::Field`.

**`intmult` — Multiply a field element by an integer**

`intmult(a, b)`

This method is more efficient than `"_mult"` in this special case.

**`_invert` — Inverse of a field element**

`_invert(a)`

This method overloads the function `_invert`.

**\_divide — Exact division**

Inherited from `Cat::Field`.

**divide — Division with remainder**

Inherited from `Cat::Field`.

**quo — Return Euclidean quotient**

Inherited from `Cat::Field`.

**rem — Return Euclidean remainder**

Inherited from `Cat::Field`.

**euclideanDegree — Return Euclidean degree**

Inherited from `Cat::Field`.

**idealGenerator — Generator of finitely generated ideal**

Inherited from `Cat::EuclideanDomain`.

**divides — Test if division is exact**

Inherited from `Cat::Field`.

**gcd — Gcd of field elements**

`gcd(a, ...)`

This method overloads the function `gcd`.

**gcdex — Extended greatest common divisor**

Inherited from `Cat::EuclideanDomain`.

**associates — Test for associate elements**

Inherited from `Cat::Field`.

**unitNormal — Unit normal form**

Inherited from `Cat::Field`.

**unitNormalRep — Unit normal representation**

Inherited from `Cat::Field`.

**lcm — Least common multiple**

Inherited from `Cat::GcdDomain`.

**sqrfree — Square-free factorization**

Inherited from `Cat::Field`.

**irreducible — Test if element is irreducible**

Inherited from `Cat::Field`.

**factor — Unique factorization**

Inherited from `Cat::Field`.

**conjNorm — Norm of an element**

`conjNorm(a)`

**conjTrace — Trace of an element**

`conjTrace(a)`

**minimalPolynomial — Minimal polynomial of an element**

`minimalPolynomial(a)`

**D — Differential operator**

`D(a)`

This method overloads the function `D`.

This method must not be called for inseparable extensions; note that MuPAD cannot check whether an extension is separable.

See “Example 3” on page 7-61 (Symbolic Math Toolbox).

### **diff — Partial differentiation**

`diff(a, x1, ...)`

Differentiation is defined to be the continuation of differentiation of the ground field; this method exists only if the ground field has a method "diff", too.

Differentiation is not possible in inseparable extensions.

This method overloads the function `diff`.

This method must not be called for inseparable extensions; note that MuPAD cannot check whether an extension is separable.

See “Example 3” on page 7-61 (Symbolic Math Toolbox).

### **random — Random element of the field**

`random()`

The `random` method of the ground field is used to generate coefficients of a random polynomial of the ground field; the residue class of that polynomial is the return value. Hence the probability distribution of the elements returned depends on that of the `random` method of the ground field.

## **Conversion Methods**

### **convert — Convert into a field element**

`convert(x)`

If the conversion fails, then FAIL is returned.

### **convert\_to — Convert a field element into another type**

`convert_to(a, T)`

Field elements can be converted to polynomials or expressions. Field elements represented by constant polynomials can also be converted to the same types as the

elements of the ground field; in particular, they can be converted to elements of the ground field.

**coerce — Coerce into this domain**

Inherited from `Cat::BaseCategory`.

**new — Create element of this domain**

Inherited from `Cat::BaseCategory`.

**expr — Convert an element of the field into an expression**

`expr(a)`

This method overloads the function `expr`.

**subs — Avoid substitution**

Inherited from `Dom::BaseDomain`.

**subsex — Avoid extended substitution**

Inherited from `Dom::BaseDomain`.

**testtype — Test type of object**

Inherited from `Cat::BaseCategory`.

**print — Return expression to print an element**

Inherited from `Cat::BaseCategory`.

**printMethods — Print out methods**

Inherited from `Dom::BaseDomain`.

**hasProp — Test for a certain property**

Inherited from `Dom::BaseDomain`.

**whichEntry — Return the domain or category implementing an entry**

Inherited from `Dom::BaseDomain`.



**allEntries — Return the names of all entries**

Inherited from Dom::BaseDomain.

**undefinedEntries — Return missing entries**

Inherited from Dom::BaseDomain.

**getAxioms — Return axioms stated in the constructor**

Inherited from Dom::BaseDomain.

**getSuperDomain — Return super-domain stated in the constructor**

Inherited from Dom::BaseDomain.

**allSuperDomains — Return all super-domains**

Inherited from Dom::BaseDomain.

**getCategories — Return categories stated in the constructor**

Inherited from Dom::BaseDomain.

**allAxioms — Return all axioms**

Inherited from Dom::BaseDomain.

**allCategories — Return all categories**

Inherited from Dom::BaseDomain.

## See Also

**MuPAD Domains**

Dom::GaloisField

## **Dom::ArithmeticalExpression**

Domains of arithmetical expressions

### **Syntax**

`Dom::ArithmeticalExpression(x)`

### **Description**

`Dom::ArithmeticalExpression` is a façade domain of arithmetical expressions built up by the system functions and operators like + and \*.

This domain has almost no algebraic structure because unqualified expressions have no normal form. (For example, there are rational expressions for zero which are not normalized to 0.) The main purpose of `Dom::ArithmeticalExpression` is to provide implementations for methods used by façade sub-domains like `Dom::Integer` which are represented by a subset of the arithmetical expressions.

Elements of `Dom::ArithmeticalExpression` are usually not created explicitly. However, if one creates elements using the usual syntax, the input is converted to an expression using `expr`, then it is checked whether the result is an arithmetical expression.

### **Superdomain**

`Dom::Expression`

### **Axioms**

`Ax::systemRep`

## Categories

Cat::BaseCategory

## Examples

### Example 1

For brevity, we will use AE as a shorthand notation for Dom::ArithmeticalExpression:

```
AE := Dom::ArithmeticalExpression
```

```
Dom::ArithmeticalExpression
```

An element of this domain can *not* be created as follows:

```
e := AE(2*sin(x) + f(x)/y)
```

$$2 \sin(x) + \frac{f(x)}{y}$$

Since Dom::ArithmeticalExpression is a façade domain, e is not a domain element, but an expression:

```
domtype(e)
```

```
DOM_EXPR
```

The fact that no error was returned yields the information that e is an arithmetical expression. This can also be checked as follows:

```
testtype(e,AE)
```

```
TRUE
```

In contrast to its super-domain `Dom::Expression`, this domain only allows elements which are valid arguments for the arithmetical functions, thus the following yields an error:

```
AE([a, b])
```

```
Error: Invalid arguments. [Dom::ArithmeticalExpression::new]
```

## Parameters

**x**

An arithmetical expression

## Entries

"key"	The name of this domain.
"one"	The neutral element w.r.t. "_mult": the constant 1.
"zero"	The neutral element w.r.t. "_plus": the constant 0.

## Methods

### Mathematical Methods

**`_divide`** — Divide arithmetical expressions

```
_divide(f, g)
```

This method overloads the function `_divide`.

For details, please see `_divide`.

**`_invert` — Invert an arithmetical expression**`_invert(f)`

This method overloads the function `_invert`.

For details, please see `_invert`.

**`_mult` — Multiplie arithmetical expressions**`_mult(<f, g, ...>)`

This method overloads the function `_mult`.

For details, please see `_mult`.

**`_negate` — Negate an arithmetical expression**`_negate(f)`

This method overloads the function `_negate`.

For details, please see `_negate`.

**`_plus` — Add arithmetical expressions**`_plus(<f, g, ...>)`

This method overloads the function `_plus`.

For details, please see `_plus`.

**`_power` — Power operator**`_power(f, g)`

This method overloads the function `_power`.

For details, please see `_power`.

**`_subtract` — Subtract an arithmetical expression**`_subtract(f, g)`

For details, please see `_subtract`.

### **D — Differential operator for functions**

`D(f)`

`D([c1, ...], f)`

This method overloads the function `D`.

For details, please see `D`.

### **diff — Differentiate an arithmetical expression**

`diff(f, <x, ...>)`

This method overloads the function `diff`.

For details, please see `diff`.

### **equiv — Test for equivalence**

Inherited from `Cat::BaseCategory`.

### **intmult — Multiply an arithmetical expression with an integer**

`intmult(f, n)`

This method overloads the function `_mult`.

For details, please see `_mult`.

### **iszero — Test for zero**

`iszero(f)`

This method overloads the function `iszero`.

For details, please see `iszero`.

### **max — Maximum of numbers**

`max(x, <y, ...>)`

All numerical arguments must be real.

This method overloads the function `max`.

For details, please see `max`.

### **min — Minimum of numbers**

`min(x, <y, ...>)`

All numerical arguments must be real.

This method overloads the function `min`.

For details, please see `min`.

### **norm — Norm of an arithmetical expression**

`norm(f)`

This method overloads the function `abs`.

For details, please see `abs`.

### **random — Create random expression**

Inherited from `Dom::Expression`.

## **Access Methods**

### **subs — Substitution**

Inherited from `Dom::Expression`.

### **subsex — Extended substitution**

Inherited from `Dom::Expression`.

## Conversion Methods

**coerce** — Coerce into this domain

Inherited from `Cat::BaseCategory`.

**convert** — Check for being an arithmetical expression

`convert(x)`

**convert\_to** — Conversion to other domains

Inherited from `Dom::Expression`.

**expr** — Just return the argument

Inherited from `Dom::Expression`.

**float** — Convert numbers to floats

Inherited from `Dom::Expression`.

## Technical Methods

**allAxioms** — Return all axioms

Inherited from `Dom::BaseDomain`.

**allCategories** — Return all categories

Inherited from `Dom::BaseDomain`.

**allEntries** — Return the names of all entries

Inherited from `Dom::BaseDomain`.

**allSuperDomains** — Return all super-domains

Inherited from `Dom::BaseDomain`.



**testtype — Test type of object**

Inherited from `Cat::BaseCategory`.

**undefinedEntries — Return missing entries**

Inherited from `Dom::BaseDomain`.

**whichEntry — Return the domain or category implementing an entry**

Inherited from `Dom::BaseDomain`.

**getAxioms — Return axioms stated in the constructor**

Inherited from `Dom::BaseDomain`.

**getCategories — Return categories stated in the constructor**

Inherited from `Dom::BaseDomain`.

**getSuperDomain — Return super-domain stated in the constructor**

Inherited from `Dom::BaseDomain`.

**hasProp — Test for a certain property**

Inherited from `Dom::BaseDomain`.

**info — Print short information about this domain**

Inherited from `Dom::BaseDomain`.

**new — Create element of this domain**

Inherited from `Cat::BaseCategory`.

**print — Return expression to print an element**

Inherited from `Cat::BaseCategory`.

**printMethods — Print out methods**

Inherited from `Dom::BaseDomain`.

**testtype** — Test whether its argument is an expression

Inherited from Dom::Expression.

**undefinedEntries** — Return missing entries

Inherited from Dom::BaseDomain.

**whichEntry** — Return the domain or category implementing an entry

Inherited from Dom::BaseDomain.

## See Also

**MuPAD Domains**

Dom::Expression

# Dom::BaseDomain

Root of the domain hierarchy

## Description

Dom::BaseDomain is the root of the domain hierarchy as defined by the Dom (Symbolic Math Toolbox) package. Every domain of the package inherits from it.

The only purpose of Dom::BaseDomain is to supply all domains of the package with some basic methods like "hasProp". Elements of Dom::BaseDomain cannot be created.

Unlike other super-domains this domain does not impose any restrictions on the representation of the elements of its sub-domains. Thus it may be a super-domain for any domain created by a domain constructor.

## Categories

Cat::BaseCategory

## Entries

<pre>"create_dom"</pre>	<p>This domain entry is used to revive the domain when it is read from a binary MCode stream.</p> <p>If this entry is present it is written to the MCode stream instead of the contents of the domain. When the stream is read it is used to create the domain.</p> <p>If this entry does not exist all entries of the domain are written to the stream and read in later to create the domain.</p> <p>Dom::BaseDomain defines "create_dom" to have the same value as the key of the domain, as stored in the entry "key". All domains of the Dom (Symbolic Math Toolbox) package inherit this entry, thus they must be created by the reader of the MCode stream by evaluating the expression stored in the key.</p>
-------------------------	---

## Methods

### Mathematical Methods

#### equal — Test for mathematical equality

```
equal(x, y)
```

If this domain has the axiom `Ax::canonicalRep`, which implies that two domain elements are mathematically equal if and only if they are structurally equal, the kernel function `_equal` is used to decide the equality. In this case `UNKNOWN` is never returned.

If the axiom `Ax::canonicalRep` does not hold the method will return `TRUE` if `x` and `y` are structurally equal (in the sense of the function `_equal`) and `UNKNOWN` otherwise.

## Conversion Methods

### **convert\_to — Convert element**

convert\_to(x, T)

The implementation provided here can convert  $x$  to an element of this domain (the trivial case) or to an element of `Dom::Expression` (by using the method "expr", see `Cat::BaseCategory`).

## Access Methods

### **allAxioms — Return all axioms**

allAxioms()

### **allCategories — Return all categories**

allCategories()

### **allEntries — Return the names of all entries**

allEntries()

### **allSuperDomains — Return all super-domains**

allSuperDomains()

The last, most general, super-domain of all domains of the Dom (Symbolic Math Toolbox) package is `Dom::BaseDomain`.

### **getAxioms — Return axioms stated in the constructor**

getAxioms()

### **getCategories — Return categories stated in the constructor**

getCategories()

### **getSuperDomain — Return super-domain stated in the constructor**

getSuperDomain()

**hasProp — Test for a certain property**

hasProp(d)

hasProp(dc)

hasProp(a)

hasProp(ac)

hasProp(c)

hasProp(cc)

hasProp(dc) tests if this domain or a super-domain of it was defined by the domain constructor dc.

hasProp(a) tests if this domain has the axiom a.

hasProp(ac) tests if an axiom of this domain was defined by the axiom constructor ac.

hasProp(c) tests if this domain has the category c.

hasProp(cc) tests if a category of this domain was defined by the category constructor cc.

**info — Print short information about this domain**

info()

It prints out the super-domains, categories, axioms and entry names of this domain.

If an entry "info\_str", which must be a string, is defined for this domain it is used to print the header line.

**printMethods — Print out methods**

printMethods(<sort>, <Table>)

printMethods(<sort>, Tree)

If no sorting function is given, sort is used as default.

Similar as above, using `Tree` provides only that the names of the entries are inserted into a tree, an element of the domain `adt::Tree`. The tree is both printed out and returned by the method.

Using neither `Table` nor `Tree` the function does the same as `dom::printMethods(sort, Table)`.

### **subs — Avoid substitution**

`subs(x, , ...)`

Sub-domains should provide a new implementation of this method with sensible semantics if possible.

### **subsex — Avoid extended substitution**

`subsex(x, , ...)`

Sub-domains should provide a new implementation of this method with sensible semantics if possible.

### **undefinedEntries — Return missing entries**

`undefinedEntries()`

An entry is missing if it should have a definition according to a category of the domain, but the definition is not present.

### **whichEntry — Return the domain or category implementing an entry**

`whichEntry(e)`

FAIL is returned if no entry with the given name is defined for this domain.

## Dom::Complex

Field of complex numbers

### Syntax

`Dom::Complex(x)`

### Description

`Dom::Complex` is the domain of complex constants represented by expressions of type `DOM_INT`, `DOM_RAT`, `DOM_FLOAT` or `DOM_COMPLEX`. An expression of type `DOM_EXPR` is considered a complex number if it is of type `Type::Arithmetical` and if it contains only indeterminates which are of type `Type::ConstantIdents` or if it contains no indeterminates, cf. "Example 2" on page 7-85 (Symbolic Math Toolbox).

`Dom::Complex` is of category `Cat::Field` due to pragmatism. This domain actually is not a field because `bool(1.0 = float(3) / float(3))` returns `FALSE`, for example.

Elements of `Dom::Complex` are usually not created explicitly. However, if one creates elements using the usual syntax, it is checked whether the input expression can be converted to a number. This means `Dom::Complex` is a facade domain which creates elements of domain type `DOM_INT`, `DOM_RAT`, `DOM_FLOAT`, `DOM_COMPLEX` or `DOM_EXPR`.

`Dom::Complex` has no normal representation, because `0` and `0.0` both represent the zero.

Viewed as a differential ring, `Dom::Complex` is trivial. It only contains constants.

`Dom::Complex` has the domain `Dom::BaseDomain` as its super domain, i.e., it inherits each method which is defined by `Dom::BaseDomain` and not re-implemented by `Dom::Complex`. Methods described below are re-implemented by `Dom::Complex`.

### Superdomain

`Dom::ArithmeticalExpression`



## Axioms

```
Ax::systemRep, Ax::efficientOperation("_divide"),  
Ax::efficientOperation("_mult"), Ax::efficientOperation("_invert")
```

## Categories

```
Cat::DifferentialRing, Cat::Field
```

## Examples

### Example 1

Creating some complex numbers using `Dom::Complex`:

```
Dom::Complex(2/3)
```

$$\frac{2}{3}$$

```
Dom::Complex(2/3 + 4*I)
```

$$\frac{2}{3} + 4i$$

### Example 2

It's also possible to use expressions or constants for creating an element of `Dom::Complex`:

```
Dom::Complex(PI)
```

$$\pi$$

```
Dom::Complex(sin(2))
```

$\sin(2)$

`Dom::Complex(sin(2/3*I) + 3)`

$3 + \sinh\left(\frac{2}{3}\right) i$

If the expression cannot be converted to an element of `Dom::Complex` we will get an error message:

`Dom::Complex(sin(x))`

`Error: Invalid arguments. [Dom::Complex::new]`

## Parameters

**x**

An expression of type `DOM_INT`, `DOM_RAT`, `DOM_FLOAT`, `DOM_COMPLEX`. An expression of type `DOM_EXPR` is also possible if it is of type `Type::Arithmetical` and if it contains only indeterminates which are of type `Type::ConstantIdents` or if it contains no indeterminates.

## Entries

"characteristic"	the characteristic of this field is 0.
"one"	the unit element; it equals 1.
"zero"	The zero element; it equals 0.

## Methods

### Mathematical Methods

**`_divide` — Divide numbers**

`_divide(x, y)`

**`_invert` — Invert numbers**

`_invert(x)`

**`_mult` — Multiplie numbers**

`_mult(x, y, ...)`

**`_negate` — Negate numbers**

`_negate(x)`

**`_plus` — Add numbers**

`_plus(x, y, ...)`

**`_power` — Power operator**

`_power(x, y)`

**`_unequal` — Inequalities**

`_unequal(x, y)`

**`conjugate` — Conversion to a basic type**

`conjugate(x)`

**`D` — Differential operator**

`D(x)`

**diff — Differentiates**

diff(z, <x, ...>)

**equal — Equations**

equal(x, y)

**expr — Conversion to a basic type**

expr(x)

**iszero — Zero test**

iszero(x)

**norm — Absolute value of a number**

norm(x)

**random — Random number generation**

random()

random(n)

random(m .. n)

random(n) returns a random number generator which creates complex random numbers where the real parts and the imaginary parts are positive integers between 0 and  $n - 1$ .

random(m .. n) returns a random number generator which creates complex random numbers where the real parts and the imaginary parts are positive integers between  $m$  and  $n$ .

**unequal — Inequalities**

unequal(x, y)

## Conversion Methods

### **convert** — Conversion into this domain

`convert(x)`

An arithmetical expression can be converted if it only contains subexpression of the types just mentioned.

If the conversion fails, FAIL is returned.

### **convert\_to** — Conversion to other domains

`convert_to(x, T)`

If the conversion fails, FAIL is returned.

The following domains are allowed for T: DOM\_INT, Dom::Integer, DOM\_RAT, Dom::Rational, DOM\_FLOAT, Dom::Float, Dom::Numerical, DOM\_COMPLEX and DOM\_EXPR.

### **normal** — Normal form of objects

`normal(x)`

## See Also

### **MuPAD Domains**

Dom::Float | Dom::Integer | Dom::Numerical | Dom::Rational | Dom::Real

# Dom::DenseMatrix

Matrices

## Syntax

### Domain Creation

`Dom::DenseMatrix(<R>)`

### Element Creation

`Dom::DenseMatrix(R)(Array)`

`Dom::DenseMatrix(R)(List)`

`Dom::DenseMatrix(R)(ListOfRows)`

`Dom::DenseMatrix(R)(Matrix)`

`Dom::DenseMatrix(R)(m, n)`

`Dom::DenseMatrix(R)(m, n, Array)`

`Dom::DenseMatrix(R)(m, n, List)`

`Dom::DenseMatrix(R)(m, n, ListOfRows)`

`Dom::DenseMatrix(R)(m, n, f)`

`Dom::DenseMatrix(R)(m, n, List, Diagonal)`

`Dom::DenseMatrix(R)(m, n, g, Diagonal)`

`Dom::DenseMatrix(R)(m, n, List, Banded)`

`Dom::DenseMatrix(R)(1, n, List)`

`Dom::DenseMatrix(R)(m, 1, List)`

## Description

### Domain Creation

`Dom::DenseMatrix(R)` creates domains of matrices over a component domain  $R$  of category `Cat::Rng` (a ring, possibly without unit).

If the optional parameter  $R$  is not given, the domain `Dom::ExpressionField()` is used.

A vector with  $n$  entries is either an  $n \times 1$  matrix (a column vector), or a  $1 \times n$  matrix (a row vector).

Arithmetical operations with matrices can be performed by using the standard arithmetical operators of MuPAD.

E.g., if  $A$  and  $B$  are two matrices defined by `Dom::DenseMatrix(R)`,  $A + B$  computes the sum, and  $A * B$  computes the product of the two matrices, provided that the dimensions are correct.

Similarly,  $A^{-1}$  or  $1/A$  computes the inverse of a square matrix  $A$  if it exists, and returns FAIL otherwise. See “Example 1” on page 7-94 (Symbolic Math Toolbox).

Many system functions have been overloaded for matrices, such as `map`, `subs`, `has`, `zip`, `conjugate` to compute the complex conjugate of a matrix, `norm` to compute matrix norms, or `exp` to compute the exponential of a matrix.

Most of the functions in the MuPAD linear algebra package `linalg` work with matrices. For example, the command `linalg::gaussJordan(A)` performs Gauss-Jordan elimination on  $A$  to transform  $A$  to its reduced row echelon form.

The domain `Dom::DenseMatrix(R)` represents matrices over  $R$  of arbitrary size, and it therefore does not have any algebraic structure (other than being a *set* of matrices).

The domain `Dom::SquareMatrix(n, R)` represents the *ring* of  $n \times n$  matrices over  $R$ . The domain `Dom::MatrixGroup(m, n, R)` represents the *Abelian group* of  $m \times n$  matrices over  $R$ .

We use the following notations for a matrix  $A$  (an element of `Dom::DenseMatrix(R)`):

- $nrows(A)$  denotes the number of rows of  $A$ .

- $ncols(A)$  denotes the number of columns of  $A$ .
- A *row index* is an integer in the range from 1 to  $nrows(A)$ .
- A *column index* is an integer in the range from 1 to  $ncols(A)$ .

---

**Note** The components of a matrix are no longer evaluated after the creation of the matrix, i.e., if they contain free identifiers they will not be replaced by their values.

---

## Element Creation

`Dom::DenseMatrix(R) (Array)` and `Dom::DenseMatrix(R) (Matrix)` create a new matrix with the dimension and the components of `Array` and `Matrix`, respectively.

The components of `Array` or `Matrix` are converted into elements of the domain `R`. An error message is issued if one of these conversions fails.

`Dom::DenseMatrix(R) (List)` creates an  $m \times 1$  column vector with components taken from the nonempty list on page 7-41, where  $m$  is the number of entries of `List`.

`Dom::DenseMatrix(R) (ListOfRows)` creates an  $m \times n$  matrix with components taken from the nested list on page 7-41 `ListOfRows`, where  $m$  is the number of inner lists of `ListOfRows`, and  $n$  is the maximal number of elements of an inner list. Each inner list corresponds to a row of the matrix. Both  $m$  and  $n$  must be non-zero.

If an inner list has less than  $n$  entries, then the remaining components in the corresponding row of the matrix are set to zero.

The entries of the inner lists are converted into elements of the domain `R`. An error message is issued if one of these conversions fails.

It might be a good idea first to create a two-dimensional array on page 7-2 from that list before calling `Dom::DenseMatrix(R)`. This is due to the fact that creating a matrix from an array is the fastest way one can achieve. However, in this case the sublists must have the same number of elements.

The call `Dom::DenseMatrix(R) (m, n)` returns the  $m \times n$  zero matrix.

Use the method "identity" to create the  $n \times n$  identity matrix.

The call `Dom::DenseMatrix(R) (m, n, Array)` creates an  $m \times n$  matrix with components taken from `Array`, which must be an array on page 7-2 or an `harray` on page



7-27. Array must have  $m n$  operands. The first  $m$  operands define the first row, the next  $m$  operands define the second row, etc. The formatting of the array is irrelevant. E.g., any array with 6 elements can be used to create a matrix of dimension  $1 \times 6$ , or  $2 \times 3$ , or  $3 \times 2$ , or  $6 \times 1$ .

The call `Dom::DenseMatrix(R)(m, n, List)` creates an  $m \times n$  matrix with components taken from the list on page 7-41 `List` with  $m n$  elements. The first  $m$  elements of the list define the first row, the next  $m$  elements of the list define the second row, etc.

The call `Dom::DenseMatrix(R)(m, n, ListOfRows)` creates an  $m \times n$  matrix with components taken from the list on page 7-41 `ListOfRows`.

If  $m \geq 2$  and  $n \geq 2$ , then `ListOfRows` must consist of at most  $m$  inner lists, each having at most  $n$  entries. The inner lists correspond to the rows of the returned matrix.

If an inner list has less than  $n$  entries, then the remaining components of the corresponding row of the matrix are set to zero. If there are less than  $m$  inner lists, then the remaining lower rows of the matrix are filled with zeroes.

`Dom::DenseMatrix(R)(m, n, f)` returns the matrix whose  $(i, j)$ th component is the value of the function call `f(i, j)`. The row index  $i$  ranges from 1 to  $m$  and the column index  $j$  from 1 to  $n$ .

The function values are converted into elements of the domain  $R$ . An error message is issued if one of these conversions fails.

`Dom::DenseMatrix(R)(1, n, List)` returns the  $1 \times n$  row vector with components taken from `List`. The list `List` must have at most  $n$  entries. If there are fewer entries, then the remaining vector components are set to zero.

The entries of the list are converted into elements of the domain  $R$ . An error message is issued if one of these conversions fails.

`Dom::DenseMatrix(R)(m, 1, List)` returns the  $m \times 1$  column vector with components taken from `List`. The list `List` must have at most  $m$  entries. If there are fewer entries, then the remaining vector components are set to zero.

The entries of the list are converted into elements of the domain  $R$ . An error message is issued if one of these conversions fails.

## Superdomain

`Dom::BaseDomain`

## Axioms

If `R` has `Ax::canonicalRep`, then `Ax::canonicalRep`.

## Categories

`Cat::Matrix(R)`.

## Examples

### Example 1

First we create the domain of matrices over the field of rational numbers:

```
MatQ := Dom::DenseMatrix(Dom::Rational)
```

```
Dom::DenseMatrix(Dom::Rational)
```

We assigned this domain to the identifier `MatQ`. Next we define the  $2 \times 2$  matrix

$$\begin{pmatrix} 1 & 5 \\ 2 & 3 \end{pmatrix}$$

by a list of two rows, where each row is a list of two elements:

```
A := MatQ([[1, 5], [2, 3]])
```

$$\begin{pmatrix} 1 & 5 \\ 2 & 3 \end{pmatrix}$$

In the same way we define the following  $2 \times 3$  matrix:

```
B := MatQ([[ -1, 5/2, 3], [1/3, 0, 2/5]])
```

$$\begin{pmatrix} -1 & \frac{5}{2} & 3 \\ \frac{1}{3} & 0 & \frac{2}{5} \end{pmatrix}$$

and perform matrix arithmetic using the standard arithmetical operators of MuPAD, e.g., the matrix product  $AB$ , the 4th power of  $A$  as well as the scalar multiplication of  $A$  times

$\frac{1}{3}$ :

```
A * B, A ^ 4, 1/3 * A
```

$$\begin{pmatrix} \frac{2}{3} & \frac{5}{2} & 5 \\ -1 & 5 & \frac{36}{5} \end{pmatrix}, \begin{pmatrix} 281 & 600 \\ 240 & 521 \end{pmatrix}, \begin{pmatrix} \frac{1}{3} & \frac{5}{3} \\ \frac{2}{3} & 1 \end{pmatrix}$$

The matrices  $A$  and  $B$  have different dimensions, and therefore the sum of  $A$  and  $B$  is not defined. MuPAD issues an error message:

```
A + B
```

```
Error: Dimensions do not match. [(Dom::DenseMatrix(Dom::Rational))::_plus]
```

To compute the inverse of  $A$ , just enter:

```
1/A
```

$$\begin{pmatrix} -\frac{3}{7} & \frac{5}{7} \\ \frac{2}{7} & -\frac{1}{7} \end{pmatrix}$$

If a matrix is not invertible, FAIL is the result of this operation. For example, the matrix:

```
C := densmatrix(2, 2, [[2]])
```

$$\begin{pmatrix} 2 & 0 \\ 0 & 0 \end{pmatrix}$$

is not invertible, hence:

```
C^(-1)
```

```
FAIL
```

## Example 2

We create the domain of matrices over the reals:

```
MatR := Dom::DenseMatrix(Dom::Real)
```

```
Dom::DenseMatrix(Dom::Real)
```

Beside standard matrix arithmetic, the library `linalg` offers a lot of functions dealing with matrices. For example, if one wants to compute the rank of a matrix, use `linalg::rank`:

```
A := MatR([[1, 2], [2, 4]])
```

```
 $\begin{pmatrix} 1 & 2 \\ 2 & 4 \end{pmatrix}$ 
```

```
linalg::rank(A)
```

```
1
```

Use `linalg::eigenvectors` to compute eigenvalues and eigenvectors of the matrix  $A$ :

```
linalg::eigenvectors(A)
```

```
 $\left[ \left[ 0, 1, \left[ \begin{pmatrix} -2 \\ 1 \end{pmatrix} \right] \right], \left[ 5, 1, \left[ \begin{pmatrix} \frac{1}{2} \\ 1 \end{pmatrix} \right] \right] \right]$ 
```

Try `info(linalg)` for a list of available functions, or enter `help(linalg)` for details about the library `linalg`.

Some of the functions in the `linalg` package simply serve as “interface” functions for methods of a matrix domain described above. For example, `linalg::transpose` uses the method “`transpose`” to get the transposed matrix. The function `linalg::gaussElim` applies Gaussian elimination to a matrix, such as:

```
linalg::gaussElim(A)
```

$$\begin{pmatrix} 1 & 2 \\ 0 & 0 \end{pmatrix}$$

The computation is performed by the method “`gaussElim`” as described above. Such functions of the `linalg` packages, in contrast to the corresponding methods of the domain `Dom::DenseMatrix(R)`, check their incoming parameters, and some of them offer extended functionalities.

### Example 3

In this example, we use the default matrix domain which is created by `Dom::DenseMatrix()`. This domain represents matrices whose components can be arbitrary arithmetical expressions (i.e., the component ring is the domain `Dom::ExpressionField()`).

This domain is already known to MuPAD by the name `matrix`:

```
A := densmatrix(
  [[1, 2, 3, 4], [2, 0, 4, 1], [-1, 0, 5, 2]]
)
```

$$\begin{pmatrix} 1 & 2 & 3 & 4 \\ 2 & 0 & 4 & 1 \\ -1 & 0 & 5 & 2 \end{pmatrix}$$

```
domtype(A)
```

```
Dom::DenseMatrix()
```

Matrix components can be extracted by the index operator `[]`:

```
A[2, 1] * A[1, 2] - A[3, 1] * A[1, 3]
```

7

If one of the indices is not in its valid range, an error message is issued. Assignments to matrix components are performed similarly:

```
delete a:
A[1, 2] := a^2: A
```

$$\begin{pmatrix} 1 & a^2 & 3 & 4 \\ 2 & 0 & 4 & 1 \\ -1 & 0 & 5 & 2 \end{pmatrix}$$

Beside the usual indexing of matrix components, it is also possible to extract submatrices from a given matrix. The following call creates the submatrix of  $A$  which consists of the rows 2 to 3 and columns 1 to 3 of  $A$ :

```
A[2..3, 1..3]
```

$$\begin{pmatrix} 2 & 0 & 4 \\ -1 & 0 & 5 \end{pmatrix}$$

The index operator does not allow to insert submatrices into a given matrix. This is implemented by the function `linalg::substitute`.

## Example 4

In the following examples, we demonstrate the different ways of creating matrices. We work with matrices defined over the field  $\mathbb{Z}_{19}$ , i.e., the field of integers modulo 19. This component ring can be created with the domain constructor `Dom::IntegerMod`.

We start by giving a list of rows, where each row is a list of row entries:

```
MatZ19 := Dom::DenseMatrix(Dom::IntegerMod(19)):
MatZ19([[1, 2], [2]])
```

$$\begin{pmatrix} 1 \bmod 19 & 2 \bmod 19 \\ 2 \bmod 19 & 0 \bmod 19 \end{pmatrix}$$

The elements of the two inner lists, the row entries, were converted into elements of the domain `Dom::IntegerMod(19)`.

The number of rows is the number of sublists of the argument, i.e.,  $m = 2$ . The number of columns is determined by the length of the inner list with the most entries, which is the first inner list with two entries. Missing entries in the other inner lists are treated as zero components. The call:

```
MatZ19(4, 4, [[1, 2], [2]])
```

$$\begin{pmatrix} 1 \bmod 19 & 2 \bmod 19 & 0 \bmod 19 & 0 \bmod 19 \\ 2 \bmod 19 & 0 \bmod 19 & 0 \bmod 19 & 0 \bmod 19 \\ 0 \bmod 19 & 0 \bmod 19 & 0 \bmod 19 & 0 \bmod 19 \\ 0 \bmod 19 & 0 \bmod 19 & 0 \bmod 19 & 0 \bmod 19 \end{pmatrix}$$

fixes the dimension of the matrix. Missing entries and inner lists are treated as zero components and zero rows, respectively.

An error message is issued if one of the given entries cannot be converted into an element over  $\mathbb{Z}_{19}$ :

```
MatZ19([[2, 3], [-1, I]])
```

```
Error: Unable to define a matrix over 'Dom::IntegerMod(19)'. [(Dom::DenseMatrix(Dom::I
```

## Example 5

This example illustrates how to create a matrix with components given as values of an index function. First we create the  $2 \times 2$  Hilbert matrix (see also the functions `linalg::hilbert` and `linalg::invhilbert`):

```
densematrix(2, 2, (i, j) -> 1/(i + j - 1))
```

$$\begin{pmatrix} 1 & \frac{1}{2} \\ \frac{1}{2} & \frac{1}{3} \end{pmatrix}$$

Note the difference when working with expressions and functions. If you give an expression it is treated as a function in the row and column indices:

```
delete x:  
densematrix(2, 2, x), densematrix(2, 2, (i, j) -> x)
```

$$\begin{pmatrix} x(1, 1) & x(1, 2) \\ x(2, 1) & x(2, 2) \end{pmatrix}, \begin{pmatrix} x & x \\ x & x \end{pmatrix}$$

## Example 6

Diagonal matrices can be created with the option `Diagonal` and a list of diagonal components:

```
MatC := Dom::DenseMatrix(Dom::Complex):  
MatC(3, 4, [1, 2, 3], Diagonal)
```

$$\begin{pmatrix} 1 & 0 & 0 & 0 \\ 0 & 2 & 0 & 0 \\ 0 & 0 & 3 & 0 \end{pmatrix}$$

Hence, to define the  $n \times n$  identity matrix, you can enter:

```
MatC(3, 3, [1 $ 3], Diagonal)
```

$$\begin{pmatrix} 1 & 0 & 0 \\ 0 & 1 & 0 \\ 0 & 0 & 1 \end{pmatrix}$$

or even call:

```
MatC(3, 3, x -> 1, Diagonal)
```

$$\begin{pmatrix} 1 & 0 & 0 \\ 0 & 1 & 0 \\ 0 & 0 & 1 \end{pmatrix}$$

The easiest way to create the identity matrix, however, is to use the method `"identity"`:

```
MatC::identity(3)
```

$$\begin{pmatrix} 1 & 0 & 0 \\ 0 & 1 & 0 \\ 0 & 0 & 1 \end{pmatrix}$$



## Example 7

Toeplitz matrices can be defined with the option `Banded`. The following call defines a three-banded matrix with the component 2 on the main diagonal and the component - 1 on the first subdiagonals:

```
densematrix(4, 4, [-1, 2, -1], Banded)
```

$$\begin{pmatrix} 2 & -1 & 0 & 0 \\ -1 & 2 & -1 & 0 \\ 0 & -1 & 2 & -1 \\ 0 & 0 & -1 & 2 \end{pmatrix}$$

## Example 8

Some system functions can be applied to matrices, such as `norm`, `expand`, `diff`, `conjugate`, or `exp`.

For example, to expand the components of the matrix:

```
delete a, b:
A := densematrix(
  [[(a - b)^2, a^2 + b^2], [a^2 + b^2, (a - b)*(a + b)]]
)
```

$$\begin{pmatrix} (a-b)^2 & a^2 + b^2 \\ a^2 + b^2 & (a+b)(a-b) \end{pmatrix}$$

enter:

```
expand(A)
```

$$\begin{pmatrix} a^2 - 2ab + b^2 & a^2 + b^2 \\ a^2 + b^2 & a^2 - b^2 \end{pmatrix}$$

If you want to differentiate the matrix components, then call for example:

```
diff(A, a)
```

$$\begin{pmatrix} 2a - 2b & 2a \\ 2a & 2a \end{pmatrix}$$

To substitute matrix components by some values, enter:

```
subs(A, a = 1, b = -1)
```

$$\begin{pmatrix} 4 & 2 \\ 2 & 0 \end{pmatrix}$$

The function `zip` can also be applied to matrices. The following call combines two matrices `A` and `B` by dividing each component of `A` by the corresponding component of `B`:

```
A := densematrix([[4, 2], [9, 3]]):
B := densematrix([[2, 1], [3, -1]]):
zip(A, B, `/`)
```

$$\begin{pmatrix} 2 & 2 \\ 3 & -3 \end{pmatrix}$$

The quoted character ``/`` is another notation for the function `_divide`, the functional form of the division operator `/`.

If one needs to apply a function to the components of a matrix, then use the function `map`. For example, to simplify the components of the matrix:

```
C := densematrix(
  [[sin(x)^2 + cos(x)^2, cos(x)*tan(x)],
  [(a^2 - b^2)/(a + b), 1]]
)
```

$$\begin{pmatrix} \cos(x)^2 + \sin(x)^2 & \cos(x) \tan(x) \\ \frac{a^2 - b^2}{a + b} & 1 \end{pmatrix}$$

call:

```
map(C, Simplify)
```

$$\begin{pmatrix} 1 & \sin(x) \\ a-b & 1 \end{pmatrix}$$

## Example 9

However, there may appear some unexpected results using the function `diff` in the context of matrices. The derivative of the following unspecified function `f` of a matrix is computed due to the chain rule:

```
diff(f(densematrix([[a*x^2, b], [c, d]])), x)
```

$$\begin{pmatrix} 2 a x f' \left( \begin{pmatrix} a x^2 & b \\ c & d \end{pmatrix} \right) & 0 \\ 0 & 0 \end{pmatrix}$$

Usually, the function `f` would implicitly be assumed to be scalar. Hence, the derivative of `f` should be scalar as well. In the above situation the chain rule is applied for differentiation: the inner function is the matrix containing the symbolic components `a*x^2`, `b`, `c` and `d`. Its derivative is computed by simply applying `diff` to each component of the matrix:

```
diff(densematrix([[a*x^2, b], [c, d]]), x)
```

$$\begin{pmatrix} 2 a x & 0 \\ 0 & 0 \end{pmatrix}$$

Finally, the exterior unspecified function `f` is implicitly assumed to be scalar, such that each component of the derivative of the inner function is multiplied by the exterior differentiation.

## Example 10

A column vector is represented as a  $2 \times 1$  matrix:

```
MatR := Dom::DenseMatrix(Dom::Real):  
v := MatR(2, 1, [1, 2])
```

$$\begin{pmatrix} 1 \\ 2 \end{pmatrix}$$

The dimension of this vector is:

```
MatR::matdim(v)
```

$$[2, 1]$$

Use `linalg::vecdim`, or even call `nops(v)` to get the length of a vector:

```
linalg::vecdim(v)
```

$$2$$

The  $i$ th component of this vector can be extracted in two ways: either by `v[i, 1]` or by `v[i]`:

```
v[1], v[2]
```

$$1, 2$$

We get the 2-norm of  $v$  by the following call:

```
norm(v, 2)
```

$$\sqrt{5}$$

## Parameters

**R**

A ring, i.e., a domain of category `Cat::Rng`; default is `Dom::ExpressionField()`

**Array**

A one- or two-dimensional array or harray

**Matrix**

A matrix, i.e., an element of a domain of category `Cat::Matrix`

**m, n**

Matrix dimension (positive integers)

**List**

A list of matrix components

**ListOfRows**

A list of at most  $m$  rows; each row given as a list of at most  $n$  matrix components

**f**

A function (Symbolic Math Toolbox) or a functional expression (Symbolic Math Toolbox) with two parameters (the row and column index)

**g**

A function or a functional expression with one parameter (the row index)

**Options****Diagonal**

Create a diagonal matrix

With the option `Diagonal`, diagonal matrices can be created with diagonal elements taken from a list on page 7-41, or computed by a function (Symbolic Math Toolbox) or a functional expression (Symbolic Math Toolbox).

`Dom::DenseMatrix(R)(m, n, List, Diagonal)` creates the  $m \times n$  diagonal matrix whose diagonal elements are the entries of `List`.

List must have at most  $\min(m, n)$  entries. If it has fewer elements, the remaining diagonal elements are set to zero.

The entries of List are converted into elements of the domain R. An error message is issued if one of these conversions fails.

`Dom::DenseMatrix(R)(m, n, g, Diagonal)` returns the matrix whose  $i$ th diagonal element is  $g(i, i)$ , where the index  $i$  runs from 1 to  $\min(m, n)$ .

The function values are converted into elements of the domain R. An error message is issued if one of these conversions fails.

### **Banded**

Create a banded Toeplitz matrix

`Dom::DenseMatrix(R)(m, n, List, Banded)` creates an  $m \times n$  banded Toeplitz matrix with the elements of List as entries. The number of entries of List must be odd, say  $2h + 1$ , and must not exceed  $n$ . The resulting matrix has bandwidth at most  $2h + 1$ .

A Toeplitz matrix is a matrix where the elements of each band are identical. See also "Example 7" on page 7-101 (Symbolic Math Toolbox).

All elements of the main diagonal of the created matrix are initialized with the middle element of List. All elements of the  $i$ th subdiagonal are initialized with the  $(h + 1 - i)$ th element of List. All elements of the  $i$ th superdiagonal are initialized with the  $(h + 1 + i)$ th element of List. All entries on the remaining sub- and superdiagonals are set to zero.

The entries of List are converted into elements of the domain R. An error message is issued if one of these conversions fails.

### **Entries**

"isSparse"	is always FALSE, as elements of <code>Dom::DenseMatrix(R)</code> use a dense representation of their matrix components.
"randomDimen"	is set to [10, 10]. See the method "random" below for details.

## Methods

### Mathematical Methods

#### **`_divide` — Divide matrices**

`_divide(A, B)`

An error message is issued if the dimensions of A and B do not match.

This method only exists if R is a commutative ring with a unit, i.e., a domain of category `Cat::Ring`.

This method overloads the function `_divide` for matrices, i.e., one may use it in the form  $A / B$ , or in functional notation: `_divide(A, B)`.

#### **`_invert` — Compute the inverse of a matrix**

`_invert(A, Normal = b)`

If the component ring R is the domain `Dom::Float`, a floating-point approximation of the inverse matrix is computed by the function `numeric::inverse`.

This method only exists if R is a domain of category `Cat::Ring`.

This method overloads the function `_invert` for matrices, i.e., one may use it in the form  $1/A$  or  $A^{-1}$ , or in functional notation: `_invert(A)`.

If `Normal = TRUE`, then the matrix inverse is always returned in a normalized form. For details about normalization, see `normal`. If `Normal = FALSE`, then the matrix inverse can appear in a normalized form, but normalization is not guaranteed. By default `Normal = TRUE`.

`Normal` affects the results only if a matrix contains variables or exact expressions, such as `sqrt(5)` or `sin(PI/7)`.

#### **`_mod` — Map the modulo operator to a matrix**

`_mod(A, n)`

`n` must be non-zero, and `a mod n` must be defined for every entry `a` of A.

This method overloads the function `mod` for matrices; one may use it in the form `A mod n`, or in functional notation: `_mod(A, n)`.

### **`_mult` — Multiply matrices by matrices, vectors and scalars**

`_mult(x, y)`

`_mult(x, y)`

If `y` is of the domain type `R` or can be converted into such an element, the corresponding scalar multiplication is computed.

Otherwise, `y` is converted into a matrix of the domain type of `x`. If this conversion fails, then this method calls the method "`_mult`" of the domain of `y` giving all arguments in the same order.

If `x` is a matrix of the same domain type as `y`, then the matrix product `x y` is computed. An error message is issued if the dimensions of the matrices do not match.

If `x` is of the domain type `R` or can be converted into such an element, the corresponding scalar multiplication is computed.

Otherwise, `x` is converted into a matrix of the domain type of `y`. If this conversion fails, then `FAIL` is returned.

This method handles more than two arguments by calling itself recursively with the first half of all arguments and the last half of all arguments. Then the product of these two results is computed with the system function `_mult`.

This method overloads the function `_mult` for matrices, i.e., one may use it in the form `x * y`, or in functional notation: `_mult(x, y)`.

### **`_negate` — Negate a matrix**

`_negate(A)`

This method overloads the function `_negate` for matrices, i.e., one may use it in the form `-A`, or in functional notation: `_negate(A)`.

### **`_plus` — Add matrices**

`_plus(A, B, ...)`



The arguments  $A$ ,  $B$ , ... are converted into matrices of the domain type `Dom::DenseMatrix(R)`. FAIL is returned if one of these conversions fails.

This method overloads the function `_plus` for matrices, i.e., one may use it in the form  $A + B$ , or in functional notation: `_plus(A, B)`.

### **`_power` — Integer power of a matrix**

`_power(A, n)`

If the power  $n$  is a negative integer then  $A$  must be nonsingular and  $R$  must be a domain of category `Cat::IntegralDomain`. Otherwise FAIL is returned.

If  $n$  is zero and the component ring  $R$  is a ring with no unit (i.e., of category `Cat::Rng`, but not of category `Cat::Ring`), FAIL is returned.

This method overloads the function `_power` for matrices, i.e., one may use it in the form  $A^n$ , or in functional notation: `_power(A, n)`.

### **`conjugate` — Complex conjugate of a matrix**

`conjugate(A)`

This method only exists if  $R$  implements the method "conjugate", which computes the complex conjugate of an element of the domain  $R$ .

This method overloads the function `conjugate` for matrices, i.e., one may use it in the form `conjugate(A)`.

### **`cos` — Cosine of a matrix**

`cos(A)`

If  $A$  is not square, an error message is issued. If the component domain of  $A$  does not allow the computation of `cos(elem)` for an arbitrary element `elem` of the component ring, FAIL is returned.

This method uses the function `numeric::expMatrix` for a floating-point approximation of the exponential of  $A$  if  $A$  is defined over the domain `Dom::Float`.

If some eigenvalues of  $A$  do not exist in  $R$  or cannot be computed, then FAIL is returned.

In the symbolic case the functions `exp` and `linalg::jordanForm` are called. The latter may not be able to compute the Jordan form of  $A$ . In this case `FAIL` is returned.

This method only exists if  $R$  is a domain of category `Cat::Field`.

This method overloads the function `cos` for matrices, i.e., one may use it in the form `cos(A)`.

### **diff — Differentiation of matrix components**

`diff(A, ...)`

This method only exists if  $R$  implements the method "`diff`".

This method overloads the function `diff` for matrices, i.e., one may use it in the form `diff(A, ...)`. See "Example 8" on page 7-101 (Symbolic Math Toolbox) and "Example 9" on page 7-103 (Symbolic Math Toolbox).

### **equal — Equality test of matrices**

`equal(A, B)`

Note that if  $R$  has the axiom `Ax::systemRep` then `normal` is used to simplify the components of  $A$  and  $B$  before testing their equality.

### **exp — Exponential of a matrix**

`exp(A, <t>)`

If  $A$  is not square, an error message is issued. If the component domain of  $A$  does not allow the computation of `exp(elem)` for an arbitrary element `elem` of the component ring, `FAIL` is returned.

This method uses the function `numeric::expMatrix` for a floating-point approximation of the exponential of  $A$  if  $A$  is defined over the domain `Dom::Float` and if  $t = 1$ .

If some eigenvalues of  $A$  do not exist in  $R$  or cannot be computed, then `FAIL` is returned.

In the symbolic case the function `linalg::jordanForm` is called, which may not be able to compute the Jordan form of  $A$ . In this case `FAIL` is returned.

This method only exists if  $R$  is a domain of category `Cat::Field`.

This method overloads the function `exp` for matrices, i.e., one may use it in the form `exp(A, ...)`.

### **expand — Expand matrix components**

`expand(A)`

This method only exists if `R` implements the method "expand", or if `R` has the axiom `Ax::systemRep` (in this case, the system function `expand` is used).

This method overloads the function `expand` for matrices, i.e., one may use it in the form `expand(A)`.

### **factor — Scalar-matrix factorization**

`factor(A)`

The factor `s` is the gcd of all components of the matrix `A`. Hence, this method only exists if `R` is of category `Cat::GcdDomain`.

This method overloads the function `factor` for matrices, i.e., one may use it in the form `factor(A)`.

### **float — Floating-point approximation of the matrix components**

`float(A)`

This method only exists if `R` implements the method "float".

---

**Note** Usually the floating-point approximations are not elements of `R`! For example, `Dom::Integer` implements such a method, but the floating-point approximation of an integer cannot be re-converted into an integer.

This method checks whether the resulting matrix can be converted into the domain type of `A` only if `testargs` returns `TRUE` (e.g., if one calls this method from the interactive level of `MuPAD`).

Otherwise, one has to take care that the matrix returned is compatible to its component ring.

---

**gaussElim — Gaussian elimination**`gaussElim(A)`

If the matrix is not square, i.e., the determinant of  $A$  is not defined, then the third entry of the list returned is the value `FAIL`.

This method only exists if the component ring  $R$  is an integral domain, i.e., a domain of category `Cat::IntegralDomain`.

If  $R$  has the method "`pivotSize`", then the pivot element of smallest size is chosen at every pivoting step, whereby `pivotSize` must return a positive integer representing the "size" of an element.

If no such method is defined, Gaussian elimination without a pivot strategy is applied to  $A$ .

If  $R$  has the axiom `Ax::efficientOperation("_invert")` and is of category `Cat::Field`, then ordinary Gaussian elimination is used. Otherwise, fraction-free elimination is performed on  $A$ .

If  $R$  implements the method "`normal`", it is used to simplify subsequent computations of the Gaussian elimination process.

Note that if  $R$  does not implement the method "`normal`", but the elements of  $R$  are represented by kernel domains, i.e.,  $R$  has the axiom `Ax::systemRep`, the system function `normal` is used instead.

**identity — Identity matrix**`identity(n)`

This method only exists if the component ring  $R$  is of category `Cat::Ring`, i.e., a ring with unit.

**int — Integration of matrix components**`int(A, ...)`

This method only exists if  $R$  implements the method "`int`".

This method overloads the system function `int` for matrices, i.e., one may use it in the form `int(A, ...)`.

**iszero — Test for zero matrices**

iszero(A)

Note that there may exist more than one representation of the zero matrix of a given dimension if R does not have `Ax::canonicalRep`.

If R implements the method `"normal"`, it is used to simplify the components of A for the zero-test.

Note that if R does not implement such a method, but the elements of R are represented by kernel domains, i.e., R has the axiom `Ax::systemRep`, the system function `normal` is used instead.

This method overloads the function `iszero` for matrices, i.e., one may use it in the form `iszero(A)`.

**matdim — Matrix dimension**

matdim(A)

**norm — Norm of matrices and vectors**

norm(A, Infinity)

norm(A, Maximum)

norm(v, Infinity)

norm(v, Maximum)

norm(A, Frobenius)

norm(A, 1)

norm(v, Euclidean)

norm(v, k)

`norm(A, Maximum)` computes the maximum norm of the matrix A, which is the maximum row sum (the row sum is the sum of norms of each component in a row).

If the domain R does not implement the methods `"max"` and `"norm"`, FAIL is returned.

Using `norm(v, Infinity)` for a vector `v` the maximum norm of all elements is returned.

If the domain `R` does not implement the methods `"max"` and `"norm"`, `FAIL` is returned.

Using `norm(v, Maximum)` for a vector `v` the maximum norm of all elements is returned.

If the domain `R` does not implement the methods `"max"` and `"norm"`, `FAIL` is returned.

`norm(A, Frobenius)` computes the Frobenius norm of `A`, which is the square root of the sum of the squares of the norms of each component.

If the result is no longer an element of the domain `R`, or if `R` does not implement the method `"norm"`, `FAIL` is returned.

`norm(A, 1)` computes the 1-norm of the matrix `A`, which is the maximum sum of the norms of the elements of each column. If `R` does not implement the methods `"max"` and `"norm"`, `FAIL` is returned.

`norm(v, Euclidean)` computes the Euclidean norm (2-norm) of the vector `v`, which is defined to be the square root of the sum of the norms of the elements of `v` raised to the square.

`FAIL` is returned if the result is no longer an element of the domain `R`. The function `linalg::scalarProduct` is used to compute the Euclidean norm of the vector `v`.

If `R` does not implement the method `"norm"`, `FAIL` is returned.

`norm(v, k)` computes the  $k$ -norm of the vector `v`, which is defined to be the  $k$ th root of the sum of the norms of the elements of `v` raised to the  $k$ th power.

`FAIL` is returned if the result is no longer an element of the domain `R`. For  $k = 2$ , the function `linalg::scalarProduct` is used to compute the 2-norm of `v`.

If `R` does not implement the method `"norm"`, `FAIL` is returned.

The method `norm` overloads the function `norm` for matrices, i.e., one may use it in the form `norm(A k)`, where `k` is either `Infinity`, `Frobenius`, or a positive integer. The default value of `k` is `Infinity`.

### **normal — Simplification of matrix components**

`normal(A)`

If  $R$  does not implement the method "normal", but the elements of  $R$  are represented by kernel domains, i.e.,  $R$  has the axiom  $Ax :: \text{systemRep}$ , then the system function `normal` is applied to the components of  $A$ . Otherwise `normal(A)` returns  $A$  without any changes.

This method overloads the function `normal` for matrices, i.e., one may use it in the form `normal(A)`.

### **nonZeros — Number of non-zero components of a matrix**

`nonZeros(A)`

### **nonZeroes — Number of non-zero components of a matrix**

`nonZeroes(A)`

### **nonZeroOperands — Return a sequence of all non-zero operands**

`nonZeroOperands(A)`

This method is useful for retrieving information on the non-zero entries. For example, to find out the types of the entries in the matrix, one should not consider all operands `op(A)`, because this would also involve the zero entries. For large matrices with few entries, it is much more efficient to use this method to extract the entries.

### **random — Random matrix generation**

`random()`

This method only exists if  $R$  implements the method "random".

The dimension of the matrix is also chosen randomly, but it is limited by the values given in "randomDimen" (see "Entries" above).

To change the value of the entry "randomDimen" for a domain `MatR` created with `Dom::DenseMatrix`, one must first unprotect the domain `Dom` (see `unprotect` for details).

### **sin — Sine of a matrix**

`sin(A)`

If  $A$  is not square, an error message is issued. If the component domain of  $A$  does not allow the computation of  $\sin(\text{elem})$  for an arbitrary element  $\text{elem}$  of the component ring, FAIL is returned.

This method uses the function `numeric::expMatrix` for a floating-point approximation of the exponential of  $A$  if  $A$  is defined over the domain `Dom::Float`.

If some eigenvalues of  $A$  do not exist in  $R$  or cannot be computed, then FAIL is returned.

In the symbolic case the functions `exp` and `linalg::jordanForm` are called. The latter may not be able to compute the Jordan form of  $A$ . In this case FAIL is returned.

This method only exists if  $R$  is a domain of category `Cat::Field`.

This method overloads the function `sin` for matrices, i.e., one may use it in the form `sin(A)`.

### **sqrt — Square root of a matrix**

`sqrt(A, <sqrtfunc>)`

Returned is a matrix  $B$  with  $B^2 = A$  such that the eigenvalues of  $B$  are the square roots of the eigenvalues of  $A$  or FAIL if the square root of the matrix does not exist. For computing the square roots of the eigenvalues a function satisfying  $\text{sqrtfunc}(a)^2 = a$  for every element  $a$  of the coefficient ring of  $A$  can be given as optional second argument.

For details we refer to the help page of the function `linalg::sqrtMatrix`.

### **testeq — Testing for equality of two matrices**

`testeq(A, B)`

### **tr — Trace of a square matrix**

`tr(A)`

If  $A$  is not square, then an error message is issued.

### **transpose — Transpose of a matrix**

`transpose(A)`



## Access Methods

### **`_concat` — Horizontal concatenation of matrices**

`_concat(A, B, ...)`

An error message is issued if the given matrices do not have the same number of rows.

This method overloads the function `_concat` for matrices, i.e., one may use it in the form `A . B . ...`, or in functional notation: `_concat(A, B, ...)`.

### **`_index` — Matrix indexing**

`_index(A, i, j)`

`_index(A, r1 .. r2, c1 .. c2)`

`_index(v, i)`

`_index(v, i1 .. i2)`

If `i` and `j` are not integers, then the call of this method returns in its symbolic form (of type "`_index`") with evaluated arguments.

Otherwise an error message is given, if `i` and `j` are not valid row and column indices, respectively.

---

**Note** Note that this method uses the system function `context` to evaluate the entry in the context of the calling environment.

---

`_index(A, r1 .. r2, c1 .. c2)` returns the submatrix of `A` created by the rows of `A` with indices from `r1` to `r2` and the columns of `A` with indices from `c1` to `c2`.

`_index(v, i)` returns the `i`th entry of the vector `v`.

An error message is issued if `v` is not a vector.

If `i` is not an integer, then the call of this method returns in its symbolic form (of type "`_index`") with evaluated arguments.

Otherwise an error message is given, if *i* is less than one or greater than the dimension of *v*.

---

**Note** Note that this method uses the system function `context` to evaluate the entry in the context of the calling environment.

---

`_index(v, i1..i2)` returns the subvector of *v*, formed by the entries with index *i1* to *i2*. See also the method "op".

An error message is issued if *v* is not a vector.

This method overloads the function `_index` for matrices, i.e., one may use it in the form `A[i, j]`, `A[r1..r2, c1..c2]`, `v[i]` and `v[i1..i2]`, respectively, or in functional notation: `_index(A, ...)`.

### **concatMatrix — Horizontal concatenation of matrices**

`concatMatrix(A, B, ...)`

### **col — Extracting a column**

`col(A, c)`

An error message is issued if *c* is less than one or greater than the number of columns of *A*.

### **delCol — Deleting a column**

`delCol(A, c)`

NIL is returned if *A* consists of only one column.

An error message is issued if *c* is less than one or greater than the number of columns of *A*.

### **delRow — Deleting a row**

`delRow(A, r)`

NIL is returned if *A* consists of only one row.

An error message is issued if *r* is less than one or greater than the number of rows of *A*.

**evalp — Evaluating matrices of polynomials at a certain point**

```
evalp(A, x = a, ...)
```

This method is only defined if R is a polynomial ring of category `Cat::Polynomial`.

This method overloads the function `evalp` for matrices, i.e., one may use it in the form `evalp(A, x = a)`.

**length — Length of a matrix**

```
length(A)
```

This method overloads the function `length` for matrices, i.e., one may use it in the form `length(A)`.

**map — Apply a function to matrix components**

```
map(A, func, <expr, ...>)
```

---

**Note** Note that the function values are converted into elements of the domain R only if `testargs` returns TRUE (e.g., if one calls this method from the interactive level of MuPAD).

If `testargs` returns FALSE, then one must guarantee that the function calls return elements of the domain type R, otherwise the resulting matrix, which is of domain type `Dom::DenseMatrix(R)`, would have components which are not elements of the domain R!

---

This method overloads the function `map` for matrices, i.e., one may use it in the form `map(A, func, ...)`.

**mapNonZeroes — Apply a function to the non-zero components of a matrix**

```
mapNonZeroes(A, f, <p1, p2, ...>)
```

**nops — Number of components of a matrix**

```
nops(A)
```

This method overloads the function `nops` for matrices, i.e., one may use it in the form `nops(A)`.

**op — Component of a matrix**

`op(A, i)`

`op(A)`

This method returns an expression sequence of all components of A.

See also the method "`_index`".

This method overloads the function `op` for matrices, i.e., one may use it in the form `op(A, i)` and `op(A)`, respectively.

**row — Extracting a row**

`row(A, r)`

An error message is issued if `r` is less than one or greater than the number of rows of A.

**setCol — Replacing a column**

`setCol(A, c, v)`

An error message is issued if `c` is less than one or greater than the number of rows of A.

**setRow — Replacing a row**

`setRow(A, r, v)`

An error message is issued if `r` is less than one or greater than the number of rows of A.

**stackMatrix — Vertical concatenation of matrices**

`stackMatrix(A, B, ...)`

An error message is issued if the given matrices do not have the same number of columns.

**subs — Substitution of matrix components**

`subs(A, ...)`

**Note** Note that the function values are converted into elements of the domain R only if `testargs` returns TRUE (e.g., if one calls this method from the interactive level of MuPAD).

If `testargs` returns FALSE, then one must guarantee that the function calls return elements of the domain type R, otherwise the resulting matrix, which is of domain type `Dom::DenseMatrix(R)`, would have components which are not elements of the domain R!

---

This method overloads the function `subs` for matrices, i.e., one may use it in the form `subs(A, ...)`.

### **subsex — Extended substitution of matrix components**

`subsex(A, ...)`

**Note** Note that the results of the substitutions are converted into elements of the domain R only if `testargs` returns TRUE (e.g., if one calls this method from the interactive level of MuPAD).

If `testargs` returns FALSE, then one must guarantee that the results of the substitutions are of the domain type R, otherwise the resulting matrix, which is of domain type `Dom::DenseMatrix(R)`, would have components which are not elements of the domain R!

---

This method overloads the function `subsex` for matrices, i.e., one may use it in the form `subsex(A, ...)`.

### **subsop — Operand substitution of matrix components**

`subsop(A, i = x, ...)`

**Note** Note that `x` is converted into the domain R only if `testargs` returns TRUE (e.g., if one calls this method from the interactive level of MuPAD).

If `testargs` returns FALSE, then `x` must be an element of R, otherwise the resulting matrix, which is of domain type `Dom::DenseMatrix(R)`, would have components which are not elements of the domain R!

---

See also the method "set\_index".

This method overloads the function `subsop` for matrices, i.e., one may use it in the form `subsop(A, ...)`.

### **swapCol — Swapping matrix columns**

```
swapCol(A, c1, c2)
```

```
swapCol(A, c1, c2, r1 .. r2)
```

An error message is issued if one of the column indices is less than one or greater than the number of columns of `A`.

`swapCol(A, c1, c2, r1 .. r2)` swaps the column with index `c1` and the column with index `c2` of `A`, but by taking only those column components which lie in the rows with indices `r1` to `r2`.

An error message is issued if one of the column indices is less than one or greater than the number of columns of `A`, or if one of the row indices is less than one or greater than the number of rows of `A`.

### **swapRow — Swapping matrix rows**

```
swapRow(A, r1, r2)
```

```
swapRow(A, r1, r2, c1 .. c2)
```

An error message is issued if one of the row indices is less than one or greater than the number of rows of `A`.

`swapRow(A, r1, r2, c1 .. c2)` swaps the row with index `r1` and the row with index `r2` of `A`, but by taking only those row components which lie in the columns with indices `c1` to `c2`.

An error message is issued if one of the row indices is less than one or greater than the number of rows of `A`, or if one of the column indices is less than one or greater than the number of columns of `A`.

### **set\_index — Setting matrix components**

```
set_index(A, i, j, x)
```

`set_index(v, i, x)`

---

**Note** Note that `x` is converted into an element of the domain `R` only if `testargs` returns `TRUE` and `i` and `j` are integers (e.g., if one calls this method from the interactive level of MuPAD). If `x` is a matrix of the same type as `A` or can be converted into a matrix of the same type as `A` and the indices `i` or `j` are ranges corresponding to a submatrix of `A`, then `x` replaces the corresponding submatrix in `A`.

Otherwise one has to take care that `x` is of domain type `R`.

---

See also the method "subsop".

`set_index(v, i, x)` replaces the `i`th entry of the vector `v` by `x`.

`set_index` on vectors overloads the function `set_index` for matrices, i.e., one may use it in the form `A[i, j] := x` and `v[i] := x`, respectively, or in functional notation: `A := set_index(A, i, j, x)` or `v := set_index(v, i, x)`.

### **zip – Combine matrices component-wise**

`zip(A, B, func, <expr, ...>)`

The row number of the matrix returned is the minimum of the row numbers of `A` and `B`, and its column number is the minimum of the column numbers of `A` and `B`.

---

**Note** Note that the function values are converted into elements of the domain `R` only if `testargs` returns `TRUE` (e.g., if one calls this method from the interactive level of MuPAD).

If `testargs` returns `FALSE`, then one must guarantee that the function calls return elements of the domain type `R`, otherwise the resulting matrix, which is of domain type `Dom::DenseMatrix(R)`, would have components which are not elements of the domain `R`!

---

This method overloads the function `zip` for matrices, i.e., one may use it in the form `zip(A, B, ...)`.

## Conversion Methods

### **convert — Conversion to a matrix**

`convert(x)`

FAIL is returned if the conversion fails.

`x` may either be an array, a matrix, or a list (of sublists, see the parameter `ListOfRows` in “Creating Elements” above). Their entries must then be convertible into elements of the domain `R`.

### **convert\_to — Matrix conversion**

`convert_to(A, T)`

`T` may either be `DOM_ARRAY`, `DOM_LIST`, or a domain constructed by `Dom::DenseMatrix` or `Dom::SquareMatrix`. The elements of `A` must be convertible into elements of the domain `R`.

Use the function `expr` to convert `A` into an object of a kernel domain (see below).

### **create — Defining matrices without component conversions**

`create(x, ...)`

This method works more efficient than if one creates matrices by calling the method “new” of the domain, because it avoids any conversion of the components. One must guarantee that the components have the correct domain type, otherwise run-time errors can be caused.

If `x` is a list of sublists, it might be a good idea first to create a two-dimensional array from that list before calling this method. This is due to the fact that creating a matrix from an array on page 7-2 is the fastest way one can achieve.

Please note that when creating a two-dimensional array from a list of sublists, the sublists must have the same number of elements.

### **expr — Matrix conversion into an object of a kernel domain**

`expr(A)`



The result is an array representing the matrix  $A$  where each entry is an object of a kernel domain.

This method overloads the function `expr` for matrices, i.e., one may use it in the form `expr(A)`.

### **expr2text — Matrix conversion to a string**

`expr2text(A)`

This method overloads the function `expr2text` for matrices, i.e., one may use it in the form `expr2text(A)`.

## **Technical Methods**

### **assignElements — Multiple assignment to matrices**

`assignElements(A, ...)`

The assigned components must have the domain type  $R$ , an implicit conversion of the components into elements of domain type  $R$  is not performed.

This method overloads the function `assignElements` for matrices, i.e., one may use it in the form `assignElements(A, ...)`.

### **mkDense — Conversion of a matrix to an array**

`mkDense(Array)`

`mkDense(List)`

`mkDense(r, c, List)`

`mkDense(List)` tries to convert the list `List` into an array `a`. The result is either `FAIL` if this is not possible, or the list `[r, c, a]`, where the positive integers `r` and `c` give the dimension of `a`. See the parameters `List` and `ListOfRows` in “Creating Elements” above for admissible formats of `List`.

The array `a` has dimension one if `r` or `c` is equal to one. The entries of `a` have been converted into elements of the domain  $R$ .

`mkDense(r, c, List)` tries to convert the list `List` into an array `a` of the dimension `r` times `c`.

The result is either `FAIL` if this is not possible, or the list `[r, c, a]`.

The array `a` has dimension one if `r` or `c` is equal to one. The entries of `a` have been converted into elements of the domain `R`.

### **print — Printing matrices**

```
print(A)
```

---

**Note** Note that in general it is not useful to print very large matrices. Hence, a warning message is displayed if the size of the matrix oversteps a certain dimension - printing such matrices can be done by using the function "doprint".

---

### **doprint — Printing very large matrices**

```
doprint(A)
```

### **unapply — Create a procedure from a matrix**

```
unapply(A, <x, ...>)
```

This method overloads the function `fp::unapply` for matrices, i.e., one may use it in the form `fp::unapply(A)`.

## **See Also**

### **MuPAD Domains**

`Dom::Matrix` | `Dom::MatrixGroup` | `Dom::SquareMatrix`

# Dom::DihedralGroup

Dihedral groups

## Syntax

### Domain Creation

Dom::DihedralGroup( $n$ )

### Element Creation

Dom::DihedralGroup( $n$ )( $l$ )

## Description

### Domain Creation

Dom::DihedralGroup( $n$ ) creates the dihedral group of size  $n$ , i.e., the group of symmetries of a regular polygon with  $n$  edges.

Dom::DihedralGroup( $n$ ) creates the group of all congruent mappings of the plane that induce a bijective mapping of the set of corners of a regular  $n$ -angle to itself.

### Element Creation

Dom::DihedralGroup( $n$ )( $[a, b]$ ) represents the group element " $t^a$  carried out after  $r^b$ ", where  $r$  is a rotation that maps each corner to its left neighbor, and  $t$  is a reflection w.r.t. some fixed central diagonal.

## Superdomain

Dom::BaseDomain

## Axioms

`Ax::canonicalRep`

## Categories

`Cat::Group`

## Examples

### Example 1

Define the group  $D_6$ , i.e., the group of congruence mappings of the hexagon:

```
G := Dom::DihedralGroup(6)
```

```
Dom::DihedralGroup(6)
```

Then elements may be created as follows:

```
a := G([7, 19]);
```

```
[1, 1]
```

This means that 19 rotations—mapping each corner to its left neighbor—and 7 reflections have the same effect as one operation of either type.

## Parameters

**n**

Positive integer

**l**

List or array of two integers

## Entries

"size"	the number of elements, which equals $2n$ .
"one"	the mapping leaving each point fixed.

## Methods

### Mathematical Methods

**\_mult — Functional composition of elements**

`_mult(a, ...)`

This method overloads the kernel function `_mult`.

**\_invert — Inverse of an element**

`_invert(a)`

This method overloads the kernel function `_invert`.

**\_power — Power of an element**

`_power(a, n)`

It overloads the kernel function `_power`.

**order — Order of a group element**

`order(a)`

**random — Random element**

`random()`

## Conversion Methods

**expr** — Convert group element to list

expr(a)

**equiv** — Test for equivalence

Inherited from `Cat::BaseCategory`.

**new** — Create element of this domain

Inherited from `Cat::BaseCategory`.

**coerce** — Coerce into this domain

Inherited from `Cat::BaseCategory`.

**hasProp** — Test for a certain property

Inherited from `Dom::BaseDomain`.

**whichEntry** — Return the domain or category implementing an entry

Inherited from `Dom::BaseDomain`.

**isone** — Test if element is one

Inherited from `Cat::Monoid`.

**printMethods** — Print out methods

Inherited from `Dom::BaseDomain`.

**info** — Print short information about this domain

Inherited from `Dom::BaseDomain`.

**\_divide** — Return quotient

Inherited from `Cat::Group`.

**getAxioms — Return axioms stated in the constructor**

Inherited from Dom::BaseDomain.

**getCategories — Return categories stated in the constructor**

Inherited from Dom::BaseDomain.

**equal — Test for mathematical equality**

Inherited from Dom::BaseDomain.

**allAxioms — Return all axioms**

Inherited from Dom::BaseDomain.

**undefinedEntries — Return missing entries**

Inherited from Dom::BaseDomain.

**allCategories — Return all categories**

Inherited from Dom::BaseDomain.

**testtype — Test type of object**

Inherited from Cat::BaseCategory.

**allEntries — Return the names of all entries**

Inherited from Dom::BaseDomain.

**getSuperDomain — Return super-domain stated in the constructor**

Inherited from Dom::BaseDomain.

**subs — Avoid substitution**

Inherited from Dom::BaseDomain.

**allSuperDomains — Return all super-domains**

Inherited from Dom::BaseDomain.

**subsex — Avoid extended substitution**

Inherited from Dom: :BaseDomain.



# Dom::DistributedPolynomial

Domains of distributed polynomials

## Syntax

### Domain Creation

```
Dom::DistributedPolynomial(<Vars, <R, <Order>>>)
```

### Element Creation

```
Dom::DistributedPolynomial(Vars, R, Order)(p)
```

```
Dom::DistributedPolynomial(Vars, R, Order)(lm)
```

```
Dom::DistributedPolynomial(Vars, R, Order)(lm, v)
```

## Description

`Dom::DistributedPolynomial(Vars, R, ..)` creates the domain of polynomials in the variables of the list `Vars` over the commutative ring `R` in distributed representation.

`Dom::DistributedPolynomial(Vars, R, Order)` creates a domain of polynomials in the variables of the list `Vars` over a domain of category `Cat::CommutativeRing` in sparse distributed representation with respect to the monomial ordering `Order`.

If `Dom::DistributedPolynomial` is called without any argument, a polynomial domain in arbitrarily many indeterminates over the domain `Dom::ExpressionField(normal)` with respect to the lexicographic monomial ordering is created.

If `Dom::DistributedPolynomial` is called only with the variable list `Vars` as argument, the polynomial domain in the variable list `Vars` over the domain `Dom::ExpressionField(normal)` with respect to the lexicographic monomial ordering is created.

---

**Note** Only commutative coefficient rings of type `DOM_DOMAIN` are allowed which inherit from `Dom::BaseDomain`. If `R` is of type `DOM_DOMAIN` but does not inherit from `Dom::BaseDomain`, the domain `Dom::ExpressionField(normal)` will be used instead.

---

`Dom::DistributedPolynomial` accepts expressions as indeterminates, similar to the kernel domain `DOM_POLY`. Hence, for example, `[x, cos(x)]` is a valid variable list.

If the variable list `Vars` is the empty list (`[]`), a polynomial domain in arbitrarily many indeterminates is created. In this case, when creating new elements from polynomials or polynomial expressions, the system function `indets` is first called to get the variables and then the polynomial is created with respect to these variables. Hence, in this case only identifiers can be valid indeterminates, because `indets` returns only identifiers.

It is not allowed to create polynomial domains in arbitrarily many indeterminates over another polynomial domain of category `Cat::Polynomial`, but it is possible to create multivariate polynomial domains with a given list of variables over any polynomial domain.

`Dom::DistributedPolynomial` represents polynomials over arbitrary commutative rings. It is intended as a basic domain for distributed polynomials from which it is easy to create new distributed polynomial domains.

All usual algebraic and arithmetical polynomial operations are implemented, including Gröbner basis computation.

---

**Note** It is highly recommended to use only coefficient rings with unique zero representation. Otherwise it can happen that, e.g., a polynomial division will not terminate or a wrong degree will be returned.

---

Please note that for reasons of efficiency not all methods check their arguments, not even at the interactive level. In particular this is true for many access methods, converting methods and technical methods.

## Superdomain

`Dom::BaseDomain`

## Axioms

If R has `Ax::normalRep`, then `Ax::normalRep`.

If R has `Ax::canonicalRep`, then `Ax::canonicalRep`.

## Categories

If `Vars` has exactly one variable, then `Cat::UnivariatePolynomial(R)`, else `Cat::Polynomial(R)`.

## Examples

### Example 1

The following call creates a polynomial domain in  $x$ ,  $y$  and  $z$ .

```
DP := Dom::DistributedPolynomial([x, y, z])
```

```
Dom::DistributedPolynomial([x, y,
z], Dom::ExpressionField(normal, iszero ◦ normal), LexOrder)
```

Since neither the coefficient ring nor the monomial ordering was specified, this domain is created with the default values for these parameters.

It is rather easy to create elements of this domain, as e.g.

```
a := DP(x + 2*y*z + 3)
```

```
x + 2 y z + 3
```

```
b := DP(z^4 - 2*y^2*x^2)
```

```
-2 x^2 y^2 + z^4
```

In contrast to expressions all elements of this domain have a representation which is fixed by the chosen Order, the representation of the coefficient ring R and the way of representing monomials.

With these elements one can now perform usual arithmetic operations as, e.g., (scalar) multiplication, multiplication with integers and adding polynomials and ring elements:

$$4*b^2 + a/3 + 1/2$$

$$16x^4y^4 - 16x^2y^2z^4 + \frac{x}{3} + \frac{2yz}{3} + 4z^8 + \frac{3}{2}$$

There are a lot of methods for manipulating polynomials and to get access to all parts of a polynomial. For example one has access to the leading monomial of a as follows:

`lmonomial(a)`

$x$

The leading monomial of a polynomial depends on the monomial ordering, so with respect to the degree order one gets a different result:

`lmonomial(a, DegreeOrder)`

$2yz$

To get a minus its leading monomial one may call:

`DP::reductum(a)`

$2yz + 3$

Obviously the following identity holds:

`a - lmonomial(a) - DP::reductum(a)`

$0$

There are also methods for converting elements of this domain into other domains, like a basic polynomial domain or the domain of arbitrary expressions:

```
poly(a), domtype(poly(a))
```

```
poly(x + 2 y z + 3, [x, y, z], Dom::ExpressionField(normal, iszero ◦ normal)), DOM_POLY
```

```
expr(b), domtype(expr(b))
```

```
z4 - 2 x2 y2, DOM_EXPR
```

## Parameters

### Vars

A list of indeterminates. Default is [] (the empty list, indicating “arbitrary indeterminates”).

### R

A commutative ring, i.e., a domain of category `Cat::CommutativeRing`. Default is `Dom::ExpressionField(normal)`.

### Order

A monomial ordering, i.e., one of the predefined orderings `LexOrder`, `DegreeOrder` or `DegInvLexOrder` or any object of type `Dom::MonomOrdering`. Default is `LexOrder`.

### p

A polynomial or a polynomial expression.

### lm

List of monomials, which are represented as lists containing the coefficients together with the exponents or exponent vectors.

### v

List of indeterminates. This parameter is only valid for `Vars = []`.

## Entries

"characteristic"	The characteristic of this domain.
"coeffRing"	The coefficient ring of this domain as defined by the parameter R.
"key"	The name of the created domain.
"one"	The neutral element w.r.t. "_mult".
"ordering"	The monomial order as defined by the parameter Order.
"variables"	The list of variables as defined by the parameter Vars.
"zero"	The neutral element w.r.t. "_plus".

## Methods

### Mathematical Methods

#### **`_divide` — Exact polynomial division**

```
_divide(a, b)
```

```
_divide(a, b)
```

```
_divide(a, b)
```

It overloads the function `_divide` for polynomials, i.e., one may use it either in the form  $a / b$ , or in functional form `_divide(a, b)`.

---

**Note** This method only exists if R is an integral domain, i.e., a domain of category `Cat::IntegralDomain`.

---

#### **`_invert` — Inverse of an element**

```
_invert(a)
```

**\_mult — Multiplie polynomials and coefficient ring elements**`_mult(<a, b, ...>)`

This method overloads the function `_mult` for polynomials, i.e., one may use it either in the form `a * b * ...` or in functional notation `_mult(a, b, ...)`.

**\_negate — Negate a polynomial**`_negate(a)`

This method overloads the function `_negate` for polynomials, i.e., one may use it either in the form `-a` or in functional notation `_negate(a)`.

**\_plus — Add polynomials and coefficient ring elements**`_plus(<a, b, ...>)`

This method overloads the function `_plus` for polynomials, i.e., one may use it either in the form `a + b + ...` or in functional notation `_plus(a, b, ...)`.

**\_power — Nth power of a polynomial**`_power(a, n)`

This method overloads the function `_power` for polynomials, i.e., one may use it either in the form `a^n` or in functional notation `_power(a, n)`.

**\_subtract — Subtract a polynomial or a coefficient ring element**`_subtract(a, b)`

This method overloads the function `_subtract` for polynomials, i.e., one may use it either in the form `a - b` or in functional notation `_subtract(a, b)`.

**associates — Test if elements are associates**

Inherited from `Cat::IntegralDomain`.

**content — Content of a polynomial**`content(a)`

---

**Note** This method only exists if R is a domain of category `Cat::GcdDomain`.

---

**D – Differential operator for polynomials**

`D(a)`

`D(l, a)`

**Dpoly – Differential operator for polynomials**

`Dpoly(a)`

`Dpoly(l, a)`

`Dpoly(l, a)` computes the partial derivative of `a` with respect to `l`. For details see `polylib::Dpoly`.

This method overloads the function `polylib::Dpoly` for polynomials.

**decompose – Functional decomposition of a polynomial**

`decompose(a, <var>)`

If `a` is a polynomial in only one variable, the second argument is not necessary.

This method overloads the function `polylib::decompose` for polynomials.

**diff – Differentiate a polynomial**

`diff(a, varseq)`

If `varseq` is an empty sequence, `a` is returned unchanged.

If in `varseq` an expression occurs which is not a variable of `a`, the zero polynomial is returned.

This method overloads the function `diff` for polynomials.

**dimension – Dimension of affine variety**

`dimension(ais, <ord>)`

`dimension(ais, <ord>)`



This method is merely an interface for the function `groebner::dimension`.

---

**Note** This method only exists if  $R$  is a field, i.e., a domain of category `Cat::Field` and `Vars` is not the empty list.

---

### **divide — Divide polynomials**

`divide(a, b, <Quo | Rem | Exact>)`

`divide(a, b, var, <Quo | Rem | Exact>)`

If no option is given, the quotient  $s$  and the remainder  $r$  are computed such that  $a = s*b + r$  and the degree of  $r$  in the relevant indeterminate is smaller than that of  $b$ . The sequence consisting of  $s, r$  is returned, otherwise `FAIL`.

If the option `Quo` is given, only the quotient  $s$  is returned.

If the option `Rem` is given, only the remainder  $r$  is returned.

If the option `Exact` is given, only the quotient  $s$  is returned, in case the remainder is zero, otherwise `FAIL`.

`divide(a, b, Exact)` divides the multivariate polynomial  $a$  by  $b$ . If  $a$  cannot be divided by  $b$ , the method returns `FAIL`.

This method overloads the function `divide` for polynomials.

---

**Note** This method only exists if  $R$  is a field, i.e., a domain of category `Cat::Field` and either this domain is of category `Cat::UnivariatePolynomial(R)` or  $R$  has characteristic zero (`R::characteristic = 0`). If the first pair of conditions is true then the first call is valid otherwise the second one.

---

### **divides — Test if elements divides another**

Inherited from `Cat::IntegralDomain`.

### **equal — Test for mathematical equality**

Inherited from `Dom::BaseDomain`.

**equiv** — Test for equivalence

Inherited from `Cat::BaseCategory`.

**evalp** — Evaluate a polynomial

`evalp(a, var = e)`

This method overloads the function `evalp` for polynomials.

**factor** — Factor a polynomial

`factor(a)`

This method overloads the function `factor` for polynomials.

---

**Note** This method only exists if `R` is a domain of category `Cat::Field` or if `R` is the domain `Dom::Integer`.

---

**func\_call** — Apply expressions to a polynomial

`func_call(a, e1, ..., en, <Expr>)`

`func_call(a, e1, ..., en, <Expr>)`

`func_call(a, e1, ..., en, <Expr>)`

`a(e1, ..., en)` applies the sequence `e1, ..., en` of either elements of this domain or elements of `R` with respect to `Vars` (where `n` is the number of variables) to the polynomial `a`. An element of this domain or an element of the coefficient ring respectively is returned.

`a(e1, ..., en, Expr)` applies the sequence of expressions or of elements of this domain or of elements of `R` to the polynomial `a`. With this call `a` is first converted into an expression. Afterwards `e1, ..., en` is substituted into this expression with respect to `Vars`. The return value may be any object.

The number of variables must be equal to the number of applied expressions.

---

**Note** This method only exists if `Vars` has at least one indeterminate.

---

**gcd — Greatest common divisor of polynomials**`gcd(a, b, ...)`

This method overloads the function `gcd` for polynomials.

---

**Note** This method only exists if `R` is a domain of category `Cat::GcdDomain`.

---

**gcdex — Extended Euclidean algorithm for polynomials**`gcdex(a, b)`

This method overloads the function `gcdex` for polynomials. Especially, it only works for coefficient rings described there.

---

**Note** This method only exists if `R` is a domain of category `Cat::GcdDomain`.

---

**groebner — Reduced Gröbner basis**`groebner(ais, <ord>, <Reorder>)``groebner(ais, <ord>, <Reorder>)`

If the option `Reorder` is given, the lexicographical order of variables may change to another one that is likely to decrease the running time.

---

**Note** Note that this may also cause a change of the returned list, which may now have polynomials over the same coefficient ring `R` but with a possibly re-ordered variable list. Thus, it may contain elements *not* belonging to this domain.

---

This method is merely an interface for the function `groebner::gbasis`.

---

**Note** This method only exists if `R` is a field, i.e., a domain of category `Cat::Field`, and `Vars` is not the empty list.

---

**idealGenerator — Generator of finitely generated ideal**

Inherited from `Cat::EuclideanDomain`.

**int — Definite and indefinite integration of a polynomial**

`int(a, <x>)`

`int(a, <x = x0 .. x1>)`

`int(a, x=x0..x1)` returns the definite integral  $\int_{x_0}^{x_1} a \, dx$  or FAIL, if the result is not an element of this domain or an element of a polynomial domain over `Dom::Fraction(R)`.

This method overloads the function `int` for polynomials.

**intmult — Multiplie a polynomial with an integer**

`intmult(a, z)`

This method is more efficient than using polynomial multiplication and is, e.g., necessary for the method "Dpoly".

**irreducible — Test if element is irreducible**

Inherited from `Cat::FactorialDomain`.

**isUnit — Test if element is a unit**

Inherited from `Cat::Polynomial`.

**isone — Test for one**

`isone(a)`

---

**Note** The result can only be valid if the coefficients of `a` are in normal form (i.e., if zero has a unique representation in `R`). Thus, `R` should have at least `Ax::normalRep`.

---

**iszero — Test for zero**

`iszero(a)`

---

**Note** The result can only be valid, if the coefficients of `a` are in normal form (i.e., if zero has a unique representation in `R`). Thus, the coefficient ring `R` should have at least `Ax::normalRep`.

---

### **lcm — Least common multiple of polynomials**

`lcm(a, b, ...)`

This method overloads the function `lcm` for polynomials.

---

**Note** This method only exists if `R` is a domain of category `Cat::GcdDomain`.

---

### **makeIntegral — Make the coefficients fraction free**

`makeIntegral(a)`

---

**Note** This method only exists if `R` is a domain of category `Cat::GcdDomain` and `R` has the method "denom".

---

### **monic — Normalize a polynomial**

`monic(a)`

The zero polynomial returns itself.

---

**Note** This method only exists if `R` is a field, i.e., a domain of category `Cat::Field`.

---

### **normalForm — Complete reduction modulo an ideal**

`normalForm(a, ais, <ord>)`

`normalForm(a, ais, <ord>)`

This method is merely an interface for the function `groebner::normalf`.

---

**Note** This method only exists if  $R$  is a field, i.e., a domain of category `Cat::Field`, and `Vars` is not the empty list.

---

**pdioe — Solve polynomial Diophantine equations**

`pdioe(a, b, c)`

This method overloads the function `solveLib::pdioe`.

---

**Note** This method only exists if  $R$  is a field, i.e., a domain of category `Cat::Field` and `Vars` consists of a single variable.

---

**pdivide — Pseudo-division of polynomials**

`pdivide(a, b, <Quo | Rem>)`

If the option `Quo` is given, only the pseudo-quotient  $q$  is returned.

If the option `Rem` is given, only the pseudo-remainder  $r$  is returned.

This method overloads the function `pdivide` for polynomials.

---

**Note** This method only exists if `Vars` consists of a single variable.

---

**pquo — Pseudo-quotient of polynomials**

`pquo(a, b)`

---

**Note** This method only exists if `Vars` consists of a single variable.

---

**prem — Pseudo-remainder of polynomials**

`prem(a, b)`

---

**Note** This method only exists if `Vars` consists of a single variable.

---

**primpart — Return primitive part**

Inherited from `Cat::Polynomial`.

**quo — Euclidean quotient**

Inherited from `Cat::EuclideanDomain`.

**random — Create a random polynomial**

`random()`

With every call the global variable `SEED` is changed by a call of `random()`. Thus it is hard to create the same random sequence twice, see `random`.

If the parameter `Vars` is the empty list, first a list of 1 to 4 variables is generated randomly and the random polynomial is generated in these indeterminates afterwards.

This method overloads the function `polylib::randpoly` for polynomials.

**rem — Euclidean remainder**

Inherited from `Cat::EuclideanDomain`.

**resultant — Resultant of two polynomials**

`resultant(a, b, <var>)`

`resultant(a, b, var)` returns the resultant of `a` and `b` with respect to the variable `var`.

The value returned is a polynomial of this domain or `FAIL`.

This method overloads the function `polylib::resultant` for polynomials.

---

**Note** This method only exists if `R` has the method `"_divide"`.

---

**ringmult — Multiplie a polynomial with a coefficient ring element**

`ringmult(a, c)`

**solve — Zero of polynomials**

`solve(a, <var>, <options>)`

`solve(a, <vars>, <options>)`

`solve(ais, <var>, <options>)`

`solve(ais, <vars>, <options>)`

`solve(ais, ..)` tries to find the zeros of the polynomial system `ais`. The exact behavior depends on further arguments.

For a detailed description of possible return values and options see function `solve`.

This method overloads the function `solve`.

**SPolynomial — Compute the S-polynomial of two polynomials**

`SPolynomial(a, b, <ord>)`

This method is merely an interface for the function `groebner::spoly`.

---

**Note** This method only exists if  $R$  is a field, i.e., a domain of category `Cat::Field`, and `Vars` is not the empty list.

---

**sqrfree — Square-free factorization of polynomials**

`sqrfree(a)`

The `ai` are primitive and pairwise different square-free divisors of `a` and represented as elements of this domain. `u` is a unit of the coefficient ring and represented as an element of this domain. The `ei` are integers.

This method overloads the function `polylib::sqrfree` for polynomials.

---

**Note** This method only exists if  $R$  is a field, i.e., a domain of category `Cat::Field`, or if  $R$  is `Dom::Integer`.

---



**unitNormal — Return unit normal**

Inherited from `Cat::Polynomial`.

**unitNormalRep — Return unit normal representation**

Inherited from `Cat::Polynomial`.

## Access Methods

**coeff — Coefficient of a polynomial**

`coeff(a)`

`coeff(a, var, n)`

`coeff(a, n)`

`coeff(a, var, n)` returns the coefficient of the term  $\text{var}^n$ —as an element of this domain if it is of category `Cat::Polynomial(R)`, or as an element of the coefficient ring `R` if it is of `Cat::UnivariatePolynomial(R)`, where `a` is considered as a univariate polynomial in a valid variable `var`.

`coeff(a, n)` returns the coefficient of the term  $\text{var}^n$ —as an element of this domain if it is of category `Cat::Polynomial(R)`, or as an element of the coefficient ring `R` if it is of `Cat::UnivariatePolynomial(R)`, where `a` is considered as a univariate polynomial in `var` and `var` is the main variable of `a`, i.e., the variable returned by `dom::mainvar(a)`.

This method overloads the function `coeff` for polynomials.

**degree — Degree of a polynomial**

`degree(a)`

`degree(a, var)`

`degree(a, var)` returns the degree of `a` with respect to `var`.

The degree of the zero polynomial is defined as zero.

This method overloads the function `degree` for polynomials.

**degreevec — Vector of exponents of the leading term of a polynomial**`degreevec(a, <ord>)`

The degree vector of the zero polynomial is defined as a list of zeros.

This method overloads the function `degreevec` for polynomials.

**euclideanDegree — Euclidean degree function**`euclideanDegree(a)`

---

**Note** This method only exists if `Vars` consists of a single variable.

---

**ground — Ground term of a polynomial**`ground(a)`

This method overloads the function `ground` for polynomials.

**has — Existence of an object in a polynomial**`has(a, obj)`

This method overloads the function `has`.

**indets — Indeterminate of a polynomial**`indets(<a>)`

In case `Vars` is not the empty list, `indets` can be called without argument.

Since this domain allows expressions as indeterminates, the returned set may contain expressions, too.

This method overloads the function `indets` for polynomials.

**lcoeff — Leading coefficient of a polynomial**`lcoeff(a)``lcoeff(a, <vars>, <ord>)`

`lcoeff(a, ord)` returns the leading coefficient of `a` with respect to the monomial ordering `ord` as an element of the coefficient ring `R`.

`lcoeff(a, vars, ord)` returns the leading coefficient of `a` with respect to the variable list `vars` and the monomial ordering `ord` as an element of this domain if it is of category `Cat::Polynomial(R)`, or as an element of the coefficient ring `R` if it is of `Cat::UnivariatePolynomial(R)`.

- If `ord` is not explicitly given, the lexicographical order `LexOrder` will be used instead.
- It tries to convert `a` into a polynomial in the specified list of indeterminates `vars` over the coefficient ring `R` and returns `FAIL` if this conversions fails.

This method overloads the function `lcoeff` for polynomials.

### **ldegree — Lowest degree of a polynomial**

`ldegree(a)`

`ldegree(a, x)`

`ldegree(a, x)` returns the lowest degree of the variable `x` in `a`.

This method overloads the function `ldegree` for polynomials.

### **lmonomial — Leading monomial of a polynomial**

`lmonomial(a, <ord>)`

`lmonomial(a, <vars>, <ord>, <Rem>)`

`lmonomial(a, vars, ord)` returns the leading monomial of `a` with respect to the variable list `vars` and the monomial ordering `ord` as an element of this domain.

- If `ord` is not explicitly given, the lexicographical order `LexOrder` will be used instead.
- It tries to convert `a` into a polynomial in the specified list of indeterminates `vars` over the coefficient ring `R` and returns `FAIL` if this conversions fails.

`lmonomial(a, vars, ord, Rem)` returns the list consisting of the leading monomial and the reductum of `a` with respect to the variable list `vars` and the monomial ordering `ord` as a list of elements of this domain.

- If `ord` is not explicitly given, the lexicographical order `LexOrder` will be used instead.

- It tries to convert `a` into a polynomial in the specified list of indeterminates `vars` over the coefficient ring `R` and returns `FAIL` if this conversions fails.

---

**Note** In MuPAD a monomial denotes a coefficient together with a power product as, e.g.,  $3x^2$ .

---

This method overloads the function `lmonomial` for polynomials.

### **lterm — Leading term of a polynomial**

`lterm(a)`

`lterm(a, <vars>, <ord>)`

`lterm(a, ord)` returns the leading coefficient of `a` with respect to the monomial ordering `ord` as an element of this domain.

`lterm(a, vars, ord)` returns the leading term of `a` with respect to the variable list `vars` and the monomial ordering `ord` as an element of this domain.

- If `ord` is not explicitly given, the lexicographical order `LexOrder` will be used instead.
- It tries to convert `a` into a polynomial in the specified list of indeterminates `vars` over the coefficient ring `R` and returns `FAIL` if this conversions fails.

---

**Note** In MuPAD a term denotes a power product without a coefficient as, e.g.,  $x^2y^3z$ .

---

This method overloads the function `lterm` for polynomials.

### **mainvar — Main variable of a polynomial**

`mainvar(<a>)`

If `Vars` is not the empty list, `mainvar` can be called without argument.

### **mapcoeffs — Apply a function to the coefficients of a polynomial**

`mapcoeffs(a, f, <e1, ...>)`

This method overloads the function `mapcoeffs` for polynomials.

**multcoeffs — Multiplie the coefficients of a polynomial with a factor**`multcoeffs(a, c)`

This method overloads the function `multcoeffs` for polynomials.

**nterms — Number of terms of a polynomial**`nterms(a)`

This method overloads the function `nterms` for polynomials.

**nthcoeff — N-th coefficient of a polynomial**`nthcoeff(a, n, <ord>)`

If `n` is larger than the number of monomials of the polynomial then the function returns FAIL.

The zero polynomial has no monomials. `nthcoeff` returns FAIL when invoked on the zero polynomial.

This method overloads the function `nthcoeff` for polynomials.

**nthmonomial — N-th monomial of a polynomial**`nthmonomial(a, n, <ord>)`

If `n` is larger than the number of monomials of the polynomial then the function returns FAIL.

The zero polynomial has no monomials. `nthmonomial` returns FAIL for the zero polynomial.

This method overloads the function `nthmonomial` for polynomials.

**nthterm — N-th term of a polynomial**`nthterm(a, n, <ord>)`

If `n` is larger than the number of monomials of the polynomial then the function returns FAIL.

The zero polynomial has no monomials. `nthterm` returns FAIL when called with the zero polynomial.

This method overloads the function `nthterm` for polynomials.

### **orderedVariableList — Ordered list of indeterminates of a polynomial**

`orderedVariableList(<a>)`

In case `Vars` is not the empty list, `orderedVariableList` can be called without an argument.

### **pivotSize — Size of a pivot element**

`pivotSize(a)`

This method is called if this domain is used as the component ring of a matrix domain to perform Gaussian elimination.

### **reductum — Reductum of a polynomial**

`reductum(a, <ord>)`

### **subs — Avoid substitution**

Inherited from `Dom::BaseDomain`.

### **subsex — Avoid extended substitution**

Inherited from `Dom::BaseDomain`.

### **tcoeff — Lowest coefficient of a polynomial**

`tcoeff(a, <ord>)`

This method overloads the function `tcoeff` for polynomials.

## **Conversion Methods**

### **coerce — Coerce into this domain**

Inherited from `Cat::BaseCategory`.

**convert — Conversion to a polynomial**`convert(p)`**convert\_to — Convert element**Inherited from `Dom::BaseDomain`.**expr — Conversion to a basic type**`expr(a)`This method overloads the function `expr`.**poly — Convert to a basic polynomial domain**`poly(a)`This method overloads the function `poly`.**TeXCoeff — TeX formatting of a polynomial coefficient**`TeXCoeff(c)`**TeXIdent — TeX formatting of a polynomial indeterminate**`TeXIdent(var)`**TeXTerm — TeX formatting of a polynomial term**`TeXTerm(t)`

## Technical Methods

**adaptIndets — Convert polynomials to common indeterminates**`adaptIndets(<a, b, ...>)`

---

**Note** This method only exists if the parameter `Vars` is the empty list (`[]`).

---

**allAxioms — Return all axioms**

Inherited from Dom::BaseDomain.

**allCategories — Return all categories**

Inherited from Dom::BaseDomain.

**allEntries — Return the names of all entries**

Inherited from Dom::BaseDomain.

**allSuperDomains — Return all super-domains**

Inherited from Dom::BaseDomain.

**getAxioms — Return axioms stated in the constructor**

Inherited from Dom::BaseDomain.

**getCategories — Return categories stated in the constructor**

Inherited from Dom::BaseDomain.

**getSuperDomain — Return super-domain stated in the constructor**

Inherited from Dom::BaseDomain.

**hasProp — Test for a certain property**

Inherited from Dom::BaseDomain.

**info — Print short information about this domain**

Inherited from Dom::BaseDomain.

**isNeg — Test on leading output token**

isNeg(a)

**mult — Multiplie polynomials**

mult(a, b, ...)



**new — Create a new element**

```
new(p)
```

```
new(lm)
```

```
new(lm, v)
```

`dom(p)` creates an element of this domain from a polynomial or a polynomial expression `p` and returns that element. If this is not possible, an error message is given.

If `Vars` is chosen as the empty list (`[]`) then in creating new elements from a polynomial or polynomial expression the function `indets` is first called to get the identifiers. Afterwards the element is created with this list of identifiers. For creating an element from a constant the dummy variable `_dummy` is introduced. The drawback of this approach is that two mathematically equal polynomials may have variable lists which differ by the dummy variable.

`dom(lm)` creates, if `Vars` is not the empty list `[]`, a polynomial from the list `lm` of the form `[[c1, [e11, ... e1n]], ... [cm, [em1, ... emn]]]` where the `ci` are coefficients and the `eij` are the exponents with respect to `Vars`. For a univariate polynomial this list can be simplified to `[[c1, e1], ... [cm, em]]`.

`dom(lm, v)` creates, if `Vars = []`, a polynomial from the list `lm` of the form `[[c1, [e11, ... e1n]], ... [cm, [em1, ... emn]]]` where the `ci` are coefficients and the `eij` are the exponents with respect to `v`. For a univariate polynomial this list can be simplified to `[[c1, e1], ... [cm, em]]`. The list of indeterminates `v` must contain valid indeterminates.

**plus — Add polynomials**

```
plus(a, b, ...)
```

**print — Print polynomials**

```
print(a)
```

This method overloads the function `print`.

**printMethods — Print out methods**

Inherited from `Dom::BaseDomain`.

**printMonomial — Print a monomial in defined order**

```
printMonomial(c, d, v)
```

**printTerm — Print a term in defined order**

```
printTerm(d)
```

```
printTerm(d, v)
```

`printTerm(d, v)` returns an ordered sequence of the indeterminates together with their powers as given in the variable list `v` and the degree vector `d` respectively.

Note that this call is only valid if `nops(v)=nops(d)`.

**Rep — Data representation of a polynomial**

```
Rep(a)
```

**sign — Leading sign of a polynomial**

```
sign(a)
```

*Note:* this method does not have the meaning of a mathematical sign function!

**testtype — Test type of object**

Inherited from `Cat::BaseCategory`.

**undefinedEntries — Return missing entries**

Inherited from `Dom::BaseDomain`.

**whichEntry — Return the domain or category implementing an entry**

Inherited from `Dom::BaseDomain`.

## See Also

### MuPAD Domains

Dom::MultivariatePolynomial | Dom::Polynomial |  
Dom::UnivariatePolynomial

## **Dom::Expression**

Domain of all objects of basic type

### **Syntax**

`Dom::Expression(x)`

### **Description**

`Dom::Expression` comprises all objects only consisting of operands of built-in types.

`Dom::Expression` is a façade domain: it has no domain elements, but uses system representation.

Unlike `Dom::ExpressionField`, `Dom::Expression` does not belong to any arithmetical category, and its elements need not be arithmetical expressions.

`Dom::Expression` mainly serves as a super-domain to `Dom::ArithmeticalExpression`; it rarely makes sense to use it directly.

### **Superdomain**

`Dom::BaseDomain`

### **Axioms**

`Ax::systemRep`, `Ax::efficientOperation("_divide")`,  
`Ax::efficientOperation("_mult")`, `Ax::efficientOperation("_invert")`

### **Categories**

`Cat::BaseCategory`

## Examples

### Example 1

Almost every MuPAD object can be converted to an expression. Objects of basic type *are* expressions.

```
Dom::Expression([3, array(1..2), rectform(exp(I))])
```

```
[3, ( NIL NIL ), cos(1) + sin(1) i]
```

The `convert` method flattens its argument: hence expression sequences are *not* allowed.

```
Dom::Expression((3, x))
```

```
Error: Invalid number of arguments. [expr]
Evaluating: Dom::Expression::new
```

## Parameters

**x**

An object of basic type consisting only of operands of built-in types, or any other object convertible to such using `expr`.

## Entries

"randomIdent"	an identifier used for creating random elements
---------------	---

## Methods

### Conversion Methods

**convert** — Conversion of objects

`convert(x)`

**convert\_to** — Conversion to other domains

`convert_to(x, T)`

**expr** — Just return the argument

`expr(x)`

**testtype** — Test whether its argument is an expression

`testtype(x, Dom::Expression)`

This method overloads `testtype`; since `Dom::Expression` has no domain elements, the overloading can only be caused by the second argument.

**float** — Convert numbers to floats

`float(x)`

### Technical Methods

**subs** — Substitution

`subs(x, s, ...)`

**subsex** — Extended substitution

`subsex(x, s, ...)`

**random** — Create random expression

`random()`

## See Also

### MuPAD Domains

Dom::ExpressionField

## Dom::ExpressionField

Domains of expressions forming a field

### Syntax

#### Domain Creation

```
Dom::ExpressionField(<Normal, <IsZero>>)
```

#### Element Creation

```
Dom::ExpressionField(Normal, IsZero)(e)
```

### Description

#### Domain Creation

`Dom::ExpressionField(Normal, IsZero)` creates a domain of expressions forming a field, where the functions `Normal` and `IsZero` are used to normalize expressions and test for zero.

The function `Normal` is used to normalize the expressions representing the elements, the function `IsZero` is used to test the expressions for zero. It is assumed that the field has characteristic 0.

The domain cannot decide if the element expressions—given the normalizing function and zero test—actually form a field. It is up to the user to choose correct functions for normalizing and zero test and to enter only valid expressions as domains elements.

One should view this domain constructor as a pragmatic way to create a field of characteristic 0 in an ad-hoc fashion. Note that the default of using `id` and `iszero` does not yield a field really, but it is often convenient and sensible to use the resulting structure as a field.



`Normal` must be a function which takes an expression representing a domain element and returns the normalized expression. `Normal` should return `FAIL` if the expression is not valid.

If `Normal` is not given, then the system function `id` is used, i.e., only the kernel simplifier is used to normalize expressions.

If a normalizing function other than `id` is given, it is assumed that this functions returns a normal form where the zero element is uniquely represented by the constant `0`.

`IsZero` must be a function which takes an expression representing a domain element and returns `TRUE` if the expression represents zero and `FALSE` otherwise.

If `IsZero` is not given, then `iszero @ Normal` is used for zero testing. If `Normal` is equal to `id` this functional expression is simplified to `iszero`.

If `Normal` is equal to `id` and `IsZero` is equal to `iszero`, a façade domain is created, i.e., the domain elements are simply expressions and are not explicitly created by `new`.

Otherwise the elements of the domain are explicitly created by `new`. Each such element has one operand, which is the expression representing the domain element. The element expressions are normalized after each operation using the function `Normal`.

## Element Creation

`Dom::ExpressionField(Normal, IsZero)(e)` creates a field element represented by the expression `e`. The expression is normalized using the function `Normal`.

If `Normal` returns `FAIL`, it is assumed that the expression does not represent a valid field element. If this test is not fully implemented the domain cannot decide if the expression represents a valid field element. In this case it is up to the user to enter only valid expressions as field elements.

If `Normal` is equal to `id` and `IsZero` is equal to `iszero`, the domain is only a façade domain. In this case the expression `e` is returned after being simplified by the built-in kernel simplifier.

## Superdomain

If Normal = id and IsZero = iszero, then Dom::ArithmeticalExpression, else Dom::BaseDomain.

## Axioms

Ax::indetElements

If Normal = id and IsZero = iszero, then Ax::efficientOperation ("\_divide"), Ax::efficientOperation ("\_mult"), Ax::efficientOperation ("\_invert"), else Ax::normalRep.

If Normal = id and IsZero = iszero and IsZero = iszero, then Ax::systemRep.

## Categories

Cat::Field, Cat::DifferentialRing

## Examples

### Example 1

Dom::ExpressionField(normal) creates a field of rational expressions over the rationals. The expressions representing the field elements are always normalized by normal:

```
Fn := Dom::ExpressionField(normal):  
a := Fn((x^2 - 1)/(x - 1))
```

$x + 1$

The field elements are explicit elements of the domain:

```
domtype(a)
```

Dom::ExpressionField(normal, iszero @ normal)

## Example 2

In the domain Dom::ExpressionField(id, iszero@normal) the expressions representing the elements are normalized by the kernel simplifier only:

```
Fi := Dom::ExpressionField(id, iszero@normal):
a := Fi((x^2 - 1)/(x - 1))
```

$$\frac{x^2 - 1}{x - 1}$$

The elements of this domain are not normalized (when viewed as rational expressions over the rationals), thus the domain does not have the axiom Ax::normalRep:

```
b := a/Fi(x + 1) - Fi(1)
```

$$\frac{x^2 - 1}{(x - 1)(x + 1)} - 1$$

But nevertheless this domain also represents the field of rational expressions over the rationals, because zero is detected correctly by the function iszero @ normal:

```
iszero(b)
```

TRUE

## Parameters

### Normal

A function used to normalize the expressions of the domain; default is id.

**IsZero**

A function used to test the expressions of the domain for zero; default is `iszero @ Normal`.

**e**

An expression representing a field element.

**Entries**

"characteristic"	The characteristic of the fields created by this constructor is assumed to be $\theta$ .
"one"	The element represented by the expression <code>1</code> is assumed to be a neutral element w.r.t. " <code>_mult</code> ".
"zero"	The element represented by the expression <code>0</code> is assumed to be a neutral element w.r.t. " <code>_plus</code> ".

**Methods****Mathematical Methods****abs — Absolute value**

`abs(x)`

Overloads the function `abs`, thus may be called via `abs(x)`.

**combine — Combine terms of the same algebraic structure**

`combine(x, <a>)`

Overloads the function `combine`, thus may be called via `combine(x, ...)`.

**conjugate — Complex conjugate**`conjugate(x)`

Overloads the function `conjugate`, thus may be called via `conjugate(x)`.

**D — Differential operator**`D(<l>, x)`

Overloads the function `D`, thus may be called via `D(x)` or `D(l, x)`.

**denom — Denominator**`denom(x)`

Overloads the function `denom`, thus may be called via `denom(x)`.

**diff — Differentiate an element**`diff(x, <v, , ...>)`

Overloads the function `diff`, thus may be called via `diff(x, ...)`.

**\_divide — Divide elements**`_divide(x, y)`

Overloads the function `_divide`, thus may be called via `x/y` or `_divide(x, y)`.

**equal — Test for mathematical equality**`equal(x, y)`**expand — Expand an element**`expand(x)`

Overloads the function `expand`, thus may be called via `expand(x)`.

**factor — Factorize an element**`factor(x)`

Overloads the function `factor`, thus may be called via `factor(x)`.

**float — Floating-point approximation**

`float(x)`

Overloads the function `float`, thus may be called via `float(x)`.

**gcd — Greatest common divisor**

`gcd(x, ...)`

Overloads the function `gcd`, thus may be called via `gcd(x, ...)`.

**Im — Imaginary part of an element**

`Im(x)`

Overloads the function `Im`, thus may be called via `Im(x)`.

**int — Definite and indefinite integration**

`int(x, <v>)`

Overloads the function `int`, thus may be called via `int(x, ...)`.

**intmult — Integer multiple**

`intmult(x, n)`

**\_invert — Invert an element**

`_invert(x)`

Overloads the function `_invert`, thus may be called via `1/x` or `_invert(x)`.

**iszero — Test for zero**

`iszero(x)`

Overloads the function `iszero`, thus may be called via `iszero(x)`.

**lcm — Least common multiple**

`lcm(x, ...)`

Overloads the function `lcm`, thus may be called via `lcm(x, ...)`.

**\_leequal — Test if less or equal**

`_leequal(x, y)`

Please note that the function `_leequal` can only test numbers (in a syntactical sense), but not constant expressions like `PI` (Symbolic Math Toolbox) or `sqrt(2)`.

Overloads the function `_leequal`, thus may be called via `x <= y, y >= x` or `_leequal(x, y)`.

**\_less — Test if element is less**

`_less(x, y)`

Please note that the function `_less` can only test numbers (in a syntactical sense), but not constant expressions like `PI` (Symbolic Math Toolbox) or `sqrt(2)`.

Overloads the function `_less`, thus may be called via `x < y, y > x` or `_less(x, y)`.

**limit — Limit computation**

`limit(x, <v, ...>)`

Overloads the function `limit`, thus may be called via `limit(x, ...)`.

**max — Maximum of arguments**

`max(x, ...)`

Overloads the function `max`, thus may be called via `max(x, ...)`.

**min — Minimum of arguments**

`min(x, ...)`

Overloads the function `min`, thus may be called via `min(x, ...)`.

**`_mult` — Multiplie elements**`_mult(x, ...)`

If all arguments are of this domain or can be coerced to this domain (using the method `coerce`), the product of the expressions representing the arguments is calculated using the function `_mult`.

If one of the arguments cannot be coerced, the arguments up to the offending one are multiplied and then the method "`_mult`" of the domain of the offending argument is called to multiply the remaining arguments.

Overloads the function `_mult`, thus may be called via `x*...` or `_mult(x, ...)`.

**`_negate` — Negate an element**`_negate(x)`

Overloads the function `_negate`, thus may be called via `-x` or `_negate(x)`.

**`norm` — Norm of an element**`norm(x)`

Overloads the function `norm`, thus may be called via `norm(x)`.

Please note that the system function `norm`, applied to an expression, computes the norm of that expression interpreted as a polynomial expression and *not* the absolute value of the expression. This may be regarded as an inconsistency.

**`normal` — Normal form**`normal(x)`

Overloads the function `normal`, thus may be called via `normal(x)`.

**`numer` — Numerator**`numer(x)`

Overloads the function `numer`, thus may be called via `numer(x)`.



**\_plus — Add elements**`_plus(x, ...)`

If all arguments are of this domain or can be coerced to this domain (using the method `coerce`) the sum of the expressions representing the arguments is calculated using the function `_plus`.

If one of the arguments cannot be coerced the arguments up to the offending one are added and then the method "`_plus`" of the domain of the offending argument is called to add the remaining arguments.

Overloads the function `_plus`, thus may be called via `x+...` or `_plus(x, ...)`.

**\_power — Exponentiate arguments**`_power(x, y)``_power(x, y)`

If both arguments are of this domain the power is calculated by mapping the function `_power` to the expressions representing the arguments.

If one of the arguments is not of this domain it is coerced to this domain, then the power is computed. If the coercion fails an error is raised.

Note that it is assumed that at least one of the arguments is of this domain.

Overloads the function `_power`, thus may be called via `x^y` or `_power(x, y)`.

**radsimp — Simplify radicals**`radsimp(x)`

Overloads the function `radsimp`, thus may be called via `radsimp(x)`.

**random — Create a random element**`random()`

See `polylib::randpoly` for details about creating random polynomials.

**Re — Real part of an element**`Re(x)`

Overloads the function `Re`, thus may be called via `Re(x)`.

**sign — Sign of an element**`sign(x)`

Overloads the function `sign`, thus may be called via `sign(x)`.

**simplify — General simplification of an element**`simplify(x, <a>)`

Overloads the function `simplify`, thus may be called via `simplify(x, ...)`.

**solve — Solve an equation**`solve(x, <a, ...>)`

Note that this method will never return an element of this domain. See `solve` for details about results and optional additional arguments.

Overloads the function `solve`, thus may be called via `solve(x, ...)`.

**sqrfree — Square-free factorization**`sqrfree(x)`

Overloads the function `polylib::sqrfree`, thus may be called via `polylib::sqrfree(x)`.

**\_subtract — Subtract elements**`_subtract(x, y)`

Overloads the function `_subtract`, thus may be called via `x-y` or `_subtract(x, y)`.

## Conversion Methods

### **convert** — Convert to this domain

`convert(x)`

### **convert\_to** — Convert to other domain

`convert_to(x, T)`

### **expr** — Convert to basic type

`expr(x)`

This method is called by the function `expr` if a subexpression of the argument is an element of this domain.

### **new** — Creating an element

`new(x)`

Overloads the function call operator for this domain, thus may be called via `F(x)` where `F` is this domain.

## Access Methods

### **nops** — Number of operands

`nops(x)`

Overloads the function `nops`, thus may be called via `nops(x)`.

### **op** — Get operands

`op(x)`

`op(x, i)`

Returns the operand with index `i` of the expression representing `x`. If `i` is `0` then the operator of the expression is returned, which usually is not an element of this domain. The other operands are converted to elements of this domain.

This method is called by the function `op` when an element of this domain is contained, as a subexpression, in the first argument of `op`. Operand ranges and paths are handled by `op` and need not be handled by this method. See `op` for details.

### **subs — Substitute subexpressions**

`subs(x, e, ...)`

Maps `subs` to the expression representing `x`. The resulting expression is converted to an element of this domain.

This method is called by the function `subs` when an element of this domain is contained, as a subexpression, in the first argument of `subs`. See `subs` for details.

### **subsex — Extended substitution**

`subsex(x, e, , ...)`

Maps `subsex` to the expression representing `x`. The resulting expression is converted to an element of this domain.

This method is called by the function `subsex` when an element of this domain is contained, as a subexpression, in the first argument of `subsex`. See `subsex` for details.

### **subsop — Substitute operand**

`subsop(x, e, , ...)`

This method is called by the function `subsop` when an element of this domain is contained, as a subexpression, in the first argument of `subsop`. Operand ranges and paths are handled by `subsop` and need not be handled by this method. See `subsop` for details.

## **Technical Methods**

### **indets — Identifier of an element**

`indets(x, <optionName>)`

Overloads the function `indets`, thus may be called via `indets(x)` and `indets(x, optionName)`, respectively.

**length — Size of an element**`length(x)`

Overloads the function `length`, thus may be called via `length(x)`.

**map — Apply function to operands**`map(x, f, <a, ...>)`

Overloads the function `map`, thus may be called via `map(x, f, ...)`.

**rationalize — Approximate floating-point numbers by rationals**`rationalize(x, <a, ...>)`

Note that this method does *not* overload the function `rationalize` from the standard library package, but the function `numeric::rationalize` from the `numeric` package instead. Thus the method may be called via `numeric::rationalize(x, ...)`.

**pivotSize — Pivot size**`pivotSize(x)`

## Dom::Float

Real floating-point numbers

### Syntax

`Dom::Float(x)`

### Description

`Dom::Float` is the set of real floating-point numbers represented by elements of the domain `DOM_FLOAT`.

`Dom::Float` is the domain of real floating point numbers represented by expressions of type `DOM_FLOAT`.

`Dom::Float` has category `Cat::Field` out of pragmatism. This domain actually is not a field because `bool(1.0 = float(3) / float(3))` returns `FALSE` for example.

Elements of `Dom::Float` are usually not created explicitly. However, if one creates elements using the usual syntax, it is checked whether the input expression may be converted to a floating point number. This means `Dom::Float` is a facade domain which creates elements of domain type `DOM_FLOAT`.

Viewed as a differential ring `Dom::Float` is trivial, it contains constants only.

`Dom::Float` has the domain `Dom::Numerical` as its super domain, i.e., it inherits each method which is defined by `Dom::Numerical` and not implemented by `Dom::Float`. Methods described below are re-implemented by `Dom::Float`.

### Superdomain

`Dom::Numerical`

## Axioms

```
Ax::canonicalRep, Ax::systemRep, Ax::canonicalOrder,  
Ax::efficientOperation("_divide"), Ax::efficientOperation("_mult"),  
Ax::efficientOperation("_invert")
```

## Categories

```
Cat::DifferentialRing, Cat::Field, Cat::OrderedSet
```

## Examples

### Example 1

Creating some floating-point numbers using `Dom::Float`. This example also shows that `Dom::Float` is a facade domain.

```
Dom::Float(2.3); domtype(%)
```

```
2.3
```

```
DOM_FLOAT
```

```
Dom::Float(sin(2/3*PI) + 3)
```

```
3.866025404
```

```
Dom::Float(sin(x))
```

```
Error: Invalid arguments. [Dom::Float::new]
```

## Example 2

By tracing the method `Dom::Float::testtypeDom` we can see the interaction between `testtype` and `Dom::Float::testtypeDom`.

```
prog::trace(Dom::Float::testtypeDom):  
delete x:  
testtype(x, Dom::Float);  
testtype(3.4, Dom::Float);  
prog::untrace(Dom::Float::testtypeDom):  
  
enter Dom::Float::testtypeDom(x, Dom::Float)  
computed FAIL
```

FALSE

```
enter Dom::Float::testtypeDom(3.4, Dom::Float)  
computed TRUE
```

TRUE

## Parameters

**x**

An expression which can be converted to a `DOM_FLOAT` by the function `float`.

## Entries

"one"	the unit element; it equals <code>1.0</code> .
"zero"	The zero element; it equals <code>0.0</code> .



## Methods

### Mathematical Methods

#### **pivotSize — Size of a pivot element**

`pivotSize(x)`

This method is called if this domain is used as the component ring of a matrix domain to perform Gaussian elimination.

#### **random — Random number generation**

`random()`

### Conversion Methods

#### **convert — Conversion of objects**

`convert(x)`

In general, if `float(x)` evaluates to a real floating-point number of type `DOM_FLOAT`, this number is the result of the conversion.

#### **convert\_to — Conversion to other domains**

`convert_to(x, T)`

The following domains are allowed for `T`: `DOM_FLOAT`, `Dom::Float` and `Dom::Numerical`.

#### **testtype — Type checking**

`testtype(x, T)`

In general this method is called from the function `testtype` and not directly by the user. “Example 2” on page 7-180 (Symbolic Math Toolbox) demonstrates this behavior.

## See Also

### **MuPAD Domains**

`Dom::Complex` | `Dom::Integer` | `Dom::Numerical` | `Dom::Rational` | `Dom::Real`

## Dom::FloatIV

The “field” of Floating Point Intervals

### Syntax

Dom::FloatIV(x, ...)

### Description

Dom::FloatIV is the inclusion algebra of (finite unions of) rectangular intervals in the complex plane.

Dom::FloatIV is the domain of kernel intervals of type DOM\_INTERVAL.

Dom::FloatIV has category Cat::Field out of pragmatism. This domain actually is not a field because, for example, there is no additive inverse of  $1 \dots 2$ .

Elements of Dom::FloatIV are usually not created explicitly. The syntax given above is equivalent to an `interval` call, with no check to ensure that the result is in fact an interval, it could, for example, also be an expression with all numerical coefficients replaced by intervals. Apart from this behavior of the constructor and the "convert" slot, Dom::FloatIV is a façade domain for elements of domain type DOM\_INTERVAL.

Viewed as a differential ring Dom::FloatIV is trivial, it contains constants only.

Dom::FloatIV has the domain Dom::Numerical as its super domain, i.e., it inherits each method which is defined by Dom::Numerical and not re-implemented by Dom::FloatIV. Methods described below are those implemented by Dom::FloatIV.

### Superdomain

Dom::Numerical

## Axioms

```
Ax::canonicalRep, Ax::systemRep, Ax::efficientOperation("_divide"),  
Ax::efficientOperation("_invert"), Ax::efficientOperation("_mult"),  
Ax::efficientOperation("_plus")
```

## Categories

```
Cat::Field, Cat::DifferentialRing
```

## Parameters

**x**, ...

MuPAD expressions

## Methods

### Mathematical Methods

#### **Im — Imaginary Part**

```
Im(iv)
```

#### **Re — Real Part**

```
Re(iv)
```

#### **abs — Absolute Value**

```
abs(iv)
```

#### **arccos — Inverse Cosine**

```
arccos(iv)
```

**arccosh — Inverse Hyperbolic Cosine**

arccosh(iv)

**arccot — Inverse Cotangent**

arccot(iv)

**arccoth — Inverse Hyperbolic Cotangent**

arccoth(iv)

**arccsc — Inverse Cosecant**

arccsc(iv)

**arccsch — Inverse Hyperbolic Cosecant**

arccsch(iv)

**arcsec — Inverse Secant**

arcsec(iv)

**arcsech — Inverse Hyperbolic Secant**

arcsech(iv)

**arcsin — Inverse Sine**

arcsin(iv)

**arcsinh — Inverse Hyperbolic Sine**

arcsinh(iv)

**arctan — Inverse Tangent**

arctan(iv)

**arctanh — Inverse Hyperbolic Tangent**

arctanh(iv)

**arg — Argument ('Polar Angle')**

arg(iv)

**beta — Beta Function**

beta(iv)

**ceil — Rounding Up**

ceil(iv)

**center — Geometric Center**

center(iv)

**cos — Cosine**

cos(iv)

**cosh — Hyperbolic Cosine**

cosh(iv)

**cot — Cotangent**

cot(iv)

**coth — Hyperbolic Cotangent**

coth(iv)

**csc — Cosecant**

csc(iv)

**dirac — Dirac delta distribution**

dirac(iv)

**exp — Exponential Function**

exp(iv)

**floor — Rounding Down**

floor(iv)

**gamma — Gamma Function**

gamma(iv)

**ln — Logarithm**

ln(iv)

**mag — Interval Magnitude**

mag(iv)

**mig — Interval Mignitude**

mig(iv)

**random — Random Element**

random()

**round — Round**

round(iv)

**sec — Secans**

sec(iv)

**sign — Sign**

sign(iv)

**sin — Sine**

sin(iv)

**sinh — Hyperbolic Sine**

sinh(iv)

**sqrt — Square Root**`sqrt(iv)`**tan — Tangent**`tan(iv)`**tanh — Hyperbolic Tangent**`tanh(iv)`**trunc — Round to Zero**`trunc(iv)`**width — Width of an Interval**`width(x)`

## Conversion Methods

**convert — Conversion of Objects**`convert(x)`**testtype — Type checking**`testtype(x, T)`

Usually, this method is called from the function `testtype` and not directly by the user.

## See Also

**MuPAD Domains**

`Dom::Complex` | `Dom::Float` | `Dom::Integer` | `Dom::Interval` | `Dom::Numerical` |  
`Dom::Rational` | `Dom::Real`



# Dom::Fraction

Field of fractions of an integral domain

## Syntax

### Domain Creation

`Dom::Fraction(R)`

### Element Creation

`Dom::Fraction(R)(r)`

## Description

### Domain Creation

`Dom::Fraction(R)` creates a domain which represents the field of fractions

$F = \left\{ \frac{x}{y} \mid x \in R, y \in R \setminus \{0\} \right\}$  of the integral domain  $R$ .

An element of the domain `Dom::Fraction(R)` has two operands, the numerator and denominator.

If `Dom::Fraction(R)` has the axiom `Ax::canonicalRep` (see below), the denominators have unit normal form on page 4-33 and the gcds of numerators and denominators cancel.

The domain `Dom::Fraction(Dom::Integer)` represents the field of rational numbers. But the created domain is not the domain `Dom::Rational`, because it uses a different representation of its elements. Arithmetic in `Dom::Rational` is much more efficient than it is in `Dom::Fraction(Dom::Integer)`.

## Element Creation

If  $r$  is a rational expression, then an element of the field of fractions `Dom::Fraction(R)` is created by going through the operands of  $r$  and converting each operand into an

element of  $R$ . The result of this process is  $r$  in the form  $\frac{x}{y}$ , where  $x$  and  $y$  are elements of  $R$ . If  $R$  has `Cat::GcdDomain`, then  $x$  and  $y$  are coprime.<sup>y</sup>

If one of the operands can not be converted into the domain  $R$ , an error message is issued.

## Superdomain

`Dom::BaseDomain`

## Axioms

`Ax::normalRep`

## Categories

`Cat::QuotientField(R)`

## Examples

### Example 1

We define the field of rational functions over the rationals:

```
F := Dom::Fraction(Dom::Polynomial(Dom::Rational))
```

```
Dom::Fraction(Dom::Polynomial(Dom::Rational, LexOrder))
```

and create an element of  $F$ :

```
a := F(y/(x - 1) + 1/(x + 1))
```

$$\frac{x + y + x y - 1}{x^2 - 1}$$

To calculate with such elements use the standard arithmetical operators:

```
2*a, 1/a, a*a
```

$$\frac{2x + 2y + 2xy - 2}{x^2 - 1}, \frac{x^2 - 1}{x + y + xy - 1}, \frac{x^2 y^2 + 2x^2 y + x^2 + 2xy^2 - 2x + y^2 - 2y + 1}{x^4 - 2x^2 + 1}$$

Some system functions are overloaded for elements of domains generated by Dom::Fraction, such as diff, numer or denom (see the description of the corresponding methods "diff", "numer" and "denom" above).

For example, to differentiate the fraction a with respect to x enter:

```
diff(a, x)
```

$$-\frac{y - 2x + 2xy + x^2 y + x^2 + 1}{x^4 - 2x^2 + 1}$$

If one knows the variables in advance, then using the domain Dom::DistributedPolynomial yields a more efficient arithmetic of rational functions:

```
Fxy := Dom::Fraction(
  Dom::DistributedPolynomial([x, y], Dom::Rational)
)
```

```
Dom::Fraction(Dom::DistributedPolynomial([x, y], Dom::Rational, LexOrder))
```

```
b := Fxy(y/(x - 1) + 1/(x + 1)):
b^3
```

$$\frac{(x^3 y^3 + 3 x^3 y^2 + 3 x^3 y + x^3 + 3 x^2 y^3 + 3 x^2 y^2 - 3 x^2 y - 3 x^2 + 3 x y^3 - 3 x y^2 - 3 x y + 3 x + y^3 - 3 y^2 + 3 y - 1)}{(x^6 - 3 x^4 + 3 x^2 - 1)}$$

## Example 2

We create the field of rational numbers as the field of fractions of the integers, i.e.,

```
Q = { x/y | x ∈ ℤ, y ∈ ℤ \ {0} }:  
Q := Dom::Fraction(Dom::Integer):  
Q(1/3)
```

$$\frac{1}{3}$$

```
domtype(%)
```

```
Dom::Fraction(Dom::Integer)
```

Another representation of  $\mathbb{Q}$  in MuPAD is the domain `Dom::Rational` where the rationals are of the kernel domains `DOM_INT` and `DOM_RAT`. Therefore it is much more efficient to work with `Dom::Rational` than with `Dom::Fraction(Dom::Integer)`.

## Parameters

**R**

An integral domain, i.e., a domain of category `Cat::IntegralDomain`

**r**

A rational expression, or an element of **R**

## Entries

"characteristic"	is the characteristic of R.
"coeffRing"	is the integral domain R.
"one"	is the one of the field of fractions of R, i.e., the fraction 1.
"zero"	is the zero of the field of fractions of R, i.e., the fraction 0.

## Methods

### Mathematical Methods

#### **`_divide` — Divide two fractions**

`_divide(x, y)`

This method overloads the function `_divide` for fractions, i.e., one may use it in the form  $x / y$  or in functional notation: `_divide(x, y)`.

#### **`_invert` — Invert a fraction**

`_invert(r)`

This method overloads the function `_invert` for fractions, i.e., one may use it in the form  $1/r$  or  $r^{-1}$ , or in functional notation: `_invert(r)`.

#### **`_less` — Less-than relation**

`_less(q, r)`

An implementation is provided only if R is an ordered set, i.e., a domain of category `Cat::OrderedSet`.

This method overloads the function `_less` for fractions, i.e., one may use it in the form  $q < r$ , or in functional notation: `_less(q, r)`.

**`_mult` — Multiply fractions by fractions or rational expressions**`_mult(q, r)`

If `q` is not of the domain type `Dom::Fraction(R)`, it is considered as a rational expression which is converted into a fraction over `R` and multiplied with `q`. If the conversion fails, `FAIL` is returned.

The same applies to `r`.

This method also handles more than two arguments. In this case, the argument list is splitted into two parts of the same length which both are multiplied with the function `_mult`. The two results are multiplied again with `_mult` whose result then is returned.

This method overloads the function `_mult` for fractions, i.e., one may use it in the form `q * r` or in functional notation: `_mult(q, r)`.

**`_negate` — Negate a fraction**`_negate(r)`

This method overloads the function `_negate` for fractions, i.e., one may use it in the form `-r` or in functional notation: `_negate(r)`.

**`_power` — Integer power of a fraction**`_power(r, n)`

This method overloads the function `_power` for fractions, i.e., one may use it in the form `r^n` or in functional notation: `_power(r, n)`.

**`_plus` — Add fractions**`_plus(q, r, ...)`

If one of the arguments is not of the domain type `Dom::Fraction(R)`, then `FAIL` is returned.

This method overloads the function `_plus` for fractions, i.e., one may use it in the form `q + r` or in functional notation: `_plus(q, r)`.

**`D` — Differential operator**`D(r)`

An implementation is provided only if  $R$  is a partial differential ring, i.e., a domain of category `Cat::PartialDifferentialRing`.

This method overloads the operator  $D$  for fractions, i.e., one may use it in the form  $D(r)$ .

#### **denom — Denominator of a fraction**

`denom(r)`

This method overloads the function `denom` for fractions, i.e., one may use it in the form `denom(r)`.

#### **diff — Differentiation of fractions**

`diff(r, u)`

This method overloads the function `diff` for fractions, i.e., one may use it in the form `diff(r, u)`.

An implementation is provided only if  $R$  is a partial differential ring, i.e., a domain of category `Cat::PartialDifferentialRing`.

#### **equal — Test on equality of fractions**

`equal(q, r)`

#### **factor — Factorize the numerator and denominator of a fraction**

`factor(r)`

The factors  $u, r_1, \dots, r_n$  are fractions of type `Dom::Fraction(R)`, the exponents  $e_1, \dots, e_n$  are integers.

The system function `factor` is used to perform the factorization of the numerator and denominator of  $r$ .

This method overloads the function `factor` for fractions, i.e., one may use it in the form `factor(r)`.

#### **intmult — Integer multiple of a fraction**

`intmult(r, n)`

**iszero — Test for zero**

iszero(r)

An element of the field `Dom::Fraction(R)` is zero if its numerator is the zero element of `R`. Note that there may be more than one representation of the zero element if `R` does not have `Ax::canonicalRep`.

This method overloads the function `iszero` for fractions, i.e., one may use it in the form `iszero(r)`.

**numer — Numerator of a fraction**

numer(r)

This method overloads the function `numer` for fractions, i.e., one may use it in the form `numer(r)`.

**random — Random fraction generation**

random()

The returning fraction is normalized (see the methods "normalize" and "normalizePrime").

## Conversion Methods

**convert\_to — Fraction conversion**

convert\_to(r, T)

If the conversion fails, `FAIL` is returned.

The conversion succeeds if `T` is one of the following domains: `Dom::Expression` or `Dom::ArithmeticalExpression`.

Use the function `expr` to convert `r` into an object of a kernel domain (see below).

**expr — Convert a fraction into an object of a kernel domain**

expr(r)



The result is an object of a kernel domain (e.g., DOM\_RAT or DOM\_EXPR).

This method overloads the function `expr` for fractions, i.e., one may use it in the form `expr(r)`.

### **retract — Retraction to base domain**

`retract(r)`

## **Technical Methods**

### **normalize — Normalizing fractions**

`normalize(x, y)`

Normalization means to remove the gcd of  $x$  and  $y$ . Hence,  $R$  needs to be of category `Cat::GcdDomain`. Otherwise, normalization cannot be performed and the result of this

method is the fraction  $\frac{x}{y}$ .

### **normalizePrime — Normalizing fractions over integral domains with a gcd**

`normalizePrime(x, y)`

In rings of category `Cat::GcdDomain`, elements are assumed to be relatively prime.

Hence, there is no need to normalize the fraction  $\frac{x}{y}$ .

In rings not of category `Cat::GcdDomain`, normalization of elements can not be performed and the result of this method is the fraction  $\frac{x}{y}$ .

## **See Also**

### **MuPAD Domains**

`Dom::Rational`

## Dom::GaloisField

Finite fields

### Syntax

#### Domain Creation

Dom::GaloisField(q)

Dom::GaloisField(p, n)

Dom::GaloisField(p, n, f)

Dom::GaloisField(F, n)

Dom::GaloisField(F, n, f)

#### Element Creation

Dom::GaloisField(p, n, f)(g)

### Description

#### Domain Creation

Dom::GaloisField(p, n, f) creates the residue class field  $\mathbb{Z}[X]/\langle f \rangle$ , a finite field with  $p^n$  elements. If f is not given, it is chosen at random among all irreducible polynomials of degree n.

Dom::GaloisField(q) (where  $q = p^n$ ) is equivalent to Dom::GaloisField(p, n).

Dom::GaloisField(F, n, f) creates the residue class field  $F[X]/\langle f \rangle$ , a finite field with  $|F|^n$  elements.

If  $f$  is not given, a random irreducible polynomial of appropriate degree is used; some free identifier is chosen as its variable, and this one must also be used when creating domain elements.

Although  $n = 1$  is allowed, `Dom::IntegerMod` should be used for representing prime fields.

If  $F$  is of type `Dom::GaloisField`, consisting of residue classes of polynomials, the variable of these polynomials must be distinct from the variable of  $f$ . If a tower several of Galois fields is constructed, the variable used in the uppermost Galois field must not equal any of those used in the tower. A special entry "VariablesInUse" serves to keep track of all variables appearing somewhere in the tower.

## Element Creation

`Dom::GaloisField(p, n, f)(g)` (or, respectively, `Dom::GaloisField(F, n, f)(g)`) creates the residue class of  $g$  modulo  $f$ . It is represented by the unique polynomial in that class that has smaller degree than  $f$ .

## Superdomain

`Dom::AlgebraicExtension(Dom::IntegerMod(p), f)`

## Axioms

`Ax::canonicalRep`

## Categories

`Cat::Field`, `Cat::Algebra(F)`, `Cat::VectorSpace(F)`

## Examples

### Example 1

We define  $L$  to be the field with 4 elements. Then  $a^4 = a$  for every  $a \in L$ , by a well-known theorem.

```
L:=Dom::GaloisField(2, 2, u^2+u+1): L(u+1)^4
```

$u + 1$

## Parameters

**q**

Prime power

**p**

Prime

**n**

Positive integer

**f**

Univariate irreducible polynomial over  $\text{Dom}::\text{IntegerMod}(p)$  or  $F$ , or polynomial expression convertible to such

**F**

Finite field of type  $\text{Dom}::\text{IntegerMod}$  or  $\text{Dom}::\text{GaloisField}$ .

**g**

Univariate polynomial over the ground field in the same variable as  $f$ , or polynomial expression convertible to such

## Entries

"zero"	the zero element of the field
"one"	the unit element of the field
"characteristic"	the characteristic of the field
"size"	the number of elements of the field
"PrimeField"	the prime field, which equals $\text{Dom}::\text{IntegerMod}(p)$ .
"Variable"	the variable of the polynomial $f$ .
"VariablesInUse"	a list consisting of "Variable" and the variables used by the ground field.

## Methods

### Mathematical Methods

#### **iszero** — Test for zero

iszero(a)

It overloads the function iszero.

#### **\_power** — Integer power of an element

\_power(a, n)

It overloads \_power.

#### **frobenius** — Frobeniu map

frobenius(a)

#### **conjugates** — Conjugate of an element

conjugates(a)

**order — Order of an element**

order(a)

**isSquare — Test whether an element is a square**

isSquare(a)

**ln — Discrete logarithm**

ln(a, b)

**elementNumber — Enumerate field elements**

elementNumber(a)

The inverse of this mapping has not been implemented.

**companionMatrix — Companion matrix of the Galois field over its ground field**

companionMatrix()

**companionPowers — Power of the companion matrix**

companionPowers()

**matrixRepresentation — Isomorphism to the algebra generated by the companion matrix**

matrixRepresentation(a)

If  $A$  is the companion matrix, the image of  $\sum_{i=1}^n a_i X^i$  is  $\sum_{i=1}^n a_i A^i$ .

**randomPrimitive — Choose a primitive element at random**

randomPrimitive()

**isBasis — Test elements for being a basis over the ground field**

isBasis(l)

**isNormal — Test whether a given field element is normal**

isNormal(a)

**randomNormal** — Choose normal element at random

randomNormal()

**isPrimitivePolynomial** — Test whether a polynomial over the field is primitive

isPrimitivePolynomial(h)

## Conversion Methods

**convert** — Conversion from other types

convert(a)

**convert\_to** — Conversion to other types

convert\_to(a, T)

## See Also

**MuPAD Domains**

Dom::AlgebraicExtension | Dom::IntegerMod

## Dom::ImageSet

Domain of images of sets under mappings

### Syntax

#### Domain Creation

`Dom::ImageSet()`

#### Element Creation

`Dom::ImageSet(f, x, S)`

`Dom::ImageSet(f, [x1, ...], [S1, ...])`

### Description

#### Domain Creation

`Dom::ImageSet` is the domain of all sets of complex numbers that can be written as the set of all values taken on by some mapping, i.e., sets of the form  $\{f(x_1, \dots, x_n) \mid x_i \in S_i\}$  for some function  $f$  and some sets  $S_1, \dots, S_n$ .

Image sets are mainly used by `solve` to express sets like  $\{k\pi \mid k \in \mathbb{Z}\}$ .

`Dom::ImageSet` belongs to the category `Cat::Set`—arithmetical and set-theoretic operations are inherited from there.

#### Element Creation

`Dom::ImageSet(f, x, S)` represents the set of all values that can be obtained by substituting some element of  $S$  for  $x$  in the expression  $f$ .



`Dom::ImageSet(f, [x1, ...], [S1, ...])` represents the set of all values that can be obtained by substituting, for each  $i$ , the identifier  $x_i$  by some element of  $S_i$  in the expression  $f$ .

`Dom::ImageSet(f, x, S)` represents the set  $\{f \mid x \in S\}$ . `Dom::ImageSet(f, [x1, ..., xn], [S1, ..., Sn])` represents the set  $\{f \mid x_i \in S_i, i = 1 \dots n\}$ .  $f$  need not contain  $x$ ; on the other hand, it may contain other identifiers (free variables).

If a list of several identifiers is given, the identifiers must be distinct.

$S$  must be a set; see `solve` for an overview of the different kinds of sets in MuPAD.

`Dom::ImageSet` carries out some automatical simplifications that may produce a result of a type different from `Dom::ImageSet`.

`Dom::ImageSet` renames the variables  $x_1, \dots, x_n$ , in order to avoid naming conflicts as well as producing a nicer output.

## Superdomain

`Dom::BaseDomain`

## Categories

`Cat::Set`

## Examples

### Example 1

We define  $S$  to be the set of all integer multiples of  $\pi$ .

```
S := Dom::ImageSet(ugly*PI, ugly, Z_)
```

$$\{\pi k \mid k \in \mathbb{Z}\}$$

Our ugly variable name has been replaced by a nicer one which suggests that it represents an integer.

We may now apply the usual set-theoretic operations.

```
S intersect Dom::Interval(3..7)
```

$$\{\pi, 2\pi\}$$

## Example 2

An element of an image set may be obtained by substituting all parameters by some values:

```
S := Dom::ImageSet(a^7 + b^3 + C, [a, b], [Z_, Z_])
```

$$\{k^7 + l^3 + C \mid k \in \mathbb{Z}, l \in \mathbb{Z}\}$$

On calling the `evalParam` method, we have to take care that the variable names have been replaced.

```
Dom::ImageSet::evalParam(S, k = 3, l = 5)
```

$$C + 2312$$

The same may be achieved using the index operator:

```
S[3, 5]
```

$$C + 2312$$

Substituting only for one parameter, we obtain an image set in the other parameter:

```
Dom::ImageSet::evalParam(S, k = 3)
```

$$\{l^3 + C + 2187 \mid l \in \mathbb{Z}\}$$

A parameter may be substituted by itself, meaning that it becomes a free variable:

`Dom::ImageSet::evalParam(S, k = k)`

$$\{k^7 + l^3 + C \mid l \in \mathbb{Z}\}$$

The `evalParam` method cannot be used to substitute a free variable:

`Dom::ImageSet::evalParam(S, C = 3)`

$$\{k^7 + l^3 + C \mid k \in \mathbb{Z}, l \in \mathbb{Z}\}$$

`delete S:`

## Parameters

**f**

Arithmetical expression

**x**

Identifier or indexed identifier

**S**

Set of any type

## Methods

### Mathematical Methods

**changevar** — Change the name of a variable

`changevar(A, oldvar, newvar)`

The new variable `newvar` must not equal any element of the list of variables; this is not checked!

**setvar — Set the name of the variable**

```
setvar(A, newvar)
```

```
setvar(A, newvar)
```

For an argument `A` that is not an image set, the method "setvar" is applied to all image sets contained in the expression `A`. `A` might be, for example, a union, intersection, etc. of image sets and other sets.

**homogpointwise — Define an n-ary pointwise operator for image sets**

```
homogpointwise(Op)
```

`Op` must accept arithmetical expressions as arguments.

**isEmpty — Test whether a set is empty**

```
isEmpty(A)
```

**substituteBySet — Substitute an ImageSet for a variable**

```
substituteBySet(a, x, A)
```

**freeIndets — Free parameters of a set**

```
freeIndets(A)
```

If  $A = \{f(x_1, \dots, x_n, y_1, \dots, y_k) \mid x_i \in S_i\}$ , the  $x_i$  are called bound and the  $y_i$  are called free parameters.

Use the slot "variables" to obtain the bound parameters.

**evalParam — Insert values for bound parameters**

```
evalParam(A(x = value, ...))
```

If `x` is not a parameter, but a free variable of `A`, it is not substituted by `value`.

value may be an identifier or contain identifiers; in particular, it may contain  $x$  and/or some of the remaining parameters. This may be used to convert parameters into free variables.

Several parameters may be replaced in a single call.

See “Example 2” on page 7-206 (Symbolic Math Toolbox).

### **`_index` — Extract element by inserting values for bound parameters**

`_index(A, value1, ...)`

The number of values passed must match the number of variables of  $A$ .

It is not checked whether for each  $i$ , the value for the  $i$ th parameter belongs to the  $i$ th set.

See “Example 2” on page 7-206 (Symbolic Math Toolbox).

## **Access Methods**

### **`expr` — Defining mapping as an expression**

`expr(A)`

This method overloads the function `expr`.

### **`variables` — List of variables**

`variables(A)`

The free parameters (identifiers appearing in  $f$  other than the  $x_i$ ) can be obtained using the “freeIndets” slot.

### **`nvars` — Number of variables**

`nvars(A)`

### **`sets` — List of sets**

`sets(A)`

## **Technical Methods**

**print** — Print image set

print(A)

# Dom::Integer

Ring of integer numbers

## Syntax

`Dom::Integer(x)`

## Description

`Dom::Integer` is the ring of integer numbers represented by elements of the domain `DOM_INT`.

Elements of `Dom::Integer` are usually not created explicitly. However, if one creates elements using the usual syntax, it is checked whether the input is an integer number. This means that `Dom::Integer` is a façade domain which creates elements of domain type `DOM_INT`.

Viewed as a differential ring `Dom::Integer` is trivial, it contains constants only.

`Dom::Integer` has the domain `Dom::Numerical` as its super domain, i.e., it inherits each method which is defined by `Dom::Numerical` and not re-implemented by `Dom::Integer`. Methods described below are those implemented by `Dom::Integer`.

## Superdomain

`Dom::Numerical`

## Axioms

`Ax::canonicalRep`, `Ax::systemRep`, `Ax::canonicalOrder`,  
`Ax::canonicalUnitNormal`, `Ax::closedUnitNormals`,  
`Ax::efficientOperation("_divide")`, `Ax::efficientOperation("_mult")`

## Categories

Cat::EuclideanDomain, Cat::FactorialDomain, Cat::DifferentialRing,  
Cat::OrderedSet

## Examples

### Example 1

Creating some integer numbers using `Dom::Integer`. This example also shows that `Dom::Integer` is a façade domain.

```
Dom::Integer(2); domtype(%)
```

```
2
```

```
DOM_INT
```

```
Dom::Integer(2/3)
```

```
Error: Invalid arguments. [Dom::Integer::new]
```

### Example 2

By tracing the method `Dom::Integer::testtypeDom` we can see the interaction between `testtype` and `Dom::Integer::testtypeDom`.

```
prog::trace(Dom::Integer::testtypeDom):  
delete x:  
testtype(x, Dom::Integer);  
testtype(3, Dom::Integer);  
prog::untrace(Dom::Integer::testtypeDom):
```

```
enter Dom::Integer::testtypeDom(x, Dom::Integer)  
computed FALSE
```

```
FALSE
```



```
enter Dom::Integer::testtypeDom(3, Dom::Integer)
computed TRUE
```

TRUE

## Parameters

**x**

An integer

## Methods

### Mathematical Methods

**associates** — Associate elements

associates(x, y)

**\_divide** — Division of two objects

\_divide(x, y)

**\_divides** — Decide if a number divides another one

\_divides(x, y)

**euclideanDegree** — Euclidean degree

euclideanDegree(x)

**factor** — Factorization

factor(x)

**gcd — Gcd computation**

gcd(x1, x2, ...)

**gcdex — Apply the extended Euclidean algorithm**

gcdex(x, y)

**\_invert — Inverse of an element**

\_invert(x)

**irreducible — Prime number test**

irreducible(x)

**isUnit — Test if an element is a unit**

isUnit(x)

**lcm — Compute the lcm**

lcm(x1, x2, ...)

**quo — Compute the euclidean quotient**

quo(x, y)

**random — Random number generation**

random()

random(n)

random(m .. n)

This methods returns a random number between 0 and  $n - 1$ .

This methods returns a random number between  $m$  and  $n$ .

**rem — Compute the Euclidean reminder**

rem(x, y)

**unitNormal — Unit normal part**`unitNormal(x)`**unitNormalRep — Unit normal representation**`unitNormalRep(x)`

## Conversion Methods

**convert — Conversion of objects**`convert(x)`**convert\_to — Conversion to other domains**`convert_to(x, T)`

The following domains are allowed for T: DOM\_INT, Dom::Integer, Dom::Rational, DOM\_FLOAT, Dom::Float and Dom::Numerical.

**testtype — Type checking**`testtype(x, T)`

Usually, this method is called from the function `testtype` and not directly by the user. “Example 2” on page 7-212 (Symbolic Math Toolbox) demonstrates this behavior.

## See Also

**MuPAD Domains**`Dom::Complex | Dom::Float | Dom::Numerical | Dom::Rational | Dom::Real`

## Dom::IntegerMod

Residue class rings modulo integers

### Syntax

#### Domain Creation

`Dom::IntegerMod(n)`

#### Element Creation

`Dom::IntegerMod(n)(a)`

### Description

#### Domain Creation

`Dom::IntegerMod(n)` creates the residue class ring of integers modulo  $n$ .

`Dom::IntegerMod(n)` creates the integer residue class rings  $\mathbb{Z}/n\mathbb{Z}$ .

#### Element Creation

`Dom::IntegerMod(n)(a)` creates the residue class of  $a$  modulo  $n$ .

### Superdomain

`Dom::BaseDomain`

## Axioms

```
Ax::normalRep, Ax::canonicalRep, Ax::noZeroDivisors,
Ax::closedUnitNormals, Ax::canonicalUnitNormal,
Ax::efficientOperation("_invert"), Ax::efficientOperation("_divide"),
Ax::efficientOperation("_mult")
```

## Categories

If  $n$  is prime, then `Cat::Field`, else `Cat::CommutativeRing`.

## Examples

### Example 1

We define the residue class ring of the integers mod 7:

```
Z7:= Dom::IntegerMod(7)
```

```
Dom::IntegerMod(7)
```

Next, we create some elements:

```
a:= Z7(1); b:= Z7(2); c:= Z7(3)
```

```
1 mod 7
```

```
2 mod 7
```

```
3 mod 7
```

We may use infix notation for arithmetical operations since the operators have been overloaded:

$a + b, a*b*c, 1/c, b/c/a/c$

$3 \bmod 7, 6 \bmod 7, 5 \bmod 7, 1 \bmod 7$

a and b are squares while c is not:

$Z7::isSquare(a), Z7::isSquare(b), Z7::isSquare(c)$

TRUE, TRUE, FALSE

Indeed, c is a generator of the group of units:

$Z7::order(a), Z7::order(b), Z7::order(c)$

1, 3, 6

## Parameters

**n**

Positive integer greater than 1

**a**

Any integer or a rational number whose denominator is coprime to n

## Entries

"characteristic"	the characteristic of the residue class ring, n
"one"	the unit element, $1 \bmod n$
"zero"	the zero element, $0 \bmod n$

## Methods

### Mathematical Methods

**`_divide` — Division of two elements**

`_divide(element1, element2)`

**`_invert` — Invert elements**

`_invert(element)`

**`_mult` — Multiply elements**

`_mult(element, ...)`

**`_negate` — Negate elements**

`_negate(element)`

**`_plus` — Add elements**

`_plus(element, ...)`

**`_power` — Power of elements**

`_power(element, power)`

**`_subtract` — Subtraction of two elements**

`_subtract(element1, element2)`

**`D` — Return derivative**

Inherited from `Cat::CommutativeRing`.

**`associates` — Test for associate elements**

Inherited from `Cat::Field`.

**coerce — Coerce into this domain**

Inherited from `Cat::BaseCategory`.

**diff — Differentiate element**

Inherited from `Cat::CommutativeRing`.

**divide — Division with remainder**

Inherited from `Cat::Field`.

**divides — Test if division is exact**

Inherited from `Cat::Field`.

**equal — Test for mathematical equality**

Inherited from `Dom::BaseDomain`.

**equiv — Test for equivalence**

Inherited from `Cat::BaseCategory`.

**euclideanDegree — Return Euclidean degree**

Inherited from `Cat::Field`.

**factor — Unique factorization**

Inherited from `Cat::Field`.

**gcd — Greatest common divisor**

Inherited from `Cat::Field`.

**gcdex — Extended greatest common divisor**

Inherited from `Cat::EuclideanDomain`.

**idealGenerator — Generator of finitely generated ideal**

Inherited from `Cat::EuclideanDomain`.



**irreducible — Test if element is irreducible**

Inherited from `Cat::Field`.

**isUnit — Test if element is an unit**

Inherited from `Cat::Field`.

**isone — Test if element is one**

Inherited from `Cat::Monoid`.

**lcm — Least common multiple**

Inherited from `Cat::GcdDomain`.

**quo — Return Euclidean quotient**

Inherited from `Cat::Field`.

**rem — Return Euclidean remainder**

Inherited from `Cat::Field`.

**sqrfree — Square-free factorization**

Inherited from `Cat::Field`.

**testtype — Test type of object**

Inherited from `Cat::BaseCategory`.

**isSquare — Test for being a square**

`isSquare(element)`

**iszero — Zero test**

`iszero(element)`

**ln — Discrete logarithm**

`ln(element, base)`

The result is `infinity` if `element` is not in the subgroup generated by `base`.

The result is `FAIL` if `base` is not a unit.

**order — Order**

`order(element)`

The result is `FAIL` if `element` is not a unit.

## Access Methods

**subs — Avoid substitution**

Inherited from `Dom::BaseDomain`.

**subsex — Avoid extended substitution**

Inherited from `Dom::BaseDomain`.

## Conversion Methods

**convert — Conversion**

`convert(number)`

The conversion fails if the denominator of `number` and the modulus `n` are not relatively prime.

**convert\_to — Conversion**

`convert_to(element, d)`

**expr — Convert an element to an expression**

`expr(element)`

## Technical Methods

**allAxioms** — Return all axioms

Inherited from Dom::BaseDomain.

**allCategories** — Return all categories

Inherited from Dom::BaseDomain.

**allEntries** — Return the names of all entries

Inherited from Dom::BaseDomain.

**allSuperDomains** — Return all super-domains

Inherited from Dom::BaseDomain.

**getAxioms** — Return axioms stated in the constructor

Inherited from Dom::BaseDomain.

**getCategories** — Return categories stated in the constructor

Inherited from Dom::BaseDomain.

**getSuperDomain** — Return super-domain stated in the constructor

Inherited from Dom::BaseDomain.

**hasProp** — Test for a certain property

Inherited from Dom::BaseDomain.

**info** — Print short information about this domain

Inherited from Dom::BaseDomain.

**new** — Create element of this domain

Inherited from Cat::BaseCategory.

**print — Printing elements**

print(element)

**printMethods — Print out methods**

Inherited from Dom::BaseDomain.

**random — Random element**

random()

**undefinedEntries — Return missing entries**

Inherited from Dom::BaseDomain.

**unitNormal — Unit normal form**

Inherited from Cat::Field.

**unitNormalRep — Unit normal representation**

Inherited from Cat::Field.

**whichEntry — Return the domain or category implementing an entry**

Inherited from Dom::BaseDomain.

## See Also

**MuPAD Domains**

Dom::GaloisField | Dom::Integer

# Dom::Interval

Intervals of real numbers

## Syntax

`Dom::Interval(l, r)`

`Dom::Interval([l], r)`

`Dom::Interval(l, [r])`

`Dom::Interval([l], [r])`

`Dom::Interval([l, r])`

## Description

`Dom::Interval` represents the set of all intervals of real numbers.

`Dom::Interval(l, r)` creates the interval of all real numbers between  $l$  and  $r$ . If a border is given as a list with  $l$  or  $r$  as the sole element, this border will be regarded as a closed border, otherwise the interval does not contain  $l$  and  $r$ .

A border can be any arithmetical expression that could represent a real number, e.g., `sqrt(2*x)` and `a + I`. Properties (Symbolic Math Toolbox) are ignored.

The domain `Dom::Interval` provides fundamental operations to combine intervals with intervals and other mathematical objects.

The return value can be either an interval of type `Dom::Interval` or the empty set of type `DOM_SET`, if the interval is empty.

Most mathematical operations are overloaded to work with intervals (such as `sin`). If  $f$  is a function of  $n$  real variables, its extension to intervals is defined to be

$f(J_1, \dots, J_n) = \{f(j_1, \dots, j_n) \mid j_i \in J_i\}$ . The return value of such an operation is in most cases an interval, a union on page 1-1081 of intervals, a `Dom::ImageSet` or a set on page 7-50. For example, the sine of an interval  $[a, b]$  is the interval  $\{\sin(x), x \text{ in } [a,$

b]] that contains all sine values of the given interval. In general, you should expect the return value to be an interval larger than strictly necessary. Also note that, when using the same interval twice in one formula, the uses are regarded as independent, so `interval1/interval1` does not return the interval `[1, 1]` as you might expect.

The functions overloaded in this way are:

- `_mult, _divide, _invert, _power`
- `_plus, _negate, _subtract`
- `abs`
- `cos, arccos, cosh, arccosh, cot, arccot, coth, arccoth, csc, arccsc, csch, arccsch, sec, arcsec, sech, arcsech, sin, arcsin, sinh, arcsinh, tan, arctan, tanh, arctanh`
- `dirac, heaviside`
- `exp, ln`
- `sign`

Furthermore, an interval is a special type of set. This is reflected by `Dom::Interval` having the category `Cat::Set`. Among the methods inherited from `Cat::Set`, the following are especially important: `intersect`, `minus` and `union`.

An interval can be open or closed. If one border is given as a list on page 7-41 with one element `[x]`, then this element `x` is taken as border and the interval will be created as closed at this side. If the interval should be closed at both sides, one list with the both borders as arguments can be given.

## Superdomain

`Dom::BaseDomain`

## Categories

`Cat::Set, Cat::AbelianMonoid`

## Examples

### Example 1

First create a closed interval between 0 and 1.

```
A:= Dom::Interval([0], [1])
```

$[0, 1]$

Now another open interval between -1 and 1.

```
B:= Dom::Interval(-1, 1)
```

$(-1, 1)$

Intervals can be handled like other objects.

```
A + B, A - B, A*B, A/B
```

$(-1, 2), (-1, 2), (-1, 1), \mathbb{R}$

```
2*A, 1 - A, (A - 1)^2
```

$[0, 2], [0, 1], [0, 1]$

### Example 2

Standard functions are overloaded to work with intervals.

```
sin(B), float(sin(B))
```

$(-\sin(1), \sin(1)), (-0.8414709848, 0.8414709848)$

### Example 3

The next examples shows some technical methods to access and manipulate intervals.

Get the borders and open/closed information about intervals.

```
A:= Dom::Interval([0], [1]):  
Dom::Interval::left(A), Dom::Interval::leftB(A)
```

```
0, [0]
```

```
Dom::Interval::isleftopen(A), Dom::Interval::subleft(A, -1)
```

```
FALSE, [-1, 1]
```

### Parameters

**l**

The left border. If given as a list of one element (the left border), the interval will be created as left closed.

**r**

The right border. If given as a list of one element (the right border), the interval will be created as right closed.

### Entries

"one"	the unit element; it equals the one-point interval [1, 1].
"zero"	the zero element; it equals the one-point interval [0, 0].



## Methods

### Mathematical Methods

**Im** — Imaginary part of an interval (this always equals zero)

Im(interval)

**Re** — Real part of an interval (this is the interval)

Re(interval)

**\_divide** — Divide intervals

\_divide(interval1, interval2)

**\_intersect** — Intersection of sets

Inherited from `Cat::Set`.

**\_invert** — Invert intervals

\_invert(interval)

**\_minus** — Set of subtractions

Inherited from `Cat::Set`.

**\_mult** — Set of product of set elements

Inherited from `Cat::Set`.

**\_negate** — Negate intervals

\_negate(interval)

**\_plus** — Set of sums of set elements

Inherited from `Cat::Set`.

**\_\_power — Pointwise power**

Inherited from `Cat :: Set`.

**\_\_union — Union of sets**

Inherited from `Cat :: Set`.

**abs — Absolute value of intervals**

`abs(interval)`

**arccos — Inverse cosine of intervals**

`arccos(interval)`

**arccosh — Area cosine of intervals**

`arccosh(interval)`

**arccot — Inverse cotangent of intervals**

`arccot(interval)`

**arccoth — Area cotangent of intervals**

`arccoth(interval)`

**arcsin — Inverse sine of intervals**

`arcsin(interval)`

**arcsinh — Area sine of intervals**

`arcsinh(interval)`

**arctan — Inverse tangent of intervals**

`arctan(interval)`

**arctanh — Area tangent of intervals**

`arctanh(interval)`

**coerce — Coerce into this domain**

Inherited from `Cat::BaseCategory`.

**contains — Containing an element**

`contains(interval, element)`

**cos — Cosine of intervals**

`cos(interval)`

**cosh — Hyperbolic cosine of intervals**

`cosh(interval)`

**cot — Cotangent of intervals**

`cot(interval)`

**coth — Hyperbolic cotangent of intervals**

`coth(interval)`

**dirac — Dirac distribution of an interval**

`dirac(interval)`

**equiv — Test for equivalence**

Inherited from `Cat::BaseCategory`.

**exp — Exponential function of an interval**

`exp(interval)`

**heaviside — Heaviside function**

`heaviside(interval)`

**intmult — Return integer multiple**

Inherited from `Cat::AbelianMonoid`.

**ln — Natural logarithm of an interval**

ln(interval)

**max — Maximum of an interval**

max(interval, ...)

The maximum of intervals is the set of all possible results of the function `max` when applied to a sequence of arguments consisting of exactly one element of each interval.

**min — Minimum of an interval**

min(interval, ...)

The minimum of intervals is defined analogously to their maximum.

**new — Create an interval**

new(left, right)

new([left], right)

new(left, [right])

new([left], [right])

**sign — Signum of an interval**

sign(interval)

**sin — Sine of intervals**

sin(interval)

**sinh — Hyperbolic sine of intervals**

sinh(interval)

**tan — Tangent of intervals**

tan(interval)

**tanh — Hyperbolic tangent of intervals**`tanh(interval)`

## Access Methods

**borders — Border of an interval**`borders(interval)`**left — Left border of an interval**`left(interval)`**leftB — Left border of an interval**`leftB(interval)`**isleftopen — Left open interval**`isleftopen(interval)`**isrightopen — Right open interval**`isrightopen(interval)`**iszero — Null interval**`iszero(interval)`**op — Operand (borders) of an interval**`op(interval)`**subs — Substitution in intervals**`subs(Interval, equation, ...)`**subsex — Avoid extended substitution**

Inherited from Dom::BaseDomain.

**subleft — Substitute left border**

subleft(interval, left)

**subright — Substitute right border**

subright(interval, right)

**subvals — Substitute both borders**

subvals(interval, left, right)

## **Conversion Methods**

**convert — Converting objects to intervals**

convert(object)

If the conversion fails, FAIL is returned.

**convert\_to — Convert element**

Inherited from Dom::BaseDomain.

**float — Convert to floating-point interval**

float(interval)

**getElement — One element of an interval**

getElement(interval)

**simplify — Simplify intervals**

simplify(interval)

**testtype — Test type of object**

Inherited from Cat::BaseCategory.

## Technical Methods

### **allAxioms — Return all axioms**

Inherited from Dom::BaseDomain.

### **allCategories — Return all categories**

Inherited from Dom::BaseDomain.

### **allEntries — Return the names of all entries**

Inherited from Dom::BaseDomain.

### **allSuperDomains — Return all super-domains**

Inherited from Dom::BaseDomain.

### **emptycheck — Check intervals**

emptycheck(interval)

### **equal — Comparison of intervals**

equal(interval, interval)

### **getAxioms — Return axioms stated in the constructor**

Inherited from Dom::BaseDomain.

### **getCategories — Return categories stated in the constructor**

Inherited from Dom::BaseDomain.

### **getSuperDomain — Return super-domain stated in the constructor**

Inherited from Dom::BaseDomain.

### **hasProp — Test for a certain property**

Inherited from Dom::BaseDomain.

**info — Print short information about this domain**

Inherited from `Dom::BaseDomain`.

**map — Apply functions to intervals**

`map(interval, function, <argument, ...>)`

**mapBorders — Apply functions to the borders of an interval**

`mapBorders(interval, function, <argument, ...>)`

**print — Printing intervals**

`print(interval)`

**printMethods — Print out methods**

Inherited from `Dom::BaseDomain`.

**random — Random interval**

`random()`

**undefinedEntries — Return missing entries**

Inherited from `Dom::BaseDomain`.

**whichEntry — Return the domain or category implementing an entry**

Inherited from `Dom::BaseDomain`.

**zip — Combine intervals**

`zip(interval, interval, function)`

## Algorithms

The operand of an object of `Dom::Interval` is an object of the domain property: `IVnat`, which realizes the basic interval arithmetic. This domain is not documented.



## See Also

### **MuPAD Functions**

Type::Interval

# Dom::LinearOrdinaryDifferentialOperator

Domain of linear ordinary differential operators

## Syntax

### Domain Creation

Dom::LinearOrdinaryDifferentialOperator(<Var, <DVar, <Ring>>>)

### Element Creation

Dom::LinearOrdinaryDifferentialOperator(Var, DVar, Ring)(p)

Dom::LinearOrdinaryDifferentialOperator(Var, DVar, Ring)(l)

Dom::LinearOrdinaryDifferentialOperator(Var, DVar, Ring)(eq, yx)

## Description

Dom::LinearOrdinaryDifferentialOperator(Var, DVar, Ring) creates the domain of linear ordinary differential operators with coefficients in the differential ring Ring and with derivation Var where DVar is the differential indeterminate. Elements of this domain are also called Ore polynomials and the multiplication of two elements is

completely determined by the prescribed rule  $\text{Var } r = r \text{ Var} + \frac{\partial}{\partial \text{Var}} r$  for every element  $r$  in Ring. And so Dom::LinearOrdinaryDifferentialOperator is a noncommutative ring.

---

**Note** Nevertheless, for some reasons, for every element  $r$  in Ring,  $\text{Var} * r$  is automatically rewritten as  $r * \text{Var}$ . See “Example 1” on page 7-239 (Symbolic Math Toolbox).

---

If `Dom::LinearOrdinaryDifferentialOperator` is called without any argument, a domain with coefficients in `Dom::ExpressionField(normal)` with derivation `Df` and differential indeterminate `x` is created.

---

**Note** Only commutative differential rings of type `DOM_DOMAIN` are allowed which inherit from `Dom::BaseDomain`. If `Ring` is of type `DOM_DOMAIN` but does not inherit from `Dom::BaseDomain`, the domain `Dom::ExpressionField(normal)` will be used instead.

---



---

**Note** It is highly recommend to use only coefficient rings with unique zero representation. Otherwise it can happen that, e.g., a polynomial division will not terminate or a wrong degree will be returned.

---

## Examples

### Example 1

First we create the domain of linear ordinary differential operators:

```
lodo := Dom::LinearOrdinaryDifferentialOperator()
```

```
Dom::LinearOrdinaryDifferentialOperator(Df, x, Dom::ExpressionField(normal, iszero
◦ normal))
```

by default the above domain has coefficients in the field `Dom::ExpressionField(normal)` with derivation `Df` and differential indeterminate `x`.

We can create elements of `lodo` in 3 ways: polynomials in `Df`, list of elements of `Dom::ExpressionField` and with a linear ordinary homogeneous differential equation:

```
lodo(Df^2 + (x + 1)*Df + 2*x), lodo([2*x, x + 1, 1]),
lodo(diff(y(x),x,x) + (x + 1)*diff(y(x),x) + 2*x*y(x), y(x))
```

```
Df^2 + (x + 1) Df + 2 x, Df^2 + (x + 1) Df + 2 x, Df^2 + (x + 1) Df + 2 x
```

It's easy to obtain the linear differential equation associated to a linear differential operator:

```
L := lodo((x + x^3)*Df^3 + (6*x^2 + 3)*Df^2 - 12):
L(y(x))
```

$$6x^2 \frac{\partial^2}{\partial x^2} y(x) - 12 y(x) + x \frac{\partial^3}{\partial x^3} y(x) + x^3 \frac{\partial^3}{\partial x^3} y(x) + 3 \frac{\partial^2}{\partial x^2} y(x)$$

and one can also evaluate a differential operator at an expression:

```
L(2*x^2 + 1), L(ln(x)), L(ln(x), Unsimplified)
```

$$0, -\frac{12x^2 \ln(x) + 4x^2 + 1}{x^2}, \frac{2(x^3 + x)}{x^3} - \frac{6x^2 + 3}{x^2} - 12 \ln(x)$$

Multiplication of elements of `lodo` is noncommutative but for every element `r` of the coefficients ring one has `Df*r = r*Df`:

```
lodo(x^2*Df), lodo(Df*x^2), lodo(Df)*lodo(x^2)
```

$$x^2 Df, x^2 Df, x^2 Df + 2x$$

## Example 2

`Dom::LinearOrdinaryDifferentialOperator` is a domain where the Euclidean division exists but one has to precise if the multiplication of 2 elements of this domain is made on the right or on the left side:

```
L1 := lodo(x*Df^3 + (x^2 - 3)*Df^2 + 4*x*Df + 2):
lodo::leftDivide(L1, lodo(x*Df + 1))
```

quotient	$Df^2 + \frac{Df(x^2 - 4)}{x} + 2$
remainder	0

```
lodo(x*Df + 1) * %[quotient] = L1
```

$$x Df^3 + (x^2 - 3) Df^2 + (4x) Df + 2 = x Df^3 + (x^2 - 3) Df^2 + (4x) Df + 2$$

Hence one has the notions of greatest common divisor, least common multiple on the right and on the left, and a modified version of the extended Euclidean algorithm:

```
L2 := lodo(x*Df + 1):
ree := lodo::rightExtendedEuclid(L1,L2)
```

$$\left[ \left[ -\frac{12}{x^2}, 1, -Df^2 - \frac{x^2 - 6}{x} Df - \frac{2(x^2 + 6)}{x^2} \right], \right. \\ \left. \left[ \frac{x^3}{12} Df + \frac{x^2}{4}, -\frac{x^3}{12} Df^3 + \left( \frac{x^2}{4} - \frac{x^4}{12} \right) Df^2 - \frac{x^3}{2} Df - \frac{x^2}{2} \right] \right]$$

The right greatest common divisor and the left least common multiple can be read from the above list:

```
iszero(lodo::rightGcd(L1,L2) - ree[1][1]),
iszero(ree[1][1] - (ree[1][2]*L1 + ree[1][3]*L2)),
iszero(lodo::leftLcm(L1,L2) - (-ree[2][1]*L1)),
iszero(-ree[2][1]*L1 - ree[2][2]*L2)
```

TRUE, TRUE, TRUE, TRUE

### Example 3

One can compute polynomial, rational and exponential zeros of linear differential operators of any degree provided the ring Ring is the field of rational functions of  $x$

```
L3 := lodo((x^2 + 1)*x*Df^3 + 3*(2*x^2 + 1)*Df^2 - 12):
lodo::rationalZeros(L3), lodo::exponentialZeros(L3)
```

$$\left\{ x^2 + \frac{1}{2} \right\}, \left\{ x^2 + \frac{1}{2}, x \sqrt{x^2 + 1} \right\}$$

even when the operator contains some parameters rationally:

```
lodo::exponentialZeros(
lodo(Df^4 + (b*l - 2*a^2 - a*l*x)*Df^2 + a^4-a^2*b*l + a^3*l*x))
```

$$\{e^{ax}, e^{-ax}\}$$

### Example 4

One can factorize linear differential operators into irreducible factors when the ring Ring is the field of rational functions of  $x$ . Nevertheless, the algorithm is complete only for operators of degree at most 3; for higher degree only left and right factors of degree 1 are found:

```
factor(lodo((x^2 + 1)*x*Df^3 + 3*(2*x^2 + 1)*Df^2 - 12)),
factor(lodo(Df^3 + a*x*Df + a + b^3 + a*b*x))
```

$$\left( (x(x^2 + 1)) Df + 5x^2 + 3 \right) \left( Df + \frac{x(6x^2 + 5)}{(x^2 + 1)(2x^2 + 1)} \right) \left( Df - \frac{4x}{2x^2 + 1} \right),$$

$$(Df + b) (Df^2 - b Df + ax + b^2)$$

Here the operator factors into two factors of degree 2 which cannot be found by MuPAD:

```
factor(lodo(Df^2 + x^3 + 1/x^3) * lodo(Df^2 + x^2 - 1/x^3))
```

$$Df^4 + (x^2 + x^3) Df^2 + \frac{2(2x^5 + 3)}{x^4} Df + \frac{-12x + x^5 + x^6 + x^{11} - 1}{x^6}$$

### Example 5

Solving linear differential operators using the command solve is also possible:

```
solve(lodo(Df^2 + (3 - x)/(16*x^2)))
```

$$\left\{ x^{1/4} e^{-\frac{\sqrt{x}}{2}}, x^{1/4} e^{\frac{\sqrt{x}}{2}} \right\}$$

For certain cases, where the groups associated to the differential operators are finite primitive groups of degree 2, a polynomial is returned corresponding to the minimal polynomial of all zeros of the differential operator (they are algebraic over the base field):

```
solve(lodo(Df^2 +
(-27*x + 32*x^2 + 27)/(144*x^2 - 288*x^3 + 144*x^4)))
```

$$\begin{aligned} & \text{RootOf}\left(\gamma_1^{24} + (-4320 x^2 (x-1)^3) \gamma_1^{16} + ((51840 \sqrt{3} i) x^3 (x-2) (x-1)^4) \gamma_1^{12} \right. \\ & \quad + (-2799360 x^4 (x-1)^6) \gamma_1^8 + ((4478976 \sqrt{3} i) x^5 (x-1)^7 (x-2)) \gamma_1^4 \\ & \quad \left. + 2985984 x^8 (x-1)^8, \gamma_1\right) \end{aligned}$$

For linear differential operators of degree greater than 3 only exponential zeros will be found:

```
solve(lodo(x*Df^4 + (-x + 4)*Df^3 - 3*Df^2 - x^2*Df - x + x^2))
```

$$\left\{ \frac{e^x}{x} \right\}$$

Certain second degree linear differential operator can be solved in terms of some special functions (nonliouvillian functions) such as `airyAi`, `besselI` and `whittakerM`:

```
solve(lodo(Df^2 - (x + 1)/(x - 1)^5))
```

$$\{\text{airyAi}(\sigma_1, 0) (x-1), \text{airyBi}(\sigma_1, 0) (x-1)\}$$

where

$$\sigma_1 = -\frac{2^{1/3} \sqrt{3} i + 2^{1/3} x + 2^{1/3} \sqrt{3} x i}{4(x-1)}$$

```
solve(lodo(Df^2 - (243 + 4*x^8 + 162*x^2 + 19*x^4)/
          36/x^2/(x^2 + 3)^2))
```

$$\left\{ \frac{M_{\frac{1}{2}, -\frac{2}{3}}\left(\frac{x^2}{3} + 1\right)}{\sqrt{x}}, \frac{W_{\frac{1}{2}, -\frac{2}{3}}\left(\frac{x^2}{3} + 1\right)}{\sqrt{x}} \right\}$$

## Parameters

### Var

An indeterminate of type `DOM_IDENT`. Default is `Df`.

### DVar

A differential indeterminate of type `DOM_IDENT`. Default is `x`.

### Ring

An arbitrary commutative differential ring of characteristic zero. Default is `Dom::ExpressionField(normal)`.

### p

A polynomial expression in `Var`.

### l

A list corresponding to the coefficients of the differential operator. If  $n$  is the length of `l` then the result returned is `l[1] + l[2]*Var + ... + l[n]*Var^(n-1)`.

### eq

A linear homogeneous differential equation.

### yx

A function of `DVar` representing the dependent variable of the above linear differential equation.



## Methods

### Mathematical Methods

#### **`_mult` – Multiply linear differential operators**

`_mult(<a, b, ...>)`

This method overloads the function `_mult` of the system kernel, i.e. one may use it either in the form `a * b * ...` or in functional notation `_mult(a, b, ...)`.

#### **`_negate` – Negate a linear differential operator**

`_negate(a)`

This method overloads the function `_negate` of the system kernel, i.e. one may use it either in the form `-a` or in functional notation `_negate(a)`.

#### **`_plus` – Add linear differential operators and coefficient ring elements**

`_plus(<a, b, ...>)`

This method overloads the function `_plus` of the system kernel, i.e. one may use it either in the form `a + b + ...` or in functional notation `_plus(a, b, ...)`.

#### **`_power` – Nth power of a linear differential operator**

`_power(a, n)`

This method overloads the function `_power` of the system kernel, i.e., one may use it either in the form `a^n` or in functional notation `_power(a, n)`.

#### **`_subtract` – Subtract a linear differential operator**

`_subtract(a, b)`

This method overloads the function `_subtract` of the system kernel, i.e. one may use it either in the form `a - b` or in functional notation `_subtract(a, b)`.

**adjoint — Adjoint of a linear differential operator**

adjoint(a)

**companionSystem — Companion matrix of a linear differential operator**

companionSystem(a)

If a is not of positive degree, an error message is issued.

**D — Derivative of a linear differential operator**

D(<l>, a)

**Dpoly — Derivative of a linear differential operator**

Dpoly(<l>, a)

Dpoly(l, a) computes the partial derivative of a with respect to l. If  $l = [1, \dots, 1]$  with  $\text{length}(l) = n$  then the method computes the n-th derivative a. If  $l = []$  then the result returned is a.

**evalL0D0 — Apply an expression to a linear differential operator**

evalL0D0(a, f)

This method may be used either in the form  $a(f)$  or in functional notation  $\text{evalL0D0}(a, f)$ .

**exponentialZeros — Exponential zeros of a linear differential operator**

exponentialZeros(a)

---

**Note** This method only works when Ring is the field of rational functions in DVar.

---

**factor — Factor a linear differential operator**

factor(a)

**Note** This method is only available when the base field Ring is the field of rational functions in DVar. If a is of degree greater than or equal to 4 then only left and right factors of degree 1 of a will be found. Otherwise, a complete factorization is returned.

---

This method overloads the function factor of the system kernel.

**factors** — List of irreducible factors of a linear differential operator

factors(a)

**func\_call** — Apply an expression to a linear differential operator

func\_call(a, f, <Unsimpified>)

This method may be used either in the form a(f) or in functional notation func\_call(a, f).

**leftDivide** — Left division of 2 linear differential operators

leftDivide(a, b)

**leftExtendedEuclid** — Left extended Euclidean algorithm for linear differential operators

leftExtendedEuclid(a, b)

**leftExtendedGcd** — Coefficient in the left extended Euclidean algorithm

leftExtendedGcd(a, b)

**leftGcd** — Left greatest common divisor of linear differential operators

leftGcd(a, b)

**leftLcm** — Left least common multiple of linear differential operators

leftLcm(a, b)

**leftQuotient** — Left quotient of linear differential operators

leftQuotient(a, b)

**LeftRemainder** — Left remainder of linear differential operators

leftRemainder(a, b)

**makeIntegral** — Integral form of a linear differential operator

makeIntegral(a)

**monic** — Normalize a linear differential operator

monic(a)

**polynomialZeros** — Polynomial zeros of a linear differential operator

polynomialZeros(a)

---

**Note** This method only works when Ring is the field of rational functions in DVar.

---

**rationalZeros** — Rational zeros of a linear differential operator

rationalZeros(a)

---

**Note** This method only works when Ring is the field of rational functions in DVar.

---

**rightDivide** — Right division of 2 linear differential operators

rightDivide(a, b)

**rightExtendedEuclid** — Right extended Euclidean algorithm for linear differential operators

rightExtendedEuclid(a, b)

**rightExtendedGcd** — Coefficient in the right extended Euclidean algorithm

rightExtendedGcd(a, b)

**rightGcd** — Right greatest common divisor of linear differential operators

rightGcd(a, b)

**rightLcm — Right least common multiple of linear differential operators**`rightLcm(a, b)`**rightQuotient — Right quotient of linear differential operators**`rightQuotient(a, b)`**rightRemainder — Right remainder of linear differential operators**`rightRemainder(a, b)`**solve — Zero of a linear differential operator**`solve(a, <Transform>, <Irreducible>)`

The algorithm for finding liouvillian solutions is complete for operators of degree at most 2 and enables to solve partially operators of higher degree (i.e. it finds all exponential solutions). The algorithm for finding solutions in terms of special functions (nonliouvillian solutions) is not complete even for the degree 2.

When option `Transform` is given the unimodular transformation is performed unconditionally and when option `Irreducible` is given, `a` is assumed to be irreducible.

---

**Note** This method only works when `Ring` is the field of rational functions in `DVar`.

---

This method overloads the function `solve` of the system kernel.

**symmetricPower — Symmetric power of a linear differential operator**`symmetricPower(a, m)`**unimodular — Unimodular transformation of a linear differential operator**`unimodular(a, <Transform>)`

If the option `Transform` is given then `a` is transformed unconditionally even if `a` has yet a unimodular Galois group.

## Access Methods

### **coeff** — Coefficient of a linear differential operator

`coeff(a)`

`coeff(a, Var, n)`

`coeff(a, n)`

`coeff(a, Var, n)` returns the coefficient of the term  $\text{Var}^n$  as an element of the coefficient ring `Ring`, where `a` is a linear differential operator in the variable `Var`.

`coeff(a, n)` returns the coefficient of the term  $\text{Var}^n$  as an element of the coefficient ring `Ring`, where `a` is a linear differential operator in the variable `Var`.

This method overloads the function `coeff` of the system kernel.

### **degree** — Degree of a linear differential operator

`degree(a)`

The degree of the zero polynomial is defined as zero.

This method overloads the function `degree` for polynomials.

### **vectorize** — List of coefficients of a linear differential operator

`vectorize(a)`

## Conversion Methods

### **convert** — Conversion to a linear differential operator

`convert(a)`

FAIL is returned if the conversion fails.

### **expr** — Conversion into an object of a kernel domain

`expr(a)`

This method overloads the function `expr` of the system kernel.

## Algorithms

Some references on linear differential equations/operators:

- `_mult`, `_divide`, `_invert`, `_power`
- `_plus`, `_negate`, `_subtract`
- `abs`
- `cos`, `arccos`, `cosh`, `arccosh`, `cot`, `arccot`, `coth`, `arccoth`, `csc`, `arccsc`, `csch`, `arccsch`, `sec`, `arcsec`, `sech`, `arcsech`, `sin`, `arcsin`, `sinh`, `arcsinh`, `tan`, `arctan`, `tanh`, `arctanh`
- `dirac`, `heaviside`
- `exp`, `ln`
- `sign`

## See Also

### MuPAD Domains

Dom::UnivariatePolynomial

# Dom::Matrix

Matrices

## Syntax

### Domain Creation

Dom::Matrix(<R>)

### Element Creation

Dom::Matrix(R)(Array)

Dom::Matrix(R)(List)

Dom::Matrix(R)(ListOfRows)

Dom::Matrix(R)(Matrix)

Dom::Matrix(R)(m, n)

Dom::Matrix(R)(m, n, Array)

Dom::Matrix(R)(m, n, List)

Dom::Matrix(R)(m, n, ListOfRows)

Dom::Matrix(R)(m, n, Table)

Dom::Matrix(R)(m, n, [(i<sub>1</sub>, j<sub>1</sub>) = value<sub>1</sub>, (i<sub>2</sub>, j<sub>2</sub>) = value<sub>2</sub>, ...])

Dom::Matrix(R)(m, n, f)

Dom::Matrix(R)(m, n, List, Diagonal)

Dom::Matrix(R)(m, n, g, Diagonal)

Dom::Matrix(R)(m, n, List, Banded)

Dom::Matrix(R)(1, n, Array)



```

Dom::Matrix(R)(1, n, List)
Dom::Matrix(R)(1, n, Table)
Dom::Matrix(R)(1, n, [j1 = value1, j2 = value2, ...])
Dom::Matrix(R)(m, 1, Array)
Dom::Matrix(R)(m, 1, List)
Dom::Matrix(R)(m, 1, Table)
Dom::Matrix(R)(m, 1, [i1 = value1, i2 = value2, ...])

```

## Description

### Domain Creation

`Dom::Matrix(R)` creates domains of matrices over a component domain `R` of category `Cat::Rng` (a ring, possibly without unit).

If the optional parameter `R` is not given, `Dom::ExpressionField()` is used as component domain. Matrices of this type accept arbitrary MuPAD expressions (numbers, symbols etc.) as entries. The name `matrix` is an alias for this default matrix domain `Dom::Matrix()`.

A vector with  $n$  entries is either an  $n \times 1$  matrix (a column vector), or a  $1 \times n$  matrix (a row vector).

Arithmetical operations with matrices can be performed by using the standard arithmetical operators of MuPAD.

E.g., if `A` and `B` are two matrices defined by `Dom::Matrix(R)`, `A + B` computes the sum, and `A * B` computes the product of the two matrices, provided that the dimensions are appropriate.

Similarly, `A^(-1)` or `1/A` computes the inverse of a square matrix `A` if it exists. Otherwise, `FAIL` is returned. See “Example 1” on page 7-257 (Symbolic Math Toolbox).

Many system functions are overloaded for matrices, such as `map`, `subs`, `has`, `zip`, E.g., use `conjugate` to compute the complex conjugate of a matrix, `norm` to compute matrix norms, or `exp` to compute the exponential of a matrix.

Most of the functions in the MuPAD linear algebra package `linalg` (Symbolic Math Toolbox) work with matrices. For example, the command `linalg::gaussJordan(A)` performs Gauss-Jordan elimination on  $A$  to transform  $A$  to its reduced row echelon form.

See the documentation of `linalg` (Symbolic Math Toolbox) for a list of available functions of this package.

The domain `Dom::Matrix(R)` represents matrices over  $R$  of arbitrary size. Therefore, it does not have any algebraic structure (other than being a *set* of matrices).

In this help page, we use the following notations for a matrix  $A$  (an element of `Dom::Matrix(R)`):

- $nrows(A)$  denotes the number of rows of  $A$ .
- $ncols(A)$  denotes the number of columns of  $A$ .
- A *row index* is an integer in the range from 1 to  $nrows(A)$ .
- A *column index* is an integer in the range from 1 to  $ncols(A)$ .

---

**Note** The number of rows and columns, respectively, of a matrix must be less than  $2^{31}$ .

---

---

**Note** The components of a matrix are no longer evaluated after the creation of the matrix, i.e., if they contain free identifiers they will not be replaced by their values.

---

## Element Creation

`Dom::Matrix(R)(Array)` and `Dom::Matrix(R)(Matrix)` create a new matrix with the dimension and the components of `Array` and `Matrix`, respectively.

The components of `Array` or `Matrix` are converted to elements of the domain  $R$ . An error message is issued if one of these conversions fails.

The creation of (sparse) matrices via arrays is useful for matrices of moderate size. Note that indexed assignments to arrays are much faster than the corresponding indexed assignments to matrices. However, since all elements of the array (including the zeroes) need to be filled in before conversion to a (sparse) matrix, memory is wasted for very large and very sparse matrices. In such a situation, one should define a table containing only the non-zero elements and convert the table to a matrix (see below).

`Dom::Matrix(R)(List)` creates an  $m \times 1$  column vector with components taken from the nonempty list on page 7-41, where  $m$  is the number of entries of `List`.

One may also use a list of equations to create an object of `Dom::Matrix`. In this case the entries of the list must be of the form  $(i, j) = \text{value}$ , where  $i$  and  $j$  denote the row and column index and `value` the coefficient of the matrix.  $i$  and  $j$  need to be positive integers.

`Dom::Matrix(R)(ListOfRows)` creates an  $m \times n$  matrix with components taken from the nested list on page 7-41 `ListOfRows`, where  $m$  is the number of inner lists of `ListOfRows`, and  $n$  is the maximal number of elements of an inner list. Each inner list corresponds to a row of the matrix. Both  $m$  and  $n$  must be non-zero.

If an inner list has less than  $n$  entries, the remaining components in the corresponding row of the matrix are set to zero.

The entries of the inner lists are converted to elements of the domain  $R$ . An error message is issued if one of these conversions fails.

The call `Dom::Matrix(R)(m, n)` returns the  $m \times n$  zero matrix.

Use the method "identity" to create the  $n \times n$  identity matrix.

The call `Dom::Matrix(R)(m, n, Array)` creates an  $m \times n$  matrix with components taken from `Array`, which must be an array on page 7-2 or an `hfarray` on page 7-27. `Array` must have  $m n$  operands. The first  $m$  operands define the first row, the next  $m$  operands define the second row, etc. The formatting of the array is irrelevant. E.g., any array with 6 elements can be used to create a matrix of dimension  $1 \times 6$ , or  $2 \times 3$ , or  $3 \times 2$ , or  $6 \times 1$ .

`Dom::Matrix(R)(m, n, List)` creates an  $m \times n$  matrix with components taken row after row from the non-empty list on page 7-41. The list must contain  $m n$  entries.

`Dom::Matrix(R)(m, n, ListOfRows)` creates an  $m \times n$  matrix with components taken from the list on page 7-41 `ListOfRows`.

If  $m \geq 2$  and  $n \geq 2$ , then `ListOfRows` must consist of at most  $m$  inner lists, each having at most  $n$  entries. The inner lists correspond to the rows of the returned matrix.

If an inner list has less than  $n$  entries, the remaining components of the corresponding row of the matrix are set to zero. If there are less than  $m$  inner lists, the remaining lower rows of the matrix are filled with zeroes.

`Dom::Matrix(R)(m, n, Table)` creates an  $m \times n$  matrix with components taken from the table on page 1-2103 Table.

By defining the entries of the table first, one can easily create large and sparse matrices. The entry `Table[i, j]` of the table will be the entry in the  $i$ -th row and the  $j$ -th column of the matrix. Therefore, the table needs to be indexed by positive integers  $i$  and  $j$ .

`Dom::Matrix(R)(m, n, [(i1, j1) = value1, (i2, j2) = value2, ...])` is a further way to create a matrix specifying only the non-zero entries  $A[i1, j1] = value1$ ,  $A[i2, j2] = value2$  etc. The ordering of the entries in the input list is irrelevant.

`Dom::Matrix(R)(m, n, f)` returns the matrix whose  $(i, j)$ -th component is the value of the function call `f(i, j)`. The row index  $i$  ranges from 1 to  $m$  and the column index  $j$  from 1 to  $n$ .

The function values are converted to elements of the domain  $R$ . An error message is issued if one of these conversions fails.

`Dom::Matrix(R)(1, n, Array)` returns the  $1 \times n$  row vector with components taken from `Array`. The array or `hfarray Array` must have  $n$  entries.

The entries of the array are converted to elements of the domain  $R$ . An error message is issued if one of these conversions fails.

`Dom::Matrix(R)(1, n, List)` returns the  $1 \times n$  row vector with components taken from `List`. The list `List` must have at most  $n$  entries. If there are fewer entries, the remaining vector components are set to zero.

The entries of the list are converted to elements of the domain  $R$ . An error message is issued if one of these conversions fails.

`Dom::Matrix(R)(1, n, Table)` returns the  $1 \times n$  row vector with components taken from `Table`. The table `Table` must not have more than  $n$  entries. If there are fewer entries, the remaining vector components are regarded as zero.

`Dom::Matrix(R)(m, 1, Array)` returns the  $m \times 1$  column vector with components taken from `Array`. The array or `hfarray Array` must have  $m$  entries.

The entries of the array are converted to elements of the domain  $R$ . An error message is issued if one of these conversions fails.

`Dom::Matrix(R)(m, 1, List)` returns the  $m \times 1$  column vector with components taken from `List`. The list `List` must have at most  $m$  entries. If there are fewer entries, the remaining vector components are set to zero.

The entries of the list are converted to elements of the domain `R`. An error message is issued if one of these conversions fails.

`Dom::Matrix(R)(m, 1, Table)` returns the  $m \times 1$  column vector with components taken from `Table`. The table `Table` must have no more than  $m$  entries. If there are fewer entries, the remaining vector components are regarded as zero.

## Superdomain

`Dom::BaseDomain`

## Axioms

If `R` has `Ax::canonicalRep`, then `Ax::canonicalRep`.

## Categories

`Cat::Matrix(R)`

## Examples

### Example 1

Whenever possible, one should use `Dom::ExpressionField()` as the coefficient domain of matrices - therefore `Dom::ExpressionField()` is the default coefficient domain of matrices.

The components of matrices over `Dom::ExpressionField()` can be arbitrary arithmetical expressions. Consider

```
Mat := Dom::Matrix()
```

Dom::Matrix()

We assigned the domain to the identifier `Mat` and now we can define a matrix  $A$  of two rows, where each row is a list of two elements by the following line:

```
A := Mat([[1, 5], [2, 3]])
```

$$\begin{pmatrix} 1 & 5 \\ 2 & 3 \end{pmatrix}$$

In the same way, we define the following  $2 \times 3$  matrix:

```
B := Mat([[-1, 5/2, 3], [1/3, 0, 2/5]])
```

$$\begin{pmatrix} -1 & \frac{5}{2} & 3 \\ \frac{1}{3} & 0 & \frac{2}{5} \end{pmatrix}$$

and perform matrix arithmetic using the standard arithmetical operators of MuPAD, e.g., the matrix product  $AB$ , the fourth power of  $A$  as well as the scalar multiplication of  $A$

times  $\frac{1}{3}$ :

```
A * B, A ^ 4, 1/3 * A
```

$$\begin{pmatrix} \frac{2}{3} & \frac{5}{2} & 5 \\ -1 & 5 & \frac{36}{5} \end{pmatrix}, \begin{pmatrix} 281 & 600 \\ 240 & 521 \end{pmatrix}, \begin{pmatrix} \frac{1}{3} & \frac{5}{3} \\ \frac{2}{3} & 1 \end{pmatrix}$$

The matrices  $A$  and  $B$  have different dimensions, and therefore the sum of  $A$  and  $B$  is not defined. MuPAD issues an error message:

```
A + B
```

```
Error: Dimensions do not match. [(Dom::Matrix(Dom::ExpressionField()))::_plus]
```

To compute the inverse of  $A$ , just enter:

```
1/A
```

$$\begin{pmatrix} -\frac{3}{7} & \frac{5}{7} \\ \frac{2}{7} & -\frac{1}{7} \end{pmatrix}$$

If a matrix is not invertible, FAIL is the result of this operation. For example, the matrix:

```
C := Mat(2, 2, [[2]])
```

$$\begin{pmatrix} 2 & 0 \\ 0 & 0 \end{pmatrix}$$

is not invertible, hence:

```
C^(-1)
```

FAIL

```
delete A, B, C;
```

## Example 2

We create the domain of matrices over the coefficient ring `Dom::ExpressionField()`:

```
Mat := Dom::Matrix()
```

Dom::Matrix()

Beside standard matrix arithmetic, the library `linalg` (Symbolic Math Toolbox) offers many functions dealing with matrices. For example, if one wants to compute the rank of a matrix, use `linalg::rank`:

```
A := Mat([[1, 2], [2, 4]])
```

$$\begin{pmatrix} 1 & 2 \\ 2 & 4 \end{pmatrix}$$

```
linalg::rank(A)
```

1

Use `linalg::eigenvectors` to compute eigenvalues and eigenvectors of the matrix `A`:

```
linalg::eigenvectors(A)
```

$$\left[ \left[ 0, 1, \left[ \left( \begin{array}{c} -2 \\ 1 \end{array} \right) \right] \right], \left[ 5, 1, \left[ \left( \begin{array}{c} \frac{1}{2} \\ 1 \end{array} \right) \right] \right] \right]$$

Try `info(linalg)` for a list of available functions, or enter `help(linalg)` for details about the library `linalg` (Symbolic Math Toolbox).

Some of the functions in the `linalg` package simply serve as “interface” functions for methods of a matrix domain described above. For example, `linalg::transpose` uses the method “`transpose`” to get the transposed matrix. The function `linalg::gaussElim` applies Gaussian elimination to a matrix by calling the method “`gaussElim`”:

```
linalg::gaussElim(A) = A::dom::gaussElim(A)[1]
```

$$\begin{pmatrix} 1 & 2 \\ 0 & 0 \end{pmatrix} = \begin{pmatrix} 1 & 2 \\ 0 & 0 \end{pmatrix}$$

In contrast to the methods of the domain `Dom::Matrix(R)`, the corresponding functions of the `linalg` packages do extended checking of their input parameters. Note that there might be minor differences in the functionality of the `linalg` functions and the matrix methods. E.g., the option `ColumnElimination` is not available in `linalg::gaussElim`, but only in the “`gaussElim`” method of the matrix domain:

```
A::dom::gaussElim(A, ColumnElimination)
```

$$\left[ \left( \begin{array}{cc} 1 & 0 \\ 2 & 0 \end{array} \right), 1, 0, \{1\} \right]$$

```
delete A:
```



### Example 3

We create the default matrix domain `Dom::Matrix()`. As a shortcut, this domain can also be created via `matrix`:

```
A := matrix([[ 1, 2, 3, 4],
             [ 2, 0, 4, 1],
             [-1, 0, 5, 2]])
```

$$\begin{pmatrix} 1 & 2 & 3 & 4 \\ 2 & 0 & 4 & 1 \\ -1 & 0 & 5 & 2 \end{pmatrix}$$

```
domtype(A)
```

```
Dom::Matrix()
```

Matrix components can be extracted by the index operator `[]`:

```
A[2, 1] * A[1, 2] - A[3, 1] * A[1, 3]
```

```
7
```

If one of the indices is not in its valid range, an error message is issued. Assignments to matrix components are performed similarly:

```
delete a:
A[1, 2] := a^2: A
```

$$\begin{pmatrix} 1 & a^2 & 3 & 4 \\ 2 & 0 & 4 & 1 \\ -1 & 0 & 5 & 2 \end{pmatrix}$$

Beside the usual indexing of matrix components, it is also possible to extract submatrices from a given matrix. The following call creates the submatrix of `A` which consists of the rows 2 to 3 and columns 1 to 3 of `A`:

```
A[2..3, 1..3]
```

$$\begin{pmatrix} 2 & 0 & 4 \\ -1 & 0 & 5 \end{pmatrix}$$

The index operator does not allow to insert submatrices into a given matrix. This is implemented by the function `linalg::substitute`.

`delete A:`

### Example 4

In the following examples, we demonstrate the different ways of creating matrices. We work with matrices defined over the field  $\mathbb{Z}_{19}$ , i.e., the field of integers modulo 19. This component ring can be created with the domain constructor `Dom::IntegerMod`.

We start by giving a list of rows, where each row is a list of row entries:

```
MatZ19 := Dom::Matrix(Dom::IntegerMod(19)):
MatZ19([[1, 2], [2]])
```

$$\begin{pmatrix} 1 \bmod 19 & 2 \bmod 19 \\ 2 \bmod 19 & 0 \bmod 19 \end{pmatrix}$$

The elements of the two inner lists, the row entries, were converted to elements of the domain `Dom::IntegerMod(19)`.

The number of rows is the number of sublists of the argument, i.e.,  $m = 2$ . The number of columns is determined by the length of the inner list with the most entries, which is the first inner list with two entries. Missing entries in the other inner lists are treated as zero components. The call:

```
MatZ19(4, 4, [[1, 2], [2]])
```

$$\begin{pmatrix} 1 \bmod 19 & 2 \bmod 19 & 0 \bmod 19 & 0 \bmod 19 \\ 2 \bmod 19 & 0 \bmod 19 & 0 \bmod 19 & 0 \bmod 19 \\ 0 \bmod 19 & 0 \bmod 19 & 0 \bmod 19 & 0 \bmod 19 \\ 0 \bmod 19 & 0 \bmod 19 & 0 \bmod 19 & 0 \bmod 19 \end{pmatrix}$$

fixes the dimension of the matrix. Missing entries and inner lists are treated as zero components and zero rows, respectively.

An error message is issued if one of the given entries cannot be converted to an element over  $\mathbb{Z}_{19}$ :

```
MatZ19([[2, 3], [-1, I]])
```

```
Error: Unable to define a matrix over 'Dom::IntegerMod(19)'. [(Dom::Matrix(Dom::IntegerMod(19)))]
```

```
delete MatZ19:
```

## Example 5

This example illustrates how to create a matrix with components given as values of an index function. First we create the  $2 \times 2$  Hilbert matrix (see also the functions `linalg::hilbert` and `linalg::invhilbert`):

```
Dom::Matrix()(2, 2, (i, j) -> 1/(i + j - 1))
```

$$\begin{pmatrix} 1 & \frac{1}{2} \\ \frac{1}{2} & \frac{1}{3} \end{pmatrix}$$

Note the difference when working with expressions and functions. If you give an expression it is treated as a function in the row and column indices:

```
delete x:
```

```
Dom::Matrix()(2, 2, x), Dom::Matrix()(2, 2, (i, j) -> x)
```

$$\begin{pmatrix} x(1, 1) & x(1, 2) \\ x(2, 1) & x(2, 2) \end{pmatrix}, \begin{pmatrix} x & x \\ x & x \end{pmatrix}$$

## Example 6

Diagonal matrices can be created with the option `Diagonal` and a list of diagonal components:

```
Mat := Dom::Matrix():  
Mat(3, 4, [1, 2, 3], Diagonal)
```

$$\begin{pmatrix} 1 & 0 & 0 & 0 \\ 0 & 2 & 0 & 0 \\ 0 & 0 & 3 & 0 \end{pmatrix}$$

Hence, to define the  $n \times n$  identity matrix, you can enter:

```
Mat(3, 3, [1 $ 3], Diagonal)
```

$$\begin{pmatrix} 1 & 0 & 0 \\ 0 & 1 & 0 \\ 0 & 0 & 1 \end{pmatrix}$$

or call:

```
Mat(3, 3, x -> 1, Diagonal)
```

$$\begin{pmatrix} 1 & 0 & 0 \\ 0 & 1 & 0 \\ 0 & 0 & 1 \end{pmatrix}$$

The easiest way to create the identity matrix, however, is to use the method "identity":

```
Mat::identity(3)
```

$$\begin{pmatrix} 1 & 0 & 0 \\ 0 & 1 & 0 \\ 0 & 0 & 1 \end{pmatrix}$$

```
delete Mat:
```

## Example 7

Toeplitz matrices can be defined with the option **Banded**. The following call defines a three-banded matrix with the component 2 on the main diagonal and the component - 1 on the first subdiagonal and superdiagonal:

```
Dom::Matrix()(4, 4, [-1, 2, -1], Banded)
```

$$\begin{pmatrix} 2 & -1 & 0 & 0 \\ -1 & 2 & -1 & 0 \\ 0 & -1 & 2 & -1 \\ 0 & 0 & -1 & 2 \end{pmatrix}$$

### Example 8

Some system functions can be applied to matrices, such as norm, expand, diff, conjugate, or exp.

For example, to expand the components of the matrix:

```
delete a, b:
A := Dom::Matrix()(
  [(a - b)^2, a^2 + b^2], [a^2 + b^2, (a - b)*(a + b)]
)
```

$$\begin{pmatrix} (a-b)^2 & a^2+b^2 \\ a^2+b^2 & (a+b)(a-b) \end{pmatrix}$$

enter:

```
expand(A)
```

$$\begin{pmatrix} a^2 - 2ab + b^2 & a^2 + b^2 \\ a^2 + b^2 & a^2 - b^2 \end{pmatrix}$$

If you want to differentiate the matrix components, then call for example:

```
diff(A, a)
```

$$\begin{pmatrix} 2a - 2b & 2a \\ 2a & 2a \end{pmatrix}$$

To substitute matrix components by some values, enter:

```
subs(A, a = 1, b = -1)
```

$$\begin{pmatrix} 4 & 2 \\ 2 & 0 \end{pmatrix}$$

The function `zip` can also be applied to matrices. The following call combines two matrices  $A$  and  $B$  by dividing each component of  $A$  by the corresponding component of  $B$ :

```
A := Dom::Matrix()([[4, 2], [9, 3]]):
B := Dom::Matrix()([[2, 1], [3,-1]]):
zip(A, B, `/`)
```

$$\begin{pmatrix} 2 & 2 \\ 3 & -3 \end{pmatrix}$$

The quoted character ``/`` is another notation for the function `_divide`, the functional form of the division operator `/`.

If one needs to apply a function to the components of a matrix, then use the function `map`. For example, to simplify the components of the matrix:

```
C := Dom::Matrix()(
  [[sin(x)^2 + cos(x)^2, cos(x)*tan(x)],
   [(a^2 - b^2)/(a + b), 1]]
)
```

$$\begin{pmatrix} \cos(x)^2 + \sin(x)^2 & \cos(x) \tan(x) \\ \frac{a^2 - b^2}{a + b} & 1 \end{pmatrix}$$

call:

```
map(C, Simplify)
```

$$\begin{pmatrix} 1 & \sin(x) \\ a - b & 1 \end{pmatrix}$$

delete A, B, C:

## Example 9

However, there may appear some unexpected results using the function `diff` in the context of matrices. The derivative of the following unspecified function `f` of a matrix is computed due to the chain rule:

```
diff(f(matrix([[a*x^2, b], [c, d]])), x)
```

$$\begin{pmatrix} 2 a x f' \left( \begin{pmatrix} a x^2 & b \\ c & d \end{pmatrix} \right) & 0 \\ 0 & 0 \end{pmatrix}$$

Usually, the function `f` would implicitly be assumed to be scalar. Hence, the derivative of `f` should be scalar as well. In the above situation the chain rule is applied for differentiation: the inner function is the matrix containing the symbolic components `a*x^2`, `b`, `c` and `d`. Its derivative is computed by simply applying `diff` to each component of the matrix:

```
diff(matrix([[a*x^2, b], [c, d]]), x)
```

$$\begin{pmatrix} 2 a x & 0 \\ 0 & 0 \end{pmatrix}$$

Finally, the exterior unspecified function `f` is implicitly assumed to be scalar, such that each component of the derivative of the inner function is multiplied by the exterior differentiation.

## Example 10

A column vector is represented by a  $2 \times 1$  matrix:

```
Mat := Dom::Matrix():
v := Mat(2, 1, [1, 2])
```

$$\begin{pmatrix} 1 \\ 2 \end{pmatrix}$$

The dimension of this vector is:

```
Mat::matdim(v)
```

```
[2, 1]
```

The length of a vector may also be queried by `linalg::vecdim` or `nops(v)`:

```
linalg::vecdim(v)
```

```
2
```

The *i*th component of this vector can be extracted in two ways: either by `v[i, 1]` or by `v[i]`:

```
v[1], v[2]
```

```
1, 2
```

We compute the 2-norm of *v* by the following call:

```
norm(v, 2)
```

```
 $\sqrt{5}$ 
```

```
delete Mat, v;
```

## Example 11

We create random matrices over the field of the rational numbers. Consider a random matrix *A1* with 3 rows and 3 columns:

```
Mat := Dom::Matrix(Dom::Rational):  
A1 := Mat::random(3, 3)
```



$$\begin{pmatrix} -\frac{65}{824} & \frac{221}{72} & -\frac{245}{597} \\ \frac{741}{814} & \frac{229}{220} & \frac{747}{79} \\ \frac{764}{979} & -\frac{535}{617} & -\frac{535}{477} \end{pmatrix}$$

A second matrix A2 should contain at most 2 non-zero entries. We can create such a matrix by using 2 as the third argument for random:

```
A2 := Mat::random(3, 3, 2)
```

$$\begin{pmatrix} 0 & 0 & \frac{905}{906} \\ 0 & 0 & 0 \\ 0 & \frac{4}{133} & 0 \end{pmatrix}$$

The product of these matrices is given by

```
C := A1 * A2
```

$$\begin{pmatrix} 0 & -\frac{140}{11343} & -\frac{58825}{746544} \\ 0 & \frac{2988}{10507} & \frac{223535}{245828} \\ 0 & -\frac{2140}{63441} & \frac{345710}{443487} \end{pmatrix}$$

By default, matrices are displayed like 'dense' arrays with zeroes in the empty places. For sparse matrices of large column and/or row dimension, such a 'dense' print mode is not appropriate: formatting of the print output would be very time consuming. Further, a 'dense' print output is not very informative for sparse matrices. For this reason, the "doprint" method provides a sparse output mode printing only the non-zero entries:

```
C::dom::doprint(C)
```

```
Dom::Matrix(Dom::Rational)(3,3, [(1, 2) = -140/11343, (1, 3) = -58825/746544, (2, 2) = 2988\
/10507,(2, 3) = 223535/245828, (3, 2) = -2140/63441, (3, 3) = 345710/443487])
```

With this method, one can also print large sparse matrices. We create a random sparse matrix with 100 rows, 200 columns and at most 6 non-zero entries:

```
X := Mat::random(100, 200, 6): print(X)
```

```
Warning: Matrix too large for display. To see all nonzero entries of a matrix A, use 'A
```

```
Dom::Matrix(Dom::Rational)(100, 200, ["..."])
```

The warning speaks for itself. X is regarded as 'too large for display' since, with the default 'dense' output mode, the sparse matrix would be printed as a huge array-like structure of dimension 100×200 with (integer) zeroes in the empty places. The sparse print mode should be used:

```
X::dom::doprint(X)
```

```
Dom::Matrix(Dom::Rational)(100,200, [(16, 64) = 448/765, (19, 4) = -61/702, (27, 126) = 343\  
/304,(46, 42) = 433/49, (68, 176) = 451/483, (100, 97) = -235/174])
```

For convenience, there is a function `doprint` that calls this method by just entering:

```
doprint(X)
```

```
Dom::Matrix(Dom::Rational)(100,200, [(16, 64) = 448/765, (19, 4) = -61/702, (27, 126) = 343\  
/304,(46, 42) = 433/49, (68, 176) = 451/483, (100, 97) = -235/174])
```

```
delete Mat, A1, A2, C, X:
```

## Parameters

**R**

A ring, i.e., a domain of category `Cat::Rng`. The default ring is `Dom::ExpressionField()`.

**Array**

A one- or two-dimensional array or `harray`

**Matrix**

A matrix, i.e., an element of a domain of category `Cat::Matrix`

**m, n**

Matrix dimension (positive integers)

**List**

A list of matrix components

**ListOfRows**

A list of at most  $m$  rows; each row given as a list of at most  $n$  matrix components

**Table**

A table of coefficients of the matrix for sparse input

**f**

A function (Symbolic Math Toolbox) or a functional expression (Symbolic Math Toolbox) with two parameters (the row and column index)

**g**

A function or a functional expression with one parameter (the row index)

## Options

**Diagonal**

Create a diagonal matrix

With the option `Diagonal`, diagonal matrices can be created with diagonal elements taken from a list on page 7-41, or computed by a function (Symbolic Math Toolbox) or a functional expression (Symbolic Math Toolbox).

`Dom::Matrix(R)(m, n, List, Diagonal)` creates the  $m \times n$  diagonal matrix, whose diagonal elements are the entries of `List`.

`List` must have at most  $\min(m, n)$  entries. If it has fewer elements, the remaining diagonal elements are set to zero.

The entries of `List` are converted to elements of the domain `R`. An error message is issued if one of these conversions fails.

`Dom::Matrix(R)(m, n, g, Diagonal)` returns the sparse matrix whose  $i$ th diagonal element is `g(i, i)`, where the index  $i$  runs from 1 to  $\min(m, n)$ .

The function values are converted to elements of the domain `R`. An error message is issued if one of these conversions fails.

### Banded

Create a Toeplitz matrix

`Dom::Matrix(R)(m, n, List, Banded)` creates an  $m \times n$  Toeplitz matrix with the elements of `List` as entries. The number of entries of `List` must be odd, say  $2h + 1$ , and must not exceed  $2 \min(m, n) - 1$ . The bandwidth of the resulting matrix is at most  $2h + 1$ .

A Toeplitz matrix is a matrix where the elements of each band are identical. See also "Example 7" on page 7-264 (Symbolic Math Toolbox).

All elements of the main diagonal of the created matrix are initialized with the middle element of `List`. All elements of the  $i$ -th subdiagonal are initialized with the  $(h + 1 - i)$ -th element of `List`. All elements of the  $i$ -th superdiagonal are initialized with the  $(h + 1 + i)$ -th element of `List`. All entries on the remaining sub- and superdiagonals are set to zero.

The entries of `List` are converted to elements of the domain `R`. An error message is issued if one of these conversions fails.

### Entries

"isSparse"	is always TRUE.
"randomDimen"	is set to [10, 10]. See the method "random" below for details.

## Methods

### Mathematical Methods

#### **`_divide` — Divide matrices**

`_divide(A, B)`

An error message is issued if the dimensions of A and B do not match.

This method only exists if R is a commutative ring with a unit, i.e., a domain of category `Cat::Ring`.

This method overloads the system function `_divide` for matrices, i.e., one may use it in the form `A / B`, or in functional notation: `_divide(A, B)`.

#### **`_invert` — Compute the inverse of a matrix**

`_invert(A, Normal = b)`

This method only exists if R is a domain of category `Cat::Ring`.

This method overloads the system function `_invert` for matrices, i.e., one may use it in the form `1/A` or `A^(-1)`, or in functional notation: `_invert(A)`.

If `Normal = TRUE`, then the matrix inverse is always returned in a normalized form. For details about normalization, see `normal`. If `Normal = FALSE`, then the matrix inverse can appear in a normalized form, but normalization is not guaranteed. By default `Normal = TRUE`.

`Normal` affects the results only if a matrix contains variables or exact expressions, such as `sqrt(5)` or `sin(PI/7)`.

#### **`_mod` — Map the modulo operator to the elements of a matrix**

`_mod(A, n)`

`n` must be non-zero, and `a mod n` must be defined for every entry `a` of `A`.

This method overloads the function `_mod` for matrices; one may use it in the form `A mod n`, or in functional notation: `_mod(A, n)`.

**`_mult` — Multiplie matrices by matrices, vectors and scalars**`_mult(x, y)``_mult(x, y)`

If  $y$  is of the domain type  $R$  or can be converted to such an element, the corresponding scalar multiplication is computed.

Otherwise,  $y$  is converted to a matrix of the domain type of  $x$ . If this conversion fails, this method calls the method "`_mult`" of the domain of  $y$  giving all arguments in the same order.

If  $x$  is a matrix of the same domain type as  $y$ , the matrix product  $x y$  is computed. An error message is issued if the dimensions of the matrices do not match.

If  $x$  is of the domain type  $R$  or can be converted to such an element, the corresponding scalar multiplication is computed.

Otherwise,  $x$  is converted to a matrix of the domain type of  $y$ . If this conversion fails, `FAIL` is returned.

This method handles more than two arguments by calling itself recursively with the first half of all arguments and the last half of all arguments. Then the product of these two results is computed with the system function `_mult`.

This method overloads the system function `_mult` for matrices, i.e., one may use it in the form  $x * y$ , or in functional notation: `_mult(x, y)`.

**`_negate` — Negate a matrix**`_negate(A)`

This method overloads the system function `_negate` for matrices, i.e., one may use it in the form  $-A$ , or in functional notation: `_negate(A)`.

**`_plus` — Add matrices**`_plus(A, B, ...)`

The arguments  $A, B, \dots$  are converted to matrices of the domain type `Dom::Matrix(R)`. `FAIL` is returned if one of these conversions fails.

This method overloads the system function `_plus` for matrices, i.e., one may use it in the form `A + B`, or in functional notation: `_plus(A, B)`.

### **`_power` — Integer power of a matrix**

`_power(A, n)`

If the power `n` is a negative integer then `A` must be nonsingular and `R` must be a domain of category `Cat::IntegralDomain`. Otherwise `FAIL` is returned.

If `n` is zero and the component ring `R` is a ring with no unit (i.e., of category `Cat::Rng`, but not of category `Cat::Ring`), `FAIL` is returned.

This method overloads the system function `_power` for matrices, i.e., one may use it in the form `A^n`, or in functional notation: `_power(A, n)`.

### **`conjugate` — Complex conjugate of a matrix**

`conjugate(A)`

This method only exists if `R` implements the method "`conjugate`", which computes the complex conjugate of an element of the domain `R`.

This method overloads the system function `conjugate` for matrices, i.e., one may use it in the form `conjugate(A)`.

### **`cos` — Cosine of a matrix**

`cos(A)`

If `A` is not square, an error message is issued. If the component domain of `A` does not allow the computation of `cos(elem)` for an arbitrary element `elem` of the component ring, `FAIL` is returned.

This method uses the function `numeric::expMatrix` for a floating-point approximation of the exponential of `A` if `A` is defined over the domain `Dom::Float`.

If some eigenvalues of `A` do not exist in `R` or cannot be computed, then `FAIL` is returned.

In the symbolic case the functions `exp` and `linalg::jordanForm` are called. The latter may not be able to compute the Jordan form of `A`. In this case `FAIL` is returned.

This method only exists if `R` is a domain of category `Cat::Field`.

This method overloads the function `cos` for matrices, i.e., one may use it in the form `cos(A)`.

### **diff — Differentiation of matrix components**

`diff(A, ...)`

This method only exists if `R` implements the method `"diff"`.

This method overloads the system function `diff` for matrices, i.e., one may use it in the form `diff(A, ...)`. See “Example 8” on page 7-265 (Symbolic Math Toolbox) and “Example 9” on page 7-267 (Symbolic Math Toolbox).

### **equal — Equality test of matrices**

`equal(A, B)`

Note that if `R` has the axiom `Ax::systemRep` then `normal` is used to simplify the components of `A` and `B` before testing their equality.

### **exp — Exponential of a matrix**

`exp(A, <t>)`

If `A` is not square, an error message is issued. If the component domain of `A` does not allow the computation of `exp(elem)` for an arbitrary element `elem` of the component ring, `FAIL` is returned.

This method uses the function `numeric::expMatrix` for a floating-point approximation of the exponential of `A` if `A*t` contains at least one floating-point number and all entries can be converted to floating-point numbers.

If some eigenvalues of `A` do not exist in `R` or cannot be computed, then `FAIL` is returned.

In the symbolic case, the function `linalg::jordanForm` is called, which may not be able to compute the Jordan form of `A`. In this case `FAIL` is returned.

This method only exists if `R` is a domain of category `Cat::Field`.

This method overloads the system function `exp` for matrices, i.e., one may use it in the form `exp(A, ...)`.



**expand — Expand matrix components**`expand(A)`

This method only exists if  $R$  implements the method "expand", or if  $R$  has the axiom `Ax::systemRep` (in this case, the system function `expand` is used).

This method overloads the system function `expand` for matrices, i.e., one may use it in the form `expand(A)`.

**factor — Scalar-matrix factorization**`factor(A)`

The factor  $s$  is the gcd of all components of the matrix  $A$ . Hence, this method only exists if  $R$  is of category `Cat::GcdDomain`.

This method overloads the system function `factor` for matrices, i.e., one may use it in the form `factor(A)`.

**float — Floating-point approximation of the matrix components**`float(A)`

This method only exists if  $R$  implements the method "float".

---

**Note** Usually the floating-point approximations are not elements of  $R$ ! For example, `Dom::Integer` implements such a method, but the floating-point approximation of an integer cannot be re-converted to an integer.

This method checks whether the resulting matrix can be converted to the domain type of  $A$  only if `testargs()` returns `TRUE` (e.g., if one calls this method from the interactive level of MuPAD).

Otherwise, one has to take care that the matrix returned is compatible with its component ring.

---

**fourier — Fourier transform of the matrix components**`fourier(A, t, s)`

This method overloads the function `fourier` for matrices.

**gaussElim — Gaussian elimination for matrices**

`gaussElim(A, <ColumnElimination>)`

With the option `ColumnElimination`, the matrix  $A$  is reduced to a lower triangular echelon form via elementary *column* operations (without `ColumnElimination`, the Gauss algorithm uses elementary *row* operations to obtain the upper echelon form). The following relation holds: `transpose(gaussElim(A, ColumnElimination)[1]) = gaussElim(transpose(A))[1]`. With `ColumnElimination`, the last entry of the returned list is the set of characteristic *column* indices of  $A$ .

For very large  $m \times n$  matrices  $A$  with  $m$  much greater  $n$ , the column elimination is faster than the row elimination.

If the matrix is not square, i.e., the determinant of  $A$  is not defined, then the third entry of the returned list is the value `FAIL`.

This method only exists if the component ring  $R$  is an integral domain, i.e., a domain of category `Cat::IntegralDomain`.

If  $R$  has the method `"pivotSize"`, the pivot element of smallest size is chosen at every pivoting step, whereby `pivotSize` must return a positive integer representing the "size" of an element.

If no such method is defined, Gaussian elimination without a pivot strategy is applied to  $A$ .

If  $R$  has the axiom `Ax::efficientOperation("_invert")` and is of category `Cat::Field`, ordinary Gaussian elimination is used. Otherwise, fraction-free elimination is performed on  $A$ .

If  $R$  implements the method `"normal"`, it is used to simplify subsequent computations of the Gaussian elimination process.

Note that if  $R$  does not implement the method `"normal"`, but the elements of  $R$  are represented by kernel domains, i.e.,  $R$  has the axiom `Ax::systemRep`, the system function `normal` is used instead.

**identity — Identity matrix**

`identity(n)`

This method only exists if the component ring  $R$  is of category `Cat::Ring`, i.e., a ring with unit.

**int — Integration of matrix components**

```
int(A, ...)
```

This method only exists if R implements the method "int".

This method overloads the system function `int` for matrices, i.e., one may use it in the form `int(A, ...)`.

**ifourier — Inverse Fourier transform of the matrix components**

```
ifourier(A, s, t)
```

This method overloads the function `ifourier` for matrices.

**ilaplace — Inverse Laplace transform of the matrix components**

```
ilaplace(A, s, t)
```

This method overloads the function `ilaplace` for matrices.

**iszero — Test for zero matrices**

```
iszero(A)
```

Note that there may exist more than one representation of the zero matrix of a given dimension if R does not have `Ax::canonicalRep`.

If R implements the method "normal", it is used to simplify the components of A for the zero-test.

Note that if R does not implement such a method, but the elements of R are represented by kernel domains, i.e., R has the axiom `Ax::systemRep`, the system function `normal` is used instead.

This method overloads the system function `iszero` for matrices, i.e., one may use it in the form `iszero(A)`.

**laplace — Laplace transform of the matrix components**

```
laplace(A, t, s)
```

This method overloads the function `laplace` for matrices.

**matdim — Matrix dimension**

matdim(A)

**norm — Norm of matrices and vectors**

norm(A, Infinity)

norm(A, Maximum)

norm(v, Infinity)

norm(v, Maximum)

norm(A, Frobenius)

norm(A, 1)

norm(v, Euclidean)

norm(v, k)

norm(A, Maximum) computes the maximum norm of the matrix A, which is the maximum row sum (the row sum is the sum of norms of each component in a row).

If the domain R does not implement the methods "max" and "norm", FAIL is returned.

Using norm(v, Infinity) for a vector v the maximum norm of all elements is returned.

If the domain R does not implement the methods "max" and "norm", FAIL is returned.

Using norm(v, Maximum) for a vector v the maximum norm of all elements is returned.

If the domain R does not implement the methods "max" and "norm", FAIL is returned.

norm(A, Frobenius) computes the Frobenius norm of A, which is the square root of the sum of the squares of the norms of each component.

If the result is no longer an element of the domain R, or if R does not implement the method "norm", FAIL is returned.

`norm(A, 1)` computes the 1-norm of the matrix `A`, which is the maximum sum of the norms of the elements of each column. If `R` does not implement the methods "max" and "norm", FAIL is returned.

`norm(v, Euclidean)` computes the Euclidean norm (2-norm) of the vector `v`, which is defined to be the square root of the sum of the norms of the elements of `v` raised to the square.

FAIL is returned if the result is no longer an element of the domain `R`. The function `linalg::scalarProduct` is used to compute the Euclidean norm of the vector `v`.

If `R` does not implement the method "norm", FAIL is returned.

`norm(v, k)` computes the  $k$ -norm of the vector `v`, which is defined to be the  $k$ th root of the sum of the norms of the elements of `v` raised to the  $k$ th power.

FAIL is returned if the result is no longer an element of the domain `R`. For  $k = 2$ , the function `linalg::scalarProduct` is used to compute the 2-norm of `v`.

If `R` does not implement the method "norm", FAIL is returned.

The method `norm` overloads the function `norm` for matrices, i.e., one may use it in the form `norm(A k)`, where  $k$  is either `Infinity`, `Frobenius`, or a positive integer. The default value of  $k$  is `Infinity`.

### **normal — Simplification of matrix components**

`normal(A)`

If `R` does not implement the method "normal", but the elements of `R` are represented by kernel domains, i.e., `R` has the axiom `Ax::systemRep`, the system function `normal` is applied to the components of `A`. Otherwise `normal(A)` returns `A` without any changes.

This method overloads the system function `normal` for matrices, i.e., one may use it in the form `normal(A)`.

### **nonZeros — Number of non-zero components of a matrix**

`nonZeros(A)`

### **nonZeroes — Number of non-zero components of a matrix**

`nonZeroes(A)`

**nonZeroOperands — Return a sequence of all non-zero operands**

`nonZeroOperands(A)`

This method is useful for retrieving information on the non-zero entries. For example, to find out the types of the entries in the matrix, one should not consider all operands `op(A)`, because this would also involve the zero entries. For large matrices with few entries, it is much more efficient to use this method to extract the entries.

**random — Random matrix generation**

`random()`

`random(g)`

`random(m, n)`

`random(m, n, g)`

`random(m, n, p)`

`random(m, n, p, g)`

The dimension of the matrix is also chosen randomly. The matrix size is limited by the values "randomDimen" (see "Entries" above). To change the value of the entry "randomDimen", one must first unprotect the domain Dom (see `unprotect` for details).

When calling the "random" method with one parameter `g`, this parameter is regarded as a random generator. The matrix entries are created by the calls `g()` which must return elements of the coefficient ring R.

The dimension of the matrix is chosen randomly as above.

When calling the "random" method with two positive integers `m` and `n`, a random matrix with `m` rows and `n` columns is created. Its elements are generated by the method "random" of the component ring R. If `R::random` does not exist, FAIL is returned.

`random(m, n, g)` creates a matrix with `m` rows and `n` columns. The third parameter `g` is regarded as a random generator. The matrix entries are created by the calls `g()` which must return elements of the coefficient ring R.

When calling the "random" method with positive integers `m`, `n` and a nonnegative integer `p`, a sparse matrix with `m` rows, `n` columns and at most `p` non-zero entries is created.

These entries are generated by the function "random" of the component ring R. If `R::random` does not exist, FAIL is returned.

The integer `p` must satisfy  $0 \leq p \leq m n$ .

When calling the "random" method with four parameters, a sparse matrix with `m` rows, `n` columns and at most `p` non-zero entries is created. The fourth parameter `g` is regarded as a random generator. The matrix entries are created by the calls `g()` which must return elements of the coefficient ring R.

The integer `p` must satisfy  $0 \leq p \leq m n$ .

### **sin — Sine of a matrix**

`sin(A)`

If `A` is not square, an error message is issued. If the component domain of `A` does not allow the computation of `sin(elem)` for an arbitrary element `elem` of the component ring, FAIL is returned.

This method uses the function `numeric::expMatrix` for a floating-point approximation of the exponential of `A` if `A` is defined over the domain `Dom::Float`.

If some eigenvalues of `A` do not exist in `R` or cannot be computed, then FAIL is returned.

In the symbolic case the functions `exp` and `linalg::jordanForm` are called. The latter may not be able to compute the Jordan form of `A`. In this case FAIL is returned.

This method only exists if `R` is a domain of category `Cat::Field`.

This method overloads the function `sin` for matrices, i.e., one may use it in the form `sin(A)`.

### **sqrt — Square root of a matrix**

`sqrt(A, <sqrtfunc>)`

Returned is a matrix `B` with  $B^2 = A$  such that the eigenvalues of `B` are the square roots of the eigenvalues of `A` or FAIL if the square root of the matrix does not exist. For computing the square roots of the eigenvalues a function satisfying  $\text{sqrtfunc}(a)^2 = a$  for every element `a` of the coefficient ring of `A` can be given as optional second argument.

For details we refer to the help page of the function `linalg::sqrtMatrix`.

**testeq — Testing for equality of two matrices**

testeq(A, B)

**tr — Trace of a square matrix**

tr(A)

If A is not square, an error message is issued.

**transpose — Transpose of a matrix**

transpose(A)

## Access Methods

**\_concat — Horizontal concatenation of matrices**

\_concat(A, B, ...)

This method overloads the system function `_concat` for matrices, i.e., one may use it in the form `A . B . . . .`, or in functional notation: `_concat(A, B, . . .)`.

**\_index — Matrix indexing**

\_index(A, i, j)

\_index(A, r1 .. r2, c1 .. c2)

\_index(v, i)

\_index(v, i1 .. i2)

If `i` and `j` are not integers, the call of this method returns in its symbolic form (of type "`_index`") with evaluated arguments.

Otherwise an error message is given, if `i` and `j` are not valid row and column indices, respectively.

---

**Note** Note that this method uses the system function `context` to evaluate the entry in the context of the calling environment.

---



`_index(A, r1..r2, c1..c2)` returns the submatrix of  $A$  created by the rows of  $A$  with indices from  $r1$  to  $r2$  and the columns of  $A$  with indices from  $c1$  to  $c2$ .

This method returns the  $i$ th entry of the vector  $v$ .

An error message is issued if  $v$  is not a vector.

If  $i$  is not an integer, the call of `_index(v, i)` returns in its symbolic form (of type "`_index`") with evaluated arguments.

Otherwise an error message is given, if  $i$  is less than one or greater than the dimension of  $v$ .

---

**Note** Note that this method uses the system function `context` to evaluate the entry in the context of the calling environment.

---

`_index(v, i1..i2)` returns the subvector of  $v$ , formed by the entries with index  $i1$  to  $i2$ . See also the method "`op`".

An error message is issued if  $v$  is not a vector.

`_index` overloads the system function `_index` for matrices, i.e., one may use it in the form `A[i, j]`, `A[r1..r2, c1..c2]`, `v[i]` and `v[i1..i2]`, respectively, or in functional notation: `_index(A, ...)`.

### **addCol — Addition of a multiple of one column to the multiple of another column**

`addCol(A, i, j, f, <g>)`

$i$  and  $j$  must be positive integers smaller than or equal to the number of columns of the matrix  $A$ .

If  $f$  and  $g$  are not elements of the coefficient domain  $R$  of the matrix  $A$  and cannot be converted to  $R$ , FAIL is returned.

### **addRow — Addition of a multiple of one row to the multiple of another row**

`addRow(A, i, j, f, g)`

$i$  and  $j$  must be positive integers smaller than or equal to the number of rows of the matrix  $A$ .

If  $f$  and  $g$  are not elements of the coefficient domain  $R$  of the matrix  $A$  and cannot be converted to  $R$ , FAIL is returned.

**concatMatrix — Horizontal concatenation of matrices**

`concatMatrix(A, B, ...)`

**col — Extracting a column of a matrix**

`col(A, c)`

An error message is issued if  $c$  is less than one or greater than the number of columns of  $A$ .

**delCol — Deleting a column of a matrix**

`delCol(A, c)`

NIL is returned if  $A$  consists of only one column.

An error message is issued if  $c$  is less than one or greater than the number of columns of  $A$ .

**delRow — Deleting a row of a matrix**

`delRow(A, r)`

NIL is returned if  $A$  consists of only one row.

An error message is issued if  $r$  is less than one or greater than the number of rows of  $A$ .

**evalp — Evaluating matrices of polynomials at a certain point**

`evalp(A, x = a, ...)`

This method is only defined if  $R$  is a polynomial ring of category `Cat::Polynomial`.

This method overloads the system function `evalp` for matrices, i.e., one may use it in the form `evalp(A, x = a)`.

**length — Length of a matrix**

`length(A)`

This method overloads the system function `length` for matrices, i.e., one may use it in the form `length(A)`.

### **map — Apply a function to matrix components**

`map(A, f, <p1, p2, ...>)`

---

**Note** Note that values returned by `f` are converted to elements of the domain `R` only if `testargs()` returns `TRUE` (i.e., if one calls this method from the interactive level of MuPAD).

If `testargs()` returns `FALSE`, one must guarantee that `f` returns elements of the domain type `R`. Otherwise, the resulting matrix will have components which are not elements of the component ring `R`!

---

---

**Note** If the function `f` does not map the zero element of the component ring to the zero element, a sparse matrix will change into a dense matrix. This may lead to memory problems when dealing with very large (sparse) matrices.

---

Note that there is the method "mapNonZeroes" which maps a function to the non-zero entries of the matrix only.

This method overloads the system function `map` for matrices, i.e., one may use it in the form `map(A, f p1 , p2 , , ...)`.

### **mapNonZeroes — Apply a function to the non-zero components of a (sparse) matrix**

`mapNonZeroes(A, f, <p1, p2, ...>)`

### **multCol — Multiplication of one column by a scalar factor**

`multCol(A, i, f)`

`i` must be a positive integer smaller than or equal to the number of columns of the matrix `A`.

If `f` is not an element of the coefficient domain `R` of the matrix `A` and cannot be converted to `R`, `FAIL` is returned.

**multRow — Multiplication of one row by a scalar factor**

`multRow(A, i, f)`

`i` must be a positive integer smaller than or equal to the number of rows of the matrix `A`.

If `f` is not an element of the coefficient domain `R` of the matrix `A` and cannot be converted to `R`, `FAIL` is returned.

**nops — Number of components of a matrix**

`nops(A)`

This method overloads the system function `nops` for matrices, i.e., one may use it in the form `nops(A)`.

**op — Component of a matrix**

`op(A, i)`

`op(A)`

This method returns an expression sequence of all components of `A`.

See also the method "`_index`".

This method overloads the system function `op` for matrices, i.e., one may use it in the form `op(A, i)` and `op(A)`, respectively.

**row — Extracting a row from a matrix**

`row(A, r)`

An error message is issued if `r` is less than one or greater than the number of rows of `A`.

**setCol — Replacing a column of a matrix**

`setCol(A, c, v)`

An error message is issued if `c` is less than one or greater than the number of rows of `A`.

**setRow — Replacing a row of a matrix**

`setRow(A, r, v)`

An error message is issued if  $r$  is less than one or greater than the number of rows of  $A$ .

### **stackMatrix – Vertical concatenation of matrices**

`stackMatrix(A, B, ...)`

An error message is issued if the given matrices do not have the same number of columns.

### **subs – Substitution of matrix components**

`subs(A, ...)`

---

**Note** Note that the function values are converted to elements of the domain  $R$  only if `testargs()` returns TRUE (e.g., if one calls this method from the interactive level of MuPAD).

If `testargs()` returns FALSE, one must guarantee that  $f$  returns elements of the domain type  $R$ . Otherwise, the resulting matrix, which is of domain type `Dom::Matrix(R)`, would have components which are not elements of the domain  $R$ !

---

This method overloads the system function `subs` for matrices, i.e., one may use it in the form `subs(A, ...)`.

### **subsex – Extended substitution of matrix components**

`subsex(A, ...)`

---

**Note** Note that the results of the substitutions are converted to elements of the domain  $R$  only if `testargs()` returns TRUE (e.g., if one calls this method from the interactive level of MuPAD).

If `testargs()` returns FALSE, one must guarantee that the results of the substitutions are of the domain type  $R$ , otherwise the resulting matrix, which is of domain type `Dom::Matrix(R)`, would have components which are not elements of the domain  $R$ !

---

This method overloads the system function `subsex` for matrices, i.e., one may use it in the form `subsex(A, ...)`.

**subsop — Operand substitution of matrix components**

```
subsop(A, i = x, ...)
```

---

**Note** Note that  $x$  is converted to the domain  $R$  only if `testargs()` returns `TRUE` (e.g., if one calls this method from the interactive level of MuPAD).

If `testargs()` returns `FALSE`,  $x$  must be an element of  $R$ , otherwise the resulting matrix, which is of domain type `Dom::Matrix(R)`, would have components which are not elements of the domain  $R$ !

---

See also the method "set\_index".

This method overloads the system function `subsop` for matrices, i.e., one may use it in the form `subsop(A, ...)`.

**swapCol — Swapping matrix columns**

```
swapCol(A, c1, c2)
```

```
swapCol(A, c1, c2, r1 .. r2)
```

An error message is issued if one of the column indices is less than one or greater than the number of columns of  $A$ .

`swapCol(A, c1, c2, r1 .. r2)` swaps the column with index  $c1$  and the column with index  $c2$  of  $A$ , but by taking only those column components which lie in the rows with indices  $r1$  to  $r2$ .

An error message is issued if one of the column indices is less than one or greater than the number of columns of  $A$ , or if one of the row indices is less than one or greater than the number of rows of  $A$ .

**swapRow — Swapping matrix rows**

```
swapRow(A, r1, r2)
```

```
swapRow(A, r1, r2, c1 .. c2)
```

An error message is issued if one of the row indices is less than one or greater than the number of rows of  $A$ .

`swapCol(A, r1, r2, c1..c2)` swaps the row with index `r1` and the row with index `r2` of `A`, but by taking only those row components which lie in the columns with indices `c1` to `c2`.

An error message is issued if one of the row indices is less than one or greater than the number of rows of `A`, or if one of the column indices is less than one or greater than the number of columns of `A`.

### **set\_index — Setting matrix components**

`set_index(A, i, j, x)`

`set_index(v, i, x)`

---

**Note** Note that `x` is converted into an element of the domain `R` only if `testargs` returns `TRUE` and `i` and `j` are integers (e.g., if one calls this method from the interactive level of MuPAD). If `x` is a matrix of the same type as `A` or can be converted into a matrix of the same type as `A` and the indices `i` or `j` are ranges corresponding to a submatrix of `A`, then `x` replaces the corresponding submatrix in `A`.

Otherwise one has to take care that `x` is of domain type `R`.

---

See also the method "`subsop`".

`set_index(v, i, x)` replaces the `i`th entry of the vector `v` by `x`.

`set_index` on vectors overloads the function `set_index` for matrices, i.e., one may use it in the form `A[i, j] := x` and `v[i] := x`, respectively, or in functional notation: `A := set_index(A, i, j, x)` or `v := set_index(v, i, x)`.

### **zip — Combine matrices component-wise**

`zip(A, B, f, <p1, p2, ...>)`

The row number of the matrix returned is the minimum of the row numbers of `A` and `B`. Its column number is the minimum of the column numbers of `A` and `B`.

---

**Note** Note that the values returned by `f` are converted to elements of the domain `R` only if `testargs()` returns `TRUE` (i.e., if one calls this method from the interactive level of MuPAD).

If `testargs()` returns `FALSE`, one must guarantee that `f` returns elements of the domain type `R`. Otherwise, the resulting matrix will have components which are not elements of the component ring `R`!

---

This method overloads the system function `zip` for matrices, i.e., one may use it in the form `zip(A, B, f p1 , p2 , , ...)`.

## Conversion Methods

### **convert — Conversion to a matrix**

`convert(x)`

`FAIL` is returned if the conversion fails.

`x` may either be an array, a matrix, or a list (of sublists, see the parameter `ListOfRows` in “Creating Elements” above). Their entries must then be convertible into elements of the domain `R`.

### **convert\_to — Matrix conversion**

`convert_to(A, T)`

`T` may either be `DOM_ARRAY`, `DOM_LIST`, or a domain constructed by `Dom::Matrix` or `Dom::SquareMatrix`. The elements of `A` must be convertible into elements of the domain `R`.

Use the function `expr` to convert `A` into an object of a kernel domain (see below).

### **create — Defining matrices without component conversions**

`create(x, ...)`

This method works more efficiently than if one creates matrices by calling the method “new” of the domain, because it avoids any conversion of the components. One must guarantee that the components have the correct domain type, otherwise run-time errors can be caused.

### **expr — Conversion of a matrix to an object of a kernel domain**

`expr(A)`



The result is an array representing the matrix  $A$  where each entry is an object of a kernel domain.

This method overloads the system function `expr` for matrices, i.e., one may use it in the form `expr(A)`.

### **expr2text — Conversion of a matrix to a string**

`expr2text(A)`

This method overloads the system function `expr2text` for matrices, i.e., one may use it in the form `expr2text(A)`.

## **Technical Methods**

### **assignElements — Multiple assignment to matrices**

`assignElements(A, ...)`

The assigned components must have the domain type  $R$ , an implicit conversion of the components into elements of domain type  $R$  is not performed.

This method overloads the system function `assignElements` for matrices, i.e., one may use it in the form `assignElements(A, ...)`.

### **mkSparse — Conversion of an array or a list of lists to a sparse structure**

`mkSparse(Array)`

`mkSparse(List)`

`mkSparse(r, c, List)`

The 'sparse structure'  $s$  is a list of  $c$  univariate polynomials that is used to store the non-trivial elements of the columns of matrices.

`mkSparse(List)` tries to convert the list `List` into a sparse structure. The result is either `FAIL` if this is not possible, or the list `[s, [r, c]]`, where the positive integers  $r$  and  $c$  are the dimension of the corresponding matrix. The 'sparse structure'  $s$  is a list of univariate polynomials that is used to store the non-trivial elements of the columns of matrices.

See the parameters `List` and `ListOfRows` in “Creating Elements” above for admissible formats of `List`.

The matrix is regarded as a column or a row vector, if `r` or `c` is equal to one. `T`

`mkSparse(r, c, List)` tries to convert the list `List` into a sparse structure representing a matrix of dimension `r` times `c`.

The result is either `FAIL` if this is not possible, or the list `[s, [r, c]]`. The 'sparse structure' `s` is a list of univariate polynomials that is used to store the non-trivial elements of the columns of matrices.

The matrix is regarded as a column or a row vector, if `r` or `c` is equal to one. `T`

### **print — Printing matrices**

```
print(A)
```

---

**Note** Note that it will not be useful to print very large sparse matrices with lots of zero coefficients in this way - printing such matrices can be done by using the function `"doprint"`.

---

Use the matrix slot `"setPrintMaxSize"` to set the maximal size of matrices that will be printed like “dense” arrays with zero entries displayed as the integer 0.

### **doprint — Printing large sparse matrices**

```
doprint(A)
```

### **setPrintMaxSize — Set the maximal size of matrices that will be printed like “dense” arrays**

```
setPrintMaxSize(printMaxSize)
```

The value of the parameter `printMaxSize` may also be `infinity`. In this case, matrices of arbitrary size are printed like “dense” arrays.

This method returns the previous value of `printMaxSize`.

The default value is `printMaxSize = 500`.

**unapply — Create a procedure from a matrix**

`unapply(A, <x, ...>)`

This method overloads the system function `fp::unapply` for matrices, i.e., one may use it in the form `fp::unapply(A)`.

## See Also

**MuPAD Domains**

`Dom::DenseMatrix` | `Dom::DenseMatrix` | `Dom::MatrixGroup` |  
`Dom::SquareMatrix`

**MuPAD Functions**

`densematrix` | `matrix`

## Dom::MatrixGroup

The Abelian group of matrices

### Syntax

#### Domain Creation

```
Dom::MatrixGroup(m, n, <R>)
```

#### Element Creation

```
Dom::MatrixGroup(m, n, R)(Array)
```

```
Dom::MatrixGroup(m, n, R)(Matrix)
```

```
Dom::MatrixGroup(m, n, R)(<m, n>)
```

```
Dom::MatrixGroup(m, n, R)(<m, n>, List)
```

```
Dom::MatrixGroup(m, n, R)(<m, n>, ListOfRows)
```

```
Dom::MatrixGroup(m, n, R)(<m, n>, f)
```

```
Dom::MatrixGroup(m, n, R)(<m, n>, List, <Diagonal>)
```

```
Dom::MatrixGroup(m, n, R)(<m, n>, g, <Diagonal>)
```

```
Dom::MatrixGroup(m, n, R)(<m, n>, List, <Banded>)
```

### Description

#### Domain Creation

`Dom::MatrixGroup(m, n, R)` creates a domain which represents the Abelian group of  $m \times n$  matrices over the component ring  $R$ , i.e., it is a domain of category `Cat::AbelianGroup`.

The domain `Dom::ExpressionField()` is used as the component ring for the matrices if the optional parameter `R` is not given.

For matrices of a domain created by `Dom::MatrixGroup(m, n, R)`, matrix arithmetic is implemented by overloading the standard arithmetical operators `+`, `-`, `*`, `/` and `^`. All functions of the `linalg` (Symbolic Math Toolbox) package dealing with matrices can be applied.

`Dom::MatrixGroup(m, n, R)` has the domain `Dom::Matrix(R)` as its super domain, i.e., it inherits each method which is defined by `Dom::Matrix(R)` and not re-implemented by `Dom::MatrixGroup(m, n, R)`.

Methods described below are implemented by `Dom::MatrixGroup`.

The domain `Dom::Matrix(R)` represents matrices over `R` of arbitrary size, and it therefore does not have any algebraic structure (except of being a *set* of matrices).

The domain `Dom::SquareMatrix(n, R)` represents the *ring* of  $n \times n$  matrices over `R`.

## Element Creation

`Dom::MatrixGroup(m, n, R)(Array)` and `Dom::MatrixGroup(m, n, R)(Matrix)` create a new matrix formed by the entries of `Array` and `Matrix`, respectively.

The components of `Array` and `Matrix`, respectively, are converted into elements of the domain `R`. An error message is issued if one of these conversions fails.

The call `Dom::MatrixGroup(m, n, R)( m , n )` returns the  $m \times n$  zero matrix. Note that the  $m \times n$  zero matrix can also be found in the entry "zero" (see below).

`Dom::MatrixGroup(m, n, R)( m , n List)` creates an  $m \times n$  matrix with components taken from the list on page 7-41 `List`.

This call is only allowed for  $m \times 1$  or  $1 \times n$  matrices, i.e., if either `m` or `n` is equal to one.

If the list has too few entries, the remaining components of the matrix are set to zero.

The entries of the list are converted into elements of the domain `R`. An error message is issued if one of these conversions fails.

`Dom::MatrixGroup(m, n, R)( m , n ListOfRows)` creates an  $m \times n$  matrix with components taken from the nested list on page 7-41 `ListOfRows`. Each inner list corresponds to a row of the matrix.

If an inner list has less than  $n$  entries, the remaining components in the corresponding row of the matrix are set to zero. If there are less than  $m$  inner lists, the remaining lower rows of the matrix are filled with zeroes.

The entries of the inner lists are coerced into elements of the domain  $R$ . An error message is issued if one of these conversions fails.

It might be a good idea first to create a two-dimensional array on page 7-2 from that list before calling `Dom::MatrixGroup(m, n, R)`. This is due to the fact that creating a matrix from an array is the fastest way one can achieve. However, in this case the sublists must have the same number of elements.

`Dom::MatrixGroup(m, n, R)( m , n f)` returns the matrix whose  $(i, j)$ th component is the value of the function call `f(i, j)`. The row index  $i$  ranges from 1 to  $m$  and the column index  $j$  from 1 to  $n$ .

The function values are coerced into elements of the domain  $R$ . An error message is issued if one of these conversions fails.

## Superdomain

`Dom::Matrix(R)`

## Axioms

If  $R$  has `Ax::canonicalRep`, then `Ax::canonicalRep`.

## Categories

`Cat::Matrix(R)`, `Cat::AbelianGroup`

## Examples

### Example 1

A lot of examples can be found on the help page of the domain constructor `Dom::Matrix`, and most of them are also examples for working with domains created by `Dom::MatrixGroup`. This example only highlights some differences with respect to working with matrices of the domain `Dom::Matrix(R)`.

The following command defines the abelian group of  $3 \times 4$  matrices over the rationals:

```
MatGQ := Dom::MatrixGroup(3, 4, Dom::Rational)
```

```
Dom::MatrixGroup(3, 4, Dom::Rational)
```

```
MatGQ::hasProp(Cat::AbelianGroup), MatGQ::hasProp(Cat::Ring)
```

```
TRUE, FALSE
```

`MatGQ` is a commutative group with respect to the addition of matrices. The unit of this group is the  $3 \times 4$  zero matrix:

```
MatGQ::zero
```

$$\begin{pmatrix} 0 & 0 & 0 & 0 \\ 0 & 0 & 0 & 0 \\ 0 & 0 & 0 & 0 \end{pmatrix}$$

Note that some operations defined by the domain `MatGQ` return matrices which are no longer elements of the matrix group. They return matrices of the domain `Dom::Matrix(Dom::Rational)`, the super-domain of `MatGQ`.

For example, if we define the matrix:

```
A := MatGQ([[1, 2, 1, 2], [-5, 3], [2, 1/3, 0, 1]])
```

$$\begin{pmatrix} 1 & 2 & 1 & 2 \\ -5 & 3 & 0 & 0 \\ 2 & \frac{1}{3} & 0 & 1 \end{pmatrix}$$

and delete its third column, we get the matrix:

```
MatGQ::delCol(A, 3)
```

$$\begin{pmatrix} 1 & 2 & 2 \\ -5 & 3 & 0 \\ 2 & \frac{1}{3} & 1 \end{pmatrix}$$

which is of the domain type:

```
domtype(%)
```

```
Dom::Matrix(Dom::Rational)
```

As another example we create the 3×3 identity matrix using the method "identity" of our domain:

```
E3 := MatGQ::identity(3)
```

$$\begin{pmatrix} 1 & 0 & 0 \\ 0 & 1 & 0 \\ 0 & 0 & 1 \end{pmatrix}$$

This is also a matrix of the domain `Dom::Matrix(Dom::Rational)`:

```
domtype(E3)
```

```
Dom::Matrix(Dom::Rational)
```

If we concatenate E3 to the right of the matrix A defined above, we get the 3 × 7 matrix:

```
B := A . E3
```



$$\begin{pmatrix} 1 & 2 & 1 & 2 & 1 & 0 & 0 \\ -5 & 3 & 0 & 0 & 0 & 1 & 0 \\ 2 & \frac{1}{3} & 0 & 1 & 0 & 0 & 1 \end{pmatrix}$$

which is of the domain type `Dom::Matrix(Dom::Rational)`:

```
domtype(B)
```

```
Dom::Matrix(Dom::Rational)
```

## Example 2

We can convert a matrix from a domain created with `Dom::MatrixGroup` into or from another matrix domain, as shown next:

```
MatGR := Dom::MatrixGroup(2, 3, Dom::Real):
```

```
MatC := Dom::Matrix(Dom::Complex):
```

```
A := MatGR((i, j) -> i*j)
```

$$\begin{pmatrix} 1 & 2 & 3 \\ 2 & 4 & 6 \end{pmatrix}$$

To convert A into a matrix of the domain `MatC`, enter:

```
coerce(A, MatC)
```

$$\begin{pmatrix} 1 & 2 & 3 \\ 2 & 4 & 6 \end{pmatrix}$$

```
domtype(%)
```

```
Dom::Matrix(Dom::Complex)
```

The conversion is done component-wise. For example, we define the following matrix:

```
B := MatC([[0, 1, 0], [exp(I), 0, 1]])
```

$$\begin{pmatrix} 0 & 1 & 0 \\ e^j & 0 & 1 \end{pmatrix}$$

The matrix  $B$  has one complex component and therefore cannot be converted into the domain `MatGR`:

```
coerce(B, MatGR)
```

**FAIL**

Note: The system function `coerce` uses the methods "convert" and "convert\_to" implemented by any domain created with `Dom::MatrixGroup` and `Dom::Matrix`.

## Parameters

**m, n**

Positive integers (matrix dimension)

**R**

A commutative ring, i.e., a domain of category `Cat::CommutativeRing`; the default is `Dom::ExpressionField()`

**Array**

An  $m \times n$  array

**Matrix**

An  $m \times n$  matrix, i.e., an element of a domain of category `Cat::Matrix`

**List**

A list of matrix components

**ListOfRows**

A list of at most  $m$  rows; each row is a list of at most  $n$  matrix components

**f**

A function (Symbolic Math Toolbox) or a functional expression (Symbolic Math Toolbox) with two parameters (the row and column index)

**g**

A function or a functional expression with one parameter (the row index)

## Options

### Diagonal

Create a diagonal matrix

With the option `Diagonal`, diagonal matrices can be created with diagonal elements taken from a list on page 7-41, or computed by a function (Symbolic Math Toolbox).

`Dom::MatrixGroup(m, n, R)( m , n List, Diagonal)` creates the  $m \times n$  diagonal matrix whose diagonal elements are the entries of `List`.

`List` must have at most  $\min(m, n)$  entries. If it has fewer elements, then the remaining diagonal elements are set to zero.

The entries of `List` are coerced into elements of the domain `R`. An error message is issued if one of these conversions fails.

`Dom::MatrixGroup(m, n, R)( m , n g, Diagonal)` returns the matrix whose  $i$ th diagonal element is `g(i, i)`, where the index  $i$  runs from 1 to  $\min(m, n)$ .

The function values are coerced into elements of the domain `R`. An error message is issued if one of these conversions fails.

### Banded

Create a banded Toeplitz matrix

With the option `Banded`, banded matrices can be created.

A *banded matrix* has all entries zero outside the main diagonal and some of the adjacent sub- and superdiagonals.

`Dom::MatrixGroup(m, n, R)( m , n List, Banded)` creates an  $m \times n$  banded Toeplitz matrix with the elements of `List` as entries. The number of entries of `List` must be odd, say  $2h + 1$ , and must not exceed  $n$ . The resulting matrix has bandwidth at most  $2h + 1$ .

All elements of the main diagonal of the created matrix are initialized with the middle element of `List`. All elements of the  $i$ th subdiagonal are initialized with the  $(h + 1 - i)$ th element of `List`. All elements of the  $i$ th superdiagonal are initialized with the  $(h + 1 + i)$ th element of `List`. All entries on the remaining sub- and superdiagonals are set to zero.

The entries of `List` are converted into elements of the domain `R`. An error message is issued if one of these conversions fails.

## Entries

"one"	is only defined if $m$ is equal to $n$ ; in that case it defines the $n \times n$ identity matrix.
"randomDimen"	is set to $[m, n]$ .
"zero"	is the $m \times n$ zero matrix.

## Methods

### Mathematical Methods

#### **evalp — Evaluating matrices of polynomials at a certain point**

`evalp(A, x = a, ...)`

This method is only defined if `R` is a polynomial ring of category `Cat::Polynomial`.

This method overloads the function `evalp` for matrices, i.e., one may use it in the form `evalp(A, x = a)`.

#### **identity — Identity matrix**

`identity(k)`

---

**Note** The matrix returned is of the domain `Dom::Matrix(R)`, if  $m \neq n$  or if  $k \neq n$ .

---

### **matdim — Matrix dimension**

matdim(A)

### **random — Random matrix generation**

random()

The components of the random matrix are randomly generated with the method "random" of the component ring R.

## **Access Methods**

### **\_concat — Horizontally concatenation of matrices**

\_concat(A, B, ...)

An error message is issued if the given matrices do not have the same number of rows.

---

**Note** The returned matrix is of the domain `Dom::Matrix(R)`.

---

This method overloads the function `_concat` for matrices, i.e., one may use it in the form `A . B . ...`, or in functional notation: `_concat(A, B, ...)`.

### **\_index — Matrix indexing**

\_index(A, i, j)

\_index(A, r1 .. r2, c1 .. c2)

\_index(A, i)

\_index(A, i1 .. i2)

If `i` and `j` are not integers, then the call of this method returns in its symbolic form (of type "`_index`") with evaluated arguments.

Otherwise an error message is given, if  $i$  and  $j$  are not valid row and column indices, respectively.

---

**Note** Note that the system function `context` is used to evaluate the entry in the context of the calling environment.

---

This method overloads the function `_index` for matrices, i.e., one may use it in the form  $A[i, j]$  or in functional notation: `_index(A, i, j)`.

Returns the submatrix of  $A$ , created by the rows of  $A$  with indices from  $r1$  to  $r2$  and the columns of  $A$  with indices from  $c1$  to  $c2$ .

---

**Note** The submatrix is of the domain `Dom::Matrix(R)`.

---

This method returns the  $i$ th entry of  $A$ .

If  $i$  is not an integer, then the call of this method returns in its symbolic form (of type "`_index`") with evaluated arguments.

Otherwise an error message is given, if  $i$  is less than one or greater than the dimension of  $v$ .

This call is only allowed for  $1 \times n$  or  $m \times 1$  matrices, i.e., either  $m$  or  $n$  must be equal to one. Otherwise an error message is issued.

---

**Note** Note that the system function `context` is used to evaluate the entry in the context of the calling environment.

---

This method returns the subvector of  $A$ , formed by the entries with index  $i1$  to  $i2$  (see also the method "`op`").

This call is only allowed for  $1 \times n$  or  $m \times 1$  matrices, i.e., either  $m$  or  $n$  must be equal to one. Otherwise an error message is issued.

This method overloads the function `_index` for matrices, i.e., one may use it in the form  $A[i, j]$ ,  $A[r1..r2, c1..c2]$ ,  $A[i]$  or  $A[i1..i2]$ , respectively, or in functional notation: `_index(A, ...)`.

**concatMatrix — Horizontally concatenation of matrices**

concatMatrix(A, B, ...)

**col — Extracting a column**

col(A, c)

An error message is issued if  $c$  is less than one or greater than  $n$ .

**delCol — Deleting a column**

delCol(A, c)

NIL is returned if  $A$  only consists of one column.

---

**Note** The returned matrix is of the domain `Dom::Matrix(R)`.

---

An error message is issued if  $c$  is less than one or greater than  $n$ .

**delRow — Deleting a row**

delRow(A, r)

NIL is returned if  $A$  only consists of one row.

---

**Note** The returned matrix is of the domain `Dom::Matrix(R)`.

---

An error message is issued if  $r$  is less than one or greater than  $m$ .

**row — Extracting a row**

row(A, r)

An error message is issued if  $r$  is less than one or greater than  $m$ .

**stackMatrix — Concatenating of matrices vertically**

stackMatrix(A, B, ...)

An error message is issued if the given matrices do not have the same number of columns.

---

**Note** The matrix returned is of the domain `Dom::Matrix(R)`.

---

## Conversion Methods

### **convert** — Conversion into a matrix

`convert(x)`

FAIL is returned if the conversion fails.

$x$  may either be an  $m \times n$  array, or an  $m \times n$  matrix of category `Cat::Matrix`.

$x$  can also be a list. See the parameter `List` and `ListOfRows` in “Creating Elements” above for admissible values of  $x$ .

The entries of  $x$  must be convertible into elements of the domain  $R$ , otherwise FAIL is returned.

## See Also

### **MuPAD Domains**

`Dom::Matrix` | `Dom::SquareMatrix`



# Dom::MonomOrdering

Monomial orderings

## Syntax

Dom::MonomOrdering(Lex(n))

Dom::MonomOrdering(RevLex(n))

Dom::MonomOrdering(DegLex(n))

Dom::MonomOrdering(DegRevLex(n))

Dom::MonomOrdering(DegInvLex(n))

Dom::MonomOrdering(WeightedLex( $w_1, \dots, w_n$ ))

Dom::MonomOrdering(WeightedDegLex( $w_1, \dots, w_n$ ))

Dom::MonomOrdering(WeightedDegRevLex( $w_1, \dots, w_n$ ))

Dom::MonomOrdering(WeightedRevLex( $w_1, \dots, w_n$ ))

Dom::MonomOrdering(Block( $o_1, \dots$ ))

Dom::MonomOrdering(Matrix(params))

## Description

Dom::MonomOrdering represents the set of all possible monomial orderings. A monomial ordering is a well-ordering of the set of all  $k$ -tuples of nonnegative integers for some  $k$ .

In MuPAD, a monomial ordering is implemented as a function that, when applied to two lists of nonnegative integers, returns  $-1$ ,  $0$ , or  $1$  if the first list is respectively smaller than, equal to, or greater than the second list. Each ordering can only compare lists of one fixed length, called its *order length*. Since the lists under consideration will be exponent vectors in most cases, their length is also referred to as the number of indeterminates.

Monomial orderings are used in algebraic geometry for comparing terms  $\prod_{i=1}^n X_i^{\alpha_i}$  and  $\prod_{i=1}^n X_i^{\beta_i}$  in a polynomial ring. Since `Dom::MonomOrdering` works on the exponent vectors  $[\alpha_1, \dots, \alpha_n]$  and  $[\beta_1, \dots, \beta_n]$ , `degreevec` must be applied to the terms to be compared before applying `Dom::MonomOrdering`.

Elements of `Dom::MonomOrdering` can be used as arguments for `lcoeff`, `lmonomial`, `lterm`, and `tcoeff` as well as for the functions of the `groebner` (Symbolic Math Toolbox) package in order to specify the monomial ordering to be considered.

Monomial orderings are created by calling `Dom::MonomOrdering(someIdentifier(parameters))`, where `someIdentifier` is one of a certain set of predefined identifiers, as stated below. Converting `someIdentifier` into a string gives the *order type* of the monomial ordering.

`Dom::MonomOrdering(Lex(n))` creates the lexicographical order on  $n$  indeterminates.

`Dom::MonomOrdering(RevLex(n))` creates the reverse lexicographical order on  $n$  indeterminates, i.e., `Dom::MonomOrdering(RevLex(n))([a1, ..., an]) = Dom::MonomOrdering(Lex(n))([an, ..., a1])`.

`Dom::MonomOrdering(DegLex(n))` creates the degree order on  $n$  indeterminates with the lexicographical order used for tie-break.

`Dom::MonomOrdering(DegRevLex(n))` creates the degree order on  $n$  indeterminates with the reverse lexicographical order used for tie-break.

`Dom::MonomOrdering(DegInvLex(n))` creates the degree order on  $n$  indeterminates, with the tie break being the opposite to the lexicographical order.

`Dom::MonomOrdering(Weighted... (w1, ..., wn))` returns a weighted degree order with weights  $w_1$  through  $w_n$ . The word following the word `Weighted` specifies the tie-break used. Note that MuPAD uses the ordinary degree order as the first tie-break.

`Dom::MonomOrdering(Matrix(params))` creates a matrix order, with the order matrix defined by `Dom::Matrix()(params)`.

`Dom::MonomOrdering(Block(o1, ..., on))` or, equivalently, `Dom::MonomOrdering([o1, ..., on])`, creates a block order such that `Dom::MonomOrdering(o1)` is used on the first indeterminates, then `Dom::MonomOrdering(o2)` is used as a tie-break on the following indeterminates etc.

Block orders may be nested, i.e., the blocks may be block orders, too.

Weight vectors with negative entries and order matrices do not define well-orderings in general. You may enter such orderings, but it may cause trouble, e.g., to use them with the groebner (Symbolic Math Toolbox) package.

## Superdomain

Dom::BaseDomain

## Categories

Cat::BaseCategory

## Examples

### Example 1

We define ORD by prescribing that lists  $[a, b, c]$  are ordered according to their weighted degrees  $5a + 2b + \pi c$ . For lists with equal weighted degree, the non-weighted degree  $a + b + c$  is used as a tie-break. Finally, the lexicographical order decides (in fact, this last step is not necessary because  $\pi$  is irrational).

```
ORD:=Dom::MonomOrdering(WeightedDegLex(5, 2, PI))
```

```
WeightedDegLex(5, 2,  $\pi$ )
```

With respect to ORD,  $[1, 6, 1]$  is smaller than  $[2, 1, 3]$ :

```
ORD([1,6,1], [2,1,3])
```

- 1

## Parameters

**n**

Positive integer

**w<sub>1</sub>, ...**

Numerical expressions

**o<sub>1</sub>, ...**

Valid arguments to `Dom::MonomOrdering`

**params**

A sequence valid as the sequence of arguments to `Dom::Matrix()`.

## Methods

### Mathematical Methods

**func\_call** — Compare two lists of integers

`func_call(o, l1, l2)`

The lengths of `l1` and `l2` must not exceed the order length of `o`. If `l1` or `l2` is too short, the necessary number of zeroes is appended.

### Access Methods

**ordertype** — Return the type of an order

`ordertype(o)`

If `o` equals `Dom::MonomOrdering(someIdentifier(params))`, then converting `someIdentifier` into a string gives the order type of `o`.

**orderlength** — Return the length of an order

orderlength(o)

**nops** — Number of blocks

nops(o)

**block** — Get a particular block

block(o, i)

**blocktype** — Get the order type of a particular block

blocktype(o, i)

**blocklength** — Get the order length of a particular block

blocklength(o, i)

## Conversion Methods

**expr** — Return an expression from which the order can be restored

expr(o)

## See Also

**MuPAD Functions**

groebner::gbasis

## Dom::Multiset

Multisets

### Syntax

```
Dom::Multiset(<s1, s2, ...>)
```

### Description

`Dom::Multiset` is the domain of multisets, i.e., sets with possibly multiple identical elements.

A multiset is represented by a set of lists of the form  $[s, m]$ , where  $s$  is an element of the multiset and  $m$  its multiplicity.

Multisets can be returned by the system solver `solve`. For example, the input `solve(x^3 - 4*x^2 + 5*x - 2, x, Multiple)` gives all roots of the polynomial  $x^3 - 4x^2 + 5x - 2$  in form of the multiset  $\{[1, 2], [2, 1]\}$ .

The standard set operations such as union, intersection and subtraction of sets have been extended to deal with multisets.

These operations can handle different types of sets, such as sets of type `DOM_SET` and multisets. One may, for example, compute the union of the multiset  $\{[a, 2], [b, 1]\}$  and the set  $\{c\}$ , which results in the multiset  $\{[a, 2], [b, 1], [c, 1]\}$ .

The elements of the multiset are sorted at the time where the multiset is created. The system function `sort` is used in order to guarantee that exactly one representation exists for a multiset, independent of the sequence in which the arguments appear.

`Dom::Multiset(s1, s2, ...)` creates the multiset consisting of the elements  $s1, s2, \dots$

Multiple identical elements in  $s1, s2, \dots$  are collected. For example, the call `Dom::Multiset(a, b, a, c)` creates a multiset with the elements  $a, b, c$ . The element  $a$  has multiplicity two, the other two elements  $b$  and  $c$  both have multiplicity one.

## Superdomain

Dom::BaseDomain

## Categories

Cat::Set

## Examples

### Example 1

The multiset  $\{a, a, b\}$  consists of the two different elements  $a$  and  $b$ , where  $a$  has multiplicity two and  $b$  has multiplicity one:

```
delete a, b, c:  
set1 := Dom::Multiset(a, a, b)
```

$$\{[a, 2], [b, 1]\}$$

We create another multiset:

```
set2 := Dom::Multiset(a, c, c)
```

$$\{[a, 1], [c, 2]\}$$

Standard set operations such as disjoint union, intersection or subtraction are implemented for multisets and can be performed using the standard set operators of MuPAD:

```
set1 union set2
```

$$\{[a, 3], [b, 1], [c, 2]\}$$

```
set1 intersect set2
```

$\{[a, 1]\}$ `contains(set1, a), contains(set1, d)` $\text{TRUE, FALSE}$ 

## Example 2

Some system functions were overloaded for multisets, such as `expand`, `normal` or `split`.

If we apply `expand` to a multiset, for example, we get an expression sequence of all elements of the multiset (appearing in correspondence to their multiplicity):

```
delete a, b, c, d, e:  
set := Dom::Multiset(a, b, c, a, c, d, c, e, c)
```

 $\{[a, 2], [b, 1], [c, 4], [d, 1], [e, 1]\}$ `expand(set)` $a, a, b, c, c, c, c, d, e$ 

If you want to convert a multiset into an ordinary set of the domain type `DOM_SET`, use `coerce`:

`coerce(set, DOM_SET)` $\{a, b, c, d, e\}$ 

Note: The system function `coerce` uses the methods "convert" and "convert\_to" of the domain `Dom::Multiset`.

Compare the last result with the return value of the function `expr`, when it is applied for multisets:

`expr(set)`



$$\{[a, 2], [b, 1], [c, 4], [d, 1], [e, 1]\}$$

The result is a set of the domain type `DOM_SET`, consisting of lists of the domain type `DOM_LIST` with two entries, an element of the multiset and the corresponding multiplicity of that element.

## Parameters

`s1, s2, ...`

Objects of any type

## Entries

"isFinite"	is TRUE because <code>Dom::Multiset</code> represents finite sets.
"inhomog_intersect"	a table of the form <code>T = Proc(multiset, setoftypeT)</code> . This entry is used internally by the implementation, and thus should not be touched.
"inhomog_union"	a table of the form <code>T = Proc(multiset, setoftypeT)</code> . This entry is used internally by the implementation, and thus should not be touched.

## Methods

### Mathematical Methods

`normal` — Normalization of multisets

`normal(set)`

This method overloads the function `normal` for multisets, i.e., one may use it in the form `normal(set)`.

**powerset — Power set of a multiset**

`powerset(set)`

The power set of `set` is returned as a set on page 7-50 of multisets.

**random — Random multiset generation**

`random()`

The number of elements created, including their multiplicities, is restricted to 20.

## Access Methods

**`_index` — Multiset indexing**

`_index(set, i)`

See the method "op".

This method overloads the function `_index` for multisets, i.e., one may use it in the form `set[i]`, or in functional notation: `_index(set, i)`.

**contains — Check on existence of set elements**

`contains(set, s)`

This method overloads the function `contains` for multisets, i.e., one may use it in the form `contains(set, s)`.

**equal — Test on equality of multisets**

`equal(set1, set2)`

The system function `_equal` is used for the test.

**expand — Expand a multiset to a sequence of its elements**

`expand(set)`

This method overloads the function `expand` for multisets, i.e., one may use it in the form `expand(set)`.

### **getElement — Extract one element from a multiset**

`getElement(set)`

Note that the elements of the multiset are sorted with the use of the system function `sort`, and thus the order of a multiset depends on the sorting criteria specified by this function.

This method overloads the function `solveLib::getElement`, i.e., one may use it in the form `solveLib::getElement(set)`.

### **has — Check on existence of (sub-)expressions**

`has(set, expr)`

To check whether `expr` is contained as an element of `set` and not as a subexpression of the elements of `set`, the function `contains` must be used.

This method overloads the function `has` for multisets, i.e., one may use it in the form `has(set, expr)`.

### **map — Apply a function to multiset elements**

`map(set, func, <expr, ...>)`

It overloads the function `map` for multisets, i.e., one may use it in the form `map(set, func, ...)`.

### **multiplicity — Multiplicity of an element**

`multiplicity(set, s)`

Elements which are not contained in `set` have multiplicity zero.

### **card — Number of elements in a multiset**

`card(set)`

This method overloads the function `card`.

**nops — Number of different elements in a multiset**

nops(set)

This method overloads the function nops for multisets, i.e., one may use it in the form nops(set).

**op — Element of a multiset**

op(set)

op(set, i)

Returns the *i*-th element *s* of the multiset *set* and its multiplicity *m* in form of the list [*s*, *m*].

See also the method "\_index".

Note that the elements of the multiset are sorted with the use of the system function sort, and thus the order of a multiset depends on the sorting criteria specified by this function.

This method overloads the function op for multisets, i.e., one may use it in the form op(*s*, *i*).

**select — Selecting of multiset elements**

select(set, func, <expr, ...>)

This method overloads the function select for multisets, i.e., one may use it in the form select(set, func, ...). See select for details.

**split — Splitting a multiset**

split(set, func, <expr, ...>)

This method overloads the function split for multisets, i.e., one may use it in the form split(set, func, ...). See split for details.

**subs — Substitution of elements in multisets**

subs(set, ...)

This method overloads the function `subs` for multisets, i.e., one may use it in the form `subs(set, ...)`.

## Conversion Methods

### **convert — Conversion into a multiset**

`convert(x)`

FAIL is returned if the conversion fails.

Currently only sets of type `DOM_SET` can be converted into multisets.

### **convert\_to — Multiset conversion**

`convert_to(set, T)`

FAIL is returned if the conversion fails.

Currently `T` may either be `DOM_SET` to convert the multiset `set` into a set (loosing the multiplicities and the order of the elements of `set`), or `DOM_EXPR` or `"_exprseq"` to convert `set` into an expression sequence (see the method `"expand"` for details).

See also the method `"expr"`.

### **expr — Multiset conversion into an object of a kernel domain**

`expr(set)`

This method overloads the function `expr` for multisets, i.e., one may use it in the form `expr(set)`.

### **sort — Sorting of multisets**

`sort(set)`

This method overloads the function `sort` for multisets, i.e., one may use it in the form `sort(set)`.

## Technical Methods

### **bin\_intersect — Intersection of two multisets**

`bin_intersect(set1, set2)`

This method is called from routines defined in the category `Cat::Set`, which implements among others the overloading of the function `intersect` for multisets. One may intersect two multisets directly by `set1 intersect set2`, or in functional notation by `_intersect(set1, set2)`.

### **bin\_minus — Subtraction of two multisets**

`bin_minus(set1, set2)`

This method is called from routines defined in the category `Cat::Set`, which implements among others the overloading of the function `minus` for multisets. One may subtract two multisets directly by `set1 minus set2`, or in functional notation by `_minus(set1, set2)`.

### **homog\_union — Union of multisets**

`homog_union(set, ...)`

This method is called from routines defined in the category `Cat::Set`, which implements among others the overloading of the function `union` for multisets. One may compute the union of two multisets directly by `set1 union set2`, or in functional notation by `_union(set1, set2)`.

### **nested\_union — Union of nested sets**

`nested_union(setofsets)`

This method is called from routines defined in the category `Cat::Set`, which implements among others the overloading of the function `union` for multisets and sets. One may compute the union of multisets and sets directly by `set1 union set2`, or in functional notation by `_union(set1, set2)`.

## See Also

### MuPAD Domains

DOM\_SET | Dom::ImageSet

# Dom::MultivariatePolynomial

Domains of multivariate polynomials

## Syntax

### Domain Creation

```
Dom::MultivariatePolynomial(<Vars, <R, <Order>>>)
```

### Element Creation

```
Dom::MultivariatePolynomial(Vars, R, Order)(p)
```

```
Dom::MultivariatePolynomial(Vars, R, Order)(lm)
```

## Description

`Dom::MultivariatePolynomial(Vars, R, ..)` creates the domain of multivariate polynomials in the variable list `Vars` over the commutative ring `R` in distributed representation.

`Dom::MultivariatePolynomial` represents multivariate polynomials over arbitrary commutative rings.

All usual algebraic and arithmetical polynomial operations are implemented, including Gröbner basis computation and some classical construction tools used in invariant theory.

---

**Note** It is highly recommend to use only coefficient rings with unique zero representation. Otherwise it may happen that, e.g., a polynomial division will not terminate or a wrong degree will be returned.

---

`Dom::MultivariatePolynomial(Vars, R, Order)` creates a domain of multivariate polynomials in the variable list `Vars` over a domain `R` of category



Cat::CommutativeRing in sparse distributed representation with respect to the monomial ordering Order.

Dom::MultivariatePolynomial() creates a polynomial domain in the variable list [x,y,z] over the domain Dom::ExpressionField(normal) with respect to the lexicographic monomial ordering.

Dom::MultivariatePolynomial(Vars) generates the polynomial domain in the variable list Vars over the domain Dom::ExpressionField(normal) with respect to the lexicographic monomial ordering is created.

---

**Note** Only commutative coefficient rings of type DOM\_DOMAIN which inherit from Dom::BaseDomain are allowed. If R is of type DOM\_DOMAIN but does not inherit from Dom::BaseDomain, the domain Dom::ExpressionField(normal) will be used instead.

---

In contrast to the domain Dom::DistributedPolynomial, Dom::MultivariatePolynomial accepts only identifiers (DOM\_IDENT) as indeterminates. This restriction enables some further methods described below.

Please note: For reasons of efficiency not all methods check their arguments, not even at the interactive level. In particular this is true for many access methods, converting methods and technical methods. This may cause strange error messages.

## Superdomain

Dom::DistributedPolynomial

## Axioms

If R has Ax::normalRep, then Ax::normalRep.

If R has Ax::canonicalRep, then Ax::canonicalRep.

## Categories

If Vars has a single variable, then `Cat::UnivariatePolynomial(R)`, else `Cat::Polynomial(R)`.

## Examples

### Example 1

To create the ring of multivariate polynomials in  $x$ ,  $y$  and  $z$  over the rationals one may define

```
MP := Dom::MultivariatePolynomial([x, y, z], Dom::Rational)
```

```
Dom::MultivariatePolynomial([x, y, z], Dom::Rational, LexOrder)
```

The elementary symmetric polynomials of this domain are

```
s1 := MP(x + y + z)
```

```
x + y + z
```

```
s2 := MP(x*y + x*z + y*z)
```

```
x y + x z + y z
```

```
s3:=MP(x*y*z)
```

```
x y z
```

A polynomial is called symmetric if it remains unchanged under every possible permutation of variables as, e.g.:

```
s3=s3(MP(y), MP(z), MP(x))
```

```
x y z = x y z
```

These polynomials arise naturally in studying the roots of a polynomial. To show this, we first have to create an univariate polynomial, e.g., in  $U$  over  $MP$ , and generate a polynomial in  $U$  with roots in  $x$ ,  $y$  and  $z$ .

```
UP:=Dom::UnivariatePolynomial(U, MP)
```

```
Dom::UnivariatePolynomial(U, Dom::MultivariatePolynomial([x, y, z], Dom::Rational, LexOrder), LexOrder)
```

```
f := UP((U - x)*(U - y)*(U - z))
```

$$U^3 + (-x - y - z) U^2 + (x y + x z + y z) U - x y z$$

```
UP(U^3) - s1*UP(U^2) + s2*UP(U) + (-1)^3*s3
```

$$U^3 + (-x - y - z) U^2 + (x y + x z + y z) U - x y z$$

This exemplifies that the coefficients of  $f$  are (elementary) symmetric polynomials in its roots.

From the fundamental theorem of symmetric polynomials we know that every symmetric polynomial can be written uniquely as a polynomial in the elementary symmetric polynomials. Thus we can rewrite the following symmetric polynomial  $s$  in the elementary symmetric polynomials  $s_1$ ,  $s_2$  and  $s_3$ ,

```
s := MP(x^3*y + x^3*z + x*y^3 + x*z^3 + y^3*z + y*z^3)
```

$$x^3 y + x^3 z + x y^3 + x z^3 + y^3 z + y z^3$$

```
S := MP::rewritePoly(s, [s1=S1, s2=S2, s3=S3])
```

$$S1^2 S2 - S1 S3 - 2 S2^2$$

where these polynomials are represented by the three new variables  $S_1$ ,  $S_2$  and  $S_3$  respectively. To see that this new polynomial  $S$  in the new variables indeed represents the old original polynomial  $s$ , we simply have to plug in the three elementary symmetric polynomials into  $S$ :

```
poly(S, Expr)(s1,s2,s3)
```

$$x^3 y + x^3 z + x y^3 + x z^3 + y^3 z + y z^3$$

When one has a given list of polynomials, e.g., like:

```
l:=[3*s1,2*s1,s1,s3]
```

$$[3x + 3y + 3z, 2x + 2y + 2z, x + y + z, xyz]$$

and one wants to sort them in an appropriate order, one may use one of the following two methods.

```
MP::sortList(l,Dom::MonomOrdering(DegLex(3)))
```

$$[xyz, 2x + 2y + 2z, x + y + z, 3x + 3y + 3z]$$

```
MP::stableSort(l,Dom::MonomOrdering(DegLex(3)))
```

$$[xyz, 3x + 3y + 3z, 2x + 2y + 2z, x + y + z]$$

In the first sorted list the order of the three polynomials of the same degree has changed, while with the second method this order remains stable.

## Example 2

Let  $G \subset GL(n, k)$  be a finite (matrix) subgroup of the general linear group. Then a polynomial  $f \in k[x_1, \dots, x_n]$  is called *invariant under*  $G$ , if for all  $A \in G$

$$f(x) = f(Ax)$$

where  $x = (x_1 \dots x_n)$ . The symmetric polynomials  $s_1$ ,  $s_2$  and  $s_3$  from the previous example are invariants under the symmetric group  $S_3$ . In fact, these three fundamental invariants yet generate the whole ring of invariants of  $S_3$ .

Now let us examine the invariants of the famous icosahedral group. One may find a representation of this group on page 73 of H. F. Blichfeldt: Finite collineation groups, University of Chicago Press, 1917.

$$S' = \begin{pmatrix} \varepsilon^3 & 0 \\ 0 & \varepsilon^2 \end{pmatrix}, U' = \begin{pmatrix} 0 & 1 \\ -1 & 0 \end{pmatrix}, T' = \begin{pmatrix} \alpha & \beta \\ \beta & -\alpha \end{pmatrix}, \varepsilon^5 = 1, \alpha = \frac{\varepsilon^4 - \varepsilon}{\sqrt{5}}, \beta = \frac{\varepsilon^2 - \varepsilon^3}{\sqrt{5}}$$

The group is generated from these three matrices, has 120 elements and is thus a finite subgroup, even of the special linear group  $SL(2, \mathbb{Q}(\varepsilon))$ . It is also well known that

$$i_1 = x_1 x_2^{11} - x_1^6 x_2^6 - x_1^{11} x_2$$

is a fundamental invariant of degree 12 of this group. To declare  $i_1$  in MuPAD one has first to define the polynomial domain.

```
MP:=Dom::MultivariatePolynomial([x1,x2],Dom::Rational)
```

```
Dom::MultivariatePolynomial([x1, x2], Dom::Rational, LexOrder)
```

```
i1:=MP(x1*x2^(11)-11*x1^6*x2^6-x1^(11)*x2)
```

$$-x_1^{11} x_2 - 11 x_1^6 x_2^6 + x_1 x_2^{11}$$

From the invariant  $i_1$  one can compute a further fundamental invariant  $i_2$  with

```
i2:=MP::hessianDet(i1)
```

$$-121 x_1^{20} + 27588 x_1^{15} x_2^5 - 59774 x_1^{10} x_2^{10} - 27588 x_1^5 x_2^{15} - 121 x_2^{20}$$

But to get more simple coefficients we choose  $i_2$  as

```
i2:=-1/121*MP::hessianDet(i1)
```

$$x_1^{20} - 228 x_1^{15} x_2^5 + 494 x_1^{10} x_2^{10} + 228 x_1^5 x_2^{15} + x_2^{20}$$

instead. Similar we obtain a third fundamental invariant  $i_3$  with

```
i3:=1/20*MP::jacobianDet([i1,i2])
```

$$x_1^{30} + 522 x_1^{25} x_2^5 - 10005 x_1^{20} x_2^{10} - 10005 x_1^{10} x_2^{20} - 522 x_1^5 x_2^{25} + x_2^{30}$$

In contrast to the symmetric groups, where all invariants can be uniquely represented by the fundamental invariants, the fundamental invariants of this group have an algebraic relation, a so-called syzygy between them. It is possible to represent  $i_3^2$  in two ways:

```
MP::rewritePoly(i3^2,[i1=I1,i2=I2,i3=I3])
```

$$-1728 I_1^5 + I_2^3$$

```
MP::rewritePoly(i3^2,[i1=I1,i2=I2,i3=I3],Unsorted)
```

$$I_3^2$$

And hence we get the syzygy:

```
MP::rewritePoly(i3^2,[i1=I1,i2=I2,i3=I3],Unsorted)-
MP::rewritePoly(i3^2,[i1=I1,i2=I2,i3=I3]) = 0
```

$$1728 I_1^5 - I_2^3 + I_3^2 = 0$$

## Parameters

### Vars

A list of indeterminates. Default: [x, y, z].

### R

A commutative ring, i.e., a domain of category `Cat::CommutativeRing`. Default: `Dom::ExpressionField(normal)`.

## Order

A monomial ordering, i.e., one of the predefined orderings `LexOrder`, `DegreeOrder`, or `DegInvLexOrder` or any object of type `Dom::MonomOrdering`. Default: `LexOrder`.

## p

A polynomial or a polynomial expression.

## lm

List of monomials, which are represented as lists containing the coefficients together with the exponents or exponent vectors.

## Entries

"characteristic"	The characteristic of this domain.
"coeffRing"	The coefficient ring of this domain as defined by the parameter <code>R</code> .
"key"	The name of the domain created.
"one"	The neutral element w.r.t. <code>"_mult"</code> .
"ordering"	The monomial ordering defined by the parameter <code>Order</code> .
"variables"	The list of variables defined by the parameter <code>Vars</code> .
"zero"	The neutral element w.r.t. <code>"_plus"</code> .

## Methods

### Mathematical Methods

#### D — Differential operator for polynomials

Inherited from `Dom::DistributedPolynomial`.

**Dpoly — Differential operator for polynomials**

Inherited from Dom::DistributedPolynomial.

**SPolynomial — Compute the S-polynomial of two polynomials**

Inherited from Dom::DistributedPolynomial.

**\_divide — Exact polynomial division**

Inherited from Dom::DistributedPolynomial.

**\_invert — Inverse of an element**

Inherited from Dom::DistributedPolynomial.

**\_mult — Multiplie polynomials and coefficient ring elements**

Inherited from Dom::DistributedPolynomial.

**\_negate — Negate a polynomial**

Inherited from Dom::DistributedPolynomial.

**\_plus — Add polynomials and coefficient ring elements**

Inherited from Dom::DistributedPolynomial.

**\_power — Nth power of a polynomial**

Inherited from Dom::DistributedPolynomial.

**\_subtract — Subtract a polynomial or a coefficient ring element**

Inherited from Dom::DistributedPolynomial.

**associates — Test if elements are associates**

Inherited from Cat::IntegralDomain.

**borderedHessianDet — Bordered Hessian determinant of a polynomial**

borderedHessianDet(a, b, <v>)



**borderedHessianMat — Bordered Hessian matrix of a polynomial**`borderedHessianMat(a, b, <v>)`**content — Content of a polynomial**

Inherited from Dom::DistributedPolynomial.

**decompose — Functional decomposition of a polynomial**

Inherited from Dom::DistributedPolynomial.

**degLex — Compare two polynomials w.r.t. the graded lexicographical order**`degLex(a, b)`**degRevLex — Compare two polynomials w.r.t. the graded reverse lexicographical order**`degRevLex(a, b)`**diff — Differentiate a polynomial**

Inherited from Dom::DistributedPolynomial.

**dimension — Dimension of affine variety**

Inherited from Dom::DistributedPolynomial.

**divide — Divide polynomials**

Inherited from Dom::DistributedPolynomial.

**divides — Test if elements divides another**

Inherited from Cat::IntegralDomain.

**equal — Test for mathematical equality**

Inherited from Dom::BaseDomain.

**equiv — Test for equivalence**

Inherited from Cat::BaseCategory.

**evalp — Evaluate a polynomial**

Inherited from Dom::DistributedPolynomial.

**factor — Factor a polynomial**

Inherited from Dom::DistributedPolynomial.

**func\_call — Apply expressions to a polynomial**

Inherited from Dom::DistributedPolynomial.

**gcd — Greatest common divisor of polynomials**

Inherited from Dom::DistributedPolynomial.

**gcdex — Extended Euclidean algorithm for polynomials**

Inherited from Dom::DistributedPolynomial.

**groebner — Reduced Gröbner basis**

Inherited from Dom::DistributedPolynomial.

**hessianDet — Hessian determinant of a polynomial**

hessianDet(a, <v>)

**hessianMat — Hessian matrix of a polynomial**

hessianMat(a, <v>)

**homogeneousComponents — List of homogeneous components of a polynomial**

homogeneousComponents(a)

**idealGenerator — Generator of finitely generated ideal**

Inherited from Cat::EuclideanDomain.

**int — Definite and indefinite integration of a polynomial**

Inherited from Dom::DistributedPolynomial.

**intmult — Multiplie a polynomial with an integer**

Inherited from Dom::DistributedPolynomial.

**irreducible — Test if element is irreducible**

Inherited from Cat::FactorialDomain.

**isHomogeneous — Test if a polynomial is homogeneous**

isHomogeneous(a)

**isUnit — Test if element is a unit**

Inherited from Cat::Polynomial.

**isone — Test for one**

Inherited from Dom::DistributedPolynomial.

**iszero — Test for zero**

Inherited from Dom::DistributedPolynomial.

**jacobianDet — Jacobian determinant of a polynomial**

jacobianDet(ais, <v>)

**jacobianMat — Jacobian matrix of a polynomial**

jacobianMat(ais, <v>)

**lcm — Least common multiple of polynomials**

Inherited from Dom::DistributedPolynomial.

**makeIntegral — Make the coefficients fraction free**

Inherited from Dom::DistributedPolynomial.

**monic — Normalize a polynomial**

Inherited from Dom::DistributedPolynomial.

**normalForm — Complete reduction modulo an ideal**

Inherited from Dom::DistributedPolynomial.

**pdioe — Solve polynomial Diophantine equations**

Inherited from Dom::DistributedPolynomial.

**pdivide — Pseudo-division of polynomials**

Inherited from Dom::DistributedPolynomial.

**pquo — Pseudo-quotient of polynomials**

Inherited from Dom::DistributedPolynomial.

**prem — Pseudo-remainder of polynomials**

Inherited from Dom::DistributedPolynomial.

**primpart — Return primitive part**

Inherited from Cat::Polynomial.

**quo — Euclidean quotient**

Inherited from Cat::EuclideanDomain.

**random — Create a random polynomial**

Inherited from Dom::DistributedPolynomial.

**rem — Euclidean remainder**

Inherited from Cat::EuclideanDomain.

**resultant — Resultant of two polynomials**

Inherited from Dom::DistributedPolynomial.

**rewriteHomPoly — Rewrite a polynomial in terms of other polynomials**

rewriteHomPoly(a, ais, v)

All the polynomials  $a$  and  $a_i$ s must be homogeneous.

The variables of  $v$  should be new variables.

### **rewritePoly — Rewrite a polynomial in terms of other polynomials**

`rewritePoly(a, [ai = vi], <Unsorted>)`

This method can be used for representing a polynomial with respect to a given polynomial basis.

When option `Unsorted` is given, the list `[ai=vi]` is not sorted. Otherwise, in a precomputation step this list will be sorted in the  $a_i$ 's w.r.t. the graded lexicographical order ("`degLex`").

Please note: the algorithm depends on the order of `Vars` and  $a_i$ s.

All the polynomials  $a_i$  must be homogeneous.

The variables of  $v_i$  should be new variables.

### **ringmult — Multiplie a polynomial with a coefficient ring element**

Inherited from `Dom::DistributedPolynomial`.

### **solve — Zero of polynomials**

Inherited from `Dom::DistributedPolynomial`.

### **sqrfree — Square-free factorization of polynomials**

Inherited from `Dom::DistributedPolynomial`.

### **unitNormal — Return unit normal**

Inherited from `Cat::Polynomial`.

### **unitNormalRep — Return unit normal representation**

Inherited from `Cat::Polynomial`.

## Access Methods

**coeff** — Coefficient of a polynomial

Inherited from Dom::DistributedPolynomial.

**degree** — Degree of a polynomial

Inherited from Dom::DistributedPolynomial.

**degreevec** — Vector of exponents of the leading term of a polynomial

Inherited from Dom::DistributedPolynomial.

**euclideanDegree** — Euclidean degree function

Inherited from Dom::DistributedPolynomial.

**ground** — Ground term of a polynomial

Inherited from Dom::DistributedPolynomial.

**has** — Existence of an object in a polynomial

Inherited from Dom::DistributedPolynomial.

**indets** — Indeterminate of a polynomial

Inherited from Dom::DistributedPolynomial.

**lcoeff** — Leading coefficient of a polynomial

Inherited from Dom::DistributedPolynomial.

**ldegree** — Lowest degree of a polynomial

Inherited from Dom::DistributedPolynomial.

**lmonomial** — Leading monomial of a polynomial

Inherited from Dom::DistributedPolynomial.

**lterm — Leading term of a polynomial**

Inherited from Dom::DistributedPolynomial.

**mainvar — Main variable of a polynomial**

Inherited from Dom::DistributedPolynomial.

**mapcoeffs — Apply a function to the coefficients of a polynomial**

Inherited from Dom::DistributedPolynomial.

**multcoeffs — Multiply the coefficients of a polynomial with a factor**

Inherited from Dom::DistributedPolynomial.

**nterms — Number of terms of a polynomial**

Inherited from Dom::DistributedPolynomial.

**nthcoeff — N-th coefficient of a polynomial**

Inherited from Dom::DistributedPolynomial.

**nthmonomial — N-th monomial of a polynomial**

Inherited from Dom::DistributedPolynomial.

**nthterm — N-th term of a polynomial**

Inherited from Dom::DistributedPolynomial.

**order — Compare two polynomials w.r.t. a given order**

order(a, b, o)

**orderedVariableList — Ordered list of indeterminates of a polynomial**

Inherited from Dom::DistributedPolynomial.

**pivotSize — Size of a pivot element**

Inherited from Dom::DistributedPolynomial.

**reductum — Reductum of a polynomial**

Inherited from Dom::DistributedPolynomial.

**sortList — Sort a list of polynomials w.r.t. a given order**

sortList(ais, o)

This sorting method may be not stable if o is not a total order.

**stableSort — Sort a list of polynomials w.r.t. a given order**

stableSort(ais, o)

This sorting method is stable, even if o is not a total order.

**subs — Avoid substitution**

Inherited from Dom::BaseDomain.

**subsex — Avoid extended substitution**

Inherited from Dom::BaseDomain.

**tcoeff — Lowest coefficient of a polynomial**

Inherited from Dom::DistributedPolynomial.

## References

- [1] Winfried Fakler. "Algorithmen zur symbolischen Lösung homogener linearer Differentialgleichungen". Diplomarbeit, Universität Karlsruhe, 1994.

## See Also

**MuPAD Domains**

Dom::DistributedPolynomial | Dom::Polynomial |  
Dom::UnivariatePolynomial



# Dom::Natural

Semi-ring of natural integer numbers

## Syntax

Dom::Natural(x)

## Description

Dom::Natural is the semi-ring of integer numbers represented by elements of the domain DOM\_INT.

Dom::Natural is the domain of natural integer numbers represented by expressions of type DOM\_INT.

Elements of Dom::Natural are usually not created explicitly. However, if one creates elements using the usual syntax, it is checked whether the input is an integer number. This means that Dom::Natural is a façade domain which creates elements of domain type DOM\_INT.

Viewed as a differential ring Dom::Natural is trivial, it contains constants only.

Dom::Natural has the domain Dom::Numerical as its super domain, i.e., it inherits each method which is defined by Dom::Numerical and not re-implemented by Dom::Natural. Methods described below are those implemented by Dom::Natural.

## Superdomain

Dom::Numerical

## Axioms

```
Ax::canonicalRep, Ax::systemRep, Ax::canonicalOrder,  
Ax::canonicalUnitNormal, Ax::closedUnitNormals,  
Ax::efficientOperation("_divide"), Ax::efficientOperation("_mult")
```

## Categories

```
Cat::EuclideanDomain, Cat::FactorialDomain, Cat::DifferentialRing,  
Cat::OrderedSet
```

## Examples

### Example 1

Creating some integer numbers using `Dom::Natural`. This example also shows that `Dom::Natural` is a façade domain.

```
Dom::Natural(2); domtype(%)
```

```
2
```

```
DOM_INT
```

```
Dom::Natural(2/3)
```

```
Error: Invalid arguments. [Dom::Natural::new]
```

### Example 2

By tracing the method `Dom::Natural::testtypeDom` we can see the interaction between `testtype` and `Dom::Natural::testtypeDom`.

```
prog::trace(Dom::Natural::testtypeDom):  
delete x:
```

```
testtype(x, Dom::Natural);  
testtype(3, Dom::Natural);  
prog::untrace(Dom::Natural::testtypeDom):  
  
enter Dom::Natural::testtypeDom(x, Dom::Natural)  
computed FAIL
```

FALSE

```
enter Dom::Natural::testtypeDom(3, Dom::Natural)  
computed TRUE
```

TRUE

## Parameters

**x**

An integer

## Methods

### Mathematical Methods

**\_divide** — Division of two objects

\_divide(x, y)

**\_divides** — Decide if a number divides another one

\_divides(x, y)

**euclideanDegree** — Euclidean degree

euclideanDegree(x)

**factor — Factorization**

factor(x)

**gcd — Gcd computation**

gcd(x1, x2, ...)

**gcdex — Apply the extended Euclidean algorithm**

gcdex(x, y)

**\_invert — Inverse of an element**

\_invert(x)

**irreducible — Prime number test**

irreducible(x)

**isUnit — Test if an element is a unit**

isUnit(x)

**lcm — Compute the lcm**

lcm(x1, x2, ...)

**quo — Compute the euclidean quotient**

quo(x, y)

**random — Random number generation**

random()

random(n)

random(m, ..., n)

This methods returns a random number between 0 and  $n - 1$ .

This methods returns a random number between m and n.

**rem — Compute the Euclidean remainder**`rem(x, y)`**unitNormal — Unit normal part**`unitNormal(x)`**unitNormalRep — Unit normal representation**`unitNormalRep(x)`

## Conversion Methods

**convert — Conversion of objects**`convert(x)`**convert\_to — Conversion to other domains**`convert_to(x, T)`

The following domains are allowed for for T: `DOM_INT`, `Dom::Natural`, `Dom::Rational`, `DOM_FLOAT`, `Dom::Float` and `Dom::Numerical`.

**testtype — Type checking**`testtype(x, T)`

Usually, this method is called from the function `testtype` and not directly by the user. “Example 2” on page 7-342 (Symbolic Math Toolbox) demonstrates this behavior.

## See Also

**MuPAD Domains**`Dom::Complex` | `Dom::Float` | `Dom::Integer` | `Dom::Numerical` | `Dom::Rational`

## Dom::Numerical

Field of numbers

### Syntax

`Dom::Numerical(x)`

### Description

`Dom::Numerical` is the field of numbers.

`Dom::Numerical` is the domain of numbers represented by one of the kernel domains `DOM_INT`, `DOM_RAT`, `DOM_FLOAT`, or `DOM_COMPLEX`.

`Dom::Numerical` is of category `Cat::Field` due to pragmatism. This domain actually is not a field because `bool(1.0 = float(3) / float(3))` returns `FALSE`, for example.

Elements of `Dom::Numerical` are usually not created explicitly. However, if one creates elements using the usual syntax, it is checked whether the input expression can be converted into a number (see below).

This means that `Dom::Numerical` is a façade domain which creates elements of domain type `DOM_INT`, `DOM_RAT`, `DOM_FLOAT` or `DOM_COMPLEX`. Every system function dealing with numbers can be applied, and computations in this domain are performed efficiently.

`Dom::Numerical` has no normal representation, because `0` and `0.0` both represent zero.

Viewed as a differential ring, `Dom::Numerical` is trivial. It only contains constants.

If `x` is a constant arithmetical expression on page 33-16 (Symbolic Math Toolbox) such as `sin(2)` or `PI + 2`, the system function `float` is applied to convert `x` into a floating-point approximation.

An error message is issued if the result of this conversion is not of domain type `DOM_FLOAT` or `DOM_COMPLEX`.

## Superdomain

Dom::ArithmeticalExpression

## Axioms

Ax::canonicalRep, Ax::systemRep, Ax::efficientOperation("\_divide"),  
Ax::efficientOperation("\_mult"), Ax::efficientOperation("\_invert")

## Categories

Cat::DifferentialRing, Cat::Field

## Examples

### Example 1

Dom::Numerical contains numbers of the domains DOM\_INT, DOM\_RAT, DOM\_FLOAT and DOM\_COMPLEX:

```
Dom::Numerical(2), Dom::Numerical(2/3),  
Dom::Numerical(3.141), Dom::Numerical(2 + 3*I)
```

$2, \frac{2}{3}, 3.141, 2 + 3i$

Constant arithmetical expressions are converted into a real and complex floating-point number, respectively, i.e., into an element of the domain DOM\_FLOAT or DOM\_COMPLEX (see the function float for details):

```
Dom::Numerical(exp(5)), Dom::Numerical(sin(2/3*I) + 3)
```

$148.4131591, 3.0 + 0.717158461i$

Note that the elements of this domain are elements of kernel domains, there are no elements of the domain type `Dom::Numerical`!

An error message is issued for non-constant arithmetical expressions:

```
Dom::Numerical(sin(x))
```

```
Error: Invalid arguments. [Dom::Numerical::new]
```

## Example 2

`Dom::Numerical` is regarded as a field, and it therefore can be used as a coefficient ring of polynomials or as a component ring of matrices, for example.

We create the domain of matrices of arbitrary size (see `Dom::Matrix`) with numerical components:

```
MatN := Dom::Matrix(Dom::Numerical)
```

```
Dom::Matrix(Dom::Numerical)
```

Next we create a banded matrix, such as:

```
A := MatN(4, 4, [-PI, 0, PI], Banded)
```

$$\begin{pmatrix} 0 & 3.141592654 & 0 & 0 \\ -3.141592654 & 0 & 3.141592654 & 0 \\ 0 & -3.141592654 & 0 & 3.141592654 \\ 0 & 0 & -3.141592654 & 0 \end{pmatrix}$$

and a row vector with four components as a  $1 \times 4$  matrix:

```
v := MatN([[2, 3, -1, 0]])
```

```
(2 3 -1 0)
```

Vector-matrix multiplication can be performed with the standard operator `*` for multiplication:



$v * A$

( -9.424777961 9.424777961 9.424777961 -3.141592654 )

Finally we compute the determinant of the matrix A, using the function `det`:

`det(A)`

97.40909103

## Parameters

**x**

An arithmetical expression (Symbolic Math Toolbox)

## Entries

"characteristic"	is zero.
------------------	----------

## Methods

### Mathematical Methods

#### **D** – Differential operator for numbers

`D(a)`

See the function `D` for details and further calling sequences.

#### **diff** – Differentiation of numbers

`diff(a, x)`

See the function `diff` for details and further calling sequences.

**norm — Absolute value of numbers**

`norm(a)`

**random — Random number generation**

`random()`

## Conversion Methods

**convert — Conversion of objects into numbers**

`convert(x)`

If `x` is of the domain type `DOM_INT`, `DOM_RAT`, `DOM_FLOAT` or `DOM_COMPLEX`, `x` is returned.

Otherwise `float(x)` is computed and the result is returned, if it is of the domain type `DOM_FLOAT` or `DOM_COMPLEX`. If it is not, `FAIL` is returned.

**convert\_to — Conversion into other domains**

`convert_to(a, T)`

If the conversion fails, `FAIL` is returned.

It currently handles the following domains for `T`: `DOM_INT`, `Dom::Integer`, `DOM_RAT`, `Dom::Rational`, `DOM_FLOAT`, `Dom::Float` and `DOM_COMPLEX`.

**testtype — Type checking**

`testtype(a, T)`

This method is called from the function `testtype`.

## See Also

**MuPAD Domains**

`Dom::Complex` | `Dom::Float` | `Dom::Integer` | `Dom::Rational` | `Dom::Real`

# Dom::Polynomial

Domains of polynomials in arbitrarily many indeterminates

## Syntax

### Domain Creation

`Dom::Polynomial(<R, <Order>>)`

### Element Creation

`Dom::PolynomialRorder(p)`

`Dom::PolynomialRorder(lm, v)`

## Description

`Dom::Polynomial(R, ..)` creates the domain of polynomials in arbitrarily many indeterminates over the commutative ring `R` in distributed representation.

`Dom::Polynomial` represents polynomials in arbitrarily many indeterminates over arbitrary commutative rings.

It is simply a front end to the domain `Dom::DistributedPolynomial([], R, Order)` and thus all usual algebraic and arithmetical polynomial operations are implemented. Please see the documentation for `Dom::DistributedPolynomial` for a list of methods.

`Dom::Polynomial(R, Order)` creates a domain of polynomials in arbitrarily many indeterminates over a domain of category `Cat::CommutativeRing` in sparse distributed representation with respect to the monomial ordering `Order`.

If `Dom::Polynomial` is called without any argument, a polynomial domain over the domain `Dom::ExpressionField(normal)` with respect to the lexicographic monomial ordering is created.

---

**Note** Only commutative coefficient rings of type `DOM_DOMAIN` which inherit from `Dom::BaseDomain` are allowed. If `R` is of type `DOM_DOMAIN` but does not inherit from `Dom::BaseDomain`, the domain `Dom::ExpressionField(normal)` will be used instead.

---

Only identifiers should be used as polynomial indeterminates, since when creating a new element from a polynomial or a polynomial expression the function `indet`s is first called to get the identifiers and then the polynomial is created with respect to these identifiers.

---

**Note** It is highly recommend to use only coefficient rings with unique zero representation. Otherwise it may happen that, e.g., a polynomial division will not terminate or a wrong degree will be returned.

---

Please note that for reasons of efficiency not all methods check their arguments, not even at the interactive level. In particular, this is true for many access methods, converting methods and technical methods. Thus, improper use of these methods may result in confusing error messages.

## Superdomain

`Dom::DistributedPolynomial`

## Axioms

`Ax::indetElements`

## Categories

`Cat::Polynomial(R)`

## Examples

### Example 1

The following call creates the polynomial domain over the rationals.

```
PR:=Dom::Polynomial(Dom::Rational)
```

```
Dom::Polynomial(Dom::Rational, LexOrder)
```

Since the monomial ordering was not specified, this domain is created with the default value for this parameter.

It is rather easy to create elements of this domain, as, e.g.,

```
a := PR(x*(2*x + y^3) - 7/2)
```

$$2x^2 + xy^3 - \frac{7}{2}$$

```
b := PR(x*(2*t + z^3) - 6)
```

$$2tx + xz^3 - 6$$

```
c := a^2-b/3+3
```

$$-\frac{2tx}{3} + 4x^4 + 4x^3y^3 + x^2y^6 - 14x^2 - 7xy^3 - \frac{xz^3}{3} + \frac{69}{4}$$

## Parameters

### R

A commutative ring, i.e., a domain of category `Cat::CommutativeRing`. Default: `Dom::ExpressionField(normal)`.

**Order**

A monomial ordering, i.e., one of the predefined orderings `LexOrder`, `DegreeOrder`, or `DegInvLexOrder` or an element of the domain `Dom`: `: MonomOrdering`. Default: `LexOrder`.

**p**

A polynomial or a polynomial expression.

**lm**

List of monomials, which are represented as lists containing the coefficients together with the exponents or exponent vectors.

**v**

List of indeterminates.

**Entries**

"characteristic"	The characteristic of this domain, which is the characteristic of R.
"coeffRing"	The coefficient ring of this domain as defined by the parameter R.
"key"	The name of the domain created.
"one"	The neutral element w.r.t. " <code>_mult</code> ", which is <code>R::one</code> .
"ordering"	The monomial order as defined by the parameter <code>Order</code> .
"zero"	The neutral element w.r.t. " <code>_plus</code> ", which is <code>R::zero</code> .

**Algorithms**

To create polynomials from expressions with no suitable indeterminates the dummy variable `_dummy` is introduced. With this variable it is possible to create elements from

constants which otherwise would fail. The drawback of this approach is that two mathematically equal polynomials may have variable lists which differ by this dummy variable.

## See Also

### **MuPAD Domains**

Dom::DistributedPolynomial | Dom::MultivariatePolynomial |  
Dom::UnivariatePolynomial

## Dom::Product

Homogeneous direct products

### Syntax

#### Domain Creation

```
Dom::Product(Set, <n>)
```

```
Dom::ProductSetn(e1, e2, ..., en)
```

```
Dom::ProductSetn(List)
```

### Description

`Dom::Product(Set, n)` is an n-fold direct product of the domain *Set*.

`Dom::Product(Set, n)(e1, e2, ..., en)` creates the n-tuple  $(e_1, e_2, \dots, e_n)$ .

The objects *e1*, *e2*, ..., *en* must be convertible into elements of the domain *Set*, otherwise an error message is issued.

`Dom::Product(Set, n)(List)` creates the n-tuple  $(l_1, l_2, \dots, l_n)$ .

The *n* elements  $l_i$  of *List* must be convertible into elements of the domain *Set*, otherwise an error message is issued.

The list must consist of exactly *n* elements, otherwise an error message is issued.

Following to the definition of a direct product many of the methods such as "D" and "\_negate" just map the operation to all the components of the tuple.

Most n-ary methods like "\_plus" and "\_mult" apply the operation component-wise to the tuples.



## Superdomain

Dom::BaseDomain

## Axioms

If Set has Ax::canonicalRep, then Ax::canonicalRep.

If Set has Cat::AbelianMonoid, then Ax::normalRep.

## Categories

Cat::HomogeneousFiniteProduct(Set)

## Examples

### Example 1

Define the 3-fold direct product of the rational numbers:

```
P3 := Dom::Product(Dom::Rational, 3)
```

```
Dom::Product(Dom::Rational, 3)
```

and create elements:

```
a := P3([1, 2/3, 0])
```

```
[1, 2/3, 0]
```

```
b := P3(2/3, 4, 1/2)
```

```
[2/3, 4, 1/2]
```

We use the standard arithmetical operators to calculate with such tuples:

```
a + b, a*b, 2*a
```

$$\left[\frac{5}{3}, \frac{14}{3}, \frac{1}{2}\right], \left[\frac{2}{3}, \frac{8}{3}, 0\right], \left[2, \frac{4}{3}, 0\right]$$

Some system functions were overloaded for such elements, such as `diff`, `map` or `zip` (see the description of the corresponding methods "`diff`", "`map`" and "`zip`" above).

For example, to divide each component of `a` by 2 we enter:

```
map(a, `/\`, 2)
```

$$\left[\frac{1}{2}, \frac{1}{3}, 0\right]$$

The quoted character ``/\`` is another notation for the function `_divide`, the functional form of the division operator `/`.

Be careful that the mapping function returns elements of the domain the product is defined over. This is not checked by the function `map` (for efficiency reasons) and may lead to "invalid" tuples. For example:

```
b := map(a, sin); domtype(b)
```

$$\left[\sin(1), \sin\left(\frac{2}{3}\right), 0\right]$$

```
Dom::Product(Dom::Rational, 3)
```

But the components of `b` are no longer rational numbers!

## Parameters

### Set

An arbitrary domain of elements, i.e., a domain of category `Cat :: BaseCategory`

**n**

The dimension of the product (a positive integer); default is 1

**ele2, en, ...**

Elements of `Set` or objects convertible into such

**List**

A list of `n` elements of `Set` or objects convertible into such

## Entries

"dimen"	is the dimension of <code>Dom::Product(Set, n)</code> , which is equal to <code>n</code> .
"coeffRing"	is the domain <code>S</code> .
"one"	is the <code>n</code> -tuple <code>(Set::one, Set::one, ..., Set::one)</code> . This entry only exists if <code>Set</code> is a monoid, i.e., a domain of category <code>Cat::Monoid</code> .
"zero"	is the <code>n</code> -tuple <code>(Set::zero, Set::zero, ..., Set::zero)</code> . This entry only exists if <code>Set</code> is an Abelian group, i.e., a domain of category <code>Cat::AbelianGroup</code> .

## Methods

### Mathematical Methods

**`_divide` — Divide tuples**

`_divide(x, y)`

This method only exists if `Set` is a (multiplicative) group, i.e., a domain of category `Cat::Group`.

This method overloads the function `_divide` for n-tuples, i.e., one may use it in the form `x / y`, or in functional notation: `_divide(x, y)`.

### **`_invert` – Compute the inverse of a tuple**

`_invert(x)`

This method only exists if `Set` is a (multiplicative) group, i.e., a domain of category `Cat::Group`.

This method overloads the function `_invert` for n-tuples, i.e., one may use it in the form `1/x` or `x(-1)`, or in functional notation: `_inverse(x)`.

### **`_less` – Less-than relation**

`_less(x, y)`

An implementation is provided only if `Set` is an ordered set, i.e., a domain of category `Cat::OrderedSet`.

This method overloads the function `_less` for n-tuples, i.e., one may use it in the form `x < y`, or in functional notation: `_less(x, y)`.

### **`_mult` – Multiplie tuples by tuples and scalars**

`_mult(x, y, ...)`

If `x` is not of the type `Dom::Product(Set, n)`, it is considered as a scalar which is multiplied to each component of the n-tuple `y` (and vice versa).

This method only exists if `Set` is a semigroup, i.e., a domain of category `Cat::SemiGroup`.

This method also handles more than two arguments. In this case, the argument list is split into two parts of the same length which both are multiplied with the function `_mult`. These two result are multiplied again with `_mult` whose result then is returned.

This method overloads the function `_mult` for n-tuples, i.e., one may use it in the form `x * y`, or in functional notation: `_mult(x, y)`.

**\_negate — Negate an n-tuple**`_negate(x)`

This method overloads the function `_negate` for n-tuples, i.e., one may use it in the form `-x`, or in functional notation: `_negate(x)`.

**\_power — ith power of a tuple**`_power(x, i)`

An implementation is provided only if `Set` is a semigroup, i.e., a domain of category `Cat::SemiGroup`.

This method overloads the function `_power` for n-tuples, i.e., one may use it in the form `x^i`, or in functional notation: `_power(x, i)`.

**\_plus — Add tuples**`_plus(x, y, ...)`

The sum of two n-tuples `x` and `y` is defined component-wise as  $(x_1 + y_1, \dots, x_n + y_n)$ .

This method overloads the function `_plus` for n-tuples, i.e., one may use it in the form `x + y`, or in functional notation: `_plus(x, y)`.

**D — Differential operator**`D(x)`

An implementation is provided only if `Set` is a partial differential ring, i.e., a domain of category `Cat::PartialDifferentialRing`.

This method overloads the operator `D` for n-tuples, i.e., one may use it in the form `D(x)`.

**diff — Differentiation of n-tuples**`diff(a, x)`

This method overloads the function `diff` for n-tuples, i.e., one may use it in the form `diff(a, x)`.

An implementation is provided only if `Set` is a partial differential ring, i.e., a domain of category `Cat::PartialDifferentialRing`.

**equal — Test on equality of n-tuples**

```
equal(x, y)
```

**intmult — Multiple of a tuple**

```
intmult(x, k)
```

An implementation is provided only if `Set` is an Abelian semigroup, i.e., a domain of category `Cat::AbelianSemiGroup`.

**iszero — Test on zero**

```
iszero(x)
```

Note that there may be more than one representation of the zero n-tuple if `R` does not have `Ax::canonicalRep`.

This method overloads the function `iszero` for n-tuples, i.e., one may use it in the form `iszero(x)`.

**random — Random tuple generation**

```
random()
```

## Access Methods

**`_index` — Tuple indexing**

```
_index(x, i)
```

See also the method `"op"`.

This method overloads the function `_index` for n-tuples, i.e., one may use it in the form `x[i]`, or in functional notation: `_index(x, i)`.

**map — Apply a function to tuple components**

```
map(x, func, <expr, ...>)
```

---

**Note** Note that the function values will *not* be implicitly converted into elements of the domain `Set`. One has to take care that the function calls return elements of the domain type `Set`.

---

This method overloads the function `map` for n-tuples, i.e., one may use it in the form `map(x, func, ...)`.

### **mapCanFail — Apply a function to tuple components**

`mapCanFail(x, func, <expr, ...>)`

#### **op — Component of a tuple**

`op(x, i)`

`op(x)`

See also the method "`_index`".

This method overloads the function `op` for n-tuples, i.e., one may use it in the form `op(x, i)`.

Returns a sequence of all components of `x`.

### **set\_index — Assigning tuple components**

`set_index(x, i, e)`

See also the method "`subsop`".

---

**Note** This method does not check whether `e` has the correct type.

---

This method overloads the indexed assignment `_assign` for n-tuples, i.e., one may use it in the form `x[i] := e`, or in functional notation: `_assign(x[i], e)`.

### **sort — Sorting the components of a tuple**

`sort(x)`

This method overloads function `sort` for tuples, i.e. one may use it in the form `sort(x)`.

**subs — Substitution of tuple components**

subs(x, ...)

---

**Note** The objects obtained by the substitutions will not be implicitly converted into elements of the domain Set. One has to take care that the substitutions return elements of the domain Set.

---

This method overloads the function subs for n-tuples, i.e., one may use it in the form subs(x, ...). See subs for details and calling sequences.

**testEach — Check every component for a certain condition**

testEach(x, func, <expr, ...>)

func must return either TRUE or FALSE, otherwise a runtime error is raised.

**testOne — Check an component for a certain condition**

testOne(x, func, <expr, ...>)

func must return either TRUE or FALSE, otherwise a runtime error is raised.

**zip — Combine tuples component-wise**

zip(x, y, func, <expr, ...>)

---

**Note** The function values will not be implicitly converted into elements of the domain Set. One has to take care that the function calls return elements of the domain Set.

---

This method overloads the function zip for n-tuples, i.e., one may use it in the form zip(x, y, func, ...).

**zipCanFail — Combine tuples component-wise**

zipCanFail(x, y, func, <expr, ...>)



## Conversion Methods

### **convert — Conversion into an n-tuple**

`convert(List)`

`convert(e1, <e2, ...>)`

FAIL is returned if this conversion fails.

Tries to convert the arguments into an element of the domain `Dom::Product(Set, n)`. This can be done if exactly `n` arguments are given where each argument can be converted into an element of the domain `Set`.

FAIL is returned if this conversion fails.

### **expr — Conversion into an object of a kernel domain**

`expr(x)`

This method overloads the function `expr` for n-tuples, i.e., one may use it in the form `expr(x)`.

## Dom::Quaternion

Skew field of quaternions

### Syntax

`Dom::Quaternion(listi)`

`Dom::Quaternion(ex)`

`Dom::Quaternion(M)`

### Description

Domain `Dom::Quaternion` represents the skew field of quaternions.

Quaternions are usually defined to be complex  $2 \times 2$  matrices of the special form

$$\begin{pmatrix} a+bi & -c-di \\ c-di & a-bi \end{pmatrix},$$

where  $a, b, c, d$  are real numbers. Another usual notation is  $a + bi + cj + dk$ ; the subfield of those quaternions for which  $c = d = 0$  is isomorphic to the field of complex numbers.

The domain `Dom::Quaternion` regards these fields as being identical, and it allows both notations that have been mentioned, as well as simply  $[a, b, c, d]$ .

If you enter a quaternion as an arithmetical expression `ex`, the identifiers `i`, `j`, and `k` are understood in the way mentioned above; `I`, `J`, and `K` may be used alternatively, and you may also mix small and capital letters. Every subexpression of `ex` not containing one of these must be real and constant.

---

**Note** Be sure that you have not assigned a value to one of the identifiers mentioned.

---

`Dom::Quaternion` has the domain `Dom::BaseDomain` as its super domain, i.e., it inherits each method which is defined by `Dom::BaseDomain` and not re-implemented by

Dom::Quaternion. Methods described below are re-implemented by Dom::Quaternion.

## Superdomain

Dom::BaseDomain

## Axioms

Ax::canonicalRep

## Categories

Cat::SkewField

## Examples

### Example 1

Creating some quaternions.

```
Dom::Quaternion([1,2,3,4]),
Dom::Quaternion(11+12*i+13*j+14*k);
M := Dom::Matrix(Dom::Complex)([[3+4*I, -6-2*I],[6-2*I, 3-4*I]]):
M, Dom::Quaternion(M)
```

$$1 + 2i + 3j + 4k, 11 + 12i + 13j + 14k$$

$$\begin{pmatrix} 3 + 4i & -6 - 2i \\ 6 - 2i & 3 - 4i \end{pmatrix}, 3 + 4i + 6j + 2k$$

## Example 2

Doing some standard arithmetic.

```

a:=Dom::Quaternion([1,2,3,4]):
b:=Dom::Quaternion([11,2,33.3,2/3]):
a*b, a+b, a^2/3, b^3;

```

$$-95.56666667 - 107.2 i + 72.96666667 j + 105.2666667 k, 12 + 4 i + 36.3 j + \frac{14 k}{3},$$

$$-\frac{28}{3} + \frac{4 i}{3} + 2 j + \frac{8 k}{3}, -35409.03667 - 1500.668889 i - 24986.137 j - 500.222963 k$$

## Example 3

More mathematical operations:

```

a:=Dom::Quaternion([1,2,3,4]):
b:=Dom::Quaternion([11,2,33.3,2/3]):
Dom::Quaternion::nthroot(b,3);
abs(a), sign(b)

```

$$2.993953193 + 0.07959236197 i + 1.325212827 j + 0.02653078732 k$$

$$\sqrt{30}, 0.3130950929 + 0.05692638053 i + 0.9478242358 j + 0.01897546018 k$$

## Example 4

Some miscellaneous operations.

```

a:=Dom::Quaternion([1,2,3,4]):
Dom::Quaternion::matrixform(a);
map(a, sqrt), map(a, _plus, 1);

```

$$\begin{pmatrix} 1+2i & -3-4i \\ 3-4i & 1-2i \end{pmatrix}$$

$$1 + \sqrt{2}i + \sqrt{3}j + 2k, 2 + 3i + 4j + 5k$$

## Parameters

### listi

A list containing four elements of type `Type::Real`

### ex

Arithmetical expression

### M

A matrix of type `Dom::Matrix(Dom::Complex)`. It has to be of a special form described in the Details section.

## Entries

"characteristic"	the characteristic of this domain is 0
"one"	the unit element; it equals <code>Dom::Quaternion([1,0,0,0])</code> .
"size"	the number of quaternions is <i>infinity</i> .
"zero"	The zero element; it equals <code>Dom::Quaternion([0,0,0,0])</code> .

## Methods

### Mathematical Methods

`_mult` — Multiplie quaternions

`_mult(x, y, ...)`

**`_plus` — Add quaternions**

`_plus(x, y, ...)`

**`_power` — n-th power of a quaternion**

`_power(x, n)`

**`Im` — Return the imaginary (vectorial) part of a quaternion.**

`Im(x)`

The result is still a quaternion.

**`Re` — Return the real part of a quaternion.**

`Re(x)`

The result is of type `Type::Real`.

**`abs` — Absolute value of a quaternion**

`abs(x)`

The result is of type `Type::Real`.

**`conjugate` — Conjugate element**

`conjugate(x)`

**`intpower` — Multiplie quaternions**

`intpower(x, {DOM_INT})`

The implementation uses “repeated squaring”.

`Dom::Quaternion` is used by “`_power`”.

**`nthroot` — N-th root of a quaternion**

`nthroot(x, n)`

The implementation uses “repeated squaring”.

Dom::Quaternion is used by "\_power".

#### **norm — Norm of a quaternion**

norm(x)

The result is of type Type::Real.

#### **random — Random number generation**

random()

#### **scalarmult — Scalar multiplication**

scalarmult(s, x)

#### **scalarprod — Inner product**

scalarprod(x, y)

#### **sign — Sign of a quaternion**

sign(x)

The result is of type Type::Real.

## **Conversion Methods**

#### **convert — Conversion of objects**

convert(x)

#### **convert\_to — Conversion to other domains**

convert\_to(x, T)

It currently handles the following domains for T: DOM\_EXPR, DOM\_LIST, Dom::Matrix(Dom::Complex).

#### **expr — Convert a quaternion to an object of a kernel domain**

expr(x)

The result is an object of the kernel domain `DOM_EXPR`.

This method overloads the function `expr` for quaternions, i.e., you may use it in the form `expr(x)`.

**matrixform** — Convert a quaternion to a 2 x 2 matrix with complex entries.

`matrixform(x)`

The result is an object of the domain `Dom::Matrix(Dom::Complex)`.

## Technical Methods

**map** — Apply a function to all components of a quaternion

`map(x, f, arg, ...)`

If optional arguments are present, then each component `co` of `x` is replaced by `f(co, arg...)`. So for the quaternion  $x := a + bi + cj + dk$ , `Dom::Quaternion(x, f, arg, ...)` returns the quaternion  $f(a, arg, ...) + f(b, arg, ...)i + f(c, arg, ...)j + f(d, arg, ...)k$ .

**simplify** — Simplification of a quaternion

`simplify(x)`

## See Also

**MuPAD Domains**

`Dom::Complex`



# Dom::Rational

Field of rational numbers

## Syntax

`Dom::Rational(x)`

## Description

`Dom::Rational` is the domain of rational numbers represented by elements of the domains `DOM_INT` or `DOM_RAT`. `Dom::Rational` represents the field of rational numbers.

Elements of `Dom::Rational` are usually not created explicitly. However, if one creates elements using the usual syntax, it is checked whether the input is of type `DOM_INT` or `DOM_RAT`. This means `Dom::Rational` is a façade domain which creates elements of domain type `DOM_INT` or `DOM_RAT`.

Viewed as a differential ring `Dom::Rational` is trivial, it contains constants only.

`Dom::Rational` has the domain `Dom::Numerical` as its super domain, i.e., it inherits each method which is defined by `Dom::Numerical` and not re-implemented by `Dom::Rational`. Methods described below are re-implemented by `Dom::Rational`.

## Superdomain

`Dom::Numerical`

## Axioms

```
Ax::canonicalRep, Ax::systemRep, Ax::canonicalOrder,  
Ax::efficientOperation("_divide"), Ax::efficientOperation("_mult"),  
Ax::efficientOperation("_invert")
```

## Categories

```
Cat::QuotientField(Dom::Integer), Cat::DifferentialRing,  
Cat::OrderedSet
```

## Examples

### Example 1

Creating some rational numbers using `Dom::Rational`. This example also shows that `Dom::Rational` is a façade domain.

```
Dom::Rational(2/3) ; domtype(%)
```

$\frac{2}{3}$

DOM\_RAT

```
Dom::Rational(2.0)
```

```
Error: Invalid arguments. [Dom::Rational::new]
```

### Example 2

By tracing the method `Dom::Rational::testtypeDom` we can see the interaction between `testtype` and `Dom::Rational::testtypeDom`.

```
prog::trace(Dom::Rational::testtypeDom):  
delete x:  
testtype(x, Dom::Rational);  
testtype(3/4, Dom::Rational);  
prog::untrace(Dom::Rational::testtypeDom):  
  
enter Dom::Rational::testtypeDom(x, Dom::Rational)  
computed FAIL
```

FALSE

```
enter Dom::Rational::testtypeDom(3/4, Dom::Rational)
computed TRUE
```

TRUE

## Parameters

**x**

An integer or a rational number

## Methods

### Mathematical Methods

**denom** — Denominator of a rational number

denom(x)

**diff** — Differentiates

diff(z, <x, ...>)

**numer** — Numerator of the rational number

numer(x)

**random** — Random number generation

random()

**retract — Retract to an integer element**

retract(x)

## Conversion Methods

**convert — Conversion of objects**

convert(x)

**convert\_to — Conversion to other domains**

convert\_to(x, T)

The following domains are allowed for T: DOM\_INT, Dom::Integer, Dom::Rational, DOM\_RAT, DOM\_FLOAT, Dom::Float and Dom::Numerical.

**testtype — Type checking**

testtype(x, T)

In general this method is called from the function `testtype` and not directly by the user. “Example 2” on page 7-374 (Symbolic Math Toolbox) demonstrates this behaviour.

## See Also

**MuPAD Domains**

Dom::Complex | Dom::Float | Dom::Numerical | Dom::Rational | Dom::Real

# Dom::Real

Field of real numbers

## Syntax

Dom::Real(x)

## Description

Dom::Real is the field of real numbers represented by elements of the kernel domains DOM\_INT, DOM\_RAT, DOM\_FLOAT, and DOM\_EXPR.

Dom::Real is the domain of real numbers represented by expressions of type DOM\_INT, DOM\_RAT or DOM\_FLOAT. An expression of type DOM\_EXPR is considered as a real number if it is of type Type::Arithmetical and if it contains no indeterminates which are not of type Type::ConstantIdents and if it contains no imaginary part. See “Example 2” on page 7-378 (Symbolic Math Toolbox).

Dom::Real has category Cat::Field due to practical reasons. This domain actually is not a field because `bool(1.0 = 1e100 + 1.0 - 1e100)` returns FALSE for example.

Elements may not have an unique representation, for example `bool(0 = sin(2)^2 + cos(2)^2 - 1)` returns FALSE.

Elements of Dom::Real are usually not created explicitly. However, if one creates elements using the usual syntax, it is checked whether the input expression can be converted to a number. This means Dom::Real is a façade domain which creates elements of domain type DOM\_INT, DOM\_RAT, DOM\_FLOAT, or DOM\_EXPR.

Dom::Real has no normal representation, because 0 and 0.0 both represent zero.

Viewed as a differential ring, Dom::Real is trivial, it contains constants only.

Dom::Real has the domain Dom::Complex as its super domain, i.e., it inherits each method which is defined by Dom::Complex and not re-implemented by Dom::Real. Methods described below are re-implemented by Dom::Real.

## Superdomain

Dom::Complex

## Axioms

Ax::systemRep, Ax::canonicalOrder, Ax::efficientOperation("\_divide"),  
Ax::efficientOperation("\_mult"), Ax::efficientOperation("\_invert")

## Categories

Cat::DifferentialRing, Cat::Field, Cat::OrderedSet

## Examples

### Example 1

The following lines demonstrate how to generate elements of Dom::Real. The rational and the floating-point numbers are elements of the real numbers:

Dom::Real(2/3)

$\frac{2}{3}$

Dom::Real(0.5666)

0.5666

### Example 2

The numbers PI and sin(2) are real numbers whereas sin(2/3 \* I) + 3 and sin(x) for general symbolic x are not real numbers. If we try to create the elements Dom::Real(sin(2/3 \* I) + 3) and Dom::Real(sin(x)) an error message is produced.

Dom::Real(PI)

$\pi$

Dom::Real(sin(2))

sin(2)

Dom::Real(sin(2/3 \* I) + 3)

Error: Invalid arguments. [Dom::Real::new]

Dom::Real(sin(x))

Error: Invalid arguments. [Dom::Real::new]

## Parameters

**x**

An expression of type DOM\_INT, DOM\_RAT, or DOM\_FLOAT. An expression of type DOM\_EXPR is also allowed if it is of type Type::Arithmetical and if it contains no indeterminates which are not of type Type::ConstantIdents and if it contains no imaginary part.

## Methods

### Mathematical Methods

**\_less** — Boolean operator “less”

\_less(x, y)

**\_leequal — Boolean operator “less or equal”**

`_leequal(x, y)`

**\_power — Power operator**

`_power(z, n)`

**conjugate — Complex conjugate**

`conjugate(x)`

**Im — Imaginary part of a real number**

`Im(x)`

**random — Random number generation**

`random()`

`random(n)`

`random(m .. n)`

This method returns a random number generator which creates positive integer between 0 and  $n - 1$ .

This method returns a random number generator which creates positive integer between  $m$  and  $n$ .

**Re — Real part of a real number**

`Re(x)`

## **Conversion Methods**

**convert — Conversion of objects**

`convert(x)`



**convert\_to – Conversion to other domains**`convert_to(x, T)`

The following domains are allowed for T: DOM\_INT, Dom::Integer, DOM\_RAT, Dom::Rational, DOM\_FLOAT, Dom::Float, Dom::Numerical, Dom::ArithmeticalExpression, Dom::Complex.

**See Also****MuPAD Domains**`Dom::Complex | Dom::Float | Dom::Integer | Dom::Numerical | Dom::Rational`

# Dom::SquareMatrix

Rings of square matrices

## Syntax

### Domain Creation

`Dom::SquareMatrix(n, <R>)`

### Element Creation

`Dom::SquareMatrix(n, R)(Array)`

`Dom::SquareMatrix(n, R)(Matrix)`

`Dom::SquareMatrix(n, R)(<n, n>)`

`Dom::SquareMatrix(n, R)(<n, n>, ListOfRows)`

`Dom::SquareMatrix(n, R)(<n, n>, f)`

`Dom::SquareMatrix(n, R)(<n, n>, List, <Diagonal>)`

`Dom::SquareMatrix(n, R)(<n, n>, g, <Diagonal>)`

`Dom::SquareMatrix(n, R)(<n, n>, List, <Banded>)`

## Description

### Domain Creation

`Dom::SquareMatrix(n, R)` creates a domain which represents the ring of  $n \times n$  matrices over a component domain  $R$ . The domain  $R$  must be of category `Cat::Rng` (a ring, possibly without unit).

If the optional parameter  $R$  is not given, the domain `Dom::ExpressionField()` is used as the component ring for the square matrices.

For matrices of a domain created by `Dom::SquareMatrix(n, R)`, standard matrix arithmetic is implemented by overloading the standard arithmetical operators `+`, `-`, `*`, `/` and `^`. All functions of the `linalg` package dealing with matrices can also be applied.

`Dom::SquareMatrix(n, R)` has the domain `Dom::Matrix(R)` as its super domain, i.e., it inherits each method which is defined by `Dom::Matrix(R)` and not re-implemented by `Dom::SquareMatrix(n, R)`.

Methods described below are re-implemented by `Dom::SquareMatrix`.

The domain `Dom::Matrix(R)` represents matrices over  $R$  of arbitrary size, and it therefore does not have any algebraic structure (except of being a *set* of matrices).

The domain `Dom::MatrixGroup(m, n, R)` represents the Abelian group of  $m \times n$  matrices over  $R$ .

## Element Creation

`Dom::SquareMatrix(n, R)(Array)` and `Dom::SquareMatrix(n, R)(Matrix)` create a new matrix formed by the entries of `Array` and `Matrix`, respectively.

The components of `Array` and `Matrix`, respectively, are converted into elements of the domain  $R$ . An error message is issued if one of these conversions fails.

The call `Dom::SquareMatrix(n, R)(n, n)` returns the  $n \times n$  zero matrix. Note that the  $n \times n$  zero matrix is also defined by the entry "zero" (see below).

`Dom::SquareMatrix(n, R)(n, n, ListOfRows)` creates an  $n \times n$  matrix with components taken from the nested list on page 7-41 `ListOfRows`. Each inner list corresponds to a row of the matrix.

If an inner list has less than  $n$  entries, the remaining components in the corresponding row of the matrix are set to zero. If there are less than  $n$  inner lists, the remaining lower rows of the matrix are filled with zeroes.

The entries of the inner lists are converted into elements of the domain  $R$ . An error message is issued if one of these conversions fails.

It might be a good idea first to create a two-dimensional array on page 7-2 from that list before calling `Dom::SquareMatrix(n, R)`. This is due to the fact that creating a matrix

from an array is the fastest way one can achieve. However, in this case the sublists must have the same number of elements.

`Dom::SquareMatrix(n, R)( n , n f)` returns the matrix whose  $(i, j)$ th component is the value of the function call `f(i, j)`. The row and column indices  $i$  and  $j$  range from 1 to  $n$ .

The function values are converted into elements of the domain  $R$ . An error message is issued if one of these conversions fails.

## Superdomain

`Dom::Matrix(R)`

## Axioms

If  $R$  has `Ax::canonicalRep`, then `Ax::canonicalRep`.

## Categories

`Cat::SquareMatrix(R)`

## Examples

### Example 1

A lot of examples can be found on the help page of the domain constructor `Dom::Matrix`, and most of them are also examples for working with domains created by `Dom::SquareMatrix`.

These examples only concentrate on some differences with respect to working with matrices of the domain `Dom::Matrix(R)`.

The following command defines the ring of two-dimensional matrices over the rationals:

```
SqMatQ := Dom::SquareMatrix(2, Dom::Rational)
```

```
Dom::SquareMatrix(2, Dom::Rational)
```

```
SqMatQ::hasProp(Cat::Ring)
```

```
TRUE
```

The unit is defined by the entry "one", which is the 2×2 identity matrix:

```
SqMatQ::one
```

$$\begin{pmatrix} 1 & 0 \\ 0 & 1 \end{pmatrix}$$

Note that some operations defined by the domain SqMatQ return matrices which are no longer square. They return therefore matrices of the domain `Dom::Matrix(Dom::Rational)`, the super-domain of SqMatQ. For example, if we delete the first row of the matrix:

```
A := SqMatQ([[1, 2], [-5, 3]])
```

$$\begin{pmatrix} 1 & 2 \\ -5 & 3 \end{pmatrix}$$

we get the matrix:

```
SqMatQ::delRow(A, 1)
```

$$(-5 \ 3)$$

which is of the domain type:

```
domtype(%)
```

```
Dom::Matrix(Dom::Rational)
```

## Example 2

We can convert a square matrix into or from another matrix domain, as shown next:

```
SqMatR := Dom::SquareMatrix(3, Dom::Real):  
MatC := Dom::Matrix(Dom::Complex):
```

```
A := SqMatR((i, j) -> sin(i*j))
```

$$\begin{pmatrix} \sin(1) & \sin(2) & \sin(3) \\ \sin(2) & \sin(4) & \sin(6) \\ \sin(3) & \sin(6) & \sin(9) \end{pmatrix}$$

To convert A into a matrix of the domain MatC, enter:

```
coerce(A, MatC)
```

$$\begin{pmatrix} \sin(1) & \sin(2) & \sin(3) \\ \sin(2) & \sin(4) & \sin(6) \\ \sin(3) & \sin(6) & \sin(9) \end{pmatrix}$$

```
domtype(%)
```

```
Dom::Matrix(Dom::Complex)
```

The conversion is done component-wise, as the following examples shows:

```
B := MatC([[0, 1], [exp(I), 0]])
```

$$\begin{pmatrix} 0 & 1 \\ e^i & 0 \end{pmatrix}$$

The matrix  $B$  is square but has one complex component and therefore cannot be converted into the domain SqMatR:

```
coerce(B, SqMatR)
```

FAIL

## Parameters

**n**

A positive integer

**R**

A ring, i.e., a domain of category `Cat::Rng`; default is `Dom::ExpressionField()`

**Array**

An  $n \times n$  array

**Matrix**

An  $n \times n$  matrix, i.e., an element of a domain of category `Cat::Matrix`

**List**

A list of matrix components

**ListOfRows**

A list of at most  $n$  rows; each row is a list of at most  $n$  matrix components

**f**

A function (Symbolic Math Toolbox) or a functional expression (Symbolic Math Toolbox) with two parameters (the row and column index)

**g**

A function or a functional expression with one parameter (the row index)

## Options

### Diagonal

Create a diagonal matrix

With the option `Diagonal`, diagonal matrices can be created with diagonal elements taken from a list on page 7-41, or computed by a function (Symbolic Math Toolbox).

`Dom::SquareMatrix(n, R)( n , n List, Diagonal)` creates the  $n \times n$  diagonal matrix whose diagonal elements are the entries of `List`.

`List` must have at most  $n$  entries. If it has fewer elements, the remaining diagonal elements are set to zero.

The entries of `List` are converted into elements of the domain  $R$ . An error message is issued if one of these conversions fails.

`Dom::SquareMatrix(n, R)( n , n g, Diagonal)` returns the matrix whose  $i$ th diagonal element is  $g(i)$ , where the index  $i$  runs from 1 to  $n$ .

The function values are converted into elements of the domain  $R$ . An error message is issued if one of these conversions fails.

### Banded

Create a banded Toeplitz matrix

`Dom::SquareMatrix(n, R)( n , n List, Banded)` creates an  $n \times n$  banded Toeplitz matrix with the elements of `List` as entries. The number of entries of `List` must be odd, say  $2h + 1$ , and must not exceed  $n$ . The resulting matrix has bandwidth at most  $2h + 1$ .

All elements of the main diagonal of the created matrix are initialized with the middle element of `List`. All elements of the  $i$ th subdiagonal are initialized with the  $(h + 1 - i)$ th element of `List`. All elements of the  $i$ th superdiagonal are initialized with the  $(h + 1 + i)$ th element of `List`. All entries on the remaining sub- and superdiagonals are set to zero.

The entries of `List` are converted into elements of the domain  $R$ . An error message is issued if one of these conversions fails.



## Entries

"one"	is the $n \times n$ identity matrix. This entry exists if the component ring R is a domain of category <code>Cat::Ring</code> , i.e., a ring with unit.
"randomDimen"	is set to <code>[n, n]</code> .
"zero"	is the $n \times n$ zero matrix.

## Methods

### Mathematical Methods

#### **evalp** — Evaluating matrices of polynomials at a certain point

```
evalp(A, x = a, ...)
```

This method is only defined if R is a polynomial ring of category `Cat::Polynomial`.

This method overloads the function `evalp` for matrices, i.e., one may use it in the form `evalp(A, x = a)`.

#### **identity** — Identity matrix

```
identity(k)
```

---

**Note** The matrix returned is of the domain `Dom::Matrix(R)` if  $k \neq n$ .

---

This method only exists if the component ring R is of category `Cat::Ring`, i.e., a ring with unit.

#### **matdim** — Matrix dimension

```
matdim(A)
```

**random — Random matrix generation**

random()

The components of the random matrix are generated with the method "random" of the component ring R.

## Access Methods

**\_concat — Horizontal concatenation of matrices**

\_concat(A, B, ...)

An error message is issued if the given matrices do not have the same number of rows.

---

**Note** The matrix returned is of the domain `Dom::Matrix(R)`!

---

This method overloads the function `_concat` for matrices, i.e., one may use it in the form `A . B . ...`, or in functional notation: `_concat(A, B, ...)`.

**\_index — Matrix indexing**

\_index(A, i, j)

\_index(A, r1 .. r2, c1 .. c2)

If `i` and `j` are not integers, then the call of this method returns in its symbolic form (of type "`_index`") with evaluated arguments.

Otherwise an error message is given, if `i` and `j` are not valid row and column indices, respectively.

---

**Note** Note that the system function `context` is used to evaluate the entry in the context of the calling environment.

---

Returns the submatrix of `A`, created by the rows of `A` with indices from `r1` to `r2` and the columns of `A` with indices from `c1` to `c2`.

---

**Note** The submatrix returned is of the domain `Dom::Matrix(R)`!

---

This method overloads the function `_index` for matrices, i.e., one may use it in the form `A[i, j]` and `A[r1..r2, c1..c2]`, respectively, or in functional notation: `_index(A, ...)`.

**concatMatrix — Horizontal concatenation of matrices**

`concatMatrix(A, B, ...)`

**col — Extracting a column**

`col(A, c)`

An error message is issued if `c` is less than one or greater than `n`.

**delCol — Deleting a column**

`delCol(A, c)`

NIL is returned if `A` only consists of one column.

---

**Note** The matrix returned is of the domain `Dom::Matrix(R)`.

---

An error message is issued if `c` is less than one or greater than `n`.

**delRow — Deleting a row**

`delRow(A, r)`

NIL is returned if `A` only consists of one row.

---

**Note** The matrix returned is of the domain `Dom::Matrix(R)`.

---

An error message is issued if `r` is less than one or greater than `n`.

**row — Extracting a row**

`row(A, r)`

An error message is issued if  $r$  is less than one or greater than  $n$ .

**stackMatrix — Vertical concatenation of matrices**

`stackMatrix(A, B, ...)`

An error message is issued if the given matrices do not have the same number of columns.

---

**Note** The matrix returned is of the domain `Dom::Matrix(R)`!

---

## Conversion Methods

**create — Defining matrices without component conversions**

`create(x, ...)`

This method should be used if the elements of the parameters  $x, \dots$  are elements of the domain type  $R$ . This is often the case if a matrix is to be created whose components come from preceding matrix and scalar operations.

## See Also

**MuPAD Domains**

`Dom::Matrix` | `Dom::MatrixGroup`

# Dom::SymmetricGroup

Symmetric groups

## Syntax

Dom::SymmetricGroup( $n$ )

Dom::SymmetricGroup( $n$ )( $l$ )

## Description

Dom::SymmetricGroup( $n$ ) creates the symmetric group of order  $n$ , that is, the domain of all the permutations of  $\{1, \dots, n\}$  elements.

A permutation of  $n$  elements is a bijective mapping of the set  $\{1, \dots, n\}$  onto itself.

The domain element Dom::SymmetricGroup( $n$ )( $l$ ) represents the bijective mapping of the first  $n$  positive integers that maps the integer  $i$  to  $l[i]$ , for  $1 \leq i \leq n$ .

## Superdomain

Dom::BaseDomain

## Axioms

Ax::canonicalRep

## Categories

Cat::Group

## Examples

### Example 1

Consider the group of permutations of the first seven positive integers:

```
G := Dom::SymmetricGroup(7)
```

```
Dom::SymmetricGroup(7)
```

We create an element of G by providing the image of 1, 2, etc.:

```
a:=G([2,4,6,1,3,5,7])
```

```
[2, 4, 6, 1, 3, 5, 7]
```

```
a(3)
```

```
6
```

## Parameters

**n**

Positive integer

**l**

List or array consisting of the first  $n$  integers in some order.

## Entries

"one"	the identical mapping of the set $\{1, \dots, n\}$ to itself.
-------	---

## Methods

### Mathematical Methods

#### **\_mult — Product of permutations**

`_mult(a1, ...)`

This method overloads the function `_mult`.

#### **\_invert — Inverse of a permutation**

`_invert(a)`

This method overloads the function `_invert`.

#### **func\_call — Function value of a permutation at a point**

`func_call(a, i)`

It computes the function value of `a` at `i`, i.e., the integer that `i` is mapped to by the permutation `a`; `i` must be an integer between 1 and  $n$ .

#### **cycles — Cycle representation of a permutation**

`cycles(a)`

#### **order — Order of a permutation**

`order(a)`

#### **inversions — Number of inversions**

`inversions(a)`

#### **sign — Sign of a permutation**

`sign(a)`

#### **random — Random permutation**

`random()`

## Access Methods

**allElements** — Return all elements of the group

allElements()

**size** — Return the size of the group

size()

## Conversion Methods

**convert** — Conversion of an object into a permutation

convert(x)

**convert\_to** — Conversion of a permutation into another type

convert\_to(a, T)

**expr** — Convert a permutation into a list

expr(a)



# Dom::UnivariatePolynomial

Domains of univariate polynomials

## Syntax

### Domain Creation

```
Dom::UnivariatePolynomial(<Var, <R, <Order>>>)
```

### Element Creation

```
Dom::UnivariatePolynomial(Var, R, Order)(p)
```

```
Dom::UnivariatePolynomial(Var, R, Order)(lm)
```

## Description

`Dom::UnivariatePolynomial(Var, R, ..)` creates the domain of univariate polynomials in the variable `Var` over the commutative ring `R`.

`Dom::UnivariatePolynomial` represents univariate polynomials over arbitrary commutative rings.

All usual algebraic and arithmetical polynomial operations are implemented, including Gröbner basis computations.

`Dom::UnivariatePolynomial(Var, R, Order)` creates a domain of univariate polynomials in the variable `Var` over a domain of category `Cat::CommutativeRing` in sparse representation with respect to the monomial ordering `Order`.

`Dom::UnivariatePolynomial()` creates the univariate polynomial domain in the variable `x` over the domain `Dom::ExpressionField(normal)` with respect to the lexicographic monomial ordering.

`Dom::UnivariatePolynomial(Var)` creates the univariate polynomial domain in the variable `Var` over the domain `Dom::ExpressionField(normal)` with respect to the lexicographic monomial ordering.

---

**Note** Only commutative coefficient rings of type `DOM_DOMAIN` which inherit from `Dom::BaseDomain` are allowed. If `R` is of type `DOM_DOMAIN` but inherits not from `Dom::BaseDomain`, the domain `Dom::ExpressionField(normal)` will be used instead.

---

For this domain only identifiers are valid variables.

---

**Note** It is highly recommend to use only coefficient rings with unique zero representation. Otherwise it may happen that, e.g., a polynomial division will not terminate or a wrong degree will be returned.

---

Please note that for reasons of efficiency not all methods check their arguments, not even at the interactive level. In particular this is true for many access methods, converting methods and technical methods. Therefore, using these methods inappropriately may result in strange error messages.

## Superdomain

`Dom::MultivariatePolynomial`

## Axioms

If `R` has `Ax::normalRep`, then `Ax::normalRep`.

If `R` has `Ax::canonicalRep`, then `Ax::canonicalRep`.

## Categories

`Cat::UnivariatePolynomial(R)`

## Examples

### Example 1

To create the ring of univariate polynomials in  $x$  over the integers one may define

```
UP:=Dom::UnivariatePolynomial(x,Dom::Integer)
```

```
Dom::UnivariatePolynomial(x, Dom::Integer, LexOrder)
```

Now, let us create two univariate polynomials.

```
a:=UP((2*x-1)^2*(3*x+1))
```

$$12x^3 - 8x^2 - x + 1$$

```
b:=UP(((2*x-1)*(3*x+1))^2)
```

$$36x^4 - 12x^3 - 11x^2 + 2x + 1$$

The usual arithmetical operations for polynomials are available:

```
a^2+a*b
```

$$432x^7 - 288x^6 - 264x^5 + 200x^4 + 35x^3 - 36x^2 - x + 2$$

The leading coefficient, leading term, leading monomial and reductum of  $a$  are

```
lcoeff(a), lterm(a), lmonomial(a), UP::reductum(a)
```

$$12, x^3, 12x^3, -8x^2 - x + 1$$

and  $a$  is of degree

```
degree(a)
```

3

The method `gcd` computes the greatest common divisor of two polynomials

`gcd(a, b)`

$$12x^3 - 8x^2 - x + 1$$

and `lcm` the least common multiple:

`lcm(a, b)`

$$36x^4 - 12x^3 - 11x^2 + 2x + 1$$

Computing the definite and indefinite integral of a polynomial is also possible,

`int(a)`

$$3x^4 - \frac{8x^3}{3} - \frac{x^2}{2} + x$$

which is in the case of indefinite integration simply the antiderivative of the polynomial.

`D(int(a)), domtype(D(int(a)))`

$$12x^3 - 8x^2 - x + 1,$$

`Dom::UnivariatePolynomial(x, Dom::Fraction(Dom::Integer), LexOrder)`

But, since for representing the indefinite integral of `a` the coefficient ring chosen as the integers is not appropriate, the polynomial ring over its quotient field is used instead.

Furthermore, interpreting the polynomials as polynomial functions is also allowed in applying coefficient ring elements, polynomials of this domain or arbitrary expressions with option `Expr` to them:

`a(5)`

1296

`a(b)`

$$559872 x^{12} - 559872 x^{11} - 326592 x^{10} + 414720 x^9 + 73872 x^8 - 123120 x^7 - 9924 x^6 \\ + 18408 x^5 + 1144 x^4 - 1364 x^3 - 97 x^2 + 38 x + 4$$

`a(sin(x), Expr)`

$$12 \sin(x)^3 - 8 \sin(x)^2 - \sin(x) + 1$$

To get a vector of coefficients of a polynomial, which gives the dense representation of it, one may use the method `vectorize`.

`UP::vectorize(a), UP::vectorize(a,6)`

$$[1, -1, -8, 12], [1, -1, -8, 12, 0, 0]$$

## Parameters

### Var

An indeterminate given by an identifier; default is `x`.

### R

A commutative ring, i.e. a domain of category `Cat::CommutativeRing`; default is `Dom::ExpressionField(normal)`.

### Order

A monomial ordering, i.e. one of the predefined orderings `LexOrder`, `DegreeOrder` or `DegInvLexOrder` or an element of domain `Dom::MonomOrdering`; default is `LexOrder`.

**p**

A polynomial or a polynomial expression.

**ℓm**

List of monomials, which are represented as lists containing the coefficients together with the exponents or exponent vectors.

## Entries

"characteristic"	The characteristic of this domain.
"coeffRing"	The coefficient ring of this domain as defined by the parameter R.
"key"	The name of the domain created.
"one"	The neutral element w.r.t. "_mult".
"ordering"	The monomial order as defined by the parameter Order.
"variables"	The list of the variable as defined by the parameter Var.
"zero"	The neutral element w.r.t. "_plus".

## Methods

### Access Methods

**coeff — Coefficient of a polynomial**

coeff(a)

coeff(a, Var, n)

coeff(a, n)

coeff(a, Var, n) returns the coefficient of the term  $\text{Var}^n$  as an element of R.

`coeff(a, n)` returns the coefficient of the term  $\text{Var}^n$  as an element of  $R$ .

This method overloads the function `coeff` for polynomials.

**degree — Degree of a polynomial**

Inherited from `Dom::DistributedPolynomial`.

**degreevec — Vector of exponents of the leading term of a polynomial**

Inherited from `Dom::DistributedPolynomial`.

**euclideanDegree — Euclidean degree function**

Inherited from `Dom::DistributedPolynomial`.

**ground — Ground term of a polynomial**

Inherited from `Dom::DistributedPolynomial`.

**has — Existence of an object in a polynomial**

Inherited from `Dom::DistributedPolynomial`.

**indets — Indeterminate of a polynomial**

Inherited from `Dom::DistributedPolynomial`.

**lcoeff — Leading coefficient of a polynomial**

Inherited from `Dom::DistributedPolynomial`.

**ldegree — Lowest degree of a polynomial**

Inherited from `Dom::DistributedPolynomial`.

**lmonomial — Leading monomial of a polynomial**

Inherited from `Dom::DistributedPolynomial`.

**lterm — Leading term of a polynomial**

Inherited from `Dom::DistributedPolynomial`.

**mainvar — Main variable of a polynomial**

Inherited from Dom::DistributedPolynomial.

**mapcoeffs — Apply a function to the coefficients of a polynomial**

Inherited from Dom::DistributedPolynomial.

**multcoeffs — Multiplie the coefficients of a polynomial with a factor**

Inherited from Dom::DistributedPolynomial.

**nterms — Number of terms of a polynomial**

Inherited from Dom::DistributedPolynomial.

**nthcoeff — N-th coefficient of a polynomial**

Inherited from Dom::DistributedPolynomial.

**nthmonomial — N-th monomial of a polynomial**

Inherited from Dom::DistributedPolynomial.

**nthterm — N-th term of a polynomial**

Inherited from Dom::DistributedPolynomial.

**order — Compare two polynomials w.r.t. a given order**

Inherited from Dom::MultivariatePolynomial.

**orderedVariableList — Ordered list of indeterminates of a polynomial**

Inherited from Dom::DistributedPolynomial.

**pivotSize — Size of a pivot element**

Inherited from Dom::DistributedPolynomial.

**reductum — Reductum of a polynomial**

Inherited from Dom::DistributedPolynomial.



**sortList — Sort a list of polynomials w.r.t. a given order**

Inherited from Dom::MultivariatePolynomial.

**stableSort — Sort a list of polynomials w.r.t. a given order**

Inherited from Dom::MultivariatePolynomial.

**subs — Avoid substitution**

Inherited from Dom::BaseDomain.

**subsex — Avoid extended substitution**

Inherited from Dom::BaseDomain.

**tcoeff — Lowest coefficient of a polynomial**

Inherited from Dom::DistributedPolynomial.

**vectorize — Vectorized form of a polynomial**

vectorize(a, <n>)

## See Also

**MuPAD Domains**

Dom::DistributedPolynomial | Dom::MultivariatePolynomial |

Dom::Polynomial

## Factored

Objects kept in factored form

## Syntax

Factored(list, <type>, <ring>)

Factored(f, <type>, <ring>)

## Description

Factored is the domain of objects kept in factored form, such as prime factorization of integers, square-free factorization of polynomials, or the factorization of polynomials in irreducible factors.

The argument `list` must be a list of odd length and of the form `[u, f1, e1, f2, e2, ..., fr, er]`, where the entries  $u$  and  $f_i$  are elements of the domain `ring`, or can be converted into such elements. The  $e_i$  must be integers. Here,  $i$  ranges from 1 to  $r$ .

See section "Operands" below for the meaning of the entries of that list.

An error message is reported, if one of the list entries is of wrong type.

An arithmetical expression `f` given as the first argument is the same as giving the list `[ring::one, f, 1]`.

See section "Operands" below for the meaning of the entries of that list.

`f` must be an element of the domain `ring`, or must be convertible into such an element, otherwise an error message would be given.

The argument `type` indicates what is known about the factorization. Currently, the following types are known:

- "unknown" - nothing is known about the factorization.
- "irreducible" - the  $f_i$  are irreducible over the domain `ring`.

- "squarefree" - the  $f_i$  are square-free over the domain ring.

If this argument is missing, then the type of the created factored object is set to "unknown".

The type of factorization is known to any element of `Factored`. Use the methods "getType" and "setType" (see below) to read and set the type of factorization of a given factored object.

The argument `ring` is the ring of factorization. It must be an integral domain, i.e., a domain of category `Cat::IntegralDomain`.

If this argument is missing, then the domain `Dom::ExpressionField()` is used.

The ring of factorization is known to any element of `Factored`. Use the methods "getRing" and "setRing" (see below) to read and set the ring of factorization of a given factored object.

You can use the index operator `[ ]` to extract the factors of an element `f` of the domain `Factored`. E.g., for  $f = u f_1^{e_1} f_2^{e_2} \dots$ , you have  $f[1] = u$ ,  $f[2] = f_1^{e_1}$ ,  $f[3] = f_2^{e_2}$  etc.

You can also use the methods "factors" and "exponents" (see below) to access the operands, i.e., the call `Factored::factors(f)` returns a list of the factors  $f_i$ , and `Factored::exponents(g)` returns a list of the exponents  $e_i$  ( $1 \leq i \leq r$ ).

The system functions `ifactor`, `factor` and `polylib::sqrfree` are the main application of this domain, they return their result in form of such factored objects (see their help pages for information about the type and ring of factorization).

There may be no need to explicitly create factored objects, but to work with the results of the mentioned system functions.

Note that an element of `Factored` is printed like an expression and behaves like that. As an example, the result of `f := factor(x^2 + 2*x + 1)` is an element of `Factored` and printed as  $(x + 1)^2$ . The call `type(f)` returns "\_power" as the expression type of `f`.

For an element `f` of `Factored`, the call `Factored::convert(f, DOM_LIST)` gives a list of all operands of `f`.

## Examples

### Example 1

The following computes the prime factorization of the integer 20:

```
f := ifactor(20)
```

```
22 5
```

The result is an element of the domain Factored:

```
domtype(f)
```

```
Factored
```

which consists of the following five operands:

```
op(f)
```

```
1, 2, 2, 5, 1
```

They represent the integer 20 in the following form:  $20 = 1 \cdot 2^2 \cdot 5$ . The factors are prime numbers and can be extracted via `Factored::factors`:

```
Factored::factors(f)
```

```
[2, 5]
```

`ifactor` kept the information that the factorization ring is the ring of integers (represented by the domain `Dom::Integer`), and that the factors of `f` are prime (and therefore irreducible, because  $\mathbb{Z}$  is an integral domain):

```
Factored::getRing(f), Factored::getType(f)
```

```
Dom::Integer, "irreducible"
```

We can convert such an object into different forms, such as into a list of its operands:

```
Factored::convert_to(f, DOM_LIST)
```

```
[1, 2, 2, 5, 1]
```

or into an unevaluated expression, keeping the factored form:

```
Factored::convert_to(f, DOM_EXPR)
```

```
22 5
```

or back into an integer:

```
Factored::convert_to(f, Dom::Integer)
```

```
20
```

You may also use the system function `coerce` here, which has the same effect.

## Example 2

We compute the factorization of the integers 108 and 512:

```
n1 := ifactor(108); n2 := ifactor(512)
```

```
22 33
```

```
29
```

The multiplication of these two integers gives the prime factorization of  $55296 = 108 \cdot 512$ :

```
n1*n2
```

```
211 33
```

Note that the most operations on such objects lead to an un-factored form, such as adding these two integers:

```
n1 + n2
```

```
620
```

You may apply the function `ifactor` to the result, if you are interested in its prime factorization:

```
ifactor(%)
```

```
22 5 31
```

You can apply (almost) each function to factored objects, functions that mainly expect arithmetical expressions as their input. Note that, before the operation is applied, the factored object is converted into an arithmetical expression in un-factored form:

```
Re(n1)
```

```
108
```

### Example 3

The second system function which deals with elements of `Factored`, is `factor`, which computes all irreducible factors of a polynomial.

For example, if we define the following polynomial of  $\mathbb{Z}_{101}$ :

```
p := poly(x12 + x + 1, [x], Dom::IntegerMod(101)):
```

and compute its factorization into irreducible factors, we get:

```
f := factor(p)
```

```

poly(x^2 + 73 x + 29, [x], Dom::IntegerMod(101))
poly(x^5 + 62 x^4 + 64 x^3 + 63 x^2 + 58 x + 100, [x], Dom::IntegerMod(101))
poly(x^5 + 67 x^4 + 72 x^3 + 100 x^2 + 33 x + 94, [x], Dom::IntegerMod(101))

```

If we multiply the factored object with an element that can be converted into an element of the ring of factorization, then we get a new factored object, which then is of the factorization type "unknown":

```
x*f
```

```

poly(x^2 + 73 x + 29, [x], Dom::IntegerMod(101))
poly(x^5 + 62 x^4 + 64 x^3 + 63 x^2 + 58 x + 100, [x], Dom::IntegerMod(101))
poly(x^5 + 67 x^4 + 72 x^3 + 100 x^2 + 33 x + 94, [x], Dom::IntegerMod(101)) x

```

```
Factored::getType(%)
```

```
"unknown"
```

You may use the function `expand` which returns the factored object in expanded form as an element of the factorization ring:

```
expand(f)
```

```
poly(x^12 + x + 1, [x], Dom::IntegerMod(101))
```

## Example 4

The third system function which return elements of `Factored` is `polylib::sqrffree`, which computes the square-free factorization of polynomials. For example:

```
f := polylib::sqrffree(x^2 + 2*x + 1)
```

$$(x + 1)^2$$

The factorization type, of course, is "squarefree":

```
Factored::getType(f)
```

```
"squarefree"
```

## Parameters

### **list**

A list of odd length

### **f**

An arithmetical expression

### **type**

A string on page 7-53 (default: "unknown")

### **ring**

A domain of category `Cat::IntegralDomain` (default: `Dom::ExpressionField()`)

## Function Calls

Calling a factored object as a function yields the object itself, regardless of the arguments. The arguments are *not* evaluated.

## Operations

You can apply (almost) every function to factored objects, functions that mainly expect arithmetical expressions as their input.



For example, one may add or multiply those objects, or apply functions such as `expand` and `diff` to them. But the result of such an operation then is usually not any longer of the domain `Factored`, as the factored form could be lost due to the operation (see examples below).

Call `expr(f)` to convert the factored object `f` into an arithmetical expression (as an element of a kernel domain).

The call `coerce(f, DOM_LIST)` returns a list of operands of the factored object `f` (see method `"convert_to"` below).

## Operands

An element  $f$  of `Factored` consists of the  $r + 1$  operands  $u, f_1, e_1, f_2, e_2, \dots, f_r, e_r$ , such that  $f = u f_1^{e_1} f_2^{e_2} \dots f_r^{e_r}$ .

The first operand  $u$  and the factors  $f_i$  are elements of the domain `ring`. The exponents  $e_i$  are integers on page 7-31.

## Methods

### Mathematical Methods

#### `_mult` — Multiply factored objects

`_mult(f, g, ...)`

Suppose that `g` is an element of the domain `ring` (or can be converted into such an element).

If `g` is a unit of `ring` or a factor of `f`, then the result is a factored object of the same factorization type as `f`. Otherwise, the result is an element of `Factored` with the factorization type `"unknown"`.

If both `f` and `g` are factored objects with factorization type `"irreducible"`, then the result is again a factored object of this type, i.e., the result is still in factored form.

Otherwise, the factored form of  $f$  is lost, and the result of this method is an element of `ring`.

This method overloads the function `_mult` for factored objects, i.e., one may use it in the form `f*g*...`, or in functional notation: `_mult(f, g, ...)`.

### **`_power` — Raise a factored object to a certain power**

`_power(f, n)`

If  $n$  is a positive integer and  $f$  a factored object with factorization type `"irreducible"` or `"squarefree"`, then the result is still a factored object of this type.

Otherwise, the factored form of  $f$  is lost, and the result of this method is an element of `ring`.

This method overloads the function `_power` for factored objects, i.e., one may use it in the form `f^n`, or in functional notation: `_power(f, n)`.

### **`expand` — Expand a factored object**

`expand(f)`

### **`exponents` — Get the exponents of a factored object**

`exponents(f)`

### **`factor` — Factor a factored object**

`factor(f)`

If  $f$  already is of the factorization type `"irreducible"`, then this method just return  $f$ .

Otherwise, this method converts  $f$  into an element of the domain `ring` and calls the method `"factor"` of `ring`.

This method returns a factored object of the domain `Factored` with factorization type `"irreducible"`, if the factorization of  $f$  can be computed (otherwise, `FAIL` is returned).

This method overloads the function `factor` for factored objects, i.e., one may use it in the form `factor(f)`.

**factors — Get the factors of a factored object**`factors(f)`**irreducible — Test if a factored object is irreducible**`irreducible(f)`

The test on irreducible is trivial, if `f` has the factorization type "irreducible".

Otherwise, this method converts `f` into an element of `ring` and calls the method "irreducible" of `ring`. The value `FAIL` is returned, if the domain `ring` cannot test if `f` is irreducible.

**iszero — Test on zero for factored objects**`iszero(f)`

This method overloads the function `iszero` for factored objects, i.e., one may use it in the form `iszero(f)`.

**sqrfree — Compute a square-free factorization of a factored object**`sqrfree(f)`

If `f` already is of the factorization type "squarefree", then this method just return `f`.

Otherwise, this method converts `f` into an element of the domain `ring` and calls the method "squarefree" of `ring`.

This method returns a factored object of the domain `Factored` with factorization type "squarefree", if the square-free factorization of `f` can be computed (otherwise, `FAIL` is returned).

This method overloads the function `polylib::sqrfree` for factored objects, i.e., one may use it in the form `polylib::sqrfree(f)`.

## Access Methods

**\_index — Extract a term of a factored object**`_index(f, i)`

Responds with an error message, if *i* is greater than the number of terms of *f*.

This method overloads the index operator [ ] for factored objects, i.e., one may use it in the form *f*[*i*].

**getRing — Get the ring of factorization**

getRing(*f*)

**getType — Get the type of factorization**

getType(*f*)

**has — Existence of an object in a factored object**

has(*f*, *x*, ...)

This method overloads the function *has* for factored objects, i.e., one may use it in the form *has*(*f*, *x*, ...).

**map — Map a function to the operands of factored objects**

map(*f*, *func*, ...)

See the system function *map* for details.

This method overloads the function *map* for factored objects, i.e., one may use it in the form *map*(*f*, *func*, ...).

**nops — Number of operands of a factored object**

nops(*f*)

This method overloads the function *nops* for factored objects, i.e., one may use it in the form *nops*(*f*).

**op — Extract an operand of a factored object**

op(*f*, *i*)

Returns FAIL, if *i* is greater than the number of operands of *f*.

This method overloads the function *op* for factored objects, i.e., one may use it in the form *op*(*f*, *i*).

**select — Select operands of a factored object**

```
select(f, func, ...)
```

This method overloads the function `select` for factored objects, i.e., one may use it in the form `select(f, func, ...)`.

**set\_index — Set/change a term of a factored object**

```
set_index(f, i, x)
```

Responds with an error message, if `i` is greater than the number of terms of `f`.

---

**Note** Make sure that `x` either is an element of the domain `ring`, or an integer.

---

This method overloads the index operator `[ ]` for factored objects, i.e., one may use it in the form `f[i] := x`.

**setRing — Set the ring of factorization**

```
setRing(f, ring)
```

---

**Note** Use this method with caution! Make sure that the factorization of `f` is still valid over the new ring, and that the operands of `f` have the correct domain type.

`ring` must be a domain of category `Cat::IntegralDomain`, which is not checked by this method.

---

**setType — Set the type of factorization**

```
setType(f, type)
```

---

**Note** Use this method with caution! Make sure that the factorization type corresponds with the factorization of `f`.

---

**subs — Substitute subexpressions in the operands of a factored object**

```
subs(f, x = a, ...)
```

This method overloads the function `subs` for factored objects, i.e., one may use it in the form `subs(f, x = a, ...)`.

**subsop — Substitute operands of a factored object**

`subsop(f, i = a, ...)`

This method overloads the function `subsop` for factored objects, i.e., one may use it in the form `subsop(f, i = a, ...)`.

**type — Expression type of factored objects**

`type(f)`

## Conversion Methods

**convert — Convert an object into a factored object**

`convert(x)`

If the conversion fails, then `FAIL` is returned.

`x` may either be a list of the form `[u, f1, e1, ..., fr, er]` of odd length (where `u`, `f1`, ..., `fr` are of the domain type `ring`, or can be converted into such elements, and `e1`, ..., `er` are integers), or an element that can be converted into the domain `ring`. The latter case corresponds to the list `[ring::one, x, 1]`.

**convert\_to — Convert factored objects into other domains**

`convert_to(f, T)`

If the conversion fails, then `FAIL` is returned.

If `T` is the domain `DOM_LIST`, then the list of operands of `f` is returned.

If `T` is the domain `DOM_EXPR`, then the unevaluated expression `u*f1^e1*f2^e2*...*fr^er` is returned, where `u`, `f1`, `e1`, ... are the operands of `f`.

Otherwise, the method "`convert`" of the domain `T` is called to convert `f` into an element of the domain `T` (which could return `FAIL`).

Use the function `expr` to convert `f` into an object of a kernel domain (see below).

### **create — Create simple and fast a factored objects**

```
create(list)
```

```
create(x)
```

This method creates a new factored object with the operands `ring::one`, `x`, `1`.

### **expr — Convert a factored object into a kernel domain**

```
expr(f)
```

---

**Note** Note that the factored form of `f` may be lost due to this conversion.

---

### **expr2text — Convert a factored object into a string**

```
expr2text(f)
```

### **testtype — Type testing for factored objects**

```
testtype(f, T)
```

This method is called from the system function `testtype`.

## **Technical Methods**

### **\_concat — Concatenate operands of factored objects**

```
_concat(f, g)
```

`f` and `g` must have the same factorization type and factorization ring, otherwise an error message is given.

### **maprec — Allow recursive mapping for factored objects**

```
maprec(f, x, ...)
```

First `f` is converted into the unevaluated expression  $u*f1^e1*f2^e2*\dots*fr^er$ , where `u`, `f1`, `e1`, ... are the operands of `f`. Then the function `misc::maprec` is called with this expression as its first parameter.

Note that the result of this method is not longer an object of `Factored!`

**print — Pretty-print routine for factored objects**

```
print(f)
```

**unapply — Create a procedure from a factored object**

```
unapply(f, <x>)
```

This method overloads the function `fp::unapply` for factored objects, i.e., one may use it in the form `fp::unapply(f)`. See `fp::unapply` for details.



# Series::Puisseux

Truncated Puiseux series expansions

## Syntax

```
Series::Puisseux(f, x, <order>, <dir>)
```

```
Series::Puisseux(f, x = x0, <order>, <dir>)
```

## Description

`Series::Puisseux` is a domain for truncated series expansions. Elements of this domain represent initial segments of Taylor, Laurent, or Puiseux series expansions, as well as slightly more general types of series expansions.

The system function `series` is the main application of this domain. It tries to compute a Taylor, Laurent, or Puiseux series or a more general series expansion of a given arithmetical expression, and the result is returned as an element of `Series::Puisseux` or, possibly, of the more general domain `Series::gseries`.

There is usually no need for you to explicitly create elements of this domain. The methods described on this help page apply if you want to process a result returned by `series` further.

---

**Note** If you create elements explicitly as described above, then any special mathematical function, such as `sin` or `exp`, involving the series variable is considered as a coefficient. Use `series` to expand such functions as well, and use the constructor only if `f` does not contain any special mathematical functions. Cf. "Example 1" on page 7-422 (Symbolic Math Toolbox).

---

Use the type specifier `Type::Series` to determine for an element of this domain, which kind of series expansion it is.

---

**Note** The coefficients are allowed to depend sublinearly on the variable of the series expansion. For example, logarithmic terms in the series variable may appear as

coefficients. Be aware that this is no Puiseux series in the mathematical sense. Cf. "Example 4" on page 7-430 (Symbolic Math Toolbox) and the help page for `series`.

---

## Environment Interactions

The function is sensitive to the global variable `ORDER`, which determines the default number of terms of the expansion.

## Examples

### Example 1

You can create objects of `Series::Puiseux` in various ways. The standard method is to use the constructor. The second argument specifies the series variable and the expansion point, with default 0 if omitted:

```
Series::Puiseux(x/(1 - x), x);  
Series::Puiseux(x/(1 - x), x = 2);  
Series::Puiseux(x/(1 - x), x = complexInfinity);
```

$$x + x^2 + x^3 + x^4 + x^5 + x^6 + O(x^7)$$

$$-2 + x - 2 - (x-2)^2 + (x-2)^3 - (x-2)^4 + (x-2)^5 + O((x-2)^6)$$

$$-1 - \frac{1}{x} - \frac{1}{x^2} - \frac{1}{x^3} - \frac{1}{x^4} - \frac{1}{x^5} + O\left(\frac{1}{x^6}\right)$$

The third argument, if present, specifies the desired number of terms. If it is omitted, the value of the environment variable `ORDER` is used:

```
Series::Puiseux(x/(1 - x), x = 2, 4);  
ORDER := 2;  
Series::Puiseux(x/(1 - x), x);  
delete ORDER;
```

$$-2 + x - 2 - (x-2)^2 + (x-2)^3 + O((x-2)^4)$$

$$x + x^2 + O(x^3)$$

The methods `const`, `one`, and `zero` provide shortcuts for creating series expansions with only a constant term or no non-zero term at all. Specifying the order of the error term is mandatory:

```
Series::Puisseux::const(PI, x, 4);
Series::Puisseux::one(x = 2, 3);
Series::Puisseux::zero(x = 0, 3/2);
Series::Puisseux::zero(x = complexInfinity, 5);
```

$$\pi + O(x^4)$$

$$1 + O((x-2)^3)$$

$$O(x^{3/2})$$

$$O\left(\frac{1}{x^5}\right)$$

Note that, e.g., `O(x^(3/2))` is not an element of `Series::Puisseux`, but can be converted by the constructor:

```
f := O(x^(3/2));
g := Series::Puisseux(f, x);
domtype(f), domtype(g)
```

$$O(x^{3/2})$$

$$O(x^{3/2})$$

### $O$ , Series::Puisseux

Both the constructor Series::Puisseux and the method const regard special mathematical functions, such as exp or sin, as coefficients:

```
Series::Puisseux(sin(x)/(1 - x), x, 4);
Series::Puisseux::const(cos(x), x = 1, 3);
```

$$\sin(x) + x \sin(x) + x^2 \sin(x) + x^3 \sin(x) + O(x^4)$$

$$\cos(x) + O((x-1)^3)$$

Use the system function series if you want to have special functions expanded as well:

```
series(sin(x)/(1 - x), x, 4);
```

$$x + x^2 + \frac{5x^3}{6} + \frac{5x^4}{6} + O(x^5)$$

The constructor returns FAIL, if it cannot convert the input into an element of Series::Puisseux. Then series may be able to produce a more general expansion:

```
delete a:
Series::Puisseux(x^a/(1 - x), x);
f := series(x^a/(1 - x), x);
domtype(f);
```

FAIL

$$x^a + x x^a + x^a x^2 + x^a x^3 + x^a x^4 + x^a x^5 + O(x^a x^6)$$

Series::gseries

The method `create` is a purely syntactical constructor, where the operands are specified explicitly. The sixth and seventh arguments are optional and default to 0 and `Undirected`, respectively:

```
Series::Puisseux::create(3, 1, 5, [1/2, 5], x) =
Series::Puisseux::create(3, 1, 5, [1/2, 5], x, 0, Undirected)
```

$$\frac{x^{1/3}}{2} + 5 x^{2/3} + O\left(x^{5/3}\right) = \frac{x^{1/3}}{2} + 5 x^{2/3} + O\left(x^{5/3}\right)$$

```
Series::Puisseux::create(1, -2, 1, [ln(x), 0, 3], x, complexInfinity);
```

$$x^2 \ln(x) + 3 + O\left(\frac{1}{x}\right)$$

## Example 2

We demonstrate the internal structure of objects of type `Series::Puisseux`:

```
f := series(exp(x), x = 1);
g := series(sin(sqrt(1/x)), x = infinity);
h := series(sin(sqrt(-x))/x, x = 0)
```

$$e + e(x-1) + \frac{e(x-1)^2}{2} + \frac{e(x-1)^3}{6} + \frac{e(x-1)^4}{24} + \frac{e(x-1)^5}{120} + O((x-1)^6)$$

$$\frac{1}{\sqrt{x}} - \frac{1}{6 x^{3/2}} + \frac{1}{120 x^{5/2}} + O\left(\frac{1}{x^{7/2}}\right)$$

$$-\frac{1}{\sqrt{-x}} + \frac{\sqrt{-x}}{6} - \frac{(-x)^{3/2}}{120} + O\left(x^{5/2}\right)$$

```
op(f);
op(g);
op(h)
```

$$0, 1, 0, 6, \left[ e, e, \frac{e}{2}, \frac{e}{6}, \frac{e}{24}, \frac{e}{120} \right], x = 1, \text{Undirected}$$

$$0, 2, 1, 7, \left[ 1, 0, -\frac{1}{6}, 0, \frac{1}{120} \right], x = \text{complexInfinity}, \text{Left}$$

$$1, 2, -1, 5, \left[ -\frac{1}{\sqrt{-x}}, 0, \frac{\sqrt{-x}}{6}, 0, -\frac{(-x)^{3/2}}{120} \right], x = 0, \text{Undirected}$$

The series f and g are of type 0, while h is of type 1:

$$\text{op}(f, 1), \text{op}(g, 1), \text{op}(h, 1)$$

$$0, 0, 1$$

The branching order of f is 1, and the branching order of both g and h is 2:

$$\text{op}(f, 2), \text{op}(g, 2), \text{op}(h, 2)$$

$$1, 2, 2$$

The third and the fourth operand determine the order of the leading term and the error term, respectively:

$$\begin{aligned} \text{ldegree}(f) &= \text{op}(f, 3)/\text{op}(f, 2), \\ \text{ldegree}(g) &= \text{op}(g, 3)/\text{op}(g, 2), \\ \text{ldegree}(h) &= \text{op}(h, 3)/\text{op}(h, 2); \\ \text{Series::Puiseux::order}(f) &= \text{op}(f, 4)/\text{op}(f, 2), \\ \text{Series::Puiseux::order}(g) &= \text{op}(g, 4)/\text{op}(g, 2), \\ \text{Series::Puiseux::order}(h) &= \text{op}(h, 4)/\text{op}(h, 2); \end{aligned}$$

$$0 = 0, \frac{1}{2} = \frac{1}{2}, -\frac{1}{2} = -\frac{1}{2}$$

$$6 = 6, \frac{7}{2} = \frac{7}{2}, \frac{5}{2} = \frac{5}{2}$$

For series expansions of type 0, the fifth operand contains the coefficients of the expansion:

```
op(f, 5) = [coeff(f)];
op(g, 5) = [coeff(g)];
```

$$\left[ e, e, \frac{e}{2}, \frac{e}{6}, \frac{e}{24}, \frac{e}{120} \right] = \left[ e, e, \frac{e}{2}, \frac{e}{6}, \frac{e}{24}, \frac{e}{120} \right]$$

$$\left[ 1, 0, -\frac{1}{6}, 0, \frac{1}{120} \right] = \left[ 1, 0, -\frac{1}{6}, 0, \frac{1}{120} \right]$$

However, h is an expansion of type 1, and then the fifth operand stores the summands:

```
op(h, 5);
[coeff(h)];
```

$$\left[ -\frac{1}{\sqrt{-x}}, 0, \frac{\sqrt{-x}}{6}, 0, -\frac{(-x)^{3/2}}{120} \right]$$

$$\left[ -\frac{\sqrt{x}}{\sqrt{-x}}, 0, \frac{\sqrt{-x}}{6\sqrt{x}}, 0, -\frac{(-x)^{3/2}}{120x^{3/2}} \right]$$

The sixth operand contains the series variable and the expansion point:

```
op(f, 6), Series::Puisseux::indet(f), Series::Puisseux::point(f);
op(g, 6), Series::Puisseux::indet(g), Series::Puisseux::point(g);
op(h, 6), Series::Puisseux::indet(h), Series::Puisseux::point(h);
```

$$x = 1, x, 1$$

$$x = \text{complexInfinity}, x, \text{complexInfinity}$$

$$x = 0, x, 0$$

The expansions  $f$  and  $h$  are undirected, while  $g$  is a directed expansion from the left along the real line to the positive infinity:

```
op(f, 7) = Series::Puiseux::direction(f),
op(g, 7) = Series::Puiseux::direction(g),
op(h, 7) = Series::Puiseux::direction(h);
```

Undirected = Undirected, Left = Left, Undirected = Undirected

---

**Note** Since the internal structure may be subject to changes, accessing the operands of and element of `Series::Puiseux` via `op` should be avoided. Use the corresponding access methods instead.

---

### Example 3

Around branch points, the series expansions of type 1 can approximate a function in a wider range than those of type 0:

```
f := x -> arcsin(x + 1):
g := series(f(x), x, 2);
h := series(f(x), x, 2, Right);
```

$$\frac{\pi}{2} - \sqrt{2} \sqrt{-x} - \frac{\sqrt{2} (-x)^{3/2}}{12} + O(x^{5/2})$$

$$\frac{\pi}{2} - \sqrt{2} \sqrt{x} i + \frac{\sqrt{2} x^{3/2} i}{12} + O(x^{5/2})$$

The expansion  $g$ , of type 1, approximates  $f$  well in an open disc centered at the origin. However, the expansion  $h$ , of type 0, was requested for positive real values of  $x$  only, and in fact it does not approximate  $f$  on the negative real axis and in the upper half plane:

```
op(g);
op(h);
```



$$1, 2, 0, 5, \left[ \frac{\pi}{2}, -\sqrt{2} \sqrt{-x}, 0, -\frac{\sqrt{2} (-x)^{3/2}}{12} \right], x = 0, \text{Undirected}$$

$$0, 2, 0, 5, \left[ \frac{\pi}{2}, -\sqrt{2} i, 0, \frac{\sqrt{2} i}{12} \right], x = 0, \text{Right}$$

```
DIGITS := 4:
[f(0.01), f(0.01*I), f(-0.01), f(-0.01*I)];
map([g(0.01), g(0.01*I), g(-0.01), g(-0.01*I)], float);
map([h(0.01), h(0.01*I), h(-0.01), h(-0.01*I)], float);
delete DIGITS:
```

$$[1.571 - 0.1413 i, 1.471 + 0.1001 i, 1.429, 1.471 - 0.1001 i]$$

$$[1.571 - 0.1413 i, 1.471 + 0.1001 i, 1.429, 1.471 - 0.1001 i]$$

$$[1.571 - 0.1413 i, 1.671 - 0.1001 i, 1.712, 1.471 - 0.1001 i]$$

The method `convert01` converts a series expansion of type 0 into one of type 1:

```
h1 := Series::Puisseux::convert01(h);
op(h1);
```

$$\frac{\pi}{2} - \sqrt{2} \sqrt{x} i + \frac{\sqrt{2} x^{3/2} i}{12} + O(x^{5/2})$$

$$1, 2, 0, 5, \left[ \frac{\pi}{2}, -\sqrt{2} \sqrt{x} i, 0, \frac{\sqrt{2} x^{3/2} i}{12} \right], x = 0, \text{Right}$$

The reverse conversion, using the method `convert10`, is in not always possible:

```
op(Series::Puisseux::convert10(h1));
op(Series::Puisseux::convert10(g));
```

$$0, 2, 0, 5, \left[ \frac{\pi}{2}, -\sqrt{2}i, 0, \frac{\sqrt{2}i}{12} \right], x=0, \text{Right}$$

$$1, 2, 0, 5, \left[ \frac{\pi}{2}, -\sqrt{2}\sqrt{-x}, 0, -\frac{\sqrt{2}(-x)^{3/2}}{12} \right], x=0, \text{Undirected}$$

You can enforce a conversion by using properties:

```
assume(x > 0):
op(Series::Puisseux::convert10(g));
unassume(x):
```

$$0, 2, 0, 5, \left[ \frac{\pi}{2}, -\sqrt{2}i, 0, \frac{\sqrt{2}i}{12} \right], x=0, \text{Undirected}$$

## Example 4

Despite the name, elements of `Series::Puisseux` may contain coefficient functions depending on the series variable:

```
f := series(psi(x), x = infinity, 4);
domtype(f), coeff(f, 0)
```

$$\ln(x) - \frac{1}{2x} - \frac{1}{12x^2} + O\left(\frac{1}{x^4}\right)$$

`Series::Puisseux, ln(x)`

With respect to differentiation, integration, and composition, such expansions behave like functions of the series variable and not like formal series:

```
diff(f, x) = series(diff(psi(x), x), x = infinity, 4)
```

$$\frac{1}{x} + \frac{1}{2x^2} + \frac{1}{6x^3} + O\left(\frac{1}{x^5}\right) = \frac{1}{x} + \frac{1}{2x^2} + \frac{1}{6x^3} + O\left(\frac{1}{x^5}\right)$$

```
int(f, x) = series(int(psi(x), x), x = infinity, 4)
```

$$x(\ln(x) - 1) - \frac{\ln(x)}{2} + \frac{1}{12x} + O\left(\frac{1}{x^3}\right) = x(\ln(x) - 1) + \frac{\ln(2)}{2} + \frac{\ln(\pi)}{2} - \frac{\ln(x)}{2} + \frac{1}{12x} + O\left(\frac{1}{x^3}\right)$$

```
f @ series(2*x, x = infinity) = series(psi(2*x), x = infinity, 4)
```

$$\ln(2) + \ln(x) - \frac{1}{4x} - \frac{1}{48x^2} + O\left(\frac{1}{x^4}\right) = \ln(2) + \ln(x) - \frac{1}{4x} - \frac{1}{48x^2} + O\left(\frac{1}{x^4}\right)$$

## Example 5

The basic arithmetical operations are implemented for elements of Series::Puisseux:

```
f := series(exp(x), x, 4);
g := series(sqrt(x)/(1 - x), x, 4);
h := series(cot(x), x, 4);
```

$$1 + x + \frac{x^2}{2} + \frac{x^3}{6} + O(x^4)$$

$$\sqrt{x} + x^{3/2} + x^{5/2} + x^{7/2} + O(x^{9/2})$$

$$\frac{1}{x} - \frac{x}{3} + O(x^3)$$

```
f + g + h;
_plus(f, g, h)
```

$$\frac{1}{x} + 1 + \sqrt{x} + \frac{2x}{3} + x^{3/2} + \frac{x^2}{2} + x^{5/2} + O(x^3)$$

$$\frac{1}{x} + 1 + \sqrt{x} + \frac{2x}{3} + x^{3/2} + \frac{x^2}{2} + x^{5/2} + O(x^3)$$

```
f - h = _subtract(f, h);
-g = _negate(g);
```

$$-\frac{1}{x} + 1 + \frac{4x}{3} + \frac{x^2}{2} + O(x^3) = -\frac{1}{x} + 1 + \frac{4x}{3} + \frac{x^2}{2} + O(x^3)$$

$$-\sqrt{x} - x^{3/2} - x^{5/2} - x^{7/2} + O(x^{9/2}) = -\sqrt{x} - x^{3/2} - x^{5/2} - x^{7/2} + O(x^{9/2})$$

```
f*g*h;
_mult(f, g, h)
```

$$\frac{1}{\sqrt{x}} + 2\sqrt{x} + \frac{13x^{3/2}}{6} + 2x^{5/2} + O(x^{7/2})$$

$$\frac{1}{\sqrt{x}} + 2\sqrt{x} + \frac{13x^{3/2}}{6} + 2x^{5/2} + O(x^{7/2})$$

```
f/g = _divide(f, g);
1/h = _invert(h);
```

$$\frac{1}{\sqrt{x}} - \frac{x^{3/2}}{2} - \frac{x^{5/2}}{3} + O(x^{7/2}) = \frac{1}{\sqrt{x}} - \frac{x^{3/2}}{2} - \frac{x^{5/2}}{3} + O(x^{7/2})$$

$$x + \frac{x^3}{3} + O(x^5) = x + \frac{x^3}{3} + O(x^5)$$

Operands that are not of type `Series::Puiseux` are implicitly converted into series expansions with the same expansion point via the constructor before the arithmetical operation is performed:

```
f - 1 - x;
h * (sin(x) + x);
```

$$\frac{x^2}{2} + \frac{x^3}{6} + O(x^4)$$

$$\frac{\sin(x)}{x} + 1 - \frac{x \sin(x)}{3} - \frac{x^2}{3} + O(x^3)$$

An error occurs when the expansion points differ or the directions of expansion are incompatible:

```
f := series(arccot(x), x = 0, Left);
g := series(sqrt(sin(x)), x = 0, Right);
f + g
```

$$-\frac{\pi}{2} - x + \frac{x^3}{3} - \frac{x^5}{5} + O(x^7)$$

$$\sqrt{x} - \frac{x^{5/2}}{12} + \frac{x^{9/2}}{1440} + O(x^{13/2})$$

Error: Inconsistent direction. [Series::Puisseux::plus]

```
h := series(1/x, x = 2, 4);
f * h
```

$$\frac{1}{2} - \frac{x-2}{4} + \frac{(x-2)^2}{8} - \frac{(x-2)^3}{16} + O((x-2)^4)$$

Error: Both series must use the same variables and expansion points. [Series::Puisseux::

If the directions are compatible, then the direction of the result specifies the minimal range where all operands are defined:

```
s := series(tanh(x), x, Real);
```

$$x - \frac{x^3}{3} + \frac{2x^5}{15} + O(x^7)$$

```
f + s;
Series::Puisseux::direction(%)
```

$$-\frac{\pi}{2} - \frac{x^5}{15} + O(x^7)$$

Left

### Example 6

The method `scalmult` implements multiplication by a constant or a single term:

```
f := series(1 + 2*x^3, x);
Series::Puisseux::scalmult(f, 5) = 5*f;
Series::Puisseux::scalmult(f, 5, 3) = 5*x^3*f;
```

$$1 + 2x^3 + O(x^6)$$

$$5 + 10x^3 + O(x^6) = 5 + 10x^3 + O(x^6)$$

$$5x^3 + 10x^6 + O(x^9) = 5x^3 + 10x^6 + O(x^9)$$

```
g := series(1 + 2*x^3, x = 2, 3);
Series::Puisseux::scalmult(g, 1, 3) = (x - 2)^3*g
```

$$17 + 24(x-2) + 12(x-2)^2 + O((x-2)^3)$$

$$17(x-2)^3 + 24(x-2)^4 + 12(x-2)^5 + O((x-2)^6) =$$

$$17(x-2)^3 + 24(x-2)^4 + 12(x-2)^5 + O((x-2)^6)$$

```
h := series(1 + 2*x^3, x = complexInfinity);
Series::Puisseux::scalmult(h, 1, 1/2) = x^(-1/2)*h
```

$$2x^3 + 1 + O\left(\frac{1}{x^3}\right)$$

$$2x^{5/2} + \frac{1}{\sqrt{x}} + O\left(\frac{1}{x^{7/2}}\right) = 2x^{5/2} + \frac{1}{\sqrt{x}} + O\left(\frac{1}{x^{7/2}}\right)$$

### Example 7

Exponentiation is implemented for integral and rational exponents:

```
f := series(exp(x), x, 3);
f^2 = _power(f, 2);
f^(1/3) = _power(f, 1/3)
```

$$1 + x + \frac{x^2}{2} + O(x^3)$$

$$1 + 2x + 2x^2 + O(x^3) = 1 + 2x + 2x^2 + O(x^3)$$

$$1 + \frac{x}{3} + \frac{x^2}{18} + O(x^3) = 1 + \frac{x}{3} + \frac{x^2}{18} + O(x^3)$$

Exponents are allowed to be non-rational, if the series expansion starts with a constant summand independent of the series variable:

```
f^I = series(exp(I*x), x, 3);
```

$$1 + xi - \frac{x^2}{2} + O(x^3) = 1 + xi - \frac{x^2}{2} + O(x^3)$$

```
g := series(sin(-x), x);
g^I
```

$$-x + \frac{x^3}{6} - \frac{x^5}{120} + O(x^7)$$

Error: Exponent must be a rational number. [Series::Puisseux::\_power]

If the exponent contains the series variable, then an error occurs:

```
f^x
```

Error: Exponent must not contain the series variable. [Series::Puisseux::\_power]

For undirected expansions and rational exponents that are not integral, the result has type 1 in general:

```
g^(1/2);
op(%, 1);
```

$$\sqrt{-x} - \frac{(-x)^{5/2}}{12} + \frac{(-x)^{9/2}}{1440} + O(x^{13/2})$$

1

The result simplifies when you specify one of the directions Left or Right:

```
g := series(sin(-x), x, Left);
g^(1/2);
op(%, 1);
```

$$-\sqrt{x} i + \frac{x^{5/2} i}{12} - \frac{x^{9/2} i}{1440} + O(x^{13/2})$$

0

```
g := series(sin(-x), x, Right);
g^(1/2);
```



$$\sqrt{x} i - \frac{x^{5/2} i}{12} + \frac{x^{9/2} i}{1440} + O(x^{13/2})$$

## Example 8

Functional composition of elements of `Series::Puisseux` is implemented by the method `_fconcat`:

```
f := series(ln(x), x = 1, 4);
g := series(cos(y), y = 0);
f@g = _fconcat(f, g);
series(ln(cos(y)), y = 0, 4);
```

$$x - 1 - \frac{(x-1)^2}{2} + \frac{(x-1)^3}{3} - \frac{(x-1)^4}{4} + O((x-1)^5)$$

$$1 - \frac{y^2}{2} + \frac{y^4}{24} + O(y^6)$$

$$-\frac{y^2}{2} - \frac{y^4}{12} + O(y^6) = -\frac{y^2}{2} - \frac{y^4}{12} + O(y^6)$$

$$-\frac{y^2}{2} - \frac{y^4}{12} + O(y^6)$$

If the left argument is not of type `Series::Puisseux`, it is implicitly expanded around the limit point of the right argument before the composition:

```
f := series(sin(-x), x = 0);
sqrt(y) @ f = Series::Puisseux(sqrt(y), y) @ f;
```

$$-x + \frac{x^3}{6} - \frac{x^5}{120} + O(x^7)$$

$$\sqrt{-x} - \frac{(-x)^{5/2}}{12} + \frac{(-x)^{9/2}}{1440} + O(x^{13/2}) = \sqrt{-x} - \frac{(-x)^{5/2}}{12} + \frac{(-x)^{9/2}}{1440} + O(x^{13/2})$$

If the right argument is not of type `Series::Puisseux`, it is implicitly expanded around the origin via the constructor before the composition:

```
f @ sqrt(y) = f @ Series::Puisseux(sqrt(y), y)
```

$$-\sqrt{y} + \frac{y^{3/2}}{6} - \frac{y^{5/2}}{120} + O(y^{7/2}) = -\sqrt{y} + \frac{y^{3/2}}{6} - \frac{y^{5/2}}{120} + O(y^{7/2})$$

This may not work if the argument to be converted contains special mathematical functions, but you can explicitly expand it into a series via `series` in this case:

```
f @ tan(y)
```

FAIL

```
f @ series(tan(y), y = 0)
```

$$-y - \frac{y^3}{6} + \frac{y^5}{40} + O(y^7)$$

Mathematically, the composition of series expansions is not defined if the limit point of the right argument is not the expansion point of the left argument:

```
g := series(y^2 - 1, y = 0);
f @ g
```

$$-1 + y^2 + O(y^6)$$

FAIL

```
f @ (y^2 - 1)
```

FAIL

```
f @ series(y^2 - 1, y = 1, 4)
```

$$-2(y-1) - (y-1)^2 + \frac{4(y-1)^3}{3} + 2(y-1)^4 + O((y-1)^5)$$

The method `revert` computes the inverse of a truncated series expansion with respect to composition. The expansion point of the inverse is the limit point of the input and vice versa:

```
f := series(ln(x), x = 1, 4);
revert(f) = series(exp(x), x = 0, 5)
```

$$x - 1 - \frac{(x-1)^2}{2} + \frac{(x-1)^3}{3} - \frac{(x-1)^4}{4} + O((x-1)^5)$$

$$1 + x + \frac{x^2}{2} + \frac{x^3}{6} + \frac{x^4}{24} + O(x^5) = 1 + x + \frac{x^2}{2} + \frac{x^3}{6} + \frac{x^4}{24} + O(x^5)$$

```
f := series(cot(x), x = 0);
revert(f) = series(arccot(x), x = complexInfinity);
```

$$\frac{1}{x} - \frac{x}{3} - \frac{x^3}{45} + O(x^5)$$

$$\frac{1}{x} - \frac{1}{3x^3} + \frac{1}{5x^5} + O\left(\frac{1}{x^7}\right) = \frac{1}{x} - \frac{1}{3x^3} + \frac{1}{5x^5} + O\left(\frac{1}{x^7}\right)$$

```
f @ revert(f), revert(f) @ f
```

$$x + O\left(\frac{1}{x^5}\right), x + O(x^7)$$

If the series variable occurs in the coefficients or the type flag is 1, an error occurs:

```
f := series(ln(sin(x)), x);
g := series(arcsin(x + 1), x, 2);
```

$$\ln(x) - \frac{x^2}{6} - \frac{x^4}{180} + O(x^6)$$

$$\frac{\pi}{2} - \sqrt{2} \sqrt{-x} - \frac{\sqrt{2} (-x)^{3/2}}{12} + O(x^{5/2})$$

revert(f)

Error: Unable to compute the functional inverse. [Series::Puisseux::revert]

revert(g)

Error: Unable to compute the functional inverse. [Series::Puisseux::revert]

## Example 9

The methods `diff` and `int` implement term-by-term differentiation and integration:

```
f := series(ln(x), x = 1, 4);
g := diff(f, x);
series(1/x, x = 1, 4);
int(g, x);
```

$$x - 1 - \frac{(x-1)^2}{2} + \frac{(x-1)^3}{3} - \frac{(x-1)^4}{4} + O((x-1)^5)$$

$$1 - (x-1) + (x-1)^2 - (x-1)^3 + O((x-1)^4)$$

$$1 - (x-1) + (x-1)^2 - (x-1)^3 + O((x-1)^4)$$

$$x - 1 - \frac{(x-1)^2}{2} + \frac{(x-1)^3}{3} - \frac{(x-1)^4}{4} + O((x-1)^5)$$

If you specify a range of integration, then the result is an arithmetical expression plus a symbolic definite integral of the  $O$ -term:

```
int(f, x = 1..2);
```

$$\int_1^2 O((x-1)^5, x=1) dx + \frac{11}{30}$$

## Example 10

Most special mathematical functions are overloaded for `Series::Puisseux`:

```
f := series(x/(1 - x), x, 4);
exp(f) = series(exp(x/(1 - x)), x, 4);
ln(f) = series(ln(x/(1 - x)), x, 4);
```

$$x + x^2 + x^3 + x^4 + O(x^5)$$

$$1 + x + \frac{3x^2}{2} + \frac{13x^3}{6} + O(x^4) = 1 + x + \frac{3x^2}{2} + \frac{13x^3}{6} + O(x^4)$$

$$\ln(x) + x + \frac{x^2}{2} + \frac{x^3}{3} + O(x^4) = \ln(x) + x + \frac{x^2}{2} + \frac{x^3}{3} + O(x^4)$$

If the system is unable to compute the composition, it returns a symbolic function call with evaluated arguments:

```
delete g;
g(f)
```

$$g(x + x^2 + x^3 + x^4 + O(x^5))$$

```
exp(series(x + 1/x, x = infinity, 5))
```

$$e^{x + \frac{1}{x} + O\left(\frac{1}{x^4}\right)}$$

In this case, you can try `series` to compute the composition:

```
series(exp(x + 1/x), x = infinity, 5)
```

$$e^x + \frac{e^x}{x} + \frac{e^x}{2x^2} + \frac{e^x}{6x^3} + \frac{e^x}{24x^4} + O\left(\frac{e^x}{x^5}\right)$$

### Example 11

The system functions `Re`, `Im`, and `conjugate` work for all real series expansions:

```
f := series(exp(I*x), x, Real);
Re(f) = series(cos(x), x, Real);
Im(f) = series(sin(x), x, Real) + 0(x^6);
conjugate(f) = series(exp(-I*x), x, Real);
```

$$1 + xi - \frac{x^2}{2} - \frac{x^3 i}{6} + \frac{x^4}{24} + \frac{x^5 i}{120} + O(x^6)$$

$$1 - \frac{x^2}{2} + \frac{x^4}{24} + O(x^6) = 1 - \frac{x^2}{2} + \frac{x^4}{24} + O(x^6)$$

$$x - \frac{x^3}{6} + \frac{x^5}{120} + O(x^6) = x - \frac{x^3}{6} + \frac{x^5}{120} + O(x^6)$$

$$1 - xi - \frac{x^2}{2} + \frac{x^3 i}{6} + \frac{x^4}{24} - \frac{x^5 i}{120} + O(x^6) = 1 - xi - \frac{x^2}{2} + \frac{x^3 i}{6} + \frac{x^4}{24} - \frac{x^5 i}{120} + O(x^6)$$

Except in trivial cases, a symbolic function call is returned for an undirected expansion:

```
Re(series(PI, x));
Re(series(exp(I*x), x));
```

$$\pi + O(x^6)$$

$$\Re\left(1 + xi - \frac{x^2}{2} - \frac{x^3 i}{6} + \frac{x^4}{24} + \frac{x^5 i}{120} + O(x^6)\right)$$

## Example 12

The method `contfrac` converts a series expansion into a continued fraction:

```
f := series(exp(x), x, 10);
contfrac(f);
```

$$1 + x + \frac{x^2}{2} + \frac{x^3}{6} + \frac{x^4}{24} + \frac{x^5}{120} + \frac{x^6}{720} + \frac{x^7}{5040} + \frac{x^8}{40320} + \frac{x^9}{362880} + O(x^{10})$$

$$1 + \frac{x}{1 + \frac{x}{-2 + \frac{x}{-3 + \frac{x}{2 + \frac{x}{5 + \frac{x}{-2 + \frac{x}{-7 + \frac{x}{2 + \frac{x}{9 + O(x)}}}}}}}}}}$$

```
g := series(tan(x), x = PI, 10);
contfrac(g);
```

$$x - \pi + \frac{(x - \pi)^3}{3} + \frac{2(x - \pi)^5}{15} + \frac{17(x - \pi)^7}{315} + \frac{62(x - \pi)^9}{2835} + O((x - \pi)^{11})$$

$$1 + \frac{x - \pi}{(x - \pi)^2} \div \left( -3 + \frac{(x - \pi)^2}{(x - \pi)^2} \right) \div \left( 5 + \frac{(x - \pi)^2}{(x - \pi)^2} \right) \div \left( -7 + \frac{(x - \pi)^2}{9 + O((x - \pi)^2)} \right)$$

If the coefficients of a series expansion depend on the series variable, then so do the coefficients of the corresponding continued fraction:

```
h := series(ln(x + 1/x), x = infinity);
contfrac(h)
```

$$\ln(x) + \frac{1}{x^2} - \frac{1}{2x^4} + O\left(\frac{1}{x^6}\right)$$

$$\ln(x) + \frac{x^{-2}}{1 + \frac{x^{-2}}{2 + O(x^{-2})}}$$

### Example 13

For series expansions around the origin, the method `laplace`, overloading `laplace`, computes the Laplace transform term by term, if the second argument is the series variable. The result is a series expansion around infinity:

```
delete s;
f := series(exp(x), x);
g := laplace(f, x, s);
series(laplace(exp(x), x, s), s = infinity);
```

$$1 + x + \frac{x^2}{2} + \frac{x^3}{6} + \frac{x^4}{24} + \frac{x^5}{120} + O(x^6)$$



$$\frac{1}{s} + \frac{1}{s^2} + \frac{1}{s^3} + \frac{1}{s^4} + \frac{1}{s^5} + \frac{1}{s^6} + O\left(\frac{1}{s^7}\right)$$

$$\frac{1}{s} + \frac{1}{s^2} + \frac{1}{s^3} + \frac{1}{s^4} + \frac{1}{s^5} + \frac{1}{s^6} + O\left(\frac{1}{s^7}\right)$$

Similarly, the method `ilaplace` computes the inverse Laplace transform term by term for series expansions around infinity, if the second argument is the series variable. The result is a series expansion around 0:

```
ilaplace(g, s, x)
```

$$1 + x + \frac{x^2}{2} + \frac{x^3}{6} + \frac{x^4}{24} + \frac{x^5}{120} + O(x^6)$$

The Laplace transform and the inverse Laplace transform, respectively, of a series do not make sense for expansion points other than 0 or infinity, respectively, and in these cases a symbolic function call is returned:

```
laplace(series(ln(x), x = 1, 2), x, s);
```

$$\text{laplace}\left(x - 1 - \frac{(x-1)^2}{2} + O((x-1)^3), x, s\right)$$

If the second argument is not the series variable, then the coefficients are transformed:

```
h := series(sin(x*y), x = 1, 2);
laplace(h, y, s);
```

$$\sin(y) + y \cos(y) (x-1) + O((x-1)^2)$$

$$\frac{1}{s^2+1} - \left( \frac{1}{s^2+1} - \frac{2s^2}{(s^2+1)^2} \right) (x-1) + O((x-1)^2)$$

**Example 14**

When called with one argument, the method `coeff` returns the sequence of all coefficients of a series expansion:

```
f := series(tan(x), x);
coeff(f)
```

$$x + \frac{x^3}{3} + \frac{2x^5}{15} + O(x^7)$$

$$1, 0, \frac{1}{3}, 0, \frac{2}{15}$$

```
g := series(1/(x - 1)^2, x = infinity);
coeff(g)
```

$$\frac{1}{x^2} + \frac{2}{x^3} + \frac{3}{x^4} + \frac{4}{x^5} + \frac{5}{x^6} + \frac{6}{x^7} + O\left(\frac{1}{x^8}\right)$$

$$1, 2, 3, 4, 5, 6$$

When called with two arguments, `coeff` returns an individual coefficient:

```
coeff(f, -1), coeff(f, 1), coeff(f, 2), coeff(f, 13/2);
```

$$0, 1, 0, 0$$

If the second argument exceeds the order of the error term, `coeff` returns FAIL:

```
coeff(f, 10)
```

FAIL

When the expansion point is `complexInfinity`, `coeff(s, n)` returns the coefficient of

$\frac{1}{x^n}$ , where  $x$  is the series variable of  $s$ :

```
coeff(g, 2), coeff(g, -3), coeff(g, -15/2)
```

```
0, 2, 0
```

Specifying the series variable as second or third argument, respectively, is optional:

```
coeff(f) = coeff(f, x);
coeff(f, 3) = coeff(f, x, 3)
```

$$\left(1, 0, \frac{1}{3}, 0, \frac{2}{15}\right) = \left(1, 0, \frac{1}{3}, 0, \frac{2}{15}\right)$$

$$\frac{1}{3} = \frac{1}{3}$$

For series expansions of type 1, the “coefficients” in general involve the series variable:

```
h := series(sin(sqrt(-x)), x);
coeff(h);
coeff(h, 3/2);
```

$$\sqrt{-x} - \frac{(-x)^{3/2}}{6} + \frac{(-x)^{5/2}}{120} + O(x^{7/2})$$

$$\frac{\sqrt{-x}}{\sqrt{x}}, 0, -\frac{(-x)^{3/2}}{6 x^{3/2}}, 0, \frac{(-x)^{5/2}}{120 x^{5/2}}$$

$$-\frac{(-x)^{3/2}}{6 x^{3/2}}$$

### Example 15

The method `ldegree` returns the order of the leading term of a series expansion. When the expansion point is `complexInfinity` and the leading term is  $\frac{1}{x^n}$ , then this is  $n$ :

```
f := series(x*sin(sqrt(-x)), x);
g := series(cot(x), x = PI);
h := series(2*arccot(x), x = infinity);
```

$$-(-x)^{3/2} + \frac{(-x)^{5/2}}{6} - \frac{(-x)^{7/2}}{120} + O(x^{9/2})$$

$$\frac{1}{x-\pi} - \frac{x-\pi}{3} - \frac{(x-\pi)^3}{45} + O((x-\pi)^5)$$

$$\frac{2}{x} - \frac{2}{3x^3} + \frac{2}{5x^5} + O\left(\frac{1}{x^7}\right)$$

```
ldegree(f), ldegree(g), ldegree(h)
```

$$\frac{3}{2}, -1, 1$$

The method `lcoeff` returns the coefficient of the leading term. For an expansion of type 1, it generally involves the series variable:

```
lcoeff(f), lcoeff(g), lcoeff(h)
```

$$-\frac{(-x)^{3/2}}{x^{3/2}}, 1, 2$$

The method `lterm` returns the leading term itself:

```
lterm(f), lterm(g), lterm(h)
```

$$x^{3/2}, \frac{1}{x-\pi}, \frac{1}{x}$$

Finally, the method `lmonomial` returns the whole summand:

```
lmonomial(f) = lcoeff(f)*lterm(f);
lmonomial(g) = lcoeff(g)*lterm(g);
lmonomial(h) = lcoeff(h)*lterm(h);
```

$$-(-x)^{3/2} = -(-x)^{3/2}$$

$$\frac{1}{x-\pi} = \frac{1}{x-\pi}$$

$$\frac{2}{x} = \frac{2}{x}$$

If the series expansion consists only of an  $O$ -term, all four methods return FAIL:

```
s := Series::Puisseux::zero(x, 6);
ldegree(s), lcoeff(s), lterm(s), lmonomial(s)
```

$$O(x^6)$$

FAIL, FAIL, FAIL, FAIL

## Example 16

The methods `nthcoeff`, `nthmonomial`, and `nthterm` return the  $n$ th non-zero coefficient, monomial, or term, respectively, of a series expansion. In contrast to polynomials, they count from the term of lowest order on, i.e., the ordering is ascending by exponent for finite expansion points and descending by exponent when the expansion point is `complexInfinity`:

```
f := series(x*sin(sqrt(-x)), x);
g := series(cot(x), x = PI);
h := series(2*arccot(x), x = infinity);
```

$$-(-x)^{3/2} + \frac{(-x)^{5/2}}{6} - \frac{(-x)^{7/2}}{120} + O(x^{9/2})$$

$$\frac{1}{x-\pi} - \frac{x-\pi}{3} - \frac{(x-\pi)^3}{45} + O((x-\pi)^5)$$

$$\frac{2}{x} - \frac{2}{3x^3} + \frac{2}{5x^5} + O\left(\frac{1}{x^7}\right)$$

`nthcoeff(f, 1) = lcoeff(f);`  
`nthmonomial(g, 1) = lmonomial(g);`  
`nthterm(h, 1) = lterm(h);`

$$-\frac{(-x)^{3/2}}{x^{3/2}} = -\frac{(-x)^{3/2}}{x^{3/2}}$$

$$\frac{1}{x-\pi} = \frac{1}{x-\pi}$$

$$\frac{1}{x} = \frac{1}{x}$$

`nthcoeff(f, 3), nthmonomial(f, 3), nthterm(f, 3);`  
`nthcoeff(g, 3), nthmonomial(g, 3), nthterm(g, 3);`  
`nthcoeff(h, 3), nthmonomial(h, 3), nthterm(h, 3);`

$$-\frac{(-x)^{7/2}}{120x^{7/2}}, -\frac{(-x)^{7/2}}{120}, x^{7/2}$$

$$-\frac{1}{45}, -\frac{(x-\pi)^3}{45}, (x-\pi)^3$$

$$\frac{2}{5}, \frac{2}{5x^5}, \frac{1}{x^5}$$

If the second argument is not positive or exceeds the number of non-zero summands, all three methods return FAIL:

```
nthcoeff(f, -4), nthterm(g, 0), nthmonomial(h, 4)
```

FAIL, FAIL, FAIL

### Example 17

We illustrate the difference between the ordering of terms in polynomials and series expansions. The ordering of the terms in a polynomial agrees with the ordering of the terms in a series expansion with expansion point `complexInfinity`:

```
f := poly(2*(x^2 + x)^3);
g := series(f, x = complexInfinity);
[lcoeff(f), lmonomial(f), lterm(f)];
[lcoeff(g), lmonomial(g), lterm(g)];
```

$$\text{poly}(2x^6 + 6x^5 + 6x^4 + 2x^3, [x])$$

$$2x^6 + 6x^5 + 6x^4 + 2x^3 + O(1)$$

$$[2, \text{poly}(2x^6, [x]), \text{poly}(x^6, [x])]$$

$$[2, 2x^6, x^6]$$

```
[nthcoeff(f, 2), nthmonomial(f, 3), nthterm(f, 4)];
[nthcoeff(g, 2), nthmonomial(g, 3), nthterm(g, 4)];
```

$$[6, \text{poly}(6x^4, [x]), \text{poly}(x^3, [x])]$$

$$[6, 6x^4, x^3]$$

For finite expansion points, however, the ordering of the terms in a series expansion is the reverse of the ordering of the terms in the corresponding polynomial:

```
h := series(f, x = 0);
[lcoeff(h), lmonomial(h), lterm(h)];
[nthcoeff(h, 2), nthmonomial(h, 3), nthterm(h, 4)];
```

$$2x^3 + 6x^4 + 6x^5 + 2x^6 + O(x^9)$$

$$[2, 2x^3, x^3]$$

$$[6, 6x^5, x^6]$$

### Example 18

The method `iszero` checks whether a series expansion has no non-zero summands apart from the  $O$ -term:

```
f := series(exp(x), x);
g := Series::Puisseux(0, x = 2, 4);
iszero(f), iszero(g)
```

$$1 + x + \frac{x^2}{2} + \frac{x^3}{6} + \frac{x^4}{24} + \frac{x^5}{120} + O(x^6)$$

$$O((x-2)^4)$$

FALSE, TRUE

### Example 19

The methods `convert` tries to convert an arbitrary object into an element of `Series::Puisseux`. If the input does not suggest an expansion point, `convert` uses the origin:



```
f := asympt(1/(x + 1), x = infinity);
g := sin(x)/(1 - x);
h := poly((x + 1)^10);
u := O((x - 1)^3, x = 1);
```

$$\frac{1}{x} - \frac{1}{x^2} + \frac{1}{x^3} - \frac{1}{x^4} + \frac{1}{x^5} - \frac{1}{x^6} + O\left(\frac{1}{x^7}\right)$$

$$- \frac{\sin(x)}{x - 1}$$

$$\text{poly}(x^{10} + 10x^9 + 45x^8 + 120x^7 + 210x^6 + 252x^5 + 210x^4 + 120x^3 + 45x^2 + 10x + 1, [x])$$

$$O((x - 1)^3, x = 1)$$

```
domtype(f), domtype(g), domtype(h), domtype(u)
```

Series::gseries, DOM\_EXPR, DOM\_POLY, O

```
F := Series::Puisseux::convert(f);
G := Series::Puisseux::convert(g);
H := Series::Puisseux::convert(h);
U := Series::Puisseux::convert(u);
```

$$\frac{1}{x} - \frac{1}{x^2} + \frac{1}{x^3} - \frac{1}{x^4} + \frac{1}{x^5} - \frac{1}{x^6} + O\left(\frac{1}{x^7}\right)$$

$$\sin(x) + x \sin(x) + x^2 \sin(x) + x^3 \sin(x) + x^4 \sin(x) + x^5 \sin(x) + O(x^6)$$

$$1 + 10x + 45x^2 + 120x^3 + 210x^4 + 252x^5 + 210x^6 + 120x^7 + 45x^8 + 10x^9 + x^{10} + O(x^{16})$$

$$O((x-1)^3)$$

convert returns FAIL, if it is unable to convert the input, e.g., because the input contains no or more than one indeterminate:

```
Series::Puisseux::convert(sin(1)),
Series::Puisseux::convert([1, y, 3])
```

FAIL, FAIL

The method convert\_to tries to convert an element of Series::Puisseux into a specified type:

```
Series::Puisseux::convert_to(F, Series::gseries);
Series::Puisseux::convert_to(F, contfrac);
Series::Puisseux::convert_to(G, DOM_EXPR);
Series::Puisseux::convert_to(H, DOM_POLY);
Series::Puisseux::convert_to(H, 0);
Series::Puisseux::convert_to(U, 0);
```

$$\frac{1}{x} - \frac{1}{x^2} + \frac{1}{x^3} - \frac{1}{x^4} + \frac{1}{x^5} - \frac{1}{x^6} + O\left(\frac{1}{x^7}\right)$$

$$\frac{x^{-1}}{1 + \frac{x^{-1}}{1 + O(x^{-5})}}$$

$$\sin(x) + x^2 \sin(x) + x^3 \sin(x) + x^4 \sin(x) + x^5 \sin(x) + x \sin(x)$$

$$\text{poly}(x^{10} + 10x^9 + 45x^8 + 120x^7 + 210x^6 + 252x^5 + 210x^4 + 120x^3 + 45x^2 + 10x + 1, [x])$$

$$O(1)$$

$$O((x-1)^3, x=1)$$

convert\_to returns FAIL, if it is unable to perform the requested conversion:

```
Series::Puisseux::convert_to(F, 0),
Series::Puisseux::convert_to(F, DOM_LIST)
```

FAIL, FAIL

## Example 20

The method `expr` converts an element of `Series::Puisseux` into an arithmetical expression, discarding the  $O$ -term. In general, the ordering of the summands is not preserved:

```
f := series(exp(x*y), x);
g := series(ln(x), x = 1, 3);
```

$$1 + x y + \frac{x^2 y^2}{2} + \frac{x^3 y^3}{6} + \frac{x^4 y^4}{24} + \frac{x^5 y^5}{120} + O(x^6)$$

$$x - 1 - \frac{(x-1)^2}{2} + \frac{(x-1)^3}{3} + O((x-1)^4)$$

```
expr(f);
expr(g);
```

$$\frac{x^5 y^5}{120} + \frac{x^4 y^4}{24} + \frac{x^3 y^3}{6} + \frac{x^2 y^2}{2} + x y + 1$$

$$x - \frac{(x-1)^2}{2} + \frac{(x-1)^3}{3} - 1$$

The method `float` applies the system function `float` to all coefficients:

```
float(f);
float(g);
```

$$1.0 + x y + 0.5 x^2 y^2 + 0.1666666667 x^3 y^3 + 0.04166666667 x^4 y^4 + 0.008333333333 x^5 y^5 + O(x^6)$$

$$1.0 (x-1) - 0.5 (x-1)^2 + 0.3333333333 (x-1)^3 + O((x-1)^4)$$

### Example 21

The methods `combine`, `expand`, and `normal` apply the corresponding system functions to all coefficients:

```
delete a, y;
f := series(y/(x + y^a), x, 4);
g := combine(f);
expand(g);
```

$$\frac{y}{y^a} - \frac{x y}{y^{2a}} + \frac{x^2 y}{y^{3a}} - \frac{x^3 y}{y^{4a}} + O(x^4)$$

$$y^{1-a} - x y^{1-2a} + x^2 y^{1-3a} - x^3 y^{1-4a} + O(x^4)$$

$$\frac{y}{y^a} - \frac{x y}{y^{2a}} + \frac{x^2 y}{y^{3a}} - \frac{x^3 y}{y^{4a}} + O(x^4)$$

For efficiency reasons, the arithmetical methods of `Series::Puisseux` usually do not perform any symbolic simplifications. Use `expand` or `normal` to simplify the results:

```
h := series(exp(x), x, 4)^a;
expand(h);
normal(h);
```

$$1 + a x + x^2 \left( \frac{a}{2} + \frac{a(a-1)}{2} \right) + x^3 \left( \frac{a}{6} + \frac{\left( \frac{a}{2} + \frac{a(a-1)}{2} \right) (a-2)}{3} + \frac{a(2a-1)}{6} \right) + O(x^4)$$

$$1 + a x + \frac{a^2 x^2}{2} + \frac{a^3 x^3}{6} + O(x^4)$$

$$1 + a x + \frac{a^2 x^2}{2} + \frac{a^3 x^3}{6} + O(x^4)$$

```
u := series(arctanh(x + y), x, 4);
normal(u);
```

$$\operatorname{arctanh}(y) - \frac{x i}{y^2 i - i} + \frac{x^2 y}{(y^2 - 1)^2} - \frac{x^3 (3 y^2 + 1)}{3 (y^2 - 1)^3} + O(x^4)$$

$$\operatorname{arctanh}(y) - \frac{x}{y^2 - 1} + \frac{x^2 y}{(y^2 - 1)^2} - \frac{x^3 (3 y^2 + 1)}{3 (y^2 - 1)^3} + O(x^4)$$

Besides normalizing the coefficients, the method `normal` also removes leading and trailing zeroes from the coefficient list:

```
v := Series::Puisseux::create(1, 3, 10,
                               [0, 1/2, 0, 5, 0, 0], x, 2);
coeff(v);
normal(v);
coeff(%);
```

$$\frac{(x-2)^4}{2} + 5 (x-2)^6 + O((x-2)^{10})$$

$$0, \frac{1}{2}, 0, 5, 0, 0$$

$$\frac{(x-2)^4}{2} + 5(x-2)^6 + O((x-2)^{10})$$

$$\frac{1}{2}, 0, 5$$

The method `map` applies a given function to all coefficients. E.g., the system function factor is not overloaded for `Series::Puiseux`, but you can use `map` to express all coefficients in factored form:

```
map(u, factor);
```

$$\operatorname{arctanh}(y) - \frac{x}{(y-1)(y+1)} + \frac{y x^2}{(y-1)^2 (y+1)^2} - \frac{(3y^2+1)x^3}{3(y-1)^3 (y+1)^3} + O(x^4)$$

In the next example, we use `map` to multiply all coefficients of a series expansion by a constant:

```
w := series(exp(x), x, 3);
map(w, _mult, PI) = PI*w
```

$$1 + x + \frac{x^2}{2} + O(x^3)$$

$$\pi + \pi x + \frac{\pi x^2}{2} + O(x^3) = \pi + \pi x + \frac{\pi x^2}{2} + O(x^3)$$

For series expansions of type 1, `map` applies the function to all non-zero coefficients as returned by `coeff`:

```
z := series(sin(sqrt(-x)), x);
coeff(z);
map(z, cos);
```

$$\sqrt{-x} - \frac{(-x)^{3/2}}{6} + \frac{(-x)^{5/2}}{120} + O(x^{7/2})$$

$$\frac{\sqrt{-x}}{\sqrt{x}}, 0, -\frac{(-x)^{3/2}}{6x^{3/2}}, 0, \frac{(-x)^{5/2}}{120x^{5/2}}$$

$$\sqrt{x} \cos\left(\frac{\sqrt{-x}}{\sqrt{x}}\right) + x^{3/2} \cos\left(\frac{(-x)^{3/2}}{6x^{3/2}}\right) + x^{5/2} \cos\left(\frac{(-x)^{5/2}}{120x^{5/2}}\right) + O\left(x^{7/2}\right)$$

## Example 22

Three different methods can be used to substitute for the series variable: `_fconcat`, `func_call`, and `subs`. Suppose `f` is an element of `Series::Puisseux` and we want to substitute an expression `t` for the series variable `x`. Then `_fconcat` converts `t` into a series expansion around the origin via the constructor, computes the functional composition, and returns the result as an element of `Series::Puisseux`:

```
f := series(exp(x), x = 0, 5);
Series::Puisseux::_fconcat(f, y) = f @ y;
f @ (y^2 + y);
```

$$1 + x + \frac{x^2}{2} + \frac{x^3}{6} + \frac{x^4}{24} + O(x^5)$$

$$1 + y + \frac{y^2}{2} + \frac{y^3}{6} + \frac{y^4}{24} + O(y^5) = 1 + y + \frac{y^2}{2} + \frac{y^3}{6} + \frac{y^4}{24} + O(y^5)$$

$$1 + y + \frac{3y^2}{2} + \frac{7y^3}{6} + \frac{25y^4}{24} + O(y^5)$$

The composition may fail if the limit point of `t` around the origin differs from the expansion point of `f` or if `t` contains special mathematical functions:

```
f @ (y + 1);
```

FAIL

```
f @ sin(y);
```

FAIL

Moreover, the composition does not work if the expression `t` is constant or contains more than one indeterminate:

```
f @ PI;
```

```
Error: Unable to compute composition. [Series::Puisseux::_fconcat]
```

```
f @ (x + y);
```

```
Error: Unable to compute composition. [Series::Puisseux::_fconcat]
```

You can enforce the composition by explicitly converting `t` into a series:

```
f @ series(y + 1, y = -1);
```

```
f @ series(sin(y), y = 0);
```

```
f @ series(x + y, x = -y);
```

$$1 + y + 1 + \frac{(y+1)^2}{2} + \frac{(y+1)^3}{6} + \frac{(y+1)^4}{24} + O((y+1)^5)$$

$$1 + y + \frac{y^2}{2} - \frac{y^4}{8} + O(y^5)$$

$$1 + x + y + \frac{(x+y)^2}{2} + \frac{(x+y)^3}{6} + \frac{(x+y)^4}{24} + O((x+y)^5)$$

Substitution with `func_call` always works. It discards the error term, `t` is substituted literally, and the result is an expression and not an object of type `Series::Puisseux`:

```
f(5) = Series::Puisseux::func_call(f, 5);
```

```
f(y) = Series::Puisseux::func_call(f, y);
```

$$\frac{523}{8} = \frac{523}{8}$$



$$\frac{y^4}{24} + \frac{y^3}{6} + \frac{y^2}{2} + y + 1 = \frac{y^4}{24} + \frac{y^3}{6} + \frac{y^2}{2} + y + 1$$

```
f(y^2 + y);
f(y + 1);
f(sin(y));
f(PI);
f(x + y);
```

$$y + \frac{(y^2 + y)^2}{2} + \frac{(y^2 + y)^3}{6} + \frac{(y^2 + y)^4}{24} + y^2 + 1$$

$$y + \frac{(y+1)^2}{2} + \frac{(y+1)^3}{6} + \frac{(y+1)^4}{24} + 2$$

$$\frac{\sin(y)^4}{24} + \frac{\sin(y)^3}{6} + \frac{\sin(y)^2}{2} + \sin(y) + 1$$

$$\pi + \frac{\pi^2}{2} + \frac{\pi^3}{6} + \frac{\pi^4}{24} + 1$$

$$x + y + \frac{(x+y)^2}{2} + \frac{(x+y)^3}{6} + \frac{(x+y)^4}{24} + 1$$

Finally, if `subs` is used to substitute for the series variable, only very special substitutions are allowed (see the description of `subs` above for more details). Then a change of variable is performed, and the result is again of type `Series::Puisseux`:

```
subs(f, x = y^2 + y)
```

```
Error: Invalid substitution. [Series::Puisseux::subs]
```

```
subs(f, x = y + 1)
```

$$1 + y + 1 + \frac{(y+1)^2}{2} + \frac{(y+1)^3}{6} + \frac{(y+1)^4}{24} + O((y+1)^5)$$

```
subs(f, x = sin(y))
```

```
Error: Invalid substitution. [Series::Puisseux::subs]
```

```
subs(f, x = PI)
```

```
Error: Invalid substitution. Exactly one indeterminate expected. [Series::Puisseux::subs]
```

```
subs(f, x = x + y)
```

```
Error: Invalid substitution. Exactly one indeterminate expected. [Series::Puisseux::subs]
```

All three methods can handle the case where the series variable occurs in the coefficients:

```
s := series(ln(x^2 + x), x);
s @ (2*y);
s(2*y);
subs(s, x = 2*y);
```

$$\ln(x) + x - \frac{x^2}{2} + \frac{x^3}{3} - \frac{x^4}{4} + \frac{x^5}{5} + O(x^6)$$

$$\ln(2) + \ln(y) + 2y - 2y^2 + \frac{8y^3}{3} - 4y^4 + \frac{32y^5}{5} + O(y^6)$$

$$2y + \ln(2y) - 2y^2 + \frac{8y^3}{3} - 4y^4 + \frac{32y^5}{5}$$

$$\ln(2y) + 2y - 2y^2 + \frac{8y^3}{3} - 4y^4 + \frac{32y^5}{5} + O(y^6)$$

Of course, `subs` can also be used to substitute for other objects than the series variable in the coefficients and in the expansion point:

```
g := series(cos(x + y), x, 4);
h := series(1/x, x = y, 4);
```

$$\cos(y) - x \sin(y) - \frac{x^2 \cos(y)}{2} + \frac{x^3 \sin(y)}{6} + O(x^4)$$

$$\frac{1}{y} - \frac{x-y}{y^2} + \frac{(x-y)^2}{y^3} - \frac{(x-y)^3}{y^4} + O((x-y)^4)$$

```
subs(g, y = PI) = series(cos(x + PI), x, 4);
subs(h, y = 2) = series(1/x, x = 2, 4);
```

$$-1 + \frac{x^2}{2} + O(x^4) = -1 + \frac{x^2}{2} + O(x^4)$$

$$\frac{1}{2} - \frac{x-2}{4} + \frac{(x-2)^2}{8} - \frac{(x-2)^3}{16} + O((x-2)^4) =$$

$$\frac{1}{2} - \frac{x-2}{4} + \frac{(x-2)^2}{8} - \frac{(x-2)^3}{16} + O((x-2)^4)$$

Even simultaneous substitutions are possible in the coefficients:

```
subs(g, [hold(sin) = cos, hold(cos) = sin, y = 2])
```

$$\sin(2) - x \cos(2) - \frac{x^2 \sin(2)}{2} + \frac{x^3 \cos(2)}{6} + O(x^4)$$

An error occurs, if the right hand side contains the series variable:

```
subs(h, y = x)
```

Error: Invalid substitution. Right side must not contain the series variable. [Series:

### Example 23

The method `has` checks, whether an object occurs syntactically in the coefficients, the series variable, the expansion point, or the direction of an element of `Series::Puisseux`:

```
f := series(sin(x + 2*y), x = PI, 2);
has(f, x), has(f, y), has(f, PI), has(f, 2), has(f, Undirected);
has(f, hold(sin)), has(f, 3), has(f, sin(2*y)), has(f, x - PI);
```

$$-\sin(2 y) - \cos(2 y) (x - \pi) + O((x - \pi)^2)$$

TRUE, TRUE, TRUE, TRUE, TRUE

TRUE, FALSE, TRUE, FALSE

The last call returns `FALSE` since the expression `x - PI` occurs only in the screen output, but not in the internal representation of `f`.

```
g := series(sign(x), x, Right);
has(g, Right), has(g, Undirected);
```

$$1 + O(x^0)$$

TRUE, FALSE

### Example 24

The method `truncate` discards summands up to the given order:

```
f := series(x*sin(sqrt(x)), x);
Series::Puisseux::truncate(f, 10);
Series::Puisseux::truncate(f, 9/2);
Series::Puisseux::truncate(f, 7/2);
Series::Puisseux::truncate(f, 3);
Series::Puisseux::truncate(f, 3/2);
Series::Puisseux::truncate(f, 1);
```

$$x^{3/2} - \frac{x^{5/2}}{6} + \frac{x^{7/2}}{120} + O(x^{9/2})$$

$$x^{3/2} - \frac{x^{5/2}}{6} + \frac{x^{7/2}}{120} + O(x^{9/2})$$

$$x^{3/2} - \frac{x^{5/2}}{6} + \frac{x^{7/2}}{120} + O(x^{9/2})$$

$$x^{3/2} - \frac{x^{5/2}}{6} + O(x^{7/2})$$

$$x^{3/2} - \frac{x^{5/2}}{6} + O(x^{7/2})$$

$$O(x^{3/2})$$

$$O(x^{3/2})$$

## Parameters

**f**

An arithmetical expression (Symbolic Math Toolbox) representing a function in  $x$

**x**

An identifier

**$x_0$**

The expansion point: an arithmetical expression (Symbolic Math Toolbox). If not specified, the default expansion point 0 is used.

**order**

The number of terms to be computed: a nonnegative integer. The default order is given by the environment variable ORDER (default value 6).

**dir**

Either `Left`, `Right`, `Real`, or `Undirected`. This optional argument can be used to specify that the resulting expansion is possibly valid along the real line only. The default is `Undirected`, which means that the expansion is valid in a neighborhood of the expansion point in the complex plane.

## Return Values

an object of domain type `Series::Puisseux`, or the value `FAIL`, if the `f` cannot be converted, e.g., if powers with non-rational exponents occur in `f`.

## Function Calls

Calling an element of `Series::Puisseux` as a function discards the error term and substitutes the first argument for the series variable. See the description of the method "`func_call`" and "Example 22" on page 7-459 (Symbolic Math Toolbox).

## Operations

`Series::Puisseux` implements the basic arithmetic of truncated series expansions. Use the ordinary arithmetical operators `+`, `-`, `*`, `/`, `^`, and `@` for composition.

The arithmetical methods of `Series::Puisseux` usually do not perform any symbolic simplifications. Use `combine`, `expand`, or `normal` to request such simplifications explicitly.

See “Example 5” on page 7-431 (Symbolic Math Toolbox) and “Example 21” on page 7-456 (Symbolic Math Toolbox).

Special mathematical functions, such as `exp` or `sin`, are overloaded for elements of `Series::Puisseux`; cf. “Example 10” on page 7-441 (Symbolic Math Toolbox).

The system functions `coeff`, `lcoeff`, `nthcoeff`, `ldegree`, `lmonomial`, `nthmonomial`, `lterm`, and `nthterm` work on truncated series expansions. Note that in contrast to polynomials, coefficients, monomials, and terms are counted from the term of lowest order term on. Cf. “Example 17” on page 7-451 (Symbolic Math Toolbox).

Use the function `expr` to convert a series expansion to an arithmetical expression (as an element of a kernel domain).

## Operands

A series of the domain type `Series::Puisseux` has the following seven operands:

- 1 a type *flag*  $t \in \{0, 1\}$ ,
- 2 the *branching order*  $b$ , a positive integer,
- 3 an integer  $v$  such that  $\frac{v}{b}$  is the order of the leading term,
- 4 an integer  $e \geq v$  such that  $\frac{e}{b}$  is the order of the error term,
- 5 a list of coefficients  $l_1, \dots, l_n$ ,
- 6 the *series variable*  $x$  and the *expansion point*  $x_0$  in form of an equation  $x = x_0$ ; the expansion point  $x_0$  may be `complexInfinity` as well,
- 7 a *direction*, `Undirected`, `Real`, `Left`, or `Right`.

The type flag distinguishes between two different internal representations.

If  $t = 0$ , then the operands above represent the truncated series expansion

$$\sum_{1 \leq i \leq n} \left( l_i (x - x_0)^{\frac{v+i-1}{b}} + \mathcal{O}\left((x - x_0)^{e/b}\right) \right)$$

If the expansion point  $x_0$  is `complexInfinity`, then the operands represent the truncated expansion

$$\sum_{1 \leq i \leq n} \left( \frac{l_i}{x^{\frac{(i+v-1)}{b}}} + O\left(\frac{1}{x^{\frac{\epsilon}{b}}}\right) \right)$$

•

A summand  $l_i(x-x_0)^{\frac{(v+i-1)}{b}}$  (or  $\frac{l_i}{x^{\frac{(i+v-1)}{b}}}$ , respectively) is called a *monomial* of the expansion,

•

the power  $(x-x_0)^{\frac{(v+i-1)}{b}}$  (or  $\frac{1}{x^{\frac{(i+v-1)}{b}}}$ , respectively) is called a *term*,

•  $l_i$  is the corresponding *coefficient*, and

•

the exponent  $\frac{(v+i-1)}{b}$  is the *order* of the corresponding term or monomial.

If  $t = 1$ , then the operands above represent the expansion

$$\sum_{1 \leq i \leq n} \left( l_i + O\left((x-x_0)^{\epsilon/b}\right) \right)$$

In this case, the powers of  $x - x_0$  are explicitly stored in the list, and  $l_i$  contains only terms

of growth order  $O\left((x-x_0)^{\frac{(v+i-1)}{b}}\right)$ . The corresponding expansion for  $x \neq x_0$  is

$$\sum_{1 \leq i \leq n} \left( l_i + O\left(\frac{1}{x^{\frac{\epsilon}{b}}}\right) \right),$$

and  $l_i$  contains only terms of growth order  $O\left(\frac{1}{x^{\frac{(v+i-1)}{b}}}\right)$ .

The notions term and order are the same as for  $t \neq 0$ , a summand  $l_i$  is called a monomial, and the corresponding coefficient is



$$\frac{l_i}{(x-x_0)^{\frac{v+i-1}{b}}}$$

(or

$$\frac{\frac{l_i}{1}}{x^{\frac{v+i-1}{b}}},$$

respectively).

The latter type of representation serves for correct expansions around branch points. For example, if we want to expand  $f(x) = \sqrt{x}$  around  $x = 0$ , then the truncated Puiseux series

$\sqrt{-1} \sqrt{x} + \mathcal{O}(x^{13/2})$  does not approximate  $f(x)$  in the lower half of the complex plane.

With  $t = 1$ , the expansion  $\sqrt{(-x)} + \mathcal{O}(x^{13/2})$ , which approximates  $f(x)$  also in the lower part of the complex plane near the origin, can be represented as an object of domain type `Series::Puisseux`.

The direction  $d$  has the same meaning as the parameter `dir` of the constructor. If  $d = \text{Undirected}$ , the operands above represent an expansion valid in some neighborhood of the expansion point in the complex plane. Usually, this is an open disc centered at  $x_0$ . If  $d \neq \text{Undirected}$  and  $x_0$  represents a real number, this means that the expansion is valid for real values of  $x$  only. If  $d = \text{Left}$  or  $d = \text{Right}$ , then the expansion is valid for  $x < x_0$  or  $x > x_0$ , respectively.

In the case  $x_0 = \text{complexInfinity}$ , and if  $d = \text{Undirected}$ , we have an expansion valid in the neighborhood of the north pole of the Riemann sphere, i.e., for all  $x \in \mathbb{C}$  of sufficiently large absolute value. If  $d = \text{Left}$ , we have an expansion around the positive real infinity valid for sufficiently large real values of  $x$ . Similarly, if  $d = \text{Right}$ , we have an expansion around the negative real infinity valid for sufficiently large negative real values of  $x$ . Finally, if  $d = \text{Real}$ , the expansion is valid both around *infinity* and around  $-\infty$ .

Cf. "Example 2" on page 7-425 (Symbolic Math Toolbox).

## Element Creation

Typically, objects of type `Series::Puisseux` are generated by calls to `series` or `taylor`.

## Methods

### Mathematical Methods

#### **conjugate** — Complex conjugation

`conjugate(s)`

This method overloads the system function `conjugate`. Cf. “Example 11” on page 7-442 (Symbolic Math Toolbox).

#### **contfrac** — Conversion into a continued fraction

`contfrac(s)`

This method overloads the system function `contfrac`. Cf. “Example 12” on page 7-443 (Symbolic Math Toolbox).

#### **diff** — Differentiation

`diff(s, t)`

This method overloads the system function `diff`. Cf. “Example 9” on page 7-440 (Symbolic Math Toolbox).

#### **\_divide** — Division

`_divide(s, t)`

#### **\_fconcat** — Functional composition

`_fconcat(s, t)`

If both `s` and `t` are of type `Series::Puisseux`, then the functional composition can only be defined if the limit point of `t` for values close to its expansion point is equal to the expansion point of `s`. Otherwise, an error occurs.

At least one of the arguments must be of type `Series::Puisseux`. If one of the arguments is not of this type, then it is converted into an element of `Series::Puisseux` via the constructor. If `s` is not of type `Series::Puisseux`, then it is converted into a series expansion around the limit point of `t`. If `t` is not of type `Series::Puisseux`, then it is converted into a series expansion around 0. The implicit conversion is performed only if the corresponding expression contains exactly one free variable.

This method overloads the system function `_fconcat` for series expansions, i.e., you may use it in the form `s@t`. See “Example 8” on page 7-437 (Symbolic Math Toolbox) and “Example 22” on page 7-459 (Symbolic Math Toolbox).

### **Im — Imaginary part**

`Im(s)`

This method overloads the system function `Im`. Cf. “Example 11” on page 7-442 (Symbolic Math Toolbox).

### **int — Integration**

`int(s, t | t = a .. b)`

This method overloads the system function `int`. Cf. “Example 9” on page 7-440 (Symbolic Math Toolbox), and the help page of `int` for a description of further optional arguments.

### **\_invert — Reciprocal of a series**

`_invert(s)`

This method overloads the system function `_invert`, i.e., you may use it in the form `1/s`.

### **ilaplace — Inverse Laplace transform**

`ilaplace(s, u, v)`

If `u` is not the series variable of `s`, then the coefficients of `s` are transformed, but not the expansion point. Otherwise, the expansion point of `s` must be infinity, `v` must be an identifier, and `s` is transformed term by term. The result is then a series expansion around `v = 0`.

This method overloads the function `ilaplace` for series expansions. Cf. “Example 13” on page 7-444 (Symbolic Math Toolbox).

### **laplace — Laplace transform**

`laplace(s, u, v)`

If `u` is not the series variable of `s`, then the coefficients of `s` are transformed, but not the expansion point. Otherwise, the expansion point of `s` must be 0, the order of the leading term of `s` must be nonnegative, `v` must be an identifier, and `s` is transformed term by term. The result is then a series expansion around  $v = \infty$ .

This method overloads the function `laplace` for series expansions. Cf. “Example 13” on page 7-444 (Symbolic Math Toolbox).

### **\_mult — Multiplication**

`_mult(s, t, , ...)`

Use the method `Series::Puisseux::scalmult` to multiply a series expansion `s` by a constant or a power of  $x - x_0$ .

This method overloads the system function `_mult` for series expansions, i.e., you may use it in the form `s*t*... .` Cf. “Example 5” on page 7-431 (Symbolic Math Toolbox).

### **\_negate — Negation**

`_negate(s)`

This method overloads the system function `_negate`, i.e., you may use it in the form `-s`.

### **\_plus — Addition**

`_plus(s, t, , ...)`

This method overloads the system function `_plus` for series expansions, i.e., you may use it in the form `s+t+... .` Cf. “Example 5” on page 7-431 (Symbolic Math Toolbox).

### **\_power — Exponentiation**

`_power(s, n)`

If `n` is a rational number, the direction of `s` is `Undirected` or `Real`, and the leading coefficient of `s` is not positive, then the type flag of the result is 1 in general.

If  $n$  is not a rational number, then the leading summand of  $s$  must not contain the series variable. Otherwise, an error occurs.

This method overloads the system function `_power` for series expansions, i.e., you may use it in the form  $s^n$ . Cf. “Example 7” on page 7-435 (Symbolic Math Toolbox).

### **Re — Real part**

`Re(s)`

This method overloads the system function `Re`. Cf. “Example 11” on page 7-442 (Symbolic Math Toolbox).

### **revert — Functional inversion**

`revert(s)`

The expansion point of the inverse is the limit point of  $s$ .

This method overloads the system function `revert`. Cf. “Example 8” on page 7-437 (Symbolic Math Toolbox).

### **scalmult — Multiplication by a single monomial**

`Series::Puisseux::scalmult(s, a, k)`

### **series — Serie expansion**

`series(s, y | y = y0, <order>, <dir>)`

This method overloads the system function `series`.

### **\_subtract — Subtraction**

`_subtract(s, t)`

## **Access Methods**

### **coeff — Extract coefficients**

`coeff(s, <x>, n)`

`coeff(s, <x>)`

The second call returns the sequence of all coefficients of  $s$ , starting with the coefficient of lowest order. (This is the coefficient of the term with the highest exponent if  $x_0 = \text{complexInfinity}$ .)

Specifying the variable  $x$  is optional; if it is present, it must coincide with the series variable of  $s$ .

This method overloads the system function `coeff`. Cf. “Example 14” on page 7-446 (Symbolic Math Toolbox).

### **direction — Direction of expansion**

`Series::Puisseux::direction(s)`

### **indet — Serie variable**

`Series::Puisseux::indet(s)`

### **iszero — Zero test**

`iszero(s)`

This method overloads the system function `iszero`. Cf. “Example 18” on page 7-452 (Symbolic Math Toolbox).

### **lcoeff — Leading coefficient (of lowest order)**

`lcoeff(s)`

This method overloads the system function `lcoeff`. See “Example 15” on page 7-447 (Symbolic Math Toolbox) and “Example 17” on page 7-451 (Symbolic Math Toolbox).

### **ldegree — Leading degree**

`ldegree(s)`

This method overloads the system function `ldegree`. See “Example 2” on page 7-425 (Symbolic Math Toolbox) and “Example 15” on page 7-447 (Symbolic Math Toolbox).

### **lmonomial — Leading monomial (of lowest order)**

`lmonomial(s)`

This method overloads the system function `lmonomial`. See “Example 15” on page 7-447 (Symbolic Math Toolbox) and “Example 17” on page 7-451 (Symbolic Math Toolbox).

### **lterm — Leading term (of lowest order)**

`lterm(s)`

This method overloads the system function `lterm`. See “Example 15” on page 7-447 (Symbolic Math Toolbox) and “Example 17” on page 7-451 (Symbolic Math Toolbox).

### **nthcoeff — Extract coefficients**

`nthcoeff(s, n)`

This method overloads the system function `nthcoeff`. See “Example 16” on page 7-449 (Symbolic Math Toolbox) and “Example 17” on page 7-451 (Symbolic Math Toolbox).

### **nthmonomial — Extract monomials**

`nthmonomial(s, n)`

This method overloads the system function `nthmonomial`. See “Example 16” on page 7-449 (Symbolic Math Toolbox) and “Example 17” on page 7-451 (Symbolic Math Toolbox).

### **nthterm — Extract terms**

`nthterm(s, n)`

This method overloads the system function `nthterm`. See “Example 16” on page 7-449 (Symbolic Math Toolbox) and “Example 17” on page 7-451 (Symbolic Math Toolbox).

### **order — Order of the error term**

`Series::Puisseux::order(s)`

### **point — Expansion point**

`Series::Puisseux::point(s)`

## Conversion Methods

### **convert** — Convert any object into a series expansion

`convert(f)`

If no expansion point can be determined from  $f$ , the origin is used. Cf. “Example 19” on page 7-452 (Symbolic Math Toolbox).

### **convert\_to** — Convert a series expansion into another domain

`convert_to(s, T)`

Use the function `expr` to convert  $s$  into an object of a kernel domain (Symbolic Math Toolbox).

### **convert01** — Convert into a series expansion of type 1

`Series::Puisseux::convert01(s)`

### **convert10** — Try to convert into a series expansion of type 0

`Series::Puisseux::convert10(s)`

For undirected expansions, the conversion is not possible in general, and then  $s$  is returned. However, you can enforce a conversion (with a not necessarily equivalent result) by using properties (Symbolic Math Toolbox). Cf. “Example 3” on page 7-428 (Symbolic Math Toolbox).

### **expr** — Convert a series expansion into an element of a kernel domain

`expr(s)`

This method overloads the system function `expr`. Cf. “Example 20” on page 7-455 (Symbolic Math Toolbox).

### **float** — Convert numeric parts of the coefficients into floats

`float(s)`

This method overloads the system function `float`. Cf. “Example 20” on page 7-455 (Symbolic Math Toolbox).



## Technical Methods

### combine — Combine coefficients

combine(s)

This method overloads the system function `combine`; see the corresponding help page for further optional arguments. Cf. “Example 21” on page 7-456 (Symbolic Math Toolbox).

### const — Convert a constant expression into a truncated series

Series::Puisseux::const(f, x | x = x<sub>0</sub>, n, <d>)

If the expansion point  $x_0$  is omitted,  $x_0 = 0$  is assumed. If the direction  $d$  is omitted,  $d = \text{Undirected}$  is assumed.

Use with care, since this function does not perform type checking. Cf. “Example 1” on page 7-422 (Symbolic Math Toolbox).

### create — Syntactical constructor

Series::Puisseux::create(b, v, e, l, x, <x<sub>0</sub>>, <d>)

If the expansion point  $x_0$  is omitted,  $x_0 = 0$  is assumed. If the direction  $d$  is omitted,  $d = \text{Undirected}$  is assumed.

Use with care, since this function does not perform type checking. Cf. “Example 1” on page 7-422 (Symbolic Math Toolbox).

### expand — Expand coefficients

expand(s)

This method overloads the system function `expand`; see the corresponding help page for further optional arguments. Cf. “Example 21” on page 7-456 (Symbolic Math Toolbox).

### func\_call — Evaluation at a point

Series::Puisseux::func\_call(s, t)

You may also use this method in the form  $s(t)$ . Cf. “Example 22” on page 7-459 (Symbolic Math Toolbox).

**has — Check whether an object occurs syntactically**

has(s, t)

This method overloads the system function has. Cf. “Example 23” on page 7-464 (Symbolic Math Toolbox).

**map — Apply a function to all non-zero coefficients**

map(s, f, <arg1, , ...>)

This method overloads the system function map. Cf. “Example 21” on page 7-456 (Symbolic Math Toolbox).

**normal — Normal form**

normal(s)

This method overloads the system function normal. Cf. “Example 21” on page 7-456 (Symbolic Math Toolbox).

**one — Create a truncated series with constant term 1**

Series::Puisseux::one(x, <x0>, n, <d>)

If the expansion point  $x_0$  is omitted,  $x_0 = 0$  is assumed. If the direction  $d$  is omitted,  $d = \text{Undirected}$  is assumed.

Use with care, since this function does not perform type checking. Cf. “Example 1” on page 7-422 (Symbolic Math Toolbox).

**print — Pretty-print routine**

print(s)

**truncate — Truncate a series expansion**

Series::Puisseux::truncate(s, n)

Cf. “Example 24” on page 7-464 (Symbolic Math Toolbox).

**subs — Replace subexpressions**

subs(s, old = new)

```
subs(s, [old1 = new1, old2 = new2, ...])
```

If the series variable  $x$  of  $s$  does not occur in the left hand sides  $old$ ,  $old1$ ,  $old2$ ,  $\dots$ , then the substitution takes place in the coefficients and in the expansion point of  $s$ . The series variable must not occur in the right hand sides  $new$ ,  $new1$ ,  $new2$ ,  $\dots$ .

---

**Note** In contrast to the usual behavior of `subs`, the result of the substitution is subjected to an additional evaluation.

---

In the second call, the series variable  $x$  of  $s$  must not occur anywhere in the substitution equations. In the first call,  $x$  is allowed to occur in  $old$  only if  $old$  equals  $x$ . In this case, a change of variable is performed, and  $new$  must be of the form

$$x_0 + a*(b*y - c)^k$$

if  $x_0 \neq \text{complexInfinity}$  and

$$a*(b*y - c)^k$$

if  $x_0 = \text{complexInfinity}$ , where

- $x_0$  is the expansion point of  $s$
- $k$  is a non-zero rational number
- $y$  is an identifier, which may well be equal to  $x$ , and otherwise  $y$  must not occur in the coefficients of  $s$ .
- $a$ ,  $b$ ,  $c$  are arithmetical expressions (Symbolic Math Toolbox) not involving  $y$ , with  $a$ ,  $b$  being non-zero. If the direction of  $s$  is not `Undirected`, then  $a$  and  $b$  must represent real numbers.
- $c$  is zero if either  $x_0 \neq \text{complexInfinity}$  and  $k$  is positive or  $x_0 = \text{complexInfinity}$  and  $k$  is negative. In this case, the result of the substitution has expansion point `complexInfinity`.
- If  $c$  is non-zero, then the result of the substitution has expansion point  $c/b$ .

Use one of the methods "`_fconcat`" or "`func_call`" for more general substitutions for the series variable.

This method overloads the system function `subs`; Cf. "Example 22" on page 7-459 (Symbolic Math Toolbox).

**zero — Create a truncated series with an error term only**

`Series::Puisseux::zero(x, <x0>, n, <d>)`

If the expansion point  $x_0$  is omitted,  $x_0 = 0$  is assumed. If the direction  $d$  is omitted,  $d = \text{Undirected}$  is assumed.

---

**Note** Although `Series::Puisseux::zero(x, n)` and  $0(x^n)$  are mathematically equivalent and are printed in the same way, they are different MuPAD objects. The former is an element of type `Series::Puisseux`, while the latter is an element of type `0`.

---

Use with care, since this function does not perform type checking. Cf. “Example 1” on page 7-422 (Symbolic Math Toolbox).

## See Also

**MuPAD Functions**

`asympt` | `series`

**MuPAD Domains**

`Series::gseries`

# Series::gseries

Generalized series expansions

## Syntax

```
Series::gseries(f, x, <order>, <Left | Right>)
```

```
Series::gseries(f, x = a, <order>, <Left | Right>)
```

## Description

`Series::gseries` is the domain of series expansions generalizing Taylor, Laurent and Puiseux expansions.

The call `Series::gseries(f, x)` computes a series expansion at the right hand side of  $x = 0$ .

The system functions `series` and `asymp` are the main application of this domain. The latter function only returns elements of this domain, whereas `series` can return an element of `Series::gseries` in cases, where a Puiseux series expansion does not exist.

There may be no need to explicitly create elements of this domain, but to work with the results of the mentioned system functions.

See the help page of the system function `asymp` for a detailed description of the parameters and examples for working with elements of the domain `Series::gseries`.

---

**Note** Note that elements of `Series::gseries` only represents *directional* (real) series expansions.

---

## Environment Interactions

The function is sensitive to the global variable `ORDER`, which determines the default number of terms of the expansion.

## Parameters

**f**

An arithmetical expression

**x**

The series variable: an identifier

**a**

The expansion point: an arithmetical expression or  $\pm\text{infinity}$

**order**

The truncation order: a nonnegative integer

## Options

**Left**

Compute a series expansion that is valid for real  $x$  smaller than  $a$ .

**Right**

Compute a series expansion that is valid for real  $x$  larger than  $a$  (the default case).

## Return Values

Object of domain type `Series::gseries`, or the value `FAIL`.

## Function Calls

Calling an element of `Series::gseries` as a function yields the object itself, regardless of the arguments. The arguments are *not* evaluated.

## Operations

Series::gseries implements standard arithmetic of generalized series expansions. Use the ordinary arithmetical operators  $+$ ,  $-$ ,  $*$ ,  $/$ , and  $^$ .

The system functions `coeff`, `lcoeff`, `nthcoeff`, `lterm`, `nthterm`, `lmonomial`, `nthmonomial`, and `ldegree` work on generalized series expansions. See the corresponding help pages of these functions for calling parameters. See the description of these methods below for further details.

The method "indet" returns the series variable of the series expansion, i.e., if `s` is an object of the domain Series::gseries, then `s::dom::indet(s)` returns the series variable.

The method "point" returns the expansion point of the series.

Use the function `expr` to convert a generalized series expansion into an arithmetical expression (as an element of a kernel domain).

## Operands

A series of the domain type Series::gseries consists of four operands:

- 1 A list of pairs  $[c_i, f_i]$ . Each pair represents a *monomial*  $c_i f_i$  of the series expansion, where the  $c_i$  are the *coefficients* and  $f_i$  the *terms* of `s`. The coefficients do not contain the series variable.

This list can be empty, if the order of the expansion is zero.

- 2 An arithmetical expression `g` representing the *error term* of the form  $O(g)$ . It may be the integer 0, in which case the expansion is exact.
- 3 The *series variable* `x`.
- 4 The *expansion point* `a`.

## Methods

### Mathematical Methods

#### **`_divide` — Divide two series expansions**

`_divide(s, t)`

If the arguments are not of domain type `Series::gseries`, then they are converted into such objects. FAIL is returned, if one of these conversions fails.

This method overloads the function `_divide` for elements of `Series::gseries`, i.e., you may use it in the form `s/t`.

#### **`_invert` — Multiplicative inverse of a series expansion**

`_invert(s)`

This method overloads the function `_invert` for elements of `Series::gseries`, i.e., you may use it in the form `1/s`.

#### **`_mult` — Multiply series expansions**

`_mult(s, t, ...)`

If both `s` and `t` are series expansions of the domain `Series::gseries`, then the result is a series expansion of the domain `Series::gseries`, too. Both series expansions must have the same series variable and expansion point, otherwise FAIL is returned.

If `s` or `t` is a series expansion of the domain `Series::Puiseux`, then it is converted into an object of `Series::gseries`. If this fails, then FAIL is returned. Otherwise, the product is computed and returned as an object of the domain `Series::gseries`.

If `s` is a series expansion and `t` is an arithmetical expression, then `t` is converted into a series expansion via the constructor `Series::gseries` (and vice versa).

Each argument of this method that is not of the domain type `Series::gseries` is converted into such an element, i.e., a generalized series expansion is computed. If this fails, then FAIL is returned.



This method overloads the function `_mult` for elements of `Series::gseries`, i.e., you may use it in the form `s*t*...`

### **`_negate` — Negative of a series expansion**

`_negate(s)`

This method overloads the function `_negate` for elements of `Series::gseries`, i.e., you may use it in the form `-s`.

### **`_plus` — Add series expansions**

`_plus(s, t, ...)`

If both `s` and `t` are series expansions of the domain `Series::gseries`, then the result is a series expansion of the domain `Series::gseries`, too. Both series expansions must have the same series variable and expansion point, otherwise `FAIL` is returned.

If `s` or `t` is a series expansion of the domain `Series::Puiseux`, then it is converted into an object of `Series::gseries`. If this fails, then `FAIL` is returned. Otherwise, the sum is computed and returned as an object of the domain `Series::gseries`.

If `s` is a series expansion and `t` is an arithmetical expression, then `t` is converted into a series expansion via the constructor `Series::gseries` (and vice versa).

Each argument of this method that is not of the domain type `Series::gseries` is converted into such an element, i.e., a generalized series expansion is computed. If this fails, then `FAIL` is returned.

This method overloads the function `_plus` for elements of `Series::gseries`, i.e., you may use it in the form `s+t+...`

### **`_power` — Exponentiation of a series expansion**

`_power(s, n)`

The exponent `n` must not involve the series variable of `s`. Otherwise, an error occurs.

If `n` is a positive integer, then repeated squaring is used for computing the `n`th power of `s`. Otherwise, the binomial theorem is applied after factoring out the leading monomial.

This method overloads the function `_power` for elements of `Series::gseries`, i.e., you may use it in the form `s^n`.

**`_subtract` — Subtract two series expansions**`_subtract(s, t)`

If the arguments are not of domain type `Series::gseries`, then they are converted into such objects. FAIL is returned, if one of these conversions fails.

This method overloads the function `_subtract` for elements of `Series::gseries`, i.e., you may use it in the form `s - t`.

## Access Methods

**`coeff` — Extract coefficients**`coeff(s, <n>)`

This method overloads the function `coeff` for elements of `Series::gseries`.

**`indet` — Serie variable**`Series::gseries::indet(s)`

Use the method "point" to get the expansion point of `s`.

**`iszero` — Zero test**`iszero(s)`

This method overloads the function `iszero` for elements of `Series::gseries`.

**`lcoeff` — Leading coefficient**`lcoeff(s)`

This method overloads the function `lcoeff` for elements of `Series::gseries`.

**`ldegree` — Leading degree**`ldegree(s)`

This method overloads the function `ldegree` for elements of `Series::gseries`.

**lmonomial — Leading monomial**`lmonomial(s)`

This method overloads the function `lmonomial` for elements of `Series::gseries`.

**lterm — Leading term**`lterm(s)`

This method overloads the function `lterm` for elements of `Series::gseries`.

**nthcoeff — Extract a coefficient**`nthcoeff(s, n)`

This method overloads the function `nthcoeff` for elements of `Series::gseries`.

**nthmonomial — Extract a monomial**`nthmonomial(s, n)`

This method overloads the function `nthmonomial` for elements of `Series::gseries`.

**nthterm — Extract a term**`nthterm(s, n)`

This method overloads the function `nthterm` for elements of `Series::gseries`.

**point — Expansion point**`Series::gseries::point(s)`

Use the method `"indet"` to get the series variable of `s`.

## Conversion Methods

**convert — Convert an object into a generalized series expansion**`Series::gseries::convert(x)`

**convert\_to — Convert a generalized series expansion into other domains**

```
Series::gseries::convert_to(s, T)
```

T might be the domain `DOM_POLY`, where the sum of monomials is considered as a polynomial in the indeterminates of the third operand of `s`.

If T is the domain `DOM_EXPR`, then the conversion is the same as implemented by the method "expr" (see below).

If T is the domain `Series::Puiseux`, then the system tries to convert `s` into a Puiseux series. If the conversion is not possible, `FAIL` is returned.

Use the function `expr` to convert `s` into an object of a kernel domain.

**create — Create simple and fast a generalized series expansion**

```
Series::gseries::create(list, errorTerm, x = a)
```

---

**Note** This method should be used with caution, because no argument checking is performed. Use it to *create*, not to compute elements of `Series::gseries`.

---

**expr — Convert a generalized series expansion into an element of a kernel domain**

```
expr(s)
```

This method overloads the function `expr` for elements of `Series::gseries`.

**series — Apply the function series to a generalized series expansion**

```
series(s, x | x = x0, <order>, <dir>)
```

This method overloads the function `series` for elements of `Series::gseries`. See the corresponding help page for a description of the possible arguments.

## Technical Methods

**combine** — Apply the function combine to all terms

`combine(s, <target>)`

This method overloads the system function `combine`. See the corresponding help page for a description of the optional argument `target`.

**has** — Check whether an object occurs syntactically

`has(s, t)`

This method overloads the system function `has`.

**map** — Map a function to the coefficients

`map(s, func, ...)`

This method overloads the function `map` for elements of `Series::gseries`.

**print** — Pretty-print routine

`print(s)`

**subs** — Substitute into a generalized series expansion

`subs(s, x = a, ...)`

This method overloads the function `subs` for elements of `Series::gseries`.

## See Also

**MuPAD Domains**

`Series::Puisseux`



## **export - Export Data**

---

## export::stl

Export STL data

### Syntax

```
export::stl(filename, [x, y, z], u = u_min .. u_max, v = v_min .. v_max, options)
```

```
export::stl(n, [x, y, z], u = u_min .. u_max, v = v_min .. v_max, options)
```

```
export::stl(filename, object1, <object2, ...>, options)
```

```
export::stl(n, object1, <object2, ...>, options)
```

### Description

`export::stl` is used to create a triangulation of a parametrized surface and write the triangulation data in STL format to an external file.

STL files contain triangulation data of 3D surfaces. Each triangle is stored as a unit normal and three vertices. The normal and the vertices are specified by three coordinates each, so there is a total of 12 numbers stored for each triangle. Read the “Background” section of this help page for further details.

If the surface is closed, it is regarded as the boundary of a 3D solid. The normals of the triangles written into the STL file should point from the inside of the body to the outside.

---

**Note** Note that the direction of the normals that `export::stl` writes into the STL file depend on the parametrization  $x(u, v)$ ,  $y(u, v)$ ,  $z(u, v)$ !

---

If  $p_1 = (x(u, v), y(u, v), z(u, v))$ ,  $p_2 = (x(u + du, v), y(u + du, v), z(u + du, v))$ ,  $p_3 = (x(u, v + dv), y(u, v + dv), z(u, v + dv))$  are the corners of a triangle, the normal associated with this triangle is the cross product of the side  $p_2 - p_1$  times the side  $p_3 - p_1$ . The routine `export::stl` chooses neighboring values of the surface parameters with  $du = (\text{`u_{max}`} - \text{`u_{min}`}) / (n_u - 1)$  and  $dv = (\text{`v_{max}`} - \text{`v_{min}`}) / (n_v - 1)$ , respectively.



---

**Note** Thus, if your parametrization is such that the cross product of the vectors  $p_2 - p_1$  and  $p_3 - p_1$  does not point to the outside of your body, you just need to let one of the parameters ( $u$ , say) run from  $u_{\max}$  to  $u_{\min}$  instead of from  $u_{\min}$  to  $u_{\max}$ . Just replace your call

```
export::stl(filename, [x,y,z], u = `u_{min}` .. `u_{max}`, v =
`v_{min}` .. `v_{max}`)
```

by

```
export::stl(filename, [x,y,z], u = `u_{max}` .. `u_{min}`, v =
`v_{min}` .. `v_{max}`).
```

---

Up to the irrelevant ordering in the STL file, the triangles generated by these calls are the same apart from the direction of the normal associated with each triangle.

If the file is specified by a character string, the corresponding file is opened and closed, automatically.

As an alternative to specifying the file by a string, the user may open the file herself via `fopen` in `Write` mode and pass the file descriptor returned by `fopen` to `export::stl`. If binary data are to be written to the file, make sure that it is opened with the `Raw`, i.e., call `fopen(filename, Write, Raw)`.

---

**Note** Note that `export::stl` does not close the file automatically if it is specified by a file descriptor. It remains open after `export::stl` has finished its job. The file needs to be closed explicitly by the user using `fclose`.

---

If the file is specified by a character string, the name may correspond to an absolute or a relative path name. In particular, the environment variable `WRITEPATH` is taken into account. The details on the help page of `fopen` hold for `export::stl`, too.

---

**Note** With the option `Append`, the file is first opened for reading and, after reading of the data in the file, opened for writing. If no absolute pathname is used to specify the file, make sure that the environment variables `READPATH` and `WRITEPATH` point to the same folder. Alternatively, it is a good idea to place the file in the same folder as the MuPAD notebook which you are currently using. If this notebook is saved on the disk of your computer, the absolute path is available as the environment variable `NOTEBOOKPATH`.

Thus, specifying a file named "myfile.stl", say, by the absolute path name `NOTEBOOKPATH. "myfile.stl"` ensures that the file is found in the same folder as your notebook.

---

Text files generated with the option `Text` or the equivalent `Ascii` can be opened and read with any text editor. However, binary files generated with the option `Bin` or the equivalent options `Binary` or `Raw` are faster to create and to process.

The file generated by `export::stl` can be read and visualized in MuPAD using the plot primitive `plot::SurfaceSTL`.

If the file name given ends in ".gz", `export::stl` writes a compressed file which can be read by any program supporting `gzip` compression.

## Environment Interactions

The function is sensitive to the environment variable `DIGITS` which determines the numerical working precision. The current value of `DIGITS` determines the number of significant decimal digits with which the STL data are written to the specified file. (This holds for text files. In binary STL files all numerical values have a precision of about 7 decimal digits.) For the internal computation of the data by MuPAD, the value of `DIGITS` is temporarily increased by 10 to minimize round-off effects.

The STL data generated by `export::stl` are written to the specified file.

## Examples

### Example 1

We generate a sphere given by the following parametrization:

```
x:= cos(u)*sin(v):  
y:= sin(u)*sin(v):  
z:= cos(v):
```

We call `export::stl` to generate the STL data and write them into a file named "sphere.stl". The file is to be generated in the same directory as the current MuPAD notebook that we are using. Hence, we specify an absolute path name for the file using

the path of the current notebook. If this notebook was saved to the disk of your computer, this path is available in the environment variable NOTEBOOKPATH:

```
filename:= NOTEBOOKPATH."sphere.stl":  
export::stl(filename, [x, y, z], u = 0 .. 2*PI, v = 0 .. PI, Text)
```

Since the file was created in Text format, it can be opened with any text editor. It should look like this:

```
solid MuPADtoSTL1  
facet normal -0.06540070486 -0.008610166138 -0.9978219344  
  outer loop  
    vertex 100.0 100.0 300.0  
    vertex 112.607862 103.3782664 298.7167292  
    vertex 113.0526192 100.0 298.7167292  
  endloop  
endfacet  
facet normal -0.1950260058 -0.02567566076 -0.9804619409  
  outer loop  
    vertex 113.0526192 100.0 298.7167292  
    vertex 112.607862 103.3782664 298.7167292  
    vertex 125.0 106.6987298 294.8888739  
  endloop  
endfacet  
  
...  
  
endsolid MuPADtoSTL1
```

We reimport the STL data and visualize the surface using `plot::SurfaceSTL`:

```
plot(plot::SurfaceSTL(filename, MeshVisible))
```

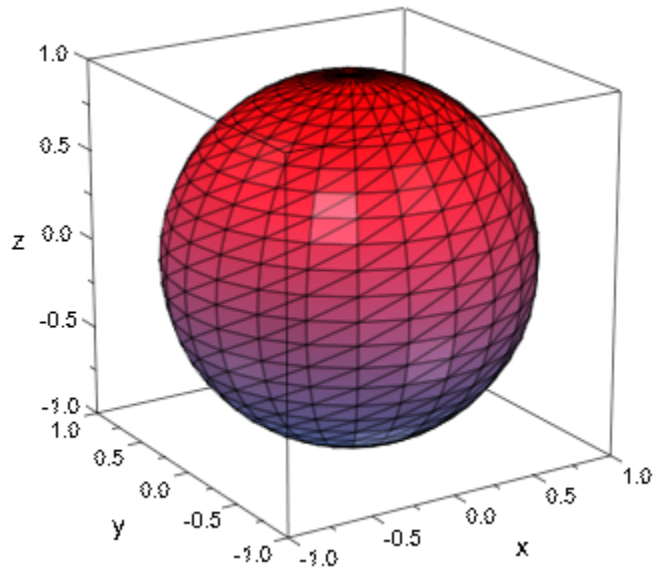

We reduce the number of significant output digits to a reasonable size. Further, we specify a mesh size and request a specific output box:

```
DIGITS:= 7:
export::stl(filename, [x, y, z], u = 0..2*PI, v = 0..PI,
            Mesh = [10, 10],
            OutputBox = [-100..100, -100..100, -100..100],
            Text):
```

The file now should look like this:

```
solid MuPADtoSTL2
facet normal -0.1733024 -0.06307691 -0.9828467
  outer loop
    vertex -3.10912 0.000000002143114 100.0
    vertex 24.32249 22.66816 93.96926
    vertex 32.7003 0.000000002143114 93.96926
  endloop
endfacet
...
```

```
endsolid MuPADtoSTL2
```

We visualize the new content of the file:

```
plot(plot::SurfaceSTL(filename, MeshVisible))
```

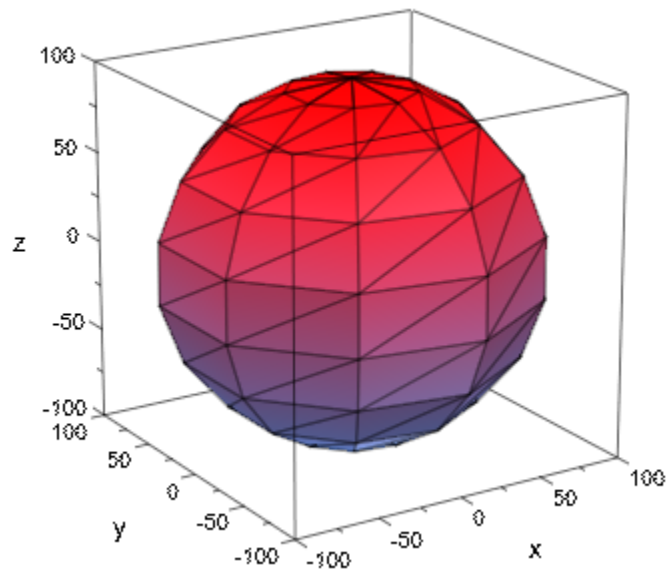

```
delete x, y, z, filename, DIGITS:
```

## Example 2

We specify the parametrization of the surface by a mixture of expressions and procedures:

```
x:= piecewise([0.1 < u < 0.9, u*cos(v)], [0otherwise, 0]):
y:= (u, v) -> piecewise([0.1 < u < 0.9, u*sin(v)], [0otherwise, 0]):
z:= (u, v) -> if u <= 0.1 then exp(-0.1)
               elif u < 0.9 then exp(-u)
               else exp(-0.9)
               end_if:
```

This is the surface that we wish to export to STL:

```
plot(plot::Surface([x, y, z], u = 0..1, v = 0..2*PI,
                  Mesh = [100, 36])):
```

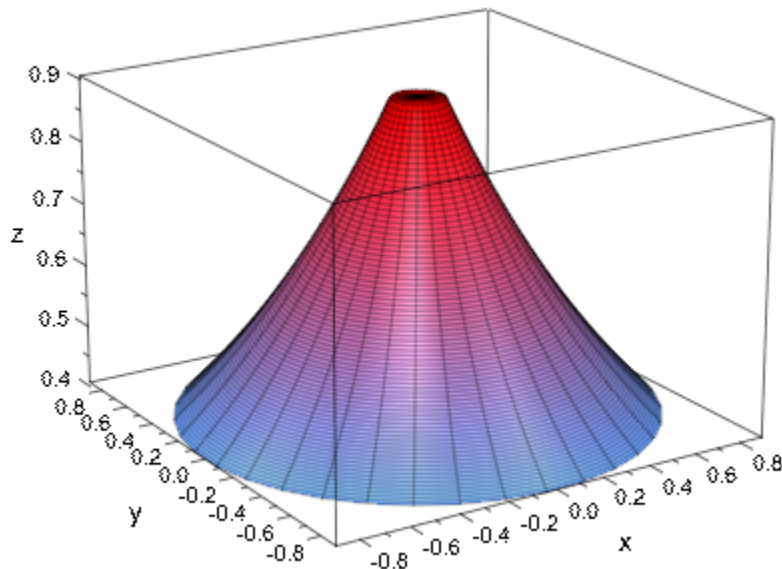

We assume that there is no external file “sample.stl”. We create it by opening it in **Write** mode in the same directory as the current MuPAD notebook that we are using. Hence, we specify an absolute path name for the file using the path of the current notebook. If this notebook was saved to the disk drive of your computer, this path is available in the environment variable `NOTEBOOKPATH`. The file descriptor `n` returned by `fopen` is passed to `export::stl`:

```
filename:= NOTEBOOKPATH."sample.stl":
DIGITS:= 7:
export::stl(filename, [x, y, z], u = 0..1, v = 0..2*PI,
            Mesh = [30, 36])
```

We reimport the STL data and visualize the surface using `plot::SurfaceSTL`:

```
plot(plot::SurfaceSTL(filename, MeshVisible))
```

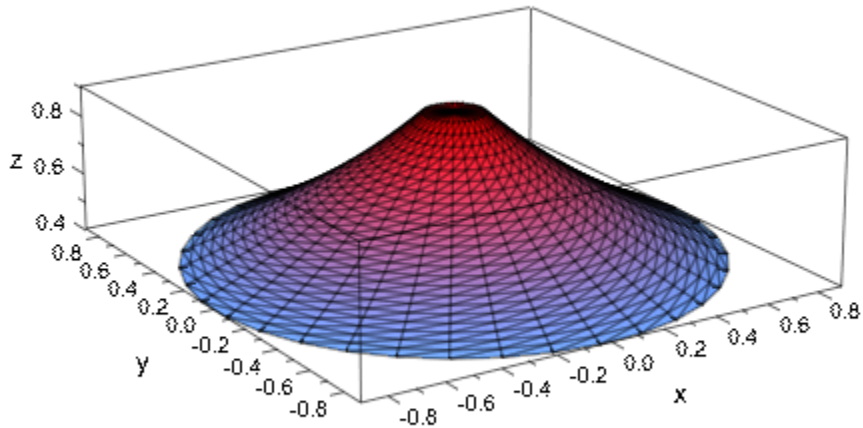

We can append a further surface to the file using the option Append:

```
export::stl(filename, [x, y, -z], u = 0..1, v = 0..2*PI,  
            Mesh = [30, 36],  
            OutputBox = [0..100, 0..100, -100..0],  
            Append)
```

We visualize the new content of the file via plot::SurfaceSTL:

```
plot(plot::SurfaceSTL(filename, MeshVisible))
```

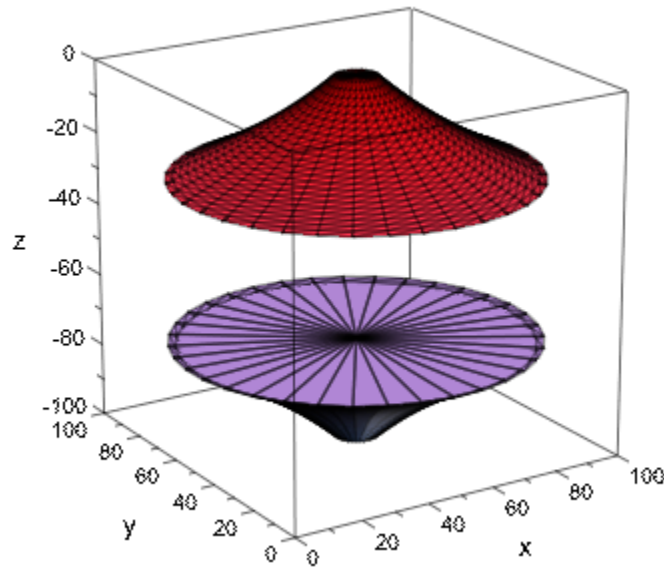

```
delete x, y, z, filename, DIGITS:
```

### Example 3

We wish to create a closed surface consisting of a “bowl” with a “lid”.

```
bowl:= [u*cos(v), u*sin(v), u^2], u = 0 .. 1, v = 0 .. 2*PI:
lid:= [u*cos(v), u*sin(v), 1 ], u = 0 .. 1, v = 0 .. 2*PI:
```

```
filename:= NOTEBOOKPATH."sample.stl":
DIGITS:= 7:
export::stl(filename, bowl, Mesh = [30, 36]):
export::stl(filename, lid, Mesh = [30, 36], Append):
plot(plot::SurfaceSTL(filename), Scaling = Constrained):
```



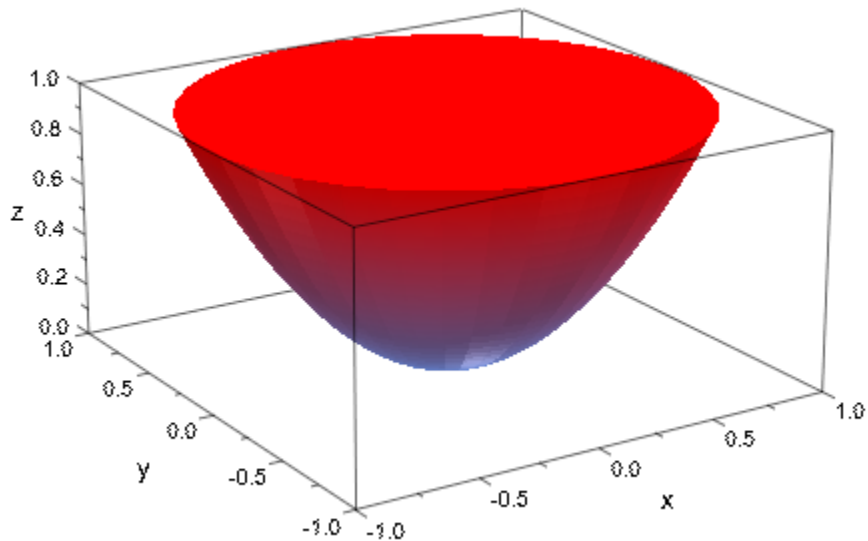

```
delete filename, DIGITS:
```

## Example 4

We demonstrate the options `Scaling = Constrained` and `Scaling = Unconstrained`. With `Scaling = Constrained`, the coordinates given by the parametrization  $x$ ,  $y$ ,  $z$  are scaled by the same factor to fit the surface into the output box. Here, we create a sphere of radius 1. The output box is not a cube: the range for the  $z$  coordinate is notably larger than for  $x$  and  $y$ . Nevertheless, the sphere stays a sphere when using `Scaling = Constrained`. However, the output box is not completely filled by the sphere:

```
x:= cos(u)*sin(v):
y:= sin(u)*sin(v):
z:= cos(v):
DIGITS:= 7:
filename:= NOTEBOOKPATH."sphere.stl":
export::stl(filename, [x, y, z], u = 0 .. 2*PI, v = 0 .. PI,
             OutputBox = [-1 .. 1, -1 .. 1, -3 .. 3],
             Scaling = Constrained):
```

```
plot(plot::SurfaceSTL(filename,
```

```
Scaling = Constrained,  
MeshVisible))
```

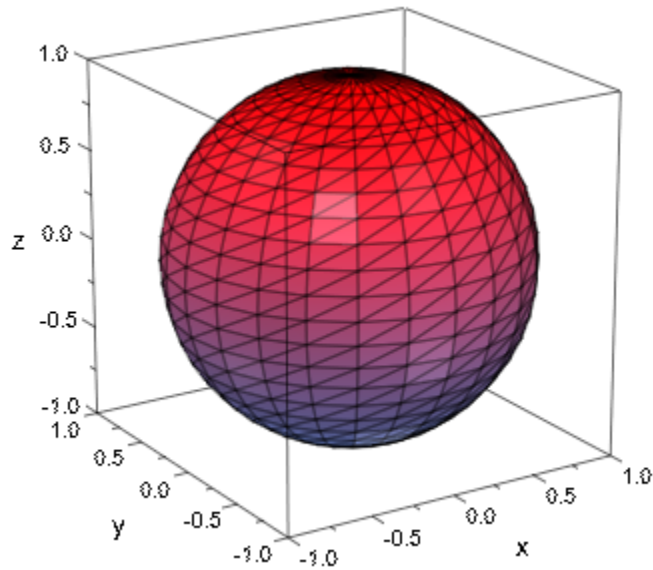

With `Scaling = Unconstrained`, the sphere is deformed to an ellipsoid filling the output box:

```
export::stl(filename, [x, y, z], u = 0..2*PI, v = 0..PI,  
            OutputBox = [-1..1, -1..1, -3..3],  
            Scaling = Unconstrained):
```

```
plot(plot::SurfaceSTL(filename,  
                    Scaling = Constrained,  
                    MeshVisible))
```

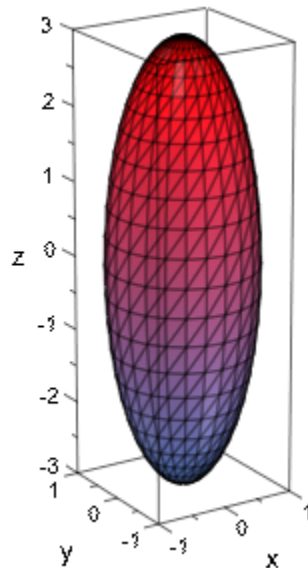

delete *x*, *y*, *z*, *filename*, DIGITS:

## Parameters

### **filename**

A file name: a non-empty character string on page 7-53

### **n**

A file descriptor provided by `fopen`: a positive integer

### **object<sub>1</sub>, object<sub>2</sub>, ...**

3D graphical objects of the `plot` library

### **x, y, z**

The coordinate functions: arithmetical expressions (Symbolic Math Toolbox) or piecewise objects depending on the surface parameters  $u$  and  $v$ . Alternatively,

procedures on page 1-1654 that accept 2 input parameters  $u$ ,  $v$  and return a numerical value when the input parameters are numerical.

### **u**

The first surface parameter: an identifier on page 7-29 or an indexed identifier on page 1-1017.

$u_{\min}$  ..  $u_{\max}$

The range for the parameter  $u$ :  $u_{\min}$ ,  $u_{\max}$  must be numerical real values.

### **v**

The second surface parameter: an identifier on page 7-29 or an indexed identifier on page 1-1017.

$v_{\min}$  ..  $v_{\max}$

The range for the parameter  $v$ :  $v_{\min}$ ,  $v_{\max}$  must be numerical real values.

## **Options**

### **Mesh**

Option, specified as `Mesh = [nu, nv]`

Sets the mesh size: the integer  $n_u$  determines, how many equidistant points in the  $u$  direction are used to sample the parametrization  $x$ ,  $y$ ,  $z$  numerically. Correspondingly, the integer  $n_v$  determines, how many equidistant points in the  $v$  direction are used. Thus, a regular mesh of  $(n_u - 1)(n_v - 1)$  rectangles is used. Each rectangle is split into 2 triangles, resulting in a triangulation consisting of  $2(n_u - 1)(n_v - 1)$  triangles. The default is `Mesh = [25, 25]`.

### **OutputBox**

Option, specified as `OutputBox = [xmin .. xmax, ymin .. ymax, zmin .. zmax]`

By default, the coordinates of the mesh points defining the STL object are written into the file as provided by the parametrization of the surface. Thus, if several objects are written

into the file via the option `Append`, the position of the objects in space is transparent and can be controlled by the user via a suitable parametrization. However, many devices such as Rapid Prototyping tools with which the STL file shall be processed, impose severe restrictions on the data in the STL file. E.g., the original STL specification requires that the  $x, y, z$  coordinates of the mesh points are positive. Many devices require that the coordinates must lie in a prescribed range (between 0 and 100, say). The option `OutputBox` provides a simple mean to shift and scale the coordinates given by the parametrization to a prescribed range.

The option `OutputBox = [ xmin .. xmax, ymin .. ymax, zmin .. zmax]` sets the output box defined by numerical values  $x_{\min}, \dots, z_{\max}$ . The mathematical coordinates  $x(u, v), y(u, v), z(u, v)$  with  $u, v$  ranging from  $u_{\min}$  to  $u_{\max}$  and from  $v_{\min}$  to  $v_{\max}$ , respectively, are shifted and scaled such that the output coordinates written to the STL file range between the values  $x_{\min}$  and  $x_{\max}, y_{\min}$  and  $y_{\max}, z_{\min}$  and  $z_{\max}$ .

---

**Note** If several objects are written to the file via the option `Append`, only the very last call of `export::stl` should bear the option `OutputBox`!

---

This last call shifts and scales all coordinates of all surfaces inside the file such that the entire scene of objects fits into the output box. The relative size and positions of the objects are preserved.

See “Example 3” on page 8-10 (Symbolic Math Toolbox).

This option is rather expensive since all data in the STL file need to be modified!

This option is not available if the file was opened outside `export::stl` and passed by a file descriptor  $n$ .

## Scaling

Option, specified as `Scaling = Unconstrained` or `Scaling = Constrained`

With `Scaling = Unconstrained`, the surface is scaled by different factors in the  $x, y$ , and  $z$  direction, such that it fills the output box set by the option `OutputBox = [xmin .. xmax, ymin .. ymax, zmin .. zmax]`. Thus, the output coordinates of a sphere define an ellipsoid with diameters given by the side lengths of the output box. This is the default setting.

With `Scaling = Constrained`, the surface is scaled by the same factor in the  $x, y$ , and  $z$  direction such that it fits into the output box set by the option `OutputBox =`

[`x\_{min}` .. `x\_{max}` , `y\_{min}` .. `y\_{max}` , `z\_{min}` .. `z\_{max}` ] . A sphere will remain a sphere even if the sides of the output box have different lengths.

This option is ignored if not used in conjunction with the `OutputBox` option.

### **Ascii, Bin, Binary, Raw, Text**

With the synonymous flags `Bin`, `Binary`, or `Raw`, respectively, the STL file is created as a binary file. If a binary file is specified by a file descriptor `n`, make sure that it was opened by the command `n:= fopen(filename, Write, Raw)`. With the synonymous flags `Text` and `Ascii`, respectively, the STL file is created as a text file. The default is `Bin`.

### **Append**

With this flag, the STL data of the surface are appended to an existing STL file named "filename". If no such file exists, it is created and processed as without `Append`. This option is not available if the file was opened outside `export::stl` and passed by a file descriptor `n`.

## **Return Values**

`null()` object.

## **Algorithms**

There are two storage formats available for STL files, which are ASCII and BINARY. ASCII files are human-readable while BINARY files are smaller and faster to process. Both ASCII as well as BINARY files can be generated by `export::stl`. A typical ASCII STL file looks like this:

```
solid sample
facet normal -4.470293E-02 7.003503E-01 -7.123981E-01
  outer loop
    vertex -2.812284E+00 2.298693E+01 0.000000E+00
    vertex -2.812284E+00 2.296699E+01 -1.960784E-02
    vertex -3.124760E+00 2.296699E+01 0.000000E+00
  endloop
```

```

    endfacet
    ...
endsolid sample

```

STL BINARY files have the following format:

Bytes	Type	Description
80	ASCII	header, no data significance
4	uint	number of facets in file
4	float	normal x - start of facet
4	float	normal y
4	float	normal z
4	float	vertex1 x
4	float	vertex1 y
4	float	vertex1 z
4	float	vertex2 x
4	float	vertex2 y
4	float	vertex2 z
4	float	vertex3 x
4	float	vertex3 y
4	float	vertex3 z
2	byte	not used - end of facet
	...	

**Facet orientation:** The facets define the surface of a 3D object. As such, each facet is part of the boundary between the interior and the exterior of the object. The orientation of the facets (which way is "out" and which way is "in") is specified redundantly in two ways which should be consistent. First, the direction of the normal is outward. Second, which is most commonly used nowadays, the facet vertices are listed in counter-clockwise order when looking at the object from the outside (right-hand rule).

**Vertex-to-vertex rule:** Each triangle must share two vertices with each of its adjacent triangles. In other words, a vertex of one triangle cannot lie on the side of another.

**Axes:** The format specifies that all vertex coordinates must be strictly positive numbers. However, it seems that - with a few exceptions - most software used today (MuPAD included) allow negative coordinates as well.

**Units:** The STL file does not contain any scale information; the coordinates may be interpreted in arbitrary units.

Further details about the STL file format are available in the web, e.g., at:

- [www.ennex.com/fabbers/StL.asp](http://www.ennex.com/fabbers/StL.asp),
- [www.math.iastate.edu/burkardt/data/stl/stl.html](http://www.math.iastate.edu/burkardt/data/stl/stl.html) and
- [rpdrc.ic.polyu.edu.hk/content/stl/stl\\_introduction.htm](http://rpdrc.ic.polyu.edu.hk/content/stl/stl_introduction.htm).

Collections of STL sample files can be found in the web, e.g., at:

- [www.wohlersassociates.com/Software-for-Rapid-Prototyping.html](http://www.wohlersassociates.com/Software-for-Rapid-Prototyping.html) and
- [www.cs.duke.edu/~edels/Tubes](http://www.cs.duke.edu/~edels/Tubes).

Information about rapid prototyping technologies is available in the web, e.g., at:

[www.cs.hut.fi/~ado/rp/rp.html](http://www.cs.hut.fi/~ado/rp/rp.html).

## See Also

### **MuPAD Functions**

`READPATH` | `WRITEPATH` | `fclose` | `fopen`

### **MuPAD Graphical Primitives**

`plot::SurfaceSTL`



# fp - Functional Programming

---

## fp::apply

Apply function to arguments

### Syntax

```
fp::apply(f, <e, ...>)
```

### Description

fp::apply(f, a) returns f(a).

fp::apply applies the function f to the arguments given by e, ....

### Environment Interactions

Same side effects as when calling f(e, ...) directly.

### Examples

#### Example 1

Apply the function f to x and y:

```
fp::apply(f, x, y)
```

*f(x, y)*

#### Example 2

Apply the functions of the first list to the arguments given by the second list:

```
zip([sin, cos], [x, y], fp::apply)
```

`[sin(x), cos(y)]`

## Parameters

**f**

Function

**e**

Object used as argument

## Return Values

Result of the function call `f(e, ...)`.

## fp::bottom

Function that never returns

### Syntax

```
fp::bottom()
```

### Description

fp::bottom() never returns because it raises an error.

### Environment Interactions

Raises an error in any case.

### Examples

#### Example 1

Calling fp::bottom is equivalent to calling error with a fixed error string:

```
fp::bottom()
```

```
Error: Reached bottom. [fp::bottom]
```

fp::bottom is used to indicate the bottom of a recursion inside a traperror call. In most cases, programs not using fp::bottom will be more readable.

## **Return Values**

This function never returns.

## fp::curry

Curry an n-ary function

### Syntax

```
fp::curry(f, <n>)
```

### Description

`fp::curry(f)` returns the higher-order function  $x \rightarrow (y \rightarrow f(x, y))$ .

`fp::curry` returns the curried version of the n-ary function `f`. If no arity `n` is given, then the function is assumed to be binary.

If `n` is smaller than 2 then `f` is returned. Otherwise, given a `n`-ary function `f`, `fp::curry` returns the function  $x_1 \rightarrow ((x_2, \dots, x_n) \rightarrow f(x_1, \dots, x_n))$

### Examples

#### Example 1

Create curried versions of binary and 3-ary functions:

```
cf := fp::curry(f):  
cf(x)(y)
```

$f(x, y)$

```
cg := fp::curry(g, 3):  
cg(x)(y)(z)
```

$g(x, y, z)$

## Example 2

A curried version of `_plus` may be used to create a function which increments its argument by 1:

```
inc := fp::curry(_plus)(1):  
inc(x)
```

$x + 1$

## Parameters

**f**

*n*-ary function

**n**

Nonnegative integer

## Return Values

Unary higher-order function.

## fp::expr\_unapply

Create a functional expression from an expression

### Syntax

```
fp::expr_unapply(e, <x, ...>)
```

### Description

`fp::expr_unapply(e, x)` tries to interpret the expression `e` as a function in `x` and to return a functional expression computing that function.

`fp::expr_unapply` views the expression `e` as a function in the indeterminates `x, ...` and tries to return a functional expression computing that function. If `fp::expr_unapply` cannot find a functional expression FAIL is returned.

If no indeterminates are given, any indeterminates of `e` found by `indets` are used.

### Examples

#### Example 1

Get the functional expression computing `sin(x)`:

```
fp::expr_unapply(sin(x), x)
```

```
sin
```

```
fp::expr_unapply(sin(x[1]), x[1])
```

```
sin
```



## Example 2

Get the functional expression computing  $\sin(x)^2 + \cos(x)^2$ :

```
fp::expr_unapply(sin(x)^2 + cos(x)^2)
```

$\sin^2 + \cos^2$

## Parameters

**e**

Expression

**x**

Identifier or indexed identifier

## Return Values

Functional expression or FAIL.

## See Also

### MuPAD Functions

fp::unapply

## fp::fixargs

Create function by fixing all but one argument

### Syntax

```
fp::fixargs(f, n, <e, ...>)
```

### Description

`fp::fixargs(f, l, y)` returns the function  $x \rightarrow f(x, y)$ .

`fp::fixargs` returns an unary function, defined by fixing all but the  $n$ -th argument of the function  $f$  to the values given by  $e \dots$ .

Thus, given a  $m$ -ary function  $f$  and  $m - 1$  values  $e_1, \dots, e_{m-1}$ , `fp::fixargs` returns the function

$$x \rightarrow f(e_1, \dots, e_{n-1}, x, e_n, \dots, e_{m-1})$$

### Examples

#### Example 1

Fix the first and third argument of  $f$  to  $x1$  and  $x3$ :

```
fp::fixargs(f, 2, x1, x3)(y)
```

```
 $f(x1, y, x3)$ 
```

## Example 2

Create a function which increments its argument by one:

```
inc := fp::fixargs(_plus, 1, 1):  
inc(x)
```

$x + 1$

## Example 3

Create a function which tests the identifier  $x$  for a type:

```
type_of_x := fp::fixargs(testtype, 2, x):  
map([DOM_INT, DOM_IDENT], type_of_x)
```

[FALSE, TRUE]

## Parameters

**f**

Function

**n**

Positive integer defining free argument

**e**

Object used as fixed argument

## Return Values

Unary function.

## fp::fixedpt

Returns fixed point of a function

### Syntax

```
fp::fixedpt(f)
```

### Description

`fp::fixedpt(f)` returns the fixed point of the unary function `f`.

`fp::fixedpt` is implemented as the *Y* combinator which is defined as follows:

$$Y: f \rightarrow g(f)(g(f))$$

where the function *g* is defined as

$$g: f \rightarrow h \rightarrow x \rightarrow f(h(h))(x)$$

### Examples

#### Example 1

A function computing the Fibonacci numbers is created as a fixed point:

```
fb2 := (f,n) -> if n <= 2 then 1 else f(n-1) + f(n-2) end:  
fib := fp::fixedpt(fp::curry(fb2)):  
fib(i) $ i=1..9
```

1, 1, 2, 3, 5, 8, 13, 21, 34

## Parameters

**f**

Unary function

## Return Values

Unary function.

## fp::fold

Create function which iterates over sequences

### Syntax

```
fp::fold(f, <e, ...>)
```

### Description

`fp::fold` returns a function which repeatedly applies `f` to sequences of arguments, where the expressions `e...` are used as starting values.

Thus, given the function  $f$  and the starting values  $e_1, \dots, e_n$ , `fp::fold` returns the function which is defined by

$$(x_1, x_2, \dots, x_m) \rightarrow f(x_m, \dots, f(x_2, f(x_1, e_1, \dots, e_n))) \dots$$

for any positive integer  $m$ . If the argument sequence is void (i.e.  $m = 0$ ) the function simply returns the sequence  $(e_1, \dots, e_n)$ .

### Examples

#### Example 1

A call to `fp::fold` returns a function, which accepts an arbitrary number of arguments:

```
fp::fold(f, x)(y1, y2, y3)
```

```
f(y3, f(y2, f(y1, x)))
```

## Example 2

The function `pset` returns the power set of the set given by its arguments:

```
addelem := (x,y) -> y union map(y, _union, {x}):  
pset := fp::fold(addelem, {{}}):  
pset(a,b,c)
```

```
{∅, {c}, {a}, {b}, {b, c}, {a, b}, {a, c}, {a, b, c}}
```

## Parameters

**f**

Function

**e**

Object used as starting value

## Return Values

Function.

## fp::nest

Repeated composition of function

### Syntax

```
fp::nest(f, n)
```

### Description

`fp::nest(f, n)` returns the  $n$ -fold repeated composition of the function  $f$ .

Thus, given the function  $f$ , `fp::nest` returns the identity function `id` if  $n$  is 0 and otherwise the function

$$f(f(\dots f(x)\dots))$$

$n$ -fold repeated.

Note that `fp::nest` is obsolete, one should use the `@@` operator or its functional form `_fnest` instead. It is only supported for compatibility with former versions of MuPAD.

### Examples

#### Example 1

Apply the 3-fold repeated composition of  $f$  to  $x$ :

```
fp::nest(f, 3)(x)
```

$$f(f(f(x)))$$



## Example 2

Numerically finding a fixed point of the function `cos` by repeated application:

```
p :=fp::nest(cos, 100)(1.0):  
p, cos(p)
```

```
0.7390851332, 0.7390851332
```

## Parameters

**f**

Function

**n**

Nonnegative integer

## Return Values

Function.

## See Also

### MuPAD Functions

`_fconcat` | `_fnest` | `fp::nestvals`

## fp::nestvals

Repeated composition returning intermediate values

### Syntax

```
fp::nestvals(f, n)
```

### Description

`fp::nestvals(f, n)` returns a function which applies the function `f` `n`-fold repeatedly to its argument and returns the intermediate `n + 1` values as a list.

Thus `fp::nestvals` returns the function `[x, f(x), ..., f(f(...f(x)...))]`

The function returned is equivalent to `[_fnest(f, i) $i=0..n]`, but more efficient.

### Examples

#### Example 1

Apply `f` 3 times nested to `x`:

```
fp::nestvals(f, 3)(x)
```

```
[x, f(x), f(f(x)), f(f(f(x)))]
```

#### Example 2

Apply `cos` 4 times nested to `1.0` and return the result and intermediate values:

```
fp::nestvals(cos, 4)(1.0)
```

```
[1.0, 0.5403023059, 0.8575532158, 0.6542897905, 0.7934803587]
```

## Parameters

**f**

Function

**n**

Nonnegative integer

## Return Values

Function.

## See Also

**MuPAD Functions**

`_fconcat` | `_fnest`

## fp::unapply

Create a procedure from an expression

### Syntax

```
fp::unapply(e, <x, ...>)
```

### Description

fp::unapply views the expression e as a function in the indeterminates x, ... and returns a procedure computing that function.

If no indeterminates are given, any indeterminates of e found by indets are used.

### Examples

#### Example 1

Get the procedure computing  $\sin(x)^2 + \cos(y)^2$ :

```
s := fp::unapply(sin(x)^2 + cos(y)^2, x, y)
```

$$(x, y) \rightarrow \cos(y)^2 + \sin(x)^2$$

### Parameters

e

Expression

**x**

Identifier or indexed identifier

## **Return Values**

Procedure.

## **Overloaded By**

e

## **See Also**

### **MuPAD Functions**

fp::expr\_unapply



# **generate - Generate Input to Other Programs**

---

## generate::C

Generate C formatted string

### Syntax

```
generate::C(e, <NoWarning>)
```

### Description

`generate::C(e)` generates C code for the MuPAD expression `e`.

`generate::C` returns a C formatted string representing an expression, equation, list of equations or a matrix.

An equation represents an assignment in C code. The type of the assignment is `double`.

When generating C code for a matrix, the generator assigns only nonzero elements. See “Example 3” on page 10-3 (Symbolic Math Toolbox).

To print an output string to a file, use the `fprint` function. Use the printing option `Unquoted` to remove quotation marks and to expand special characters like line breaks and tabs.

Use the `generate::optimize` function to optimize the MuPAD code before converting it to C code. See “Example 5” on page 10-4 (Symbolic Math Toolbox).

The `NoWarning` option lets you suppress warnings. See “Example 6” on page 10-4 (Symbolic Math Toolbox).

## Examples

### Example 1

The code generator converts a list of equations to a sequence of assignments:



```
generate::C([x1 = y2^2*(y1 + sin(z)), x2 = tan(x1^4)]):
print(Unquoted, %)
```

```
x1 = (y2*y2)*(y1+sin(z));
x2 = tan(x1*x1*x1*x1);
```

## Example 2

MuPAD matrix and array indexing differs from C array indexing. By default, MuPAD array indices start with 1, and C array indices start with 0. To create the code compatible with the default indexing in C, the `generate::C` function decrements each index by one:

```
A:= matrix([[1,2],[3,4]]):
generate::C(A)."\n".
  generate::C(hold(Determinante = A[1,1]*A[2,2] - A[1,2]*A[2,1]]):
print(Unquoted, %)
```

```
A[0][0] = 1.0;
A[0][1] = 2.0;
A[1][0] = 3.0;
A[1][1] = 4.0;
```

```
Determinante = A[0][0]*A[1][1]-A[0][1]*A[1][0];
```

## Example 3

Generated C code does not include assignments for zero elements of a matrix:

```
A:= matrix([[1, 0, 0],[0, 0, 1]]):
print(Unquoted, generate::C(A))
```

```
A[0][0] = 1.0;
A[1][2] = 1.0;
```

## Example 4

If the first index of an array is not 1, the `generate::C` function issues a warning:

```
A:= array(1..2, 2..3, [[1,2],[3,4]]):
print(Unquoted, generate::C(A))
```

Warning: Array index 'A[1..2, 2..3]' out of range 1..n.

```
A[0][1] = 1.0;
A[0][2] = 2.0;
A[1][1] = 3.0;
A[1][2] = 4.0;
```

## Example 5

The `generate::C` function does not optimize your code:

```
print(Unquoted,
      generate::C([x = a + b, y = (a + b)^2])):
```

```
x = a+b;
y = pow(a+b,2.0);
```

You can use the `generate::optimize` function before converting your MuPAD expression to C code. For example, this function can reduce the number of operations by finding common subexpressions:

```
print(Unquoted,
      generate::C(
        generate::optimize([x = a + b, y = (a + b)^2])
      )):
```

```
x = a+b;
y = x*x;
```

## Example 6

By default, the `generate::C` function can issue warnings:

```
print(Unquoted, generate::C(f(x)))
```

Warning: Function 'f' not verified to be a valid C function.

```
t0 = f(x);
```

If you started using `generate::C` recently, the warnings can help you identify the potential issues in the converted code. If you want to suppress warnings, use the `NoWarning` option:

```
print(Unquoted, generate::C(f(x), NoWarning))

t0 = f(x);
```

## Parameters

**e**

An expression, equation, list of equations, or a matrix

## Options

**NoWarning**

Suppress warnings.

## Return Values

`generate::C` returns a string on page 7-53 containing C code.

## See Also

**MuPAD Functions**

`fprint` | `generate::optimize` | `print`

## **generate::fortran**

Generate Fortran formatted string

### **Syntax**

```
generate::fortran(e, <NoWarning>, <Version = "versionName">)
```

### **Description**

`generate::fortran(e)` generates Fortran code for the MuPAD expression `e`.

`generate::fortran` returns a Fortran formatted string representing an expression, equation, list of equations, or a matrix.

An equation represents an assignment in Fortran code. The type of the assignment is `double`.

When generating Fortran code for a matrix, the generator assigns only nonzero elements. See "Example 2" on page 10-7 (Symbolic Math Toolbox).

To print an output string to a file, use the `fprint` function. To remove quotation marks and to expand special characters like line breaks and tabs, use the printing option `Unquoted`.

Use the `generate::optimize` function to optimize the MuPAD code before converting it to Fortran code. See "Example 4" on page 10-8 (Symbolic Math Toolbox).

The `NoWarning` option lets you suppress warnings. See "Example 5" on page 10-8 (Symbolic Math Toolbox).

The `Version` option specifies the target version of the Fortran compiler that `generate::fortran` uses to generate code. The options are `Fortran77` (default), `Fortran90`, and `Fortran95`. See "Example 6" on page 10-9 (Symbolic Math Toolbox).

## Examples

### Example 1

The code generator converts a list of equations to a sequence of assignments.

```
generate::fortran([x[1] = y[2 + i]^2*(y[1] + sin(z)),
                  x[2] = tan(x[1]^4)]):
print(Unquoted,%)
```

```
x(1) = (sin(z)+y(1))*y(i+2)**2
x(2) = tan(x(1)**4)
```

### Example 2

Generated Fortran code does not include assignments for zero elements of a matrix.

```
A:= matrix([[1, 0, 0],[0, 0, 1]]):
print(Unquoted, generate::fortran(A))
```

```
A(1,1) = 1.0D0
A(2,3) = 1.0D0
```

### Example 3

If the first index of an array is not 1, then the `generate::fortran` function issues a warning.

```
A:= array(1..2, 2..3, [[1,2],[3,4]]):
print(Unquoted, generate::fortran(A))
```

```
Warning: Array index 'A[1..2, 2..3]' out of range 1..n.
```

```
A(1,2) = 1.0D0
A(1,3) = 2.0D0
A(2,2) = 3.0D0
A(2,3) = 4.0D0
```

## Example 4

The `generate::fortran` function does not optimize your code.

```
print(Unquoted,
      generate::fortran([x = a + b, y = (a + b)^2])):

x = a+b
y = (a+b)**2
```

You can use the `generate::optimize` function before converting your MuPAD expression to Fortran code. For example, this function can reduce the number of operations by finding common subexpressions.

```
print(Unquoted,
      generate::fortran(
        generate::optimize([x = a + b, y = (a + b)^2])
      )):

x = a+b
y = x**2
```

## Example 5

By default, the `generate::fortran` function can issue warnings.

```
print(Unquoted, generate::fortran(gamma(x)))
```

Warning: Function 'gamma' requires a Fortran2008 compiler.

```
t0 = gamma(x)
```

Warnings help identify potential issues in converted code. To suppress warnings, use the `NoWarning` option.

```
print(Unquoted, generate::fortran(gamma(x), NoWarning))
```

```
t0 = gamma(x)
```

If the warning specifies that the compiler required is either Fortran90 or Fortran95, then you can suppress the warning by specifying the correct compiler version using `Version`. For example, the `ceiling` function requires Fortran90 instead of the default Fortran77.

```
generate::fortran(ceiling(x))
```

Warning: Function 'ceiling' requires a Fortran90 compiler.

```
"  t0 = ceiling(x)"
```

Specify `Version` as `Fortran90`. The `generate::fortran` function does not issue a warning.

```
generate::fortran(ceiling(x), Version = "Fortran90")
```

```
"  t0 = ceiling(x)"
```

## Example 6

By default, the `generate::fortran` function uses the target Fortran version Fortran77 to generate code. To specify Fortran90 or Fortran95 as the target version, use the `Version` option.

Generate output for the Fortran90 compiler by specifying the `Version` option as Fortran90.

```
f := expand((x+1)^20):
fcode90 := generate::fortran(f, Version = "Fortran90"):
print(Unquoted, fcode90)
```

```
  t0 = x*2.0D1+x**2*1.9D2+x**3*1.14D3+x**4*4.845D3+x**5*1.5504D4+x**6*
&3.876D4+x**7*7.752D4+x**8*1.2597D5+x**9*1.6796D5+x**10*1.84756D5&
&+x**11*1.6796D5+x**12*1.2597D5+x**13*7.752D4+x**14*3.876D4+x**15*1&
&.5504D4+x**16*4.845D3+x**17*1.14D3+x**18*1.9D2+x**19*2.0D1+x**20+1&
&.0D0
```

The code formatting for multiline statements in Fortran90 differs from the formatting in the default target of Fortran77.

## Parameters

**e**

An expression, equation, list of equations, or a matrix

## Options

### **NoWarning**

Suppress warnings.

### **Version**

Specify the Fortran compiler version. The default version is Fortran77. The Version values are Fortran77, Fortran90, and Fortran95. For example, `generate::fortran(..., Version = "Fortran90")` uses compiler version Fortran90.

## Return Values

`generate::fortran` returns a string on page 7-53 containing Fortran code.

## See Also

### **MuPAD Functions**

`fprint` | `generate::optimize` | `print`



# generate::MATLAB

Generate MATLAB formatted string

## Syntax

`generate::MATLAB(e, <NoWarning>)`

## Description

`generate::MATLAB(e)` generates MATLAB code for the MuPAD expression `e`.

`generate::MATLAB` returns a MATLAB formatted string representing an expression, equation, list of equations or a matrix.

`generate::MATLAB` assumes that the type of converted data is `double`. See “Example 1” on page 10-12 (Symbolic Math Toolbox).

An equation represents an assignment in MATLAB code. See “Example 4” on page 10-13 (Symbolic Math Toolbox).

When generating MATLAB code for a matrix, the generator produces a matrix of zeros, and then it substitutes nonzero elements. See “Example 2” on page 10-12 (Symbolic Math Toolbox).

Use the `generate::optimize` function to optimize the MuPAD code before converting it to the MATLAB syntax. See “Example 5” on page 10-13 (Symbolic Math Toolbox).

To display generated MATLAB code on screen, use the `print` function. Use the printing option `Unquoted` to remove quotation marks and to expand special characters like line breaks and tabs. If a generated code line is longer than the `TEXTWIDTH` setting, the `print` function breaks that line into several shorter lines. The inserted line continuation character (`\`) is not valid in MATLAB. To avoid inserting line continuation characters, increase the `TEXTWIDTH` setting or use the `fprint` function to write generated code to a file.

`generate::MATLAB` does not create a MATLAB function. You can print an output string to a file using the `fprint` function with the `Unquoted` option. See “Example 6” on page 10-14 (Symbolic Math Toolbox).

Working from the MATLAB workspace you can create a MATLAB function containing your expression. To call the MuPAD expression from the MATLAB workspace, use `evalin` or `feval` functions. See “Create MATLAB Functions from MuPAD Expressions” (Symbolic Math Toolbox).

If you work with the Simulink® products, you can copy the generated code and paste it into a Simulink block. Also, you can call the MuPAD expression from the MATLAB workspace using `evalin` or `feval` functions. Working from the MATLAB workspace you can automatically create a Simulink block containing your expression. See “Create MATLAB Function Blocks from MuPAD Expressions” (Symbolic Math Toolbox).

The `NoWarning` option lets you suppress warnings. See “Example 7” on page 10-14 (Symbolic Math Toolbox).

## Examples

### Example 1

By default, MATLAB stores all numeric values as double-precision floating-point. In accordance with the default MATLAB data type, `generate::MATLAB` converts the elements of expressions, equations, and matrices to the `double` format:

```
print(Unquoted, generate::MATLAB(x^2 + y/3 + 1/6))
```

```
t0 = y/3.0+x^2+1.0/6.0;
```

### Example 2

The generator produces a matrix of zeros, and then it replaces nonzero elements:

```
A:= matrix([[1, 0, 0],[0, 0, 1]]):  
print(Unquoted, generate::MATLAB(A))
```

```
A = reshape([1.0,0.0,0.0,0.0,0.0,0.0,1.0],[2,3]);
```

### Example 3

If the first index of an array is not 1, the `generate::MATLAB` function issues a warning:

```
A:= array(1..2, 2..3, [[1,2],[3,4]]):
print(Unquoted, generate::MATLAB(A))
```

```
Warning: Array index 'A[1..2, 2..3]' out of range 1..n.
```

```
A = reshape([1.0,3.0,2.0,4.0],[2,2]);
```

### Example 4

When generating MATLAB code from equations, you get assignments instead of equations. For example, generate MATLAB code for the following list of equations:

```
f := generate::MATLAB([x = exp(t*s), y = sin(t)*cos(s)]):
print(Unquoted, f)
```

```
x = exp(s*t);
y = cos(s)*sin(t);
```

### Example 5

The `generate::MATLAB` function does not optimize your code:

```
print(Unquoted,
      generate::MATLAB([x = a + b, y = (a + b)^2])):
```

```
x = a+b;
y = (a+b)^2;
```

You can use the `generate::optimize` function before converting your MuPAD code to MATLAB syntax. For example, this function can reduce the number of operations by finding common subexpressions:

```
f := generate::optimize([x = a + b, y = (a + b)^2]):
print(Unquoted,
      generate::MATLAB(f)):
```

```
x = a+b;  
y = x^2;
```

## Example 6

To create a file with a MATLAB formatted string representing a symbolic expression, use the `fprint` function:

```
A:= matrix([[1, 0, 0],[0, 0, 1]]):  
fprint(Unquoted, Text, "matrixA.m", generate::MATLAB(A))
```

If the file `matrixA.m` already exists, `fprint` replaces the existing MATLAB code with the converted symbolic expression. You can open and edit the resulting file.

## Example 7

By default, the `generate::MATLAB` function can issue warnings:

```
print(Unquoted, generate::MATLAB(g(x)))
```

```
Warning: Function 'g' not verified to be a valid MATLAB function.
```

```
t0 = g(x);
```

If you started using `generate::MATLAB` recently, the warnings can help you identify the potential issues in the converted code. If you want to suppress warnings, use the `NoWarning` option:

```
print(Unquoted, generate::MATLAB(g(x), NoWarning))
```

```
t0 = g(x);
```

## Parameters

**e**

An expression, equation, list of equations, or a matrix

## Options

### NoWarning

Suppress warnings.

## Return Values

generate::MATLAB returns a string on page 7-53 containing MATLAB code.

## See Also

### MuPAD Functions

fprint | generate::Simscape | generate::optimize | print

## generate::MathML

Generate MathML from expressions

### Syntax

```
generate::MathML(expr, options)
```

### Description

`generate::MathML(expr)` returns the MathML code representing `expr`. To print this code to a file, use `fprint`.

### Examples

#### Example 1

Generate the MathML code from the following expression. Use `hold` to prevent evaluation of the integral. By default, `generate::MathML` returns both Presentation and Content MathML, and includes annotations.

```
generate::MathML(hold(int)(exp(x^2)/x, x))
```

```
<math xmlns='http://www.w3.org/1998/Math/MathML'>
  <semantics>
    <mrow>
      <mo form='prefix'>&Integral;</mo>
    <mrow/>
    <mfrac>
      <msup>
        <mo>&ee;</mo>
      <msup>
        <mi>x</mi>
        <mn>2</mn>
      </msup>
    </mfrac>
  </semantics>
</math>
```

```

        </msup>
        <mi>x</mi>
    </mfrac>
    <mo form='infix'>&DifferentialD;</mo>
    <mi>x</mi>
</mrow>
<annotation-xml encoding='MathML-Content'>
  <apply>
    <int/>
    <bvar>
      <ci>x</ci>
    </bvar>
    <apply>
      <divide/>
      <apply>
        <exp/>
        <apply>
          <power/>
          <ci>x</ci>
          <cn type='integer'>2</cn>
        </apply>
      </apply>
    </apply>
  </apply>
</annotation-xml>
<annotation encoding='MuPAD'>
  int(exp(x^2)/x, x)
</annotation>
</semantics>
</math>

```

## Example 2

Show only the Presentation MathML part of the output by setting Content to FALSE.

```
generate::MathML(hold(int)(exp(x^2)/x, x),
                 Content = FALSE)
```

```

<math xmlns='http://www.w3.org/1998/Math/MathML'>
  <semantics>
    <mrow>
      <mo form='prefix'>&Integral;</mo>

```

```
<mrow/>
<mfrac>
  <msup>
    <mo>&ee;</mo>
    <msup>
      <mi>x</mi>
      <mn>2</mn>
    </msup>
  </msup>
  <mi>x</mi>
</mfrac>
<mo form='infix'>&DifferentialD;</mo>
<mi>x</mi>
</mrow>
<annotation encoding='MuPAD'>
  int(exp(x^2)/x, x)
</annotation>
</semantics>
</math>
```

Show only the Content MathML part of the output by setting Presentation to FALSE.

```
generate::MathML(hold(int)(exp(x^2)/x, x),
                 Presentation = FALSE)
```

```
<math xmlns='http://www.w3.org/1998/Math/MathML'>
  <semantics>
    <apply>
      <int/>
      <bvar>
        <ci>x</ci>
      </bvar>
      <apply>
        <divide/>
        <apply>
          <exp/>
          <apply>
            <power/>
            <ci>x</ci>
            <cn type='integer'>2</cn>
          </apply>
        </apply>
      <ci>x</ci>
    </apply>
  </semantics>
</math>
```



```

</apply>
<annotation encoding='MuPAD'>
  int(exp(x^2)/x, x)
</annotation>
</semantics>
</math>

```

Suppress annotations by setting `Annotation` to `FALSE`.

```

generate::MathML(hold(int)(exp(x^2)/x, x),
  Annotation = FALSE)

```

```

<math xmlns='http://www.w3.org/1998/Math/MathML'>
  <semantics>
    <mrow>
      <mo form='prefix'>&Integral;</mo>
      <mrow/>
        <mfrac>
          <msup>
            <mo>&ee;</mo>
            <msup>
              <mi>x</mi>
              <mn>2</mn>
            </msup>
          </msup>
          <mi>x</mi>
        </mfrac>
        <mo form='infix'>&DifferentialD;</mo>
        <mi>x</mi>
      </mrow>
      <annotation-xml encoding='MathML-Content'>
        <apply>
          <int/>
          <bvar>
            <ci>x</ci>
          </bvar>
          <apply>
            <divide/>
            <apply>
              <exp/>
              <apply>
                <power/>
                <ci>x</ci>
                <cn type='integer'>2</cn>
              </apply>
            </apply>
          </apply>
        </annotation-xml>
      </semantics>
    </math>

```

```
        </apply>
      </apply>
    <ci>x</ci>
  </apply>
</apply>
</annotation-xml>
</semantics>
</math>
```

### Example 3

Generate MathML code from the following expression and write the result to filename.mathml by using fprintf.

```
fprintf(Text, "filename.mathml",
        generate::MathML(hold(int)(exp(x^2)/x, x))):
```

## Parameters

### expr

Arithmetical expression

## Options

### Annotation

Option, specified as Annotation = FALSE.

Suppresses the output of annotations.

### Content

Option, specified as Content = FALSE.

Suppresses the MathML Content part of the output.

### Presentation

Option, specified as Presentation = FALSE.

Suppresses the MathML Presentation part of the output.

## Return Values

generate::MathML returns an object containing MathML code.

## Overloaded By

expr

## See Also

**MuPAD Functions**

fprint | print

## generate::optimize

Generate optimized code

### Syntax

```
generate::optimize(r)
```

### Description

`generate::optimize(r)` returns a sequence of equations representing an “optimized computation sequence” for the input expression `r`. Each equation in the sequence corresponds to an assignment of a subexpression of the input expression to a “temporary variable.” Common subexpressions are computed only once, thus reducing the total operation count.

The number of operations, namely additions (or subtractions), multiplications (or divisions) and in particular functions calls of the output is usually lower than the number of such operations of the input. This facility is useful for code generation.

### Examples

#### Example 1

In this first example, we show the effects of optimization for a simple expression:

```
generate::optimize(cos(x^2) + x^2*sin(x^2) + x^4)
```

```
[t2 = x^2, t1 = cos(t2) + t2 sin(t2) + t2^2]
```

The “blind” computation of the input expression requires 7 multiplications, 2 additions and 2 function calls. The optimized version introduces a “temporary variable” `t2` storing the subexpression `x^2` that is used to compute the final result `t1`. This reduces the total

cost to 3 multiplications, 2 additions and 2 function calls, albeit using 1 extra assignment to the temporary variable `t2`.

## Example 2

Here we repeat the exercise of the first example but with an array of expressions:

```
generate::optimize(array(1..2, 1..2, [[x^3, x^2],[x^2, x^4]]))
```

$$\left[ t2 = x^2, t1 = \begin{pmatrix} t2 \cdot x & t2 \\ t2 & t2^2 \end{pmatrix} \right]$$

The original input requires 6 multiplications. The optimized version needs only 3 multiplications and 1 extra assignment.

## Example 3

We optimize a list of equations representing a computation sequence for 3 variables `t`, `C[1]`, `C[2]`:

```
generate::optimize([t = u, C[1] = t*(u - w)^2, C[2] = 2*(u - w)^3])
```

$$\left[ t = u, t1 = u - w, t2 = t1^2, C_1 = t \cdot t2, C_2 = 2 \cdot t1 \cdot t2 \right]$$

The original computation requires 5 multiplications and 2 subtractions. The optimized version needs 4 multiplications and 1 subtraction.

Note that since these examples involve small expressions, the computational savings are slight. In the case of very large expressions, optimization can yield a considerable dividend.

## Parameters

`r`

An expression, array or list of equations

## Return Values

List of equations.

## Algorithms

A number of FORTRAN compilers provide optimizers. However, they use algorithms of complexity  $O(n^2)$  and  $O(n^3)$  where  $n$  is the size of the input expressions. For large amounts of code, these algorithms may “break.” MuPAD provides a reasonably good scalar (as in non-vectorized and non-parallelized) optimizer which is limited to common subexpression optimization and using binary powering for integer powers. It uses hashing of expressions so that given a sub-expression, it can determine in constant time if this subexpression has already occurred. This results in an overall efficiency which is of lower complexity namely,  $O(n)$  i.e. linear in the size of the input expressions to be optimized, Hence overall efficiency is not compromised by very large expressions. This does mean that not all possible optimizations are made but nonetheless a number of reductions including the exploitation of some symmetries are possible.

It should be understood that “optimization” is meant in the sense of compiler optimization. The end-result rarely corresponds to the absolute irreducible minimum number of operations - or as in the case of FORTRAN code generation, the absolute minimum of floating-point operations (FLOPS). Achieving this limit can be extremely difficult if not impossible especially for large computational sequences. Nonetheless, in a number of real-life instances, the MuPAD optimizer can yield a very useful result. Additionally, MuPAD provides symbolic manipulation tools such as `factor` which can yield additional reduction in operation costs.

In many cases of optimization, it is most often a matter of how best to pose the problem so as to fully exploit every possible symmetry or useful natural property of the given problem.

# generate::Simscape

Generate Simscape equation

## Syntax

```
generate::Simscape(e, <NoWarning>)
```

## Description

`generate::Simscape(e)` generates Simscape™ code for the MuPAD expression `e`.

Simscape software extends the Simulink product line with tools for modeling and simulating multidomain physical systems, such as those with mechanical, hydraulic, pneumatic, thermal, and electrical components. Unlike other Simulink blocks, which represent mathematical operations or operate on signals, Simscape blocks represent physical components or relationships directly. With Simscape blocks, you build a model of a system just as you would assemble a physical system. For more information about Simscape software, see “Simscape”.

You can extend the Simscape modeling environment by creating custom components. When you define a component, use the equation section of the component file to establish the mathematical relationships among a component's variables, parameters, inputs, outputs, time, and the time derivatives of each of these entities. MuPAD and Simscape software let you perform symbolic computations and use the results of these computations in the equation section. The `generate::Simscape` function translates the results of symbolic computations to Simscape language equations.

`generate::Simscape` returns a Simscape formatted string representing an expression, equation, list of expressions or equations, or a matrix.

`generate::Simscape` converts the identifier `t` to the variable `time` in the resulting Simscape code. However, the name `t` of a function call does not change during conversion. See “Example 1” on page 10-27 (Symbolic Math Toolbox) and “Example 2” on page 10-27 (Symbolic Math Toolbox).

`generate::Simscape` converts any derivative with respect to the variable `t` to the Simscape notation `x.der`, where `x` is the time-dependent variable. See “Example 3” on page 10-27 (Symbolic Math Toolbox).

`generate::Simscape` assumes that the type of converted data is `double`. See “Example 4” on page 10-28 (Symbolic Math Toolbox).

When generating Simscape code for a matrix, the generator produces a dense matrix. See “Example 5” on page 10-28 (Symbolic Math Toolbox).

Use the `generate::optimize` function to optimize the MuPAD code before converting it to the Simscape syntax. See “Example 6” on page 10-28 (Symbolic Math Toolbox).

`generate::Simscape` converts piecewise expressions to Simscape code by using the `if` statements. See “Example 7” on page 10-29 (Symbolic Math Toolbox).

The equation section of a Simscape component file supports a limited number of functions. For details and the list of supported functions, see [Simscape equations](#). If a symbolic equation contains the functions that are not available in the equation section of a Simscape component file, `generate::Simscape` cannot correctly convert these equations to Simscape equations. Such expressions do not trigger an error. The following types of expressions are prone to invalid conversion:

- Expressions with infinities
- Expressions that contain programming structures, such as loops, conditional statements (except for the `if` statement), and `map` function calls
- Expressions that contain intervals, sets, and lists

To display generated Simscape code on screen, use the `print` function. To remove quotation marks and to expand special characters like line breaks and tabs, use the printing option `Unquoted`. If a generated code line is longer than the `TEXTWIDTH` setting, the `print` function breaks that line into several shorter lines. The inserted line continuation character (`\`) is not valid in Simscape. To avoid inserting line continuation characters, increase the `TEXTWIDTH` setting or use the `fprint` function to write generated code to a file.

To write generated Simscape code to a file, use the `fprint` function with the `Unquoted` option. See “Example 8” on page 10-30 (Symbolic Math Toolbox).

The `NoWarning` option lets you suppress warnings. See “Example 2” on page 10-27 (Symbolic Math Toolbox).



## Examples

### Example 1

The `generate::Simscape` function replaces all instances of the MuPAD identifier `t` with the variable `time`. For example, convert the following equation to the Simscape equation:

```
e := A*sin(w*t) + B*cos(w*t) = 0;
print(Unquoted, generate::Simscape(e))
```

```
B*cos(time*w)+A*sin(time*w) == 0.0;
```

### Example 2

The `generate::Simscape` function does not change the function name `t` in function calls:

```
print(Unquoted, generate::Simscape([t(), t(0), t(x)]))
```

```
Warning: Function 't' not verified to be a valid Simscape function.
```

```
t();
t(0.0);
t(x);
```

This example produces a few identical warnings. If you started using `generate::Simscape` recently, warnings can help you identify potential issues in the converted code. If you want to suppress warnings, use the `NoWarning` option:

```
print(Unquoted, generate::Simscape([t(), t(0), t(x)], NoWarning))
```

```
t();
t(0.0);
t(x);
```

### Example 3

When generating Simscape code, the `generate::Simscape` function converts the derivatives with respect to the variable `t` to the Simscape notation `x.der`. Here `x` is the

time-dependent variable. For example, generate the Simscape code for the equation  $e$  that has two time-dependent variables:

```
e := x'(t) + diff(y(t), t) + 2*x + 5 = 0:  
print(Unquoted, generate::Simscape(e))
```

```
x*2.0+x.der+y.der+5.0 == 0.0;
```

## Example 4

By default, Simscape stores all numeric values as double-precision floating-point values. In accordance with this default data type, `generate::Simscape` converts the elements of expressions, equations, and matrices to the double format:

```
print(Unquoted, generate::Simscape(x^2 + y/3 + 1/6))
```

```
y/3.0+x^2+1.0/6.0;
```

## Example 5

`generate::Simscape` can generate Simscape code for a MuPAD matrix. In contrast to `generate::MATLAB` (which produces sparse matrices), the Simscape code generator produces dense matrices:

```
A:= matrix([[1, 0, 0],[0, 0, 1]]):  
print(Unquoted, generate::Simscape(A))
```

```
[  
 1.0 0.0 0.0  
 0.0 0.0 1.0  
];
```

## Example 6

The `generate::Simscape` function does not optimize your code:

```
print(Unquoted,  
      generate::Simscape([x = a + b, y = (a + b)^2])):
```

```
x == a+b;
y == (a+b)^2;
```

You can use the `generate::optimize` function before converting your MuPAD code to Simscape syntax. For example, this function can reduce the number of operations by finding common subexpressions:

```
print(Unquoted,
      generate::Simscape(
        generate::optimize([x = a + b, y = (a + b)^2])
      )):
```

```
x == a+b;
y == x^2;
```

## Example 7

The `generate::Simscape` function also accepts piecewise expressions. The function uses `if` statements when generating Simscape code for piecewise expressions. For example, the Fourier transform of the following expression is a piecewise function:

```
FT := fourier(exp(-abs(x)*abs(t))*sin(t)/t, t, s)
```

$$\left\{ \arctan\left(\frac{s+1}{|x|}\right) - \arctan\left(\frac{s-1}{|x|}\right) \text{ if } x \neq 0 \right.$$

`generate::Simscape` converts this result to a valid Simscape expression:

```
print(Unquoted, generate::Simscape(FT))
```

```
if (x ~= 0.0)
  -atan((s-1.0)/abs(x))+atan((s+1.0)/abs(x));
else
  NaN;
end
```

## Example 8

To create a text file with a Simscape formatted string representing a symbolic expression, use the `fprint` command:

```
e := x'(t) + 2*x + 5 = 0:  
fprint(Unquoted, Text, "eqn.txt", generate::Simscape(e))
```

If the file `eqn.txt` already exists, `fprint` replaces the existing Simscape code with the converted symbolic expression. You can open and edit the resulting text file.

## Parameters

**e**

An expression, equation, list of equations, or a matrix

## Options

**NoWarning**

Suppress warnings.

## Return Values

`generate::Simscape` returns a string containing Simscape code. In case of invalid conversion, the returned value is an arbitrary string.

## See Also

**MuPAD Functions**

`fprint` | `generate::MATLAB` | `generate::optimize` | `print`

# generate::TeX

Generate formatted string from expressions

## Syntax

```
generate::TeX(e)
```

## Description

`generate::TeX(e)` returns a TeX formatted string representing `e`. This string may be printed to a file using `fprint`. Use the printing option `Unquoted` to remove quotes and to expand special characters like newlines and tabs.

The output string may be used in the math-mode of TeX. Note that `generate::TeX` doesn't break large formulas into smaller ones.

## Examples

### Example 1

`generate::TeX` generates a string containing the TeX code:

```
generate::TeX(hold(int)(exp(x^2)/x, x))
```

```
"\int \frac{{\mathrm{e}}^{x^2}}{x} \,d x"
```

Use `print` with option `Unquoted` to get a more readable output:

```
print(Unquoted, generate::TeX(hold(int)(exp(x^2)/x, x)))
```

```
\int \frac{{\mathrm{e}}^{x^2}}{x} \,d x
```

## Parameters

e

An arithmetical expression

## Return Values

generate::TeX returns a string on page 7-53 containing TeX code.

## Overloaded By

e

## Algorithms

The TeX packages amsmath and amssymb are needed.

## See Also

### MuPAD Functions

fprint | print

# Graph - Graph Theory

---

## Graph::addEdges

Adds one or several edges to a graph

### Syntax

`Graph::addEdges(G, Edge)`

`Graph::addEdges(G, Edge, <EdgeWeights = ew>, <EdgeCosts = ec>, <EdgeDescriptions = ed>`

### Description

`Graph::addEdges` adds one or several edges to an already existing Graph. An edge is represented by a list containing two vertices of the graph. A warning is raised if one of the specified edges does already exist in the graph.

`Graph::addEdges(G, Edge)` adds the edge(s) `Edge` to the graph `G`. The two vertices of each edge must be vertices in the given graph. Otherwise an error is raised. If an edge is specified that already exists, a warning will be printed that this edge is not used.

With `Graph::addEdges(G, Edge, EdgeWeights=ew, EdgeCosts=ec, EdgeDescriptions=ed)` the weight, cost and description of each edge can be set to every edge additionally. If these specifications are missing, the default value 0 (=None) is assumed. If a specification is used it has to hold exactly the same number of values as there are edges. Otherwise an error will be raised.

---

**Note** The value None can be used in the specification lists for every edge that is not to be specified explicitly.

---

## Examples

### Example 1

First, an undirected graph with two vertices and no edges is created. Then two edges are added:



```
G := Graph([a, b, c, d], []):
Graph::printEdgeInformation(G):
G := Graph::addEdges(G, [[a, b], [c, d]]):
Graph::printEdgeInformation(G)
```

No edges.

Edges existing in the graph:

```
-----
[a, b], [c, d], [b, a], [d, c]
```

As you can see, [b, a] and [d, c] were inserted automatically.

```
G2 := Graph::addEdges(G, [[a, d]]):Graph::getEdges(G2)
```

```
[[a, d], [d, a], [a, b], [c, d], [b, a], [d, c]]
```

Now, what happens if an edge is inserted that already exists in the graph?

```
G := Graph::addEdges(G, [[d, c]])
```

Warning: The following edges were not used for operation: [[d, c]]. [Graph::selectEdge]

```
Graph(...)
```

Suppose, we try to insert an edge with a vertex not existing in the graph:

```
G := Graph::addEdges(G, [[a, 5]])
```

Error: One or more edges contain vertices that are not in list '[5]'. [Graph::addEdges]

Now let's see what happens when a directed graph is created:

```
G := Graph([a, b, c, d], [], Directed):
G := Graph::addEdges(G, [[a, b], [b, c], [c, d]],
                    EdgeWeights = [2/8, -5, PI],
                    EdgeCosts = [30, -40, None]):
Graph::printGraphInformation(G)
```

```
Vertices: [a, b, c, d]
Edges: [[a, b], [b, c], [c, d]]
Vertex weights: no vertex weights.
Edge descriptions: no edge descriptions.
Edge weights: [a, b] = 1/4, [b, c] = -5, [c, d] = PI (other existing edges\
  have no weight)
Edge costs: [a, b] = 30, [b, c] = -40 (other existing edges have costs zer\
  o)
Adjacency list (out): a = [b], b = [c], c = [d], d = []
Adjacency list (in): a = [], b = [a], c = [b], d = [c]
Graph is directed.
```

Have a close look at the Edge costs line. The edge [c, d] is not mentioned explicitly due to the value **None**:

```
G2 := Graph::addEdges(G, [[a, b], [a, d]], EdgeWeights=[10, 20],
                        EdgeCosts = [80, 90],
                        EdgeDescriptions = ["First way", "Second way"]):
Graph::printGraphInformation(G2)
```

Warning: The following edges were not used for operation: [[a, b]]. [Graph::selectEdge]

```
Vertices: [a, b, c, d]
Edges: [[a, d], [a, b], [b, c], [c, d]]
Vertex weights: no vertex weights.
Edge descriptions: [a, d] = "Second way"
Edge weights: [a, b] = 1/4, [b, c] = -5, [c, d] = PI, [a, d] = 20 (other e\
  xisting edges have no weight)
Edge costs: [a, b] = 30, [b, c] = -40, [a, d] = 90 (other existing edges h\
  ave costs zero)
Adjacency list (out): a = [b, d], b = [c], c = [d], d = []
Adjacency list (in): a = [], b = [a], c = [b], d = [a, c]
Graph is directed.
```

If an edge has specifications, but exist already in the graph, the specifications will not change. (see Information for edge [a, b] above)

## Parameters

**G**

Graph

**Edge**

List of one or more edges

**ew, ec**

Lists of numbers

**ed**

List of texts

**b**

Boolean value

## Options

**EdgeWeights**

The weight(s) of the new edge(s). Default is 0.

**EdgeCosts**

The cost(s) of the new edge(s). Default is 0.

**EdgeDescriptions**

The description(s) for the new edge(s). Default is no text.

## Return Values

Graph with the correct edges inserted.

## Graph::addVertices

Adds one or several vertices to a graph

### Syntax

```
Graph::addVertices(G, Vertex, <VertexWeights = vw>)
```

### Description

`Graph::addVertices` adds one or several vertices to an already existing graph. A vertex is represented by an arbitrary expression. A warning is raised if one of the specified vertices does already exist in the graph.

`Graph::addVertices(G, Vertex)` adds the vertices in `Vertex` to the graph `G`. If a vertex is specified that already exists, a warning will be printed that this vertex (and its vertex weight) is not used.

With `Graph::addVertices(G, Vertex, VertexWeights=vw)` the weight can be set to every vertex additionally. If these specifications are missing, the default value 0 (=None) is assumed. If a specification is used it has to hold exactly the same number of values as there are vertices. Otherwise an error will be raised.

---

**Note** The value None can be used in the specification lists for every edge that is not to be specified explicitly.

---

### Examples

#### Example 1

First, an undirected graph with two vertices and no edges is created. Then two vertices are added:

```
G := Graph([a, b, c, d], []):  
Graph::printVertexInformation(G):
```

```
G := Graph::addVertices(G, [e, f]):  
Graph::printVertexInformation(G)
```

```
Vertices existing in the graph:  
-----
```

```
Vertex a has weight None  
Vertex b has weight None  
Vertex c has weight None  
Vertex d has weight None
```

```
Vertices existing in the graph:  
-----
```

```
Vertex a has weight None  
Vertex b has weight None  
Vertex c has weight None  
Vertex d has weight None  
Vertex e has weight None  
Vertex f has weight None
```

No weights were specified, so every vertex has weight `None`. In the algorithms default-values will be used accordingly.

Now, what happens if a vertex is inserted that already exists in the graph?

```
G2 := Graph::addVertices(G, [a, g], VertexWeights=[10, 100]):  
Graph::printVertexInformation(G2)
```

```
Warning: The following vertices already exist: [a]. [Graph::selectVertex]
```

```
Vertices existing in the graph:  
-----
```

```
Vertex a has weight None  
Vertex b has weight None  
Vertex c has weight None  
Vertex d has weight None  
Vertex e has weight None  
Vertex f has weight None  
Vertex g has weight 100
```

If a vertex weight is specified for a vertex already existing, it will not be changed (see Vertex a above)

## Parameters

**G**

Graph

**Vertex**

List of one or more vertices

**vw**

Lists of numbers

## Options

**VertexWeights**

The weight(s) of the new vertex/vertices. Default is 0.

## Return Values

Graph with the correct vertices inserted.

# Graph::admissibleFlow

Checks a flow for admissibility in a Graph

## Syntax

```
Graph::admissibleFlow(G, f)
```

## Description

`Graph::admissibleFlow(G, f)` checks if the flow `f` is admissible in the Graph `G` according to its vertices and their capacities.

`Graph::admissibleFlow` checks whether a given flow is an admissible flow in the specified graph. A flow in a graph is a table `t`, where `t[[i, j]]` gives the number of units flowing from vertex `i` to vertex `j`. `Graph::admissibleFlow` returns `TRUE` if the flow is admissible. Otherwise `FALSE` is returned.

`Graph::admissibleFlow` does not check whether the flow is admissible, if a flow from vertex `i` to vertex `j` is allowed to pass through other vertices. See “Example 2” on page 11-10 (Symbolic Math Toolbox).

## Examples

### Example 1

In a cyclic graph with default capacities (1), the flow with one unit flowing from each vertex to its successor is certainly admissible:

```
G1 := Graph::createCircleGraph([v1, v2, v3, v4]):  
Graph::admissibleFlow(G1, table([v1, v2] = 1,  
                                [v2, v3] = 1,  
                                [v3, v4] = 1,  
                                [v4, v1] = 1))
```

TRUE

### Example 2

The flow must be specified in whole. `Graph::admissibleFlow` does not include “hops”, like skipping vertices in the path:

```
Graph::admissibleFlow(Graph::createCircleGraph([v1, v2, v3]),  
                      table([v1, v3] = 1))
```

FALSE

## Parameters

**G**

Graph

**f**

The flow, specified in a table

## Return Values

Either TRUE or FALSE



# Graph::bipartite

Finds out if a graph is bipartite.

## Syntax

```
Graph::bipartite(G, <Bool | Lists>)
```

## Description

Graph::bipartite(G) finds out whether G is bipartite or not.

Graph::bipartite(G, Sets): If G is bipartite, then a list containing two lists will be returned. Each of the lists contains the vertices belonging to the set. If G is not bipartite, then FAIL will be returned instead of any list.

Graph::bipartite(G, Bool) offers the same result as Graph::bipartite(G). If G is bipartite, then TRUE will be returned, otherwise FALSE.

## Examples

### Example 1

A small graph containing 3 vertices with 2 edges connecting them is created:

```
G := Graph([a, b, c], [[a, b], [b, c]]):  
Graph::bipartite(G, Lists);  
Graph::bipartite(G, Bool)
```

```
[[b], [a, c]]
```

```
TRUE
```

Two lists with vertices are shown. Another word for bipartite is two-colorable. This means that the graph above can be colored with only two colors so that no two vertices have the same color if connected with an edge. The bottom output could also be accomplished without using the parameter `Bool`:

```
Graph::bipartite(G)
```

TRUE

The following example shows what happens when a graph is not bipartite (an edge is added to connect the vertices a and c):

```
G2 := Graph::addEdges(G, [[a, c]]):  
Graph::bipartite(G2, Lists);  
Graph::bipartite(G2, Bool)
```

FAIL

FALSE

## Parameters

**G**

Graph

## Options

**Lists**

If `Lists` is stated the return value will be a list of two lists containing the (sorted) vertices belonging to each set, or `FAIL`.

**Bool**

If `Bool` is stated the return value will be either `TRUE` or `FALSE`. This is the default.

## **Return Values**

Depending on the options either a boolean value or list-sets will be returned.

## Graph::breadthFirstSearch

Makes a breadth first Search in a graph.

### Syntax

```
Graph::breadthFirstSearch(G, <StartVertex = v>)
```

### Description

Graph::breadthFirstSearch traverses through a graph via breadth first search. The output shows the first time of identification and the predecessor of each vertex. If a vertex is a single vertex with no predecessor its predecessor is *infinity*.

Graph::breadthFirstSearch(G, StartVertex = v) traverses through a graph via breadth first search starting from vertex v. The output shows the first time of identification and the predecessor of each vertex. If a vertex is a single vertex with no predecessor its predecessor is *infinity*.

### Examples

#### Example 1

A typical tree is created and drawn for a better understanding of the algorithm:

```
G := Graph([a, b, c, d, e, f, g, h, i, j, k, l],
           [[a, b], [a, c], [b, d], [b, e], [c, f], [c, g],
            [d, h], [e, i], [e, j], [f, k], [g, l]],
           Directed);
plot(
  Graph::plotGridGraph(G, VerticesPerLine = [12, 12, 12, 12],
    VertexOrder = [
  None, None, None, None, None, None,
  a,   None, None, None, None, None,
  None, None, b,   None, None, None,
  None, None, None, c,   None, None,
```

```
None, d, None, None, e, None,  
None, f, None, None, g, None,  
h, None, None, i, None, j,  
None, None, k, None, None, l  
  ]  
 )  
)
```

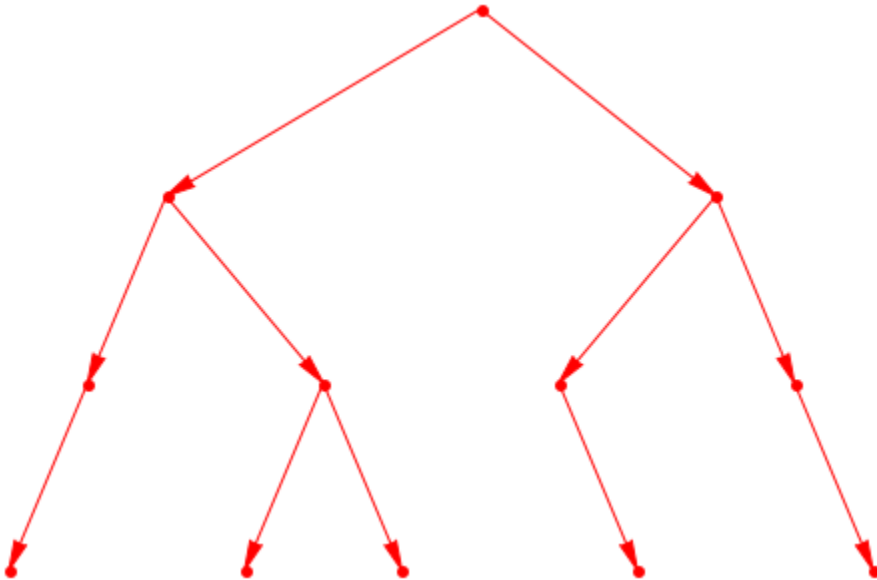

Now we call `breadthFirstSearch` to find out the starting times and predecessors

```
Graph::breadthFirstSearch(G)
```

a	1	a	0	a	a
b	2	b	1	b	a
c	3	c	1	c	a
d	4	d	2	d	b
e	5	e	2	e	b
f	6	f	2	f	c
g	7	g	2	g	c
h	8	h	3	h	d
i	9	i	3	i	e
j	10	j	3	j	e
k	11	k	3	k	f
l	12	l	3	l	g

Vertex *a* is discovered first, then vertex *b* and so on. The right table shows the predecessor of every vertex. The backtracking from a single vertex is therefore really simple. *a* as the first vertex discovered in its component can not be backtracked any further. The distance of each vertex in its component can be read in the middle table. Root-vertices always have the value 0 (they are the roots).

## Example 2

What happens now, if there exist a vertex that has no connection to any other vertex. The upper example is taken and a single vertex is added without changing anything else. Then a breadth first search is invoked on the graph:

```
G := Graph([a, b, c, d, e, f, g, h, i, j, k, l],
           [[a, b], [a, c], [b, d], [b, e], [c, f], [c, g],
            [d, h], [e, i], [e, j], [f, k], [g, l]],
           Directed);

G2 := Graph::addVertices(G, [m]);
Graph::breadthFirstSearch(G2, StartVertex = [a])
```

a	1	a	0	a	a
b	2	b	1	b	a
c	3	c	1	c	a
d	4	d	2	d	b
e	5	e	2	e	b
f	6	f	2	f	c
g	7	g	2	g	c
h	8	h	3	h	d
i	9	i	3	i	e
j	10	j	3	j	e
k	11	k	3	k	f
l	12	l	3	l	g
m	13	m	0	m	$\infty$

The newly inserted vertex `m` has no predecessor. The predecessor therefore holds the value *infinity*.

### Example 3

If we start somewhere in the graph without knowing the root of the DAG, the results are of course different:

```
G := Graph([a, b, c, d, e, f, g, h, i, j, k, l],
           [[a, b], [a, c], [b, d], [b, e], [c, f], [c, g],
            [d, h], [e, i], [e, j], [f, k], [g, l]],
           Directed):
```

```
Graph::breadthFirstSearch(G, StartVertex = [c])
```

a	6	a	0	a	a
b	7	b	1	b	a
c	1	c	0	c	c
d	8	d	2	d	b
e	9	e	2	e	b
f	2	f	1	f	c
g	3	g	1	g	c
h	10	h	3	h	d
i	11	i	3	i	e
j	12	j	3	j	e
k	4	k	2	k	f
l	5	l	2	l	g

The predecessor of c is c, but if we look at the graph it should be a. This is nevertheless not quite correct. Breadth first search takes the given vertex and uses this as the root of the graph (no in-vertices!). This explains also why the next call shows a *infinity* as predecessor to l.

## Parameters

**G**

Graph

**v**

List containing one vertex.

## Options

**StartVertex**

Defines a vertex from which to start the breadth first traversal.



## Return Values

List containing three tables. The first table holds the timestamp of the discovery. The second the distance to the root-vertex. The last table holds the predecessor vertices.

## Graph::checkForVertices

Checks if all vertices in edges really exist.

### Syntax

```
Graph::checkForVertices(Edge, Vertex)
```

### Description

Graph::checkForVertices(Edge, Vertex) checks if all vertices out of Edge are in Vertex.

### Examples

#### Example 1

What vertices are within the stated edges, but not in the vertex list?

```
Graph::checkForVertices([[a, b], [1, 2]], [a, 2])
```

```
[b, 1]
```

Neither b nor 1 were in the second list. a was in the first edge and 2 in the second.

#### Example 2

A more complex example. The second list contains a vertex that does not exist in the graph at all. For the checking it does not matter though. Every vertex NOT in the second list is to be returned. In the end it does not matter if the vertex-list contains vertices that are not existent, because only existing vertices are returned.

```
G := Graph::createCompleteGraph(10):  
Graph::checkForVertices(Graph::getEdges(G), [1, 2, 3, 11])
```

[4, 5, 6, 7, 8, 9, 10]

## Parameters

### Edge

List of one or more Edges

### Vertex

List of one or more vertices

## Return Values

List with the vertices out of the Edges that were not stated in Vertex.

## Graph::chromaticNumber

Chromatic number of a graph

### Syntax

```
Graph::chromaticNumber(G)
```

### Description

`Graph::chromaticNumber(G)` returns the chromatic number of the graph `G`. The chromatic number of a graph is defined to be the number of colors necessary to color it such that no two adjacent vertices have the same color.

### Examples

#### Example 1

We compute the chromatic number of the complete graph with 5 vertices; it must be 5 since any two vertices are adjacent:

```
Graph::chromaticNumber(Graph::createCompleteGraph(5))
```

5

### Parameters

**G**

An undirected graph

## Return Values

Positive integer

## Algorithms

Internally, the chromatic polynomial on page 11-24 is used to compute the chromatic number.

## See Also

### **MuPAD Functions**

Graph::chromaticPolynomial

## Graph::chromaticPolynomial

Calculates a chromatic polynomial

### Syntax

`Graph::chromaticPolynomial(G, x)`

### Description

`Graph::chromaticPolynomial(G, x)` returns the chromatic polynomial of the graph  $G$ . Evaluating the result at  $x = n$ , for any integer  $n$ , gives the number of possible ways to color the graph  $G$  using  $n$  colors such that no two adjacent vertices have the same color.

$G$  must be an undirected graph: if an edge goes from  $a$  to  $b$ , another edge must go from  $b$  to  $a$ , for any two vertices  $a, b$ .

### Examples

#### Example 1

We compute the chromatic polynomial of the complete graph with 5 vertices:

```
f := Graph::chromaticPolynomial(Graph::createCompleteGraph(5), x)
```

$$\text{poly}(x^5 - 10x^4 + 35x^3 - 50x^2 + 24x, [x])$$

There are 240 ways to color a complete graph with 5 vertices, since this is the number of bijective mappings between the set of colors and the set of vertices:

```
f(5)
```

```
120
```

```
delete f:
```

## Example 2

Now let us delete one edge from a complete graph:

```
G:= Graph::createCompleteGraph(5):
G:= Graph::removeEdge(G, [[2, 3]]):
G:= Graph::removeEdge(G, [[3, 2]])
```

```
Graph(...)
```

Now there are some additional possible colourings: vertices 2 and 3 may now have the same color, in five different ways; in each case, there must be one of the four remaining colors that does not occur at all. In each of the 20 cases, we are left with 3 vertices that form a complete graph and 3 colors, such that there are 6 colourings. Altogether this gives us 120 additional colourings:

```
Graph::chromaticPolynomial(G, x)(5)
```

```
240
```

## Parameters

**G**

An undirected graph

**x**

An identifier

## Return Values

polynomial on page 1-1601

## References

See Birkhoff and Lewis, *Chromatic Polynomials*, Trans. AMS, Vol. 60, p.355-451, 1946.

## Algorithms

Computing the chromatic polynomial of a graph with  $n$  vertices reduces to computing two chromatic polynomials of graphs with  $n - 1$  vertices. The running time is hence roughly  $2^n$ .



# Graph::contract

Contracts vertices

## Syntax

```
Graph::contract(G, VertexTable)
```

## Description

`Graph::contract(G, VertexTable)` contracts the vertices for each entry in the table.

---

**Note** The graph to be contracted must not have edge weights, costs or descriptions. If it has, an error will be raised.

---



---

**Note** If `VertexTable` contains vertices not in `G`, these will be skipped.

---

## Examples

### Example 1

A simple example to see how a contraction is done.

```
ConG := Graph([a, b, c, d, e, f],
              [[a, c], [d, a], [f, c], [d, f], [e, b]],
              Directed):
Graph::printGraphInformation(ConG)
```

```
Vertices: [a, b, c, d, e, f]
Edges: [[a, c], [d, a], [d, f], [e, b], [f, c]]
Vertex weights: no vertex weights.
Edge descriptions: no edge descriptions.
Edge weights: no edge weights.
```

Edge costs: no edge costs.

Adjacency list (out): a = [c], b = [], c = [], d = [a, f], e = [b], f = [c]

Adjacency list (in): a = [d], b = [e], c = [a, f], d = [], e = [], f = [d]  
 Graph is directed.

```
plot(
  Graph::plotGridGraph(ConG,
    VerticesPerLine = 3,
    VertexOrder = [None, b, None,
                  a, None, c,
                  None, e, None,
                  d, None, f],
    EdgeColor = RGB::Black))
```

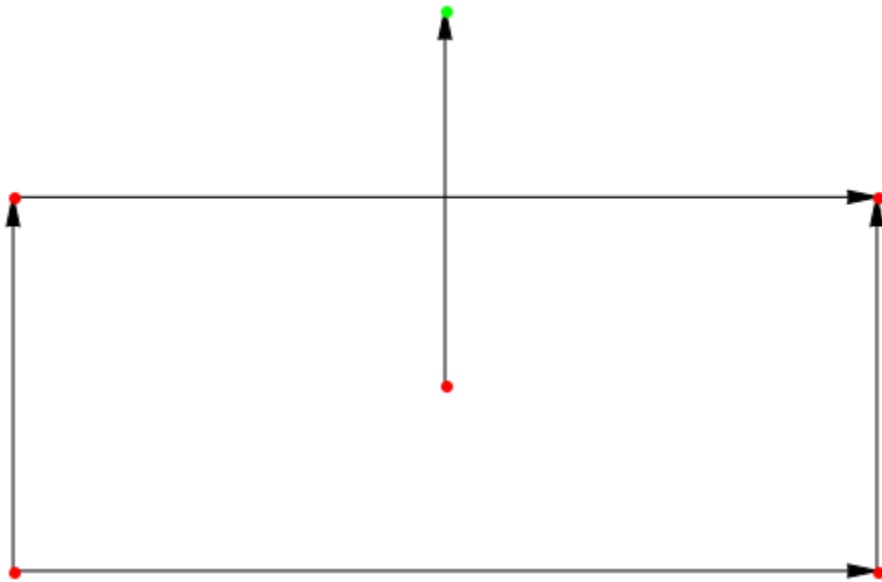

```
t := table(A = [a, b, c],
          B = [d, f])
```

$$\begin{array}{c|c} A & [a, b, c] \\ B & [d, f] \end{array}$$

```
newG := Graph::contract(ConG, t):
Graph::printGraphInformation(newG)
```

```
Vertices: [A, B, e]
Edges: [[A, A], [B, A], [B, B], [e, A]]
Vertex weights: no vertex weights.
Edge descriptions: no edge descriptions.
Edge weights: no edge weights.
Edge costs: no edge costs.
Adjacency list (out): e = [A], A = [A], B = [A, B]
Adjacency list (in): e = [], A = [A, B, e], B = [B]
Graph is directed.
```

Since vertices  $a, b, c$  were contracted to vertex  $A$ , edge  $[a, c]$  was removed and edge  $[A, A]$  was created. Vertices  $d, f$  took care of the deletion of edges  $[d, a], [d, f], [f, c]$ . Instead edges  $[B, A]$  and  $[B, B]$  were created. In the end edge  $[e, b]$  was changed to  $[e, A]$  since vertex  $b$  does not exist any longer because it was replaced by  $A$ .

```
plot(Graph::plotGridGraph(newG,
    VerticesPerLine = 2,
    VertexOrder = [None, B,
                   A,   None,
                   None, e]))
```

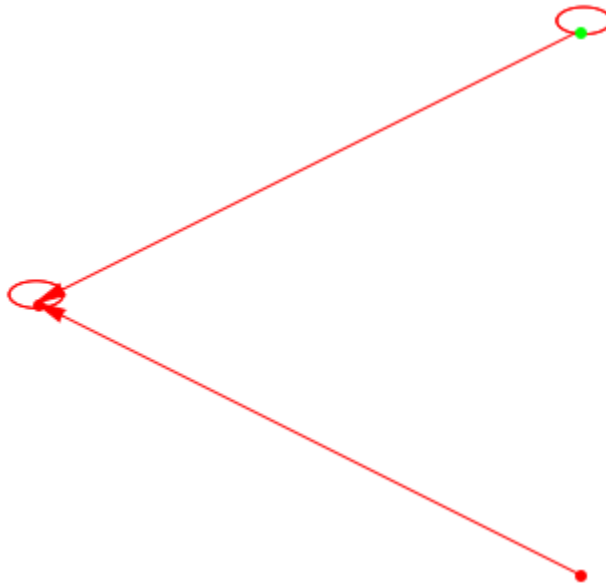

## Example 2

Graph::contract ignores vertices not in the graph:

```
Con2 := Graph([], []):  
t := table(A = [a, b, c], B = [d, f]):  
Graph::printGraphInformation(Graph::contract(Con2, t))
```

```
Vertices: no vertices.  
Edges: []  
Adjacency list (out): no edges.  
Adjacency list (in): no edges.  
Graph is undirected.
```

## Parameters

**G**

Graph

**VertexTable**

A table with the name of the new vertex on the left side and a list of vertices to contract on the right side.

**Return Values**

Graph consisting of the new vertices and edges.

## Graph::convertSSQ

Converts a Graph into a single source single sink Graph

### Syntax

Graph::convertSSQ(G, q, s)

### Description

Graph::convertSSQ(G, q, s) converts the graph G into a directed single source single sink graph. The specified vertices q and s are added to the graph. It is an error if they are already predefined. Otherwise they are connected to the other vertices of the graph in the following way:

A new edge [q, i] is added for every vertex i with a positive weight. A new edge [i, s] is added for every vertex i with a negative weight. The capacities of these edges are in each case the weight of node i. The edge weights are zero.

### Examples

#### Example 1

A testexample to show the transformation.

```
V := [1, 2, 3, 4]:  
Vw := [4, 0, 0, -4]:  
Ed := [[1, 2], [1, 3], [2, 3], [2, 4], [3, 4]]:  
Ec := [2, 2, 1, 3, 1]:  
Ew := [4, 2, 2, 3, 5]:  
G1 := Graph(V, Ed, VertexWeights = Vw,  
            EdgeWeights = Ew, EdgeCosts = Ec):  
G2 := Graph::convertSSQ(G1, [q], [s]):  
Graph::printGraphInformation(G2)
```

```
Vertices: [1, 2, 3, 4, q, s]
```

```

Edges: [[1, 2], [1, 3], [2, 1], [2, 3], [2, 4], [3, 1], [3, 2], [3, 4], [4,
2], [4, 3], [4, s], [q, 1]]
Vertex weights: 1 = 0, 2 = 0, 3 = 0, 4 = 0, q = 4, s = -4 (other existing \
vertices have no weight)
Edge descriptions: no edge descriptions.
Edge weights: [1, 2] = 4, [1, 3] = 2, [2, 3] = 2, [2, 4] = 3, [3, 4] = 5, \
[2, 1] = 4, [3, 1] = 2, [3, 2] = 2, [4, 2] = 3, [4, 3] = 5, [q, 1] = 4, [4\
, s] = 4 (other existing edges have no weight)
Edge costs: [1, 2] = 2, [1, 3] = 2, [2, 3] = 1, [2, 4] = 3, [3, 4] = 1, [2\
, 1] = 2, [3, 1] = 2, [3, 2] = 1, [4, 2] = 3, [4, 3] = 1, [q, 1] = 0, [4, \
s] = 0 (other existing edges have costs zero)
Adjacency list (out): 1 = [2, 3], 2 = [1, 3, 4], 3 = [1, 2, 4], 4 = [2, 3,\
s], q = [1], s = []
Adjacency list (in): 1 = [2, 3, q], 2 = [1, 3, 4], 3 = [1, 2, 4], 4 = [2, \
3], q = [], s = [4]
Graph is directed.

```

The former undirected graph was transformed into a directed one!

## Parameters

**q, s**

Vertices not predefined in the Graph

**G**

A Graph

## Return Values

Directed augmented Graph

## Algorithms

Both, Bellman and Dijkstra expect a Graph without negative circles. Only Dijkstra may return erroneous results when negative edges (either weights or costs) are specified.

The Bellman algorithm originated from: Ahuja, Magnanti, Orlin: Dom::Graph Flows, Prentice-Hall, 1993 Section 5.4



# Graph::createCircleGraph

Generates a circle Graph

## Syntax

```
Graph::createCircleGraph(L, <Directed | Undirected>)
```

```
Graph::createCircleGraph(N, <Directed | Undirected>)
```

## Description

`Graph::createCircleGraph(L)` generates a circle Graph

`Graph::createCircleGraph([v1, ..., vn])` generates a new graph which is the cycle  $[v1, v2], [v2, v3], \dots, [vn, v1]$ . The values for the edge weights, edge costs and vertex weights can be set manually via `Graph::setEdgeWeights`, `Graph::setEdgeCosts` and `Graph::setVertexWeights`

`Graph::createCircleGraph(3)` generates a new graph which is the cycle  $[1, 2], [2, 3], [3, 1]$ . The values for the edge weights, edge capacities and vertex weights can be set manually via `Graph::setEdgeWeights`, `Graph::setEdgeCosts` and `Graph::setVertexWeights`

`Graph::createCircleGraph(3, Undirected)` generates a new graph which includes the vertices  $[1, 2], [2, 3], [3, 1], [2, 1], [3, 2], [1, 3]$ .

## Examples

### Example 1

A (directed) circle graph with four vertices:

```
G1 := Graph::createCircleGraph(4):  
Graph::printGraphInformation(G1)
```

```
Vertices: [1, 2, 3, 4]
Edges: [[1, 2], [2, 3], [3, 4], [4, 1]]
Vertex weights: no vertex weights.
Edge descriptions: no edge descriptions.
Edge weights: no edge weights.
Edge costs: no edge costs.
Adjacency list (out): 1 = [2], 2 = [3], 3 = [4], 4 = [1]
Adjacency list (in): 1 = [4], 2 = [1], 3 = [2], 4 = [3]
Graph is directed.
```

## Example 2

The same graph but this time with parameter `Undirected`:

```
G2 := Graph::createCircleGraph(4, Undirected):
Graph::printGraphInformation(G2)
```

```
Vertices: [1, 2, 3, 4]
Edges: [[1, 2], [1, 4], [2, 1], [2, 3], [3, 2], [3, 4], [4, 1], [4, 3]]
Vertex weights: no vertex weights.
Edge descriptions: no edge descriptions.
Edge weights: no edge weights.
Edge costs: no edge costs.
Adjacency list (out): 1 = [2, 4], 2 = [1, 3], 3 = [2, 4], 4 = [1, 3]
Adjacency list (in): 1 = [2, 4], 2 = [1, 3], 3 = [2, 4], 4 = [1, 3]
Graph is undirected.
```

## Example 3

The circle graph with predefined vertices:

```
G3 := Graph::createCircleGraph([a, b, c, d, 4, 5, 6]):
Graph::printGraphInformation(G3)
```

```
Vertices: [4, 5, 6, a, b, c, d]
Edges: [[4, 5], [5, 6], [6, a], [a, b], [b, c], [c, d], [d, 4]]
Vertex weights: no vertex weights.
Edge descriptions: no edge descriptions.
Edge weights: no edge weights.
Edge costs: no edge costs.
```

```
Adjacency list (out): a = [b], b = [c], c = [d], d = [4], 4 = [5], 5 = [6]\n, 6 = [a]\nAdjacency list (in): a = [6], b = [a], c = [b], d = [c], 4 = [d], 5 = [4],\n6 = [5]\nGraph is directed.
```

## Parameters

**L**

List of vertices

**N**

A positive Integer

## Options

**Directed**

The Graph is created as a directed graph. Default.

**Undirected**

The Graph is created as an undirected graph.

## Return Values

Graph

## Graph::createCompleteGraph

Generates a complete graph

### Syntax

```
Graph::createCompleteGraph(n)
```

### Description

Graph::createCompleteGraph(n) generates the complete Graph with n vertices. A complete graph has a connection between each pair of vertices (except to itself).

The vertices of the generated graph are labeled with the numbers 1 to n.

### Examples

#### Example 1

The complete Graph with three vertices has  $3 \cdot 2 = 6$  edges:

```
G := Graph::createCompleteGraph(3):  
Graph::printGraphInformation(G)
```

```
Vertices: [1, 2, 3]  
Edges: [[1, 2], [1, 3], [2, 1], [2, 3], [3, 1], [3, 2]]  
Vertex weights: no vertex weights.  
Edge descriptions: no edge descriptions.  
Edge weights: no edge weights.  
Edge costs: no edge costs.  
Adjacency list (out): 1 = [2, 3], 2 = [1, 3], 3 = [1, 2]  
Adjacency list (in): 1 = [2, 3], 2 = [1, 3], 3 = [1, 2]  
Graph is undirected.
```

## Parameters

**n**

A positive integer

## Return Values

Graph

## Graph::createGraphFromMatrix

Transfers a squared matrix into a directed graph

### Syntax

Graph::createGraphFromMatrix(M)

### Description

Graph::createGraphFromMatrix(M) generates a directed Graph where each  $m_{i,j}$  in the matrix defines an edge from  $i$  to  $j$ . The value of the cell defines the weight of the resulting edge.

The vertices of the generated graph are labeled with the numbers 1 to  $n$ , where  $n$  defines the column/row-dimension of the matrix. Since the matrix has to be squared,  $n$  stays the same.

### Examples

#### Example 1

A matrix is defined and the resulting squared matrix is transferred into a Graph.

```
a := matrix([[3, 2, 4], [2, 3, 6], [4, 8, 3]]);  
G := Graph::createGraphFromMatrix(a);  
Graph::printGraphInformation(G)
```

$$\begin{pmatrix} 3 & 2 & 4 \\ 2 & 3 & 6 \\ 4 & 8 & 3 \end{pmatrix}$$

Vertices: [1, 2, 3]

Edges: [[1, 1], [1, 2], [1, 3], [2, 1], [2, 2], [2, 3], [3, 1], [3, 2], [3,

```
, 3]]
```

```
Vertex weights: no vertex weights.
```

```
Edge descriptions: no edge descriptions.
```

```
Edge weights: [1, 1] = 3, [1, 2] = 2, [1, 3] = 4, [2, 1] = 2, [2, 2] = 3, \  
[2, 3] = 6, [3, 1] = 4, [3, 2] = 8, [3, 3] = 3 (other existing edges have \  
no weight)
```

```
Edge costs: no edge costs.
```

```
Adjacency list (out): 1 = [1, 2, 3], 2 = [1, 2, 3], 3 = [1, 2, 3]
```

```
Adjacency list (in): 1 = [1, 2, 3], 2 = [1, 2, 3], 3 = [1, 2, 3]
```

```
Graph is directed.
```

## Parameters

**M**

A matrix

## Return Values

Graph

## Graph::createRandomEdgeWeights

Sets random weights to edges

### Syntax

```
Graph::createRandomEdgeWeights(G, r, <Dom::Integer | Dom::Real>)
```

### Description

Graph::createRandomEdgeWeights(G, x..y) creates random integer edge weights within the range x..y.

Graph::createRandomEdgeWeights(G, x..y, Dom::Integer) does exactly the same.

Graph::createRandomEdgeWeights(G, x..y, Dom::Real) creates random real edge weights within the range x..y.

---

**Note** Already existing edge weights will be changed, too!

---

### Examples

#### Example 1

Creating edge weights for a small cyclic graph. First, it has no specified weights:

```
G1 := Graph::createCircleGraph(5):  
Graph::printGraphInformation(G1)
```

```
Vertices: [1, 2, 3, 4, 5]  
Edges: [[1, 2], [2, 3], [3, 4], [4, 5], [5, 1]]  
Vertex weights: no vertex weights.  
Edge descriptions: no edge descriptions.
```



```

Edge weights: no edge weights.
Edge costs: no edge costs.
Adjacency list (out): 1 = [2], 2 = [3], 3 = [4], 4 = [5], 5 = [1]
Adjacency list (in): 1 = [5], 2 = [1], 3 = [2], 4 = [3], 5 = [4]
Graph is directed.

```

Now the weights are set within the range -100..50 (your output may differ due random assignment):

```

G2 := Graph::createRandomEdgeWeights(G1, -100..50):
Graph::printGraphInformation(G2)

```

```

Vertices: [1, 2, 3, 4, 5]
Edges: [[1, 2], [2, 3], [3, 4], [4, 5], [5, 1]]
Vertex weights: no vertex weights.
Edge descriptions: no edge descriptions.
Edge weights: [1, 2] = 47, [2, 3] = -12, [3, 4] = 28, [4, 5] = 1, [5, 1] = \
-36 (other existing edges have no weight)
Edge costs: no edge costs.
Adjacency list (out): 1 = [2], 2 = [3], 3 = [4], 4 = [5], 5 = [1]
Adjacency list (in): 1 = [5], 2 = [1], 3 = [2], 4 = [3], 5 = [4]
Graph is directed.

```

If the weights should be of type Real it can be set optionally:

```

G2 := Graph::createRandomEdgeWeights(G1, -100..50, Dom::Real):
Graph::printGraphInformation(G2)

```

```

Vertices: [1, 2, 3, 4, 5]
Edges: [[1, 2], [2, 3], [3, 4], [4, 5], [5, 1]]
Vertex weights: no vertex weights.
Edge descriptions: no edge descriptions.
Edge weights: [1, 2] = -67.72964183, [2, 3] = -10.16896282, [3, 4] = -72.8\
4684348, [4, 5] = -61.00518722, [5, 1] = 18.2662729 (other existing edges \
have no weight)
Edge costs: no edge costs.
Adjacency list (out): 1 = [2], 2 = [3], 3 = [4], 4 = [5], 5 = [1]
Adjacency list (in): 1 = [5], 2 = [1], 3 = [2], 4 = [3], 5 = [4]
Graph is directed.

```

## **Parameters**

**G**

A graph

**r**

A range

## **Return Values**

Graph

# Graph::createRandomEdgeCosts

Sets random costs to edges

## Syntax

```
Graph::createRandomEdgeCosts(G, r, <Dom::Integer | Dom::Real>)
```

## Description

`Graph::createRandomEdgeCosts(G, x..y)` creates random edge weights of type Integer within the range `x..y`.

`Graph::createRandomEdgeCosts(G, x..y, Dom::Integer)` does exactly the same.

`Graph::createRandomEdgeCosts(G, x..y, Dom::Real)` creates random edge weights of type Real within the range `x..y`.

---

**Note** Already existing edge costs will be changed, too!

---

## Examples

### Example 1

Creating edge weights for a small cyclic graph. First, it has no specified weights:

```
G1 := Graph::createCircleGraph(5):  
Graph::printGraphInformation(G1)
```

```
Vertices: [1, 2, 3, 4, 5]  
Edges: [[1, 2], [2, 3], [3, 4], [4, 5], [5, 1]]  
Vertex weights: no vertex weights.  
Edge descriptions: no edge descriptions.  
Edge weights: no edge weights.
```

```
Edge costs: no edge costs.  
Adjacency list (out): 1 = [2], 2 = [3], 3 = [4], 4 = [5], 5 = [1]  
Adjacency list (in): 1 = [5], 2 = [1], 3 = [2], 4 = [3], 5 = [4]  
Graph is directed.
```

Now the costs are set within the range  $-100..50$  (your output may differ due random assignment):

```
G2 := Graph::createRandomEdgeCosts(G1, -100..50):  
Graph::printGraphInformation(G2)
```

```
Vertices: [1, 2, 3, 4, 5]  
Edges: [[1, 2], [2, 3], [3, 4], [4, 5], [5, 1]]  
Vertex weights: no vertex weights.  
Edge descriptions: no edge descriptions.  
Edge weights: no edge weights.  
Edge costs: [1, 2] = 47, [2, 3] = -12, [3, 4] = 28, [4, 5] = 1, [5, 1] = -\36 (other existing edges have costs zero)  
Adjacency list (out): 1 = [2], 2 = [3], 3 = [4], 4 = [5], 5 = [1]  
Adjacency list (in): 1 = [5], 2 = [1], 3 = [2], 4 = [3], 5 = [4]  
Graph is directed.
```

If the costs should be of type Real it can be set optionally:

```
G2 := Graph::createRandomEdgeCosts(G1, -100..50, Dom::Real):  
Graph::printGraphInformation(G2)
```

```
Vertices: [1, 2, 3, 4, 5]  
Edges: [[1, 2], [2, 3], [3, 4], [4, 5], [5, 1]]  
Vertex weights: no vertex weights.  
Edge descriptions: no edge descriptions.  
Edge weights: no edge weights.  
Edge costs: [1, 2] = -67.72964183, [2, 3] = -10.16896282, [3, 4] = -72.846\84348, [4, 5] = -61.00518722, [5, 1] = 18.2662729 (other existing edges ha\ve costs zero)  
Adjacency list (out): 1 = [2], 2 = [3], 3 = [4], 4 = [5], 5 = [1]  
Adjacency list (in): 1 = [5], 2 = [1], 3 = [2], 4 = [3], 5 = [4]  
Graph is directed.
```

## Parameters

**G**

A graph

**r**

A range

## Return Values

Graph

## Graph::createRandomGraph

Generates a random graph.

### Syntax

```
Graph::createRandomGraph(VertexNr, EdgeNr, <Directed | Undirected>)
```

### Description

Graph::createRandomGraph generates a random graph.

Graph::createRandomGraph(VertexNr, EdgeNr) generates a random graph with VertexNr vertices and EdgeNr edges.

---

**Note** If the number EdgeNr is too great (i.e.  $\text{EdgeNr} \geq \frac{\text{VertexNr}(\text{VertexNr}-1)}{2}$ ), a complete graph will be created.

---

Graph::createRandomGraph(VertexNr, EdgeNr, Undirected) generates a random graph with VertexNr vertices and 2 EdgeNr edges is created. This is due to the fact that no odd number of undirected edges could be created otherwise.

### Examples

#### Example 1

The following graph was created randomly, meaning that your results will most probably differ:

```
G := Graph::createRandomGraph(5,6):  
Graph::printGraphInformation(G)
```

```
Vertices: [1, 2, 3, 4, 5]
```

```

Edges: [[1, 4], [2, 1], [2, 4], [2, 5], [3, 1], [3, 4]]
Vertex weights: no vertex weights.
Edge descriptions: no edge descriptions.
Edge weights: no edge weights.
Edge costs: no edge costs.
Adjacency list (out): 1 = [4], 2 = [1, 4, 5], 3 = [1, 4], 4 = [], 5 = []
Adjacency list (in): 1 = [2, 3], 2 = [], 3 = [], 4 = [1, 2, 3], 5 = [2]
Graph is directed.

```

## Example 2

The same number of vertices, but this time the edges are undirected (and therefore the number of Edges is  $(2 \text{ EdgeNr})$ ). As you can clearly see, the edges differ from the edges created above:

```

G := Graph::createRandomGraph(5, 6, Undirected):
Graph::printGraphInformation(G)

```

```

Vertices: [1, 2, 3, 4, 5]
Edges: [[1, 4], [1, 5], [2, 3], [2, 4], [2, 5], [3, 2], [4, 1], [4, 2], [4\
, 5], [5, 1], [5, 2], [5, 4]]
Vertex weights: no vertex weights.
Edge descriptions: no edge descriptions.
Edge weights: no edge weights.
Edge costs: no edge costs.
Adjacency list (out): 1 = [4, 5], 2 = [3, 4, 5], 3 = [2], 4 = [1, 2, 5], 5\
= [1, 2, 4]
Adjacency list (in): 1 = [4, 5], 2 = [3, 4, 5], 3 = [2], 4 = [1, 2, 5], 5 \
= [1, 2, 4]
Graph is undirected.

```

## Example 3

If the number of edges to be created extends the possible limit ( $\frac{\text{vertices}(\text{vertices}-1)}{2}$ ), a complete graph will be returned:

```

G := Graph::createRandomGraph(3, 6, Undirected):
Graph::printGraphInformation(G)

```

Warning: Unable to produce the required number of edges. Creating a complete graph inst

Vertices: [1, 2, 3]  
Edges: [[1, 2], [1, 3], [2, 1], [2, 3], [3, 1], [3, 2]]  
Vertex weights: no vertex weights.  
Edge descriptions: no edge descriptions.  
Edge weights: no edge weights.  
Edge costs: no edge costs.  
Adjacency list (out): 1 = [2, 3], 2 = [1, 3], 3 = [1, 2]  
Adjacency list (in): 1 = [2, 3], 2 = [1, 3], 3 = [1, 2]  
Graph is undirected.

## Parameters

### VertexNr

Positive integer

### EdgeNr

Positive integer

## Options

### Directed

If `Directed` is stated, a directed Graph is created Default

### Undirected

If `Undirected` is stated, an undirected Graph is created.

## Return Values

Graph



# Graph::createRandomVertexWeights

Sets random weights to vertices

## Syntax

```
Graph::createRandomVertexWeights(G, r, <Int | Real>)
```

## Description

Graph::createRandomVertexWeights(G, x..y) creates random vertex weights of type Integer within the range x..y.

Graph::createRandomVertexWeights(G, x..y, Real) creates random vertex weights of type Real within the range x..y.

---

**Note** Already existing vertex weights will be changed, too!

---

## Examples

### Example 1

Creating vertex weights for a small cyclic graph. First, it has no specified weights:

```
G1 := Graph::createCircleGraph(5):
Graph::printGraphInformation(G1)
```

```
Vertices: [1, 2, 3, 4, 5]
Edges: [[1, 2], [2, 3], [3, 4], [4, 5], [5, 1]]
Vertex weights: no vertex weights.
Edge descriptions: no edge descriptions.
Edge weights: no edge weights.
Edge costs: no edge costs.
Adjacency list (out): 1 = [2], 2 = [3], 3 = [4], 4 = [5], 5 = [1]
```

```
Adjacency list (in): 1 = [5], 2 = [1], 3 = [2], 4 = [3], 5 = [4]
Graph is directed.
```

Now the weights are set within the range `-100..50` (your output may differ due random assignment):

```
G2 := Graph::createRandomVertexWeights(G1, -100..50):
Graph::printGraphInformation(G2)
```

```
Vertices: [1, 2, 3, 4, 5]
Edges: [[1, 2], [2, 3], [3, 4], [4, 5], [5, 1]]
Vertex weights: 1 = 47, 2 = -12, 3 = 28, 4 = 1, 5 = -36 (other existing ve\
rtices have no weight)
Edge descriptions: no edge descriptions.
Edge weights: no edge weights.
Edge costs: no edge costs.
Adjacency list (out): 1 = [2], 2 = [3], 3 = [4], 4 = [5], 5 = [1]
Adjacency list (in): 1 = [5], 2 = [1], 3 = [2], 4 = [3], 5 = [4]
Graph is directed.
```

If the weights should be of type `Real` it can be set optionally:

```
G2 := Graph::createRandomVertexWeights(G1, -100..50, Real):
Graph::printGraphInformation(G2)
```

```
Vertices: [1, 2, 3, 4, 5]
Edges: [[1, 2], [2, 3], [3, 4], [4, 5], [5, 1]]
Vertex weights: 1 = -67.72964183, 2 = -10.16896282, 3 = -72.84684348, 4 = \
-61.00518722, 5 = 18.2662729 (other existing vertices have no weight)
Edge descriptions: no edge descriptions.
Edge weights: no edge weights.
Edge costs: no edge costs.
Adjacency list (out): 1 = [2], 2 = [3], 3 = [4], 4 = [5], 5 = [1]
Adjacency list (in): 1 = [5], 2 = [1], 3 = [2], 4 = [3], 5 = [4]
Graph is directed.
```

## Parameters

**G**

A graph

**r**

A range

## Options

**Int**

If stated, the weights are only of type integer. (Default)

**Real**

If stated, the weights are only of type real.

## Return Values

Graph

## Graph::depthFirstSearch

Makes a depth first Search in a graph.

### Syntax

```
Graph::depthFirstSearch(G, <StartVertex = v>)
```

### Description

Graph::depthFirstSearch traverses through a graph via depth first search. The output shows the first time of identification, the finishing time and the predecessor of each vertex. If a vertex is a single vertex with no predecessor its predecessor is *infinity*.

Graph::depthFirstSearch(G, StartVertex=v) traverses through a graph via depth first search starting from vertex v. The output shows the first time of identification, the finishing time and the predecessor of each vertex. If a vertex is a single vertex with no predecessor its predecessor is *infinity*.

### Examples

#### Example 1

A typical tree is created and drawn for a better understanding of the algorithm.

```
G := Graph([a, b, c, d, e, f, g, h, i, j, k, l],
           [[a, b], [a, c], [b, d], [b, e], [c, f], [c, g],
            [d, h], [e, i], [e, j], [f, k], [g, l]],
           Directed);
plot(
  Graph::plotGridGraph(G, VerticesPerLine = [12, 12, 12, 12],
    VertexOrder = [
      None, None, None, None, None, None,
      a,    None, None, None, None, None,
      None, None, b,    None, None, None,
      None, None, None, c,    None, None,
```

```

None, d,   None, None, e,   None,
None, f,   None, None, g,   None,
h,   None, None, i,   None, j,
None, None, k,   None, None, l
]
)
)

```

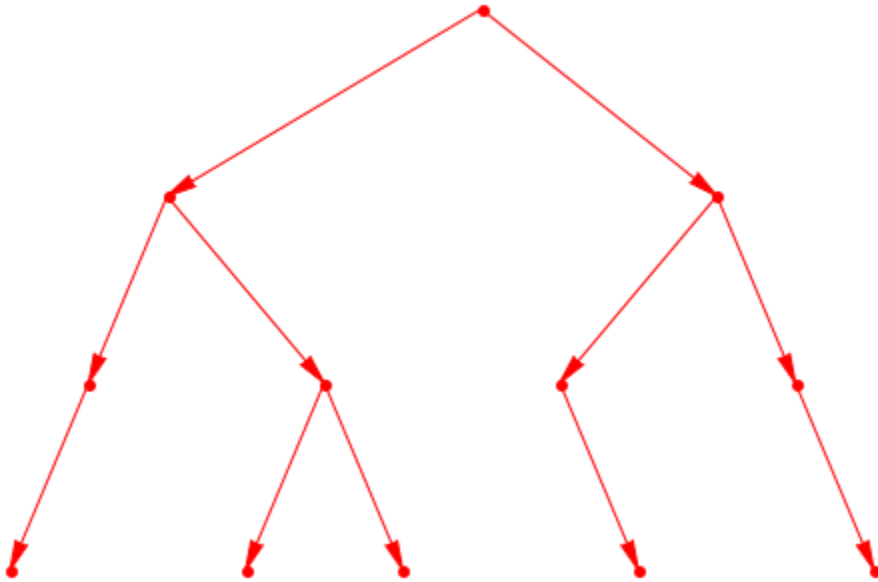

Now we call `Graph::depthFirstSearch` to find out the starting times, the finishing times and the predecessors of each vertex:

```
Graph::depthFirstSearch(G)
```

a	1	a	24	a	a
b	2	b	13	b	a
c	14	c	23	c	a
d	3	d	6	d	b
e	7	e	12	e	b
f	15, f	f	18,	f	c
g	19	g	22	g	c
h	4	h	5	h	d
i	8	i	9	i	e
j	10	j	11	j	e
k	16	k	17	k	f
l	20	l	21	l	g

Vertex a is discovered first, then vertex b and so on. The table in the middle shows the finishing times. h for example has the finishing time of 5, meaning that vertices a, b, c, d and h itself were visited before it was recognized that h is a leaf (finishing time = starting time + 1). The right table shows the predecessor of every vertex. The backtracking from a single vertex is therefore really simple. a as the first vertex discovered in its component can not be backtracked any further.

## Example 2

What happens now, if there exist a vertex that has no connection to any other vertex. The upper example is taken and a single vertex is added without changing anything else. Then a depth first search is invoked on the graph:

```
G := Graph([a, b, c, d, e, f, g, h, i, j, k, l],
           [[a, b], [a, c], [b, d], [b, e], [c, f], [c, g],
            [d, h], [e, i], [e, j], [f, k], [g, l]],
           Directed);

G2 := Graph::addVertices(G, [m]);
Graph::depthFirstSearch(G2, StartVertex = [a])
```

a	1	a	24	a	a
b	2	b	13	b	a
c	14	c	23	c	a
d	3	d	6	d	b
e	7	e	12	e	b
f	15	f	18	f	c
g	19	g	22	g	c
h	4	h	5	h	d
i	8	i	9	i	e
j	10	j	11	j	e
k	16	k	17	k	f
l	20	l	21	l	g
m	25	m	26	m	$\infty$

The newly inserted vertex *m* has no predecessor. The predecessor holds therefore the value *infinity*.

### Example 3

If we start somewhere in the graph without knowing the root of the DAG, the results are of course different:

```
G := Graph([a, b, c, d, e, f, g, h, i, j, k, l],
           [[a, b], [a, c], [b, d], [b, e], [c, f], [c, g],
            [d, h], [e, i], [e, j], [f, k], [g, l]],
           Directed):
```

```
Graph::depthFirstSearch(G, StartVertex = [c])
```

a	11	a	24	a	a
b	12	b	23	b	a
c	1	c	10	c	c
d	13	d	16	d	b
e	17	e	22	e	b
f	2, f	f	5, f	f	c
g	6	g	9	g	c
h	14	h	15	h	d
i	18	i	19	i	e
j	20	j	21	j	e
k	3	k	4	k	f
l	7	l	8	l	g

The predecessor of c is c, but if we look at the graph it should be a. This is nevertheless not quite correct. Breadth first search takes the given vertex and uses this as the root of the graph (no in-vertices!). This explains also why the next call shows a *infinity* as predecessor to l:

`Graph::depthFirstSearch(G, StartVertex = [l])`

a	3	a	24	a	a
b	4	b	15	b	a
c	16	c	23	c	a
d	5	d	8	d	b
e	9	e	14	e	b
f	17, f	f	20, f	f	c
g	21	g	22	g	c
h	6	h	7	h	d
i	10	i	11	i	e
j	12	j	13	j	e
k	18	k	19	k	f
l	1	l	2	l	∞

## Parameters

**G**

Graph



**v**

List containing one vertex.

## **Options**

### **StartVertex**

Defines a vertex from which to start the depth first traversal.

## **Return Values**

List containing three tables. The first table holds the first identification timestamp of each vertex, the second the finishing timestamp and the third the predecessor vertex.

## Graph::getAdjacentEdgesEntering

Returns the incident edges.

### Syntax

```
Graph::getAdjacentEdgesEntering(G, Vertex)
```

### Description

Graph::getAdjacentEdgesEntering(G, Vertex) returns a list with vertices  $v_1..v_n$ , where  $[v_1, Vertex] .. [v_n, Vertex]$  are incident (incoming) Edges to Vertex.

### Examples

#### Example 1

First, a complete graph is defined:

```
G1 := Graph::createCompleteGraph(5):  
Graph::printGraphInformation(G1)
```

```
Vertices: [1, 2, 3, 4, 5]  
Edges: [[1, 2], [1, 3], [1, 4], [1, 5], [2, 1], [2, 3], [2, 4], [2, 5], [3,  
, 1], [3, 2], [3, 4], [3, 5], [4, 1], [4, 2], [4, 3], [4, 5], [5, 1], [5, \  
2], [5, 3], [5, 4]]  
Vertex weights: no vertex weights.  
Edge descriptions: no edge descriptions.  
Edge weights: no edge weights.  
Edge costs: no edge costs.  
Adjacency list (out): 1 = [2, 3, 4, 5], 2 = [1, 3, 4, 5], 3 = [1, 2, 4, 5]\,  
4 = [1, 2, 3, 5], 5 = [1, 2, 3, 4]  
Adjacency list (in): 1 = [2, 3, 4, 5], 2 = [1, 3, 4, 5], 3 = [1, 2, 4, 5],\  
4 = [1, 2, 3, 5], 5 = [1, 2, 3, 4]  
Graph is undirected.
```

Now we get the vertices that form all incident edges [2, 1] .. [5, 1]:

```
Graph::getAdjacentEdgesEntering(G1, [1])
```

```
[2, 3, 4, 5]
```

Now we get the vertices that form all incident edges [1, 5] .. [4, 5]:

```
Graph::getAdjacentEdgesEntering(G1, [5])
```

```
[1, 2, 3, 4]
```

## Parameters

### **G**

A graph

### **Vertex**

One vertex of G.

## Return Values

List

## Graph::getAdjacentEdgesLeaving

Returns the adjacent edges.

### Syntax

```
Graph::getAdjacentEdgesLeaving(G, Vertex)
```

### Description

Graph::getAdjacentEdgesLeaving(G, Vertex) returns a list with vertices  $v_1 \dots v_n$ , where [Vertex,  $v_1$ ] .. [Vertex,  $v_n$ ] are adjacent (outgoing) Edges to Vertex.

### Examples

#### Example 1

First, a complete graph is defined:

```
G1 := Graph::createCompleteGraph(5):  
Graph::printGraphInformation(G1)
```

```
Vertices: [1, 2, 3, 4, 5]  
Edges: [[1, 2], [1, 3], [1, 4], [1, 5], [2, 1], [2, 3], [2, 4], [2, 5], [3,  
, 1], [3, 2], [3, 4], [3, 5], [4, 1], [4, 2], [4, 3], [4, 5], [5, 1], [5, \  
2], [5, 3], [5, 4]]  
Vertex weights: no vertex weights.  
Edge descriptions: no edge descriptions.  
Edge weights: no edge weights.  
Edge costs: no edge costs.  
Adjacency list (out): 1 = [2, 3, 4, 5], 2 = [1, 3, 4, 5], 3 = [1, 2, 4, 5]\  
, 4 = [1, 2, 3, 5], 5 = [1, 2, 3, 4]  
Adjacency list (in): 1 = [2, 3, 4, 5], 2 = [1, 3, 4, 5], 3 = [1, 2, 4, 5],\  
4 = [1, 2, 3, 5], 5 = [1, 2, 3, 4]  
Graph is undirected.
```

Now we get the vertices that form all adjacent edges [1, 2] .. [1, 5]:

```
Graph::getAdjacentEdgesLeaving(G1, [1])
```

```
[2, 3, 4, 5]
```

Now we get the vertices that form all adjacent edges [2, 1] .. [2, 5]:

```
Graph::getAdjacentEdgesLeaving(G1, [2])
```

```
[1, 3, 4, 5]
```

## Parameters

### **G**

A graph

### **Vertex**

One vertex of G.

## Return Values

List

## Graph::getBestAdjacentEdge

Returns the "best" incident edges.

### Syntax

```
Graph::getBestAdjacentEdge(G, Vertex, Vertices, <Min | Max>, <Weights | Costs>)
```

### Description

Graph::getBestAdjacentEdge(G, Vertex) returns the best incident edge according to specified attributes.

Graph::getBestAdjacentEdge(G, Vertex, Vertices) returns a vertex v out of Vertices. The best edge is (Vertex, v) according to the specifications.

### Examples

#### Example 1

Let us create a graph and find out the edge with the least weight:

```
G1 := Graph([1, a, 3, 4], [[1, a], [1, 3], [1, 4]],  
            EdgeWeights = [10, 20, 30],  
            EdgeCosts = [30, 20, 10]):  
Graph::getBestAdjacentEdge(G1, [1], Graph::getVertices(G1)),  
Graph::getBestAdjacentEdge(G1, [1], Graph::getVertices(G1),  
                            Min, Weights)
```

*a, a*

The result shows that edge [1, a] has the least weight. It also shows that Min and Weights are the defaults if omitted. Next, we want to know the edge with maximum weight:

```
Graph::getBestAdjacentEdge(G1, [1], Graph::getVertices(G1), Max)
```

4

The vertex with maximum weight is edge [1,4]. Now we have a look at the costs. The minimum cost edge can be found with:

```
Graph::getBestAdjacentEdge(G1, [1], Graph::getVertices(G1), Costs)
```

4

So the vertex with maximum weight is also the edge with minimum costs. Finally let us search for the edge with maximum costs:

```
Graph::getBestAdjacentEdge(G1, [1], Graph::getVertices(G1),  
                           Costs, Max)
```

a

## Parameters

### **G**

A graph

### **Vertex**

One vertex of G.

### **Vertices**

Vertices in G.

## **Options**

### **Min**

If stated, the edge with the minimum attribute will be found. (Default)

### **Max**

If stated, the edge with the maximum attribute will be found.

### **Weights**

If stated, edge weights will be used for comparison. (Default)

### **Costs**

If stated, edge costs will be used for comparison.

## **Return Values**

Vertex



## Graph::getEdgeCosts

Returns a table with the edge costs.

### Syntax

Graph::getEdgeCosts(G)

### Description

Graph::getEdgeCosts(G) returns a table with the edge costs of the graph G. Thus Graph::getEdgeCosts(G) returns the costs of all edges in G.

---

**Note** Costs will most probably only be defined, if transportation problems occur.

---

---

**Note** If FAIL is returned, no costs were defined (this way both, network and graph algorithms handle this situation correct.)

---

### Examples

#### Example 1

First lets define a graph without edge costs:

```
G1 := Graph::createCircleGraph(3):  
Graph::getEdgeCosts(G1)
```

FAIL

FAIL was returned, because no edge costs were defined.

```
Graph::getEdges(G1);  
G1 := Graph::setEdgeCosts(G1, [[1, 2], [3, 1]], [5, 1/2]):  
Graph::getEdgeCosts(G1)
```

```
[[1, 2], [2, 3], [3, 1]]
```

[1, 2]	5
[3, 1]	$\frac{1}{2}$

The first output shows all the edges and the second one the assigned edge costs.

## Parameters

**G**

A graph

## Return Values

Table

# Graph::getEdgeDescriptions

Returns a table with the edge descriptions.

## Syntax

```
Graph::getEdgeDescriptions(G)
```

## Description

Graph::getEdgeDescriptions(G) returns a table with the edge descriptions of the graph G. Thus Graph::getEdgeDescriptions(G) returns the weight of all edges in G.

---

**Note** Descriptions will most probably only be defined, if transportation problems occur.

---

**Note** If FAIL is returned, no descriptions were defined (this way both, network and graph algorithms handle this situation correct.)

---

## Examples

### Example 1

First lets define a graph without edge descriptions:

```
G1 := Graph::createCircleGraph(3):  
Graph::getEdgeDescriptions(G1)
```

FAIL

FAIL was returned, because no edge descriptions were defined.

```
Graph::getEdges(G1);  
G1 := Graph::setEdgeDescriptions(G1, [[1, 2], [3, 1]],
```

```
Graph::getEdgeDescriptions(G1) ["Shortcut", "Highway 66"]:
```

```
[[1, 2], [2, 3], [3, 1]]
```

[1, 2]	"Shortcut"
[3, 1]	"Highway 66"

The first output shows all the edges and the second one the assigned edge descriptions.

## Parameters

**G**

A graph

## Return Values

Table

## Graph::getEdges

Returns a list with all edges

### Syntax

```
Graph::getEdges(G)
```

### Description

Graph::getEdges(G) returns a list containing all edges of the graph G. Each edge is represented by a list containing the two connected vertices.

### Examples

#### Example 1

Graph::getEdges only returns the edges, without their capacities:

```
G1 := Graph::createCircleGraph([v1, v2, v3, v4]):  
Graph::getEdges(G1)
```

```
[[v1, v2], [v2, v3], [v3, v4], [v4, v1]]
```

```
G2 := Graph::createCompleteGraph(3):  
Graph::getEdges(G2)
```

```
[[1, 2], [1, 3], [2, 1], [2, 3], [3, 1], [3, 2]]
```

## **Parameters**

**G**

A Graph

## **Return Values**

List of all edges, a list of lists

# Graph::getEdgesEntering

Returns the incoming edges

## Syntax

Graph::getEdgesEntering(G)

## Description

Graph::getEdgesEntering(G) returns a table with the adjacency lists for incident (incoming) edges. Thus Graph::getEdgesEntering(G) returns a table containing all those vertices  $w$  for which there is an edge  $[w, v]$  in  $G$ .

## Examples

### Example 1

A small directed graph is created to show the incoming (incident) edges:

```
V := [1, 2, 3, 4, 5]:
Ed := [[1, 2], [1, 3], [2, 3], [2, 4], [3, 4], [3, 5], [4, 5]]:
G1 := Graph(V, Ed, Directed):
Graph::getEdgesEntering(G1)
```

1	[]
2	[1]
3	[1, 2]
4	[2, 3]
5	[3, 4]

In an undirected graph the output could look like this:

```
G1 := Graph::createCompleteGraph(5):  
Graph::getEdgesEntering(G1)
```

```
1 | [2, 3, 4, 5]  
2 | [1, 3, 4, 5]  
3 | [1, 2, 4, 5]  
4 | [1, 2, 3, 5]  
5 | [1, 2, 3, 4]
```

## Parameters

**G**

A graph

## Return Values

Table



# Graph::getEdgesLeaving

Returns the outgoing edges

## Syntax

```
Graph::getEdgesLeaving(G)
```

## Description

Graph::getEdgesLeaving(G) returns a table with the adjacency lists for adjacent (outgoing) edges. Thus Graph::getEdgesLeaving(G) returns a table containing all those vertices w for which there is an edge [v,w] in G.

## Examples

### Example 1

A small directed graph is created to show the outgoing (adjacent) edges:

```
V := [1, 2, 3, 4, 5]:
Ed := [[1, 2], [1, 3], [2, 3], [2, 4], [3, 4], [3, 5], [4, 5]]:
G1 := Graph(V, Ed, Directed):
Graph::getEdgesLeaving(G1)
```

1	[2, 3]
2	[3, 4]
3	[4, 5]
4	[5]
5	[]

In an undirected graph the output could look like this:

```
G1 := Graph::createCompleteGraph(5):  
Graph::getEdgesLeaving(G1)
```

1	[2, 3, 4, 5]
2	[1, 3, 4, 5]
3	[1, 2, 4, 5]
4	[1, 2, 3, 5]
5	[1, 2, 3, 4]

## Parameters

**G**

A graph

## Return Values

Table

## Graph::getEdgeNumber

Returns the number of edges.

### Syntax

```
Graph::getEdgeNumber(G)
```

### Description

Graph::getEdgeNumber(G) returns a number representing the number of edges in G.

### Examples

#### Example 1

Let us create a graph and find out the number of edges:

```
G1 := Graph([1, a, 3, 4], [[1, a], [1, 3], [1, 4]]):  
Graph::getEdgeNumber(G1)
```

6

We know that a complete graph consists of  $|Vertices|^2 - |Vertices|$  edges:

```
G2 := Graph::createCompleteGraph(4):  
Graph::getEdgeNumber(G2)
```

12

## **Parameters**

**G**

A graph

## **Return Values**

Number

# Graph::getEdgeWeights

Returns a table with the edge weights.

## Syntax

```
Graph::getEdgeWeights(G)
```

## Description

Graph::getEdgeWeights(G) returns a table with the edge weights of the graph G. Thus Graph::getEdgeWeights(G) returns the weight of all edges in G.

---

**Note** Weights will most probably only be defined, if transportation problems occur.

---

---

**Note** If FAIL is returned, no weights were defined (this way both, network and graph algorithms handle this situation correct.)

---

## Examples

### Example 1

First lets define a graph without edge weights:

```
G1 := Graph::createCircleGraph(3):  
Graph::getEdgeWeights(G1)
```

FAIL

FAIL was returned, because no edge weights were defined.

```
Graph::getEdges(G1);  
G1 := Graph::setEdgeWeights(G1, [[1, 2], [3, 1]], [5, 1/2]):  
Graph::getEdgeWeights(G1)
```

```
[[1, 2], [2, 3], [3, 1]]
```

```
-----  
[1, 2] | 5  
[3, 1] | 1/2
```

The first output shows all the edges and the second one the assigned edge weights.

## Parameters

**G**

A graph

## Return Values

Table

# Graph::getSubGraph

Returns a subgraph.

## Syntax

```
Graph::getSubGraph(G, Vertex)
```

## Description

`Graph::getSubGraph(G, Vertex)` returns a subgraph according to the specified vertices.

`Graph::getSubGraph(G)` returns a graph that only holds the specified vertices and the belonging edges.

## Examples

### Example 1

First, a complete graph is defined with some additional settings:

```
G1 := Graph::createCompleteGraph(5):
G1 := Graph::setEdgeWeights(G1, [[1,2]], [20]):
G1 := Graph::setEdgeCosts(G1, [[1, 2]], [20]):
G1 := Graph::setEdgeDescriptions(G1, [[1, 2]], ["Shortcut"]):
Graph::printGraphInformation(G1)
```

```
Vertices: [1, 2, 3, 4, 5]
Edges: [[1, 2], [1, 3], [1, 4], [1, 5], [2, 1], [2, 3], [2, 4], [2, 5], [3\
, 1], [3, 2], [3, 4], [3, 5], [4, 1], [4, 2], [4, 3], [4, 5], [5, 1], [5, \
2], [5, 3], [5, 4]]
Vertex weights: no vertex weights.
Edge descriptions: [1, 2] = "Shortcut", [2, 1] = "Shortcut"
Edge weights: [1, 2] = 20, [2, 1] = 20 (other existing edges have no weigh\
```

```
t)
Edge costs: [1, 2] = 20, [2, 1] = 20 (other existing edges have costs zero)
Adjacency list (out): 1 = [2, 3, 4, 5], 2 = [1, 3, 4, 5], 3 = [1, 2, 4, 5]\
, 4 = [1, 2, 3, 5], 5 = [1, 2, 3, 4]
Adjacency list (in): 1 = [2, 3, 4, 5], 2 = [1, 3, 4, 5], 3 = [1, 2, 4, 5],\
4 = [1, 2, 3, 5], 5 = [1, 2, 3, 4]
Graph is undirected.
```

Now we get the subgraph for the vertices 1, 2, 4:

```
G2 := Graph::getSubGraph(G1, [1, 2, 4]):
Graph::printGraphInformation(G2)
```

```
Vertices: [1, 2, 4]
Edges: [[1, 2], [1, 4], [2, 1], [2, 4], [4, 1], [4, 2]]
Vertex weights: no vertex weights.
Edge descriptions: [1, 2] = "Shortcut", [2, 1] = "Shortcut"
Edge weights: [1, 2] = 20, [2, 1] = 20 (other existing edges have no weigh\
t)
Edge costs: [1, 2] = 20, [2, 1] = 20 (other existing edges have costs zero)
Adjacency list (out): 1 = [2, 4], 2 = [1, 4], 4 = [1, 2]
Adjacency list (in): 1 = [2, 4], 2 = [1, 4], 4 = [1, 2]
Graph is undirected.
```

The subgraph for the vertices 1, 3, 4 looks like:

```
G2 := Graph::getSubGraph(G1, [1, 3, 4]):
Graph::printGraphInformation(G2)
```

```
Vertices: [1, 3, 4]
Edges: [[1, 3], [1, 4], [3, 1], [3, 4], [4, 1], [4, 3]]
Vertex weights: no vertex weights.
Edge descriptions: no edge descriptions.
Edge weights: no edge weights.
Edge costs: no edge costs.
Adjacency list (out): 1 = [3, 4], 3 = [1, 4], 4 = [1, 3]
Adjacency list (in): 1 = [3, 4], 3 = [1, 4], 4 = [1, 3]
Graph is undirected.
```



## Parameters

**G**

A graph

**Vertex**

A list containing one or more vertices of G.

## Return Values

Graph

## Graph::getVertexNumber

Returns the number of vertices.

### Syntax

```
Graph::getVertexNumber(G)
```

### Description

Graph::getVertexNumber(G) returns a number representing the number of vertices in G.

### Examples

#### Example 1

An example with 100 vertices:

```
G1 := Graph::createCompleteGraph(100):  
Graph::getVertexNumber(G1)
```

100

### Parameters

**G**

A graph

## Return Values

Number

## Graph::getVertexWeights

Returns a table with the vertex weights.

### Syntax

```
Graph::getVertexWeights(G)
```

### Description

Graph::getVertexWeights(G) returns a table with the vertex weights of the graph G. Thus Graph::getVertexWeights(G) returns the weight of all vertices in G.

---

**Note** If FAIL is returned, no weights were defined (this way both, network and graph algorithms handle this situation correct.)

---

### Examples

#### Example 1

First lets define a graph without vertex weights:

```
G1 := Graph::createCircleGraph(3):  
Graph::getVertexWeights(G1)
```

FAIL

FAIL was returned, because no vertex weights were defined.

```
Graph::getVertices(G1);  
G1 := Graph::setVertexWeights(G1, [1, 3], [5, 1/2]):  
Graph::getVertexWeights(G1)
```

[1, 2, 3]

1	5
3	$\frac{1}{2}$

The first output shows all the vertices and the second one the assigned vertex weights.

## Parameters

**G**

A graph

## Return Values

Table

## Graph::getVertices

Returns a list with all vertices

### Syntax

```
Graph::getVertices(G)
```

### Description

Graph::getVertices(G) returns the list of all vertices of the Graph G.

### Examples

#### Example 1

A small creation of two different graphs and the output getVertices generates:

```
G1 := Graph::createCompleteGraph(10):  
Graph::getVertices(G1)
```

```
[1, 2, 3, 4, 5, 6, 7, 8, 9, 10]
```

```
G2 := Graph::createCircleGraph([x.i $ i = 1..12]):  
Graph::getVertices(G2)
```

```
[x1, x2, x3, x4, x5, x6, x7, x8, x9, x10, x11, x12]
```

### Parameters

**G**

A graph

## Return Values

List

## Graph::inDegree

Returns the indegree of one or more vertices.

### Syntax

`Graph::inDegree(G, <Vertex>)`

### Description

`Graph::inDegree(G, Vertex)` returns the indegree of the vertex `Vertex` in the Graph `G`, i.e., the number of edges `[u,Vertex]`.

`Graph::inDegree(G, [v1, v2, ..., vn])` returns a table in which the keys are `v1, v2, ..., vn` and the corresponding values are the indegrees.

`Graph::inDegree(G)` returns a table in which each node of `G` is mapped to its indegree. `Graph::inDegree(G)` is equivalent to `Graph::inDegree(G, Graph::getVertices(G))`.

### Examples

#### Example 1

In a complete graph of  $n$  vertices, each vertex has indegree  $n - 1$ :

```
G := Graph::createCompleteGraph(5):
Graph::inDegree(G, [2, 4, 5]), Graph::inDegree(G),
Graph::inDegree(G, Graph::getVertices(G))
```

2	4	1	4	1	4
4	4	3	4	3	4
5	4	4	4	4	4
		5	4	5	4



The first table shows what happens, if some vertices are specified. The second and third table return all indegrees, but with two different calls (the second is redundant).

## Example 2

Remember that also only one vertex needs to be specified as a list!

```
G := Graph::createCompleteGraph(5):  
Graph::inDegree(G, [2])
```

$\frac{2}{4}$

## Parameters

**G**

A Graph

**Vertex**

A list containing one or more vertices.

## Return Values

Table containing all the indegrees of the specified vertices.

## Graph::**isConnected**

Finds out if the graph is connected

### Syntax

```
Graph::isConnected(G)
```

### Description

Graph::**isConnected**(G) returns TRUE if G is connected, FALSE otherwise.

### Examples

#### Example 1

A circle graph is made to create a connected Graph:

```
G1 := Graph::createCircleGraph(3):  
Graph::isConnected(G1)
```

TRUE

After adding a single vertex to the graph, it is not connected any more:

```
G2 := Graph::addVertices(G1, [4]):  
Graph::isConnected(G2)
```

FALSE

## Parameters

**G**

A graph

## Return Values

TRUE or FALSE

## Graph::isDirected

Finds out if the graph is directed

### Syntax

```
Graph::isDirected(G)
```

### Description

Graph::isDirected(G) returns TRUE if G is directed, FALSE otherwise.

### Examples

#### Example 1

A circle graph is made to create a directed Graph:

```
G1 := Graph::createCircleGraph(3):  
Graph::isDirected(G1)
```

TRUE

#### Example 2

Now a complete graph is created in order to get an undirected graph:

```
G1 := Graph::createCompleteGraph(3):  
Graph::isDirected(G1)
```

FALSE

## Parameters

**G**

A graph

## Return Values

TRUE or FALSE

## Graph::isEdge

Finds out if the edges exists

### Syntax

```
Graph::isEdge(G, Edge)
```

### Description

Graph::isEdge(G) returns TRUE if ALL specified edges exist in G, FALSE otherwise.

### Examples

#### Example 1

A circle graph is made to create a directed Graph:

```
G1 := Graph::createCircleGraph(3):  
Graph::printGraphInformation(G1)
```

```
Vertices: [1, 2, 3]  
Edges: [[1, 2], [2, 3], [3, 1]]  
Vertex weights: no vertex weights.  
Edge descriptions: no edge descriptions.  
Edge weights: no edge weights.  
Edge costs: no edge costs.  
Adjacency list (out): 1 = [2], 2 = [3], 3 = [1]  
Adjacency list (in): 1 = [3], 2 = [1], 3 = [2]  
Graph is directed.
```

First let us check for an existing single edge:

```
Graph::isEdge(G1, [[1, 2]] )
```

TRUE

Now we check if several edges exist:

```
Graph::isEdge(G1, [[1, 2], [2, 3]] )
```

TRUE

What about a non existing edge?

```
Graph::isEdge(G1, [[3, 2]] )
```

FALSE

Finally a list of some existing and non existing edges is checked:

```
Graph::isEdge(G1, [[1, 2], [2, 3], [3, 2]])
```

FALSE

## Parameters

**G**

A graph

**Edge**

A list containing one or more edges

## Return Values

TRUE or FALSE

## Graph::isVertex

Finds out if special vertices exist in the Graph

### Syntax

```
Graph::isVertex(G, Vertex)
```

### Description

Graph::isVertex(G) returns TRUE if ALL specified vertices exist in G, FALSE otherwise.

### Examples

#### Example 1

A circle graph is made to create a directed Graph:

```
G1 := Graph::createCircleGraph(3):  
Graph::printGraphInformation(G1)
```

```
Vertices: [1, 2, 3]  
Edges: [[1, 2], [2, 3], [3, 1]]  
Vertex weights: no vertex weights.  
Edge descriptions: no edge descriptions.  
Edge weights: no edge weights.  
Edge costs: no edge costs.  
Adjacency list (out): 1 = [2], 2 = [3], 3 = [1]  
Adjacency list (in): 1 = [3], 2 = [1], 3 = [2]  
Graph is directed.
```

First, let us check for an existing vertex:

```
Graph::isVertex(G1, [1])
```



TRUE

Now we check if several vertices exist:

```
Graph::isVertex(G1, [1, 2])
```

TRUE

What about a non existing vertex?

```
Graph::isVertex(G1, [4])
```

FALSE

Finally a list of some existing and non existing vertices is checked:

```
Graph::isVertex(G1, [1, 2, 4])
```

FALSE

## Parameters

**G**

A graph

**Vertex**

A list containing one or more vertices

## Return Values

TRUE or FALSE

## Graph::longestPath

Longest paths from one single node

### Syntax

```
Graph::longestPath(G, v, <w>, <Length>, <Path>)
```

### Description

`Graph::longestPath(G, v)` returns a table with the length of longest paths from `v` to all other nodes in the Graph with respect to the edge weight.

`Graph::longestPath(G, v, w)` returns the length of a longest path from `v` to `w`.

If the optional argument `Path` is given, a table with longest paths is returned. If both `Length` and `Path` are given, then both the length of the longest paths and the paths are returned. Paths are given as lists of nodes in reverse order.

If `Path` is not given, the option `Length` has no effect.

---

**Note** The Graph `G` must be directed and should not contain cycles.

---

## Examples

### Example 1

We construct a Graph and try a few calls to `Graph::longestPath`:

```
V := [1, 2, 3, 4, 5]:  
Ed := [[1, 2], [1, 3], [2, 3], [2, 4], [3, 4], [3, 5], [4, 5]]:  
Ew := [7, 6, 5, 4, 2, 2, 1]:  
G := Graph(V, Ed, EdgeWeights = Ew, Directed):  
Graph::longestPath(G, 1)
```

1	0
2	7
3	12
4	14
5	15

`Graph::longestPath(G, 1, Path)`

2	[2, 1]
3	[3, 2, 1]
4	[4, 3, 2, 1]
5	[5, 4, 3, 2, 1]

## Parameters

**G**

A Graph

**v, w**

Vertices in G

## Options

**Length**

Return a table with the lengths of shortest paths

**Path**

Return a table with the paths themselves

## Return Values

Table, an integer or a list of nodes

## **Algorithms**

The implemented algorithm is a variation of the algorithm of Bellman.

## Graph::maxFlow

Computes a maximal flow through a graph

### Syntax

```
Graph::maxFlow(G, s, t)
```

### Description

`Graph::maxFlow(G, s, t)` computes a maximal flow from `s` to `t` in `G` with respect to the edge capacities. `s` and `t` must be nodes in `G`.

`Graph::maxFlow(G, s, t)` returns a sequence containing the flow value, that is the inflow of `s`, which equals the outflow of `s`, and the flow itself in form of table `tbl` with the flow from vertex `v` to vertex `w` is `tbl[[v,w]]`.

### Examples

#### Example 1

In the complete Graph with four vertices and default capacities of 1, the maximum flow from one vertex to another one consists of sending one unit through each of the remaining vertices and one directly, which makes three units altogether:

```
G1 := Graph::createCompleteGraph(4):  
Graph::maxFlow(G1, [1], [4])
```

	[1, 2]	1
	[2, 1]	0
	[1, 3]	1
	[3, 1]	0
	[1, 4]	1
3,	[2, 3]	0
	[3, 2]	0
	[4, 1]	0
	[2, 4]	1
	[4, 2]	0
	[3, 4]	1
	[4, 3]	0

## Example 2

As a more complex example, the following graph shows that this function also finds flows through multiple edges, unlike `Graph::admissibleFlow`, which only works on completely described flows:

```
V := [1, 2, 3, s, t]:
Edge := [[s, 1], [t, 2], [1, 2], [1, 3], [2, 3], [3, t]]:
up := [5, 5, 2, 6, 6, 1]:
G2 := Graph(V, Edge, EdgeCosts = up, Directed):
Graph::maxFlow(G2, [s], [t])
```

	[1, 2]	0
	[1, 3]	1
1,	[2, 3]	0
	[s, 1]	1
	[t, 2]	0
	[3, t]	1

## Parameters

**G**

Graph

**s, t**

Expressions (vertices in G)

## Return Values

List, containing a number and a table

## Algorithms

The implemented algorithm is the preflow-push algorithm of Goldberg & Tarjan with the FIFO selection strategy and an exact distance labeling ("A new approach to the maximum-flow problem", Journal of the ACM 35(4), 1988).

The running time is  $O(n^3)$ , where  $n$  is the number of vertices in the Graph.

## Graph::minCost

Computes a minimal cost flow

### Syntax

`Graph::minCost(G)`

### Description

`Graph::minCost(G)` computes a minimum cost flow in  $G$  with respect to the edge capacities, the edge weights and the vertex weights of  $G$ .

The vertex weights are interpreted as supply and demand. The edge weights give restrictions for the flow on every edge. The edge costs are the cost for one unit flow over an edge.

The algorithm computes a flow, if there is any, which is possible and satisfactory, i.e., it is within the supply and demand range, which respects the capacities and which has minimal cost. For details, see “Algorithms” on page 11-107 (Symbolic Math Toolbox).

### Examples

#### Example 1

We construct a Graph with five vertices and seven edges. One of the vertices is a pure source (1), another one is a pure sink (5). No other vertices supply or demand any goods, they only serve as transportation junctions:

```
V := [1, 2, 3, 4, 5]:  
Vw := [25, 0, 0, 0, -25]:  
edges := [[1, 2], [1, 3], [2, 3], [2, 4], [3, 4], [3, 5], [4, 5]]:  
Ec := [7, 6, 5, 4, 2, 2, 1]:  
Ew := [30, 20, 25, 10, 20, 25, 20]:  
G1 := Graph(V, edges, EdgeCosts = Ec, EdgeWeights = Ew,
```



VertexWeights = Vw, Directed):  
 Graph::minCost(G1)

[1, 2]	5	[1, 2]	35	
[1, 3]	20	[1, 3]	120	
[2, 3]	0	[2, 3]	0	, 220,
[2, 4]	5	[2, 4]	20	
[3, 4]	0	[3, 4]	0	
[3, 5]	20	[3, 5]	40	
[4, 5]	5	[4, 5]	5	

1	12
2	5
3	2
4	1
5	0

All 25 units could be transported from vertex 1 to vertex 5, for a total cost of 220. The cost for each edge can be found in the first table, the accumulated costs in the second and the last table holds the dual prices. For example 6 units flow over edge [1, 3] since  $6 \cdot 20 = 120$  and 7 units flow over edge [1, 2] since  $7 \cdot 5 = 35$ .

## Parameters

**G**

Graph

## Return Values

Sequence, consisting of three tables and a number. The first table holds the amount flowing over the edges, the second the accumulated costs for each used edge and the number is the sum of all edge-costs for the flow. The last table holds the dual prices for each vertex.

## Algorithms

The implemented algorithm is the relaxation algorithm due to Bertsekas (taken from Bertsekas, "Linear Network Optimization", MIT Press, Cambridge(Mass.)-London, 1991) which is known to be one of the fastest algorithms in practice.

The minimum cost flow tries to minimize the cost of a certain amount of flow through a graph. Specifically, the minimum cost flow minimizes

$$\sum_{(i,j) \in A} a_{ij} x_{ij}$$

subject to

$$\sum_{\{j|(i,j) \in A\}} x_{ij} - \sum_{\{j|(j,i) \in A\}} x_{ji} = s_i, \quad \forall i \in N \quad (1.1)$$

$$b_{ij} \leq x_{ij} \leq c_{ij}, \quad \forall (i,j) \in A, \quad (1.2)$$

where,

$N$  = vertices of graph

$A$  = edges of graph

$a_{ij}$  = edge cost of edge (i,j)

$x_{ij}$  = minimal flow through edge (i,j)

$s_i$  = vertex weight of vertex  $i$

$c_{ij}$  = edge weight of edge (i,j).

If the vertex weights  $s_i$  do add up to 0 then Graph : :minCost errors.

If constraints (1.1) and (1.2) cannot be satisfied with  $s_i$  and  $c_{ij}$ , then Graph : :minCost throws an error.

# Graph::minCut

Computes a minimal cut

## Syntax

```
Graph::minCut(G, q, s)
```

## Description

`Graph::minCut(G, q, s)` computes a minimal cut in  $G$  that separates  $q$  from  $s$ , i.e., a subset  $T$  of the set  $S$  of edges of  $G$  such that every path from  $q$  to  $s$  contains at least one edge in  $T$ . The cut is minimal with respect to the capacities of the edges.

`Graph::minCut(G, q, s)` returns a sequence consisting of the cut value (the sum of the edge weights of the cut edges) and a list with the edges of the cut.

Note that  $q$  is separated from  $s$ , not vice versa.

## Examples

### Example 1

In a complete graph, a vertex can be separated from another one only by cutting all edges starting at the first vertex:

```
G1 := Graph::createCompleteGraph(4):  
Graph::minCut(G1, [1], [4])
```

```
3, [[1, 2], [1, 3], [1, 4]]
```

## Example 2

In the following example, the edge from vertex  $q$  to vertex 1 could have been used as well, but its edge capacity is higher than that of the edge used, so the minimality condition precludes this choice:

```
V := [1, 2, 3, q, s]:  
Edge := [[q, 1], [1, 2], [1, 3], [2, 3], [3, s]]:  
up := [5, 2, 6, 6, 1]:  
G2 := Graph(V, Edge, EdgeWeights = up, Directed):  
Graph::minCut(G2, [q], [s])
```

1, [[3, s]]

There is no path from vertex  $s$  to vertex  $q$  (or any other vertex of the Graph), so no cut is necessary to separate  $s$  from  $q$ :

```
Graph::minCut(G2, [s], [q])
```

0, []

## Parameters

$q, s$

Vertices that have to be defined within  $G$

$G$

Graph

## Return Values

Sequence, consisting of the “cut value” and a list of edges cut

# Graph::minimumSpanningTree

Creates a MST

## Syntax

`Graph::minimumSpanningTree(G, <SearchFor = Weights | Costs>, <ReturnAsTable>)`

## Description

`Graph::minimumSpanningTree(G)` creates a minimum spanning tree of Graph G according to the weights of the edges and returns a Graph consisting only of them. The same result would be achieved using `Graph::minimumSpanningTree(G, SearchFor = Weights)`

`Graph::minimumSpanningTree(G, SearchFor = Costs)` creates a minimum spanning tree according to the costs of the edges and returns a Graph consisting only of them.

`Graph::minimumSpanningTree(G, ReturnAsTable)` creates a minimum spanning tree according to the weights of the edges and returns a list with two objects. The first is a table consisting of the used edges and their weights. The second object is a number containing the sum of all the edge weights.(The same result can be achieved using: `Graph::minimumSpanningTree(G, SearchFor=Weights, ReturnAsTable)`.)

`Graph::minimumSpanningTree(G, SearchFor=Costs, ReturnAsTable)` creates a minimum spanning tree according to the costs of the edges and returns a list with two objects. The first is a table consisting of the used edges and their costs. The second object is a number containing the sum of all the edge costs.

## Examples

### Example 1

The following graph  $G$  will be used throughout all the examples. For details on the format of  $G$ , see `Graph`. (Have a look at the edge  $[c, f]$ . This edge is responsible for the different outputs whether `Costs` or `Weights` was chosen.)

```
G := Graph([a, b, c, d, e, f, g, h, i],
           [[a, b], [a, h], [b, h], [b, c], [c, d], [d, f], [d, e],
            [f, e], [h, g], [g, f], [c, i], [h, i], [g, i], [c, f]],
           EdgeWeights = [4, 8, 11, 8, 7, 14, 9, 10, 1, 2, 2, 7, 6, 4],
           EdgeCosts   = [4, 8, 11, 8, 7, 14, 9, 10, 1, 2, 2, 7, 6, 12]):
```

We will plot this graph and all graphs derived from it using `Graph::plotGridGraph` with the following options:

```
plotOptions :=
  VerticesPerLine=7,
  VertexOrder = [
    None, b,   None, c,   None, d,   None,
    a,   None, i,   None, None, None, e,
    None, h,   None, g,   None, f,   None]:

plot(Graph::plotGridGraph(G, plotOptions))
```

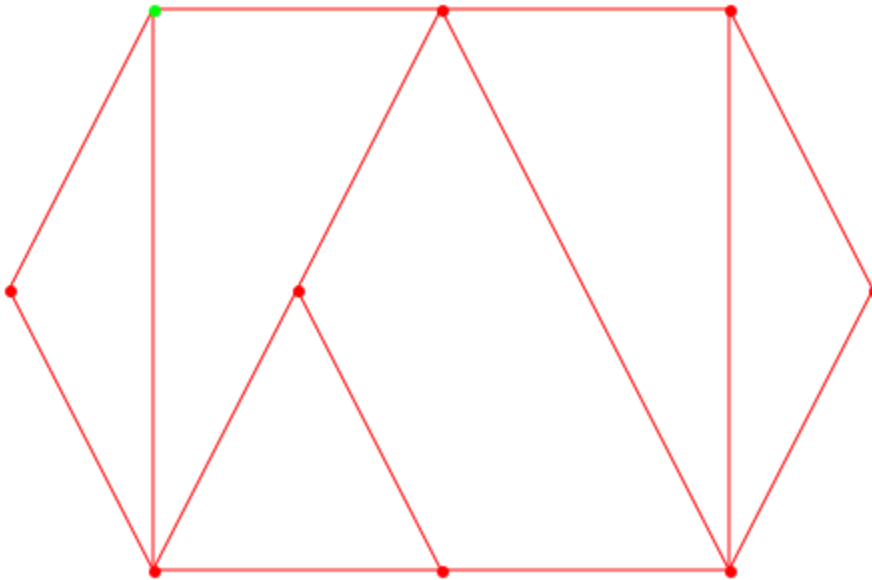

Now we use this Graph to create a minimum spanning tree according to the weights of the edges and have a look which edges were used:

```
Graph::minimumSpanningTree(G, SearchFor = Weights, ReturnAsTable),  
Graph::minimumSpanningTree(G, ReturnAsTable)
```

$\sigma_1, \sigma_1$

where

$$\sigma_1 = \begin{array}{|l|l} [a, b] & 4 \\ [b, a] & 4 \\ [b, c] & 8 \\ [c, b] & 8 \\ [c, d] & 7 \\ [d, c] & 7 \\ [c, f] & 4 \\ [d, e] & 9, 37 \\ [e, d] & 9 \\ [f, c] & 4 \\ [c, i] & 2 \\ [i, c] & 2 \\ [f, g] & 2 \\ [g, f] & 2 \\ [g, h] & 1 \\ [h, g] & 1 \end{array}$$

Both calls return exactly the same tables. That was expected and just to show that it is of no importance if the additional `SearchFor=Weights` is omitted.

Now we want to get the minimum spanning tree returned as a Graph so we can have a look how it looks like

```
weightMST := Graph::minimumSpanningTree(G):
plot(Graph::plotGridGraph(weightMST, plotOptions,
                           EdgeColor = RGB::Green))
```



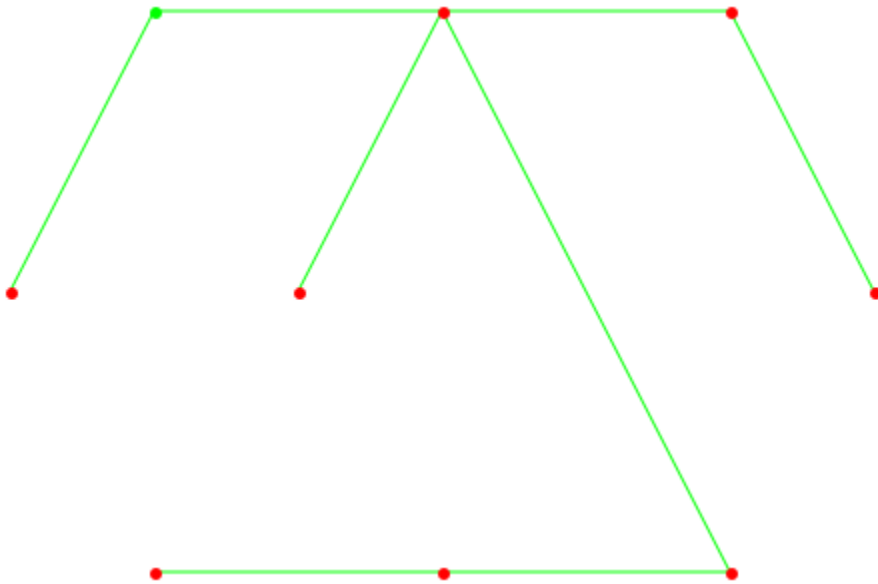

There are two ways of displaying both graphs at the same time:

```
plot(  
  Graph::plotGridGraph(G, plotOptions, EdgeColor = RGB::Black),  
  Graph::plotGridGraph(weightMST, plotOptions,  
    EdgeColor = RGB::Green)  
)
```

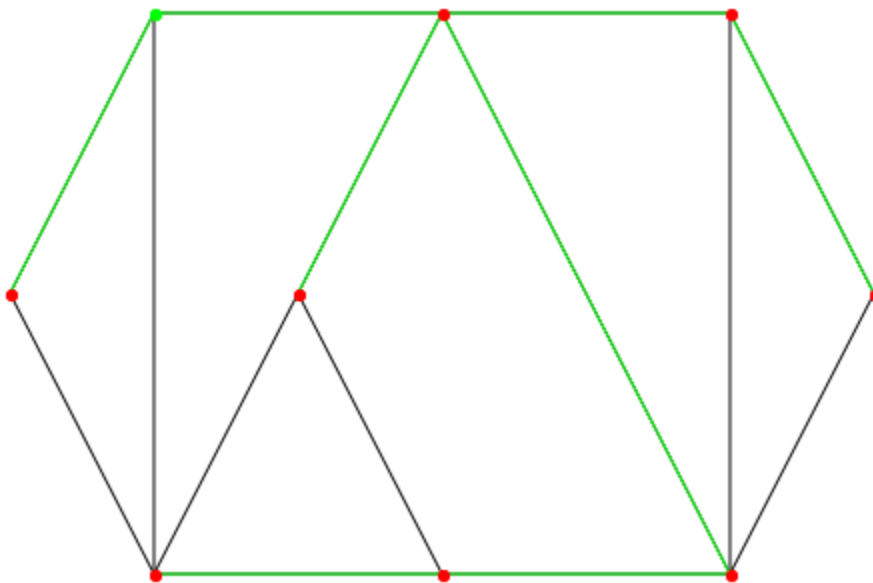

```
edgesWeightMST := Graph::getEdges(weightMST):  
plot(Graph::plotGridGraph(G, plotOptions,  
    EdgeColor = RGB::Black,  
    SpecialEdges = edgesWeightMST,  
    SpecialEdgeColor = RGB::Green))
```

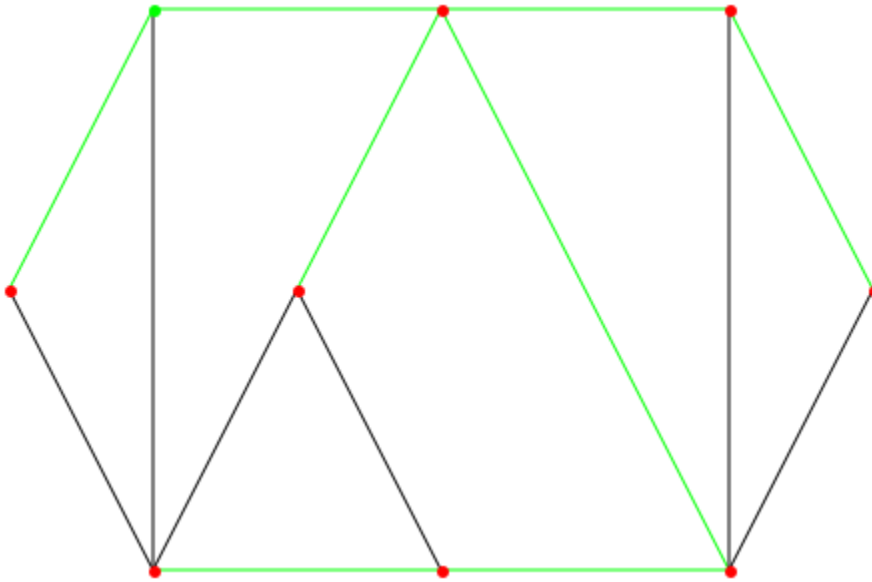

## Example 2

Maybe instead of the weights there is an interest in getting the MST for the costs of the edges.

```
G := Graph([a, b, c, d, e, f, g, h, i],
  [[a, b], [a, h], [b, h], [b, c], [c, d], [d, f], [d, e],
   [f, e], [h, g], [g, f], [c, i], [h, i], [g, i], [c, f]],
  EdgeWeights = [4, 8, 11, 8, 7, 14, 9, 10, 1, 2, 2, 7, 6, 4],
  EdgeCosts   = [4, 8, 11, 8, 7, 14, 9, 10, 1, 2, 2, 7, 6, 12]):
```

```
Graph::minimumSpanningTree(G, SearchFor = Costs, ReturnAsTable)
```

$[a, b]$	4
$[b, a]$	4
$[b, c]$	8
$[c, b]$	8
$[c, d]$	7
$[d, c]$	7
$[d, e]$	9
$[e, d]$	9, 39
$[c, i]$	2
$[i, c]$	2
$[f, g]$	2
$[g, f]$	2
$[g, h]$	1
$[h, g]$	1
$[g, i]$	6
$[i, g]$	6

Plotting this spanning tree is just as easy as above:

```
costMST := Graph::minimumSpanningTree(G, SearchFor = Costs):  
plot(Graph::plotGridGraph(costMST, plotOptions,  
    EdgeColor = RGB::Blue))
```

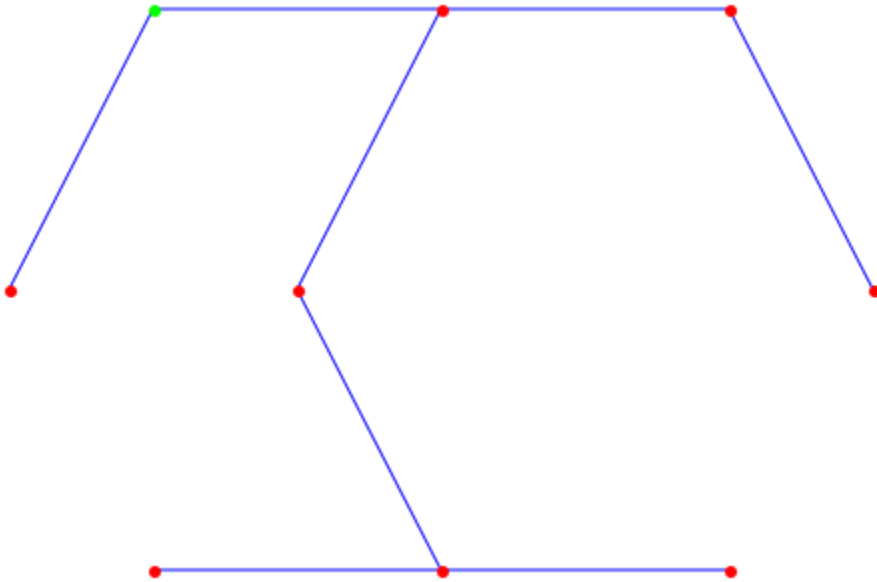

To combine both spanning trees, we use different line widths, to avoid one graph being completely covered by the other:

```
plot(
  plot::Group2d(
    Graph::plotGridGraph(costMST, plotOptions,
      EdgeColor = RGB::Blue),
    LineWidth = 2.5
  ),
  plot::Group2d(
    Graph::plotGridGraph(G, plotOptions,
      EdgeColor = RGB::Black),
    Graph::plotGridGraph(weightMST, plotOptions,
      EdgeColor = RGB::Green),
    PointSize = 5,
    LineWidth = 1
  )
)
```

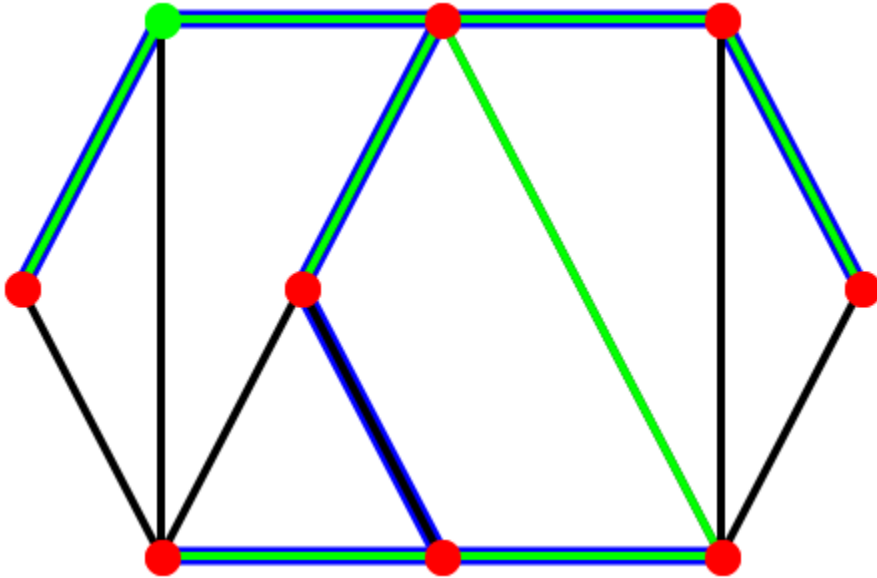

## Parameters

**G**

Graph

## Options

**SearchFor**

Can either be `Costs` or `Weights`. Default is `Weights`

**ReturnAsTable**

If omitted, a Graph is returned, otherwise a list containing a table and the sum of the edge weights/costs.

## Return Values

Graph consisting of the MST. Only if `ReturnAsTable` was specified, a list containing a table and a number are returned. The table holds the edges with either the weights or costs of each edge and the number is the sum of all edges.

# Graph

Creates new graph

## Syntax

`Graph(V, E, <VertexWeights = vw>, <EdgeDescriptions = ed>, <EdgeWeights = ew>, <EdgeCos`

## Description

`Graph(V, E)` creates a graph.

`Graph([v1, ..., vn], [e1, ..., em])` generates a new undirected graph with  $n$  vertices and  $m$  edges.

`Graph([1,a,3], [[1,a],[1,3]], Directed)` generates a new directed graph with the vertices 1, a, 3 and the edges [1,a], [1,3].

`Graph([a,b,3], [[a,b],[b,3]], VertexWeights = [1,2,3], EdgeWeights = [4,5])` generates a new directed graph where the vertices have the values  $a=1$ ,  $b=2$ ,  $3=3$  and the edges  $[a,b]=4$ ,  $[b,3]=5$ .

`Graph([a,b,3], [[a,b],[b,3]], VertexWeights = [1,None,3], EdgeWeights = [4, None])` generates a new directed graph where the vertices have the values  $a=1$ ,  $3=3$  and the edges  $[a,b]=4$ . The difference to the example directly above is that the keyword `None` can be used to not assign a value to a vertex or edge.

## Examples

### Example 1

An (undirected) graph with four vertices:

```
G1 := Graph([1,a,3], [[1,a],[1,3]]):  
Graph::printGraphInformation(G1)
```



```

Vertices: [1, 3, a]
Edges: [[1, 3], [1, a], [3, 1], [a, 1]]
Vertex weights: no vertex weights.
Edge descriptions: no edge descriptions.
Edge weights: no edge weights.
Edge costs: no edge costs.
Adjacency list (out): 1 = [3, a], a = [1], 3 = [1]
Adjacency list (in): 1 = [3, a], a = [1], 3 = [1]
Graph is undirected.

```

## Example 2

The same graph but this time with parameter `Directed`:

```

G1 := Graph([1,a,3], [[1,a],[1,3]], Directed):
Graph::printGraphInformation(G1)

```

```

Vertices: [1, 3, a]
Edges: [[1, 3], [1, a]]
Vertex weights: no vertex weights.
Edge descriptions: no edge descriptions.
Edge weights: no edge weights.
Edge costs: no edge costs.
Adjacency list (out): 1 = [3, a], a = [], 3 = []
Adjacency list (in): 1 = [], a = [1], 3 = [1]
Graph is directed.

```

## Example 3

The circle graph with predefined vertices:

```

G3 := Graph([a,b,3], [[a,b],[b,3]],
            VertexWeights = [1,2,3],
            EdgeWeights = [4,5]):
Graph::printGraphInformation(G3)

```

```

Vertices: [3, a, b]
Edges: [[3, b], [a, b], [b, 3], [b, a]]
Vertex weights: a = 1, b = 2, 3 = 3 (other existing vertices have no weight)

```

Edge descriptions: no edge descriptions.  
 Edge weights: [a, b] = 4, [b, 3] = 5, [b, a] = 4, [3, b] = 5 (other existing edges have no weight)  
 Edge costs: no edge costs.  
 Adjacency list (out): a = [b], b = [3, a], 3 = [b]  
 Adjacency list (in): a = [b], b = [3, a], 3 = [b]  
 Graph is undirected.

## Example 4

The circle graph with predefined vertices:

```
G3 := Graph([a,b,3,7], [[a,b],[b,3],[3,7]],
VertexWeights = [1,2,3,4], EdgeWeights = [-1,-2,-5],
EdgeDescriptions = ["Small", None, "Smallest"]):
Graph::printGraphInformation(G3)
```

```
Vertices: [3, 7, a, b]
Edges: [[3, 7], [3, b], [7, 3], [a, b], [b, 3], [b, a]]
Vertex weights: a = 1, b = 2, 3 = 3, 7 = 4 (other existing vertices have no weight)
Edge descriptions: [a, b] = "Small", [3, 7] = "Smallest", [b, a] = "Small", [7, 3] = "Smallest"
Edge weights: [a, b] = -1, [b, 3] = -2, [3, 7] = -5, [b, a] = -1, [3, b] = -2, [7, 3] = -5 (other existing edges have no weight)
Edge costs: no edge costs.
Adjacency list (out): a = [b], b = [3, a], 3 = [7, b], 7 = [3]
Adjacency list (in): a = [b], b = [3, a], 3 = [7, b], 7 = [3]
Graph is undirected.
```

If you look at the edge descriptions, the keyword `None` can be used for every edge which is not supposed to have a description.

## Parameters

**V**

List of vertices

**E**

List of edges

**vw, ew, ec**

List of numbers

**ed**

List of strings

## **Options**

### **Directed**

The Graph is created as a directed graph.

### **Undirected**

The Graph is created as an undirected graph. **Default.**

## Graph::outDegree

Returns the outdegree of one or more vertices.

### Syntax

`Graph::outDegree(G, <Vertex>)`

### Description

`Graph::outDegree(G)` returns the number of edges leaving each vertex `Vertex` of the Graph `G`.

`Graph::outDegree(G, Vertex)` returns the outdegree of the vertex `Vertex` in the Graph `G`, i.e., the number of edges `[Vertex, u]`.

`Graph::outDegree(G, [v1, v2, ..., vn])` returns a table in which the keys are `v1, v2, ..., vn` and the corresponding values are the outdegrees.

`Graph::outDegree(G)` returns a table in which each node of `G` is mapped to its outdegree. `Graph::outDegree(G)` is equivalent to `Graph::outDegree(G, Graph::getVertices(G))`.

### Examples

#### Example 1

In a complete graph of  $n$  vertices, each vertex has outdegree  $n - 1$ :

```
G := Graph::createCompleteGraph(5):  
Graph::outDegree(G, [2, 4, 5]), Graph::outDegree(G),  
Graph::outDegree(G, Graph::getVertices(G))
```

2	4	1	4	1	4
4	4	2	4	2	4
5	4	4	4	4	4
		5	4	5	4

The first table shows what happens, if some vertices are specified. The second and third table return all indegrees, but with two different calls (the second is redundant).

## Example 2

Remember that also only one vertex needs to be specified as a list !

```
G := Graph::createCompleteGraph(5):
Graph::outDegree(G, [2])
```

2	4
---	---

## Parameters

**G**

A Graph

## Options

**Vertex**

A list containing one or more vertices.

## Return Values

Table containing all the outdegrees of the specified vertices.

## Graph::plotBipartiteGraph

Plots a Graph in a bipartite layout

### Syntax

```
Graph::plotBipartiteGraph(G, <PointSize = n>, <SpecialVertices = [v1, ..., vn]>, <SpecialE
```

### Description

`Graph::plotBipartiteGraph(G)` returns a `plot::Group2d` object in which the vertices are ordered in two rows (from bottom to top). The first vertex in the left row is drawn in blue and the second (the first vertex in the right row) in green. All other vertices are drawn in red. The width of the points is predefined with 40.

### Examples

#### Example 1

A random graph is created and plotted (your output may differ due to random creation):

```
G1 := Graph::createRandomGraph(110, 10, Undirected):  
plot(Graph::plotBipartiteGraph(G1)):
```

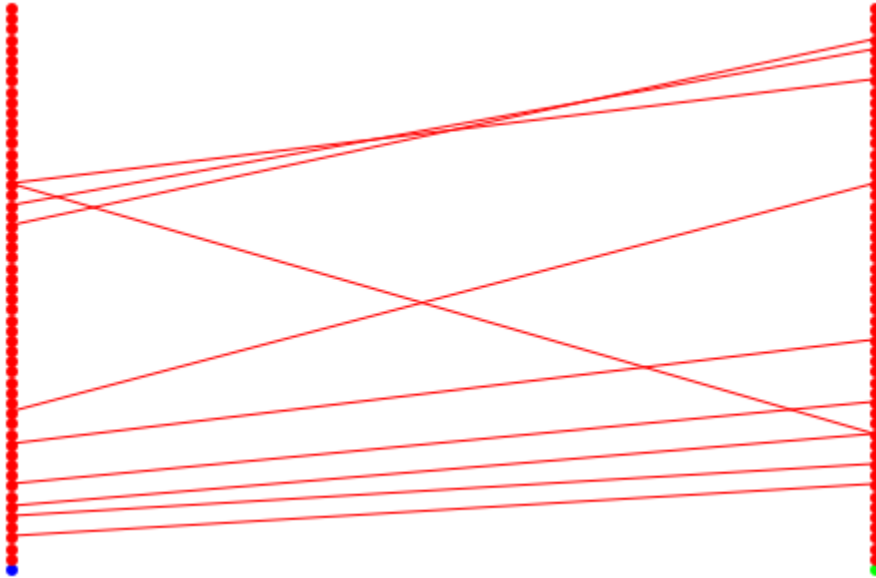

## Example 2

If some edges are to be emphasized they can be drawn in a special color:

```
G2 := Graph([1, 2, 3, 4, 5, 6],
            [[1, 2], [2, 3], [3, 4], [4, 5], [1, 6]]):
Graph::bipartite(G2, Lists)
```

```
[[2, 4, 6], [1, 3, 5]]
```

```
edges := [[6, 1], [1, 2]]:
plot(Graph::plotBipartiteGraph(G2, SpecialEdges = edges,
                               SpecialEdgeColor = RGB::Blue))
```

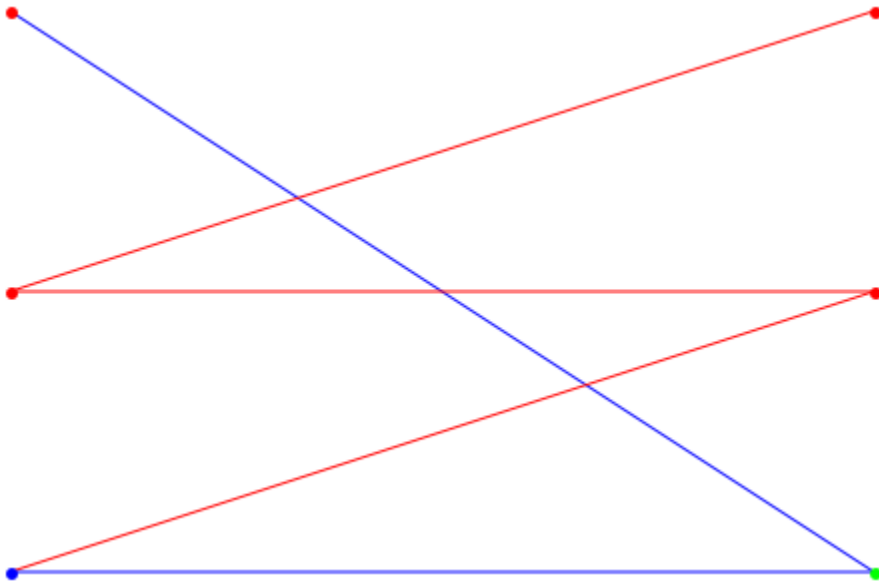

## Parameters

**G**

Graph

**n**

a positive integer

**$[v_1, \dots, v_n]$**

a list of vertices

**$[e_1, \dots, e_n]$**

a list of edges



## Options

### **PointSize**

Defines the thickness in which the points are drawn. Default is 40.

### **SpecialVertices**

Defines a set of vertices. This option makes only sense if used with the option `SpecialVertexColor`.

### **SpecialEdges**

Defines a set of edges. This option makes only sense if used with the option `SpecialEdgeColor`.

### **EdgeColor**

Defines a color with which to draw the edges. Default is `RGB : :Red`.

### **SpecialEdgeColor**

Defines a color to be used to draw the set of edges specified. This option makes only sense if used with the option `SpecialEdges`.

### **VertexColor**

Defines a color with which to draw the vertices. If this option is specified, the first two vertices are set to this color, too. They can be given different colors via `Vertex1Color` and `Vertex2Color`. Default is `RGB : :Red`.

### **SpecialVertexColor**

Defines a color to be used to draw the set of vertices specified. This option makes only sense if used with the option `SpecialVertices`.

### **Vertex1Color**

Defines a color with which to draw the first vertex with (the starting vertex at the bottom of the first set). Default is `RGB : :Blue`.

### **Vertex2Color**

Defines a color with which to draw the second vertex with (the starting vertex at the bottom of the second set). Default is `RGB: :Green`.

### **Return Values**

`plot::Group2d`

# Graph::plotCircleGraph

Plots a Graph in a circle layout

## Syntax

```
Graph::plotCircleGraph(G, <PointSize = n>, <SpecialVertices = [v1, ..., vn]>, <SpecialEdge
```

## Description

`Graph::plotCircleGraph(G)` returns a `plot::Group2d` object in which the vertices are ordered in a circle (rightmost position upwards). The first vertex is drawn in blue and the second in green. All other vertices are drawn in red. The edges are drawn in red. The width of the points is predefined with 40. If a vertex points to itself it will be drawn outside

## Examples

### Example 1

A random graph is created and plotted (your output may differ due random creation):

```
G1 := Graph::createRandomGraph(20, 10, Undirected):  
plot(Graph::plotCircleGraph(G1))
```

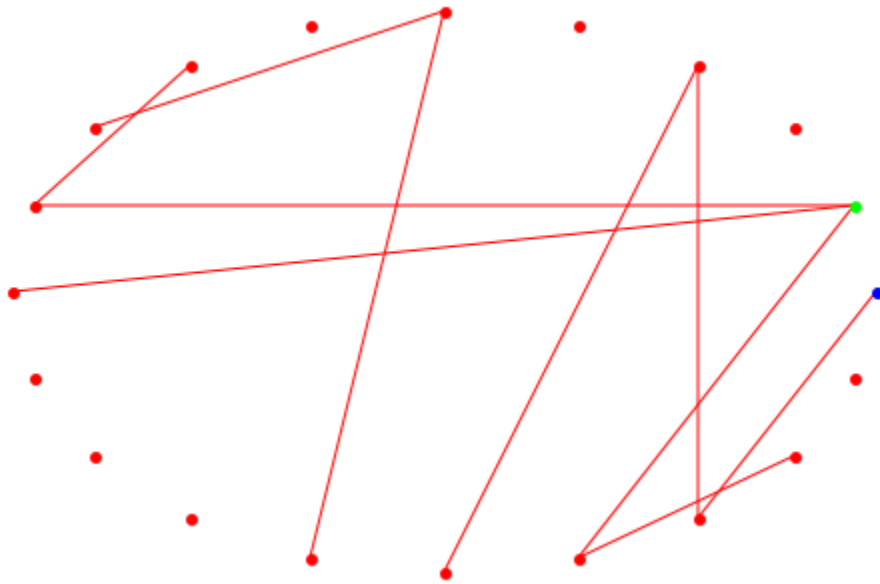

Next, a complete graph will be plotted.

```
G1 := Graph::createCompleteGraph(20):  
plot(Graph::plotCircleGraph(G1))
```

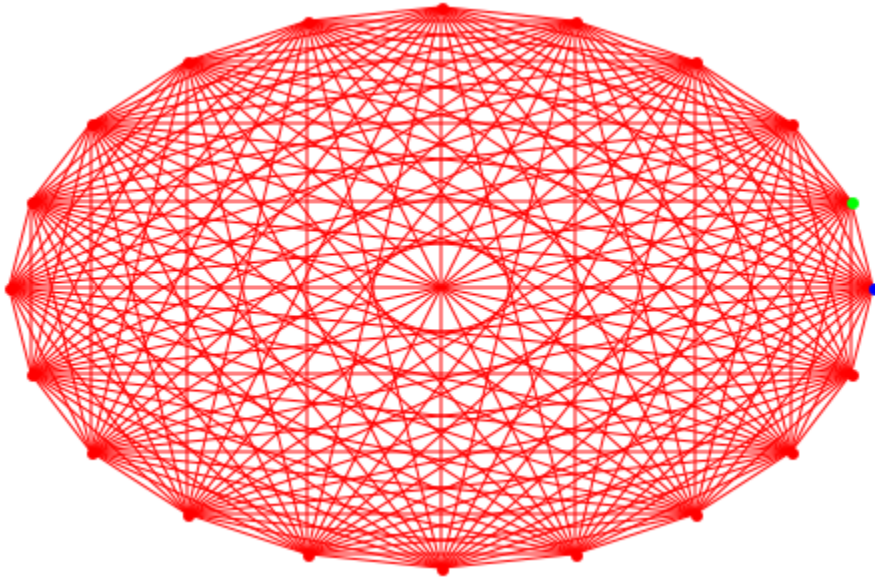

## Example 2

If some edges are to be emphasized they can be drawn in a special color:

```
G2 := Graph([1, 2, 3, 4, 5],
            [[1, 2], [2, 3], [3, 4], [4, 5],
             [1, 3], [1, 4], [1, 5]]):
edges := [[1, 3], [1, 4]]:
plot(Graph::plotCircleGraph(G2,
                           SpecialEdges = edges, SpecialEdgeColor = RGB::Blue))
```

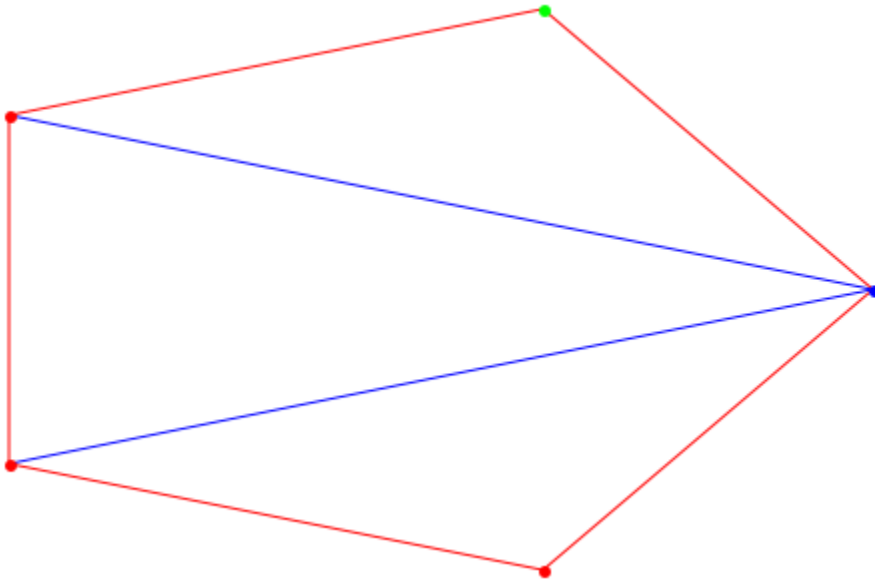

## Parameters

**G**

Graph

**n**

a positive integer

**[ $v_1, \dots, v_n$ ]**

a list of vertices

**[ $e_1, \dots, e_n$ ]**

a list of edges

## Options

### **PointSize**

Defines the thickness in which the points are drawn. Default is 40.

### **SpecialVertices**

Defines a set of vertices. This option makes only sense if used with the option `SpecialVertexColor`.

### **SpecialEdges**

Defines a set of edges. This option makes only sense if used with the option `SpecialEdgeColor`.

### **EdgeColor**

Defines a color with which to draw the edges. Default is `RGB::Red`

### **SpecialEdgeColor**

Defines a color to be used to draw the set of edges specified. This option makes only sense if used with the option `SpecialEdges`

### **VertexColor**

Defines a color with which to draw the vertices. If this option is specified, the first two vertices are set to this color, too. They must be specified via `Vertex1Color` and `Vertex2Color` to distinct them again. Default is `RGB::Red`

### **SpecialVertexColor**

Defines a color to be used to draw the set of vertices specified. This option makes only sense if used with the option `SpecialVertices`

### **Vertex1Color**

Defines a color with which to draw the uppermost left (first) vertex with (the starting vertex). Default is `RGB::Blue`

### **Vertex2Color**

Defines a color with which to draw the second vertex with. Default is RGB::Green

### **Return Values**

`plot::Group2d`



# Graph::plotGridGraph

Plots a Graph in a grid layout

## Syntax

`Graph::plotGridGraph(G, <PointSize = n>, <VerticesPerLine = n>, <VertexOrder = [n1, ..., nn]`

## Description

`Graph::plotGridGraph(G)` returns a `plot::Scene` object in which the vertices are square ordered (topmost left to downmost right). The number of vertices per line is the floor of the squareroot of the number of the vertices. The first vertex is drawn in `RGB::Blue` and the second in `RGB::Green`. All other vertices are drawn in `RGB::Red`. The edges are drawn in `RGB::Red`. The width of the points is predefined with 40. If the last line contains only one vertex, it will be drawn centered in the middle of the line.

`Graph::plotGridGraph(G, VerticesPerLine=n)` returns a `plot::Scene` object like described above with one exception. In every line there are exactly `n` vertices. They appear in sorted order depending on their name. If the last row consists of only one vertex, this one will be centered.

`Graph::plotGridGraph(G, VerticesPerLine=[v1..vn])` returns a `plot::Scene` object like described above with one exception. In line 1 there are exactly `v1` vertices placed. In line 2 there are `v2` vertices and so on. The last line contains `vn` vertices. They appear in sorted order depending on their name. The sum of the numbers specified in `VerticesPerLine` must equal the number of vertices in the graph.

`Graph::plotGridGraph(G, VerticesPerLine=n, VertexOrder=[v1..vn])` returns a `plot::Scene` object like described above with one exception. In every line there are exactly `n` vertices. They appear in sorted order depending on the order that was specified in `VertexOrder`. `vi` can consist of any vertex defined as well as the substitute `None`. Nevertheless the number of vertices in `G` must not exceed the number of `VerticesPerLine`. If the last line holds only one vertex, it will be centered.

## Examples

### Example 1

First, a small graph is created and plotted with the default values:

```
G := Graph([a, b, c, d], [[a, b], [b, c], [c, d], [d, a]]):  
plot(Graph::plotGridGraph(G))
```

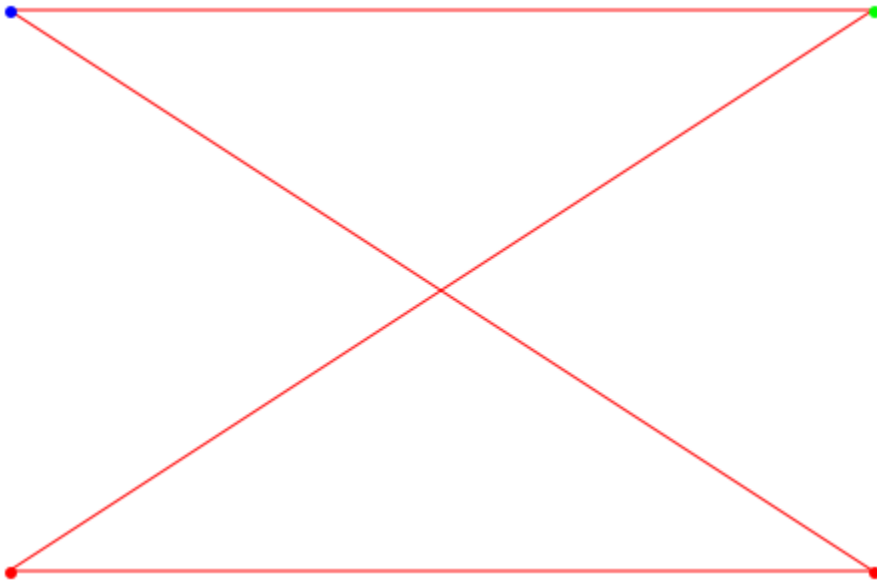

Now, we exchange the two vertices c and d. The order given above was [a, b, c, d]:

```
plot(Graph::plotGridGraph(G, VertexOrder = [a, b, d, c]))
```

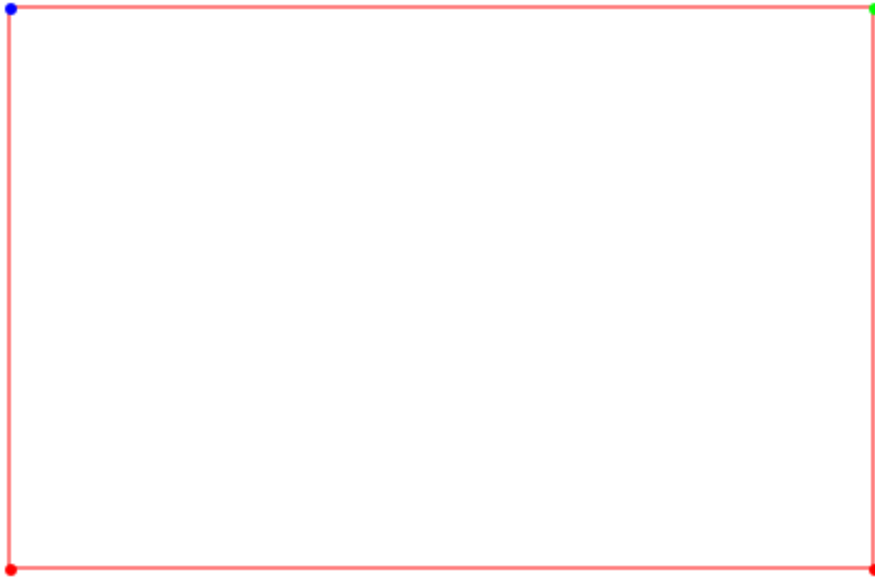

If only one vertex is placed in the last line, it will be centered:

```
plot(Graph::plotGridGraph(G, VertexOrder = [a, b, d, c],  
    VerticesPerLine = 3))
```

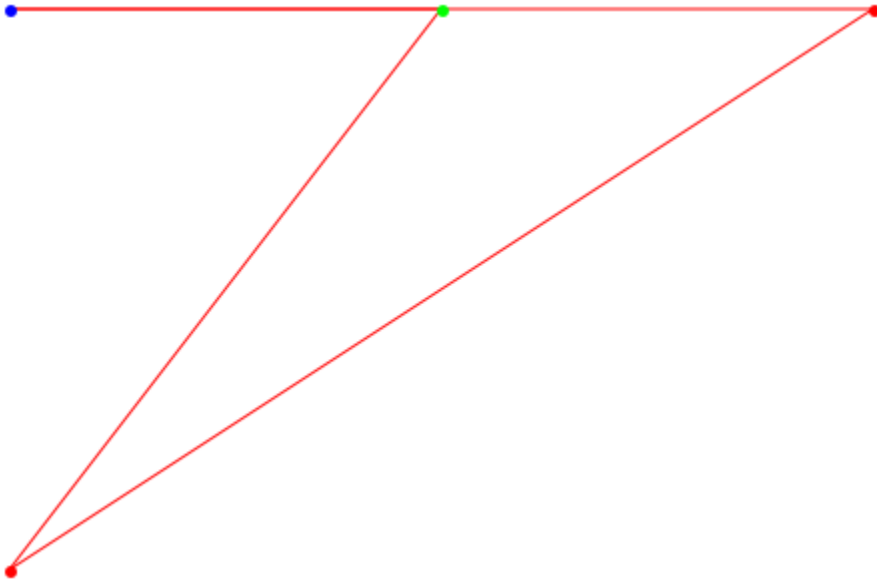

The same result can be gained by defining the Vertices per line specifically (in this case the number of vertices must be no less than the number of vertices in the graph):

```
plot(Graph::plotGridGraph(G, VertexOrder = [a, b, d, c],  
                          VerticesPerLine = [3, 1]))
```

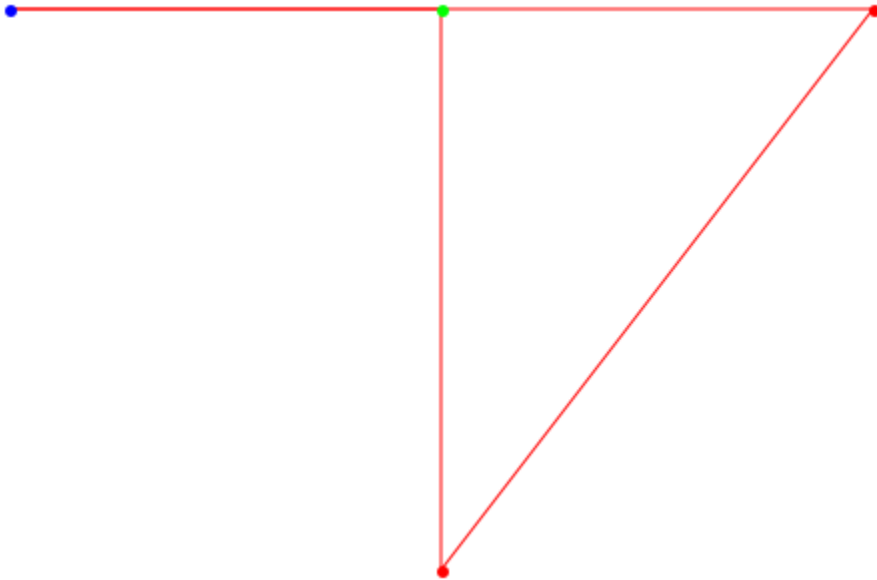

Now we get to the point, why the plot routine got the name Grid. The substitute `None` can be used whenever a place should be skipped. Think of some drawing paper with caskets. The layout is exactly the same. In this case it would consist of 3 caskets in each row. `None` leaves it blank, while a vertex from the Graph is drawn. Because the first casket is empty, the first color is omitted, too. The vertex `a` which is placed in the second casket is drawn as predefined in `Vertex2Color` (`RGB::Green`):

```
plot(Graph::plotGridGraph(G,
    VertexOrder = [None, a,  None,
                   b,  None, c,
                   None, d,  None],
    VerticesPerLine = 3))
```

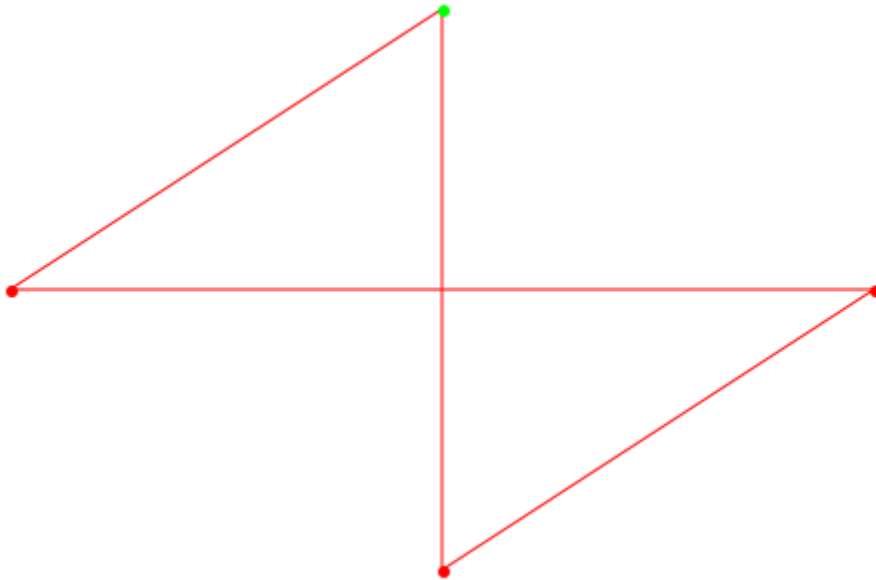

## Example 2

With the knowledge obtained so far, it is possible to get deeper into the art of creating objects. One of the most useful outputs is that of a tree. Thus a Graph is created to be used for the tree output:

```
TreeGraph := Graph([a, b, c, d, e, f, g, h, i, j, k, l],
  [[a, b], [a, c], [b, d], [b, e], [c, f], [c, g],
   [d, h], [e, i], [e, j], [f, k], [g, l]], Directed):
```

Next we define a special vertex order, because the vertices are not drawn the way they were defined:

```
vOrder :=
[None, None, None, None, None, None,
 a, None, None, None, None, None,
 None, None, b, None, None, None,
 None, None, None, c, None, None,
 None, d, None, None, e, None,
 None, f, None, None, g, None,
 h, None, None, i, None, j,
 None, None, k, None, None, l ]:
```

Now it is time to have a look at how the tree looks:

```
plot(Graph::plotGridGraph(TreeGraph,
    VerticesPerLine = 12, VertexOrder = vOrder))
```

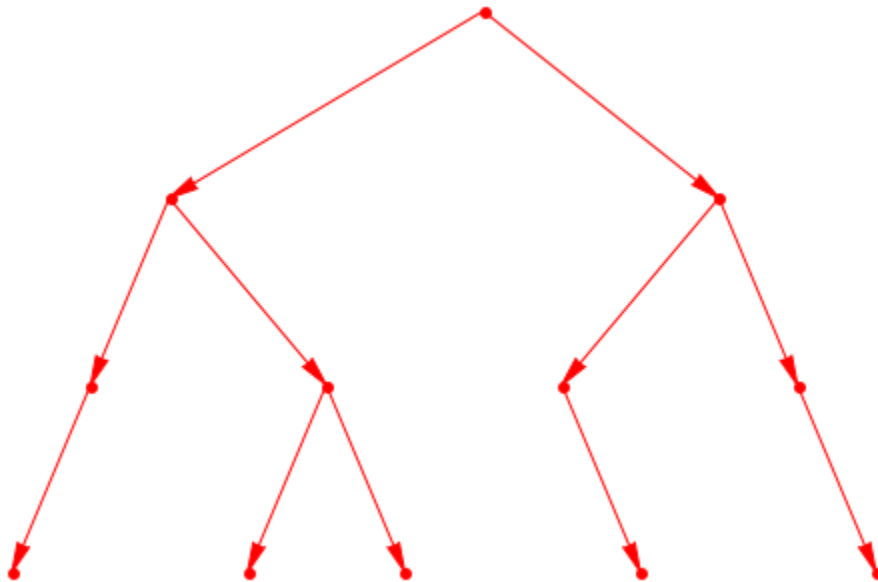

Now we want to see the path from vertex a to Vertexb. For this example it will be given explicitly. For bigger graphs one of the `shortestPath` procedures is recommended:

```
specialPath := [[a, c], [c, f], [f, k]]:
```

Finally we draw the path inside the Graph and have a good overview about the path it takes:

```
plot(Graph::plotGridGraph(TreeGraph,
    VerticesPerLine = 12, VertexOrder = vOrder,
    SpecialEdges = specialPath, SpecialEdgeColor = RGB::Blue))
```

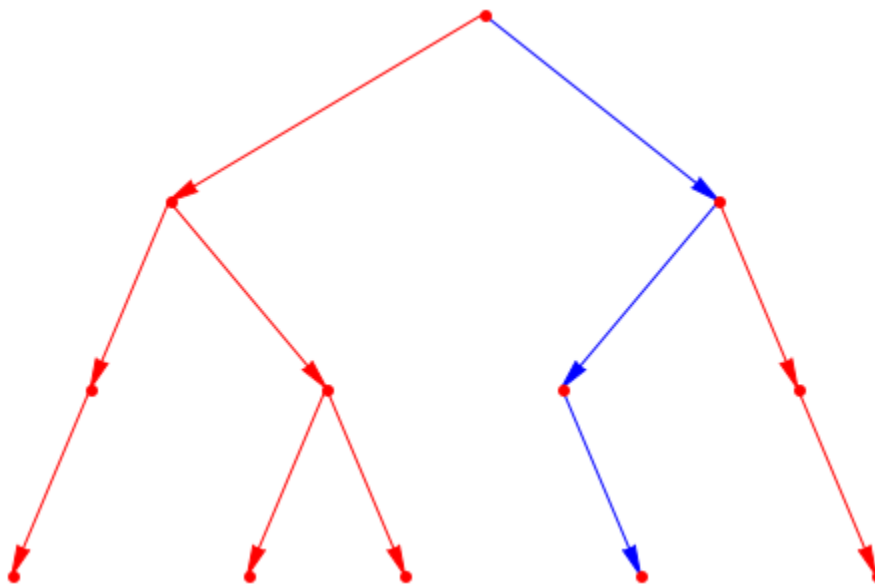

### Example 3

To show what can be done with more detailed and complex examples a small outer face is being drawn (have a close look at the Vertices which are not drawn, because the color is set to RGB::White and thus equals the background-color). Additionally, the “eyes” have been colored differently, so the usage of `SpecialVertexColor` could be presented:

```
Smile := Graph([1,2,4,5,7,8,9,10,11,12,13,14,15,16,17,18,19,20,
                21,22,23,24,25,26,27,28,29,30,31,32,33,34,35,36],
               [[1,4],[2,5],[4,5],[7,4],[5,8],[7,10],[9,10],[10,14],[9,13],
                [13,19],[19,20],[20,14],[14,15],[15,16],[16,17],[17,11],
                [ 8,11],[11,12],[12,18],[18,22],[22,21],[21,17],[21,24],
                [24,28],[28,32],[32,36],[36,35],[35,34],[34,33],[33,29],
                [29,25],[25,23],[23,20],[26,30],[30,31],[31,27]]):
plot(
  Graph::plotGridGraph(Smile, VerticesPerLine = 10,
    VertexOrder = [
      None, None, None,  1, None, None,  2, None, None, None,
      None, None, None, None,  4,  5, None, None, None, None,
      None, None, None,  7, None, None,  8, None, None, None,
      None,  9, 10, None, None, None, None, 11, 12, None,
```



```

    13, None, None, 14, 15, 16, 17, None, None, 18,
    None, 19, 20, None, None, None, None, 21, 22, None,
    None, None, 23, None, None, None, None, 24, None, None,
    None, None, 25, 26, None, None, 27, 28, None, None,
    None, None, 29, None, 30, 31, None, 32, None, None,
    None, None, None, 33, 34, 35, 36, None, None, None],
SpecialEdges = [[13,9],[9,10],[10,14],[14,20],[20,19],[19,13],
[14,15],[15,16],[16,17],[17,21],[21,22],[22,18],[18,12],[12,11],
[11,17]],
SpecialVertices = [1,2,4,5,7,8,23,24,25,26,27,28,29,30,31,
32,33,34,35,36],
VertexColor = RGB::White,
SpecialVertexColor = RGB::Green, EdgeColor = RGB::Green,
SpecialEdgeColor = RGB::Black)
)

```

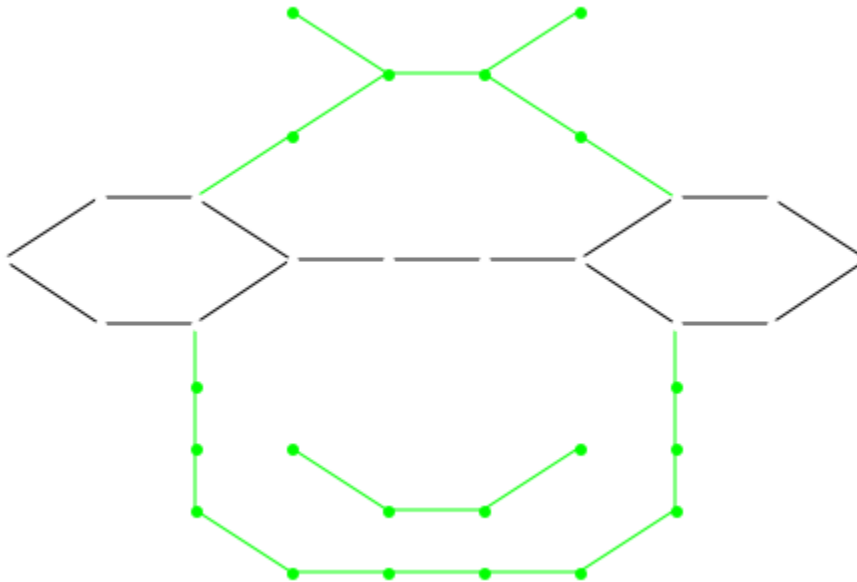

## Example 4

The next example is a complete graph drawn with the vertices ordered in a square so that all vertices can be connected inside the square:

```
CG := Graph::createCompleteGraph(30):  
plot(Graph::plotGridGraph(CG,  
    VerticesPerLine = [8, 2, 2, 2, 2, 2, 2, 2, 8],  
    Vertex1Color = RGB::Red, Vertex2Color = RGB::Red))
```

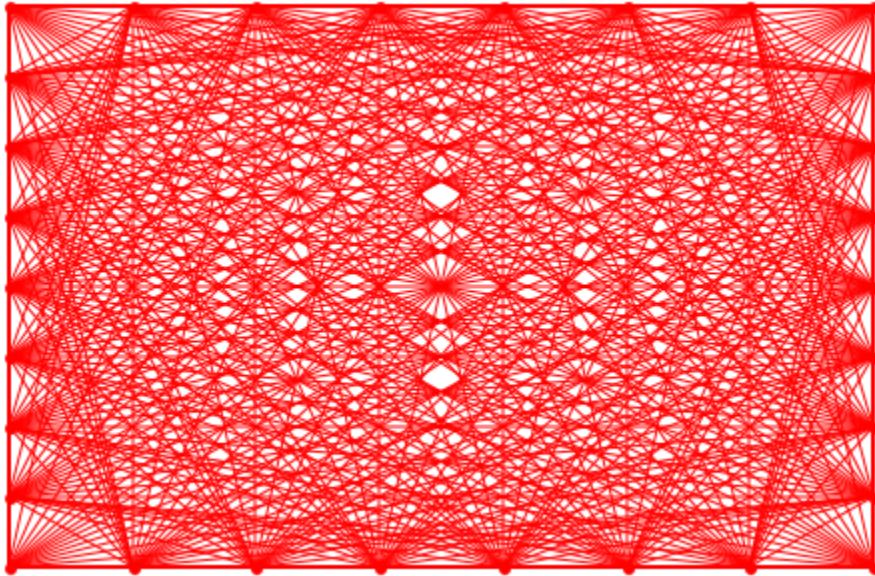

Using the default values in every line vertices are drawn and the graph looks not as “dense” as the above one:

```
plot(Graph::plotGridGraph(CG, Vertex1Color = RGB::Red,  
    Vertex2Color = RGB::Red))
```

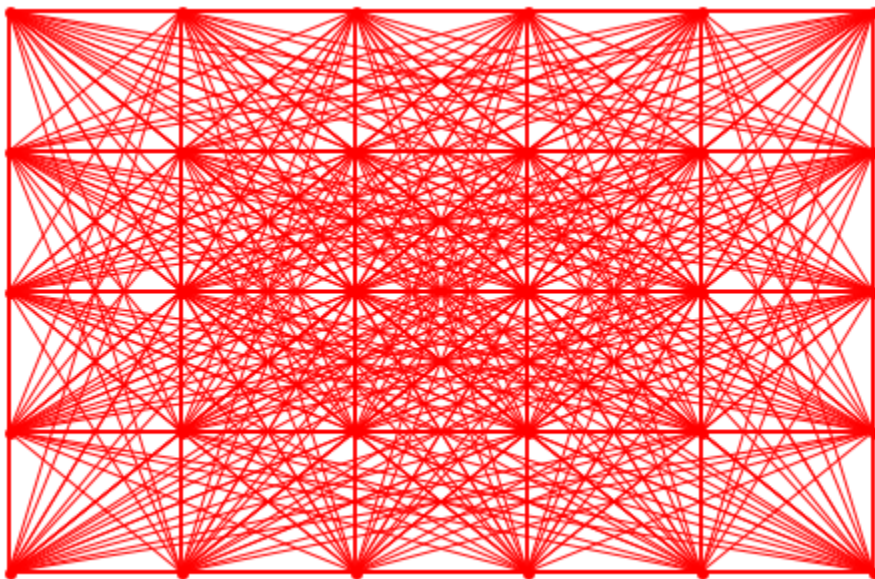

## Example 5

The last example shows a small kite inside a frame:

```
Shield := Graph([1, 2, 3, 4, 5, 6, 7, 8, 9],
  [[1, 2], [1, 8], [2, 9], [8, 9], [3, 5], [4, 5],
   [5, 6], [5, 7], [3, 6], [6, 7], [3, 4], [4, 7]]):
plot(Graph::plotGridGraph(Shield, Vertex1Color = RGB::White,
  Vertex2Color = RGB::White, VertexColor = RGB::White,
  VerticesPerLine = 7,
  VertexOrder = [
    1, None, None, None, None, None, 2,
    None, None, None, 3, None, None, None,
    None, None, None, None, None, None, None,
    None, None, None, None, None, None, None,
    None, 4, None, 5, None, 6, None,
    None, None, None, None, None, None, None,
    None, None, None, None, None, None, None,
    None, None, None, None, None, None, None,
    None, None, None, None, None, None, None,
    None, None, None, None, None, None, None,
    None, None, None, None, None, None, None,
    None, None, None, None, None, None, None,
```

```
None, None, None, None, None, None, None,  
None, None, None, None, None, None, None,  
None, None, None, None, None, None, None,  
None, None, None, None, None, None, None,  
None, None, None, None, None, None, None,  
None, None, None, 7, None, None, None,  
8, None, None, None, None, None, 9],  
SpecialVertices = [3, 4, 5, 6, 7],  
SpecialVertexColor = RGB::Blue,  
SpecialEdges = [[3, 5], [4, 5], [5, 6], [5, 7],  
[3, 6], [6, 7], [3, 4], [4, 7]],  
SpecialEdgeColor = RGB::Blue))
```

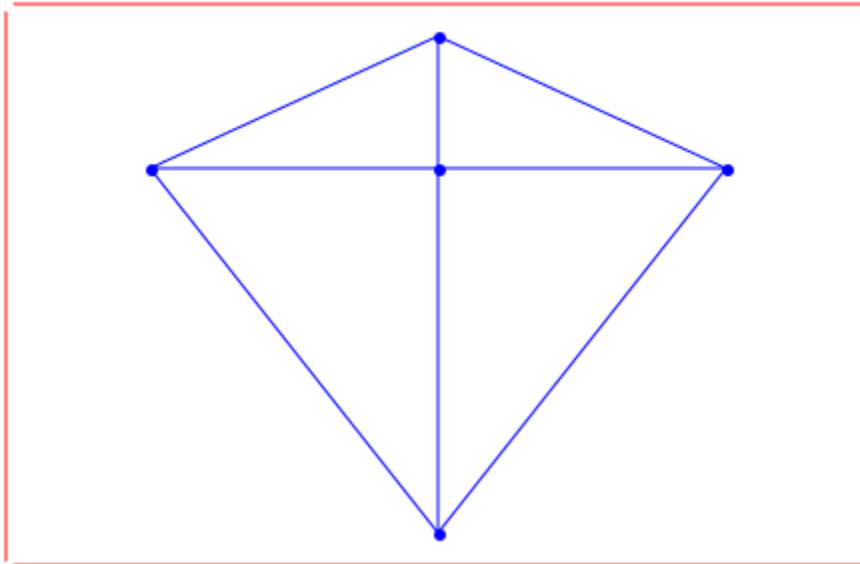

## Parameters

G

Graph

**n**

a positive integer

**[n<sub>1</sub>, ..., n<sub>m</sub>]**

a list of positive integers

**[v<sub>1</sub>, ..., v<sub>n</sub>]**

a list of vertices

**[e<sub>1</sub>, ..., e<sub>n</sub>]**

a list of edges

## Options

### **PointSize**

Defines the thickness in which the points are drawn. Default is 40.

### **VerticesPerLine**

If specified as single number, this many vertices are placed in every row. If specified as list, the number of vertices per line are read out of the list. If the vertices are specified as list, the number of vertices must match either the number of vertices defined in the graph, or, if specified, the number defined in `VertexOrder`.

### **VertexOrder**

Defines an order in which the vertices are to be placed. It starts in the upper left and ends in the lower right. The number of specified vertices must match the number of vertices defined in the graph or the sum of the vertices specified in `VerticesPerLine`.

### **SpecialVertices**

Defines a set of vertices. This option makes only sense if used with the option `SpecialVertexColor`.

**SpecialEdges**

Defines a set of edges. This option makes only sense if used with the option `SpecialEdgeColor`.

**EdgeColor**

Defines a color with which to draw the edges. Default is `RGB::Red`

**SpecialEdgeColor**

Defines a color to be used to draw the set of edges specified. This option makes only sense if used with the option `SpecialEdges`

**VertexColor**

Defines a color with which to draw the vertices. If this option is specified, the first two vertices are set to this color, too. They must be specified via `Vertex1Color` and `Vertex2Color` to distinct them again. Default is `RGB::Red`

**SpecialVertexColor**

Defines a color to be used to draw the set of vertices specified. This option makes only sense if used with the option `SpecialVertices`

**Vertex1Color**

Defines a color with which to draw the uppermost left (first) vertex with (the starting vertex). If `VertexOrder` holds a `None` for this vertex, it will be skipped. Default is `RGB::Blue`

**Vertex2Color**

Defines a color with which to draw the second vertex with. If `VertexOrder` holds a `None` for this vertex, it will be skipped. Default is `RGB::Green`

**Return Values**

`Plot::Scene`.

# Graph::printEdgeCostInformation

Prints the edge costs of a graph

## Syntax

```
Graph::printEdgeCostInformation(G)
```

## Description

Graph::printEdgeCostInformation prints the edge costs of a graph.

Graph::printEdgeCostInformation(G) prints the edge costs of the graph *G*

## Examples

### Example 1

A circle graph is created and the edge costs of it printed to screen:

```
G := Graph::createCircleGraph(3):  
Graph::printEdgeCostInformation(G)
```

```
No edge costs defined.
```

```
G := Graph::setEdgeCosts(G, [[1, 2], [2, 3], [3, 1]], [10, 20, 30]):  
Graph::printEdgeCostInformation(G)
```

```
Edge costs existing in the graph:
```

```
-----  
Edge [1, 2] has cost 10  
Edge [2, 3] has cost 20  
Edge [3, 1] has cost 30
```

## **Parameters**

**G**

Graph

## **Return Values**

Text containing information about the edge costs of a graph.



# Graph::printEdgeDescInformation

Prints the edge descriptions of a graph

## Syntax

```
Graph::printEdgeDescInformation(G)
```

## Description

Graph::printEdgeDescInformation prints the edge descriptions of a graph.

Graph::printEdgeDescInformation(G) prints the edge descriptions of the graph G

## Examples

### Example 1

A circle graph is created and the edge descriptions of it printed to screen:

```
G := Graph::createCircleGraph(3):
Graph::printEdgeDescInformation(G)
```

No edge descriptions defined.

```
G := Graph::setEdgeDescriptions(G, [[1, 2], [2, 3], [3, 1]],
                                ["Shortcut", "Highway", "Speedup"]):
Graph::printEdgeDescInformation(G)
```

Edge descriptions existing in the graph:

```
-----
Edge [1, 2] = "Shortcut"
Edge [2, 3] = "Highway"
```

Edge [3, 1] = "Speedup"

## Parameters

**G**

Graph

## Return Values

Text containing information about the edge descriptions of a graph.

# Graph::printEdgeInformation

Prints the edges of a graph

## Syntax

```
Graph::printEdgeInformation(G)
```

## Description

Graph::printEdgeInformation prints the edges of a graph.

Graph::printEdgeInformation(G) prints the edges used in the graph G.

## Examples

### Example 1

A circle graph is created and the edges of it printed to screen:

```
G := Graph::createCircleGraph(3):  
Graph::printEdgeInformation(G)
```

Edges existing in the graph:

```
-----  
[1, 2], [2, 3], [3, 1]
```

### Example 2

A complete graph is created and the edges of it printed to screen:

```
G := Graph::createCompleteGraph(3):  
Graph::printEdgeInformation(G)
```

Edges existing in the graph:

-----  
[1, 2], [1, 3], [2, 1], [2, 3], [3, 1], [3, 2]

## Parameters

**G**

Graph

## Return Values

Text containing information about the edges of a graph.

# Graph::printEdgeWeightInformation

Prints the edge weights of a graph

## Syntax

```
Graph::printEdgeWeightInformation(G)
```

## Description

Graph::printEdgeWeightInformation prints the edge weights of a graph.

Graph::printEdgeWeightInformation(G) prints the edge weights of the graph G

## Examples

### Example 1

A circle graph is created and the edge weights of it printed to screen:

```
G := Graph::createCircleGraph(3):  
Graph::printEdgeWeightInformation(G)
```

No edge weights defined.

```
G := Graph::setEdgeWeights(G, [[1, 2], [2, 3], [3, 1]], [10, 20, 30]):  
Graph::printEdgeWeightInformation(G)
```

Edge weights existing in the graph:

```
-----  
Edge [1, 2] has weight 10  
Edge [2, 3] has weight 20  
Edge [3, 1] has weight 30
```

## **Parameters**

**G**

Graph

## **Return Values**

Text containing information about the edge weights of a graph.

# Graph::printGraphInformation

Prints the edges of a graph

## Syntax

```
Graph::printGraphInformation(G)
```

## Description

`Graph::printGraphInformation` prints a summary of various information about a graph.

`Graph::printGraphInformation(G)` prints a summary of the graph *G*

## Examples

### Example 1

A circle graph is created and a summary of it printed to screen:

```
G := Graph::createCircleGraph(3):  
Graph::printGraphInformation(G)
```

```
Vertices: [1, 2, 3]  
Edges: [[1, 2], [2, 3], [3, 1]]  
Vertex weights: no vertex weights.  
Edge descriptions: no edge descriptions.  
Edge weights: no edge weights.  
Edge costs: no edge costs.  
Adjacency list (out): 1 = [2], 2 = [3], 3 = [1]  
Adjacency list (in): 1 = [3], 2 = [1], 3 = [2]  
Graph is directed.
```

## Example 2

A complete graph is created and a summary of it printed to screen:

```
G := Graph::createCompleteGraph(3):  
Graph::printGraphInformation(G)
```

```
Vertices: [1, 2, 3]  
Edges: [[1, 2], [1, 3], [2, 1], [2, 3], [3, 1], [3, 2]]  
Vertex weights: no vertex weights.  
Edge descriptions: no edge descriptions.  
Edge weights: no edge weights.  
Edge costs: no edge costs.  
Adjacency list (out): 1 = [2, 3], 2 = [1, 3], 3 = [1, 2]  
Adjacency list (in): 1 = [2, 3], 2 = [1, 3], 3 = [1, 2]  
Graph is undirected.
```

## Parameters

**G**

Graph

## Return Values

Text containing information about the graph.



# Graph::printVertexInformation

Prints vertex information of a graph

## Syntax

```
Graph::printVertexInformation(G)
```

## Description

Graph::printVertexInformation prints the edges of a graph.

Graph::printVertexInformation(G) prints the edges of the graph G

## Examples

### Example 1

A circle graph is created and information of the vertices printed to screen:

```
G := Graph::createCircleGraph(3):  
Graph::printVertexInformation(G)
```

```
Vertices existing in the graph:
```

```
-----  
Vertex 1 has weight None  
Vertex 2 has weight None  
Vertex 3 has weight None
```

### Example 2

A complete graph is created and information of the vertices printed to screen:

```
G := Graph::createCompleteGraph(3):  
Graph::printVertexInformation(G)
```

Vertices existing in the graph:

-----

Vertex 1 has weight None

Vertex 2 has weight None

Vertex 3 has weight None

## Parameters

**G**

Graph

## Return Values

Text containing information about the vertices of a graph.

# Graph::removeEdge

Removes one or several edges from a graph

## Syntax

```
Graph::removeEdge(G, e)
```

```
Graph::removeEdge(G, l)
```

## Description

`Graph::removeEdge(G, [e1, ..., en])` removes edges `e1...en` from graph `G`.

`Graph::removeEdge` deletes one or several edges from a graph. An edge is represented by a list containing two vertices of the graph. A warning is printed if the specified edge is not contained in the graph.

`Graph::removeEdge(G, e)` removes the edge `e` from the graph `G`.

`Graph::removeEdge(G, l)` removes all edges in list `l` from graph `G`.

## Examples

### Example 1

Removing an edge from a cyclic graph results in a (degenerated) tree:

```
G1 := Graph::createCircleGraph(5):  
Graph::printGraphInformation(G1)
```

```
Vertices: [1, 2, 3, 4, 5]  
Edges: [[1, 2], [2, 3], [3, 4], [4, 5], [5, 1]]  
Vertex weights: no vertex weights.  
Edge descriptions: no edge descriptions.
```

```
Edge weights: no edge weights.  
Edge costs: no edge costs.  
Adjacency list (out): 1 = [2], 2 = [3], 3 = [4], 4 = [5], 5 = [1]  
Adjacency list (in): 1 = [5], 2 = [1], 3 = [2], 4 = [3], 5 = [4]  
Graph is directed.
```

```
plot(Graph::plotCircleGraph(G1))
```

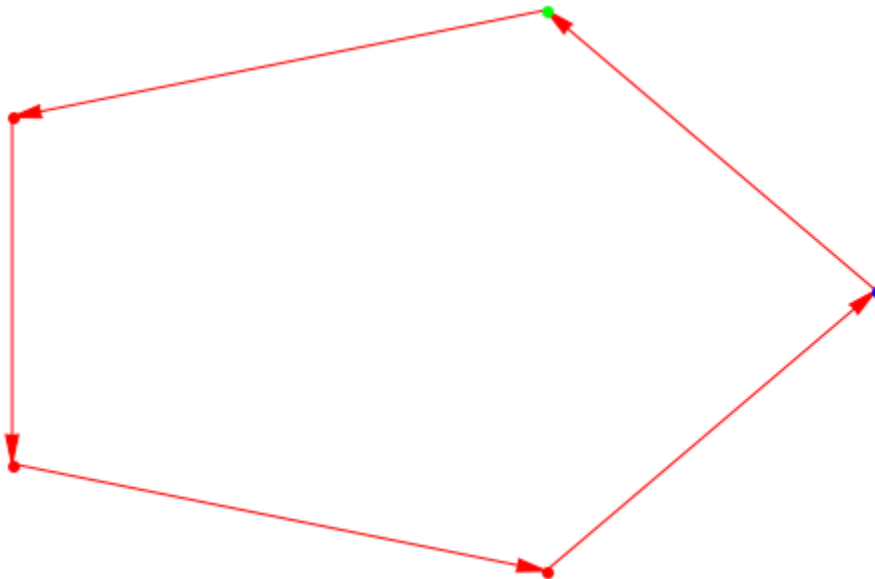

```
G2 := Graph::removeEdge(G1, [[5, 1]]):  
Graph::printGraphInformation(G2)
```

```
Vertices: [1, 2, 3, 4, 5]  
Edges: [[1, 2], [2, 3], [3, 4], [4, 5]]  
Vertex weights: no vertex weights.  
Edge descriptions: no edge descriptions.  
Edge weights: no edge weights.  
Edge costs: no edge costs.  
Adjacency list (out): 1 = [2], 2 = [3], 3 = [4], 4 = [5], 5 = []  
Adjacency list (in): 1 = [], 2 = [1], 3 = [2], 4 = [3], 5 = [4]  
Graph is directed.
```

```
plot(Graph::plotCircleGraph(G2))
```

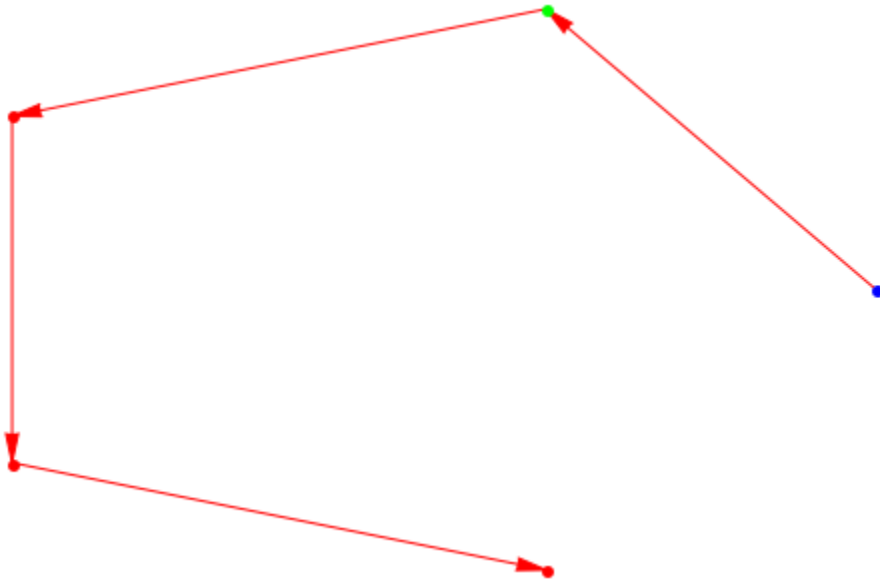

If more than one edge is to be removed they must also be specified in a list:

```
edges := [[2, 3], [4, 5]]:
G3 := Graph::removeEdge(G1, edges):
Graph::printGraphInformation(G3)
```

```
Vertices: [1, 2, 3, 4, 5]
Edges: [[1, 2], [3, 4], [5, 1]]
Vertex weights: no vertex weights.
Edge descriptions: no edge descriptions.
Edge weights: no edge weights.
Edge costs: no edge costs.
Adjacency list (out): 1 = [2], 2 = [], 3 = [4], 4 = [], 5 = [1]
Adjacency list (in): 1 = [5], 2 = [1], 3 = [], 4 = [3], 5 = []
Graph is directed.
```

```
plot(Graph::plotCircleGraph(G3))
```

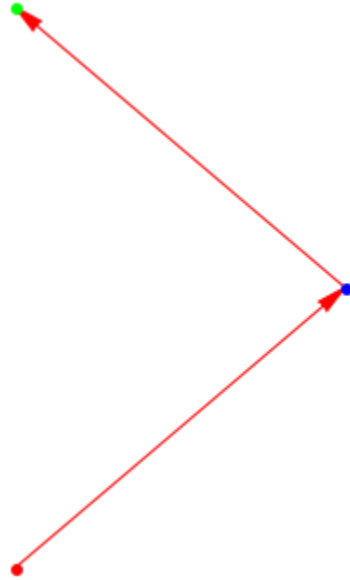

## Parameters

**$l$**

A list of edges

**$e$**

An edge

**$G$**

A graph

## Return Values

Graph

# Graph::removeVertex

Removes one or several vertices from a graph

## Syntax

`Graph::removeVertex(G, v)`

`Graph::removeVertex(G, l)`

## Description

`Graph::removeVertex(G, v)` removes vertex `v` from graph `G`.

`Graph::removeVertex(G, [v1, ..., vn])` removes vertices `v1...vn` from graph `G`.

`Graph::removeVertex` deletes one or several vertices from a graph. A warning is printed if the specified vertex is not contained in the graph.

---

**Note** If a vertex is connected to other vertices with edges, they will be removed from the graph, too!

---

`Graph::removeVertex(G, v)` removes the vertex `v` from the graph `G`.

`Graph::removeVertex(G, l)` removes all vertices in list `l` from graph `G`.

## Examples

### Example 1

Removing a vertex from a cyclic graph removes also two edges:

```
G1 := Graph::createCircleGraph(5):  
Graph::printGraphInformation(G1)
```

```
Vertices: [1, 2, 3, 4, 5]
Edges: [[1, 2], [2, 3], [3, 4], [4, 5], [5, 1]]
Vertex weights: no vertex weights.
Edge descriptions: no edge descriptions.
Edge weights: no edge weights.
Edge costs: no edge costs.
Adjacency list (out): 1 = [2], 2 = [3], 3 = [4], 4 = [5], 5 = [1]
Adjacency list (in): 1 = [5], 2 = [1], 3 = [2], 4 = [3], 5 = [4]
Graph is directed.
```

```
plot(Graph::plotCircleGraph(G1))
```

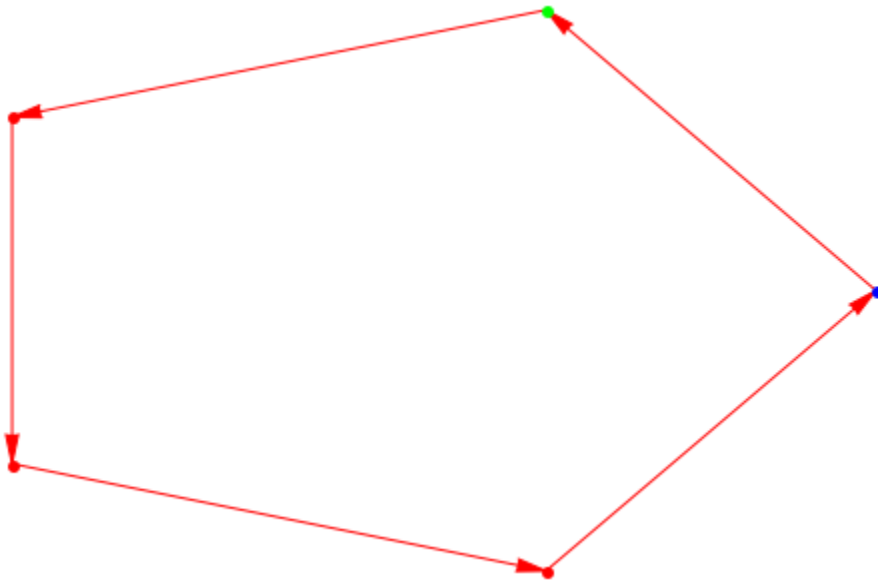

```
G2 := Graph::removeVertex(G1, [1]):
Graph::printGraphInformation(G2)
```

```
Vertices: [2, 3, 4, 5]
Edges: [[2, 3], [3, 4], [4, 5]]
Vertex weights: no vertex weights.
Edge descriptions: no edge descriptions.
Edge weights: no edge weights.
Edge costs: no edge costs.
```



```
Adjacency list (out): 2 = [3], 3 = [4], 4 = [5], 5 = []
Adjacency list (in): 2 = [], 3 = [2], 4 = [3], 5 = [4]
Graph is directed.
```

```
plot(Graph::plotCircleGraph(G2))
```

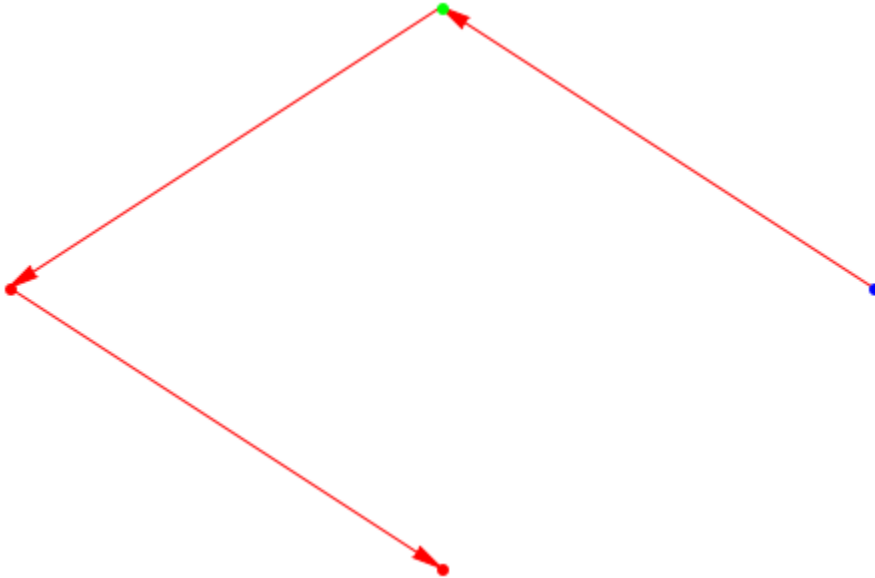

If more than one vertex is to be removed they must also be specified in a list:

```
vertices := [2, 4]:
G3 := Graph::removeVertex(G1, vertices):
Graph::printGraphInformation(G3)
```

```
Vertices: [1, 3, 5]
Edges: [[5, 1]]
Vertex weights: no vertex weights.
Edge descriptions: no edge descriptions.
Edge weights: no edge weights.
Edge costs: no edge costs.
Adjacency list (out): 1 = [], 2 = [], 3 = [], 5 = [1]
Adjacency list (in): 1 = [5], 2 = [], 3 = [], 5 = []
Graph is directed.
```

```
plot(Graph::plotCircleGraph(G3))
```

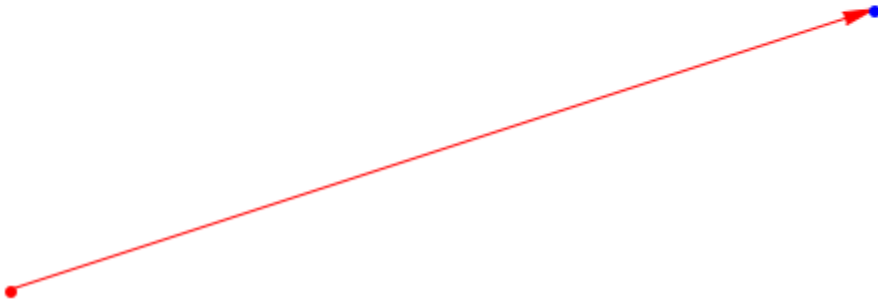

## Parameters

**$\mathcal{V}$**

A list of vertices

**$v$**

A vertex

**$G$**

A graph

## Return Values

Graph

# Graph::residualGraph

Computes the residual graph

## Syntax

```
Graph::residualGraph(G, f, <Extended>)
```

## Description

`Graph::residualGraph(G, flow)` computes the residual of the graph `G` with respect to the flow `flow`, meaning the graph that remains when the flow `flow` is “subtracted” from `G`.

`Graph::residualGraph` computes the residual graph with respect to a given flow. A flow in a `Graph` is a table `tbl`, where `tbl[[i, j]]` gives the number of units flowing from vertex `i` to vertex `j`.

If the optional argument `Extended` is given, then also those edges with a zero residual capacity are considered, otherwise these edges are omitted.

## Examples

### Example 1

In the following call, `G2` is the graph consisting of the remaining transport capacities after a given flow:

```
G1 := Graph::createCompleteGraph(3):
G2 := Graph::residualGraph(G1,
  table( [1, 2] = 1, [2, 1] = 1/2,
         [1, 3] = 0, [3, 1] = 0.5,
         [2, 3] = 1, [3, 2] = 0 ) ):
Graph::getEdgeWeights(G2)
```

[2, 1]	$\frac{1}{2}$
[1, 3]	1
[3, 1]	0.5
[3, 2]	1

The algorithm detects the lack of edge weights and edge costs and sets all edge weights and costs to default values of 1.

## Example 2

The resulting graph depends on whether the option `Extended` is used:

```
V := [1, 2, 3, q, s]:
Edge := [[q, 1], [1, 2], [1, 3], [2, 3], [3, s]]:
up := [5, 4, 4, 2, 5]:
G := Graph(V,Edge,EdgeWeights = up, Directed):
flow := table([q, 1] = 5, [3, s] = 5, [1, 2] = 1,
              [1, 3] = 4, [2, 3] = 1):
G1 := Graph::residualGraph(G, flow):
Graph::printGraphInformation(G1):
```

```
Vertices: [1, 2, 3, q, s]
Edges: [[2, 1], [3, 1], [3, 2], [s, 3], [1, q], [1, 2], [2, 3]]
Vertex weights: no vertex weights.
Edge descriptions: no edge descriptions.
Edge weights: [1, 2] = 3, [2, 3] = 1, [2, 1] = 1, [3, 1] = 4, [3, 2] = 1, \
[s, 3] = 5, [1, q] = 5 (other existing edges have no weight)
Edge costs: [1, 2] = 1, [2, 3] = 1, [2, 1] = -3, [3, 1] = 0, [3, 2] = -1, \
[s, 3] = 0, [1, q] = 0 (other existing edges have costs zero)
Adjacency list (out): 1 = [2, q], 2 = [1, 3], 3 = [1, 2], q = [], s = [3]
Adjacency list (in): 1 = [2, 3], 2 = [1, 3], 3 = [2, s], q = [1], s = []
Graph is directed.
```

Edge Weights contain the residual graph with all the flows. Edge Costs show the flow that was subtracted or added. For example edge [1, 2] had weight 4. After a flow of 3 was sent over it, the residual edge [2, 1] contains the flow of -3 and the residual edge [1, 2] contains the flow of 1. Since the negative flow of the reverted edge plus the flow of the

edge in the residual graph have to sum up to the flow it shows that the flow is calculated correctly.  $(-(-3) + 1 = 4)$

```
G1 := Graph::residualGraph(G, flow, Extended):
Graph::printGraphInformation(G1);
```

```
Vertices: [1, 2, 3, q, s]
Edges: [[2, 1], [3, 1], [3, 2], [s, 3], [1, q], [1, 2], [1, 3], [2, 3], [3,
, s], [q, 1]]
Vertex weights: no vertex weights.
Edge descriptions: no edge descriptions.
Edge weights: [q, 1] = 5, [1, 2] = 4, [1, 3] = 4, [2, 3] = 2, [3, s] = 5, \
[2, 1] = -4, [3, 1] = -4, [3, 2] = -2, [s, 3] = -5, [1, q] = -5 (other exi\
sting edges have no weight)
Edge costs: [1, 2] = 3, [1, 3] = 0, [2, 3] = 1, [3, s] = 0, [q, 1] = 0, [2\
, 1] = 1, [3, 1] = 4, [3, 2] = 1, [s, 3] = 5, [1, q] = 5 (other existing e\
dges have costs zero)
Adjacency list (out): 1 = [2, 3, q], 2 = [1, 3], 3 = [1, 2, s], q = [1], s \
= [3]
Adjacency list (in): 1 = [2, 3, q], 2 = [1, 3], 3 = [1, 2, s], q = [1], s \
= [3]
Graph is directed.
```

## Parameters

**G**

Graph

**flow**

The predefined flow

## Options

**Extended**

Include edges with zero capacities

## **Return Values**

Graph

# Graph::revert

Reverts the edges of a graph.

## Syntax

```
Graph::revert(G)
```

## Description

`Graph::revert(G)` returns a graph in which all edges  $[u, v]$  and their properties belong to edges  $[v, u]$ .

`Graph::revert` overloads the system function `revert`.

## Examples

### Example 1

First, a circle graph is defined with some additional settings:

```
G1 := Graph::createCircleGraph(3):
G1 := Graph::setEdgeWeights(G1, [[1, 2]], [20]):
G1 := Graph::setEdgeCosts(G1, [[1, 2]], [20]):
G1 := Graph::setEdgeDescriptions(G1, [[1, 2]], ["Shortcut"]):
Graph::printGraphInformation(G1)
```

```
Vertices: [1, 2, 3]
Edges: [[1, 2], [2, 3], [3, 1]]
Vertex weights: no vertex weights.
Edge descriptions: [1, 2] = "Shortcut"
Edge weights: [1, 2] = 20 (other existing edges have no weight)
Edge costs: [1, 2] = 20 (other existing edges have costs zero)
Adjacency list (out): 1 = [2], 2 = [3], 3 = [1]
Adjacency list (in): 1 = [3], 2 = [1], 3 = [2]
Graph is directed.
```

Now we revert the graph:

```
G2 := revert(G1):  
Graph::printGraphInformation(G2)
```

```
Vertices: [1, 2, 3]  
Edges: [[1, 3], [2, 1], [3, 2]]  
Vertex weights: no vertex weights.  
Edge descriptions: [2, 1] = "Shortcut"  
Edge weights: [2, 1] = 20 (other existing edges have no weight)  
Edge costs: [2, 1] = 20 (other existing edges have costs zero)  
Adjacency list (out): 1 = [3], 2 = [1], 3 = [2]  
Adjacency list (in): 1 = [2], 2 = [3], 3 = [1]  
Graph is directed.
```

## Parameters

**G**

A graph

## Return Values

Graph



# Graph::setEdgeCosts

Assigns edge costs to edges.

## Syntax

```
Graph::setEdgeCosts(G, Edge, EdgeCosts, <OnlySpecifiedEdges>)
```

## Description

`Graph::setEdgeCosts(G, Edges, EdgeCosts)` returns a graph where `Edges` have the edge costs `EdgeCosts`.

---

**Note** If *OnlySpecifiedEdges* is stated and an undirected graph is to be changed, only the edges specified are used and not the inverted ones. For example if a call `Graph::setEdgeCosts(G, [[u,v]], [1])` is invoked, only the edge `[u, v]` gets 1. The edge `[v, u]` will not be changed.

---

---

**Note** The substitute `None` can be used when a specified edge should not get the assigned costs.

---

## Examples

### Example 1

First lets define a graph without edge costs:

```
G1 := Graph::createCircleGraph(3):  
Graph::getEdgeCosts(G1)
```

FAIL

FAIL was returned, because no edge costs werde defined.

```
Graph::getEdges(G1);
G1 := Graph::setEdgeCosts(G1, [[1, 2], [3, 1]], [5, 1/2]);
Graph::getEdgeCosts(G1)
```

```
[[1, 2], [2, 3], [3, 1]]
```

[1, 2]	5
[3, 1]	$\frac{1}{2}$

The first output shows all the edges and the second one the assigned edge costs.

```
G1 := Graph::setEdgeCosts(G1, [[2, 3]], [infinity]);
Graph::getEdgeCosts(G1)
```

[1, 2]	5
[3, 1]	$\frac{1}{2}$
[2, 3]	$\infty$

It is easy to see that only the edge cost of [2,3] was changed.

## Example 2

First lets define a graph without edge costs:

```
G1 := Graph::createCompleteGraph(3);
Graph::getEdgeCosts(G1)
```

```
FAIL
```

FAIL was returned, because no edge costs werde defined.

```
Graph::getEdges(G1);
G2 := Graph::setEdgeCosts(G1, [[1, 2], [3, 1]], [5, 1/2]);
Graph::getEdgeCosts(G2)
```

```
[[1, 2], [1, 3], [2, 1], [2, 3], [3, 1], [3, 2]]
```

[1, 2]	5
[2, 1]	5
[1, 3]	$\frac{1}{2}$
[3, 1]	$\frac{1}{2}$

The first output shows all the edges (the graph is undirected !) and the second one the assigned edge costs. Not only the specified edges were set, but also the reverted edges.

```
Graph::getEdges(G1);
G2 := Graph::setEdgeCosts(G1, [[1, 2], [3, 1]], [5, 1/2],
    OnlySpecifiedEdges);
Graph::getEdgeCosts(G2)
```

```
[[1, 2], [1, 3], [2, 1], [2, 3], [3, 1], [3, 2]]
```

[1, 2]	5
[3, 1]	$\frac{1}{2}$

It is easy to see that only the specified edge costs were changed and not the reverted edges, too.

### Example 3

There exist also the possibility to set the costs via a table instead of a list.

```
tbl := table([1, 2] = 15, [1, 3] = 20):
G2 := Graph::createCompleteGraph(3):

G2 := Graph::setEdgeCosts(G2, [[1, 2], [3, 1]], tbl):
Graph::getEdgeCosts(G2)
```

[1, 2]	15
[2, 1]	15
[1, 3]	20
[3, 1]	20

And again, but this time only the specified edges:

```
tbl := table([1, 2] = 15, [1, 3] = 20):  
G2 := Graph::createCompleteGraph(3):  
G2 := Graph::setEdgeCosts(G2, [[1, 2], [3, 1]], tbl,  
    OnlySpecifiedEdges):  
Graph::getEdgeCosts(G2)
```

[1, 2]	15
[3, 1]	20

## Parameters

### **G**

A graph

### **Edge**

A list of one or more edges

### **EdgeCosts**

A list of one or more numbers, or a table consisting of the edges with their costs.

## Options

### **OnlySpecifiedEdges**

Only the edges specified in Edge will be set.

## **Return Values**

New graph with the corrected edge costs.

## Graph::setEdgeDescriptions

Assigns edge Descriptions to edges.

### Syntax

```
Graph::setEdgeDescriptions(G, Edge, EdgeDescriptions, <OnlySpecifiedEdges>)
```

### Description

Graph::setEdgeDescriptions(G, Edges, EdgeDescriptions) returns a graph where Edges have the edge descriptions EdgeDescriptions.

---

**Note** If *OnlySpecifiedEdges* is stated and an undirected graph is to be changed, only the edges specified are used and not the inverted ones. For example if a call Graph::setEdgeDescriptions(G, [[u,v]], [1]) is invoked, only the edge [u, v] gets 1. The edge [v, u] will not be changed.

---

---

**Note** The substitute None can be used when a specified edge should not get the assigned description.

---

### Examples

#### Example 1

First lets define a graph without edge descriptions:

```
G1 := Graph::createCircleGraph(3):  
Graph::getEdgeDescriptions(G1)
```

FAIL

FAIL was returned, because no edge descriptions werde defined.

```
Graph::getEdges(G1);
G1 := Graph::setEdgeDescriptions(G1, [[1, 2],[3, 1]],
    ["Route 66", "Speedway"]);
Graph::getEdgeDescriptions(G1)
```

```
[[1, 2], [2, 3], [3, 1]]
```

[1, 2]	"Route 66"
[3, 1]	"Speedway"

The first output shows all the edges and the second one the assigned edge descriptions.

```
G1 := Graph::setEdgeDescriptions(G1, [[2, 3]], ["Shortcut"]);
Graph::getEdgeDescriptions(G1)
```

[1, 2]	"Route 66"
[3, 1]	"Speedway"
[2, 3]	"Shortcut"

It is easy to see that only the edge description of [2,3] was changed.

## Example 2

First lets define a graph without edge Descriptions:

```
G1 := Graph::createCompleteGraph(3);
Graph::getEdgeDescriptions(G1)
```

```
FAIL
```

FAIL was returned, because no edge descriptions werde defined.

```
Graph::getEdges(G1);
G2 := Graph::setEdgeDescriptions(G1, [[1, 2], [3, 1]],
    ["Route 66", "Speedway"]);
Graph::getEdgeDescriptions(G2)
```

```
[[1, 2], [1, 3], [2, 1], [2, 3], [3, 1], [3, 2]]
```

[1, 2]	"Route 66"
[2, 1]	"Route 66"
[1, 3]	"Speedway"
[3, 1]	"Speedway"

The first output shows all the edges (the graph is undirected !) and the second one the assigned edge Descriptions. Not only the specified edges were set, but also the reverted edges.

```
Graph::getEdges(G1);
G2 := Graph::setEdgeDescriptions(G1, [[1, 2], [3, 1]],
                                   ["Route 66", "Speedway"],
                                   OnlySpecifiedEdges):
Graph::getEdgeDescriptions(G2)
```

```
[[1, 2], [1, 3], [2, 1], [2, 3], [3, 1], [3, 2]]
```

[1, 2]	"Route 66"
[3, 1]	"Speedway"

It is easy to see that only the specified edge Descriptions were changed and not the reverted edges, too.

### Example 3

There exist also the possibility to set the Descriptions via a table instead of a list.

```
tbl := table([1, 2] = "Highway", [1, 3] = "Road to nowhere"):
G2 := Graph::createCompleteGraph(3):
Graph::getEdgeDescriptions(G2):

G2 := Graph::setEdgeDescriptions(G2, [[1, 2], [3, 1]], tbl):
Graph::getEdgeDescriptions(G2)
```



[1, 2]	"Highway"
[2, 1]	"Highway"
[1, 3]	"Road to nowhere"
[3, 1]	"Road to nowhere"

And again, but this time only the specified edges:

```
tbl := table([1, 2] = "Highway", [1, 3] = "Road to nowhere"):
G2 := Graph::createCompleteGraph(3):
Graph::getEdgeDescriptions(G2):
G2 := Graph::setEdgeDescriptions(G2, [[1, 2], [3, 1]], tbl,
    OnlySpecifiedEdges):
Graph::getEdgeDescriptions(G2)
```

[1, 2]	"Highway"
[3, 1]	"Road to nowhere"

## Parameters

### G

A graph

### Edge

A list of one or more edges

### EdgeDescriptions

A list of one or more numbers, or a table consisting of the edges with their descriptions.

## Options

### OnlySpecifiedEdges

Only the edges specified in Edge will be set.

## **Return Values**

New graph with the corrected edge Descriptions.

# Graph::setEdgeWeights

Assigns edge weights to edges.

## Syntax

```
Graph::setEdgeWeights(G, Edge, EdgeWeights, <OnlySpecifiedEdges>)
```

## Description

Graph::setEdgeWeights(G, Edges, EdgeWeights) returns a graph where Edges have the edge weights EdgeWeights.

---

**Note** If *OnlySpecifiedEdges* is stated and an undirected graph is to be changed, only the edges specified are used and not the inverted ones. For example if a call Graph::setEdgeWeights(G, [[u,v]], [1]) is invoked, only the edge [u, v] gets 1. The edge [v, u] will not be changed.

---

---

**Note** The substitute None can be used when a specified edge should not get the assigned weights.

---

## Examples

### Example 1

How to set edge weights with a list:

```
G1 := Graph::createCircleGraph(3):  
Graph::getEdgeWeights(G1)
```

FAIL

FAIL was returned, because no edge weights were defined.

```
Graph::getEdges(G1);
G1 := Graph::setEdgeWeights(G1, [[1, 2], [3, 1]], [5, 1/2]);
Graph::getEdgeWeights(G1)
```

```
[[1, 2], [2, 3], [3, 1]]
```

[1, 2]	5
[3, 1]	$\frac{1}{2}$

The first output shows all the edges and the second one the assigned edge weights.

```
G1 := Graph::setEdgeWeights(G1, [[2, 3]], [infinity]);
Graph::getEdgeWeights(G1)
```

[1, 2]	5
[3, 1]	$\frac{1}{2}$
[2, 3]	$\infty$

It is easy to see that only the edge weight of [2, 3] was changed.

## Example 2

How to set edge weights with a table:

```
G1 := Graph::createCompleteGraph(3);
Graph::getEdgeWeights(G1)
```

```
FAIL
```

FAIL was returned, because no edge weights were defined.

```
Graph::getEdges(G1);
G2 := Graph::setEdgeWeights(G1, [[1, 2], [3, 1]], [5, 1/2]);
Graph::getEdgeWeights(G2)
```

```
[[1, 2], [1, 3], [2, 1], [2, 3], [3, 1], [3, 2]]
```

[1, 2]	5
[2, 1]	5
[1, 3]	$\frac{1}{2}$
[3, 1]	$\frac{1}{2}$

The first output shows all the edges (the graph is undirected !) and the second one the assigned edge weights. Not only the specified edges were set, but also the reverted edges.

```
Graph::getEdges(G1);
G2 := Graph::setEdgeWeights(G1, [[1, 2], [3, 1]], [5, 1/2],
    OnlySpecifiedEdges);
Graph::getEdgeWeights(G2)
```

```
[[1, 2], [1, 3], [2, 1], [2, 3], [3, 1], [3, 2]]
```

[1, 2]	5
[3, 1]	$\frac{1}{2}$

It is easy to see that only the specified edge Weights were changed and not the reverted edges, too.

### Example 3

There exist also the possibility to set the weights via a table instead of a list.

```
tbl := table([1, 2] = 15, [1, 3] = 20):
G2 := Graph::createCompleteGraph(3):

G2 := Graph::setEdgeWeights(G2, [[1, 2], [3, 1]], tbl):
Graph::getEdgeWeights(G2)
```

[1, 2]	15
[2, 1]	15
[1, 3]	20
[3, 1]	20

And again, but this time only the specified edges:

```
tbl := table([1, 2] = 15, [1, 3] = 20):  
G2 := Graph::createCompleteGraph(3):  
  
G2 := Graph::setEdgeWeights(G2, [[1, 2], [3, 1]], tbl,  
                             OnlySpecifiedEdges):  
Graph::getEdgeWeights(G2)
```

[1, 2]	15
[3, 1]	20

## Parameters

### **G**

A graph

### **Edge**

A list of one or more edges

### **EdgeWeights**

A list of one or more numbers, or a table consisting of the edges with their weights.

## Options

### **OnlySpecifiedEdges**

Only the edges specified in Edge will be set.

## **Return Values**

New graph with the corrected edge weights.

## Graph::setVertexWeights

Assigns vertex weights to vertices.

### Syntax

```
Graph::setVertexWeights(G, Vertex, VertexWeights)
```

### Description

Graph::setVertexWeights(G, Vertex, VertexWeights) returns a graph where the vertices in Vertex have the vertex weights VertexWeights.

---

**Note** The substitute None can be used when a specified edge should not get the assigned weights.

---

### Examples

#### Example 1

How to set vertex weights with a list:

```
G1 := Graph::createCircleGraph(3):  
Graph::getVertexWeights(G1)
```

FAIL

FAIL was returned, because no vertex weights were defined.

```
Graph::getVertices(G1);  
G1 := Graph::setVertexWeights(G1, [1, 3], [5, 1/2]):  
Graph::getVertexWeights(G1)
```

[1, 2, 3]



1	5
3	$\frac{1}{2}$

The first output shows all vertices and the second the assigned vertex weights.

## Example 2

How to set vertex weights with a table:

```
G1 := Graph::createCompleteGraph(3):
Graph::getVertexWeights(G1)
```

FAIL

FAIL was returned, because no vertex weights were defined.

```
G2 := Graph::createCompleteGraph(3):
tbl := table(1 = 15, 3 = 20):
G2 := Graph::setVertexWeights(G2, [1, 3], tbl):
Graph::getVertexWeights(G2)
```

1	15
3	20

## Parameters

### G

A graph

### Vertex

A list of one or more vertices

### VertexWeights

A list of one or more numbers, or a table consisting of the vertices with their weights.

## **Return Values**

New graph with the corrected vertex weights.

# Graph::shortestPathAllPairs

Shortest paths from and to all vertices

## Syntax

```
Graph::shortestPathAllPairs(G, <SearchFor = Weights | Costs>)
```

## Description

`Graph::shortestPathAllPairs(G)` returns a table with all paths between all vertices.

`Graph::shortestPathAllPairs(G, SearchFor=Costs)` returns a table with all paths according to the edge costs.

`Graph::shortestPathAllPairs(G, SearchFor=Weights)` returns a table with all paths according to the edge weights. (Default)

## Examples

### Example 1

A small graph to be used for the algorithms:

```
G := Graph([a, b, c, d], [[a, b], [a, c], [b, c], [c, d]],  
           EdgeWeights = [2, 1, 3, 2],  
           EdgeCosts = [1, 3, 1, 2],  
           Directed):
```

Now the shortest path between all vertices is found according to the edge weights, because no specification was given and defaults are used.

```
Graph::shortestPathAllPairs(G)
```

a, a	0		
a, b	2		
b, a	$\infty$	a, b	a
a, c	1	b, a	$\infty$
b, b	0	a, c	a
c, a	$\infty$	c, a	$\infty$
a, d	3	a, d	c
b, c	3	b, c	b
c, b	$\infty$	c, b	$\infty$
d, a	$\infty$	d, a	$\infty$
b, d	5	b, d	c
c, c	0	d, b	$\infty$
d, b	$\infty$	c, d	c
c, d	2	d, c	$\infty$
d, c	$\infty$		
d, d	0		

The interpretation of the table is as follows:

The first table holds each path: (FromVertex, ToVertex) = weight/cost. The second table is a bit more tricky. The left hand side again is the path itself. On the right hand side though, the vertex that was found before the final vertex was reached is stated. If for example the path from a to d is to be found with all vertices that are used within this path it is done in the following way: First take the path itself (a, d). The predecessor is c. Now have a look for the path (a, c). It's predecessor is a. Since the predecessor equals the first vertex in the path to be found, the search is over and the path a -> c -> d is found. To search the graph for costs the option SearchFor=Costs has to be added.

`Graph::shortestPathAllPairs(G, SearchFor = Costs)`

a, a	0		
a, b	1		
b, a	$\infty$	a, b	a
a, c	2	b, a	$\infty$
b, b	0	a, c	b
c, a	$\infty$	c, a	$\infty$
a, d	4	a, d	c
b, c	1	b, c	b
c, b	$\infty$	c, b	$\infty$
d, a	$\infty$	d, a	$\infty$
b, d	3	b, d	c
c, c	0	d, b	$\infty$
d, b	$\infty$	c, d	c
c, d	2	d, c	$\infty$
d, c	$\infty$		
d, d	0		

## Example 2

Now the weights of the graph are changed, so that negative edge weights are assigned. You will see that this does not influence the correctness of the results the algorithm returns (like for example Dijkstra).

```
G := Graph([a, b, c, d], [[a, b], [a, c], [b, c], [c, d]],
  EdgeWeights = [2, 1, 3, 2],
  EdgeCosts = [1, 3, 1, 2],
  Directed):
```

```
G := Graph::setEdgeWeights(G, Graph::getEdges(G), [2, 1, -3, 2]):
```

```
Graph::shortestPathAllPairs(G)
```

$a, a$	0		
$a, b$	2		
$b, a$	$\infty$	$a, b$	$a$
$a, c$	-1	$b, a$	$\infty$
$b, b$	0	$a, c$	$b$
$c, a$	$\infty$	$c, a$	$\infty$
$a, d$	1	$a, d$	$c$
$b, c$	-3	$b, c$	$b$
$c, b$	$\infty$	$c, b$	$\infty$
$d, a$	$\infty$	$d, a$	$\infty$
$b, d$	-1	$b, d$	$c$
$c, c$	0	$d, b$	$\infty$
$d, b$	$\infty$	$c, d$	$c$
$c, d$	2	$d, c$	$\infty$
$d, c$	$\infty$		
$d, d$	0		

## Parameters

**G**

Graph

## Options

**SearchFor**

Defines whether the weights of the graph are considered or the costs. Default is Weights.

## Return Values

List consisting of two tables. The first table holds the sum of the path weights or costs and the second the predecessors for every path (to find the complete path).

## Algorithms

The algorithm is also known as Floyd-Warshall or Roy-Warshall algorithm. The idea behind it is to solve the problem by continuous matrix multiplication. The only difference is that Floyd uses the assignment  $a_{i,j} := \min(a_{i,j}, a_{i,k} + a_{k,j})$ .

## References

[1] Ahuja, Magnanti, Orlin: Network Flows, Prentice-Hall, 1993 Section 5.6

## Graph::shortestPathSingleSource

Shortest paths from one single vertex

### Syntax

`Graph::shortestPathSingleSource(G, StartVertex, <EndVertex = v>, <SearchWith = Dijkstra`

### Description

`Graph::shortestPathSingleSource(G, StartVertex=vertex)` gives the length of a shortest path from `StartVertex` to every other vertex in `G`.

`Graph::shortestPathSingleSource(G, StartVertex=sv)` returns a table with all paths from `sv` to any other.

`Graph::shortestPathSingleSource(G, StartVertex=sv, ReturnAsGraph)` returns a table with all paths from `sv` to any other because `EndVertex` has to be set in order to get a Graph as return value.

With `Graph::shortestPathSingleSource(G, StartVertex=sv, EndVertex=ev, SearchWith=Dijkstra, SearchFor=Costs)` returns a table from vertex `sv` to vertex `ev` according to Dijkstra which used the edge-costs for its algorithm.

---

**Note** Using Dijkstra for shortest path can be erroneous if the graph contains negative edges.

---

---

**Note** If `ReturnAsGraph` is stated and `EndVertex` omitted, a table is returned nevertheless.

---



## Examples

### Example 1

A small graph to be used for the algorithms:

```
G := Graph([a, b, c, d], [[a, b], [a, c], [b, c], [c, d]],
           EdgeWeights = [2, 1, 3, 2],
           EdgeCosts = [1, 3, 1, 2], Directed):
```

Now the shortest path is found according to Bellman using edge weights, because no specification was given and defaults are used:

```
Graph::shortestPathSingleSource(G, StartVertex = [a])
```

$$\begin{array}{c|c|c|c} a & 0 & b & a \\ b & 2 & c & a \\ c & 1 & d & c \\ d & 3 & & \end{array}$$

To search the graph with Bellman for costs the option SearchFor=Costs has to be added:

```
Graph::shortestPathSingleSource(G, StartVertex = [a],
                               SearchFor=Costs)
```

$$\begin{array}{c|c|c|c} a & 0 & b & a \\ b & 1 & c & b \\ c & 2 & d & c \\ d & 4 & & \end{array}$$

### Example 2

Now the weights of the graph are changed, so that negative edge weights are assigned. After this the procedure is called again with Bellman and afterwards with Dijkstra to compare the results:

```
G := Graph([a, b, c, d], [[a, b], [a, c], [b, c], [c, d]],
           EdgeWeights = [2, 1, 3, 2],
           EdgeCosts = [1, 3, 1, 2], Directed):
```

```
G := Graph::setEdgeWeights(G, Graph::getEdges(G),
                           [2, 1, -3, 2]);

Graph::shortestPathSingleSource(G, StartVertex = [a],
                                SearchWith = Bellman),
Graph::shortestPathSingleSource(G, StartVertex = [a],
                                SearchWith = Dijkstra)
```

$$\left[ \begin{array}{c|c} a & 0 \\ b & 2 \\ c & -1 \\ d & 1 \end{array} \right], \left[ \begin{array}{c|c} b & a \\ c & b \\ d & c \end{array} \right], \left[ \begin{array}{c|c} a & 0 \\ b & 2 \\ c & -1 \\ d & 3 \end{array} \right], \left[ \begin{array}{c|c} b & a \\ c & a \\ d & c \end{array} \right]$$

This is a typical example where Dijkstra can make a mistake because he does not correct earlier solutions (a so called greedy strategy). Although vertex c gets the correct value -1, at the time d got the value 3, vertex c still held the value 1. This happens because Dijkstra first searches the best solutions (a->c = 1) then traverses further (c->d = 1 + 2 = 3). In spite of changing the value of vertex c the value for d is never to be changed again (because no other path ever reaches it again):

It might be interesting to see a shortest path inside the graph. Here are two steps that accomplish this task:

Fist step (creation of a shortest path graph [in this case with Dijkstra]):

```
dijk := Graph::shortestPathSingleSource(G, StartVertex = [a],
                                         EndVertex = [d],
                                         SearchWith = Dijkstra,
                                         ReturnAsGraph):
```

Second step (combination of the graphs using plotGridGraph):

```
plot(Graph::plotGridGraph(G, VerticesPerLine = 4,
                          VertexOrder = [None, b, None, d, a, None, c, None],
                          VertexColor = RGB::Red,
                          SpecialEdges = Graph::getEdges(dijk),
                          SpecialEdgeColor = RGB::Blue))
```

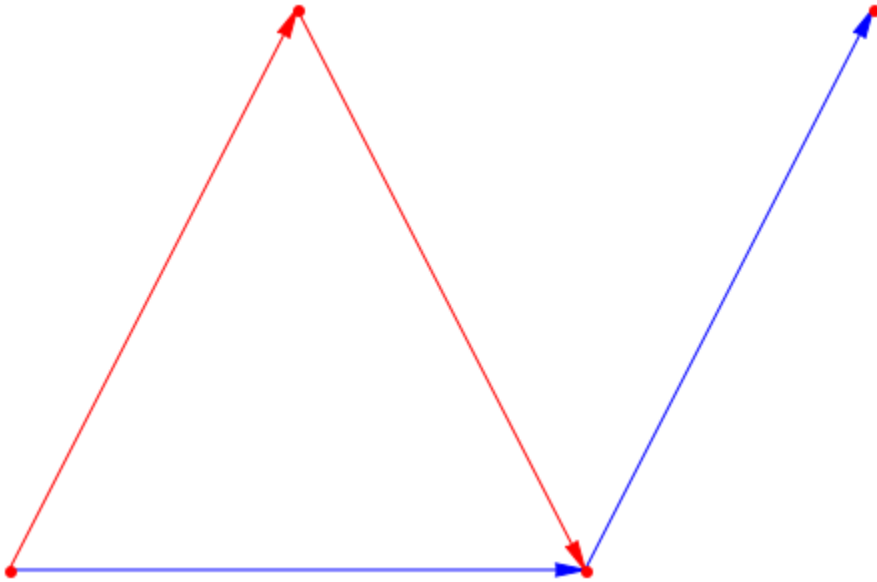

The same with Bellman to show the differences:

First step (creation of a shortest path graph [in this case with Dijkstra]):

```
bellm := Graph::shortestPathSingleSource(G, StartVertex = [a],
                                         EndVertex = [d],
                                         SearchWith = Bellman,
                                         ReturnAsGraph):
```

Second step (combination of the graphs using plotGridGraph):

```
plot(Graph::plotGridGraph(G, VerticesPerLine = 4,
                          VertexOrder = [None, b, None, d, a, None, c, None],
                          VertexColor = RGB::Red,
                          SpecialEdges = Graph::getEdges(bellm),
                          SpecialEdgeColor = RGB::Blue))
```

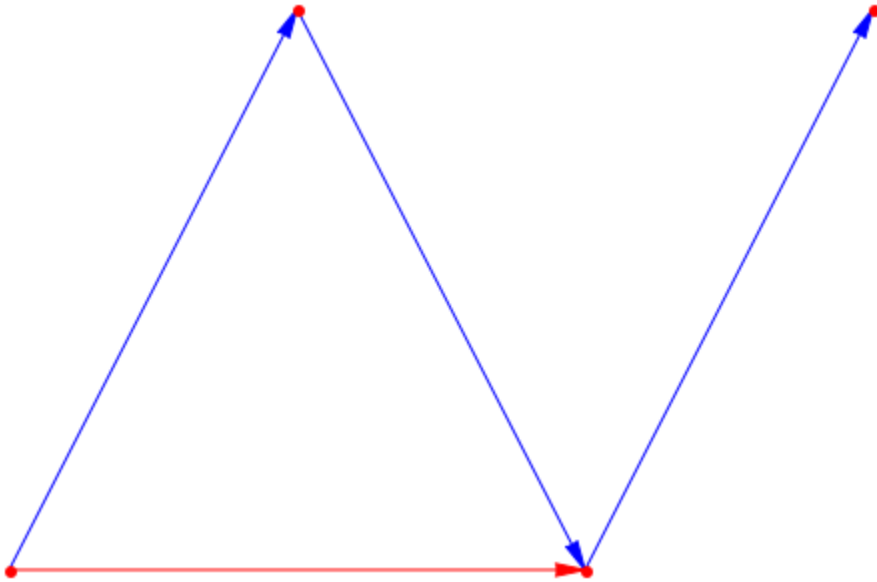

## Parameters

**G**

Graph

**vertex**

A vertex in G

## Options

**EndVertex**

Specifies a single vertex to which the shortest path is to be found.

**SearchWith**

Defines the algorithm to use. Dijkstra can be erroneous if the graph consists of negative edges. Default is Bellman

**SearchFor**

Defines whether the weights of the graph are considered or the costs. Default is Weights.

**ReturnAsGraph**

If stated and EndVertex is set, the path is returned as a Graph. If stated and EndVertex is not set, this option is omitted.

**Return Values**

Either a list consisting of two tables or a Graph. The first table holds the weights or cost for each vertex and the second the predecessors for every vertex (to find the path)

**Algorithms**

Both, Bellman and Dijkstra expect a Graph without negative circles. Only Dijkstra may return erroneous results when negative edges (either weights or costs) are specified.

The Bellman algorithm originated from: Ahuja, Magnanti, Orlin: Graph Flows, Prentice-Hall, 1993 Section 5.4

## Graph::stronglyConnectedComponents

Finds the strongly connected components

### Syntax

`Graph::stronglyConnectedComponents(G)`

### Description

`Graph::stronglyConnectedComponents(G)` finds the strongly connected components of  $G$

`Graph::stronglyConnectedComponents` returns all the strongly connected components of a graph. Single vertices form a component of themselves.

### Examples

#### Example 1

Two obvious components pointing to a single vertex:

```
G1 := Graph([a, b, c, d, e, f, g],
            [[a, b], [b, g], [g, a], [b, c],
             [d, c], [e, d], [d, f], [f, e]], Directed);

plot(Graph::plotGridGraph(G1,
    VertexOrder = [a,    None, None, None, e,
                  None, b,  c,  d,  None,
                  g,   None, None, None, f],
    VerticesPerLine=5))
```

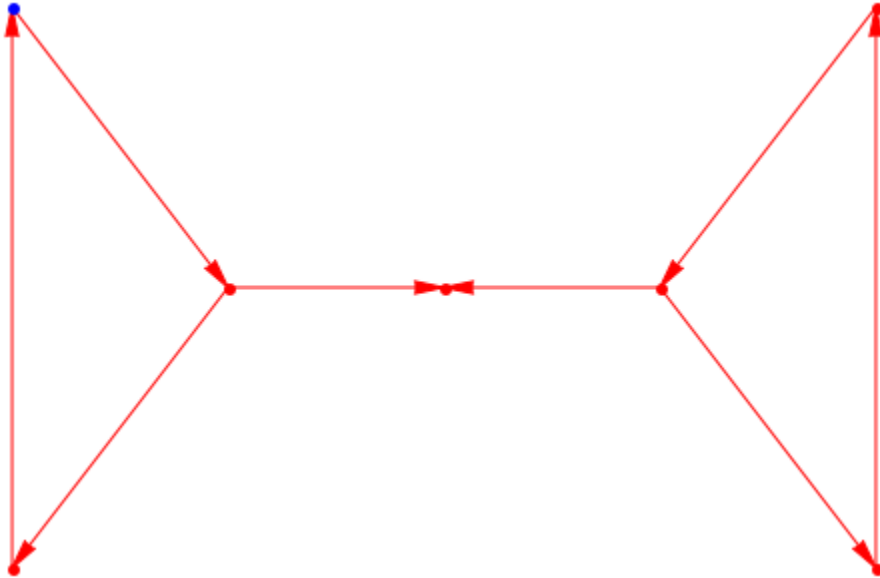

The graphical output reveals the two "big" components [a, b, g] and [d, e, f]. The single vertex [c] forms a component of itself:

```
G2 := Graph::stronglyConnectedComponents(G1)
```

```
[Graph(...), Graph(...), Graph(...)]
```

A list containing three Graphs is returned. Now we find out which vertices belong to each component:

```
Graph::getVertices(op(G2, 1))
```

```
[d, e, f]
```

```
Graph::getVertices(op(G2, 2))
```

```
[a, b, g]
```

```
Graph::getVertices(op(G2, 3))
```

[c]

## Example 2

A complete graph is returned as a single component:

```
G3 := Graph::createCompleteGraph(5):  
plot(Graph::plotCircleGraph(G3))
```

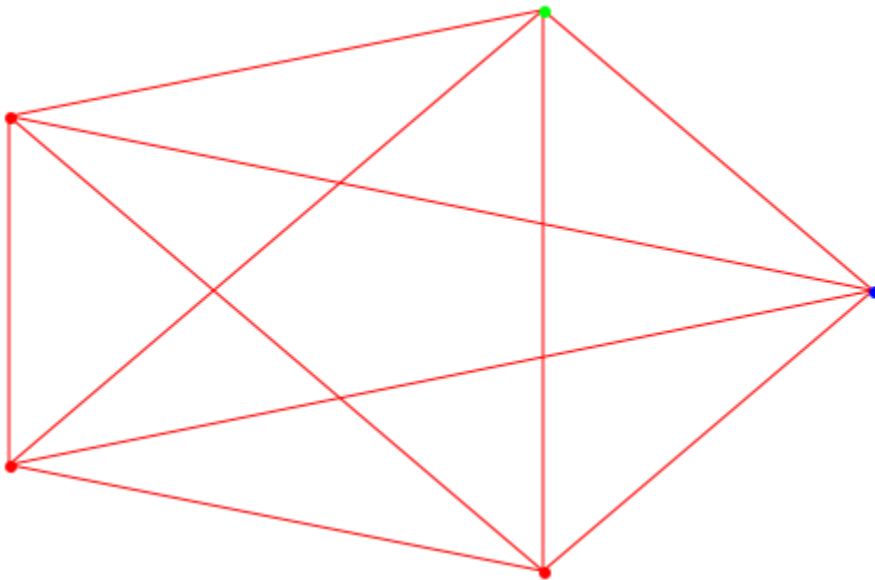

```
G4 := Graph::stronglyConnectedComponents(G3):  
plot(Graph::plotCircleGraph(op(G4)))
```



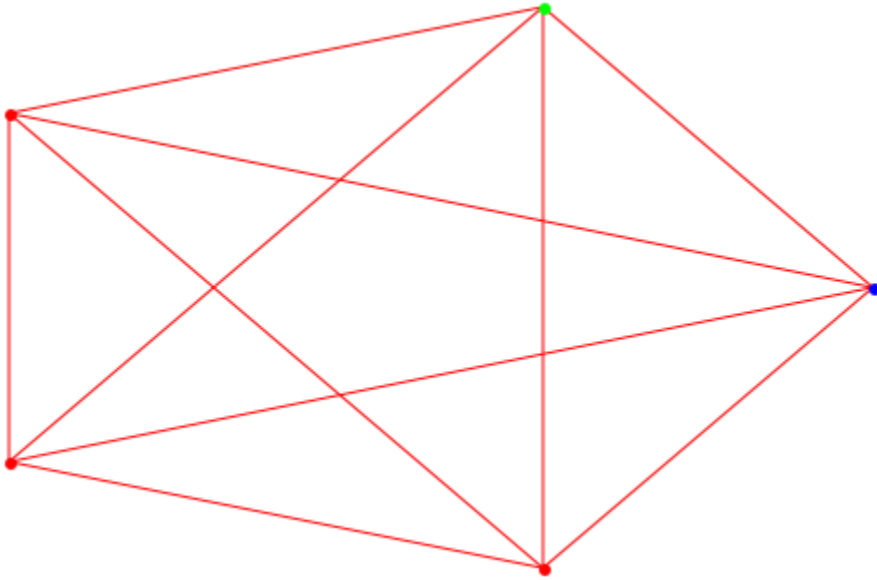

It was necessary to use `op(G4)`, because `G4` is a list containing a graph!

## Parameters

**G**

A graph

## Return Values

List of graphs containing the strongly connected components.

## Graph::topSort

Topological sorting of the vertices

### Syntax

Graph::topSort(G)

### Description

Graph::topSort(G) computes a topological sorting of the graph G, i.e., a numbering  $T$  of the vertices, such that  $T_i < T_j$  whenever there is an edge  $[i, j]$  in the graph. Single vertices are positioned at the beginning.

Graph::topSort returns a list containing two tables. The first table holds the ordering of the vertices. The second table shows the predecessors of each vertex. If several vertex  $u_i$  precede a vertex  $v$ , the first vertex in the ordering of  $u_i$  is the predecessor of  $v$ . If no predecessor exist, the value will be *infinity*.

---

**Note** If G contains any cycle then a topological sorting does not exist and the call of Graph::topSort results in an error.

---

### Examples

#### Example 1

A "butterfly" graph that is decomposed in three strongly connected components:

```
G1 := Graph([a, b, c, d, e, f],  
           [[a, b], [a, c], [a, d], [c, e], [d, e]],  
           Directed):  
Graph::topSort(G1)
```

1	f	a	a
2	a	b	a
3	b, c	c	a
4	c	d	a
5	d	e	c
6	e	f	$\infty$

The first table shows the ordering of the vertices. The left side holds the order for each vertex, whereas the right side holds the name of the vertex. The second table shows the predecessors of each vertex. If no predecessor exist, the right side holds *infinity*. Otherwise the right side holds the vertex that is the direct predecessor of the vertex on the left side. To see how the graph looks a graphical plotting helps:

```
plot(Graph::plotGridGraph(G1,
    VertexOrder = [None, b, f,
                  a, c, None,
                  None, None, e,
                  None, d, None],
    VerticesPerLine=3))
```

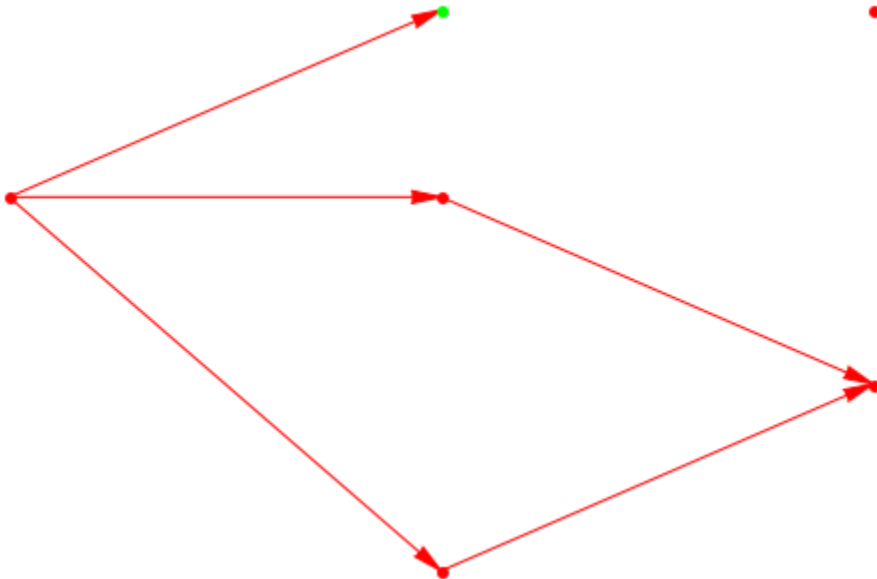

## **Parameters**

**G**

A graph

## **Return Values**

List containing two tables.

# groebner - Gröbner bases

---

## groebner::dimension

Dimension of the affine variety generated by polynomials

### Syntax

```
groebner::dimension(polys, <order>)
```

### Description

`groebner::dimension(polys)` computes the dimension of the affine variety generated by the polynomials in the set or list `polys`.

The rules laid down in the introduction to the `groebner` (Symbolic Math Toolbox) package concerning the polynomial types and the ordering apply.

The polynomials in the list `polys` must all be of the same type. In particular, do not mix polynomials created via `poly` and polynomial expressions!

### Examples

#### Example 1

An example from the book of Cox, Little and O'Shea (see below):

```
groebner::dimension([y^2*z^3, x^5*z^4, x^2*y*z^2])
```

2

## Parameters

### **polys**

A list or set of polynomials or polynomial expressions of the same type. The coefficients in these polynomials and polynomial expressions can be arbitrary arithmetical expressions.

### **order**

One of the identifiers `DegInvLexOrder`, `DegreeOrder`, and `LexOrder`, or a user-defined term ordering of type `Dom::MonomOrdering`. The default ordering is `DegInvLexOrder`.

## Return Values

Nonnegative integer

## References

The implemented algorithm is described in Cox, Little, O'Shea: "Ideals, Varieties and Algorithms", Springer, 1992, Chapter 9.

## Algorithms

First, the Gröbner basis of the given polynomials with respect to the given monomial ordering is computed using `groebner::gbasis`. This Gröbner basis is then used to compute the dimension of the affine variety generated by the polynomials.

## See Also

### **MuPAD Functions**

`groebner::gbasis` | `poly`

## groebner::eliminate

Eliminate variables

### Syntax

```
groebner::eliminate(sys, vars)
```

### Description

`groebner::eliminate(sys, vars)` returns a list of polynomial expressions obtained by eliminating the elements of `vars` from `sys`. In other words, the return value does not contain the variables in `vars`, every zero of the original system `sys` must be a zero of the return value, and every tuple of numbers that makes the return value zero can be extended to a solution of `sys`.

### Examples

#### Example 1

Suppose that  $x^2 + y = 0$  and  $x + y = 0$ , what does this imply for  $y$ ?

```
groebner::eliminate({x^2 + y, y+x}, {x})
```

```
[y^2 + y]
```

We infer that for every pair  $(x, y)$  solving the system,  $y$  must satisfy  $y^2 + y = 0$ , that is,  $y = 0$  or  $y = -1$ . Indeed:

```
solve({x^2 + y, y+x}, {x, y})
```

```
{[x = 0, y = 0], [x = 1, y = -1]}
```



## Parameters

### **sys**

A set or list of polynomial expressions. The coefficients in these polynomial expressions can be arbitrary arithmetical expressions.

### **vars**

A set or list of identifiers

## Return Values

List of polynomial expressions

## Algorithms

`groebner::eliminate` proceeds by computing a lexical-order Gröbner basis. Hence the computation complexity grows fast when increasing the number of variables.

## See Also

### **MuPAD Functions**

`groebner::gbasis`

## groebner::gbasis

Computation of a reduced Gröbner basis

### Syntax

```
groebner::gbasis(polys, <order>, options)
```

### Description

`groebner::gbasis(polys)` computes a reduced Gröbner basis of the ideal generated by the polynomials in the list `polys`.

The rules laid down in the introduction to the `groebner` (Symbolic Math Toolbox) package concerning the polynomial types and the ordering apply.

The polynomials in the list `polys` must all be of the same type. In particular, do not mix polynomials created via `poly` and polynomial expressions!

The ordering strategy indicated by `Reorder` is used automatically when polynomial expressions are used.

### Examples

#### Example 1

We demonstrate the effect of various input formats. First, we use polynomial expressions to define the polynomial ideal. The Gröbner basis is returned as a list of polynomial expressions:

```
groebner::gbasis([x^2 - y^2, x^2 + y], LexOrder)
```

```
[x^2 + y, x^4 - x^2]
```

Next, the same polynomials are defined via `poly`. Note that `poly` fixes the ordering of the variables.

```
groebner::gbasis([poly(x^2 - y^2, [x, y]),
                 poly(x^2 + y, [x, y])], LexOrder)
```

$$\left[ \text{poly}(x^2 + y, [x, y]), \text{poly}(y^2 + y, [x, y]) \right]$$

Changing the ordering of the variables in `poly` changes the lexicographical ordering. This results in a different basis:

```
groebner::gbasis([poly(x^2 - y^2, [y, x]),
                 poly(x^2 + y, [y, x])], LexOrder)
```

$$\left[ \text{poly}(y + x^2, [y, x]), \text{poly}(x^4 - x^2, [y, x]) \right]$$

With `Reorder` the ordering of the variables may be changed internally:

```
groebner::gbasis([poly(x^2 - y^2, [x, y]),
                 poly(x^2 + y, [x, y])], LexOrder, Reorder)
```

$$\left[ \text{poly}(y + x^2, [y, x]), \text{poly}(x^4 - x^2, [y, x]) \right]$$

## Example 2

Polynomials over arbitrary fields are allowed. In particular, you can use the field of rational functions in some given variable(s):

```
F := Dom::Fraction(Dom::DistributedPolynomial([y])):
F::Name := "Q(y)":
groebner::gbasis(
[poly(y*z^2 + 1, [x, z], F),
 poly((y^2 + 1)*x^2 - y - z^3, [x, z], F)])
```

$$\left[ \text{poly}\left(x^2 + \frac{z}{y+y^3} - \frac{y}{y^2+1}, [x, z], \text{Q}(y)\right), \text{poly}\left(z^2 + \frac{1}{y}, [x, z], \text{Q}(y)\right) \right]$$

```
delete F:
```

## Parameters

### **polys**

A list or set of polynomials or polynomial expressions of the same type. The coefficients in these polynomials and polynomial expressions can be arbitrary arithmetical expressions. If `polys` are polynomials over an arbitrary domain, then their coefficients must be domain elements and the domain must be a field.

### **order**

One of the identifiers `DegInvLexOrder`, `DegreeOrder`, and `LexOrder`, or a user-defined term ordering of type `Dom::MonomOrdering`. The default ordering is `DegInvLexOrder`.

## Options

### **Factor**

With this option, `groebner::gbasis` returns a set of lists, such that each list is the Gröbner basis of an ideal. The union of these ideals is a superset of the ideal given as input, and a subset of the radical of that ideal. In other words, it has the same variety (only the multiplicity of points can change).

### **IgnoreSpecialCases**

With this option, `groebner::gbasis` handles all coefficients in all intermediate results as nonzero unless these coefficients are equal to zero for all parameter values. In other words, if the coefficients are rational functions of the free parameters, then results are correct on all of the parameter space except on an algebraic variety of lower dimension.

### **Reorder**

With this option `groebner::gbasis` internally may change the lexicographical ordering of variables to decrease running time.

With this option the variables are sorted internally such that they have a “heuristic optimal” ordering. Consequently, the ordering of the variables in the output polynomials may differ from their ordering in the input polynomials. For details on the ordering strategy, see W. Boege, R. Gebauer und H. Kredel: “Some Examples for Solving Systems of

Algebraic Equations by Calculating Groebner Bases” in J. Symbolic Comp. (1986) Vol. 1, 83-98.

Re-ordering is always applied when polynomial expressions are used for input.

### **Monic**

Option, specified as `Monic = N`

This option sets the normalizing routine to `N`. For every polynomial `f` in the polynomial ring, `N(f, o)` must return some associate of `f`, where `o` is the chosen order.

The method `N` should be chosen such that it produces simple output.

By default, `polylib::primpart` is used for polynomials with integer coefficients; other polynomials are divided by their leading coefficient.

### **Order**

Option, specified as `Order = order`

This option is equivalent to passing `order` as an argument.

## **Return Values**

List of polynomials. The output polynomials have the same type as the polynomials of the input list.

## **References**

For general information, see T. Becker and V. Weispfenning: “Gröbner Bases”, Springer (1993). For details on the sugar selection strategy, see A. Giovini, T. Mora, G. Niesi, L. Robbiano, C. Traverso: “One sugar cube, please — or Selection strategies in the Buchberger algorithm”, Proc. ISSAC '91, Bonn, 49-54 (1991).

## Algorithms

In most cases, `groebner::gbasis` computes the basis via the Buchberger algorithm with the “sugar” selection strategy being used.

## See Also

### **MuPAD Functions**

`poly`

# groebner::normalf

Complete reduction modulo a polynomial ideal

## Syntax

```
groebner::normalf(p, polys, <order>)
```

## Description

`groebner::normalf(p, polys)` computes a normal form of the polynomial `p` by complete reduction modulo all polynomials in the list `polys`.

The rules laid down in the introduction to the `groebner` (Symbolic Math Toolbox) package concerning the polynomial types and the ordering apply.

The polynomials in the list `polys` must all be of the same type as `p`. In particular, do not mix polynomials created via `poly` and polynomial expressions.

## Examples

### Example 1

We consider the ideal generated by the following polynomials:

```
p1 := poly(x^2 - x + 2*y^2, [x,y]):
p2 := poly(x + 2*y - 1, [x,y]):
```

We compute the normal form of the following polynomial `p` modulo the ideal generated by `p1`, `p2` with respect to lexicographical ordering:

```
p := poly(x^2*y - 2*x*y + 1, [x,y]):
groebner::normalf(p, [p1, p2], LexOrder);
```

$$\text{poly}(-2 y^3 + 2 y^2 - y + 1, [x, y])$$

Note that  $p_1, p_2$  do not form a Gröbner basis. The corresponding Gröbner basis leads to a different normal form of  $p$ :

```
groebner::normalf(p, groebner::gbasis([p1, p2]), LexOrder)
```

$$\text{poly}\left(-\frac{5}{9}y + 1, [x, y]\right)$$

```
delete p1, p2, p:
```

## Parameters

**p**

A polynomial or a polynomial expression. The coefficients in this polynomial and polynomial expression can be arbitrary arithmetical expressions.

**polys**

A list of polynomials of the same type as  $p$ . In particular, if  $p$  is a polynomial expression,  $\text{polys}$  must be a list of polynomial expressions.

**order**

One of the identifiers `DegInvLexOrder`, `DegreeOrder`, and `LexOrder`, or a user-defined term ordering of type `Dom::MonomOrdering`. The default ordering is `DegInvLexOrder`.

## Return Values

Polynomial of the same type as the input polynomials. If polynomial expressions are used as input, then a polynomial expression is returned.

## Algorithms

A polynomial  $g$  is a reduced form of a polynomial  $p$  modulo a list of polynomials  $p_1, \dots, p_n$ , if  $g \equiv p$  and none of the leading terms of the  $p_i$  divides the leading term of  $p$ , or if — for some  $i$  —  $g$  is a reduced form of  $p - q p_i$ , where  $q$  is the quotient of the leading monomial



of  $p$  and the leading monomial of  $p_i$ . A reduced form always exists, but need not be unique. It is unique, if the  $p_i$  form a Gröbner basis.

In the implementation of `groebner::normalf`, reduction modulo some  $p_i$  of largest possible total degree is preferred, if reduction modulo several  $p_i$  is possible.

## See Also

### **MuPAD Functions**

`groebner::gbasis` | `poly`

## groebner::spoly

The S-polynomial of two polynomials

### Syntax

```
groebner::spoly(p1, p2, <order>)
```

### Description

`groebner::spoly(p1, p2)` computes the S-polynomial of the polynomials `p1` and `p2`.

The rules laid down in the introduction to `groebner` (Symbolic Math Toolbox) concerning the polynomial types and the ordering apply.

The polynomials must be of the same type. In particular, do not mix polynomials created via `poly` and polynomial expressions!

### Examples

#### Example 1

The polynomials

```
p1 := poly(x^2 - x + 2*y^2, [x, y]):  
p2 := poly(x + 2*y - 1, [x, y]):
```

generate the following S-polynomial with respect to lexicographical ordering:

```
groebner::spoly(p1, p2, LexOrder)
```

```
poly(-2 x y + 2 y^2, [x, y])
```

```
delete p1, p2:
```

## Parameters

**$p_1, p_2$**

A list or set of polynomials or polynomial expressions of the same type. The coefficients in these polynomials and polynomial expressions can be arbitrary arithmetical expressions.

**order**

One of the identifiers `DegInvLexOrder`, `DegreeOrder`, and `LexOrder`, or a user-defined term ordering of type `Dom::MonomOrdering`. The default ordering is `DegInvLexOrder`.

## Return Values

Polynomial of the same type as the input polynomials. If polynomial expressions are used as input, then a polynomial expression is returned.

## Algorithms

The S-polynomial of two polynomials  $p_1, p_2$  is defined to be

$$\frac{\text{lcm}(\text{lterm}(p_1), \text{lterm}(p_2))}{\text{lmonomial}(p_1)} p_1 - \frac{\text{lcm}(\text{lterm}(p_1), \text{lterm}(p_2))}{\text{lmonomial}(p_2)} p_2$$

where `lterm` and `lmonomial` are used in the same sense as the MuPAD functions of the same name. This formula is constructed such that the leading terms of the two summands cancel.

## See Also

**MuPAD Functions**

`poly`

## groebner::stronglyIndependentSets

Strongly independent set of variables

### Syntax

```
groebner::stronglyIndependentSets(G)
```

### Description

`groebner::stronglyIndependentSets(G)` computes a strongly independent set of variables modulo the ideal generated by  $G$ .

A set of variables  $S$  is strongly independent modulo an ideal  $I$  if no leading term of an element of the Gröbner basis of  $I$  consists entirely of elements of  $S$ . A set is maximally strongly independent if no proper superset of it is strongly independent. Two maximally strongly independent set may be of different size.

`groebner::stronglyIndependentSets` accepts Gröbner bases in the format returned by `groebner::gbasis`.

### Examples

#### Example 1

The following example has been given by Moeller and Mora in 1983.

```
G:=map([X0^8*X2, X0*X3, X1^8*X3, X1^7*X3^2, X1^6*X3^3,  
      X1^5*X3^4, X1^4*X3^5, X1^3*X3^6, X1^2*X3^7, X1*X3^8],  
      poly, [X3, X2, X1, X0]):  
groebner::stronglyIndependentSets(G)
```

```
[2, {X0, X1}, {{X2, X3}, {X0, X1}, {X1, X2}}]
```

```
delete G:
```

## Parameters

### G

The Gröbner basis of an ideal: a list on page 7-41.

## Return Values

List of the form  $[d, S, M]$ , where  $d$  is an integer equal to the dimension of the ideal generated by  $G$ ,  $S$  is the greatest strongly independent set of variables, and  $M$  is a set consisting of all maximal strongly independent sets of variables or a piecewise consisting of such lists.

## References

[1] Kredel H. and V. Weispfenning, "Computing dimension and independent sets for polynomial ideals", JSC volume 6 (1988), 231-247.

## See Also

### MuPAD Functions

groebner::gbasis



# import - Import Data

---

## import::csv

Read CSV data from an ASCII file

### Syntax

```
import::csv(filename, <separator>, <NonNested>, <Trim>, <DecimalComma>)
```

```
import::csv(n, <separator>, <NonNested>, <Trim>, <DecimalComma>)
```

### Description

`import::csv` is used to read CSV (“Comma Separated Values” or “Character Separated Values”) data files produced by external programs, like Microsoft Excel®. CSV is an ASCII based tabular data file format, formally defined in RfC 4180, that has fields separated by the comma character.

---

**Note** Some localized versions of Microsoft Excel use semicolons instead of commas! Set the parameter `separator` to change the default separator.

---

`import::csv(filename)` reads the data in the file `filename`. File data separated by a comma are regarded as different data elements. The result is a list of lists, each sublist representing one line of the file.

`import::csv(filename, separator)` reads the data in the file `filename`. File data separated by the character `separator` are regarded as different data elements. The result is a list of lists, each sublist representing one line of the file.

`import::csv(filename, separator, NonNested)` reads the data in the file `filename` as a single data record. File data separated by the character `separator` are regarded as different data elements. The result is a plain non-nested list containing the data of all lines of the file.

In contrast to `finput`, the data must not be ended by a colon or semicolon. Data separated by `separator` are interpreted as single data items. The default separator is a comma.



Empty lines are ignored.

All data elements in the file that cannot be converted to valid MuPAD numbers are imported as MuPAD strings.

`import::csv` tries to convert a number contained in the CSV file to a valid MuPAD number. For example: 1,234.56 or 1 234.56 are converted to the MuPAD number 1234.56. Many countries use a comma to separate the integral and fractional part instead of the dot used in England and the US. For example: 1234,56 or 1.234,56 are converted to 1234.56. `import::csv` expects this number format if the option `DecimalComma` is given.

---

**Note** A comma as CSV separator doesn't make sense if the comma is used to separate thousands in a number or the decimal comma is used. In most cases, the CSV file uses a semicolon to separate data. So, a semicolon should be used as separator.

---

---

**Note** All numbers contained in the CSV file must use the same radix separator, mixed formats cannot be converted.

---

With `NonNested`, the result will be a list containing all data. Otherwise, the result is a list of list, each "inner" list representing a line of the CSV file.

With `Trim`, leading and trailing blanks in strings are removed.

If the file is specified by a string, the corresponding file is opened and closed, automatically. If the user has opened a text file in `Read` mode and passes the file descriptor to `import::readdata`, the file remains open and needs to be closed by the user.

Files compressed with `gzip` or in a compatible format, whose names end in `".gz"`, are automatically decompressed while being read by `import::csv`.

`import::csv(filename)` searches for the file in various directories:

- First, the name is interpreted as a relative file name: `filename` is concatenated to each directory given by the environment variable `READPATH`.
- Then the file name is interpreted as an absolute path name.
- Then the file name is interpreted relative to the "working directory".
- Last, the file name is concatenated to the directory path.

If a file can be opened with one of this names, then the file is read.

Note that the meaning of “working directory” depends on the operating system. On Microsoft Windows systems and on Apple Mac OS X systems, the “working directory” is the folder where MuPAD is installed. On UNIX systems, it is the current working directory in which MuPAD was started; when started from a menu or desktop item, this is typically the user's home directory.

A path separator (“/”) is inserted as necessary when concatenating a given path and filename.

If a file is specified by a file name, there is no need to open or close the file via `fopen` and `fclose`, respectively. This is done automatically by `import::readdata`.

Instead of a file name, also a file descriptor of a file opened via `fopen` can be used. Note that the file must have been opened in Read mode by `fopen`. If a file descriptor is used, the corresponding file is not closed automatically but must be closed by the user via `fclose`.

## Examples

### Example 1

We wish to read CSV data into a MuPAD session. Assume that the file “`datafile.csv`” contains the following two columns of ASCII data:

```
a ,12.5
a-b ,1234.56
```

`import::csv` returns the following list representing the data in the file:

```
data := import::csv("datafile.csv")
```

```
[[ "a ", 12.5 ], [ " a-b ", 1234.56 ]]
```

```
data := import::csv("datafile.csv", Trim)
```

```
[[ "a", 12.5 ], [ "a-b", 1234.56 ]]
```

```
data := import::csv("datafile.csv", NonNested)
```

```
["a", 12.5, " a-b ", 1234.56]
```

## Example 2

Let us assume that the file “datafile.csv” contains the following ASCII data:

```
a ;12.5
a-b;1,234.56
a b; -12345.6789E-02
```

We specify the data separator ";" for reading the data:

```
import::csv("datafile.csv", ";")
```

```
[[["a", 12.5], ["a-b", 1234.56], ["a b", -123.456789]]]
```

## Example 3

Let us assume that the file “datafile.csv” contains the following ASCII data:

```
abc;12,5
a-b;1.234,56
a b; -12345.6789E-02
```

We specify the data separator ";" and the option `DecimalComma` for reading the data:

```
import::csv("datafile.csv", ";", DecimalComma)
```

```
[[["a", 12.5], ["a-b", 1234.56], ["a b", -123.456789]]]
```

## Parameters

### filename

The file name: a non-empty character string on page 7-53

**n**

A file descriptor provided by `fopen`: a positive integer

### **separator**

The separator between data elements: a character string on page 7-53 of length 1 (a single character). The default separator is a comma (the single character string `" , "`).

## **Options**

### **NonNested**

Return all file data as a single data record in a non-nested list. The data of all lines are ordered sequentially in this list.

### **Trim**

Leading and trailing blanks in strings are removed.

### **DecimalComma**

A decimal comma instead of a decimal point is used as the radix separator in the CSV file.

## **Return Values**

Nested list on page 7-41 of lists. The sublists contain the data of the individual lines. With the option `NonNested`, a plain list containing all data elements from every line in the file.

## **See Also**

### **MuPAD Functions**

`FILEPATH` | `READPATH` | `fopen` | `import::readdata` | `readbytes`

# import::readbitmap

Read bitmap data

## Syntax

```
import::readbitmap(filename, <ReturnType = DOM_HFARRAY | DOM_ARRAY | DOM_LIST>)
```

## Description

`import::readbitmap` is used for reading ASCII or binary data files storing bitmap images of pictures. The following standard graphical formats can be read: BMP, DCX, DDS, WAD, GIF, ICO, JPG, LIF, MDL, PCD, PCX, PIC, PIX, PNG, PNM, PSD, PSP, PXR, RAW, SGI, TGA, TIF, WAL, XPM. The format of the pixel data is determined automatically from the contents of the file. The return value `[w, h, colordata]` provides the pixel height `h`, the pixel width `w`, and the color data of the bitmap image.

Either the complete return value or just the third element, `colordata`, can be passed to the function `plot::Raster` to generate a plot object that can be used in a MuPAD graphics. E.g., the command

```
plot(plot::Raster(import::readbitmap("mypicture.jpeg")))
```

creates a MuPAD graphics of the bitmap stored in the JPG file "mypicture.jpeg".

---

**Note** Most of the standard graphical formats store the pixel data row by row in the usual reading order starting with the upper left corner of the image. The pixel data in the returned array `colordata` (if requesting `ReturnType = DOM_ARRAY`), however, are to be interpreted as follows:

`colordata[1, 1]` is the RGB color of the lower left corner.

`colordata[h, 1]` is the RGB color of the upper left corner.

`colordata[1, w]` is the RGB color of the lower right corner.

`colordata[h, w]` is the RGB color of the upper right corner.

The interpretation of the other return types is analogous, see below for details on the return types.

---

This is consistent with the interpretation of a color array by `plot::Raster`.

`import::readbitmap(filename)` searches for the file in various directories:

- First, the name is interpreted as a relative file name: `filename` is concatenated to each directory given by the environment variable `READPATH`.
- Then the file name is interpreted as an absolute path name.
- Then the file name is interpreted relative to the “working directory.”
- Last, the file name is concatenated to the directory path.

If a file can be opened with one of this names, then the file is read.

Note that the meaning of “working directory” depends on the operating system. On Microsoft Windows systems and on Apple Mac OS X systems, the “working directory” is the folder where MuPAD is installed. On UNIX systems, it is the current working directory in which MuPAD was started; when started from a menu or desktop item, this is typically the user's home directory.

A path separator (“/”) is inserted as necessary when concatenating a given path and filename.

`import::readbitmap` does not accept file handles returned by `fopen`. Nor can it handle files which have been compressed by `gzip`, but since most bitmap formats employ high quality compression in any case, there is little reason to try compressing them again in any case.

## Examples

### Example 1

We import a PGM (portable graymap) picture:

```
[w, h, Norton] := import::readbitmap("Norton.pgm");
```

The bitmap image is to be embedded in a MuPAD graphics. We use the width `w` and the height `h` to place the bitmap in a rectangle whose sides have the same ratio as the

original bitmap. With `Scaling = Constrained` we make sure that this aspect ratio is also used in the final graphics:

```
xmin := 2: xmax := xmin + w/100:  
ymin := 0.5: ymax := ymin + h/100:  
plot(plot::Function2d(x*sin(PI/x), x = -1..4.5, AdaptiveMesh = 2),  
      plot::Raster(Norton, x = xmin ..xmax, y = ymin .. ymax),  
      Scaling = Constrained, Footer = "Work And Play"):
```

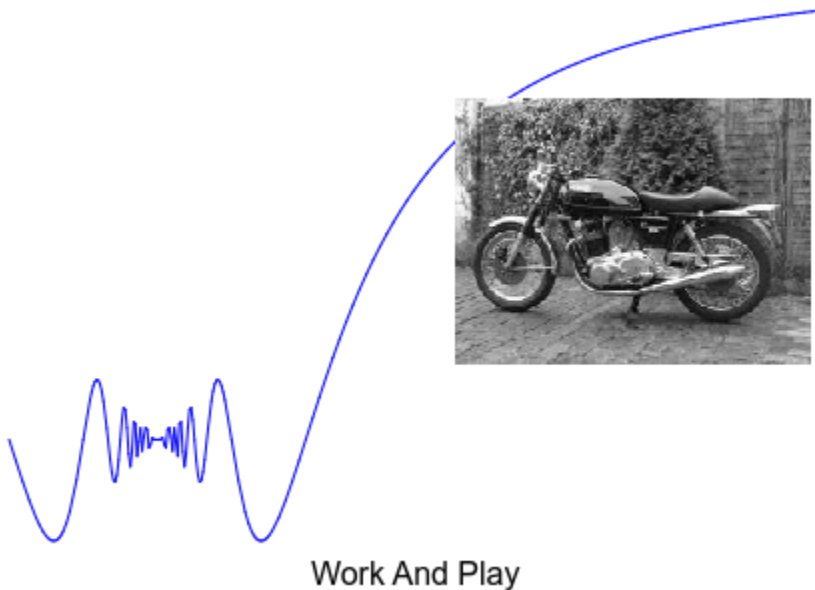

## Parameters

**filename**

The file name: a non-empty character string on page 7-53

## Options

### ReturnType

Option, specified as `ReturnType = DOM_HFARRAY | DOM_ARRAY | DOM_LIST`

Set the type of the actual color data returned as `colordata`.

If set to `DOM_LIST`, `colordata` is a nested list, the outermost list containing `h` lists, each of which represents one row of image data and contains `w` lists of three floating-point numbers, each of which represents an “RGB Colors” (Symbolic Math Toolbox) color.

If set to `DOM_ARRAY`, `colordata` is an array containing lists with color information, as in `array(2, 1..h, 1..w, [color1, color2, ...] )`. The interpretation is analogous to the nested lists described above.

If set to `DOM_HFARRAY`, which is the default setting, `colordata` is a `DOM_HFARRAY` of dimensions `hfarray(3, 1..h, 1..w, 1..3, [actual data])`. The interpretation of these floating-point values is as described above for the `DOM_LIST` case.

## Return Values

list on page 7-41 [`w`, `h`, `colordata`]. The integer `w` is the pixel width of the bitmap. The integer `h` is the pixel height of the bitmap. `colordata` provides the RGB colors of the bitmap. Its type depends on the setting of the option `ReturnType`.

## See Also

### MuPAD Functions

`READPATH` | `import::readdata` | `readbytes`

### MuPAD Graphical Primitives

`plot::Raster`



# import::readdata

Read data from an ASCII file

## Syntax

```
import::readdata(filename | n, <separator>, <NonNested>)
```

## Description

`import::readdata(filename)` reads the data in the file `filename`. File data separated by whitespace are regarded as different data elements. The result is a list of lists, each sublist representing one line of the file.

`import::readdata(filename, separator)` reads the data in the file `filename`. File data separated by the character `separator` are regarded as different data elements. The result is a list of lists, each sublist representing one line of the file.

`import::readdata(filename, separator, NonNested)` reads the data in the file `filename` as a single data record. File data separated by the character `separator` are regarded as different data elements. The result is a plain non-nested list containing the data of all lines of the file.

`import::readdata(filename)` searches for the file in various directories:

- First, the name is interpreted as a relative file name: `filename` is concatenated to each directory given by the environment variable `READPATH`.
- Then the file name is interpreted as an absolute path name.
- Then the file name is interpreted relative to the “working directory.”
- Last, the file name is concatenated to the library directory.

If a file can be opened with one of this names, then the file is read.

Note that the meaning of “working directory” depends on the operating system. On Microsoft Windows systems and on Apple Mac OS X systems, the “working directory” is the folder where MuPAD is installed. On UNIX systems, it is the current working directory

in which MuPAD was started; when started from a menu or desktop item, this is typically the user's home directory.

A path separator ("/") is inserted as necessary when concatenating a given path and filename.

If a file is specified by a file name, there is no need to open or close the file via `fopen` and `fclose`, respectively. This is done automatically by `import::readdata`.

Instead of a file name, also a file descriptor of a file opened via `fopen` can be used. Note that the file must have been opened in Read mode by `fopen`. If a file descriptor is used, the corresponding file is not closed automatically but must be closed by the user via `fclose`.

Files compressed by `gzip` or a compatible program (having a name ending in ".gz") are decompressed automatically upon reading.

All data elements in the file are interpreted as MuPAD objects. If a data element cannot be interpreted as a MuPAD object, it is imported as a MuPAD string on page 7-53. Otherwise, the corresponding MuPAD object is inserted into the list returned by `import::readdata`.

---

**Note** Note that the MuPAD objects corresponding to the data elements are evaluated after reading. E.g., the data element "sin(0)" in the file is evaluated and imported as the MuPAD integer 0. Beware: the characters ";" and ":" have a specific meaning if not specified as separators in `import::readdata`: they separate MuPAD commands. Hence, if a read data element contains one of this characters, MuPAD interprets this data element as a sequence of statements and, upon evaluation, returns the value of the *last* statement as the MuPAD object corresponding to the data element. Cf. "Example 3" on page 13-14 (Symbolic Math Toolbox).

---

In contrast to `finput`, the data elements in the file do not have to be ended by a colon or a semicolon.

Empty lines in the file are ignored.

## Examples

### Example 1

We wish to read statistical data into a MuPAD session to test the correlation of two data samples. Assume that the file "datafile" contains the following two columns of ASCII data (each column representing a data sample):

```
0.12    0.2534
2.324   5.72
1.02    2.2232
4.02    7.321
7.4     14.9
-7.4    -15.1
```

`import::readdata` returns the following list representing the data in the file:

```
data := import::readdata("datafile")
```

```
[[0.12, 0.2534], [2.324, 5.72], [1.02, 2.2232], [4.02, 7.321], [7.4, 14.9], [-7.4, -15.1]]
```

The data structure `stats::sample` converts this nested list into two data columns:

```
s := stats::sample(data)
```

```
0.12    0.2534
2.324   5.72
1.02    2.2232
4.02    7.321
7.4     14.9
-7.4    -15.1
```

The following computation shows that there is a very strong correlation on page 30-75 between the data in the first column and the data in the second column:

```
stats::correlation(s, 1, 2)
```

```
0.9982703003
```

If the data in the file are supposed to represent a single sample (data record), we may ignore the fact that the numbers are arranged on several lines. With `NonNested`, the data are read as a single sample:

```
data := import::readdata("datafile", NonNested)

[0.12, 0.2534, 2.324, 5.72, 1.02, 2.2232, 4.02, 7.321, 7.4, 14.9, -7.4, -15.1]
```

Mean and standard deviation of the data are:

```
stats::mean(data), stats::stdev(data)

1.900133333, 7.568789783
```

```
delete data, s:
```

## Example 2

Let us assume that the file “datafile” contains the following ASCII data:

```
1 | 2 | 3
4| 5 | 6.65786
7| 8 |9| 5 | "ahfjd" | ab100|-23
```

We specify the data separator “|” for reading the data:

```
import::readdata("datafile", "|")

[[[1, 2, 3], [4, 5, 6.65786], [7, 8, 9, 5, "ahfjd", ab100, -23]]]
```

Note that whitespace inside the data elements as well as the empty line in the file are ignored.

## Example 3

We first create the ASCII data files that will be used in this example. We recall that  $x$  degrees Celsius are  $\frac{9x}{5} + 32$  degrees Fahrenheit. First, two data files are created

containing the matching temperatures from - 5 degrees Celsius to 30 degrees Celsius in steps of 5 degrees Celsius:

```
n1 := fopen(Text, "data1", Write):
n2 := fopen(Text, "data2", Write):
for celsius from -5 to 20 step 5 do
  fahrenheit := 9/5*celsius + 32:
  fprintf(Unquoted, n1, celsius, " ", fahrenheit):
  fprintf(n2, celsius, fahrenheit):
end_for:
fclose(n1):
fclose(n2):
```

The file "data1" now contains the following data:

```
-5 23
0 32
5 41
10 50
15 59
20 68
```

The file "data2" contains the following data:

```
-5:23:
0:32:
5:41:
10:50:
15:59:
20:68:
```

Now, we import the data:

```
import::readdata("data1")
```

```
[[ -5, 23], [0, 32], [5, 41], [10, 50], [15, 59], [20, 68]]
```

Reading data from the file "data2" yields an unexpected result:

```
import::readdata("data2")
```

```
[[23], [32], [41], [50], [59], [68]]
```

What went wrong? Remember that the default data separator is whitespace. Consequently, MuPAD reads the expression `-5:23` as the only data element in the first line. When MuPAD evaluates this data element, it interprets it as a sequence of two MuPAD statements. The result of the statement sequence is the result of the last of the two statements, i.e., the number 23. This is the first datum in the resulting list. For getting the data as desired, an appropriate separator must be specified. The file "data2" should be read as follows:

```
import::readdata("data2", ":")
```

```
[[[-5, 23], [0, 32], [5, 41], [10, 50], [15, 59], [20, 68]]]
```

We use the option `NonNested` to get a plain list containing all data elements without putting each record (line) in a sublist of its own:

```
import::readdata("data2", ":", NonNested)
```

```
[-5, 23, 0, 32, 5, 41, 10, 50, 15, 59, 20, 68]
```

```
delete n1, n2:
```

## Example 4

Here we can see that the data are evaluated after reading. First, we create the data file:

```
n1 := fopen(Text, "data3", Write) :  
fprint(Unquoted, n1, a, " 12 ", b):  
fclose(n1):
```

Now, the data are read:

```
import::readdata("data3")
```

```
[[a, 12, b]]
```

If `a` and `b` have values, we get:

```
a := 3: b := 34: import::readdata("data3")
```

```
[[3, 12, 34]]
```

```
delete n1, a, b:
```

## Example 5

First, we create a data file with random floating-point data that is separated by blank characters:

```
n := fopen(Text, "data4", Write):
for i from 1 to 3 do
  fprintf(Unquoted, n, (frandom(), " ") $ j = 1..4);
end_for;
fclose(n):
```

This file is reopened for reading with `fopen`:

```
n := fopen(Text, "data4", Read)
```

```
64
```

The file descriptor `n` returned by `fopen` can be passed to `import::readdata`:

```
import::readdata(n)
```

```
[[0.2703567032, 0.8142678572, 0.1145977439, 0.247668289],
 [0.436855213, 0.7507294917, 0.5143284818, 0.47002619],
 [0.06956333824, 0.5063265159, 0.4145331467, 0.365909575]]
```

Note, however, that the file was opened explicitly by the user with `fopen` and is not closed automatically by `import::readdata`. Consequently, the user is supposed to close the file explicitly via `fclose`:

```
fclose(n):
delete i, n:
```

## Parameters

### filename

The file name: a non-empty character string on page 7-53

**n**

A file descriptor provided by `fopen`: a positive integer

**separator**

The separator between data elements: a character string on page 7-53 of length 1 (a single character). The default separator is whitespace.

## Options

**NonNested**

Return all file data as a single data record in a non-nested list. The data of all lines are ordered sequentially in this list.

## Return Values

Nested list on page 7-41 of lists. The sublists contain the data of the individual lines. With the option `NonNested`, a plain list containing all data elements from every line in the file.

## See Also

**MuPAD Functions**

`finput` | `fopen` | `fread` | `ftextinput` | `import::csv` | `import::readbitmap` | `pathname` | `read`



# import::readlisp

Parse Lisp-formatted string

## Syntax

```
import::readlisp(s)
```

## Description

`import::readlisp(s)` parses the Lisp-formatted string `s` and returns the corresponding MuPAD expression.

`import::readlisp` returns the constructed MuPAD expression as an unevaluated call. So the result of `import::readlisp` is in every case of type `DOM_EXPR`.

If the parsed string `s` contains only white spaces, then the unevaluated `null()` expression is returned.

## Examples

### Example 1

A first example:

```
import::readlisp("(INTEGRATE (EXPT X -1) X)")
```

$$\int \frac{1}{X} dX$$

```
import::readlisp("(EXP 2.0)")
```

$$e^{2.0}$$

## Example 2

In "Example 1" on page 13-19 (Symbolic Math Toolbox) above we can see that the corresponding MuPAD expression is not evaluated. Let us have a closer look at this behavior:

```
domtype(import::readlisp("(INTEGRATE (EXPT X -1) X)")),  
eval(import::readlisp("(INTEGRATE (EXPT X -1) X)")),  
domtype(import::readlisp("(EXP 2.0)")),  
eval(import::readlisp("(EXP 2.0)"))
```

```
DOM_EXPR, ln(X), DOM_EXPR, 7.389056099
```

## Example 3

Another example demonstrating that `import::readlisp` returns an unevaluated call:

```
x := 2: import::readlisp>(* x (/ 2 y))
```

```
 $x \frac{2}{y}$ 
```

```
eval(import::readlisp>(* x (/ 2 y)))
```

```
 $\frac{4}{y}$ 
```

## Example 4

An empty string is converted into an unevaluated call of `null()`:

```
type(import::readlisp(""))
```

```
"null"
```

We try to convert an illegal Lisp string:

```
import::readlisp>(* 2(EXP 3))
```

Error: Missing closing parenthesis. [import::parseLambda]

## Parameters

**s**

A string

## Return Values

MuPAD expression of type DOM\_EXPR



# intlib - Integration Utilities

---

## intlib::byparts

Integration by parts

### Syntax

```
intlib::byparts(integral, du)
```

### Description

`intlib::byparts(integral, du)` performs on `integral` the integration by parts, where `du` is the part to be integrated and returns an expression containing the unevaluated partial integral.

Mathematically, the rule of integration by parts is formally defined for indefinite integrals as

$$\int u'(x) v(x) dx = u(x) v(x) - \int u(x) v'(x) dx$$

and for definite integrals as

$$\int_a^b u'(x) v(x) dx = u(b) v(b) - u(a) v(a) - \int_a^b u(x) v'(x) dx$$

`intlib::byparts` works for indefinite as well as for definite integrals.

If MuPAD cannot solve the integral for `du` in case of definite integration, the function call is returned unevaluated.

The first argument should contain a symbolic integral of type "int". Such an expression can be obtained with `hold` or `freeze` (cf. "Example 1" on page 14-3 (Symbolic Math Toolbox)).

The second argument `du` should typically be a partial expression of the integrand in integral.

## Examples

### Example 1

As a first example we apply the rule of integration by parts to the integral  $\int_a^b x e^x dx$ . By using the function `hold` we ensure that the first argument is of type "int":

```
intlib::byparts(hold(int)(x*exp(x), x = a..b), exp(x))
```

$$b e^b - a e^a - \int_a^b e^x dx$$

In this case the ansatz is chosen as  $u'(x) = e^x$  and thus  $v(x) = x$ .

### Example 2

In the following we give a more advanced example using the method of integration by parts for solving the integral  $\int e^{ax} \sin(bx) dx$ . For this we have to prevent that the integrator already evaluates the integrals. Thus we first inactivate the requested integral with the function `freeze`

```
F := freeze(int)(exp(a*x)*sin(b*x), x)
```

$$\int e^{ax} \sin(bx) dx$$

and apply afterwards partial integration with  $u'(x) = e^{ax}$ :

```
F1 := intlib::byparts(F, exp(a*x))
```

$$\frac{e^{ax} \sin(bx)}{a} - \int \frac{b e^{ax} \cos(bx)}{a} dx$$

This result contains another symbolic integral, which MuPAD can solve directly:

```
eval(F1)
```

$$\frac{e^{ax} \sin(bx)}{a} - \frac{b e^{ax} (a \cos(bx) + b \sin(bx))}{a (a^2 + b^2)}$$

### Example 3

Here we demonstrate the difference between indefinite and definite integration by parts. If in the indefinite case the partial part cannot be solved, simply the unevaluated integral is plugged into the integration rule:

```
intlib::byparts(hold(int)(x*f(x), x), f(x))
```

$$x \int f(x) dx - \int \int f(x) dx dx$$

This is no longer true for the definite case:

```
intlib::printWarnings(TRUE):  
intlib::byparts(hold(int)(x*f(x), x=a..b), f(x))
```

```
Warning: Unable to find closed form for 'int(f(x), x)'. [intlib::byparts]
```

$$\text{intlib::byparts} \left( \int_a^b x f(x) dx, f(x) \right)$$



## Parameters

### **integral**

Integral: an arithmetical expression (Symbolic Math Toolbox) containing a symbolic "int" call of the form `int(du*v, x)` or `int(du*v, x = a..b)`

### **du**

The part to be integrated: an arithmetical expression

## Return Values

Arithmetical expression.

## See Also

### **MuPAD Functions**

`intlib::changevar` | `subs`

## intlib::changevar

Change of variable

### Syntax

```
intlib::changevar(integral, eq, <var>)
```

### Description

`intlib::changevar(integral, eq)` performs a change of variable for indefinite and definite integrals.

Mathematically, the substitution rule is formally defined for indefinite integrals as

$$\int f(g(x)) g'(x) dx = \left( \left( \int f(t) dt \right) \Big|_{t=g(x)} \right)$$

and for definite integrals as

$$\int_a^b f(g(x)) g'(x) dx = \int_{g(a)}^{g(b)} f(t) dt$$

`intlib::changevar(integral, eq)` performs in `integral` the change of variable defined by `eq` and returns an unevaluated new integral. You can use the `eval` command to find the closed form of this new integral providing that the closed form exists.

`intlib::changevar` works for indefinite as well as for definite integrals.

The first argument should contain a symbolic integral of type "int". Such an expression can be obtained with `hold` or `freeze`. See "Example 1" on page 14-7 (Symbolic Math Toolbox).

If more than two variables occur in `eq`, the new variable must be given as third argument.

If MuPAD cannot solve the given equation eq an error will occur.

## Examples

### Example 1

As a first example we perform a change of variable for the integral  $\int_a^b f(x+c) dx$ . By using the hold function we ensure that the first argument is of type "int":

```
intlib::changevar(hold(int)(f(x + c), x = a..b),
                  t = x + c, t)
```

$$\int_{a+c}^{b+c} f(t) dt$$

Note that in this case the substitution equation has two further variables besides x. Thus it is necessary to specify the new integration variable as third argument.

### Example 2

In the following example we use the change of variable method for solving the integral  $\int \cos(\ln(x)) dx$ . First we perform the transformation  $t = \ln(x)$ :

```
f1 := intlib::changevar(hold(int)(cos(ln(x)), x),
                       t = ln(x), t)
```

$$\int e^t \cos(t) dt$$

Now we can evaluate the integral with the MuPAD integrator:

```
f2:=eval(f1)
```

$$\frac{e^t (\cos(t) + \sin(t))}{2}$$

Finally we change the variable  $t$  back to  $x$  and get the result:

```
F := simplify(f2 | t = ln(x))
```

$$\frac{\sqrt{2} x \sin\left(\frac{\pi}{4} + \ln(x)\right)}{2}$$

We can also verify the solution of the integral:

```
simplify(diff(F,x) - cos(ln(x)))
```

0

## Parameters

### **integral**

The integral: an arithmetical expression (Symbolic Math Toolbox) containing a symbolic "int" call

### **eq**

Equation defining the new integration variable in terms of the old one: an equation

### **var**

The new integration variable: an identifier

## Return Values

Arithmetical expression.

## See Also

### **MuPAD Functions**

intlib::byparts | subs

# intlib::intOverSet

Integration over a set

## Syntax

```
intlib::intOverSet(f, x, S)
```

## Description

`intlib::intOverSet(f, x, S)` computes the integral  $\int_{-\infty}^{\infty} f(x) i_S(x) dx$  where  $i_S(x)$  is the indicator function of the set  $S$ .

If  $S$  is an interval  $(a, b)$  with  $a \leq b$ , the call is equivalent to `int(f, x=a..b)`. However, by definition, interchanging the borders to `int(f, x=b..a)` just reverses the sign of the latter while  $(b, a)$  is empty and any integral over the empty set is zero.

The function may return unevaluated if the integral could not be computed.

## Examples

### Example 1

For intervals, calling `intlib::intOverSet` is just equivalent to calling definite integration:

```
int(1/x, x=1..2), intlib::intOverSet(1/x, x, Dom::Interval(1, 2))
```

$\ln(2), \ln(2)$

If the lower border is greater than the upper, this does not hold anymore:

```
int(1/x, x=2..1), intlib::intOverSet(1/x, x, Dom::Interval(2, 1))
```

$-\ln(2), 0$

## Example 2

In more complex cases, the function returns unevaluated:

```
intlib::intOverSet(1/x^2, x, solve(t > sin(t), t))
```

$$\int_{x \in \text{solve}(\sin(t) < t, t)} \frac{1}{x^2} dx$$

## Parameters

**f**

Arithmetical expression

**x**

Identifier

**S**

Set-theoretic expression

## Return Values

Arithmetical expression.

## See Also

**MuPAD Functions**

int

# intlib::printWarnings

Enable or disable warnings

## Syntax

```
intlib::printWarnings(TRUE)
```

```
intlib::printWarnings(FALSE)
```

```
intlib::printWarnings()
```

## Description

`intlib::printWarnings` lets you enable or disable warnings.

By default, MuPAD does not display warnings during integration. To enable warnings, use the `intlib::printWarnings(TRUE)` function call. If later you want to disable warnings, use the `intlib::printWarnings(FALSE)` function call. See “Example 1” on page 14-11 (Symbolic Math Toolbox).

The `intlib::printWarnings()` function call shows whether warnings are enabled or disabled. See “Example 1” on page 14-11 (Symbolic Math Toolbox).

The output of `intlib::printWarnings` displays the previous setting. You can save this previous setting and switch to a new setting in a single function call. See “Example 2” on page 14-12 (Symbolic Math Toolbox).

## Examples

### Example 1

Enable the warnings by setting the value of `intlib::printWarnings` to `TRUE`:

```
intlib::printWarnings(TRUE):
```

Compute the integral of  $|x|$  under the assumption that  $x$  is an integer. MuPAD cannot integrate the expression over a discrete subset of the real numbers. The system issues a warning and integrates over the set  $\mathbb{R}$  of real numbers:

```
int(abs(x), x) assuming x in Z_
```

Warning: Unable to integrate when 'x' has property 'Z\_'. Using assumption 'x' has prop

$$\frac{x^2 \operatorname{sign}(x)}{2}$$

If you evaluate the same integral again, MuPAD does not recalculate the integral. The system remembers the previous result and returns it, skipping the warning:

```
int(abs(x), x) assuming x in Z_
```

$$\frac{x^2 \operatorname{sign}(x)}{2}$$

To check whether the warnings are enabled or disabled, use the `intlib::printWarnings()` function call:

```
intlib::printWarnings()
```

TRUE

Disable the warnings for further computations:

```
intlib::printWarnings(FALSE):
```

## Example 2

Enable the warnings and save the previous setting in a single function call:

```
old := intlib::printWarnings(TRUE):
```

Assume that  $x$  is positive. Then, integrate  $x$  over the interval  $[-2, 1]$ . In this case, the system issues a warning, temporarily disregards the assumption  $x > 0$ , and integrates over the interval  $[-2, 1]$ :



```
assume(x > 0):  
int(x, x = -2..1)
```

Warning: Using assumption 'x' has property 'Dom::Interval([-2], [1])' for integration :

$$-\frac{3}{2}$$

Restore the setting of intlib::printWarnings:

```
intlib::printWarnings(old):
```

The warnings are disabled now:

```
intlib::printWarnings()
```

**FALSE**

For further computations, clear the assumption on the variable x:

```
unassume(x):
```

## Return Values

Previously set value TRUE or FALSE

## See Also

### MuPAD Functions

int

## Topics

“Integration” (Symbolic Math Toolbox)



# **linalg - Linear Algebra**

---

## `linalg::addCol`

Linear combination of matrix columns

### Syntax

```
linalg::addCol(A, c1, c2, s1)
```

```
linalg::addCol(A, c1, c2, s1, s2)
```

### Description

`linalg::addCol(A, c1, c2, s1)` adds  $s_1$  times column  $c_1$  to column  $c_2$ , in the matrix  $A$ .

`linalg::addCol(A, c1, c2, s)` returns a copy of the matrix  $A$  in which column  $c_2$  of  $A$  is replaced by  $s \operatorname{col}(A, c_1) + \operatorname{col}(A, c_2)$ .

`linalg::addCol(A, c1, c2, s1, s2)` returns a copy of the matrix  $A$  in which column  $c_2$  of  $A$  is replaced by  $s_1 \operatorname{col}(A, c_1) + s_2 \operatorname{col}(A, c_2)$ .

### Examples

#### Example 1

The following defines a  $3 \times 3$  matrix over the integers:

```
A := Dom::Matrix(Dom::Integer)(  
  [[1, 2, 3], [4, 5, 6], [7, 8, 9]]  
)
```

$$\begin{pmatrix} 1 & 2 & 3 \\ 4 & 5 & 6 \\ 7 & 8 & 9 \end{pmatrix}$$

We replace the 2nd column by  $- \text{col}(A, 1) + \text{col}(A, 2)$ , i.e., we subtract the first column from the second:

```
linalg::addCol(A, 1, 2, -1)
```

$$\begin{pmatrix} 1 & 1 & 3 \\ 4 & 1 & 6 \\ 7 & 1 & 9 \end{pmatrix}$$

## Example 2

The following defines a  $2 \times 3$  matrix over the reals:

```
B := Dom::Matrix(Dom::Real)(
  [[sin(2), 0, 1], [1, PI, 0]]
)
```

$$\begin{pmatrix} \sin(2) & 0 & 1 \\ 1 & \pi & 0 \end{pmatrix}$$

If  $s$  is an expression that does not represent a real number then an error message is reported. The following tries to replace the 1st column by  $x \text{col}(B, 3) + \text{col}(B, 1)$ , where  $x$  is an identifier which cannot be converted to the component ring  $\text{Dom}::\text{Real}$  of  $B$ :

```
delete x: linalg::addCol(B, 3, 1, x)
```

```
Error: Unable to convert 'x'. [linalg::addCol]
```

## Example 3

If symbolic expressions are involved, then one may define matrices over a component ring created by  $\text{Dom}::\text{ExpressionField}$ . The following example defines a matrix over this default component ring:

```
delete a11, a12, a21, a22, x:
C := matrix([[a11, a12], [a21, a22]])
```

$$\begin{pmatrix} a11 & a12 \\ a21 & a22 \end{pmatrix}$$

We retry the input from the previous example:

```
linalg::addCol(C, 2, 1, x)
```

$$\begin{pmatrix} a_{11} + a_{12} x & a_{12} \\ a_{21} + a_{22} x & a_{22} \end{pmatrix}$$

## Parameters

**A**

An  $m \times n$  matrix of a domain of category `Cat::Matrix`

**c<sub>1</sub>, c<sub>2</sub>**

The column indices: positive integers less or equal to  $n$

**s<sub>1</sub>, s<sub>2</sub>**

Expressions that can be converted to the component ring of A

## Return Values

Matrix of the same domain type as A.

## See Also

### MuPAD Domains

`Dom::Matrix`

### MuPAD Functions

`linalg::addRow` | `linalg::col` | `linalg::multCol` | `linalg::multRow`

# linalg::addRow

Linear combination of matrix rows

## Syntax

```
linalg::addRow(A, r1, r2, s)
```

```
linalg::addRow(A, r1, r2, s1, s2)
```

## Description

`linalg::addRow(A, r1, r2, s1)` adds  $s_1$  times row  $r_1$  to row  $r_2$ , in the matrix  $A$ .

`linalg::addRow(A, r1, r2, s)` returns a copy of the matrix  $A$  in which row  $r_2$  of  $A$  is replaced by  $s \text{row}(A, r_1) + \text{row}(A, r_2)$ .

`linalg::addRow(A, r1, r2, s1, s2)` returns a copy of the matrix  $A$  in which row  $r_2$  of  $A$  is replaced by  $s_1 \text{row}(A, r_1) + s_2 \text{row}(A, r_2)$ .

## Examples

### Example 1

The following defines a  $3 \times 3$  matrix over the integers:

```
A := Dom::Matrix(Dom::Integer)(
  [[1, 2, 3], [4, 5, 6], [7, 8, 9]]
)
```

$$\begin{pmatrix} 1 & 2 & 3 \\ 4 & 5 & 6 \\ 7 & 8 & 9 \end{pmatrix}$$

We replace the 2nd row by  $-\text{row}(A, 1) + \text{row}(A, 2)$ , i.e., we subtract the first row from the second:

```
linalg::addRow(A, 1, 2, -1)
```

$$\begin{pmatrix} 1 & 2 & 3 \\ 3 & 3 & 3 \\ 7 & 8 & 9 \end{pmatrix}$$

## Example 2

The following defines a 2×3 matrix over the reals:

```
B := Dom::Matrix(Dom::Real)(  
  [[sin(2), 0, 1], [1, PI, 0]]  
)
```

$$\begin{pmatrix} \sin(2) & 0 & 1 \\ 1 & \pi & 0 \end{pmatrix}$$

If  $s$  is an expression that does not represent a real number then an error message is reported. The following tries to replace the 1st row by  $x \text{ row}(B, 2) + \text{row}(B, 1)$ , where  $x$  is an identifier which cannot be converted to the component ring `Dom::Real` of  $B$ :

```
delete x: linalg::addRow(B, 2, 1, x)
```

```
Error: Unable to convert 'x'. [linalg::addRow]
```

## Example 3

If symbolic expressions are involved, then one may define matrices over the component ring created by `Dom::ExpressionField`. The following example defines a matrix over this default component ring:

```
delete a11, a12, a21, a22, x:  
C := matrix([[a11, a12], [a21, a22]])
```

$$\begin{pmatrix} a11 & a12 \\ a21 & a22 \end{pmatrix}$$

We retry the input from the previous example:



```
linalg::addRow(C, 2, 1, x)
```

$$\begin{pmatrix} a_{11} + a_{21} x & a_{12} + a_{22} x \\ a_{21} & a_{22} \end{pmatrix}$$

## Parameters

**A**

An  $m \times n$  matrix of a domain of category `Cat::Matrix`

**r<sub>1</sub>, r<sub>2</sub>**

The row indices: positive integers less or equal to  $m$

**s, s<sub>1</sub>, s<sub>2</sub>**

Expressions that can be converted to the component ring of A

## Return Values

Matrix of the same domain type as A.

## See Also

### MuPAD Functions

`linalg::addCol` | `linalg::multCol` | `linalg::multRow` | `linalg::row`

# linalg::adjoint

Adjoint of a matrix

## Syntax

```
linalg::adjoint(A)
```

## Description

`linalg::adjoint(A)` computes the adjoint  $Adj(A)$  of the  $n \times n$  matrix  $A$ . The adjoint matrix satisfies the equation  $A Adj(A) = \det A I_n$ , where  $I_n$  is the  $n \times n$  identity matrix. The component ring of  $A$  must be of category `Cat::CommutativeRing`.

## Examples

### Example 1

We define a matrix over the rationals:

```
MatQ := Dom::Matrix(Dom::Rational):  
A := MatQ([[0, 2, 1], [2, 1, 0], [1, 0, 2]])
```

$$\begin{pmatrix} 0 & 2 & 1 \\ 2 & 1 & 0 \\ 1 & 0 & 2 \end{pmatrix}$$

Then the adjoint matrix of  $A$  is given by:

```
Ad := linalg::adjoint(A)
```

$$\begin{pmatrix} 2 & -4 & -1 \\ -4 & -1 & 2 \\ -1 & 2 & -4 \end{pmatrix}$$

We check the property of the adjoint matrix  $\text{Ad}$  mentioned above:

$$A * \text{Ad} = \det(A) * \text{MatQ}::\text{identity}(3)$$

$$\begin{pmatrix} -9 & 0 & 0 \\ 0 & -9 & 0 \\ 0 & 0 & -9 \end{pmatrix} = \begin{pmatrix} -9 & 0 & 0 \\ 0 & -9 & 0 \\ 0 & 0 & -9 \end{pmatrix}$$

## Parameters

**A**

A square matrix of a domain of category `Cat::Matrix`

## Return Values

Matrix of the same domain type as  $A$ .

## Algorithms

The adjoint of a square matrix  $A$  is the matrix whose  $(i, j)$ -th entry is the  $(j, i)$ -th cofactor of  $A$ .

The  $(j, i)$ -th *cofactor* of  $A$  is defined by  $a'_{ji} = (-1)^{i+j} \det(A_{ji})$ , where  $A_{ji}$  is the submatrix of  $A$  obtained from  $A$  by deleting the  $i$ -th row and  $j$ -th column.

## See Also

### MuPAD Functions

`det`

## `linalg::angle`

Angle between two vectors

### Syntax

```
linalg::angle(u, v)
```

### Description

`linalg::angle(u, v)` computes the angle  $\varphi$  between the two vectors  $u$  and  $v$ , defined by

$$\varphi = \arccos\left(\frac{\langle \vec{u}, \vec{v} \rangle}{\|\vec{u}\|_2 \|\vec{v}\|_2}\right),$$

where  $\langle \vec{u}, \vec{v} \rangle$  denotes the scalar product of two vectors given by

`linalg::scalarProduct`, and  $\|\cdot\|_2$  the 2-norm of a vector, i.e.,  $\|\vec{u}\|_2 = \sqrt{\langle \vec{u}, \vec{u} \rangle}$ .

`linalg::angle` does not check if the computation is defined in the corresponding component ring. This can lead to an error message, as shown in “Example 2” on page 15-12 (Symbolic Math Toolbox).

The following relationship between the angle between  $\vec{u}$  and  $\vec{v}$  and the angle between  $\vec{u}$  and  $-\vec{v}$  holds:  $\varphi(\vec{u}, -\vec{v}) = \pi - \varphi(\vec{u}, \vec{v})$ .

An error message is returned if the vectors are not defined over the same component ring.

## Examples

### Example 1

We compute the angle between the two vectors  $\begin{pmatrix} 2 \\ 5 \end{pmatrix}$  and  $\begin{pmatrix} -3 \\ 3 \end{pmatrix}$ :

```
phi := linalg::angle(
  matrix([2, 5]), matrix([-3, 3])
)
```

$$\arccos\left(\frac{\sqrt{18}\sqrt{29}}{58}\right)$$

We use the function `float` to get a floating-point approximation of this number:

```
float(phi)
```

1.165904541

We give two further examples:

```
linalg::angle(
  matrix([1, -1]), matrix([1, 1])
)
```

$$\frac{\pi}{2}$$

```
linalg::angle(
  matrix([1, 1]), matrix([-1, -1])
)
```

$\pi$

## Example 2

`linalg::angle` does not check whether the term  $\frac{\langle \vec{u}, \vec{v} \rangle}{\|\vec{u}\|_2 \|\vec{v}\|_2}$  is defined in the corresponding component ring.

As an example, we try to compute the angle between two vectors with components in  $\mathbb{Z}_7$ :

```
MatZ7 := Dom::Matrix(Dom::IntegerMod(7))
```

```
Dom::Matrix(Dom::IntegerMod(7))
```

The following call leads to an error because the 2-norm cannot be computed:

```
linalg::angle(MatZ7([1, 1]), MatZ7([-1, -1]))
```

```
Error: Integer exponent expected. [(Dom::IntegerMod(7))::_power]
```

Note that the domain `Dom::IntegerMod(7)` does not implement the square root of an element, therefore in MuPAD you cannot compute the angle of any two vectors over  $\mathbb{Z}_7$ .

## Parameters

**u, v**

Vectors of the same dimension; a vector is a  $n \times 1$  or  $1 \times n$  matrix of a domain of category `Cat::Matrix`

## Return Values

Arithmetical expression.

## See Also

### MuPAD Functions

`arccos` | `linalg::scalarProduct` | `linalg::vecdim`

# `linalg::basis`

Basis for a vector space

## Syntax

`linalg::basis(S)`

## Description

`linalg::basis(S)` returns a basis for the vector space spanned by the vectors in the set or list  $S$ .

`linalg::basis(S)` removes those vectors in  $S$  that are linearly dependent on other vectors in  $S$ . The result is a basis for the vector space spanned by the vectors in  $S$ .

For an ordered basis of vectors,  $S$  should be a list of vectors.

The vectors in  $S$  must be defined over the same component ring.

The component ring of the vectors in  $S$  must be a field, i.e., it must be of category `Cat::Field`.

## Examples

### Example 1

We define the domain of matrices over  $\mathbb{Q}$ :

```
MatQ := Dom::Matrix(Dom::Rational):
```

and compute a basis for the vector space spanned by the vectors  $\begin{pmatrix} 3 \\ -2 \end{pmatrix}$ ,  $\begin{pmatrix} 1 \\ 0 \end{pmatrix}$  and

$\begin{pmatrix} 5 \\ -3 \end{pmatrix}$ :



```
v1 := MatQ([3, -2]):
v2 := MatQ([1, 0]):
v3 := MatQ([5, -3]):
linalg::basis([v1, v2, v3])
```

$$\left[ \begin{pmatrix} 3 \\ -2 \end{pmatrix}, \begin{pmatrix} 1 \\ 0 \end{pmatrix} \right]$$

If not a list but a set of vectors is given, then the basis returned may not consist of the same vectors as above. The order of the vectors in the set depends on the internal order (see `sysorder` and `DOM_SET`), i.e., the order of the vectors appears to be random:

```
b := linalg::basis({v1, v2, v3}):
op(b, 1)
```

$$\begin{pmatrix} 3 \\ -2 \end{pmatrix}$$

## Parameters

**s**

A set or list of  $n$ -dimensional vectors; a vector is a  $n \times 1$  or  $1 \times n$  matrix of a domain of category `Cat::Matrix`

## Return Values

Set or a list of vectors, respectively.

## See Also

### MuPAD Functions

`linalg::intBasis` | `linalg::sumBasis` | `lllint`

# `linalg::charmat`

Characteristic matrix

## Syntax

```
linalg::charmat(A, x)
```

## Description

`linalg::charmat(A, x)` returns the characteristic matrix  $xI_n - A$  of the  $n \times n$  matrix  $A$ , where  $I_n$  denotes the  $n \times n$  identity matrix.

The component ring of  $A$  must be a commutative ring, i.e., a domain of category `Cat::CommutativeRing`.

The characteristic matrix  $M = xI_n - A$  of  $A$  can be evaluated at a point  $x = u$  via `evalp(M, x = u)`. See “Example 2” on page 15-17 (Symbolic Math Toolbox).

## Examples

### Example 1

We define a matrix over the rational numbers:

```
A := Dom::Matrix(Dom::Rational)([[1, 2], [3, 4]])
```

$$\begin{pmatrix} 1 & 2 \\ 3 & 4 \end{pmatrix}$$

and compute the characteristic matrix of  $A$  in the variable  $x$ :

```
MA := linalg::charmat(A, x)
```

$$\begin{pmatrix} x-1 & -2 \\ -3 & x-4 \end{pmatrix}$$

The determinant of the matrix  $MA$  is a polynomial in  $x$ , the characteristic polynomial of the matrix  $A$ :

```
pA := det(MA)
```

$$x^2 - 5x - 2$$

```
domtype(pA)
```

```
Dom::DistributedPolynomial([x], Dom::Rational, LexOrder)
```

Of course, we can compute the characteristic polynomial of  $A$  directly via `linalg::charpoly`:

```
linalg::charpoly(A, x)
```

$$x^2 - 5x - 2$$

The result is of the same domain type as the polynomial  $pA$ .

## Example 2

We define a matrix over the complex numbers:

```
B := Dom::Matrix(Dom::Complex)([[1 + I, 1], [1, 1 - I]])
```

$$\begin{pmatrix} 1+i & 1 \\ 1 & 1-i \end{pmatrix}$$

The characteristic matrix of  $B$  in the variable  $z$  is:

```
MB := linalg::charmat(B, z)
```

$$\begin{pmatrix} z-1-i & -1 \\ -1 & z-1+i \end{pmatrix}$$

We evaluate MB at  $z = i$  and get the matrix:

```
evalp(MB, z = I)
```

$$\begin{pmatrix} -1 & -1 \\ -1 & -1+2i \end{pmatrix}$$

Note that this is a matrix of the domain type `Dom::Matrix(Dom::Complex)`:

```
domtype(%)
```

```
Dom::Matrix(Dom::Complex)
```

## Parameters

**A**

A square matrix of a domain of category `Cat::Matrix`

**x**

An identifier on page 7-29

## Return Values

Matrix of the domain `Dom::Matrix(Dom::DistributedPolynomial([x], R))` or of `Dom::DenseMatrix(Dom::DistributedPolynomial([x], R))`, where `R` is the component ring of `A`.

## See Also

### **MuPAD Functions**

`linalg::charpoly`

## `linalg::charpoly`

Characteristic polynomial of a matrix

### Syntax

```
linalg::charpoly(A, x)
```

### Description

`linalg::charpoly(A, x)` computes the characteristic polynomial of the matrix  $A$ . The characteristic polynomial of a  $n \times n$  matrix is defined by  $p_A(x) := \det(xI_n - A)$ , where  $I_n$  denotes the  $n \times n$  identity matrix.

The component ring of  $A$  must be a commutative ring, i.e., a domain of category `Cat::CommutativeRing`.

### Examples

#### Example 1

We define a matrix over the rational numbers:

```
A := Dom::Matrix(Dom::Rational)([[1, 2], [3, 4]])
```

$$\begin{pmatrix} 1 & 2 \\ 3 & 4 \end{pmatrix}$$

Then the characteristic polynomial  $p_A(x)$  is given by:

```
linalg::charpoly(A, x)
```

$$x^2 - 5x - 2$$

It is of the domain type:

```
domtype(%)
```

```
Dom::DistributedPolynomial([x], Dom::Rational, LexOrder)
```

## Example 2

We define a matrix over  $\mathbb{Z}_7$ :

```
B := Dom::Matrix(Dom::IntegerMod(7))([[1, 2], [3, 0]])
```

$$\begin{pmatrix} 1 \bmod 7 & 2 \bmod 7 \\ 3 \bmod 7 & 0 \bmod 7 \end{pmatrix}$$

The characteristic polynomial  $p_B(x)$  of B is given by:

```
p := linalg::charpoly(B, x)
```

$$(1 \bmod 7) x^2 + (6 \bmod 7) x + (1 \bmod 7)$$

We compute the zeros of  $p_B(x)$ , i.e., the eigenvalues of the matrix B:

```
solve(p)
```

$$\{[x = 3 \bmod 7], [x = 5 \bmod 7]\}$$

## Parameters

**A**

A square matrix of a domain of category `Cat::Matrix`

**x**

An identifier on page 7-29

## Return Values

Polynomial of the domain `Dom::DistributedPolynomial([x],R)`, where `R` is the component ring of `A`.

## References

Reference: Jounaidi Abdeljaoued, *The Berkowitz Algorithm, Maple and Computing the Characteristic Polynomial in an Arbitrary Commutative Ring*, MapleTech Vol 4 No 3, pp 21-32, Birkhäuser, 1997.

## Algorithms

`linalg::charpoly` implements Hessenberg's algorithm to compute the characteristic polynomial of a square matrix `A`. See: Henri Cohen: *A Course in Computational Algebraic Number Theory*, GTM 138, Springer Verlag.

This algorithm works for any field and requires only  $O(n^3)$  field operations, in contrast to  $O(n^4)$  when computing the determinant of the characteristic matrix of `A`.

Since the size of the components of `A` in intermediate computations of Hessenberg's algorithm can swell extremely, it is only applied for matrices over `Dom::Float` and `Dom::IntegerMod`.

For any other component ring, the characteristic polynomial is computed using the Berkowitz algorithm.

## See Also

### MuPAD Functions

`det` | `linalg::charmat` | `linalg::hessenberg` | `linalg::minpoly`



# linalg::col

Extract columns of a matrix

## Syntax

```
linalg::col(A, c)
```

```
linalg::col(A, c1 .. c2)
```

```
linalg::col(A, list)
```

## Description

`linalg::col(A, c)` extracts the  $c$ -th column vector of the matrix  $A$ .

`linalg::col(A, c1 .. c2)` returns a list of column vectors whose indices are in the range  $c_1 .. c_2$ . If  $c_2 < c_1$  then the empty list `[]` is returned.

`linalg::col(A, list)` returns a list of column vectors whose indices are contained in `list` (in the same order).

## Examples

### Example 1

We define a matrix over  $\mathbb{Q}$ :

```
A := Dom::Matrix(Dom::Rational)(
  [[1, 1/5, 2], [-3/2, 0, 5]]
)
```

$$\begin{pmatrix} 1 & \frac{1}{5} & 2 \\ -\frac{3}{2} & 0 & 5 \end{pmatrix}$$

and illustrate the three different input formats for `linalg::col`:

```
linalg::col(A, 2)
```

$$\begin{pmatrix} \frac{1}{5} \\ 0 \end{pmatrix}$$

```
linalg::col(A, [2, 1, 3])
```

$$\left[ \begin{pmatrix} \frac{1}{5} \\ 0 \end{pmatrix}, \begin{pmatrix} 1 \\ -\frac{3}{2} \end{pmatrix}, \begin{pmatrix} 2 \\ 5 \end{pmatrix} \right]$$

```
linalg::col(A, 2..3)
```

$$\left[ \begin{pmatrix} \frac{1}{5} \\ 0 \end{pmatrix}, \begin{pmatrix} 2 \\ 5 \end{pmatrix} \right]$$

## Parameters

**A**

An  $m \times n$  matrix of a domain of category `Cat::Matrix`

**c**

The column index: a positive integer less or equal to  $n$

**c<sub>1</sub> .. c<sub>2</sub>**

A range of column indices (positive integers less or equal to  $n$ )

**list**

A list of column indices (positive integers less or equal to  $n$ )

## Return Values

Single column vector or a list of column vectors; a column vector is an  $m \times 1$  matrix of category `Cat::Matrix(R)`, where  $R$  is the component ring of  $A$ .

## See Also

### MuPAD Functions

`linalg::delCol` | `linalg::delRow` | `linalg::row` | `linalg::setCol` |  
`linalg::setRow`

## **linalg::companion**

Companion matrix of a univariate polynomial

### **Syntax**

```
linalg::companion(p, <x>)
```

### **Description**

`linalg::companion(p)` returns the companion matrix associated with the polynomial  $p$ .

$p$  must be monic and of degree one at least.

If  $p$  is a polynomial, i.e., an object of type `DOM_POLY`, then specifying  $x$  has no effect.

If  $p$  is a polynomial, then the component ring of the returned matrix is the coefficient ring of  $p$ , except in two cases for built-in coefficient rings: if the coefficient ring of  $p$  is `Expr` then the domain `Dom::ExpressionField()` is the component ring of the companion matrix. If it is `IntMod(m)` then the companion matrix is defined over the ring `Dom::IntegerMod(m)` (see “Example 2” on page 15-27 (Symbolic Math Toolbox)).

If  $p$  is a polynomial expression, then the companion matrix is defined over `Dom::ExpressionField()`.

If  $p$  is a polynomial expression containing several symbolic indeterminates then  $x$  must be specified and distinguishes the indeterminate  $x$  from the other symbolic parameters.

### **Examples**

#### **Example 1**

We start with the following polynomial expression:

```
delete a_0, a_1, a_2, a_3:
p := x^4 + a_3*x^3 + a_2*x^2 + a_1*x + a_0
```

$$x^4 + a_3 x^3 + a_2 x^2 + a_1 x + a_0$$

To compute the companion matrix of  $p$  with respect to  $x$  we must specify the second parameter  $x$ , because the expression  $p$  contains the indeterminates  $a_0, a_1, a_2, a_3$  and  $x$ :

```
linalg::companion(p)
```

Error: Variables in multivariate polynomials must be specified by the second argument.

```
linalg::companion(p, x)
```

$$\begin{pmatrix} 0 & 0 & 0 & -a_0 \\ 1 & 0 & 0 & -a_1 \\ 0 & 1 & 0 & -a_2 \\ 0 & 0 & 1 & -a_3 \end{pmatrix}$$

Of course, we can compute the companion matrix of  $p$  with respect to  $a_0$  as well.

```
linalg::companion(p, a_0)
```

$$(-x^4 - a_3 x^3 - a_2 x^2 - a_1 x)$$

The following fails with an error message, because the polynomial  $p$  is not monic with respect to  $a_1$ :

```
linalg::companion(p, a_1)
```

Error: Polynomial must be monic. [linalg::companion]

## Example 2

If we enter a polynomial over the built-in coefficient domain `Expr`, then the companion matrix is defined over the standard component ring for matrices (the domain `Dom::ExpressionField()`):

```
C := linalg::companion(poly(x^2 + 10*x + PI, [x]))
```

$$\begin{pmatrix} 0 & -\pi \\ 1 & -10 \end{pmatrix}$$

```
domtype(C)
```

```
Dom::Matrix()
```

If we define a polynomial over the build-in coefficient domain `IntMod(m)`, then the companion matrix is defined over the corresponding component ring `Dom::IntegerMod(m)`, as shown in the next example:

```
p := poly(x^2 + 10*x + 7, [x], IntMod(3))
```

$$\text{poly}(x^2 + x + 1, [x], \text{IntMod}(3))$$

```
C := linalg::companion(p)
```

$$\begin{pmatrix} 0 \bmod 3 & 2 \bmod 3 \\ 1 \bmod 3 & 2 \bmod 3 \end{pmatrix}$$

```
domtype(C)
```

```
Dom::Matrix(Dom::IntegerMod(3))
```

## Parameters

**p**

An univariate polynomial, or a polynomial expression

**x**

An identifier on page 7-29

## Return Values

Matrix of the domain `Dom::Matrix(R)`.

## Algorithms

The companion matrix of the polynomial  $x^n + a_{n-1}x^{n-1} + \dots + a_1x + a_0$  is the matrix:

$$C = \begin{pmatrix} 0 & \dots & 0 & -a_0 \\ 1 & & & -a_1 \\ & \dots & & \vdots \\ & & & \vdots \\ & & 0 & -a_{n-1} \\ & & 1 & -a_n \end{pmatrix}.$$

The companion matrix of a univariate polynomial  $p$  of degree  $n$  is an  $n \times n$  matrix  $C$  with  $p_C = p$ , where  $p_C$  is the characteristic polynomial of  $C$ .

## linalg::concatMatrix

Join matrices horizontally

### Syntax

```
linalg::concatMatrix(A, B1, <B2, ...>)
```

### Description

`linalg::concatMatrix(A, B1, B2, dots )` returns the matrix formed by joining the matrices  $A, B_1, B_2, \dots$  horizontally.

The matrices  $B_1, B_2, \dots$  are converted into the matrix domain  $\text{Dom}::\text{Matrix}(R)$ , where  $R$  is the component ring of  $A$ .

An error message is raised if one of these conversions fails, or if the matrices do not have the same number of rows as the matrix  $A$ .

A short form of `linalg::concatMatrix` is available through the dot operator `.`, i.e., instead of `linalg::concatMatrix(A, B)` one may use the short form  $A \cdot B$ .

### Examples

#### Example 1

We define the matrix:

```
A := matrix([[sin(x), x], [-x, cos(x)]])
```

$$\begin{pmatrix} \sin(x) & x \\ -x & \cos(x) \end{pmatrix}$$

and append the  $2 \times 2$  identity matrix to the right of  $A$ :



```
I2 := matrix::identity(2):
linalg::concatMatrix(A, I2)
```

$$\begin{pmatrix} \sin(x) & x & 1 & 0 \\ -x & \cos(x) & 0 & 1 \end{pmatrix}$$

The short form for this operation is:

```
A . I2
```

$$\begin{pmatrix} \sin(x) & x & 1 & 0 \\ -x & \cos(x) & 0 & 1 \end{pmatrix}$$

## Example 2

We define a matrix from the ring of 2×2 square matrices:

```
SqMatQ := Dom::SquareMatrix(2, Dom::Rational):
A := SqMatQ([[1, 2], [3, 4]])
```

$$\begin{pmatrix} 1 & 2 \\ 3 & 4 \end{pmatrix}$$

Note the following operation:

```
AA := A . A
```

$$\begin{pmatrix} 1 & 2 & 1 & 2 \\ 3 & 4 & 3 & 4 \end{pmatrix}$$

returns a matrix of a different domain type as the input matrix:

```
domtype(AA)
```

```
Dom::Matrix(Dom::Rational)
```

## Parameters

$A, B_1, B_2, \dots$

Matrices of a domain of category `Cat::Matrix`

## Return Values

Matrix of the domain type `Dom::Matrix(R)`, where  $R$  is the component ring of  $A$ .

## See Also

### MuPAD Functions

`linalg::stackMatrix`

# linalg::cond

Condition number of a matrix

## Syntax

```
linalg::cond(M, <1 | 2 | Spectral | Infinity | Frobenius>)
```

## Description

`linalg::cond(M)` computes the condition number of a matrix, defined by  $\|M\|_{\infty} \left\| \frac{1}{M} \right\|_{\infty}$ . By default the matrix norm Infinity is used by `linalg::cond`.

`linalg::cond(M)` is the short form of `linalg::cond(M, Infinity)`.

`linalg::cond(M, k)` computes the condition number of the matrix M, defined by

$$\|M\|_k \left\| \frac{1}{M} \right\|_k.$$

For further details see the help page of `norm`.

## Examples

### Example 1

We define the 3×3 matrix A.

```
A := matrix(3,3, [[1,0,3],[-4,2,0],[0,3,-2]])
```

$$\begin{pmatrix} 1 & 0 & 3 \\ -4 & 2 & 0 \\ 0 & 3 & -2 \end{pmatrix}$$

Now we calculate the condition number of A for some matrix norms.

```
linalg::cond(A)
```

$$\frac{33}{10}$$

```
linalg::cond(A, Infinity)
```

$$\frac{33}{10}$$

```
linalg::cond(A, 1)
```

$$3$$

```
linalg::cond(A, Frobenius)
```

$$\frac{\sqrt{2} \sqrt{43} \sqrt{251}}{40}$$

The result for the spectral norm is too complex, so we want the floating valuation. The tiny imaginary part is a rounding artifact:

```
linalg::cond(A, 2);  
float(%)
```

$$\sqrt{\frac{343}{9 \sigma_1} + \sigma_1 + \frac{43}{3}} \sqrt{\frac{11401}{5760000 \sigma_2} + \sigma_2 + \frac{251}{2400}}$$

where

$$\sigma_1 = \left( \frac{3970}{27} + \frac{\sqrt{27} \sqrt{910841} i}{27} \right)^{1/3}$$

$$\sigma_2 = \left( \frac{705851}{13824000000} + \frac{\sqrt{910841} \sqrt{176947200000000} i}{17694720000000} \right)^{1/3}$$

$$2.223147175 + 1.386849201 \cdot 10^{-18} i$$

If  $A$  contains at least one floating-point number, the result will be computed numerically.

```
B := A:
B[1,1] := float(B[1,1]):
linalg::cond(B, 2)
```

2.223147175

## Example 2

We define the  $2 \times 2$  matrix  $C$ .

```
C := matrix([[1, -2], [3, -4]])
```

$$\begin{pmatrix} 1 & -2 \\ 3 & -4 \end{pmatrix}$$

Now we calculate the condition number of  $C$  for some matrix norms.

```
linalg::cond(C,1)
```

21

```
linalg::cond(C,Infinity)
```

21

```
linalg::cond(C,Frobenius); Simplify(%);
```

$$\frac{\sqrt{2} \sqrt{15} \sqrt{30}}{2}$$

15

### Example 3

Hilbert matrices are very ill-conditioned:

```
linalg::cond( linalg::hilbert(3) )
```

748

```
linalg::cond( linalg::hilbert(5) )
```

943656

```
linalg::cond( linalg::hilbert(7) )
```

$\frac{1970389773}{2}$

## Parameters

**M**

Square matrix of domain type `Dom::Matrix`

## Options

**Frobenius, Infinity, Spectral**

The index of the matrix norm.

## Return Values

Arithmetical expression.

## See Also

### MuPAD Functions

norm

## `linalg::crossProduct`

Cross product of three-dimensional vectors

### Syntax

```
linalg::crossProduct(u, v)
```

### Description

`linalg::crossProduct(u, v)` computes the cross product of the three-dimensional vectors  $\vec{u}$  and  $\vec{v}$ . This is the vector

$$\vec{u} \times \vec{v} = \begin{pmatrix} u_2 v_3 - u_3 v_2 \\ u_3 v_1 - u_1 v_3 \\ u_1 v_2 - u_2 v_1 \end{pmatrix}.$$

The vectors must be defined over the same component ring.

### Examples

#### Example 1

We define two vectors:

```
a := matrix([[1, 2, 3]]);  
b := matrix([[ -1, 0, 1]])
```

```
( 1 2 3 )
```

```
( -1 0 1 )
```



The cross product of these two vectors is a vector  $\vec{c}$  which is orthogonal to  $\vec{a}$  and  $\vec{b}$ :

```
c:= linalg::crossProduct(a, b)
```

```
(2 -4 2)
```

```
linalg::scalarProduct(a, c), linalg::scalarProduct(b, c)
```

```
0, 0
```

## Parameters

**u, v**

3-dimensional vectors, i.e., either two  $3 \times 1$  or two  $1 \times 3$  matrices of a domain of category `Cat::Matrix`

## Return Values

Vector of the same domain type as u.

## See Also

**MuPAD Functions**

`linalg::scalarProduct`

## `linalg::delCol`

Delete matrix columns

### Syntax

```
linalg::delCol(A, c)
```

```
linalg::delCol(A, c1 .. c2)
```

```
linalg::delCol(A, list)
```

### Description

`linalg::delCol(A, c)` returns a copy of the matrix  $A$  in which the column with index  $c$  is deleted.

`linalg::delCol(A, c1.. c2)` deletes those columns whose indices are in the range  $c_1.. c_2$ . If  $c_2 < c_1$  then the input matrix  $A$  is returned.

`linalg::delCol(A, list)` deletes those columns whose indices are contained in `list`.

If all columns are deleted then `NIL` is returned.

### Examples

#### Example 1

We define the following matrix:

```
A := matrix([[1, 2, 3, 4], [5, 6, 7, 8]])
```

$$\begin{pmatrix} 1 & 2 & 3 & 4 \\ 5 & 6 & 7 & 8 \end{pmatrix}$$

and demonstrate the three different input formats for `linalg::delCol`:

```
linalg::delCol(A, 2)
```

$$\begin{pmatrix} 1 & 3 & 4 \\ 5 & 7 & 8 \end{pmatrix}$$

```
linalg::delCol(A, [1, 3])
```

$$\begin{pmatrix} 2 & 4 \\ 6 & 8 \end{pmatrix}$$

```
linalg::delCol(A, 2..4)
```

$$\begin{pmatrix} 1 \\ 5 \end{pmatrix}$$

## Example 2

We compute the inverse of the  $2 \times 2$  matrix:

```
MatQ := Dom::Matrix(Dom::Rational):
A := MatQ([[3, 2], [5, -4]])
```

$$\begin{pmatrix} 3 & 2 \\ 5 & -4 \end{pmatrix}$$

by appending the  $2 \times 2$  identity matrix to the right side of  $A$  and applying the Gauss-Jordan algorithm provided by the function `linalg::gaussJordan`:

```
B := linalg::gaussJordan(A . MatQ::identity(2))
```

$$\begin{pmatrix} 1 & 0 & \frac{2}{11} & \frac{1}{11} \\ 0 & 1 & \frac{5}{22} & -\frac{3}{22} \end{pmatrix}$$

We get the inverse of  $A$  by deleting the first two columns of the matrix  $B$ :

```
AI := linalg::delCol(B, 1..2)
```

$$\begin{pmatrix} \frac{2}{11} & \frac{1}{11} \\ \frac{5}{22} & -\frac{3}{22} \end{pmatrix}$$

Finally, we check the result:

$$A * AI, AI * A$$

$$\begin{pmatrix} 1 & 0 \\ 0 & 1 \end{pmatrix}, \begin{pmatrix} 1 & 0 \\ 0 & 1 \end{pmatrix}$$

Note: The inverse of A can be computed directly by entering 1/A.

## Parameters

**A**

An  $m \times n$  matrix of a domain of category `Cat::Matrix`

**c**

The column index: a positive integer less or equal to  $n$

**c<sub>1</sub> .. c<sub>2</sub>**

A range of column indices (positive integers less or equal to  $n$ )

**list**

A list of column indices (positive integers less or equal to  $n$ )

## Return Values

Matrix of a domain of category `Cat::Matrix(R)`, where R is the component ring of A, or NIL.

## See Also

### MuPAD Functions

`linalg::col` | `linalg::delRow` | `linalg::row`

### Topics

“Swap and Delete Rows and Columns” (Symbolic Math Toolbox)

## `linalg::delRow`

Delete matrix rows

### Syntax

```
linalg::delRow(A, r)
```

```
linalg::delRow(A, r1 .. r2)
```

```
linalg::delRow(A, list)
```

### Description

`linalg::delRow(A, r)` returns a copy of the matrix  $A$  in which the row with index  $r$  is deleted.

`linalg::delRow(A, r1 .. r2)` deletes those rows whose indices are in the range  $r_1 .. r_2$ . If  $r_2 < r_1$  then the input matrix  $A$  is returned.

`linalg::delRow(A, list)` deletes those rows whose indices are contained in `list`.

If all rows are deleted then `NIL` is returned.

### Examples

#### Example 1

We define the following matrix:

```
A := matrix([[1, 2], [3, 4], [5, 6], [7, 8]])
```

$$\begin{pmatrix} 1 & 2 \\ 3 & 4 \\ 5 & 6 \\ 7 & 8 \end{pmatrix}$$

and illustrate the three different input formats for `linalg::delRow`:

```
linalg::delRow(A, 2)
```

$$\begin{pmatrix} 1 & 2 \\ 5 & 6 \\ 7 & 8 \end{pmatrix}$$

```
linalg::delRow(A, [1, 4])
```

$$\begin{pmatrix} 3 & 4 \\ 5 & 6 \end{pmatrix}$$

```
linalg::delRow(A, 2..4)
```

$$(1 \ 2)$$

## Parameters

**A**

An  $m \times n$  matrix of a domain of category `Cat::Matrix`

**r**

The row index: a positive integer less or equal to  $m$

**r<sub>1</sub> .. r<sub>2</sub>**

A range of row indices (positive integers less or equal to  $m$ )

**list**

A list of row indices (positive integers less or equal to  $m$ )

## Return Values

Matrix of a domain of category `Cat::Matrix(R)`, where `R` is the component ring of `A` or `NIL`.

## See Also

### MuPAD Functions

`linalg::col` | `linalg::delCol` | `linalg::row`

## Topics

“Swap and Delete Rows and Columns” (Symbolic Math Toolbox)



# linalg::eigenvalues

Eigenvalues of a matrix

## Syntax

```
linalg::eigenvalues(A, <Multiple>)
```

## Description

`linalg::eigenvalues(A)` returns a list of the eigenvalues of the matrix  $A$ .

A floating-point approximation of the eigenvalues is computed with `numeric::eigenvalues`, if the matrix  $A$  is defined over the component ring `Dom::Float` (see “Example 1” on page 15-47 (Symbolic Math Toolbox)). In this case it is recommended to call `numeric::eigenvalues` directly for a better efficiency.

The eigenvalues are obtained by computing the zeros of the characteristic polynomial of  $A$ . The solver `solve` must be able to compute the roots of the characteristic polynomial over the component ring of  $A$ .

## Examples

### Example 1

We compute the eigenvalues of the matrix

$$A = \begin{pmatrix} 1 & 4 & 2 \\ 1 & 4 & 2 \\ 2 & 5 & 3 \end{pmatrix}.$$

```
A := matrix([[1, 4, 2], [1, 4, 2], [2, 5, 3]]):
linalg::eigenvalues(A)
```

```
{0, 4 - √15, √15 + 4}
```

If we consider the matrix over the domain `Dom :: Float`, then the call of `linalg::eigenvalues(A)` results in a numerical computation of the eigenvalues of `A` via `numeric::eigenvalues`:

```
B := Dom::Matrix(Dom::Float)(A):  
linalg::eigenvalues(B)
```

```
{-1.370431546 10-15, 0.1270166538, 7.872983346}
```

## Example 2

With the option `Multiple` we get the information about the algebraic multiplicity of each eigenvalue:

```
C := Dom::Matrix(Dom::Rational)(4, 4, [[-3], [0, 6]])
```

```
(  
  -3  0  0  0  
   0  6  0  0  
   0  0  0  0  
   0  0  0  0  
)
```

```
linalg::eigenvalues(C, Multiple)
```

```
[[ -3, 1], [0, 2], [6, 1]]
```

## Parameters

**A**

A square matrix of a domain of category `Cat :: Matrix`

## Options

### Multiple

Returns a list of sublists, where each sublist contains an eigenvalue of  $A$  and its algebraic multiplicity. Note that due to rounding errors, this may lead to wrong results in cases where multiple eigenvalues exist and `numeric::eigenvalues` is used.

## Return Values

Set of the eigenvalues of  $A$ , or a list of inner lists when the option `Multiple` is given (see below).

## See Also

### MuPAD Functions

`linalg::charpoly` | `linalg::eigenvectors` | `numeric::eigenvalues` | `solve`

## Topics

“Find Eigenvalues and Eigenvectors” (Symbolic Math Toolbox)

“Compute Eigenvalues and Eigenvectors Numerically” (Symbolic Math Toolbox)

# `linalg::eigenvectors`

Eigenvectors of a matrix

## Syntax

```
linalg::eigenvectors(A)
```

## Description

`linalg::eigenvectors(A)` computes the eigenvalues and eigenvectors of the matrix  $A$ .

A floating-point approximation of the eigenvalues and the eigenvectors is computed using `numeric::eigenvectors`, if the matrix  $A$  is defined over the component ring `Dom::Float` (see “Example 1” on page 15-51 (Symbolic Math Toolbox)). In this case it is recommended to call `numeric::eigenvalues` directly for a better efficiency.

`linalg::eigenvectors` works as follows: For each eigenvalue  $\lambda$  of the  $n \times n$  matrix  $A$ , a basis for the kernel of  $(\lambda I_n - A)$ , the eigenspace of  $A$  with respect to the eigenvalue  $\lambda$ , is computed using the Gauss-Jordan algorithm (see `linalg::gaussJordan`). Here,  $I_n$  denotes the  $n \times n$  identity matrix.

The eigenvectors are of the domain `Dom::Matrix(R)`, where  $R$  is the component ring of  $A$ .

The component ring of the matrix  $A$  must be a field, i.e., a domain of category `Cat::Field`, for which the solver `solve` is able to compute the zeros of a polynomial.

It can happen that a basis for the eigenspace of  $A$  with respect to a certain eigenvalue cannot be computed (e.g., if the component ring does not have a canonical representation of the zero element). In this case `linalg::eigenvectors` answers with a warning message and returns `FAIL`.

## Examples

### Example 1

We compute the eigenvalues and the eigenvectors of the matrix

$$A = \begin{pmatrix} 1 & -3 & 3 \\ 6 & -10 & 6 \\ 6 & 6 & 4 \end{pmatrix} :$$

```
A := Dom::Matrix(Dom::Rational)(
  [[1, -3, 3], [6, -10, 6], [6, 6, 4]]
):
Ev:= linalg::eigenvectors(A)
```

$$\left[ \left[ -11, 1, \begin{pmatrix} -\frac{7}{10} \\ -\frac{9}{5} \\ 1 \end{pmatrix} \right], \left[ -2, 1, \begin{pmatrix} -1 \\ 0 \\ 1 \end{pmatrix} \right], \left[ 8, 1, \begin{pmatrix} \frac{1}{4} \\ \frac{5}{12} \\ 1 \end{pmatrix} \right] \right]$$

The matrix A is diagonalizable. Hence, we extract the eigenvectors and combine them to a matrix P such that  $P^{-1} * A * P$  is the diagonal matrix whose diagonal entries are given by the corresponding eigenvalues:

```
Eigenvectors:= Ev[1][3][1], Ev[2][3][1], Ev[3][3][1]
```

$$\begin{pmatrix} -\frac{7}{10} \\ -\frac{9}{5} \\ 1 \end{pmatrix}, \begin{pmatrix} -1 \\ 0 \\ 1 \end{pmatrix}, \begin{pmatrix} \frac{1}{4} \\ \frac{5}{12} \\ 1 \end{pmatrix}$$

```
P:= Eigenvectors[1].Eigenvectors[2].Eigenvectors[3]
```

$$\begin{pmatrix} -\frac{7}{10} & -1 & \frac{1}{4} \\ -\frac{9}{5} & 0 & \frac{5}{12} \\ 1 & 1 & 1 \end{pmatrix}$$

`P-1 * A * P`

$$\begin{pmatrix} -11 & 0 & 0 \\ 0 & -2 & 0 \\ 0 & 0 & 8 \end{pmatrix}$$

A more skillful way of extracting the above eigenvectors from the output generated by `linalg::eigenvectors` is the following:

`map(Ev, op@op, 3)`

$$\left[ \left[ \begin{pmatrix} -\frac{7}{10} \\ -\frac{9}{5} \\ 1 \end{pmatrix}, \begin{pmatrix} -1 \\ 0 \\ 1 \end{pmatrix}, \begin{pmatrix} \frac{1}{4} \\ \frac{5}{12} \\ 1 \end{pmatrix} \right] \right]$$

If we consider the matrix `A` over the domain `Dom::Float`, the call of `linalg::eigenvectors(A)` results in a numerical computation of the eigenvalues and the eigenvectors of `A` via the function `numeric::eigenvectors`:

`B := Dom::Matrix(Dom::Float)(A):`  
`linalg::eigenvectors(B)`

$$\left[ \left[ 8.0, 1, \left[ \begin{pmatrix} 0.2248595067 \\ 0.3747658445 \\ 0.8994380268 \end{pmatrix} \right] \right], \left[ -2.0, 1, \left[ \begin{pmatrix} 0.7071067812 \\ 0.0 \\ -0.7071067812 \end{pmatrix} \right] \right], \right. \\ \left. \left[ -11.0, 1, \left[ \begin{pmatrix} 0.3218603429 \\ 0.8276408818 \\ -0.4598004899 \end{pmatrix} \right] \right] \right]$$

## Parameters

**A**

A square matrix of a domain of category `Cat::Matrix`

## Return Values

List of sublists, where each sublist consists of an eigenvalue  $\lambda$  of A, its algebraic multiplicity and a basis for the eigenspace of  $\lambda$ . If a basis of an eigenspace cannot be computed, FAIL is returned.

## See Also

### MuPAD Functions

`linalg::eigenvalues` | `linalg::nullspace` | `numeric::eigenvectors`

## Topics

“Find Eigenvalues and Eigenvectors” (Symbolic Math Toolbox)

“Compute Eigenvalues and Eigenvectors Numerically” (Symbolic Math Toolbox)

## `linalg::expr2Matrix`

Construct a matrix from equations

### Syntax

```
linalg::expr2Matrix(eqns, <vars, R>, <Include>)
```

### Description

`linalg::expr2Matrix(eqns, vars)` constructs the extended coefficient matrix

$(A, \vec{b})$  of the system of  $m$  linear equations in `eqns` with respect to the  $n$  indeterminates in `vars`. The vector  $\vec{b}$  is the right-hand side of this system.

`linalg::expr2Matrix` returns the extended coefficient matrix  $M = (A, \vec{b})$ . The right-hand side vector  $\vec{b}$  can be extracted from the matrix  $M$  by `linalg::col(M, n + 1)`.

The coefficient matrix  $A$  can be extracted by `linalg::delCol(M, n + 1)`.

Arithmetical expressions in `eqns` are considered as equations with right hand-sides zero.

If no variables are given, then the indeterminates of the equations are determined with the function `indets` and the option `PolyExpr`, i.e., the left-hand sides of the equations are considered as polynomial expressions.

If no component ring  $R$  is given then the standard domain `Dom::ExpressionField()` is chosen as the component ring of the extended coefficient matrix.

The coefficients of the linear equations are converted into elements of the component ring  $R$ . An error message is returned if this is not possible.



## Examples

### Example 1

The extended coefficient matrix of the system  $x + y + z = 1$ ,  $2y - z + 5 = 0$  of linear equations in the variables  $x, y, z$  is the following  $2 \times 4$  matrix:

```
delete x, y, z:
Ab := linalg::expr2Matrix(
  [x + y + z = 1, 2*y - z + 5], [x, y, z], Dom::Real
)
```

$$\begin{pmatrix} 1 & 1 & 1 & 1 \\ 0 & 2 & -1 & -5 \end{pmatrix}$$

We use `linalg::matlinsolve` to compute the general solution of this system:

```
linalg::matlinsolve(Ab)
```

$$\left[ \left( \begin{array}{c} \frac{7}{2} \\ -\frac{5}{2} \\ 0 \end{array} \right), \left[ \left( \begin{array}{c} -\frac{3}{2} \\ \frac{1}{2} \\ 1 \end{array} \right) \right] \right]$$

The coefficient matrix or the right-hand side vector can be extracted from the matrix `Ab` in the following way:

```
A := linalg::delCol(Ab, 4); b := linalg::col(Ab, 4)
```

$$\begin{pmatrix} 1 & 1 & 1 \\ 0 & 2 & -1 \end{pmatrix}$$

$$\begin{pmatrix} 1 \\ -5 \end{pmatrix}$$

## Example 2

The following two inputs lead to different linear systems:

```
delete x, y, z:  
linalg::expr2Matrix([x + y + z = 1, 2*y - z + 5 = x]),  
linalg::expr2Matrix([x + y + z = 1, 2*y - z + 5 = x], [x, y])
```

$$\begin{pmatrix} 1 & 1 & 1 & 1 \\ -1 & 2 & -1 & -5 \end{pmatrix}, \begin{pmatrix} 1 & 1 & 1 & -z \\ -1 & 2 & z & -5 \end{pmatrix}$$

## Example 3

Note the difference between calling `linalg::expr2Matrix` with and without option `Include`:

```
delete x, y:  
linalg::expr2Matrix([x + y = 1, 2*x - y = 3], [x, y])
```

$$\begin{pmatrix} 1 & 1 & 1 \\ 2 & -1 & 3 \end{pmatrix}$$

```
linalg::expr2Matrix([x + y = 1, 2*x - y = 3], [x, y], Include)
```

$$\begin{pmatrix} 1 & 1 & -1 \\ 2 & -1 & -3 \end{pmatrix}$$

## Parameters

### eqns

The system of linear equations, i.e. a set or list of expressions of type `"_equal"`

### vars

A set or list of indeterminates

**R**

A commutative ring, i.e., a domain of category `Cat::CommutativeRing`

**Options****Include**

Appends the negative of the right-hand side vector  $\vec{b}$  to the coefficient matrix  $A$  of the given system of linear equations. The result is the  $m \times (n + 1)$  matrix  $\begin{pmatrix} A, & -\vec{b} \end{pmatrix}$ .

**Return Values**

$m \times (n + 1)$  matrix of the domain `Dom::Matrix(R)`.

**See Also****MuPAD Functions**

`indets` | `linalg::matlinsolve` | `linsolve`

## `linalg::factorCholesky`

The Cholesky decomposition of a matrix

### Syntax

```
linalg::factorCholesky(A, <NoCheck>, <Real>)
```

### Description

`linalg::factorCholesky(A)` computes the Cholesky factorization of a Hermitian positive definite matrix  $A$  and returns a lower triangular matrix  $L$ , such that  $LL^H = A$ . Here,  $L^H$  is the Hermitian conjugate of  $L$  (the complex conjugate of the transpose).

The component ring of  $A$  must be a field (a domain of category `Cat::Field`).

If  $A$  is not a Hermitian positive definite matrix, then `linalg::factorCholesky` throws an error. If you use `NoCheck`, `linalg::factorCholesky` does not check whether the matrix is Hermitian positive definite. See “Example 2” on page 15-59 (Symbolic Math Toolbox).

If you use `Real`, then `linalg::factorCholesky` assumes that  $A$  is real and symmetric and, therefore, does not apply complex conjugate in the course of the algorithm.

`linalg::factorCholesky` returns `FAIL` if it fails to compute the matrix  $L$  over the component ring of  $A$ . (The algorithm requires the computation of square roots of some elements in  $L$ ).

### Environment Interactions

Properties of identifiers are taken into account.

## Examples

### Example 1

Define matrix S as follows:

```
S := Dom::Matrix(Dom::Rational)(
  [[4, -2, 4, 2], [-2, 10, -2, -7], [4, -2, 8, 4], [2, -7, 4, 7]]
)
```

$$\begin{pmatrix} 4 & -2 & 4 & 2 \\ -2 & 10 & -2 & -7 \\ 4 & -2 & 8 & 4 \\ 2 & -7 & 4 & 7 \end{pmatrix}$$

Compute the Cholesky factorization of S:

```
L := linalg::factorCholesky(S)
```

$$\begin{pmatrix} 2 & 0 & 0 & 0 \\ -1 & 3 & 0 & 0 \\ 2 & 0 & 2 & 0 \\ 1 & -2 & 1 & 1 \end{pmatrix}$$

Verify the result:

```
is(L * htranspose(L) = S)
```

TRUE

### Example 2

Define matrix H as follows:

```
H := matrix([[a, b], [b, a]])
```

$$\begin{pmatrix} a & b \\ b & a \end{pmatrix}$$

`linalg::factorCholesky` cannot compute the Cholesky factorization because it cannot prove that  $H$  is a Hermitian matrix:

```
linalg::factorCholesky(H)
```

```
Error: Hermitian matrix expected. [linalg::factorCholesky]
```

If you assume that  $a$  and  $b$  are real, then matrix  $H$  is Hermitian. Still, `linalg::factorCholesky` cannot compute the Cholesky factorization:

```
linalg::factorCholesky(H) assuming a in R_ and b in R_
```

```
Error: Unable to check whether the matrix component is positive. [linalg::factorCholesky]
```

Use the `NoCheck` option to skip checking whether this matrix is Hermitian positive definite. Now, `linalg::factorCholesky` computes the factorization:

```
L := linalg::factorCholesky(H, NoCheck)
```

$$\begin{pmatrix} \sqrt{a} & 0 \\ \frac{b}{\sqrt{a}} & \frac{\sqrt{a|a|-|b|^2}}{\sqrt{|a|}} \end{pmatrix}$$

This result is not generally valid:

```
L*httranspose(L) = H
```

$$\begin{pmatrix} \sqrt{a} & \sqrt{a} \\ \frac{b\sqrt{a}}{\sqrt{a}} & \frac{\sqrt{a|a|-|b|^2}}{|a|} \sqrt{a|a|-|b|^2} + \frac{b\bar{b}}{\sqrt{a}\sqrt{a}} \end{pmatrix} = \begin{pmatrix} a & b \\ b & a \end{pmatrix}$$

It is valid for  $0 < a < b$ :

```
simplify(L*httranspose(L) = H) assuming 0 < b < a
```

$$\begin{pmatrix} a & b \\ b & a \end{pmatrix} = \begin{pmatrix} a & b \\ b & a \end{pmatrix}$$

### Example 3

Compute the Cholesky factorization of matrix  $H$  using `NoCheck` to skip checking whether it is Hermitian positive definite. By default, `linalg::factorCholesky` computes a Hermitian factorization  $A = L L^H$ . Thus, the result contains complex conjugates (implied by  $|a| = a \bar{a}$ ).

```
H := matrix([[a, b], [b, a]]):
L := linalg::factorCholesky(H, NoCheck)
```

$$\begin{pmatrix} \sqrt{a} & 0 \\ \frac{b}{\sqrt{a}} & \frac{\sqrt{a|a|-|b|^2}}{\sqrt{|a|}} \end{pmatrix}$$

To avoid complex conjugates in the result, use `Real`:

```
L := linalg::factorCholesky(H, NoCheck, Real)
```

$$\begin{pmatrix} \sqrt{a} & 0 \\ \frac{b}{\sqrt{a}} & \sqrt{\frac{a^2 - b^2}{a}} \end{pmatrix}$$

With this option, `linalg::factorCholesky` computes a symmetric factorization  $A = L L^t$  instead of a Hermitian factorization  $A = L L^H$ :

```
simplify(L*transpose(L) = H)
```

$$\begin{pmatrix} a & b \\ b & a \end{pmatrix} = \begin{pmatrix} a & b \\ b & a \end{pmatrix}$$

## Parameters

### A

Square matrix of a domain of category `Cat::Matrix`.

## Options

### NoCheck

Skip checking whether  $A$  is Hermitian positive definite. When you use this option, the identity  $LL^H = A$  is guaranteed to hold only if  $A$  is a Hermitian positive definite matrix.

### Real

Compute the Cholesky factorization assuming that matrix  $A$  is symmetric and all its symbolic parameters are real. In this case, the transpose of the matrix is its Hermitian transpose. Use this option if  $A$  contains symbolic parameters, and you want to avoid complex conjugates. When using this option, the identity  $LL^T = A$  is guaranteed to hold.

## Return Values

Matrix of the same domain type as  $A$ , or the value FAIL.

## Algorithms

The Cholesky factorization of a Hermitian positive definite  $n \times n$  matrix  $A$  is a decomposition of  $A$  in a product  $LL^H = A$ , such that  $L$  is a lower triangular matrix with positive entries on the main diagonal.  $L$  is called the “Cholesky factor” of  $A$ .

If  $L = (l_{i,j})$ , where  $1 \leq i \leq n$ ,  $1 \leq j \leq n$ , is the Cholesky factor of  $A$ , then

$$\det A = \left( \prod_{i=1}^n l_{ii} \right)^2.$$

## See Also

### MuPAD Functions

`linalg::isHermitian` | `linalg::isPosDef`

## Topics

“Compute Cholesky Factorization” (Symbolic Math Toolbox)



# linalg::factorLU

LU-decomposition of a matrix

## Syntax

```
linalg::factorLU(A)
```

## Description

`linalg::factorLU(A)` computes an LU-decomposition of an  $m \times n$  matrix  $A$ , i.e., a decomposition of the  $A$  into an  $m \times m$  lower triangular matrix  $L$  and an  $m \times n$  upper triangular matrix  $U$  such that  $PA = LU$ , where  $P$  is a permutation matrix.

The diagonal entries of the lower triangular matrix  $L$  are equal to one (*Doolittle*-decomposition). The diagonal entries of  $U$  are the pivot elements used during the computation.

The matrices  $L$  and  $U$  are unique.

`pivindex` is a list  $[r_1, r_2, \dots]$  representing the row exchanges of  $A$  in the pivoting steps, i.e.,  $B = PA = LU$ , where  $b_{ij} = a_{r_i, j}$ .

A floating-point approximation of the decomposition is computed using `numeric::factorLU`, if the matrix  $A$  is defined over the component ring `Dom::Float`. In this case it is recommended to call `numeric::factorLU` directly for a better efficiency.

The algorithm also works for singular  $A$ . In this case either  $L$  or  $U$  is singular.

$L$  and  $U$  are nonsingular if and only if  $A$  is nonsingular.

The component ring of the matrix  $A$  must be a field, i.e., a domain of category `Cat::Field`.

## Examples

### Example 1

We compute an LU-decomposition of the real matrix:

```
A := Dom::Matrix(Dom::Real)(  
  [[2, -3, -1], [1, 1, -1], [0, 1, -1]]  
)
```

$$\begin{pmatrix} 2 & -3 & -1 \\ 1 & 1 & -1 \\ 0 & 1 & -1 \end{pmatrix}$$

```
[L, U, pivlist] := linalg::factorLU(A)
```

$$\left[ \begin{pmatrix} 1 & 0 & 0 \\ \frac{1}{2} & 1 & 0 \\ 0 & \frac{2}{5} & 1 \end{pmatrix}, \begin{pmatrix} 2 & -3 & -1 \\ 0 & \frac{5}{2} & -\frac{1}{2} \\ 0 & 0 & -\frac{4}{5} \end{pmatrix}, [1, 2, 3] \right]$$

The lower triangular matrix  $L$  is the first element and the upper triangular matrix  $U$  is the second element of the list LU. The product of these two matrices is equal to the input matrix A:

```
L * U
```

$$\begin{pmatrix} 2 & -3 & -1 \\ 1 & 1 & -1 \\ 0 & 1 & -1 \end{pmatrix}$$

### Example 2

An LU-decomposition of the  $3 \times 2$  matrix:

```
A := Dom::Matrix(Dom::Real)([[2, -3], [1, 2], [2, 3]])
```

$$\begin{pmatrix} 2 & -3 \\ 1 & 2 \\ 2 & 3 \end{pmatrix}$$

gives a  $3 \times 3$  lower triangular matrix and a  $3 \times 2$  upper triangular matrix:

```
[L, U, pivlist] := linalg::factorLU(A)
```

$$\left[ \begin{pmatrix} 1 & 0 & 0 \\ \frac{1}{2} & 1 & 0 \\ 1 & \frac{12}{7} & 1 \end{pmatrix}, \begin{pmatrix} 2 & -3 \\ 0 & \frac{7}{2} \\ 0 & 0 \end{pmatrix}, [1, 2, 3] \right]$$

```
L * U
```

$$\begin{pmatrix} 2 & -3 \\ 1 & 2 \\ 2 & 3 \end{pmatrix}$$

### Example 3

To compute the LU-decomposition of the matrix:

```
A := matrix([[1, 2, -1], [0, 0, 3], [0, 2, -1]])
```

$$\begin{pmatrix} 1 & 2 & -1 \\ 0 & 0 & 3 \\ 0 & 2 & -1 \end{pmatrix}$$

one row interchange is needed, and we therefore get a non-trivial permutation list:

```
[L, U, pivlist] := linalg::factorLU(A)
```

$$\left[ \begin{pmatrix} 1 & 0 & 0 \\ 0 & 1 & 0 \\ 0 & 0 & 1 \end{pmatrix}, \begin{pmatrix} 1 & 2 & -1 \\ 0 & 2 & -1 \\ 0 & 0 & 3 \end{pmatrix}, [1, 3, 2] \right]$$

The corresponding permutation matrix is the following:

```
P := linalg::swapRow(matrix::identity(3), 3, 2)
```

$$\begin{pmatrix} 1 & 0 & 0 \\ 0 & 0 & 1 \\ 0 & 1 & 0 \end{pmatrix}$$

Hence, we have a decomposition of  $A$  into the product of the three matrices  $\frac{1}{P}$ ,  $L$  and  $U$  as follows:

```
P^(-1) * L * U
```

$$\begin{pmatrix} 1 & 2 & -1 \\ 0 & 0 & 3 \\ 0 & 2 & -1 \end{pmatrix}$$

## Example 4

You may compute an LU-decomposition of a matrix with symbolic components, such as:

```
delete a, b, c, d:  
A := matrix([[a, b], [c, d]])
```

$$\begin{pmatrix} a & b \\ c & d \end{pmatrix}$$

The diagonal entries of the matrix  $U$  are the pivot elements used during the computation. They must be non-zero, if the inverse of  $U$  is needed:

```
[L, U, pivlist] := linalg::factorLU(A)
```

$$\left[ \left( \begin{array}{cc} 1 & 0 \\ \frac{c}{a} & 1 \end{array} \right), \left( \begin{array}{cc} a & b \\ 0 & d - \frac{bc}{a} \end{array} \right), [1, 2] \right]$$

For example, if we use this decomposition to solve the linear system  $A \vec{x} = \vec{b}$  for arbitrary vectors  $\vec{b} = (b_1, b_2)^t$ , then the following result is only correct for  $a \neq 0$  and  $d - \frac{bc}{a} \neq 0$ :

```
delete b1, b2:
linalg::matlinsolveLU(L, U, matrix([b1, b2]))
```

$$\begin{pmatrix} \frac{b_1 - \frac{b(a b_2 - b_1 c)}{a d - b c}}{a} \\ \frac{a b_2 - b_1 c}{a d - b c} \end{pmatrix}$$

## Parameters

**A**

A matrix of a domain of category `Cat::Matrix`

## Return Values

List `[L, U, pivindex]` with the two matrices  $L$  and  $U$  of the domain `Dom::Matrix(R)` and a list `pivindex` of positive integers.  $R$  is the component ring of  $A$ .

## Algorithms

The following algorithm for solving the system  $A \vec{x} = \vec{b}$  with a nonsingular matrix  $A$  uses LU-decomposition:

1 Compute a LU-decomposition of  $A$ :  $A = L U$ .

2

Solve  $\vec{y} = \frac{\vec{b}}{L}$  by forward substitution.

3

Solve  $\vec{x} = \frac{\vec{y}}{R}$  by backward substitution.

The LU-decomposition of a matrix  $A$  is useful for solving several systems of linear equations  $A \vec{x} = \vec{b}$  with the same coefficient matrix  $A$  and several right-hand side vectors  $\vec{b}$ , because then step one of the algorithm above needs to be done only once.

## See Also

### MuPAD Functions

`linalg::factorCholesky` | `linalg::factorQR` | `linalg::inverseLU` |  
`linalg::matlinsolveLU` | `lllint` | `numeric::factorLU`

## Topics

“Compute LU Factorization” (Symbolic Math Toolbox)

# **linalg::factorQR**

QR-decomposition of a matrix

## **Syntax**

```
linalg::factorQR(A)
```

## **Description**

`linalg::factorQR(A)` computes an QR-decomposition of an  $m \times n$  matrix  $A$ , i.e., a decomposition of  $A$  into an  $m \times m$  unitary matrix  $Q$  and an  $m \times n$  upper triangular matrix  $R$  such that  $QR = A$ .

`linalg::factorQR` uses Gram-Schmidt orthonormalization to compute the decomposition.

For a singular or non-square matrix  $A$  the QR-decomposition of  $A$  is not unique.

The columns of  $Q$  form an orthonormal basis with respect to the scalar product of two vectors, defined by `linalg::scalarProduct`, and the 2-norm of two vectors (see the method "norm" of the domain constructor `Dom::Matrix`).

If the component ring of  $A$  does not define the method "conjugate", then the factor  $Q$  is orthogonal instead of unitary.

If the columns of  $A$  cannot be orthonormalized then FAIL is returned.

If  $A$  is a matrix over the domain `Dom::Float` and the computations are based on the standard scalar product, then the use of the corresponding function from the numeric library (`numeric::factorQR`) is recommended.

Even if  $A$  is defined over the real or the complex numbers the call of `numeric::factorQR` with the option `Symbolic` is recommended for better efficiency.

The component ring of the matrix  $A$  must be a field, i.e., a domain of category `Cat::Field`.

## Examples

### Example 1

We compute the QR-decomposition of a real matrix:

```
A := Dom::Matrix(Dom::Real)(
  [[2, -3, -1], [1, 1, -1], [0, 1, -1]]
)
```

$$\begin{pmatrix} 2 & -3 & -1 \\ 1 & 1 & -1 \\ 0 & 1 & -1 \end{pmatrix}$$

```
QR := linalg::factorQR(A)
```

$$\left[ \begin{pmatrix} \frac{2\sqrt{5}}{5} & -\frac{\sqrt{6}}{6} & -\frac{\sqrt{2}\sqrt{15}}{30} \\ \frac{\sqrt{5}}{5} & \frac{\sqrt{6}}{3} & \frac{\sqrt{2}\sqrt{15}}{15} \\ 0 & \frac{\sqrt{6}}{6} & -\frac{\sqrt{2}\sqrt{15}}{6} \end{pmatrix}, \begin{pmatrix} \sqrt{5} & -\sqrt{5} & -\frac{3\sqrt{5}}{5} \\ 0 & \sqrt{6} & -\frac{\sqrt{6}}{3} \\ 0 & 0 & \frac{2\sqrt{2}\sqrt{15}}{15} \end{pmatrix} \right]$$

The orthogonal matrix  $Q$  is the first element and the upper triangular matrix  $R$  is the second element of the list  $QR$ . The product of these two matrices is equal to the input matrix  $A$ :

```
QR[1] * QR[2]
```

$$\begin{pmatrix} 2 & -3 & -1 \\ 1 & 1 & -1 \\ 0 & 1 & -1 \end{pmatrix}$$

### Example 2

The QR-decomposition of the  $3 \times 2$  matrix:



```
B := Dom::Matrix(Dom::Real)(
  [[2, -3], [1, 2], [2, 3]]
)
```

$$\begin{pmatrix} 2 & -3 \\ 1 & 2 \\ 2 & 3 \end{pmatrix}$$

yields a 3×3 orthogonal matrix and a 3×2 upper triangular matrix:

```
QR := linalg::factorQR(B)
```

$$\left[ \begin{pmatrix} \frac{2}{3} & -\frac{31\sqrt{194}}{582} & \frac{\sqrt{194}}{194} \\ \frac{1}{3} & \frac{8\sqrt{194}}{291} & \frac{6\sqrt{194}}{97} \\ \frac{2}{3} & \frac{23\sqrt{194}}{582} & -\frac{7\sqrt{194}}{194} \end{pmatrix}, \begin{pmatrix} 3 & \frac{2}{3} \\ 0 & \frac{\sqrt{194}}{3} \\ 0 & 0 \end{pmatrix} \right]$$

```
QR[1] * QR[2]
```

$$\begin{pmatrix} 2 & -3 \\ 1 & 2 \\ 2 & 3 \end{pmatrix}$$

For this example we may call `numeric::factorQR(B, Symbolic)` instead, which in general is faster than `linalg::factorQR`:

```
QR := numeric::factorQR(B, Symbolic)
```

$$\left[ \begin{pmatrix} \frac{2}{3} & -\frac{31\sqrt{194}}{582} & \frac{\sqrt{194}}{194} \\ \frac{1}{3} & \frac{8\sqrt{194}}{291} & \frac{6\sqrt{194}}{97} \\ \frac{2}{3} & \frac{23\sqrt{194}}{582} & -\frac{7\sqrt{194}}{194} \end{pmatrix}, \begin{pmatrix} 3 & \frac{2}{3} \\ 0 & \frac{\sqrt{194}}{3} \\ 0 & 0 \end{pmatrix} \right]$$

## Parameters

**A**

A matrix of a domain of category `Cat::Matrix`

## Return Values

List [Q, R] of the two matrices Q and R (of the same domain type as A), or the value FAIL.

## Algorithms

The QR-decomposition can be used to generate a least square solution to an

overdetermined system of linear equations. If  $A \vec{x} = \vec{b}$ , then  $R \vec{x} = Q^t \vec{b}$  can be solved via backward substitution.

## See Also

### MuPAD Functions

`linalg::factorCholesky` | `linalg::factorLU` | `lllint` | `numeric::factorQR`

## Topics

“Compute QR Factorization” (Symbolic Math Toolbox)

# linalg::frobeniusForm

Frobenius form of a matrix

## Syntax

```
linalg::frobeniusForm(A, <All>)
```

## Description

`linalg::frobeniusForm(A)` returns the Frobenius form of the matrix  $A$ , also called the Rational Canonical form of  $A$ .

`linalg::frobeniusForm(A, All)` computes the Frobenius form  $R$  of  $A$  and a transformation matrix  $P$  such that  $PRP^{-1}$ .

The Frobenius form as computed by `linalg::frobeniusForm` is unique (see below).

The component ring of  $A$  must be a field, i.e., a domain of category `Cat::Field`.

## Examples

### Example 1

The Frobenius form of the following matrix over  $\mathbb{C}$ :

```
A := Dom::Matrix(Dom::Complex)(
  [[1, 2, 3], [4, 5, 6], [7, 8, 9]]
)
```

$$\begin{pmatrix} 1 & 2 & 3 \\ 4 & 5 & 6 \\ 7 & 8 & 9 \end{pmatrix}$$

is the matrix:

```
R := linalg::frobeniusForm(A)
```

$$\begin{pmatrix} 0 & 0 & 0 \\ 1 & 0 & 18 \\ 0 & 1 & 15 \end{pmatrix}$$

The transformation matrix  $P$  can be selected from the list  $[R, P]$ , which is the result of `linalg::frobeniusForm` with option `All`:

```
P := linalg::frobeniusForm(A, All)[2]
```

$$\begin{pmatrix} 1 & 1 & 30 \\ 0 & 4 & 66 \\ 0 & 7 & 102 \end{pmatrix}$$

We check the result:

```
P * R * P^(-1)
```

$$\begin{pmatrix} 1 & 2 & 3 \\ 4 & 5 & 6 \\ 7 & 8 & 9 \end{pmatrix}$$

## Parameters

**A**

A square matrix of a domain of category `Cat::Matrix`

## Options

**All**

Returns the list  $[R, P]$  with the Frobenius form  $R$  of  $A$  and a transformation matrix  $P$  such that  $A = PRP^{-1}$ .

## Return Values

Matrix of the same domain type as  $A$ , or the list  $[R, P]$  when the option `All` is given.

## References

Reference: P. Ozello: *Calcul exact des formes de Jordan et de Frobenius d'une matrice*, pp. 30-43. Thèse de l'Université Scientifique Technologique et Médicale de Grenoble, 1987

## Algorithms

The Frobenius form of a square matrix  $A$  is the matrix

$$R = \begin{pmatrix} R_1 & & \\ & \ddots & \\ & & R_r \end{pmatrix},$$

where  $R_1, \dots, R_r$  are known as companion matrices and have the form:

$$R_i = \begin{pmatrix} 0 & \dots & 0 & -a_0 \\ 1 & & & -a_1 \\ & \ddots & & \vdots \\ & & \ddots & \vdots \\ & & & 0 & \vdots \\ & & & & 1 & -a_{n_i-1} \end{pmatrix}, i = 1, \dots, r$$

In the last column of the companion matrix  $R_i$ , you see the coefficients of its minimal polynomial in ascending order, i.e., the polynomial  $m_i := X^{n_i} + a_{n_i-1}X^{n_i-1} + \dots + a_1X + a_0$  is the minimal polynomial of the matrix  $R_i$ .

For these polynomials the following holds:  $m_{i+1}$  divides  $m_i$  for  $i = 1, \dots, r-1$ , and the product of all  $m_i$  for  $i = 1, \dots, r$  gives a factorization of the characteristic polynomial of the matrix  $A$ . The Frobenius form defined in this way is unique.

## See Also

### **MuPAD Functions**

`linalg::hermiteForm` | `linalg::jordanForm` | `linalg::minpoly` |  
`linalg::smithForm`

# linalg::gaussElim

Gaussian elimination

---

**Note** For Gaussian Elimination in MATLAB®, see the Symbolic Math Toolbox™ `rref` function.

---

## Syntax

```
linalg::gaussElim(A, <All>)
```

## Description

`linalg::gaussElim(A)` performs Gaussian elimination on the matrix  $A$  to reduce  $A$  to a similar matrix in upper row echelon form.

A row echelon form of  $A$  returned by `linalg::gaussElim` is not unique. See `linalg::gaussJordan` for computing the *reduced* row echelon form.

The component ring  $R$  of  $A$  must be an integral domain, i.e., a domain of category `Cat::IntegralDomain`.

If  $R$  is a field, i.e., a domain of category `Cat::Field`, ordinary Gaussian elimination is used. Otherwise, `linalg::gaussElim` applies fraction-free Gaussian elimination to  $A$ .

`linalg::gaussElim` serves as an interface function for the method "`gaussElim`" of the matrix domain of  $A$ , i.e., one may call `A::dom::gaussElim(A)` directly instead of `linalg::gaussElim(A, All)`

Refer to the help page of `Dom::Matrix` for details about the computation strategy of `linalg::gaussElim`.

## Examples

### Example 1

We apply Gaussian elimination to the following matrix:

```
A := Dom::Matrix(Dom::Rational)(  
  [[1, 2, 3, 4], [-1, 0, 1, 0], [3, 5, 6, 9]]  
)
```

$$\begin{pmatrix} 1 & 2 & 3 & 4 \\ -1 & 0 & 1 & 0 \\ 3 & 5 & 6 & 9 \end{pmatrix}$$

which reduces A to the following row echelon form:

```
linalg::gaussElim(A)
```

$$\begin{pmatrix} 1 & 2 & 3 & 4 \\ 0 & 2 & 4 & 4 \\ 0 & 0 & -1 & -1 \end{pmatrix}$$

### Example 2

We apply Gaussian elimination to the matrix:

```
B := Dom::Matrix(Dom::Integer)(  
  [[1, 2, -1], [1, 0, 1], [2, -1, 4]]  
)
```

$$\begin{pmatrix} 1 & 2 & -1 \\ 1 & 0 & 1 \\ 2 & -1 & 4 \end{pmatrix}$$

and get the following result:

```
linalg::gaussElim(B, All)
```



$$\left[ \left( \begin{pmatrix} 1 & 2 & -1 \\ 0 & -2 & 2 \\ 0 & 0 & -2 \end{pmatrix}, 3, -2, \{1, 2, 3\} \right) \right]$$

We see that  $\text{rank}(B) = 3$  and  $\det B = -2$ .

## Parameters

**A**

A matrix of a domain of category `Cat::Matrix`

## Options

**ALL**

Returns a list  $[T, \text{rank}(A), \det A, \{j_1, \dots, j_r\}]$  where  $T$  is a row echelon form of  $A$  and  $\{j_1, \dots, j_r\}$  is the set of characteristic column indices of  $T$ .

If  $A$  is not square, then the value FAIL is given instead of  $\det A$ .

## Return Values

a matrix of the same domain type as  $A$ , or the list  $[T, \text{rank}(A), \det(A), \{j\_1, \dots, j\_r\}]$  when the option `ALL` is given (see below).

## Algorithms

Let  $T = (t_{i,j})_{1 \leq i \leq m, 1 \leq j \leq n}$  be an  $m \times n$  matrix. Then  $T$  is a matrix in an upper row echelon form, if  $r \in \{0, 1, \dots, n\}$  and indices  $j_1, j_2, \dots, j_r \in \{1, \dots, n\}$  exist with:

- 1  $j_1 < j_2 < \dots < j_r$ .

- 2 For each  $i \in \{1, \dots, r\}$ :  $t_{i,1} = t_{i,2} = \dots = t_{i,j_i-1} = 0$ .
- 3 For each  $i \in \{r+1, \dots, m\}$ :  $t_{i,j} = 0$  for each  $j \in \{1, \dots, n\}$ .

The indices  $j_1, j_2, \dots, j_r$  are the *characteristic column indices* of the matrix  $T$ .

## See Also

### MuPAD Functions

`linalg::gaussJordan` | `linalg::lllint`

# linalg::gaussJordan

Gauss-Jordan elimination

## Syntax

```
linalg::gaussJordan(A, <All>)
```

## Description

`linalg::gaussJordan(A)` performs Gauss-Jordan elimination on the matrix  $A$ , i.e., it returns the reduced row echelon form of  $A$ .

The component ring  $R$  of  $A$  must be an integral domain, i.e., a domain of category `Cat::IntegralDomain`.

If  $R$  is a field, i.e., a domain of category `Cat::Field`, then the leading entries of the matrix  $T$  in reduced row echelon form are equal to one.

If  $R$  is a ring providing the method "gcd", then the components of each row of  $T$  do not have a non-trivial common divisor.

If the component ring of  $A$  is a field, then the reduced row echelon form is unique.

## Examples

### Example 1

We apply Gauss-Jordan elimination to the following matrix:

```
A := Dom::Matrix(Dom::Rational)(
  [[1, 2, 3, 4], [-5, 0, 3, 0], [3, 5, 6, 9]]
)
```

$$\begin{pmatrix} 1 & 2 & 3 & 4 \\ -5 & 0 & 3 & 0 \\ 3 & 5 & 6 & 9 \end{pmatrix}$$

```
linalg::gaussJordan(A, All)
```

$$\left[ \left( \begin{pmatrix} 1 & 0 & 0 & \frac{1}{2} \\ 0 & 1 & 0 & \frac{1}{2} \\ 0 & 0 & 1 & \frac{5}{6} \end{pmatrix} \right), 3, \text{FAIL}, \{1, 2, 3\} \right]$$

We see that  $\text{rank}(B) = 3$ . Because the determinant of a matrix is only defined for square matrices, the third element of the returned list is the value FAIL.

## Example 2

If we consider the matrix from “Example 1” on page 15-81 (Symbolic Math Toolbox) as an integer matrix and apply the Gauss-Jordan elimination we get the following matrix:

```
B := Dom::Matrix(Dom::Integer)(  
  [[1, 2, 3, 4], [-5, 0, 3, 0], [3, 5, 6, 9]]  
):  
linalg::gaussJordan(B)
```

$$\begin{pmatrix} 2 & 0 & 0 & 1 \\ 0 & -2 & 0 & -1 \\ 0 & 0 & -6 & -5 \end{pmatrix}$$

## Parameters

**A**

A matrix of a domain of category `Cat::Matrix`

## Options

### ALL

Returns a list  $[T, \text{rank}(A), \det A, \{j_1, \dots, j_r\}]$  where  $T$  is the reduced row echelon form of  $A$  and  $\{j_1, \dots, j_r\}$  is the set of characteristic column indices of  $T$ .

If  $A$  is not square, then the value FAIL is given instead of  $\det A$ .

## Return Values

a matrix of the same domain type as  $A$ , or the list  $[T, \text{rank}(A), \det(A), \{j_1, \dots, j_r\}]$  when the option ALL is given (see below).

## Algorithms

Let  $T = (t_{i,j})_{1 \leq i \leq m, 1 \leq j \leq n}$  be an  $m \times n$  matrix. Then  $T$  is a matrix in *reduced row echelon form*, if  $r \in \{0, 1, \dots, n\}$  and indices  $j_1, j_2, \dots, j_r \in \{1, \dots, n\}$  exist with:

- 1  $j_1 < j_2 < \dots < j_r$ .
- 2 For each  $i \in \{1, \dots, r\}$ :  $t_{i,1} = t_{i,2} = \dots = t_{i,j_i-1} = 0$ . In addition, if  $A$  is defined over a field:  $t_{i,j_i} = 1$ .
- 3 For each  $i \in \{r+1, \dots, m\}$ :  $t_{i,j} = 0$  for each  $j \in \{1, \dots, n\}$ .
- 4 For each  $i \in \{1, \dots, r\}$ :  $t_{k,j_i} = 0$  for each  $k \in \{1, \dots, i-1\}$ .

The indices  $j_1, j_2, \dots, j_r$  are the *characteristic column indices* of the matrix  $T$ .

## See Also

### MuPAD Functions

linalg::gaussElim

## Topics

“Compute Reduced Row Echelon Form” (Symbolic Math Toolbox)

## `linalg::hermiteForm`

Hermite normal form of a matrix

### Syntax

```
linalg::hermiteForm(A, <var>, <All>)
```

### Description

`linalg::hermiteForm(A)` returns the Hermite normal form of a nonsingular integer square matrix  $A$ . The Hermite normal form of a matrix is an upper-triangular matrix  $H$ ,

such that  $H_{jj} \geq 0$  and  $-\frac{H_{ij}}{2} < H_{ij} \leq \frac{H_{ij}}{2}$  for  $j > i$ . If matrix  $A$  is not square or singular, `linalg::hermiteForm` simply returns an upper-triangular matrix.

If matrix  $A$  is not of the domain `Dom::Matrix(Dom::Integer)` then `linalg::hermiteForm` converts  $A$  into a matrix of this domain for intermediate computations. If this conversion fails, then `linalg::hermiteForm` issues an error message.

`linalg::hermiteForm(A, var)` returns the Hermite normal form of  $A$  assuming that the elements of  $A$  are univariate polynomials in the variable `var`. If  $A$  does not contain `var`, then `hermiteForm(A)` and `hermiteForm(A, var)` return different results.

`linalg::hermiteForm(A, <var>, All)` returns the list  $[H, U]$ , where  $H$  is the Hermite normal form of  $A$ , and  $U$  is a unimodular transformation matrix, such that  $H = U \cdot A$ . You can use the `All` option with or without specifying the variable `var`.

### Examples

#### Example 1

Create the following matrix of integers.

```
A := matrix([[9, -36, 30], [-36, 192, -180], [30, -180, 180]])
```

$$\begin{pmatrix} 9 & -36 & 30 \\ -36 & 192 & -180 \\ 30 & -180 & 180 \end{pmatrix}$$

Find the Hermite normal form of this matrix.

```
linalg::hermiteForm(A)
```

$$\begin{pmatrix} 3 & 0 & 30 \\ 0 & 12 & 0 \\ 0 & 0 & 60 \end{pmatrix}$$

Use the All option to find the corresponding transformation matrix.

```
[H, U] := linalg::hermiteForm(A, All)
```

$$\left[ \begin{pmatrix} 3 & 0 & 30 \\ 0 & 12 & 0 \\ 0 & 0 & 60 \end{pmatrix}, \begin{pmatrix} 13 & 9 & 7 \\ 6 & 4 & 3 \\ 20 & 15 & 12 \end{pmatrix} \right]$$

Verify that  $H = U \cdot A$ .

```
H = U*A
```

$$\begin{pmatrix} 3 & 0 & 30 \\ 0 & 12 & 0 \\ 0 & 0 & 60 \end{pmatrix} = \begin{pmatrix} 3 & 0 & 30 \\ 0 & 12 & 0 \\ 0 & 0 & 60 \end{pmatrix}$$

## Example 2

Create the following matrix of polynomials.

```
B := matrix([[-(x - 3)^2*(x - 2), (x - 3)*(x - 2)*(x - 4)],
             [(x - 3)*(x - 2)*(x - 4), -(x - 3)^2*(x - 4)]
            ])
```

$$\begin{pmatrix} -(x-2)(x-3)^2 & (x-2)(x-3)(x-4) \\ (x-2)(x-3)(x-4) & -(x-3)^2(x-4) \end{pmatrix}$$

Find the Hermite normal form of this matrix.

```
linalg::hermiteForm(B)
```

$$\begin{pmatrix} x^2 - 5x + 6 & 0 \\ 0 & x^2 - 7x + 12 \end{pmatrix}$$

Use the All option to find the corresponding transformation matrix.

```
[H, U] := linalg::hermiteForm(B, All)
```

$$\left[ \begin{pmatrix} x^2 - 5x + 6 & 0 \\ 0 & x^2 - 7x + 12 \end{pmatrix}, \begin{pmatrix} 3 - x & 2 - x \\ 4 - x & 3 - x \end{pmatrix} \right]$$

### Example 3

If a matrix does not contain a particular variable, and you call `linalg::hermiteForm` specifying that variable as the second argument, then the result differs from what you get without specifying that variable. For example, create a matrix that does not contain any variables.

```
A := matrix([[9, -36, 30], [-36, 192, -180], [30, -180, 180]])
```

$$\begin{pmatrix} 9 & -36 & 30 \\ -36 & 192 & -180 \\ 30 & -180 & 180 \end{pmatrix}$$

Call `linalg::hermiteForm` specifying variable `x` as the second argument. In this case, `linalg::hermiteForm` assumes that the elements of `A` are univariate polynomials in `x`.



```
linalg::hermiteForm(A, x)
```

$$\begin{pmatrix} 1 & 0 & 0 \\ 0 & 1 & 0 \\ 0 & 0 & 1 \end{pmatrix}$$

Call `linalg::hermiteForm` without specifying variables. In this case, `linalg::hermiteForm` treats `A` as a matrix of integers.

```
linalg::hermiteForm(A)
```

$$\begin{pmatrix} 3 & 0 & 30 \\ 0 & 12 & 0 \\ 0 & 0 & 60 \end{pmatrix}$$

## Parameters

**A**

An integer matrix of category `Cat::Matrix`

## Options

**All**

Returns the list `[H, U]`, where `H` is the Hermite normal form of `A`, and `U` is a corresponding transformation matrix.

## Return Values

Matrix of the same domain type as `A`. With the option `All`, `linalg::hermiteForm` returns the list `[H, U]`, where `H` is a matrix of the same domain type as `A`, and `U` is a corresponding transformation matrix.

## Algorithms

If  $A$  is an  $n \times n$  matrix with coefficients in  $\mathbb{Z}$  then its Hermite normal form is an  $n \times n$  matrix  $H = (h_{ij})$ , such that  $H = AU$  with  $|U| = \pm 1$ .

The Hermite normal form  $H$  is unique if  $A$  is matrix of full row rank. The matrix  $U$  is not unique.

If  $A$  is a square matrix, then the product of the diagonal elements of its Hermite normal form is, up to the sign, the determinant of  $A$ .

## See Also

### MuPAD Functions

`linalg::frobeniusForm` | `linalg::jordanForm` | `linalg::smithForm` | `lllint`

# linalg::hessenberg

Hessenberg matrix

## Syntax

```
linalg::hessenberg(A, <All>)
```

## Description

`linalg::hessenberg(A)` returns an (upper) Hessenberg matrix  $H$ .

`linalg::hessenberg` uses Gaussian elimination without pivoting. There is no special implementation for matrices with floating-point components.

The component ring of  $A$  must be a field, i.e., a domain of category `Cat::Field`.

## Examples

### Example 1

Consider the matrix:

```
A := Dom::Matrix(Dom::Rational)(
  [[0, 1, 0, -1], [-4/3, 2/3, 5/3, -1/3],
   [-1, 2, 0, 0], [-5/3, 4/3, 1/3, 1/3]]
)
```

$$\begin{pmatrix} 0 & 1 & 0 & -1 \\ -\frac{4}{3} & \frac{2}{3} & \frac{5}{3} & -\frac{1}{3} \\ -1 & 2 & 0 & 0 \\ -\frac{5}{3} & \frac{4}{3} & \frac{1}{3} & \frac{1}{3} \end{pmatrix}$$

The following Hessenberg matrix is similar to  $A$ :

```
H := linalg::hessenberg(A)
```

$$\begin{pmatrix} 0 & -\frac{1}{4} & -\frac{1}{7} & -1 \\ -\frac{4}{3} & \frac{3}{2} & \frac{34}{21} & -\frac{1}{3} \\ 0 & \frac{7}{8} & -\frac{17}{14} & \frac{1}{4} \\ 0 & 0 & -\frac{72}{49} & \frac{5}{7} \end{pmatrix}$$

If the corresponding transformation matrix is needed as well, call `linalg::hessenberg` with option `All`:

```
[H, P] := linalg::hessenberg(A, All)
```

$$\left[ \begin{pmatrix} 0 & -\frac{1}{4} & -\frac{1}{7} & -1 \\ -\frac{4}{3} & \frac{3}{2} & \frac{34}{21} & -\frac{1}{3} \\ 0 & \frac{7}{8} & -\frac{17}{14} & \frac{1}{4} \\ 0 & 0 & -\frac{72}{49} & \frac{5}{7} \end{pmatrix}, \begin{pmatrix} 1 & 0 & 0 & 0 \\ 0 & 1 & 0 & 0 \\ 0 & -\frac{3}{4} & 1 & 0 \\ 0 & -\frac{8}{7} & -\frac{1}{7} & 1 \end{pmatrix} \right]$$

Then  $P$  is a nonsingular matrix such that the product  $PAP^{-1}$  is equal to  $H$ :

```
P * A * P^(-1)
```

$$\begin{pmatrix} 0 & -\frac{1}{4} & -\frac{1}{7} & -1 \\ -\frac{4}{3} & \frac{3}{2} & \frac{34}{21} & -\frac{1}{3} \\ 0 & \frac{7}{8} & -\frac{17}{14} & \frac{1}{4} \\ 0 & 0 & -\frac{72}{49} & \frac{5}{7} \end{pmatrix}$$

## Parameters

**A**

A square matrix of a domain of category `Cat::Matrix`

## Options

**All**

Returns the list `[H, P]` with a Hessenberg matrix  $H$  similar to  $A$  and the corresponding nonsingular transformation matrix  $P$  such that  $H = P A P^{-1}$ .

## Return Values

Matrix of the same domain type as  $A$ , or the list `[H, P]` when the option `All` is given.

## References

Reference: K.-H. Kiyek, F. Schwarz: *Lineare Algebra*. Teubner Studienbücher Mathematik, B.G. Teubner Stuttgart, Leipzig, 1999.

## Algorithms

An  $n \times n$  matrix  $A = (a_{i,j})_{1 \leq i \leq n, 1 \leq j \leq n}$  is called an (upper) *Hessenberg matrix*, if the following holds:  $a_{i,j} = 0$  for all  $i, j \in \{1, \dots, n\}$  with  $i > j$ .

For each square matrix  $A$  over a field there exists a Hessenberg matrix similar to  $A$ . In general, the upper Hessenberg matrix is not unique.

## See Also

### **MuPAD Functions**

`linalg::charpoly`

# linalg::hilbert

Hilbert matrix

## Syntax

`linalg::hilbert(n, <R>)`

## Description

`linalg::hilbert(n)` returns the  $n \times n$  Hilbert matrix  $H = (h_{i,j})_{1 \leq i \leq m, 1 \leq j \leq n}$  defined by

$$h_{i,j} = \frac{1}{(i+j-1)}.$$

The entries of Hilbert matrices are rational numbers. Note, however, that the returned matrix is not defined over the component domain `Dom::Rational`, but over the standard component domain `Dom::ExpressionField()`. Thus, no conversion is necessary when working with other functions that expect or return matrices over that component domain.

Use `linalg::hilbert(n, Dom::Rational)` to define the  $n \times n$  Hilbert matrix over the field of rational numbers.

## Examples

### Example 1

We construct the  $3 \times 3$  Hilbert matrix:

```
H := linalg::hilbert(3)
```

$$\begin{pmatrix} 1 & \frac{1}{2} & \frac{1}{3} \\ \frac{1}{2} & \frac{1}{3} & \frac{1}{4} \\ \frac{1}{3} & \frac{1}{4} & \frac{1}{5} \end{pmatrix}$$

This is a matrix of the domain `Dom::Matrix()`.

If you prefer a different component ring, the matrix may be converted to the desired domain after construction (see `coerce`, for example). Alternatively, one can specify the component ring when creating the Hilbert matrix. For example, specification of the domain `Dom::Float` generates floating-point entries:

```
H := linalg::hilbert(3, Dom::Float)
```

$$\begin{pmatrix} 1.0 & 0.5 & 0.3333333333 \\ 0.5 & 0.3333333333 & 0.25 \\ 0.3333333333 & 0.25 & 0.2 \end{pmatrix}$$

```
domtype( H )
```

```
Dom::Matrix(Dom::Float)
```

## Parameters

**n**

The dimension of the matrix: a positive integer

**R**

The component ring: a domain of category `Cat::Rng`; default: `Dom::ExpressionField()`

## Return Values

$n \times n$  matrix of the domain `Dom::Matrix(R)`.

## Algorithms

Hilbert matrices are symmetric and positive definite.



Hilbert matrices of large dimension are notoriously ill-conditioned challenging any numerical inversion scheme. However, their inverse can also be computed by a closed formula (see `linalg::invhilbert`).

## See Also

### MuPAD Functions

`linalg::invhilbert` | `linalg::invpascal` | `linalg::invvandermonde` |  
`linalg::pascal` | `linalg::toeplitz` | `linalg::toeplitzSolve` |  
`linalg::vandermonde` | `linalg::vandermondeSolve`

## `linalg::htranspose`

Hermitian transpose of a matrix

### Syntax

```
linalg::htranspose(M)
```

### Description

`linalg::htranspose(M)` computes the Hermitian transpose of the matrix  $M$ .

The Hermitian transpose of  $M$  is computed. The result is an  $n \times m$  matrix.

The  $[i, j]$ th element of the result is equal to the conjugate of the  $[j, i]$ th element of  $M$ .

### Examples

#### Example 1

We define a  $3 \times 4$  matrix:

```
A := matrix([[1, 2, 3, 4], [-I, 0, 1+I, 0], [3, 5, 6, 9]])
```

$$\begin{pmatrix} 1 & 2 & 3 & 4 \\ -i & 0 & 1+i & 0 \\ 3 & 5 & 6 & 9 \end{pmatrix}$$

Then the Hermitian transpose of  $A$  is the  $4 \times 3$  matrix:

```
linalg::htranspose(A)
```

$$\begin{pmatrix} 1 & i & 3 \\ 2 & 0 & 5 \\ 3 & 1-i & 6 \\ 4 & 0 & 9 \end{pmatrix}$$

## Parameters

**M**

$m \times n$  matrix of domain `Dom::Matrix`

## Return Values

$n \times m$  matrix of domain `Dom::Matrix`.

## Overloaded By

**M**

## Algorithms

Let  $A = (a_{i,j})_{1 \leq i \leq m, 1 \leq j \leq n}$  be an  $m \times n$  matrix. Then the Hermitian transpose of  $A$  is the  $n \times m$  matrix:

$$A^t = \begin{pmatrix} \overline{a_{1,1}} & \overline{a_{1,2}} & \cdots & \overline{a_{m,1}} \\ \overline{a_{1,2}} & \overline{a_{2,2}} & \cdots & \overline{a_{m,2}} \\ \vdots & \vdots & \ddots & \vdots \\ \overline{a_{1,n}} & \overline{a_{1,n}} & \cdots & \overline{a_{m,n}} \end{pmatrix}.$$

## See Also

### MuPAD Functions

`conjugate` | `linalg::transpose`

## `linalg::intBasis`

Basis for the intersection of vector spaces

### Syntax

```
linalg::intBasis(S1, S2, ...)
```

### Description

`linalg::intBasis(S1, S2, ...)` returns a basis for the intersection of the vector spaces spanned by the vectors in  $S_1, S_2, \dots$

The domain type of the vectors of the returned set is the domain type of the first parameter  $S_1$ .

A basis for the zero-dimensional space is the empty set or empty list, respectively.

The given vectors must be defined over the same component ring which must be a field, i.e., a domain of category `Cat::Field`.

### Examples

#### Example 1

We define three vectors  $\vec{v}_1, \vec{v}_2, \vec{v}_3$  in  $\mathbb{Q}^2$ :

```
MatQ := Dom::Matrix(Dom::Rational):  
v1 := MatQ([[3, -2]]); v2 := MatQ([[1, 0]]); v3 := MatQ([[5, -3]])
```

$(3 \ -2)$

$(1 \ 0)$

$$(5 \ -3)$$

A basis for the vector space  $V_1 \cap V_2 \cap V_3$  with

- $V_1$  generated by  $\vec{v}_1, \vec{v}_2, \vec{v}_3$
- $V_2$  generated by  $\vec{v}_1, \vec{v}_3$
- $V_3$  generated by  $\vec{v}_1 + \vec{v}_2, \vec{v}_2, \vec{v}_1 + \vec{v}_3$

is:

```
linalg::intBasis([v1, v2, v3], [v1, v3], [v1 + v2, v2, v1 + v3])
```

$$[(4 \ -2), (1 \ 0)]$$

## Example 2

The intersection of the two vector spaces spanned by the vectors in  $S_1$  and  $S_2$ , respectively:

```
S1 := {matrix([[1, 0, 1, 0]]), matrix([[0, 1, 0, 1]])};
S2 := {matrix([[1, 2, 1, 1]]), matrix([[-1, -2, 1, 0]])}
```

$$\{(0 \ 1 \ 0 \ 1), (1 \ 0 \ 1 \ 0)\}$$

$$\{(-1 \ -2 \ 1 \ 0), (1 \ 2 \ 1 \ 1)\}$$

is the zero-dimensional space:

```
linalg::intBasis(S1, S2)
```

$$\emptyset$$

## Parameters

$S_1, S_2, \dots$

Either sets or lists of  $n$ -dimensional vectors (a vector is an  $n \times 1$  or  $1 \times n$  matrix of a domain of category `Cat::Matrix`)

## Return Values

Set or a list of vectors, according to the domain type of the parameter  $S_1$ .

## See Also

### MuPAD Functions

`linalg::basis` | `linalg::sumBasis`

# `linalg::inverseLU`

Computing the inverse of a matrix using LU-decomposition

## Syntax

```
linalg::inverseLU(A)
```

```
linalg::inverseLU(L, U, pivindex)
```

## Description

`linalg::inverseLU(A)` computes the inverse  $\frac{1}{A}$  of the square matrix  $A$  using LU-decomposition.

`linalg::inverseLU(L, U, pivindex)` computes the inverse of the matrix  $A = P^{-1}LU$  where  $L$ ,  $U$  and  $pivindex$  are the result of an LU-decomposition of the (nonsingular) Matrix  $A$ , as computed by `linalg::factorLU`.

The matrix  $A$  must be nonsingular.

`pivindex` is a list  $[r[1], r[2], \dots]$  representing a permutation matrix  $P$  such that  $B = PA = LU$ , where  $b_{ij} = a_{r_i, j}$ .

It is not checked whether `pivindex` has such a form.

The component ring of the input matrices must be a field, i.e., a domain of category `Cat::Field`.

## Examples

### Example 1

We compute the inverse of the matrix:

```
A := Dom::Matrix(Dom::Real)(  
  [[2, -3, -1], [1, 1, -1], [0, 1, -1]]  
)
```

$$\begin{pmatrix} 2 & -3 & -1 \\ 1 & 1 & -1 \\ 0 & 1 & -1 \end{pmatrix}$$

using LU-decomposition:

```
Ai := linalg::inverseLU(A)
```

$$\begin{pmatrix} 0 & 1 & -1 \\ -\frac{1}{4} & \frac{1}{2} & -\frac{1}{4} \\ -\frac{1}{4} & \frac{1}{2} & -\frac{5}{4} \end{pmatrix}$$

We check the result:

```
A * Ai, Ai * A
```

$$\begin{pmatrix} 1 & 0 & 0 \\ 0 & 1 & 0 \\ 0 & 0 & 1 \end{pmatrix}, \begin{pmatrix} 1 & 0 & 0 \\ 0 & 1 & 0 \\ 0 & 0 & 1 \end{pmatrix}$$

We can also compute the inverse of  $A$  in the usual way:

```
1/A
```

$$\begin{pmatrix} 0 & 1 & -1 \\ -\frac{1}{4} & \frac{1}{2} & -\frac{1}{4} \\ -\frac{1}{4} & \frac{1}{2} & -\frac{5}{4} \end{pmatrix}$$

`linalg::inverseLU` should be used for efficiency reasons in the case where an LU decomposition of a matrix already is computed, as the next example illustrates.



## Example 2

If we already have an LU decomposition of a (nonsingular) matrix, we can compute the inverse of the matrix  $A = P^{-1}LU$  as follows:

```
LU := linalg::factorLU(linalg::hilbert(3))
```

$$\left[ \left( \begin{pmatrix} 1 & 0 & 0 \\ \frac{1}{2} & 1 & 0 \\ \frac{1}{3} & 1 & 1 \end{pmatrix}, \begin{pmatrix} 1 & \frac{1}{2} & \frac{1}{3} \\ 0 & \frac{1}{12} & \frac{1}{12} \\ 0 & 0 & \frac{1}{180} \end{pmatrix}, [1, 2, 3] \right)$$

```
linalg::inverseLU(op(LU))
```

$$\begin{pmatrix} 9 & -36 & 30 \\ -36 & 192 & -180 \\ 30 & -180 & 180 \end{pmatrix}$$

`linalg::inverseLU` then only needs to perform forward and backward substitution to compute the inverse matrix (see also `linalg::matlinsolveLU`).

## Parameters

**A, L, U**

A square matrix of a domain of category `Cat::Matrix`

**pivindex**

A list of positive integers

## Return Values

Matrix of the same domain type as A or L, respectively.

## See Also

### MuPAD Functions

`_invert` | `linalg::factorLU` | `linalg::matlinsolveLU`

# linalg::invhilbert

Inverse of a Hilbert matrix

## Syntax

`linalg::invhilbert(n, <R>)`

## Description

`linalg::invhilbert(n)` returns the inverse of the  $n \times n$  Hilbert matrix  $H$ . The  $n \times n$

Hilbert matrix  $H = (h_{i,j})_{1 \leq i \leq m, 1 \leq j \leq n}$  is defined by  $h_{i,j} = \frac{1}{(i+j-1)}$ .

`linalg::invhilbert` uses an explicit formula for the inverse.

Note that the entries of the inverse of a Hilbert matrix are integers. But the returned matrix is defined over the standard component domain `Dom::ExpressionField()` so that no conversion is necessary when working with other functions that expect or return matrices over that component domain.

`linalg::invhilbert(n, Dom::Integer)` returns the inverse of the  $n \times n$  Hilbert matrix defined over the integers.

## Examples

### Example 1

We compute the inverse of the  $3 \times 3$  Hilbert matrix:

```
A := linalg::invhilbert(3)
```

$$\begin{pmatrix} 9 & -36 & 30 \\ -36 & 192 & -180 \\ 30 & -180 & 180 \end{pmatrix}$$

This is a matrix of the domain `Dom::Matrix()`.

If you prefer a different component ring, the matrix may be converted into the desired domain afterwards (see `coerce`, for example). Alternatively, one can specify the component ring when calling `linalg::invhilbert`, for example the domain `Dom::Float`:

```
A := linalg::invhilbert(3, Dom::Float)
```

$$\begin{pmatrix} 9.0 & -36.0 & 30.0 \\ -36.0 & 192.0 & -180.0 \\ 30.0 & -180.0 & 180.0 \end{pmatrix}$$

```
domtype( A )
```

```
Dom::Matrix(Dom::Float)
```

## Parameters

**n**

The dimension of the matrix: a positive integer

**R**

The component ring: a domain of category `Cat::Rng`; default: `Dom::ExpressionField()`

## Return Values

$n \times n$  matrix of the domain `Dom::Matrix(R)`.

## References

N.J. Higham, Accuracy and Stability of Numerical Algorithms, SIAM 1996

## Algorithms

Hilbert matrices of large dimension are notoriously ill-conditioned, challenging any numerical inversion scheme.

`linalg::invhilbert` uses the formula

$$\left(\frac{1}{H}\right)_{i,j} = \frac{(-1)^{i+j} (c_i c_j)}{i+j-1}$$

where

$$c_i = \frac{(n+i-1)!}{(n-i)! ((i-1)!)^2}$$

for the inverse of the  $n \times n$  Hilbert matrix  $H$ . All entries of  $\frac{1}{H}$  are integers.

## See Also

### MuPAD Functions

`linalg::hilbert` | `linalg::invpascal` | `linalg::invvandermonde` |  
`linalg::pascal` | `linalg::toeplitz` | `linalg::toeplitzSolve` |  
`linalg::vandermonde` | `linalg::vandermondeSolve`

# `linalg::invpascal`

Inverse of a Pascal matrix

## Syntax

`linalg::invpascal(n, <R>)`

## Description

`linalg::invpascal(n)` returns the inverse of the  $n \times n$  Pascal matrix on page 15-183.

The entries of inverse Pascal matrices are integer numbers. Note, however, that the returned matrix is not defined over the component domain `Dom::Integer`, but over the standard component domain `Dom::ExpressionField()`. Thus, no conversion is necessary when working with other functions that expect or return matrices over that component domain.

The runtime to compute the inverse  $n \times n$  Pascal matrix via `linalg::invpascal` is  $O(n^2)$ . This is much faster than inverting the Pascal matrix by a generic inversion algorithm.

The Pascal matrices are provided by `linalg::pascal`.

## Examples

### Example 1

We construct the inverse  $3 \times 3$  Pascal matrix:

```
linalg::invpascal(3)
```

$$\begin{pmatrix} 3 & -3 & 1 \\ -3 & 5 & -2 \\ 1 & -2 & 1 \end{pmatrix}$$

This is a matrix of the domain `Dom::Matrix()`.

If you prefer a different component ring, the matrix may be converted to the desired domain after construction (see `coerce`, for example). Alternatively, one can specify the component ring when creating the inverse Pascal matrix. For example, specification of the domain `Dom::Float` generates floating-point entries:

```
linalg::invpascal(3, Dom::Float)
```

$$\begin{pmatrix} 3.0 & -3.0 & 1.0 \\ -3.0 & 5.0 & -2.0 \\ 1.0 & -2.0 & 1.0 \end{pmatrix}$$

```
domtype(%)
```

```
Dom::Matrix(Dom::Float)
```

## Parameters

**n**

The dimension of the matrix: a positive integer

**R**

The component ring: a domain of category `Cat::Rng`; default: `Dom::ExpressionField()`

## Return Values

$n \times n$  matrix of the domain `Dom::Matrix(R)`.

## Algorithms

Pascal matrices and their inverses are symmetric and positive definite.

The determinant of a Pascal matrix and its inverse is 1.

The inverse of a Pascal matrix has integer entries.

If  $\lambda$  is an eigenvalue of a Pascal matrix/inverse Pascal matrix, then  $\frac{1}{\lambda}$  is also an eigenvalue of the matrix.

The entries  $Q_{ij}$  of the inverse  $n \times n$  Pascal matrix  $Q$  satisfy the linear relation

$$Q_{i,j} = Q_{i,j+1} + Q_{i+1,j} + (-1)^{i+j} \binom{n}{i} \binom{n}{j}.$$

This relation is used by `linalg::invpascal` to compute the matrix.

## See Also

### MuPAD Functions

`linalg::hilbert` | `linalg::invhilbert` | `linalg::invvandermonde` |  
`linalg::pascal` | `linalg::toeplitz` | `linalg::toeplitzSolve` |  
`linalg::vandermonde` | `linalg::vandermondeSolve`



# linalg::isHermitian

Checks whether a matrix is Hermitian

## Syntax

```
linalg::isHermitian(A)
```

## Description

`linalg::isHermitian(A)` determines whether the matrix  $A$  is Hermitian, i.e., whether  $A = \overline{A}^t$ , where  $\overline{A}$  denotes the conjugate matrix.

If the component ring of the matrix  $A$  does not provide the method "conjugate", then  $A$  is tested for symmetry, i.e., `linalg::isHermitian` returns TRUE if and only if  $A$  satisfies the equation  $A = A^t$ .

## Examples

### Example 1

Here is an example of a Hermitian matrix:

```
A := Dom::Matrix(Dom::Complex)([[1, I], [-I, 1]])
```

$$\begin{pmatrix} 1 & i \\ -i & 1 \end{pmatrix}$$

```
linalg::isHermitian(A)
```

```
TRUE
```

The following matrix is not Hermitian:

```
B := Dom::Matrix(Dom::Complex)([[1, -I], [-I, 1]])
```

$$\begin{pmatrix} 1 & -i \\ -i & 1 \end{pmatrix}$$

```
linalg::isHermitian(B)
```

FALSE

The reason is the following:

```
linalg::transpose(conjugate(B)) <> B
```

$$\begin{pmatrix} 1 & i \\ i & 1 \end{pmatrix} \neq \begin{pmatrix} 1 & -i \\ -i & 1 \end{pmatrix}$$

## Example 2

Here is an example of a symmetric matrix over the integers:

```
C := Dom::Matrix(Dom::Integer)([[1, 2], [2, -1]])
```

$$\begin{pmatrix} 1 & 2 \\ 2 & -1 \end{pmatrix}$$

```
linalg::isHermitian(C)
```

TRUE

## Parameters

**A**

A square matrix of a domain of category `Cat::Matrix`

## Return Values

Either TRUE or FALSE.

## See Also

### **MuPAD Functions**

`linalg::isPosDef`

## `linalg::isPosDef`

Test a matrix for positive definiteness

### Syntax

```
linalg::isPosDef(A)
```

### Description

`linalg::isPosDef(A)` checks whether the matrix  $A$  is positive definite, so that

$\vec{x}^t A \vec{x} > 0$  for arbitrary vectors  $\vec{x} \neq \vec{0}$ .

The component ring of  $A$  must be a field, i.e., a domain of category `Cat::Field`.

An error message is returned, if a result of an intermediate computation cannot be checked for being positive (which could happen, for example, if components of  $A$  are symbolic).

### Environment Interactions

Properties of identifiers are taken into account.

### Examples

#### Example 1

Here is an example of a positive definite matrix:

```
MatR := Dom::Matrix( Dom::Real ):  
A := MatR([[14, 6, 9], [6, 17, -4], [9, -4, 13]])
```

$$\begin{pmatrix} 14 & 6 & 9 \\ 6 & 17 & -4 \\ 9 & -4 & 13 \end{pmatrix}$$

```
linalg::isPosDef(A)
```

```
TRUE
```

The following matrix is not positive definite:

```
B := MatR([[1, 2, 3], [2, 3, 4], [5, 6, 7]])
```

$$\begin{pmatrix} 1 & 2 & 3 \\ 2 & 3 & 4 \\ 5 & 6 & 7 \end{pmatrix}$$

```
linalg::isPosDef(B)
```

```
FALSE
```

## Example 2

`linalg::isPosDef` in general does not work for matrices with symbolic entries. It may respond with an error message (because the system in general cannot decide whether a symbolic component is positive), such as for the following matrix:

```
delete a, b:
C := matrix([[a, b], [b, a]])
```

$$\begin{pmatrix} a & b \\ b & a \end{pmatrix}$$

```
linalg::isPosDef(C)
```

```
Error: Unable to check whether the matrix component is positive. [linalg::factorCholesk
```

However, properties of identifiers are taken into account, so that, for example, `linalg::isPosDef` is able to perform the test correctly for the following matrix:

```
assume(a > 1): C := matrix([[a, 1], [1, a]]):  
linalg::isPosDef(C)
```

**TRUE**

Note that such computations depend on the power of the underlying property mechanism implemented in the property library.

## Parameters

**A**

A matrix of a domain of category `Cat::Matrix`

## Return Values

Either `TRUE` or `FALSE`.

## See Also

### MuPAD Functions

`linalg::factorCholesky` | `linalg::isHermitian`

# linalg::isUnitary

Test whether a matrix is unitary

## Syntax

```
linalg::isUnitary(A)
```

## Description

`linalg::isUnitary` tests whether the matrix  $A$  is a unitary matrix. An  $n \times n$  matrix  $A$  is unitary, if  $A \overline{A}^t = I_n$ , where  $I_n$  is the  $n \times n$  identity matrix.

The square matrix  $A$  is a unitary matrix, if and only if the columns of  $A$  form an orthonormal basis with respect to the scalar product `linalg::scalarProduct` of two vectors.

The correctness of the result `FALSE` of `linalg::isUnitary` can only be guaranteed if the elements of the component ring  $R$  of the matrix  $A$  are canonically represented, i.e., if each element of  $R$  has only one unique representation.

The axiom `Ax::canonicalRep` states that a domain has this property. Hence, `linalg::isUnitary` returns `FALSE` or `UNKNOWN`, respectively, depending on whether the component ring of  $A$  has the axiom `Ax::canonicalRep`.

If the component ring of  $A$  does not define the method "conjugate" then it is checked whether  $A$  is an orthogonal matrix such that  $AA^t = E_n$ , where  $E_n$  is the  $n \times n$  identity matrix.

## Examples

### Example 1

The following matrix is unitary:

```
A := 1/sqrt(5) * matrix([[1, 2], [2, -1]])
```

$$\begin{pmatrix} \frac{\sqrt{5}}{5} & \frac{2\sqrt{5}}{5} \\ \frac{2\sqrt{5}}{5} & -\frac{\sqrt{5}}{5} \end{pmatrix}$$

```
linalg::isUnitary(A)
```

```
TRUE
```

## Parameters

**A**

A square matrix of a domain of category `Cat::Matrix`

## Return Values

Either TRUE, FALSE, or UNKNOWN.

## See Also

### MuPAD Functions

`linalg::orthog` | `linalg::scalarProduct`



# linalg::jordanForm

Jordan normal form of a matrix

## Syntax

`linalg::jordanForm(A, <All>)`

## Description

`linalg::jordanForm(A)` returns the Jordan normal form  $J$  of the matrix  $A$ .

`linalg::jordanForm` computes a nonsingular transformation matrix  $P$  and a matrix  $J$  such that  $A = PJP^{-1}$  with  $J = \text{diag}(J_1, \dots, J_r)$  and Jordan matrices  $J_1, \dots, J_r$ .

The Jordan normal form of a square matrix  $A$  over a field  $F$  exists if the characteristic polynomial of  $A$  splits over  $F$  into linear factors. If this is not the case for the matrix  $A$ , then `linalg::jordanForm` returns FAIL.

The Jordan normal form is unique up to permutations of the Jordan matrices  $J_1, \dots, J_r$ .

The implemented method computes the eigenvalues of  $A$ . It returns FAIL if this is not possible (see `linalg::eigenvalues`).

The component ring of  $A$  must be a field, i.e., a domain of category `Cat::Field`.

## Examples

### Example 1

The Jordan normal form of the matrix:

```
A := Dom::Matrix(Dom::Complex)([[1, 2], [4, 5]])
```

$$\begin{pmatrix} 1 & 2 \\ 4 & 5 \end{pmatrix}$$

is the following matrix:

```
J := linalg::jordanForm(A)
```

$$\begin{pmatrix} -2\sqrt{3}+3 & 0 \\ 0 & 2\sqrt{3}+3 \end{pmatrix}$$

The corresponding transformation matrix  $P$  can be obtained from the result  $[J, P]$  of `linalg::jordanForm` with the option `All`:

```
P := linalg::jordanForm(A, All)[2]
```

$$\begin{pmatrix} -\frac{\sqrt{3}}{2} - \frac{1}{2} & \frac{\sqrt{3}}{2} - \frac{1}{2} \\ 1 & 1 \end{pmatrix}$$

We check the result:

```
map(P * J * P^(-1), ratsimp)
```

$$\begin{pmatrix} 1 & 2 \\ 4 & 5 \end{pmatrix}$$

To get this result we must apply the function `ratsimp` to each component of the matrix that is returned by the matrix product  $PJP^{-1}$ .

## Parameters

**A**

A square matrix of a domain of category `Cat::Matrix`

## Options

### All

Returns the list [J, P] with the Jordan normal form  $J$  of  $A$  and the corresponding transformation matrix  $P$  such that  $A = PJP^{-1}$ .

## Return Values

Either a matrix of the same domain type as  $A$ , the list [J, P] when the option All is given, or the value FAIL.

## See Also

### MuPAD Functions

`linalg::eigenvalues` | `linalg::frobeniusForm` | `linalg::hermiteForm` |  
`linalg::smithForm`

# linalg::kroneckerProduct

Kronecker product of matrices

## Syntax

`linalg::kroneckerProduct(A, <B, ...>)`

## Description

`linalg::kroneckerProduct(A, B)` computes the Kronecker product of two matrices A and B.

The Kronecker product (direct matrix product) of an  $m \times n$  matrix A and a  $p \times q$  matrix B is the  $(m p) \times (n q)$  matrix  $A \otimes B$  given in block form as

$$A \otimes B = \begin{pmatrix} a_{1,1} B & \dots & a_{1,n} B \\ \vdots & & \vdots \\ a_{m,1} B & \dots & a_{m,n} B \end{pmatrix}.$$

Componentwise:  $A \otimes B_{I,J} = A_{i,j} B_{k,l}$  with  $I = p(i-1) + k, J = q(j-1) + l$ .

If A and B are matrices of the same matrix domain with the same component ring, the result is a matrix of the same type as A and B. If the domains or the component rings of A and B differ, `linalg::kroneckerProduct` tries to convert B into the domain type of A by `A::dom::coerce`. If this fails, conversion of A to the domain type of B is attempted. If no conversion is possible, an error is raised.

---

**Note** Note that the Kronecker product is only implemented for matrices over the domains `Dom::Matrix`, `Dom::SquareMatrix` or `Dom::MatrixGroup`. In particular, this includes matrices created by `matrix`.

---

A call with more than two arguments produces `linalg::kroneckerProduct(A, B, C) = linalg::kroneckerProduct(linalg::kroneckerProduct(A, B), C)` etc.

A call with only one argument is possible. It returns the input matrix.

## Examples

### Example 1

We consider two matrices A and B with symbolic components:

```
A:= matrix([[a11, a12], [a21, a22]]);
B:= matrix([[b11, b12, b13], [b21, b22, b23]]);
```

$$\begin{pmatrix} a_{11} & a_{12} \\ a_{21} & a_{22} \end{pmatrix}$$

$$\begin{pmatrix} b_{11} & b_{12} & b_{13} \\ b_{21} & b_{22} & b_{23} \end{pmatrix}$$

The Kronecker product of A and B is computed by multiplying the matrix B with each of the components of the matrix A. The resulting block matrix is returned as a matrix of larger dimension:

```
linalg::kroneckerProduct(A, B);
```

$$\begin{pmatrix} a_{11} b_{11} & a_{11} b_{12} & a_{11} b_{13} & a_{12} b_{11} & a_{12} b_{12} & a_{12} b_{13} \\ a_{11} b_{21} & a_{11} b_{22} & a_{11} b_{23} & a_{12} b_{21} & a_{12} b_{22} & a_{12} b_{23} \\ a_{21} b_{11} & a_{21} b_{12} & a_{21} b_{13} & a_{22} b_{11} & a_{22} b_{12} & a_{22} b_{13} \\ a_{21} b_{21} & a_{21} b_{22} & a_{21} b_{23} & a_{22} b_{21} & a_{22} b_{22} & a_{22} b_{23} \end{pmatrix}$$

```
delete A, B;
```

## Example 2

An  $n \times n$  matrix  $H$  with components in  $\{-1, 1\}$  is called a *Hadamard matrix* if  $H$  multiplied with its transpose equals  $n$  times the  $n \times n$  identity matrix. The matrix  $H$  defined below is a Hadamard matrix:

```
H:= matrix([[1, 1], [1, -1]]);  
H * linalg::transpose(H) = 2 * matrix::identity(2);
```

$$\begin{pmatrix} 1 & 1 \\ 1 & -1 \end{pmatrix}$$

$$\begin{pmatrix} 2 & 0 \\ 0 & 2 \end{pmatrix} = \begin{pmatrix} 2 & 0 \\ 0 & 2 \end{pmatrix}$$

Hadamard matrices play a role in the field of error correcting codes. A basic property of this type of matrices is that the Kronecker product of two Hadamard matrices is again a Hadamard matrix. We verify this statement for the matrix  $H$ :

```
H2:= linalg::kroneckerProduct(H, H);
```

$$\begin{pmatrix} 1 & 1 & 1 & 1 \\ 1 & -1 & 1 & -1 \\ 1 & 1 & -1 & -1 \\ 1 & -1 & -1 & 1 \end{pmatrix}$$

Indeed, the matrix  $H2$  is again a Hadamard matrix:

```
H2 * linalg::transpose(H2) = 4 * matrix::identity(4);
```

$$\begin{pmatrix} 4 & 0 & 0 & 0 \\ 0 & 4 & 0 & 0 \\ 0 & 0 & 4 & 0 \\ 0 & 0 & 0 & 4 \end{pmatrix} = \begin{pmatrix} 4 & 0 & 0 & 0 \\ 0 & 4 & 0 & 0 \\ 0 & 0 & 4 & 0 \\ 0 & 0 & 0 & 4 \end{pmatrix}$$

```
delete H, H2;
```

## Parameters

A, B, ...

Matrices of the domains `Dom::Matrix`, `Dom::SquareMatrix` or `Dom::MatrixGroup`

## Return Values

Matrix of the same type as A or B.

# linalg::matdim

Dimension of a matrix

## Syntax

```
linalg::matdim(A)
```

## Description

`linalg::matdim(A)` returns the dimension of the matrix  $A$ , i.e., the number of rows and columns of  $A$ .

`linalg::matdim` is an interface function for the method "matdim" of the matrix domain of  $A$ , i.e., instead of `linalg::matdim(A)` one may call `A::dom::matdim(A)` directly.

## Examples

### Example 1

The dimension of the matrix:

```
A := matrix([[1, 2, 3, 4], [3, 1, 4], [5, 6]])
```

$$\begin{pmatrix} 1 & 2 & 3 & 4 \\ 3 & 1 & 4 & 0 \\ 5 & 6 & 0 & 0 \end{pmatrix}$$

can be determined by:

```
linalg::matdim(A)
```

```
[3, 4]
```



## Parameters

**A**

An  $m \times n$  matrix of a domain of category `Cat::Matrix`

## Return Values

List `[m, n]`, where `m` is the number of rows and `n` is the number of columns of `A`.

## See Also

### MuPAD Functions

`linalg::ncols` | `linalg::nrows` | `linalg::vecdim`

## Topics

“Compute Dimensions of a Matrix” (Symbolic Math Toolbox)

## `linalg::matlinsolve`

Solving systems of linear equations

### Syntax

```
linalg::matlinsolve(A, b, <list>, options)
```

```
linalg::matlinsolve(A, B, options)
```

```
linalg::matlinsolve(A, options)
```

### Description

`linalg::matlinsolve(A, b)` computes the general solution of the equation  $A \vec{x} = \vec{b}$ .

`linalg::matlinsolve(A, b)` returns the solution vector  $\vec{x}$  of the system  $A \vec{x} = \vec{b}$  if it is a unique solution.

`linalg::matlinsolve(A, b)` returns a list  $[\vec{w}, [\vec{v}_1, \dots, \vec{v}_r]]$  if the system  $A \vec{x} = \vec{b}$  has more than one solution, where  $\vec{w}$  is one particular solution, i.e.,  $A \vec{w} = \vec{b}$  and  $\vec{v}_1, \dots, \vec{v}_r$  form a basis of the kernel of A, i.e., the solution space of the homogenous system  $A \vec{x} = (\vec{0})$ .

Each solution  $\vec{x}$  has the form  $\vec{x}_s + s_1 \vec{v}_1 + \dots + s_r \vec{v}_r$  ( $r \leq n$ ) with certain scalars  $s_1, \dots, s_r$ .

A list of  $n$  scalars  $[s_1, \dots, s_n]$  may be passed as the additional parameter `list`. This

extracts the solution  $\vec{x}_s + s_{i_1} \vec{v}_1 + \dots + s_{i_r} \vec{v}_r$  with  $\{i_1, \dots, i_r\} = \{1, \dots, n\} \setminus \{j_1, \dots, j_l\}$  from the solution space of the system  $A \vec{x} = \vec{b}$ , where  $j_1, \dots, j_l$  are the characteristic column indices of A (see `linalg::gaussJordan`).

The entries of `list` are converted to elements of the component ring of  $A$  (an error message is returned if this is not possible).

---

**Note** This option should only be used for exact and symbolic computations. In the case that  $A$  or  $b$  contains floating-point entries, it should not be used.

---

If the system  $A \vec{x} = \vec{b}$  has no solution, then the empty list `[]` is returned.

`linalg::matlinsolve(A)` solves the matrix equation  $C \vec{x} = \vec{b}$ , where  $\vec{b}$  is the last column of  $A$  and  $C$  is  $A$  with the last column deleted.

`linalg::matlinsolve(A, B)` returns the solution  $X$  of the matrix equation  $AX = B$ , if it has exactly one solution. Otherwise the empty list `[]` is returned.

The vector  $b$  and the matrix  $B$  respectively, are converted into the domain `Dom::Matrix(R)`, where  $R$  is the component ring of  $A$ . Solution vectors also belong to this domain.

The component ring of  $A$  must be an integral domain, i.e., a domain of category `Cat::IntegralDomain`.

`linalg::matlinsolve` can compute the general solution for systems with more than one solution only over fields, i.e., component rings of category `Cat::Field`. If in this case the component ring of  $A$  does not have a canonical representation of the zero element, then it may happen that `linalg::matlinsolve` does not find a basis for the null space. In such a case, a wrong result is returned.

`linalg::matlinsolve` does exploit a sparse structure of  $A$ . (A matrix is *sparse* if it has many zero components). See “Example 5” on page 15-135 (Symbolic Math Toolbox).

Use the function `numeric::matlinsolve` to solve a linear system numerically.

## Examples

### Example 1

Solve the linear system:

$$\begin{pmatrix} 1 & 2 \\ -1 & 2 \end{pmatrix} \vec{x} = \begin{pmatrix} 1 \\ -1 \end{pmatrix}$$

over the reals. First, enter the coefficient matrix and the right side:

```
MatR := Dom::Matrix(Dom::Real):  
A := MatR([[1, 2], [-1, 2]]); b := MatR([1, -1])
```

$$\begin{pmatrix} 1 & 2 \\ -1 & 2 \end{pmatrix}$$

$$\begin{pmatrix} 1 \\ -1 \end{pmatrix}$$

Next, call `linalg::matlinsolve` to solve the system:

```
x := linalg::matlinsolve(A, b)
```

$$\begin{pmatrix} 1 \\ 0 \end{pmatrix}$$

The system has exactly one solution. The vector  $x$  satisfies the matrix equation given above:

```
A * x
```

$$\begin{pmatrix} 1 \\ -1 \end{pmatrix}$$

## Example 2

The system:

$$\begin{pmatrix} 1 & 2 \\ -1 & -2 \end{pmatrix} \vec{x} = \begin{pmatrix} 1 \\ 1 \end{pmatrix}$$

does not have a solution over  $\mathbb{R}$  (in fact, over no component domain):

```
MatR := Dom::Matrix(Dom::Real):
A := MatR([[1, 2], [-1, -2]]): b := MatR([1, 0]):
linalg::matlinsolve(A, b)
```

□

### Example 3

Solve the linear system:

$$\begin{pmatrix} 1 & 1 & -4 & -7 & -6 \\ 1 & -3 & -5 & -7 \end{pmatrix} \vec{x} = \begin{pmatrix} 30 \\ 17 \end{pmatrix}$$

over the rational numbers. First, enter the coefficient matrix and the right side:

```
MatQ := Dom::Matrix(Dom::Rational):
A := MatQ([[1, 1, -4, -7, -6], [0, 1, -3, -5, -7]]):
b := MatQ([30, 17])
```

$$\begin{pmatrix} 1 & 1 & -4 & -7 & -6 \\ 0 & 1 & -3 & -5 & -7 \end{pmatrix}$$

$$\begin{pmatrix} 30 \\ 17 \end{pmatrix}$$

Next, call `linalg::matlinsolve` to solve the system:

```
sol:= linalg::matlinsolve(A, b)
```

$$\left[ \begin{pmatrix} 13 \\ 17 \\ 0 \\ 0 \\ 0 \end{pmatrix}, \left[ \begin{pmatrix} 1 \\ 3 \\ 1 \\ 0 \\ 0 \end{pmatrix}, \begin{pmatrix} 2 \\ 5 \\ 0 \\ 1 \\ 0 \end{pmatrix}, \begin{pmatrix} -1 \\ 7 \\ 0 \\ 0 \\ 1 \end{pmatrix} \right] \right]$$

The result is to be interpreted as follows: The first vector of the list `sol` is a particular solution of the linear system:

```
A * sol[1]
```

$$\begin{pmatrix} 30 \\ 17 \end{pmatrix}$$

The second entry of the list contains a basis for the null space of  $A$ , i.e., the solution space of the corresponding homogenous system  $A \vec{x} = \vec{0}$  (the kernel of  $A$ ). The basis returned is given as a list of vectors.

The following input checks this fact by computing the product  $A \vec{x}$  for each vector  $\vec{x}$  of the list `sol[2]`:

```
map(sol[2], x -> A * x)
```

$$\left[ \begin{pmatrix} 0 \\ 0 \end{pmatrix}, \begin{pmatrix} 0 \\ 0 \end{pmatrix}, \begin{pmatrix} 0 \\ 0 \end{pmatrix} \right]$$

Any solution of the linear system can be represented as a sum of a particular solution (here: `sol[1]`) and a linear combination of the basis vectors of the kernel of  $A$ . Hence the input system has an infinite number of solutions.

For example, another solution of the system is given by:

```
x := sol[1] + 1*sol[2][1] + 1/2*sol[2][2] - 2*sol[2][3]
```

$$\begin{pmatrix} 17 \\ \frac{17}{2} \\ 1 \\ \frac{1}{2} \\ -2 \end{pmatrix}$$

```
A * x
```

$$\begin{pmatrix} 30 \\ 17 \end{pmatrix}$$

If you identify the columns of the coefficient matrix  $A$  of the linear system with the variables  $x_1, x_2, x_3, x_4, x_5$ , then you see from the general solution that the variables  $x_3, x_4, x_5$  act as free parameters. They can be assigned arbitrary rational values to obtain a unique solution.

By giving a list of values for these variables as a third parameter to `linalg::matlinsolve`, you can select a certain vector from the set of all solutions of the linear system. For example, to select the same vector  $x$  as chosen in the previous input, enter:

```
linalg::matlinsolve(A, b, [0, 0, 1, 1/2, -2])
```

$$\begin{pmatrix} 17 \\ \frac{17}{2} \\ 1 \\ \frac{1}{2} \\ -2 \end{pmatrix}$$

If you are only interested in a particular solution and do not need the general solution of the linear system, enter:

```
linalg::matlinsolve(A, b, Special)
```

$$\begin{pmatrix} 13 \\ 17 \\ 0 \\ 0 \\ 0 \end{pmatrix}$$

This call suppresses the computation of the kernel of  $A$ .

## Example 4

If the linear system is given in the form of equations the function `linalg::expr2Matrix` can be used to form the corresponding matrix equation:

```
delete x, y, z:
Ab := linalg::expr2Matrix(
```

```
[x + y + z = 6, 2*x + y + 2*z = 10, x + 3*y + z = 10]  
)
```

$$\begin{pmatrix} 1 & 1 & 1 & 6 \\ 2 & 1 & 2 & 10 \\ 1 & 3 & 1 & 10 \end{pmatrix}$$

The result here is the extended coefficient matrix of the input system, that is, the right side vector  $\vec{b}$  is the 4th column vector of the matrix  $Ab$ . Since you did not specify a component ring for this matrix, the standard component ring for matrices, the domain `Dom::ExpressionField()`, was chosen.

To solve the linear system, call:

```
linalg::matlinsolve(Ab)
```

$$\left[ \begin{pmatrix} 4 \\ 2 \\ 0 \end{pmatrix}, \left[ \begin{pmatrix} -1 \\ 0 \\ 1 \end{pmatrix} \right] \right]$$

The system has an infinite number of solutions. The third variable  $z$  acts as a free parameter and therefore can have any (complex) value.

To get the general solution in parameter form, you can use parameters for the variables  $x$ ,  $y$ ,  $z$  of the input system:

```
delete u, v, w:  
sol := linalg::matlinsolve(Ab, [u, v, w])
```

$$\begin{pmatrix} 4 - w \\ 2 \\ w \end{pmatrix}$$

This is possible here because you perform the matrix computations over `Dom::ExpressionField()` which lets you compute with symbolical (arithmetical) expressions.

To select a certain vector from the set of solutions, for example, the solution for  $w = 1$ , enter:



```
x := subs(sol, w = 1)
```

$$\begin{pmatrix} 3 \\ 2 \\ 1 \end{pmatrix}$$

## Example 5

Consider a system of linear equations with a sparse structure, that is, the coefficient matrix has many zero components:

```
eqs := {x1 + x5 = 0, x2 - x4 = 1, x3 + 2*x5 = 2, x4 - x5 = -1}:
Ab := linalg::expr2Matrix(eqs, [x1, x2, x3, x4, x5])
```

$$\begin{pmatrix} 1 & 0 & 0 & 0 & 1 & 0 \\ 0 & 1 & 0 & -1 & 0 & 1 \\ 0 & 0 & 1 & 0 & 2 & 2 \\ 0 & 0 & 0 & 1 & -1 & -1 \end{pmatrix}$$

`linalg::matlinsolve` exploits the sparsity of the coefficient matrix if it is passed as a matrix of type `Dom::Matrix`. Alternatively, you can use the function `linsolve` which allows sparse input and output via symbolic equations:

```
linsolve(eqs)
```

$$[x1 = -x5, x2 = x5, x3 = 2 - 2x5, x4 = x5 - 1]$$

You also can use the function `numeric::matlinsolve` with the option `Symbolic` instead of `linalg::matlinsolve`:

```
A := linalg::delCol(Ab, 6):
b := linalg::col(Ab, 6):
numeric::matlinsolve(A, b, Symbolic)
```

$$\left[ \begin{pmatrix} 0 \\ 0 \\ 2 \\ -1 \\ 0 \end{pmatrix}, \begin{pmatrix} -1 \\ 1 \\ -2 \\ 1 \\ 1 \end{pmatrix} \right]$$

Note that the function `numeric::matlinsolve` always works over a subfield of the complex numbers and does not let you specify the domain of computation. Without the option `Symbolic`, `numeric::matlinsolve` converts input data to floating-point numbers.

### Example 6

Check whether the matrix equation

$$\begin{pmatrix} 1 & 2 \\ -2 & 3 \end{pmatrix} \vec{x} = \begin{pmatrix} 4 & 2 \\ 6 & 3 \end{pmatrix}$$

has a unique solution over the integers.

Start by entering the coefficient matrix and the right side matrix:

```
MatZ := Dom::Matrix(Dom::Integer):  
A := MatZ([[1, 2], [-2, 3]]); B := MatZ([[4, 2], [6, 3]])
```

$$\begin{pmatrix} 1 & 2 \\ -2 & 3 \end{pmatrix}$$

$$\begin{pmatrix} 4 & 2 \\ 6 & 3 \end{pmatrix}$$

Next, solve the matrix equation:

```
X := linalg::matlinsolve(A, B)
```

$$\begin{pmatrix} 0 & 0 \\ 2 & 1 \end{pmatrix}$$

The equation indeed has a unique solution (otherwise the answer of `linalg::matlinsolve` would be the empty list []). Check the result:

```
A * X
```

$$\begin{pmatrix} 4 & 2 \\ 6 & 3 \end{pmatrix}$$

## Example 7

If you use the `Normal` option, `linalg::matlinsolve` calls the `normal` function for final results. This call ensures that `linalg::matlinsolve` returns results in normalized form:

```
A := matrix([[1, s], [t, -1]]):
b := matrix([s + 1, t - 1]):
x := linalg::matlinsolve(A, b)
```

$$\begin{pmatrix} 1 \\ 1 \end{pmatrix}$$

If you specify `Normal = FALSE`, `linalg::matlinsolve` does not call `normal` for the final result:

```
x := linalg::matlinsolve(A, b, Normal = FALSE)
```

$$\begin{pmatrix} s - \frac{s(t(s+1)-t+1)}{st+1} + 1 \\ \frac{t(s+1)-t+1}{st+1} \end{pmatrix}$$

## Example 8

Solve this system:

```
A := matrix([[1, s], [1, t]]):
b := matrix([1, 1]):
linalg::matlinsolve(A, b)
```

$$\begin{pmatrix} 1 \\ 0 \end{pmatrix}$$

Note that more solutions exist for  $t = s$ . `linalg::matlinsolve` omits these solutions because it makes some additional assumptions on symbolic parameters of this system. To see the assumptions that `linalg::matlinsolve` made while solving this system, use the `ShowAssumptions` option:

```
linalg::matlinsolve(A, b, ShowAssumptions)
```

```
 $\left[\begin{pmatrix} 1 \\ 0 \end{pmatrix}, \square, \square, [t - s \neq 0]\right]$ 
```

## Parameters

### A

$m \times n$  matrix of a domain of category `Cat::Matrix`

### B

$m \times k$  matrix of a domain of category `Cat::Matrix`

### b

$m$ -dimensional column vector, i.e., a  $m \times 1$  matrix of a domain of category `Cat::Matrix`

### list

List of  $n$  elements of the component ring of A

## Options

### Normal

Option, specified as `Normal = b`

Return normalized results. The value `b` must be `TRUE` or `FALSE`. By default, `Normal = TRUE`, meaning that `linalg::matlinsolve` guarantees normalization of the returned results. Normalizing results can be computationally expensive.

By default, `linalg::matlinsolve` calls `normal` before returning results. This additional internal call ensures that the final result is normalized. This call can be computationally expensive. This option affects the output only if the solution contains variables or exact expressions, such as `sqrt(5)` or `sin(PI/7)`.

To avoid this additional call, specify `Normal = FALSE`. In this case, `linalg::matlinsolve` also can return normalized results, but does not guarantee such normalization. See “Example 7” on page 15-137 (Symbolic Math Toolbox).

### ShowAssumptions

Return information about internal assumptions that `linalg::matlinsolve` made on symbolic parameters in eqs.

With `ShowAssumptions`, `linalg::matlinsolve` returns a list `[S, KernelBasis, Constraints, Pivots]`. The lists `Constraints` and `Pivots` contain equations and inequalities involving symbolic parameters in `A` and `b` (or `B`). Internally, these were assumed to hold true when solving the system. See “Example 8” on page 15-137 (Symbolic Math Toolbox).

When Gaussian elimination produces an equation  $\theta = c$  with nonzero  $c$ , `linalg::matlinsolve` without `ShowAssumptions` returns `[]`. If  $c$  involves symbolic parameters, try using `linalg::matlinsolve` with `ShowAssumptions` to solve such systems. If the system is solvable, you will get the solution. In this case, an equation  $\theta = c$  is returned in the `Constraints` list. If the system is not solvable, `linalg::matlinsolve` with `ShowAssumptions` returns `[[], [], [], []]`.

### Special

Only one particular solution  $w$  of the system  $A \vec{x} = \vec{b}$  is returned. This suppresses the computation of a basis for the kernel of  $A$ .

### Unique

Checks whether the system has a unique solution and returns it. The return value `NIL` means that the system has more than one solution.

## Return Values

Without `ShowAssumptions`, `linalg::matlinsolve` can return a vector or a list `[S, KernelBasis]` (possibly empty), where `S` is a solution vector and `KernelBasis` is a list of basis vectors for the kernel of  $A$ . It also can return a matrix or the value `NIL`.

The matrix and the vectors, respectively, are of the domain type `Dom::Matrix(R)`, where  $R$  is the component ring of  $A$ .

With `ShowAssumptions`, `linalg::matlinsolve` returns a list `[S, KernelBasis, Constraints, Pivots]`. The lists `Constraints` and `Pivots` contain equations and inequalities involving symbolic parameters in `A` and `b` (or `B`). Internally, these were assumed to hold true when solving the system. If the system is not solvable, `linalg::matlinsolve` with `ShowAssumptions` returns `[[], [], [], []]`.

## Algorithms

Let  $A$  be an  $m \times n$  matrix with components from a field  $F$  and  $\vec{b}$  an  $m$ -dimensional vector over  $F$ . Let  $(A, \vec{b})$  be the extended coefficient matrix of the linear system  $A \vec{x} = \vec{b}$ .

Then the following holds:

- The linear system  $A \vec{x} = \vec{b}$  has a solution, if and only if  $\text{rank}(A, \vec{b}) = \text{rank}(A)$ .
- It has exactly one solution, if and only if  $\text{rank}(A, \vec{b}) = \text{rank}(A) = n$ .
- If  $\vec{x}_0$  is a solution of the system  $A \vec{x} = \vec{b}$  and  $\{\vec{v}_1, \dots, \vec{v}_r\}$  a basis of the kernel of  $A$ , then

$$L(A, \vec{b}) = \left\{ \vec{w} + \lambda_1 \vec{v}_1 + \lambda_2 \vec{v}_2 + \dots + \lambda_r \vec{v}_r \mid \lambda_1, \dots, \lambda_r \in K \right\}$$

is the set of all solutions of the linear system  $A \vec{x} = \vec{b}$ , the *general solution* of the (inhomogeneous) linear system.

The *kernel of the matrix*  $A$  is defined as:

$$\ker(A) = \left\{ \vec{w} \mid A \vec{w} = \vec{0} \right\}.$$

The kernel of  $A$  is a vector space over  $F$  of dimension  $n - \text{rank}(A)$ .

## See Also

### MuPAD Functions

`linalg::expr2Matrix` | `linalg::matlinsolveLU` | `linalg::nullspace` |  
`linalg::wiedemann` | `linsolve` | `numeric::matlinsolve`

### Topics

“Solve Algebraic Systems” (Symbolic Math Toolbox)

## `linalg::matlinsolveLU`

Solving the linear system given by an LU decomposition

### Syntax

```
linalg::matlinsolveLU(L, U, b)
```

```
linalg::matlinsolveLU(L, U, B)
```

### Description

`linalg::matlinsolveLU(L, U, b)` solves the linear system  $LU\vec{x} = \vec{b}$ , where the matrices  $L$  and  $U$  form an LU-decomposition, as computed by `linalg::factorLU`.

If the third parameter is an  $n \times k$  matrix  $B$  then the result is an  $n \times k$  matrix  $X$  satisfying the matrix equation  $LUX = B$ .

The system to be solved always has a unique solution.

The diagonal entries of the lower diagonal matrix  $L$  must be equal to one (*Doolittle*-decomposition, see `linalg::factorLU`).

`linalg::matlinsolveLU` expects  $L$  and  $U$  to be nonsingular.

`linalg::matlinsolveLU` does not check on any of the required properties of  $L$  and  $U$ .

The component ring of the matrices  $L$  and  $U$  must be a field, i.e., a domain of category `Cat::Field`.

The parameters must be defined over the same component ring.



## Examples

### Example 1

We solve the system

$$\begin{pmatrix} 2 & -3 & -1 \\ 1 & 1 & -1 \\ & 1 & -1 \end{pmatrix} X = \begin{pmatrix} 1 & & \\ & 1 & \\ & & 1 \end{pmatrix} :$$

```
MatR := Dom::Matrix(Dom::Real):
A := MatR([[2, -3, -1], [1, 1, -1], [0, 1, -1]]);
I3 := MatR::identity(3)
```

$$\begin{pmatrix} 2 & -3 & -1 \\ 1 & 1 & -1 \\ 0 & 1 & -1 \end{pmatrix}$$

$$\begin{pmatrix} 1 & 0 & 0 \\ 0 & 1 & 0 \\ 0 & 0 & 1 \end{pmatrix}$$

We start by computing an LU-decomposition of A:

```
LU := linalg::factorLU(A)
```

$$\left[ \begin{pmatrix} 1 & 0 & 0 \\ \frac{1}{2} & 1 & 0 \\ 0 & \frac{2}{5} & 1 \end{pmatrix}, \begin{pmatrix} 2 & -3 & -1 \\ 0 & \frac{5}{2} & -\frac{1}{2} \\ 0 & 0 & -\frac{4}{5} \end{pmatrix}, [1, 2, 3] \right]$$

Now we solve the system  $AX = I_3$ , which gives us the inverse of A:

```
Ai := linalg::matlinsolveLU(LU[1], LU[2], I3)
```

$$\begin{pmatrix} 0 & 1 & -1 \\ -\frac{1}{4} & \frac{1}{2} & -\frac{1}{4} \\ -\frac{1}{4} & \frac{1}{2} & -\frac{5}{4} \end{pmatrix}$$

$A * A_i, A_i * A$

$$\begin{pmatrix} 1 & 0 & 0 \\ 0 & 1 & 0 \\ 0 & 0 & 1 \end{pmatrix}, \begin{pmatrix} 1 & 0 & 0 \\ 0 & 1 & 0 \\ 0 & 0 & 1 \end{pmatrix}$$

## Parameters

**L**

An  $n \times n$  lower triangular matrix of a domain of category `Cat::Matrix`

**U**

An  $n \times n$  upper triangular form matrix of the same domain as L

**B**

An  $n \times k$  matrix of a domain of category `Cat::Matrix`

**b**

An  $n$ -dimensional column vector, i.e., an  $n \times 1$  matrix of a domain of category `Cat::Matrix`

## Return Values

$n$ -dimensional solution vector or  $n \times k$  dimensional solution matrix, respectively, of the domain type `Dom::Matrix(R)`, where R is the component ring of A.

## See Also

### MuPAD Functions

`linalg::factorLU` | `linalg::inverseLU` | `linalg::matlinsolve`

# `linalg::minpoly`

Minimal polynomial of a matrix

## Syntax

```
linalg::minpoly(A, x)
```

## Description

`linalg::minpoly(A, x)` computes the minimal polynomial of the square matrix  $A$  in  $x$ , i.e., the monic polynomial of lowest degree annihilating the matrix  $A$ .

The minimal polynomial of  $A$  divides the characteristic polynomial of  $A$ , by Cayley-Hamilton theorem.

If the matrix is defined over `Dom::Float`, then due to numerical errors the computed polynomial can have a degree higher than the dimension of the matrix. In such cases, `linalg::minpoly` returns the value `FAIL`. See “Example 3” on page 15-148 (Symbolic Math Toolbox).

The component ring of  $A$  must be a field, i.e., a domain of category `Cat::Field`.

## Examples

### Example 1

We define the following matrix over the rational numbers:

```
A := Dom::Matrix(Dom::Rational)(  
  [[0, 2, 0], [0, 0, 2], [2, 0, 0]]  
)
```

$$\begin{pmatrix} 0 & 2 & 0 \\ 0 & 0 & 2 \\ 2 & 0 & 0 \end{pmatrix}$$

The minimal polynomial of the matrix  $A$  in the variable  $x$  is then given by:

```
delete x: linalg::minpoly(A, x)
```

$$x^3 - 8$$

In this case, the minimal polynomial is in fact equal to the characteristic polynomial of  $A$ :

```
linalg::charpoly(A, x)
```

$$x^3 - 8$$

## Example 2

The minimal polynomial of the matrix:

```
B := matrix([[0, 1, 0], [0, 0, 0], [0, 0, 0]])
```

$$\begin{pmatrix} 0 & 1 & 0 \\ 0 & 0 & 0 \\ 0 & 0 & 0 \end{pmatrix}$$

is a polynomial of degree 2:

```
m := linalg::minpoly(B, x)
```

$$x^2$$

The characteristic polynomial of  $B$  has degree 3 and is divided by the minimal polynomial of  $B$ :

```
p := linalg::charpoly(B, x)
```

$$x^3$$

```
p / m
```

$x$ 

### Example 3

For the following example, MuPAD is not able to compute the minimal polynomial, and thus FAIL is returned:

```
C := Dom::Matrix(Dom::Float)([
  [7, 0, 0, 0, 0], [1, 0, 0, 0, 0], [1, 2, 0, 0, 0],
  [1, 2, 3, 0, 0], [1, 2, 3, 4, 7]
])
```

$$\begin{pmatrix} 7.0 & 0.0 & 0.0 & 0.0 & 0.0 \\ 1.0 & 0.0 & 0.0 & 0.0 & 0.0 \\ 1.0 & 2.0 & 0.0 & 0.0 & 0.0 \\ 1.0 & 2.0 & 3.0 & 0.0 & 0.0 \\ 1.0 & 2.0 & 3.0 & 4.0 & 7.0 \end{pmatrix}$$

```
delete x: linalg::minpoly(C, x)
```

```
Warning: Unable to compute minimal polynomial. [linalg::minpoly]
```

FAIL

In fact, for this example MuPAD is not able to check for zero equivalence during Gaussian elimination and therefore chose a wrong pivot element.

If you perform the computation over the coefficient domain `Dom::ExpressionField(normal)` instead, then in most cases the minimal polynomial can be computed:

```
C := matrix([
  [7, 0, 0, 0, 0], [1, 0, 0, 0, 0], [1, 2, 0, 0, 0],
  [1, 2, 3, 0, 0], [1, 2, 3, 4, 7]
])
```

$$\begin{pmatrix} 7 & 0 & 0 & 0 & 0 \\ 1 & 0 & 0 & 0 & 0 \\ 1 & 2 & 0 & 0 & 0 \\ 1 & 2 & 3 & 0 & 0 \\ 1 & 2 & 3 & 4 & 7 \end{pmatrix}$$

`linalg::minpoly(C, x)`

$$x^5 - 14x^4 + 49x^3$$

However, in general this problem regarding zero recognition cannot be avoided.

## Parameters

**A**

A square matrix of a domain of category `Cat::Matrix`

**x**

An indeterminate

## Return Values

Polynomial of the domain `Dom::DistributedPolynomial([x],R)`, where R is the component ring of A, or the value FAIL.

## See Also

### MuPAD Functions

`linalg::charpoly` | `linalg::frobeniusForm`

## `linalg::multCol`

Multiply columns with a scalar

### Syntax

```
linalg::multCol(A, c, s)
```

```
linalg::multCol(A, c1 .. c2, s)
```

```
linalg::multCol(A, list, s)
```

### Description

`linalg::multCol(A, c, s)` returns a copy of the matrix  $A$  resulting from  $A$  by multiplying the  $c$ -th column of  $A$  with the scalar  $s$ .

`linalg::multCol(A, c1.. c2, s)` returns a copy of the matrix  $A$  obtained from  $A$  by multiplying those columns whose indices are in the range  $c_1.. c_2$  with the scalar  $s$ .

`linalg::multCol(A, list, s)` returns a copy of the matrix  $A$  obtained from matrix  $A$  by multiplying those columns whose indices are contained in `list` with the scalar  $s$ .

The scalar  $s$  is converted into an element of the component ring of the matrix  $A$ . An error message is returned if the conversion fails.

### Examples

#### Example 1

We define the following matrix:

```
A := matrix([[1, 2, 3], [4, 5, 6], [7, 8, 9]])
```

$$\begin{pmatrix} 1 & 2 & 3 \\ 4 & 5 & 6 \\ 7 & 8 & 9 \end{pmatrix}$$



and illustrate the three different input formats for `linalg::multCol`:

```
linalg::multCol(A, 2, -1)
```

$$\begin{pmatrix} 1 & -2 & 3 \\ 4 & -5 & 6 \\ 7 & -8 & 9 \end{pmatrix}$$

```
linalg::multCol(A, 1..2, 2)
```

$$\begin{pmatrix} 2 & 4 & 3 \\ 8 & 10 & 6 \\ 14 & 16 & 9 \end{pmatrix}$$

```
linalg::multCol(A, [3, 1], 0)
```

$$\begin{pmatrix} 0 & 2 & 0 \\ 0 & 5 & 0 \\ 0 & 8 & 0 \end{pmatrix}$$

## Parameters

**A**

An  $m \times n$  matrix of a domain of category `Cat::Matrix`

**c**

The column index: a positive integer less or equal to  $n$

**c<sub>1</sub> .. c<sub>2</sub>**

A range of column indices (positive integers less or equal to  $n$ )

**list**

A list of column indices (positive integers less or equal to  $n$ )

## **Return Values**

Matrix of the same domain type as A.

## **See Also**

### **MuPAD Functions**

`linalg::addCol` | `linalg::addRow` | `linalg::multRow`

# linalg::multRow

Multiply rows with a scalar

## Syntax

```
linalg::multRow(A, r, s)
```

```
linalg::multRow(A, r1 .. r2, s)
```

```
linalg::multRow(A, list, s)
```

## Description

`linalg::multRow(A, r, s)` returns a copy of the matrix  $A$  resulting from  $A$  by multiplying the  $r$ -th row of  $A$  with the scalar  $s$ .

`linalg::multRow(A, r1.. r2, s)` returns a copy of the matrix  $A$  obtained from  $A$  by multiplying those rows whose indices are in the range  $r_1.. r_2$  with the scalar  $s$ .

`linalg::multRow(A, list, s)` returns a copy of the matrix  $A$  obtained from matrix  $A$  by multiplying those rows whose indices are contained in `list` with the scalar  $s$ .

The scalar  $s$  is converted into an element of the component ring of the matrix  $A$ . An error message is returned if the conversion fails.

## Examples

### Example 1

We define the following matrix:

```
A := matrix([[1, 2, 3], [4, 5, 6], [7, 8, 9]])
```

$$\begin{pmatrix} 1 & 2 & 3 \\ 4 & 5 & 6 \\ 7 & 8 & 9 \end{pmatrix}$$

and illustrate the three different input formats for `linalg::multRow`:

```
linalg::multRow(A, 2, -1)
```

$$\begin{pmatrix} 1 & 2 & 3 \\ -4 & -5 & -6 \\ 7 & 8 & 9 \end{pmatrix}$$

```
linalg::multRow(A, 1..2, 2)
```

$$\begin{pmatrix} 2 & 4 & 6 \\ 8 & 10 & 12 \\ 7 & 8 & 9 \end{pmatrix}$$

```
linalg::multRow(A, [3, 1], 0)
```

$$\begin{pmatrix} 0 & 0 & 0 \\ 4 & 5 & 6 \\ 0 & 0 & 0 \end{pmatrix}$$

## Parameters

**A**

An  $m \times n$  matrix of a domain of category `Cat::Matrix`

**r**

The row index: a positive integer less or equal to  $m$

**r<sub>1</sub> .. r<sub>2</sub>**

A range of row indices (positive integers less or equal to  $m$ )

**list**

A list of row indices (positive integers less or equal to  $m$ )

## Return Values

Matrix of the same domain type as A.

## See Also

### MuPAD Functions

`linalg::addCol` | `linalg::addRow` | `linalg::multCol`

## `linalg::ncols`

Number of columns of a matrix

### Syntax

```
linalg::ncols(A)
```

### Description

`linalg::ncols(A)` returns the number of columns of the matrix  $A$ .

### Examples

#### Example 1

The matrix:

```
A:= matrix([[1, 2, 3, 4], [3, 1, 4], [5, 6]])
```

$$\begin{pmatrix} 1 & 2 & 3 & 4 \\ 3 & 1 & 4 & 0 \\ 5 & 6 & 0 & 0 \end{pmatrix}$$

has four columns:

```
linalg::ncols(A)
```

4

## Parameters

**A**

A matrix of a domain of category `Cat::Matrix`

## Return Values

Positive integer.

## See Also

### **MuPAD Functions**

`linalg::matdim` | `linalg::nrows` | `linalg::vecdim`

## `linalg::nonZeros`

Number of non-zero elements of a matrix

### Syntax

```
linalg::nonZeros(A)
```

### Description

`linalg::nonZeros(A)` returns the number of non-zero components of the matrix  $A$ .

### Examples

#### Example 1

The matrix

```
MZ7 := Dom::Matrix(Dom::IntegerMod(7)):
A := MZ7([[18, -1], [4, 81]])
```

$$\begin{pmatrix} 4 \bmod 7 & 6 \bmod 7 \\ 4 \bmod 7 & 4 \bmod 7 \end{pmatrix}$$

has four non-zero entries:

```
linalg::nonZeros(A)
```

4

The matrix:

```
B := MZ7([[21, 2], [-1, 14]])
```



$$\begin{pmatrix} 0 \bmod 7 & 2 \bmod 7 \\ 6 \bmod 7 & 0 \bmod 7 \end{pmatrix}$$

has only two non-zero entries:

```
linalg::nonZeros(B)
```

```
2
```

## Parameters

**A**

A matrix of a domain of category `Cat::Matrix`

## Return Values

Nonnegative integer

# linalg::normalize

Normalize a vector

## Syntax

```
linalg::normalize(v)
```

## Description

`linalg::normalize(v)` normalizes the vector  $\vec{v}$  with respect to the 2-norm

$$(\|\vec{v}\|_2 = \sqrt{\langle \vec{v}, \vec{v} \rangle}).$$

The result of `linalg::normalize(v)` is a vector that has norm 1 and the same direction as  $v$ .

The scalar product  $\langle \vec{v}, \vec{v} \rangle$  for a vector  $\vec{v}$  is implemented by the function `linalg::scalarProduct`.

The norm of a vector is computed with the function `norm`, which is overloaded for vectors. See the method "norm" of the domain constructor `Dom:Matrix` for details.

If the norm is an object that cannot be converted into an element of the component ring of  $v$ , then an error occurs (see "Example 2" on page 15-161 (Symbolic Math Toolbox)).

## Examples

### Example 1

We define the following vector:

```
u := matrix([[1, 2]])
```

$$(1 \ 2)$$

Then the vector of norm 1 with the same direction as  $u$  is given by:

```
linalg::normalize(u)
```

$$\left( \frac{\sqrt{5}}{5} \quad \frac{2\sqrt{5}}{5} \right)$$

## Example 2

The following computation fails because the vector  $(1, 2)$  cannot be normalized over the rationals:

```
v := Dom::Matrix(Dom::Rational)([[1, 2]]):
linalg::normalize(v)
```

Error: Unable to normalize the given vector over its component ring. [linalg::normalize]

If we define  $v$  over the real numbers, then we get the normalized vector of  $v$  as follows:

```
w := Dom::Matrix(Dom::Real)(v): linalg::normalize(w)
```

$$\left( \frac{\sqrt{5}}{5} \quad \frac{2\sqrt{5}}{5} \right)$$

## Parameters

$v$

A vector, i.e., an  $n \times 1$  or  $1 \times n$  matrix of a domain of category `Cat::Matrix`

## Return Values

Vector of the same domain type as  $v$ .

## See Also

### MuPAD Functions

`linalg::scalarProduct` | `norm`

# `linalg::nrows`

Number of rows of a matrix

## Syntax

```
linalg::nrows(A)
```

## Description

`linalg::nrows(A)` returns the number of rows of the matrix  $A$ .

## Examples

### Example 1

The matrix:

```
A := matrix([[1, 2, 3, 4], [3, 1, 4], [5, 6]])
```

$$\begin{pmatrix} 1 & 2 & 3 & 4 \\ 3 & 1 & 4 & 0 \\ 5 & 6 & 0 & 0 \end{pmatrix}$$

has three rows:

```
linalg::nrows(A)
```

3

## Parameters

**A**

A matrix of a domain of category `Cat::Matrix`

## Return Values

Positive integer.

## See Also

### **MuPAD Functions**

`linalg::matdim` | `linalg::ncols` | `linalg::vecdim`

# linalg::nullspace

Basis for the null space of a matrix

## Syntax

```
linalg::nullspace(A)
```

## Description

`linalg::nullspace(A)` returns a basis for the null space of the matrix  $A$ , i.e., a list  $B$  of linearly independent vectors such that  $A \vec{x} = \vec{0}$  if and only if  $\vec{x}$  is a linear combination of the vectors in  $B$ .

The component ring of the matrix  $A$  must be a field, i.e., a domain of category `Cat::Field`.

If the component ring of  $A$  does not have a canonical representation of the zero element, it can happen that `linalg::nullspace` does not find a basis for the null space. In such a case, a wrong result is returned.

## Examples

### Example 1

The kernel of the matrix:

```
A := Dom::Matrix(Dom::Real)(
  [[3^(1/2)*2 - 2, 2], [4, 3^(1/2)*2 + 2]]
)
```

$$\begin{pmatrix} 2\sqrt{3}-2 & 2 \\ 4 & 2\sqrt{3}+2 \end{pmatrix}$$

is one-dimensional, and a basis is  $\left\{ \begin{pmatrix} -\frac{1}{\sqrt{3}-1} \\ 1 \end{pmatrix} \right\}$ :

`linalg::nullspace(A)`

$$\left[ \begin{pmatrix} -\frac{1}{\sqrt{3}-1} \\ 1 \end{pmatrix} \right]$$

## Parameters

**A**

A matrix of a domain of category `Cat::Matrix`

## Return Values

List of (column) vectors of the domain `Dom::Matrix(R)`, where R is the component ring of A.

## See Also

### MuPAD Functions

`linalg::basis` | `linalg::matlinsolve` | `linsolve` | `numeric::matlinsolve`

## Topics

“Compute Bases for Null Spaces of Matrices” (Symbolic Math Toolbox)



# linalg::ogCoordTab

Table of orthogonal coordinate transformations

## Syntax

```
linalg::ogCoordTab[ogName](u1, u2, u3, <C>)
```

```
linalg::ogCoordTab[ogName,  
  Transformation](u1, u2, u3, <C>)
```

```
linalg::ogCoordTab[ogName,  
  InverseTransformation](u1, u2, u3, <C>)
```

```
linalg::ogCoordTab[ogName,  
  UnitVectors](u1, u2, u3, <C>)
```

```
linalg::ogCoordTab[ogName,  
  Scales](u1, u2, u3, <C>)
```

```
linalg::ogCoordTab[ogName, Ranges](<C>)
```

```
linalg::ogCoordTab[ ogName , Dimension]
```

## Description

`linalg::ogCoordTab` is a table of predefined orthogonal coordinate transformations in  $\mathbb{R}^3$ .

The entry associated with `ogName` defines a coordinate transformation  $\vec{x} = \vec{x}(\vec{u})$  which maps the orthogonal parameters  $\vec{u} = (u_1, u_2, u_3)$  to a vector  $\vec{x} = (x_1, x_2, x_3)$  in Cartesian coordinates.

The coordinate systems `EllipticCylindrical` and `Torus` are defined with a constant parameter `c` which has to be passed as an additional argument. See “Example 2” on page 15-171 (Symbolic Math Toolbox).

The following coordinate transformations are stored in `linalg::ogCoordTab`. They are invertible for the indicated parameter values:

- Cartesian:

$$u_1 \in \mathbb{R}, u_2 \in \mathbb{R}, u_3 \in \mathbb{R}:$$

$$x_1 = u_1, x_2 = u_2, x_3 = u_3$$

- Spherical:

$$0 < u_1 < \infty, 0 \leq u_2 \leq \pi, 0 \leq u_3 < 2\pi:$$

$$x_1 = u_1 \sin(u_2) \cos(u_3), x_2 = u_1 \sin(u_2) \sin(u_3), x_3 = u_1 \cos(u_2)$$

- Spherical[LeftHanded]:

$$0 < u_1 < \infty, 0 \leq u_2 < 2\pi, 0 \leq u_3 \leq \pi:$$

$$x_1 = u_1 \cos(u_2) \sin(u_3), x_2 = u_1 \sin(u_2) \sin(u_3), x_3 = u_1 \cos(u_3)$$

- Cylindrical:

$$0 < u_1 < \infty, 0 \leq u_2 < 2\pi, u_3 \in \mathbb{R}:$$

$$x_1 = u_1 \cos(u_2), x_2 = u_1 \sin(u_2), x_3 = u_3$$

- EllipticCylindrical:

$$0 < u_1 < \infty, 0 \leq u_2 < 2\pi, u_3 \in \mathbb{R} \text{ (with a real constant } c\text{)}:$$

$$x_1 = c \cos(u_1) \cos(u_2), x_2 = c \sinh(u_1) \sin(u_2), x_3 = u_3$$

- ParabolicCylindrical:

$$0 < u_1 < \infty, u_2 \in \mathbb{R}, u_3 \in \mathbb{R}:$$

$$x_1 = \frac{(u_1^2 - u_2^2)}{2}, x_2 = u_1 u_2, x_3 = u_3$$

- RotationParabolic:

$$0 < u_1 < \infty, 0 < u_2 < \infty, 0 \leq u_3 < 2\pi:$$

$$x_1 = u_1 u_2 \cos(u_3), x_2 = u_1 u_2 \sin(u_3), x_3 = \frac{(u_1^2 - u_2^2)}{2}$$

- Torus:

$$0 < u_1 < c, 0 \leq u_2 < 2\pi, 0 \leq u_3 < 2\pi \text{ (with a positive constant } c\text{):}$$

$$x_1 = (c - u_1 \cos(u_2)) \cos(u_3), x_2 = (c - u_1 \cos(u_2)) \sin(u_3), x_3 = u_1 \sin(u_2)$$

`linalg::ogCoordTab` is used by functions such as `curl`, `divergence`, `gradient`, and `laplacian` to perform computations in non-Cartesian coordinates.

## Examples

### Example 1

The following call returns the Cartesian vector  $\vec{x} = [x, y, z]$  in terms of the right-handed spherical coordinates  $\vec{u} = [u_1, u_2, u_3]$ :

```
linalg::ogCoordTab[Spherical, Transformation](u1, u2, u3)
```

```
[u1 cos(u3) sin(u2), u1 sin(u2) sin(u3), u1 cos(u2)]
```

The spherical coordinates expressed by the Cartesian coordinates:

```
linalg::ogCoordTab[Spherical, InverseTransformation](x, y, z)
```

$$\left[ \sqrt{x^2 + y^2 + z^2}, \arccos\left(\frac{z}{\sqrt{x^2 + y^2 + z^2}}\right), \arccos\left(\frac{x}{\sqrt{x^2 + y^2}}\right) \right. \\ \left. + \text{sign}(y) (\text{sign}(y) - 1) \left( \pi - \arccos\left(\frac{x}{\sqrt{x^2 + y^2}}\right) \right) \right]$$

Note the  $\text{sign}(y)$  in the expression for  $u_3$ . This ensures that the correct angle is returned for any value of  $y$ :

```
assume(y > 0):
linalg::ogCoordTab[Spherical, InverseTransformation](x, y, z)
```

$$\left[ \sqrt{x^2 + y^2 + z^2}, \arccos\left(\frac{z}{\sqrt{x^2 + y^2 + z^2}}\right), \arccos\left(\frac{x}{\sqrt{x^2 + y^2}}\right) \right]$$

```
linalg::ogCoordTab[Spherical, InverseTransformation](1, 1, 0),
linalg::ogCoordTab[Spherical, InverseTransformation](-1, 0, 1),
linalg::ogCoordTab[Spherical, InverseTransformation](1, 0, 2),
linalg::ogCoordTab[Spherical, InverseTransformation](1, -1, 3)
```

$$\left[ \sqrt{2}, \frac{\pi}{2}, \frac{\pi}{4} \right], \left[ \sqrt{2}, \frac{\pi}{4}, \pi \right], \left[ \sqrt{5}, \arccos\left(\frac{2\sqrt{5}}{5}\right), 0 \right], \left[ \sqrt{11}, \arccos\left(\frac{3\sqrt{11}}{11}\right), \frac{7\pi}{4} \right]$$

These parameter values are from the following ranges:

```
linalg::ogCoordTab[Spherical, Ranges]()
```

$$[0.. \infty, 0.. \pi, 0.. 2\pi]$$

The following orthonormal vectors are tangent to the spherical parameter lines:

```
linalg::ogCoordTab[Spherical, UnitVectors](u1, u2, u3)
```

$$\left[ [\cos(u_3) \sin(u_2), \sin(u_2) \sin(u_3), \cos(u_2)], [\cos(u_2) \cos(u_3), \cos(u_2) \sin(u_3), -\sin(u_2)], \right. \\ \left. [-\sin(u_3), \cos(u_3), 0] \right]$$

The 'scaling factors' are:

```
linalg::ogCoordTab[Spherical,Scales](u1, u2, u3)
```

```
[1, u1, u1 sin(u2)]
```

There is the following relationship between the Jacobian of the transformation  $\vec{u} \rightarrow \vec{x}$  from the orthogonal coordinates to the Cartesian coordinates:

```
xyz:= linalg::ogCoordTab[Spherical, Transformation](u1, u2, u3):
unitvectors:= linalg::ogCoordTab[Spherical, UnitVectors](u1, u2, u3):
scales:= linalg::ogCoordTab[Spherical, Scales](u1, u2, u3):
```

```
linalg::transpose(jacobian(xyz, [u1, u2, u3])) =
  matrix(3, 3, scales, Diagonal)* matrix(unitvectors)
```

```
 $\sigma_1 = \sigma_1$ 
```

```
where
```

$$\sigma_1 = \begin{pmatrix} \cos(u_3) \sin(u_2) & \sin(u_2) \sin(u_3) & \cos(u_2) \\ u_1 \cos(u_2) \cos(u_3) & u_1 \cos(u_2) \sin(u_3) & -u_1 \sin(u_2) \\ -u_1 \sin(u_2) \sin(u_3) & u_1 \cos(u_3) \sin(u_2) & 0 \end{pmatrix}$$

```
delete y, xyz, unitvectors, scales:
```

## Example 2

The following call returns the Cartesian vector  $\vec{x} = [x, y, z]$  in terms of elliptic cylindrical coordinates  $\vec{u} = [u, v, w]$  involving a parameter  $c$ :

```
linalg::ogCoordTab[EllipticCylindrical, Transformation](u, v, z, c)
```

```
[c cosh(u) cos(v), c sinh(u) sin(v), z]
```

We compute the gradient of the function  $f(u, v, w) = x(u, v, w)$  in elliptic cylindrical coordinates  $\vec{u} = [u, v, w]$ .

```
f := (c*cos(v)*cosh(u))^2:
```

For computing the components of the gradient with respect to an orthogonal system, it is sufficient to know the 'scale parameters':

```
linalg::ogCoordTab[EllipticCylindrical, Scales](u, v, w, c)
```

$$\left[ c \sqrt{\cosh(u)^2 - \cos(v)^2}, c \sqrt{\cosh(u)^2 - \cos(v)^2}, 1 \right]$$

```
gradf := gradient(f, [u, v, w], %)
```

$$\begin{pmatrix} \frac{2 c \cosh(u) \cos(v)^2 \sinh(u)}{\sqrt{\cosh(u)^2 - \cos(v)^2}} \\ -\frac{2 c \cosh(u)^2 \cos(v) \sin(v)}{\sqrt{\cosh(u)^2 - \cos(v)^2}} \\ 0 \end{pmatrix}$$

These are the coefficients of the gradient with respect to the orthonormal basis

$\vec{e}_u, \vec{e}_v, \vec{e}_w$  returned via the option UnitVectors:

```
[e_u, e_v, e_w] :=  
linalg::ogCoordTab[EllipticCylindrical, UnitVectors](u, v, w, c)
```

$$[[\sigma_1, \sigma_2, 0], [-\sigma_2, \sigma_1, 0], [0, 0, 1]]$$

where

$$\sigma_1 = \frac{\cos(v) \sinh(u)}{\sqrt{\cosh(u)^2 - \cos(v)^2}}$$

$$\sigma_2 = \frac{\cosh(u) \sin(v)}{\sqrt{\cosh(u)^2 - \cos(v)^2}}$$

We convert the lists  $e_u$ ,  $e_v$ ,  $e_w$  into column vectors via `matrix`. Thus, in the standard basis of  $\mathbb{R}^3$ , the gradient vector field is:

```
G := gradf[1]*matrix(e_u)
+ gradf[2]*matrix(e_v)
+ gradf[3]*matrix(e_w)
```

$$\begin{pmatrix} \frac{2c \cosh(u) \cos(v)^3 \sinh(u)^2}{\cosh(u)^2 - \cos(v)^2} + \frac{2c \cosh(u)^3 \cos(v) \sin(v)^2}{\cosh(u)^2 - \cos(v)^2} \\ 0 \\ 0 \end{pmatrix}$$

$$\begin{pmatrix} \frac{2c \cosh(u) \cos(v)^3 \sinh(u)^2}{\cosh(u)^2 - \cos(v)^2} + \frac{2c \cosh(u)^3 \cos(v) \sin(v)^2}{\cosh(u)^2 - \cos(v)^2} \\ 0 \\ 0 \end{pmatrix}$$

$$\begin{pmatrix} \frac{2c \cosh(u) \cos(v)^3 \sinh(u)^2}{\cosh(u)^2 - \cos(v)^2} + \frac{2c \cosh(u)^3 \cos(v) \sin(v)^2}{\cosh(u)^2 - \cos(v)^2} \\ 0 \\ 0 \end{pmatrix}$$

We simplify this expression using the identities  $\sin^2(v) = 1 - \cos^2(v)$ ,  $\sinh^2(u) = \cosh^2(u) - 1$ :

```
normal(subs(G, sin(v)^2 = 1 - cos(v)^2,
            sinh(u)^2 = cosh(u)^2 - 1))
```

$$\begin{pmatrix} 2 c \cosh(u) \cos(v) \\ 0 \\ 0 \end{pmatrix}$$

This is the gradient of the function  $f(x, y, z) = x^2$  with  $x$  expressed by elliptic cylindrical coordinates:

```
G := gradient(x^2, [x, y, z])
```

$$\begin{pmatrix} 2 x \\ 0 \\ 0 \end{pmatrix}$$

```
[x, y, z] :=
linalg::ogCoordTab[EllipticCylindrical, Transformation](u, v, w, c)
```

$$[c \cosh(u) \cos(v), c \sinh(u) \sin(v), w]$$

```
map(G, eval)
```

$$\begin{pmatrix} 2 c \cosh(u) \cos(v) \\ 0 \\ 0 \end{pmatrix}$$

```
delete f, gradf, e_u, e_v, e_w, G, x, y, z:
```

## Parameters

### ogName

The name of a predefined coordinate system. The following 3 dimensional coordinate systems are available: Cartesian, Spherical, Spherical[LeftHanded],



Cylindrical, EllipticCylindrical, ParabolicCylindrical, RotationParabolic, Torus.

**$u_1, u_2, u_3$**

The coordinates of the orthogonal system: identifiers on page 7-29, indexed identifiers on page 1-1017, or arithmetical expressions (Symbolic Math Toolbox).

**$x_1, x_2, x_3$**

Cartesian coordinates: identifiers on page 7-29, indexed identifiers on page 1-1017, or arithmetical expressions (Symbolic Math Toolbox).

**$c$**

An arithmetical expression (Symbolic Math Toolbox). The default value is  $c = 1$ .

## Options

### Transformation

`linalg::ogCoordTab [ogName, Transformation](  $u_1, u_2, u_3, c$  )` returns a list of arithmetical expressions  $[x_1(u_1, u_2, u_3), x_2(u_1, u_2, u_3), x_3(u_1, u_2, u_3)]$  defining the transformation from the orthogonal coordinates  $u_i$  to the Cartesian coordinates  $x_j$ . The transformation is invertible if the coordinates  $u_i$  are from the range  $a_i < u_i < b_i$  where  $[a1..b1, a2..b2, a3..b3] = \text{linalg::ogCoordTab [ogName, Ranges]}(c)$ .

### InverseTransformation

`linalg::ogCoordTab [ogName, InverseTransformation](  $x_1, x_2, x_3, c$  )` returns a list of arithmetical expressions  $[u_1(x_1, x_2, x_3), u_2(x_1, x_2, x_3), u_3(x_1, x_2, x_3)]$  defining the inverse transformation. The inverse transformation produces parameter values  $u_i$  in the range  $a_i \leq u_i \leq b_i$  given by  $[a1..b1, a2..b2, a3..b3] = \text{linalg::ogCoordTab [ogName, Ranges]}(c)$ .

### UnitVectors

`linalg::ogCoordTab [ogName, UnitVectors](  $u_1, u_2, u_3, c$  )` returns a list of orthonormal vectors  $[\vec{e}_1, \vec{e}_2, \vec{e}_3]$ , where each vector is represented by a list of three

arithmetical expressions. These vectors  $\vec{e}_i = \frac{1}{s_i} \frac{\partial}{\partial u_i} \vec{x}$  with  $s_i = \left| \frac{\partial}{\partial u_i} \vec{x} \right|$  are the unit vectors tangent to the parameter lines  $u_i$ .

### Scales

`linalg::ogCoordTab [ogName, Scales]( u1, u2, u3, c )` returns a list [ s<sub>1</sub>, s<sub>2</sub>, s<sub>3</sub>] of “scaling factors” of the transformation  $\vec{u} \rightarrow \vec{x}$ . The “scales” are the Euclidean

lengths  $s_i = \left| \frac{\partial}{\partial u_i} \vec{x} \right|$  of the vectors  $\frac{\partial}{\partial u_i} \vec{x}$  tangent to the parameter lines  $u_i$ .

## Return Values

Most of the entries in `linalg::ogCoordTab` are functions:

`linalg::ogCoordTab [ogName, Transformation]( u1, u2, u3, c )` returns a list of arithmetical expressions [ x<sub>1</sub>( u<sub>1</sub>, u<sub>2</sub>, u<sub>3</sub>), x<sub>2</sub>( u<sub>1</sub>, u<sub>2</sub>, u<sub>3</sub>), x<sub>3</sub>( u<sub>1</sub>, u<sub>2</sub>, u<sub>3</sub>)] defining the transformation from the orthogonal coordinates  $u_i$  to the Cartesian coordinates  $x_j$ .

`linalg::ogCoordTab [ogName, InverseTransformation]( x1, x2, x3, c )` returns a list of arithmetical expressions [ u<sub>1</sub>( x<sub>1</sub>, x<sub>2</sub>, x<sub>3</sub>), u<sub>2</sub>( x<sub>1</sub>, x<sub>2</sub>, x<sub>3</sub>), u<sub>3</sub>( x<sub>1</sub>, x<sub>2</sub>, x<sub>3</sub>)] defining the inverse transformation.

`linalg::ogCoordTab [ogName, UnitVectors]( u1, u2, u3, c )` returns a list of orthogonal unit “vectors.” The “vectors” are given as lists of arithmetical expressions.

`linalg::ogCoordTab [ogName, Scales]( u1, u2, u3, c )` returns a list of arithmetical expressions.

`linalg::ogCoordTab [ogName, Ranges]( c )` returns a list of ranges on page 1-16 [ a<sub>1</sub>.. b<sub>1</sub>, a<sub>2</sub>.. b<sub>2</sub>, a<sub>3</sub>.. b<sub>3</sub>]. The transformation is invertible for parameter values  $a_i < u_i < b_i$ .

`linalg::ogCoordTab [ogName, Dimension]` yields the dimension of the space parametrized by the orthogonal coordinates. Presently, all predefined systems parametrize  $\mathbb{R}^3$ , i.e., the dimension is 3 in all cases.

The call `linalg::ogCoordTab [ogName]( u1, u2, u3, c )` is identical to the call `linalg::ogCoordTab [ogName, UnitVectors]( u1, u2, u3, c )`.

## See Also

### **MuPAD Functions**

`curl` | `divergence` | `gradient` | `hessian` | `jacobian` | `laplacian`

## `linalg::orthog`

Orthogonalization of vectors

### Syntax

```
linalg::orthog(S, <Real>)
```

### Description

`linalg::orthog(S)` orthogonalizes the vectors in  $S$  using the Gram-Schmidt orthogonalization algorithm.

The vectors in  $S$  are orthogonalized with respect to the scalar product `linalg::scalarProduct`.

If  $O$  is the returned set, then the vectors of  $O$  span the same subspace as the vectors in  $S$ , and they are pairwise orthogonal, i.e.:  $\vec{v} \vec{w} = 0$  for all  $\vec{v}, \vec{w} \in O$  with  $\vec{v} \neq \vec{w}$ .

The vectors returned are not normalized. To normalize them use `map(0, linalg::normalize)`.

For an ordered set of orthogonal vectors,  $S$  should be a list.

The vectors in  $S$  must be defined over the same component ring.

The component ring of the vectors in  $S$  must be a field, i.e., a domain of category `Cat::Field`.

If you use the `Real` option, `linalg::orthog` computes an orthogonal basis using a real scalar product in the orthogonalization process.

## Examples

### Example 1

The following list of vectors is a basis of the vector space  $\mathbb{R}^3$ :

```
MatR := Dom::Matrix(Dom::Real):
S := [MatR([2, 1, 0]), MatR([-3, 1, 1]), MatR([-1, -1, -1])]
```

$$\left[ \begin{pmatrix} 2 \\ 1 \\ 0 \end{pmatrix}, \begin{pmatrix} -3 \\ 1 \\ 1 \end{pmatrix}, \begin{pmatrix} -1 \\ -1 \\ -1 \end{pmatrix} \right]$$

The Gram-Schmidt algorithm then returns an orthogonal basis for  $\mathbb{R}^3$ . We get an orthonormal basis with the following input:

```
ON:= linalg::orthog(S)
```

$$\left[ \begin{pmatrix} 2 \\ 1 \\ 0 \end{pmatrix}, \begin{pmatrix} -1 \\ 2 \\ 1 \end{pmatrix}, \begin{pmatrix} -\frac{2}{15} \\ \frac{4}{15} \\ -\frac{2}{3} \end{pmatrix} \right]$$

The vectors can be normalized using `linalg::normalize`:

```
map(ON, linalg::normalize)
```

$$\left[ \begin{pmatrix} \frac{2\sqrt{5}}{5} \\ \frac{\sqrt{5}}{5} \\ 0 \end{pmatrix}, \begin{pmatrix} -\frac{\sqrt{6}}{6} \\ \frac{\sqrt{6}}{3} \\ \frac{\sqrt{6}}{6} \end{pmatrix}, \begin{pmatrix} -\frac{\sqrt{2}\sqrt{15}}{30} \\ \frac{\sqrt{2}\sqrt{15}}{15} \\ -\frac{\sqrt{2}\sqrt{15}}{6} \end{pmatrix} \right]$$

We may also build a matrix from the vectors in `S` and apply `linalg::orthog` to this matrix. The result is the matrix whose columns are given by the above elements of the list `ON`:

```
A:= S[1].S[2].S[3]
```

$$\begin{pmatrix} 2 & -3 & -1 \\ 1 & 1 & -1 \\ 0 & 1 & -1 \end{pmatrix}$$

```
linalg::orthog(A)
```

$$\begin{pmatrix} 2 & -1 & -\frac{2}{15} \\ 1 & 2 & \frac{4}{15} \\ 0 & 1 & -\frac{2}{3} \end{pmatrix}$$

## Example 2

The orthogonalization of the vectors:

```
T := {matrix([[ -2, 5, 3]]), matrix([[0, 2, 1]])}
```

$$\{(0 \ 2 \ 1), (-2 \ 5 \ 3)\}$$

gives:

```
linalg::orthog(T)
```

$$\{(0 \ 2 \ 1), (-2 \ -\frac{1}{5} \ \frac{2}{5})\}$$

## Example 3

The result of `linalg::orthog` is a list or set of linearly independent vectors, even if the input contains linearly dependent vectors:

```
MatQ := Dom::Matrix(Dom::Rational):  
S := [MatQ([2, 1]), MatQ([3, 4]), MatQ([-1, 1])]
```

$$\left[ \begin{pmatrix} 2 \\ 1 \end{pmatrix}, \begin{pmatrix} 3 \\ 4 \end{pmatrix}, \begin{pmatrix} -1 \\ 1 \end{pmatrix} \right]$$

```
linalg::orthog(S)
```

$$\left[ \begin{pmatrix} 2 \\ 1 \end{pmatrix}, \begin{pmatrix} -1 \\ 2 \end{pmatrix} \right]$$

### Example 4

Compute an orthogonal basis of this matrix:

```
A := matrix([[a, 1], [1, a]]):
linalg::orthog(A)
```

$$\begin{pmatrix} a - \frac{a^2 - 1}{a\bar{a} + 1} \\ 1 - \frac{\bar{a} - a^2 \bar{a}}{a\bar{a} + 1} \end{pmatrix}$$

To avoid complex conjugates, use the Real option:

```
linalg::orthog(A, Real)
```

$$\begin{pmatrix} a - \frac{a^2 - 1}{a^2 + 1} \\ 1 - \frac{a(a^2 - 1)}{a^2 + 1} \end{pmatrix}$$

## Parameters

**S**

A set or list of vectors of the same dimension (a vector is an  $n \times 1$  or  $1 \times n$  matrix of a domain of category `Cat::Matrix`) or a matrix

## Options

**Real**

Avoid using a complex scalar product in the orthogonalization process.

## Return Values

Set or a list of vectors, respectively.

## See Also

### MuPAD Functions

`linalg::factorQR` | `linalg::isUnitary` | `linalg::normalize` |  
`linalg::scalarProduct` | `lllint` | `norm`



# linalg::pascal

Pascal matrix

## Syntax

`linalg::pascal(n, <R>)`

## Description

`linalg::pascal(n)` returns the  $n \times n$  Pascal matrix  $P$  given by  $P_{i,j} = \binom{i+j-2}{i-1}$ ,  $1 \leq i, j \leq n$ .

The entries of Pascal matrices are integer numbers. Note, however, that the returned matrix is not defined over the component domain `Dom::Integer`, but over the standard component domain `Dom::ExpressionField()`. Thus, no conversion is necessary when working with other functions that expect or return matrices over that component domain.

Use `linalg::pascal(n, Dom::Integer)` to define the  $n \times n$  Pascal matrix over the ring of integer numbers.

Inverse Pascal matrices are provided by `linalg::invpascal`.

## Examples

### Example 1

We construct the  $3 \times 3$  Pascal matrix:

```
linalg::pascal(3)
```

$$\begin{pmatrix} 1 & 1 & 1 \\ 1 & 2 & 3 \\ 1 & 3 & 6 \end{pmatrix}$$

This is a matrix of the domain `Dom::Matrix()`.

If you prefer a different component ring, the matrix may be converted to the desired domain after construction (see `coerce`, for example). Alternatively, one can specify the component ring when creating the Pascal matrix. For example, specification of the domain `Dom::Float` generates floating-point entries:

```
linalg::pascal(3, Dom::Float)
```

$$\begin{pmatrix} 1.0 & 1.0 & 1.0 \\ 1.0 & 2.0 & 3.0 \\ 1.0 & 3.0 & 6.0 \end{pmatrix}$$

```
domtype(%)
```

```
Dom::Matrix(Dom::Float)
```

## Example 2

The Cholesky factor on page 15-58 of a Pascal matrix consists of the elements of Pascal's triangle:

```
linalg::factorCholesky(linalg::pascal(4))
```

$$\begin{pmatrix} 1 & 0 & 0 & 0 \\ 1 & 1 & 0 & 0 \\ 1 & 2 & 1 & 0 \\ 1 & 3 & 3 & 1 \end{pmatrix}$$

## Parameters

**n**

The dimension of the matrix: a positive integer

**R**

The component ring: a domain of category `Cat::Rng`; default:  
`Dom::ExpressionField()`

## Return Values

$n \times n$  matrix of the domain `Dom::Matrix(R)`.

## Algorithms

Pascal matrices are symmetric and positive definite.

The determinant of a Pascal matrix is 1.

The inverse of a Pascal matrix has integer entries.

If  $\lambda$  is an eigenvalue of a Pascal matrix, then  $\frac{1}{\lambda}$  is also an eigenvalue of the matrix.

## See Also

### MuPAD Functions

`linalg::hilbert` | `linalg::invhilbert` | `linalg::invpascal` |  
`linalg::invvandermonde` | `linalg::toeplitz` | `linalg::toeplitzSolve` |  
`linalg::vandermonde` | `linalg::vandermondeSolve`

# linalg::permanent

Permanent of a matrix

## Syntax

```
linalg::permanent(A)
```

## Description

`linalg::permanent(A)` computes the permanent of the square matrix  $A$ .

The component ring of the matrix  $A$  must be a commutative ring, i.e., a domain of category `Cat::CommutativeRing`.

## Examples

### Example 1

We compute the permanent of the following matrix:

```
delete a11, a12, a21, a22:  
A := matrix([[a11, a12], [a21, a22]])
```

$$\begin{pmatrix} a11 & a12 \\ a21 & a22 \end{pmatrix}$$

which gives us the general formula for the permanent of an arbitrary  $2 \times 2$  matrix:

```
linalg::permanent(A)  
  
a11 a22 + a12 a21
```

## Example 2

The permanent of a matrix can be computed over arbitrary commutative rings. Let us create a random matrix defined over the ring  $\mathbb{Z}_6$ , the integers modulo 6:

```
B := linalg::randomMatrix(5, 5, Dom::IntegerMod(6))
```

$$\begin{pmatrix} 3 \bmod 6 & 2 \bmod 6 & 3 \bmod 6 & 5 \bmod 6 & 4 \bmod 6 \\ 2 \bmod 6 & 5 \bmod 6 & 2 \bmod 6 & 1 \bmod 6 & 1 \bmod 6 \\ 1 \bmod 6 & 3 \bmod 6 & 3 \bmod 6 & 2 \bmod 6 & 2 \bmod 6 \\ 1 \bmod 6 & 0 \bmod 6 & 3 \bmod 6 & 3 \bmod 6 & 5 \bmod 6 \\ 0 \bmod 6 & 0 \bmod 6 & 0 \bmod 6 & 1 \bmod 6 & 3 \bmod 6 \end{pmatrix}$$

The permanent of this matrix is:

```
linalg::permanent(B)
```

4 mod 6

Its determinant is:

```
det(B)
```

0 mod 6

## Parameters

**A**

A square matrix of a domain of category `Cat::Matrix`

## Return Values

Element of the component ring of A.

## Algorithms

The permanent of an  $n \times n$  matrix  $A = (a_{i,j})_{1 \leq i \leq n, 1 \leq j \leq n}$  is defined similarly as the determinant of  $A$ , only the signs of the permutations do not enter the definition:

$$\text{perm}(A) := \sum_{\sigma \in S_n} \prod_{j=1}^n a_{\sigma(j),j}$$

( $S_n$  is the symmetric group of all permutations of  $\{1, \dots, n\}$ .)

In contrast to the computation of the determinant, the computation of the permanent takes time  $O(n^2 2^n)$ .

## See Also

### MuPAD Functions

det

# linalg::pseudoInverse

Moore-Penrose inverse of a matrix

## Syntax

```
linalg::pseudoInverse(A)
```

## Description

`linalg::pseudoInverse(A)` computes the Moore-Penrose inverse of  $A$ .

If the Moore-Penrose inverse of  $A$  does not exist, then FAIL is returned.

The component ring of the matrix  $A$  must be a field, i.e., a domain of category `Cat::Field`.

## Examples

### Example 1

The Moore-Penrose inverse of the  $2 \times 3$  matrix:

```
A := Dom::Matrix(Dom::Complex)([[1, I, 3], [1, 3, 2]])
```

$$\begin{pmatrix} 1 & i & 3 \\ 1 & 3 & 2 \end{pmatrix}$$

is the  $3 \times 2$  matrix:

```
Astar := linalg::pseudoInverse(A)
```

$$\begin{pmatrix} \frac{7}{96} + \frac{1}{32} i & \frac{1}{24} - \frac{1}{32} i \\ -\frac{7}{32} - \frac{5}{96} i & \frac{5}{16} + \frac{7}{96} i \\ \frac{7}{24} + \frac{1}{16} i & \frac{1}{96} - \frac{3}{32} i \end{pmatrix}$$

Note that in this example, only:

$A * Astar$

$$\begin{pmatrix} 1 & 0 \\ 0 & 1 \end{pmatrix}$$

yields the identity matrix, but not (see “Backgrounds” below):

$Astar * A$

$$\begin{pmatrix} \frac{11}{96} & \frac{3}{32} - \frac{1}{48} i & \frac{29}{96} + \frac{1}{32} i \\ \frac{3}{32} + \frac{1}{48} i & \frac{95}{96} & -\frac{1}{32} - \frac{1}{96} i \\ \frac{29}{96} - \frac{1}{32} i & -\frac{1}{32} + \frac{1}{96} i & \frac{43}{48} \end{pmatrix}$$

## Parameters

**A**

A matrix of category `Cat::Matrix`

## Return Values

Matrix of the same domain type as A, or the value FAIL.



## Algorithms

For an invertible matrix  $A$ , the Moore-Penrose inverse  $A^*$  of  $A$  coincides with the inverse of  $A$ . In general, only  $AA^*A = A$  and  $A^*AA^* = A^*$  holds.

If  $A$  is of dimension  $m \times n$ , then  $A^*$  is of dimension  $n \times m$ .

The computation of the Moore-Penrose inverse requires the existence of a scalar product on the vector space  $K^n$ , where  $K$  is the coefficient field of the matrix  $A$ . This is only the case for some fields  $K$  in theory, but `linalg::scalarProduct` works also for vectors over other fields (e.g. finite fields). The computation of a Moore-Penrose inverse may fail in such cases.

## See Also

### MuPAD Functions

`_invert`

# linalg::randomMatrix

Generate a random matrix

## Syntax

```
linalg::randomMatrix(m, n, <R>, <bound>, <Diagonal | Unimodular>)
```

## Description

The call `linalg::randomMatrix(m, n)` returns a random  $m \times n$  matrix over the default component ring for matrices, i.e., over the domain `Dom::ExpressionField()`.

The matrix components are generated by the method "random" of the domain R (see "Example 2" on page 15-193 (Symbolic Math Toolbox)).

The parameter `bound` is given as a parameter to the method "random" of the domain R in order to bound the size of the components of the random matrix. The correct type of `bound` is determined by the method "random". The parameter has no effect if the slot "random" does not have a size argument.

## Examples

### Example 1

We create a random square matrix over the integers. Because the matrix is random the created matrix can vary:

```
linalg::randomMatrix(2, 2, Dom::Integer)
```

$$\begin{pmatrix} 824 & -65 \\ -814 & -741 \end{pmatrix}$$

If you want to bound the size of its components, say between -2 and 2, enter:

```
linalg::randomMatrix(2, 2, Dom::Integer, -2..2)
```

$$\begin{pmatrix} -1 & 1 \\ -2 & 1 \end{pmatrix}$$

## Example 2

The following input creates a random vector over the component ring `Dom::FloatIV` of floating-point intervals. Because the vector is random the created vector can vary:

```
v := linalg::randomMatrix(1, 4, Dom::FloatIV)
```

```
[[0.2703581654 ... 0.831037179 , 0.1531565158 ... 0.9948127811 ,
  0.1801642274 ... 0.2662729024 , 0.4520830547 ... 0.6787819565 ]]
```

```
domtype(v)
```

```
Dom::Matrix(Dom::FloatIV)
```

The components of this matrix are random floating-point intervals created by the "random" method of the domain constructor `Dom::FloatIV`.

## Example 3

To create a random diagonal matrix over the rationals we enter, for example:

```
linalg::randomMatrix(3, 3, Dom::Rational, Diagonal)
```

$$\begin{pmatrix} \frac{229}{220} & 0 & 0 \\ 0 & -\frac{535}{617} & 0 \\ 0 & 0 & -\frac{245}{597} \end{pmatrix}$$

## Example 4

The following command creates a random unimodular matrix over the integers so that its determinant is either 1 or -1:

```
A := linalg::randomMatrix(3, 3, Dom::Integer, Unimodular)
```

$$\begin{pmatrix} -1 & -8 & 4 \\ 4 & 0 & -5 \\ -3 & 5 & 2 \end{pmatrix}$$

```
det(A)
```

$$-1$$

We can bound the size of the components. The following input returns a unimodular matrix  $A = (a_{ij})$  with  $|a_{ij}| \leq 2$  for  $i, j = 1, 2, 3$ :

```
A := linalg::randomMatrix(3, 3, 2, Unimodular)
```

$$\begin{pmatrix} 0 & -1 & 0 \\ 1 & 0 & 2 \\ 1 & 0 & 1 \end{pmatrix}$$

Since we did not specify the component ring, the matrix is defined over the standard component ring for matrices (the domain `Dom::ExpressionField()`):

```
domtype(A)
```

```
Dom::Matrix()
```

## Parameters

**m, n**

Positive integers

**R**

The component ring, i.e., a domain of category `Cat::Rng`; default:  
`Dom::ExpressionField()`

**bound**

An arithmetical expression

## Options

**Diagonal**

Creates a random  $m \times n$  diagonal matrix over R.

**Unimodular**

Creates a random  $m \times m$  unimodular matrix over R, so that its determinant is a unit in R.

---

**Note** Note that this option is only available for square matrices.

---

The norm of each component of the matrix returned does not exceed `bound`, which must be a positive integer, if specified. The default value of `bound` is 10.

## Return Values

Matrix of the domain `Dom::Matrix(R)`.

## References

For generating random unimodular matrices, see Jürgen Hansen: *Generating Problems in Linear Algebra*, MapleTech, Volume 1, No.2, 1994.

## See Also

### **MuPAD Domains**

Dom::Matrix

### **MuPAD Functions**

random

# linalg::rank

Rank of a matrix

## Syntax

```
linalg::rank(A)
```

```
linalg::rank(S)
```

## Description

`linalg::rank(A)` computes the rank of the matrix  $A$ .

`linalg::rank(S)` computes the rank of the matrix whose columns are the vectors in  $S$ .

The row rank of a matrix is the maximal number of linearly independent row vectors of that matrix. The column rank of a matrix is the maximal number of linearly independent column vectors of that matrix. For each matrix, its row rank is equal to its column rank. This number is called the rank of a matrix.

The component ring of  $A$  or of the vectors given in  $S$  must be an integral domain (a domain of category `Cat::IntegralDomain`).

`linalg::rank` replaces symbolic elements of a matrix by random integer numbers between 1 and  $10^{10}$ . Then the function computes the rank of the resulting numeric matrix by Gaussian elimination (see `linalg::gaussElim`). This approach introduces a tiny chance of getting a wrong result.

---

**Note** `linalg::rank` does not simplify special functions and algebraic numbers. For some matrices, this approach leads to wrong results. See “Example 3” on page 15-198 (Symbolic Math Toolbox).

---

## Examples

### Example 1

Define the following matrix A over  $\mathbb{Z}$ :

```
MatZ := Dom::Matrix(Dom::Integer):  
A := MatZ([[1, 2, 3, 4], [-1, 0, 1, 0], [3, 5, 6, 9]])
```

$$\begin{pmatrix} 1 & 2 & 3 & 4 \\ -1 & 0 & 1 & 0 \\ 3 & 5 & 6 & 9 \end{pmatrix}$$

Compute the rank of the matrix A:

```
linalg::rank(A)
```

3

### Example 2

Use the three vectors  $\begin{pmatrix} 0 \\ 1 \\ 1 \end{pmatrix}$ ,  $\begin{pmatrix} 0 \\ 1 \\ 0 \end{pmatrix}$ ,  $\begin{pmatrix} 0 \\ 0 \\ 1 \end{pmatrix}$  to define the columns of the matrix A. Compute the rank of A:

```
MatZ := Dom::Matrix(Dom::Integer):  
S := { MatZ([0,1,1]), MatZ([0,1,0]), MatZ([0,0,1]) }:  
linalg::rank(S)
```

2

### Example 3

The `linalg::rank` function does not use any simplification rules for special functions, algebraic numbers (radicals), and so on. If `linalg::rank` computes intermediate



expressions that can be simplified to zero, the function can return incorrect results. For example, create the following matrices:

```
A := matrix([[exp(x + y), exp(x)], [exp(y), 1]]);
B := matrix([[sin(x)^2 + cos(x)^2, 1], [1, 1]]);
C := matrix([[sqrt(6), sqrt(2)], [sqrt(3), 1]])
```

$$\begin{pmatrix} e^{x+y} & e^x \\ e^y & 1 \end{pmatrix}$$

$$\begin{pmatrix} \cos(x)^2 + \sin(x)^2 & 1 \\ 1 & 1 \end{pmatrix}$$

$$\begin{pmatrix} \sqrt{6} & \sqrt{2} \\ \sqrt{3} & 1 \end{pmatrix}$$

There is only one independent row in each of these matrices. The rank of the matrices A, B, and C is 1. The `linalg::rank` function returns 2 because it does not simplify the expressions  $e^{x+y} - e^x e^y$ ,  $\sin^2 + \cos^2 - 1$ , and  $\sqrt{2} \sqrt{3} - \sqrt{6}$ :

```
linalg::rank(A), linalg::rank(B), linalg::rank(C)
```

```
2, 2, 2
```

## Parameters

### A

A matrix of a domain of category `Cat::Matrix`

### S

A list or set of column vectors of the same dimension (a column vector is an  $n \times 1$  matrix of a domain of category `Cat::Matrix`)

## Return Values

Nonnegative integer

## See Also

### MuPAD Functions

`det` | `linalg::gaussElim`

## Topics

“Compute Rank of a Matrix” (Symbolic Math Toolbox)

# linalg::row

Extract rows of a matrix

## Syntax

```
linalg::row(A, r)
```

```
linalg::row(A, r1 .. r2)
```

```
linalg::row(A, list)
```

## Description

`linalg::row(A, r)` extracts the  $r$ -th row vector of the matrix  $A$ .

`linalg::row(A, r1 .. r2)` returns a list of row vectors whose indices are in the range  $r_1 .. r_2$ . If  $r_2 < r_1$  then the empty list `[]` is returned.

`linalg::row(A, list)` returns a list of row vectors whose indices are contained in `list` (in the same order).

## Examples

### Example 1

We define a matrix over  $\mathbb{Q}$ :

```
A := Dom::Matrix(Dom::Rational)(
  [[1, 1/5], [-3/2, 5], [2, -3]]
)
```

$$\begin{pmatrix} 1 & \frac{1}{5} \\ -\frac{3}{2} & 5 \\ 2 & -3 \end{pmatrix}$$

and illustrate the three different input formats for the function `linalg::row`:

```
linalg::row(A, 2)
```

$$\left(-\frac{3}{2} \ 5\right)$$

```
linalg::row(A, [2, 1, 3])
```

$$\left[\left(-\frac{3}{2} \ 5\right), \left(1 \ \frac{1}{5}\right), (2 \ -3)\right]$$

```
linalg::row(A, 2..3)
```

$$\left[\left(-\frac{3}{2} \ 5\right), (2 \ -3)\right]$$

## Parameters

**A**

An  $m \times n$  matrix of a domain of category `Cat::Matrix`

**r**

The row index: a positive integer less or equal to  $m$

**r<sub>1</sub> .. r<sub>2</sub>**

A range of row indices (positive integers less or equal to  $m$ )

**list**

A list of row indices (positive integers less or equal to  $m$ )

## Return Values

Single row vector or a list of row vectors; a row vector is a  $1 \times n$  matrix of category `Cat::Matrix(R)`, where  $R$  is the component ring of  $A$ .

## See Also

### MuPAD Functions

`linalg::col` | `linalg::delCol` | `linalg::delRow` | `linalg::setCol` |  
`linalg::setRow`

## `linalg::scalarProduct`

Scalar product of vectors

### Syntax

```
linalg::scalarProduct(u, v, <Real>)
```

### Description

`linalg::scalarProduct(u, v)` computes the scalar product of the vectors

$\vec{u} = (u_1, \dots, u_n)$  and  $\vec{v} = (v_1, \dots, v_n)$  with respect to the standard basis, i.e., the sum  $u_1 \bar{v}_1 + \dots + u_n \bar{v}_n$ .

The scalar product is also called “inner product” or “dot product”.

If the component ring of the vectors  $u$  and  $v$  does not define the entry “conjugate” or if the option `Real` is specified, then `linalg::scalarProduct` uses the definition  $u_1 v_1 + \dots + u_n v_n$  of the scalar product.

The vectors  $u$  and  $v$  must be defined over the same component ring.

`linalg::scalarProduct` can be redefined to a different scalar product. This also affects the behaviour of functions such as `linalg::angle`, `linalg::factorQR`, `linalg::isUnitary`, `norm` (for vectors and matrices), `linalg::orthog` and `linalg::pseudoInverse` depend on the definition of `linalg::scalarProduct`. See “Example 3” on page 15-206 (Symbolic Math Toolbox).

### Environment Interactions

Properties of identifiers are taken into account.

## Examples

### Example 1

We compute the scalar product of the vectors  $(i, 1)$  and  $(1, -i)$ :

```
MatC := Dom::Matrix(Dom::Complex):
u := MatC([I, 1]): v := MatC([1, -I]):
linalg::scalarProduct(u, v)
```

$2i$

### Example 2

We compute the scalar product of the vectors  $\vec{u} = (u_1, u_2)$  and  $\vec{v} = (v_1, v_2)$  with the symbolic entries  $u_1, u_2, v_1, v_2$  over the standard component ring for matrices:

```
delete u1, u2, v1, v2:
u := matrix([u1, u2]): v := matrix([v1, v2]):
linalg::scalarProduct(u, v)
```

$u1 \overline{v1} + u2 \overline{v2}$

You can use `assume` to tell the system that the symbolic components are to represent real numbers:

```
assume([u1, u2, v1, v2], Type::Real):
```

Then the scalar product of  $\vec{u}$  and  $\vec{v}$  simplifies to:

```
linalg::scalarProduct(u, v)
```

$u1 v1 + u2 v2$

Alternatively, the option `Real` can be specified:

```
unassume(u1, u2, v1, v2):
linalg::scalarProduct(u, v, Real)
```

$$u_1 v_1 + u_2 v_2$$

### Example 3

One particular scalar product in the real vector space of continuous functions on the interval  $[0, 1]$  is defined by

$$(f, g) = \int_0^1 f(t) g(t) dt$$

To compute an orthogonal basis corresponding to the polynomial basis  $1, t, t^2, t^3, \dots$  with respect to this scalar product, we replace the standard scalar product by the following procedure:

```
standardScalarProduct := linalg::scalarProduct:
unprotect(linalg):
linalg::scalarProduct := proc(u, v)
    local F, f, t;
begin
    // (0)
    f := expr(u[1] * v[1]);

    // (1)
    t := indets(f);
    if t = {} then t := genident("t") else t := op(t, 1) end_if;

    // (2)
    F := int(f, t = 0..1);

    // (3)
    u::dom::coeffRing::coerce(F)
end:
```

We start with step (0) to convert  $f(t)g(t)$  to an expression of a basic domain type, such that the system function `int` in step (2) can handle its input (this is not necessary if the elements of the component ring of the vectors are already represented by elements of basic domains).



Step (1) extracts the indeterminate of the polynomials, step (2) computes the scalar product as defined above and step (3) converts the result back to an element of the component ring of vectors  $u$  and  $v$ .

Note that we need to unprotect the write protected identifier `linalg`, otherwise the assignment would lead to an error message.

We next create the matrix which consists of the first five of the above polynomials:

```
P := matrix([[1, t, t^2, t^3, t^4]])
```

$$\begin{pmatrix} 1 & t & t^2 & t^3 & t^4 \end{pmatrix}$$

If we now perform the Gram-Schmidt orthogonalization procedure on the columns of  $P$  with the function `linalg::orthog`, we get:

```
S := linalg::orthog(linalg::col(P, 1..4))
```

$$\left[ \left( 1 \right), \left( t - \frac{1}{2} \right), \left( t^2 - t + \frac{1}{6} \right), \left( t^3 - \frac{3t^2}{2} + \frac{3t}{5} - \frac{1}{20} \right) \right]$$

Each vector in  $S$  is orthogonal to the other vectors in  $S$  with respect to the modified scalar product. We check this for the first vector:

```
linalg::scalarProduct(S[1], S[j]) $ j = 2..nops(S)
```

$$0, 0, 0$$

Finally, we undo the redefinition of the scalar product, so as not to run into trouble with subsequent computations:

```
linalg::scalarProduct := standardScalarProduct:
protect(linalg, Error):
```

## Parameters

**u, v**

Vectors of the same dimension (a vector is an  $n \times 1$  or  $1 \times n$  matrix of a domain of category `Cat::Matrix`)

## Options

**Real**

Use  $u_1 v_1 + \dots + u_n v_n$  as the definition of the scalar product, i.e., suppress the use of conjugate.

## Return Values

Element of the component ring of `u` and `v`.

## See Also

**MuPAD Functions**

`linalg::angle` | `linalg::crossProduct` | `linalg::factorQR` |  
`linalg::isUnitary` | `linalg::orthog` | `norm`

# linalg::setCol

Change a column of a matrix

## Syntax

```
linalg::setCol(A, p, c)
```

## Description

`linalg::setCol(A, p, c)` returns a copy of matrix  $A$  with the  $p$ -th column replaced by the column vector  $\vec{c}$ .

If  $c$  is a list with at most  $m$  elements, then  $c$  is converted into a column vector. An error message is returned if the conversion is not possible (e.g., if an element of the list cannot be converted into an object of the component ring of  $A$ ; see “Example 2” on page 15-210 (Symbolic Math Toolbox)).

## Examples

### Example 1

We define a matrix over the rationals:

```
MatQ := Dom::Matrix(Dom::Rational):
A := MatQ([[1, 2], [3, 2]])
```

$$\begin{pmatrix} 1 & 2 \\ 3 & 2 \end{pmatrix}$$

and replace the 2nd column by the  $2 \times 1$  zero vector:

```
linalg::setCol(A, 2, MatQ([0, 0]))
```

$$\begin{pmatrix} 1 & 0 \\ 3 & 0 \end{pmatrix}$$

## Example 2

We create the  $2 \times 2$  zero matrix over  $\mathbb{Z}_6$ :

```
B := Dom::Matrix(Dom::IntegerMod(6))(2, 2)
```

$$\begin{pmatrix} 0 \bmod 6 & 0 \bmod 6 \\ 0 \bmod 6 & 0 \bmod 6 \end{pmatrix}$$

and replace the 2nd column by the vector  $\begin{pmatrix} 1 \\ -1 \end{pmatrix}$ . We give the column vector in form of a list. Its elements are converted implicitly into objects of the component ring of B:

```
linalg::setCol(B, 2, [1, -1])
```

$$\begin{pmatrix} 0 \bmod 6 & 1 \bmod 6 \\ 0 \bmod 6 & 5 \bmod 6 \end{pmatrix}$$

The following input leads to an error message because the number  $1/3$  can not be converted into an object of type `Dom::IntegerMod(6)`:

```
linalg::setCol(B, 1, [1/3, 0])
```

```
Error: Invalid column vector. [linalg::setCol]
```

## Parameters

**A**

An  $m \times n$  matrix of a domain of category `Cat::Matrix`

**c**

A column vector, or a list that can be converted into a column vector of the domain  $\text{Dom}::\text{Matrix}(R)$ , where  $R$  is the component ring of  $A$  (a column vector is an  $m \times 1$  matrix)

## Return Values

Matrix of the same domain type as  $A$ .

## See Also

### MuPAD Functions

`linalg::col` | `linalg::delCol` | `linalg::delRow` | `linalg::row` |  
`linalg::setRow`

## `linalg::setRow`

Change a row of a matrix

### Syntax

```
linalg::setRow(A, p, r)
```

### Description

`linalg::setRow(A, p, r)` returns a copy of the matrix  $A$  with the  $p$ -th row replaced by the row vector  $\vec{r}$ .

If  $r$  is a list with at most  $n$  elements, then  $r$  is converted into a row vector. An error message is returned if the conversion is not possible (e.g., if an element of the list cannot be converted into an object of the component ring of  $A$ ; see “Example 2” on page 15-213 (Symbolic Math Toolbox)).

### Examples

#### Example 1

We define a matrix over the rationals:

```
MatQ := Dom::Matrix(Dom::Rational):  
A := MatQ([[1, 2], [3, 2]])
```

$$\begin{pmatrix} 1 & 2 \\ 3 & 2 \end{pmatrix}$$

and replace the 2nd row by the  $1 \times 2$  zero vector:

```
linalg::setRow(A, 2, MatQ(1, 2, [0, 0]))
```

$$\begin{pmatrix} 1 & 2 \\ 0 & 0 \end{pmatrix}$$

## Example 2

We create the  $2 \times 4$  zero matrix over  $\mathbb{Z}_6$ :

```
B := Dom::Matrix(Dom::IntegerMod(6))(2, 4)
```

$$\begin{pmatrix} 0 \bmod 6 & 0 \bmod 6 & 0 \bmod 6 & 0 \bmod 6 \\ 0 \bmod 6 & 0 \bmod 6 & 0 \bmod 6 & 0 \bmod 6 \end{pmatrix}$$

and replace the 2nd row by the vector  $(1, -1, 1, -1)$ . We give the row vector in form of a list. Its elements are converted implicitly into objects of the component ring of B:

```
linalg::setRow(B, 2, [1, -1, 1, -1])
```

$$\begin{pmatrix} 0 \bmod 6 & 0 \bmod 6 & 0 \bmod 6 & 0 \bmod 6 \\ 1 \bmod 6 & 5 \bmod 6 & 1 \bmod 6 & 5 \bmod 6 \end{pmatrix}$$

The following input leads to an error message because the number  $\frac{1}{3}$  can not be converted into an object of type `Dom::IntegerMod(6)`:

```
linalg::setRow(B, 1, [1/3, 0, 1, 0])
```

```
Error: Invalid row vector. [linalg::setRow]
```

## Parameters

### A

An  $m \times n$  matrix of a domain of category `Cat::Matrix`

**r**

A row vector or a list that can be converted into a row vector the domain  
Dom: `::Matrix(R)`, where R is the component ring of A (a row vector is a  $1 \times n$  matrix)

## Return Values

Matrix of the same domain type as A.

## See Also

### MuPAD Functions

`linalg::col` | `linalg::delCol` | `linalg::delRow` | `linalg::row` |  
`linalg::setCol`



# linalg::smithForm

Smith normal form of a matrix

## Syntax

```
linalg::smithForm(A, <var>, <All>)
```

## Description

`linalg::smithForm(A)` computes the Smith normal form of the  $n$ -dimensional square matrix  $A$ , that is an  $n \times n$  diagonal matrix  $S$ , such that  $S_{i-1, i-1}$  divides  $S_{i, i}$  for  $i = 2, \dots, n$ .

The Smith normal form of a matrix  $A$  is unique.

The component ring of  $A$  must be a Euclidean ring, that is, a domain of category `Cat::EuclideanDomain`.

`linalg::smithForm(A, var)` returns the Smith normal form of  $A$ , assuming that the elements of  $A$  are univariate polynomials in the variable `var`. If  $A$  does not contain `var`, then `smithForm(A)` and `smithForm(A, var)` return different results.

`linalg::smithForm(A, <var>, All)` returns the list  $[S, U, V]$ , where  $S$  is the Smith normal form of  $A$ , and  $U$  and  $V$  are unimodular transformation matrices, such that  $S = U \cdot A \cdot V$ . You can use the `All` option with or without specifying the variable `var`.

## Examples

### Example 1

Create the following matrix of integers.

```
A := matrix([[9, -36, 30], [-36, 192, -180], [30, -180, 180]])
```

$$\begin{pmatrix} 9 & -36 & 30 \\ -36 & 192 & -180 \\ 30 & -180 & 180 \end{pmatrix}$$

Find the Smith normal form of this matrix.

```
linalg::smithForm(A)
```

$$\begin{pmatrix} 3 & 0 & 0 \\ 0 & 12 & 0 \\ 0 & 0 & 60 \end{pmatrix}$$

Use the All option to find the corresponding transformation matrices.

```
[S, U, V] := linalg::smithForm(A, All)
```

$$\left[ \begin{pmatrix} 3 & 0 & 0 \\ 0 & 12 & 0 \\ 0 & 0 & 60 \end{pmatrix}, \begin{pmatrix} 1 & 1 & 1 \\ -4 & -1 & 0 \\ 10 & 5 & 3 \end{pmatrix}, \begin{pmatrix} 1 & -2 & 0 \\ 0 & 1 & 5 \\ 0 & 1 & 4 \end{pmatrix} \right]$$

Verify that  $S = U \cdot A \cdot V$ .

```
S = U*A*V
```

$$\begin{pmatrix} 3 & 0 & 0 \\ 0 & 12 & 0 \\ 0 & 0 & 60 \end{pmatrix} = \begin{pmatrix} 3 & 0 & 0 \\ 0 & 12 & 0 \\ 0 & 0 & 60 \end{pmatrix}$$

## Example 2

Create the following matrix of polynomials.

```
B := matrix([[-(x - 3)^2*(x - 2), (x - 3)*(x - 2)*(x - 4)],  
            [(x - 3)*(x - 2)*(x - 4), -(x - 3)^2*(x - 4)]  
            ])
```

$$\begin{pmatrix} -(x-2)(x-3)^2 & (x-2)(x-3)(x-4) \\ (x-2)(x-3)(x-4) & -(x-3)^2(x-4) \end{pmatrix}$$

Find the Smith normal form of this matrix.

```
linalg::smithForm(B)
```

$$\begin{pmatrix} x-3 & 0 \\ 0 & x^3-9x^2+26x-24 \end{pmatrix}$$

Use the All option to find the corresponding transformation matrices.

```
[U, S, V] := linalg::smithForm(B, All)
```

$$\left[ \begin{pmatrix} x-3 & 0 \\ 0 & x^3-9x^2+26x-24 \end{pmatrix}, \begin{pmatrix} -\frac{1}{2} & -\frac{1}{2} \\ x-4 & x-2 \end{pmatrix}, \begin{pmatrix} 1 & 2-\frac{x}{2} \\ 1 & 1-\frac{x}{2} \end{pmatrix} \right]$$

### Example 3

If a matrix does not contain a particular variable, and you call `linalg::smithForm` specifying that variable as the second argument, then the result differs from what you get without specifying that variable. For example, create a matrix that does not contain any variables.

```
A := matrix([[9, -36, 30], [-36, 192, -180], [30, -180, 180]])
```

$$\begin{pmatrix} 9 & -36 & 30 \\ -36 & 192 & -180 \\ 30 & -180 & 180 \end{pmatrix}$$

Call `linalg::smithForm` specifying variable `x` as the second argument. In this case, `linalg::smithForm` assumes that the elements of `A` are univariate polynomials in `x`.

```
linalg::hermiteForm(A, x)
```

$$\begin{pmatrix} 1 & 0 & 0 \\ 0 & 1 & 0 \\ 0 & 0 & 1 \end{pmatrix}$$

Call `linalg::smithForm` without specifying variables. In this case, `linalg::smithForm` treats  $A$  as a matrix of integers.

```
linalg::hermiteForm(A)
```

$$\begin{pmatrix} 3 & 0 & 30 \\ 0 & 12 & 0 \\ 0 & 0 & 60 \end{pmatrix}$$

## Parameters

**A**

A square matrix of a domain of category `Cat::Matrix`

## Options

**All**

Returns the list  $[S, U, V]$ , where  $S$  is the Smith normal form of  $A$ , and  $U$  and  $V$  are unimodular transformation matrices, such that  $S = U \cdot A \cdot V$ .

## Return Values

Matrix of the same domain type as  $A$ . With the option `All`, `linalg::smithForm` returns the list  $[S, U, V]$ , where  $S$  is a matrix of the same domain type as  $A$ , and  $U$  and  $V$  are corresponding transformation matrices.

## Algorithms

An  $n \times n$  matrix  $S = (s_{ij})$  with coefficients in a Euclidean ring is the Smith normal form of a matrix if  $S$  is a diagonal matrix (with nonnegative coefficients in case of the ring  $\mathbb{Z}$ ), such that  $s_{i,i}$  divides  $s_{i+1,i+1}$  for all  $i < n$ .

## See Also

### MuPAD Functions

`linalg::frobeniusForm` | `linalg::hermiteForm` | `linalg::jordanForm`

## `linalg::sqrtMatrix`

Square root of a matrix

### Syntax

```
linalg::sqrtMatrix(A, <sqrtfunc>)
```

### Description

`linalg::sqrtMatrix(A)` returns the square root of the matrix  $A$ .

### Examples

#### Example 1

A square root of a diagonal matrix is given by the diagonal matrix, whose diagonal entries are just the square roots of the original matrix.

Compute the square root of the matrix

$$A = \begin{pmatrix} 4 & 0 & 0 \\ 0 & 2 & 0 \\ 0 & 0 & -1 \end{pmatrix} ;$$

```
A := matrix([[4, 0, 0], [0, 2, 0], [0, 0, -1]]):  
S := linalg::sqrtMatrix(A)
```

$$\begin{pmatrix} 2 & 0 & 0 \\ 0 & \sqrt{2} & 0 \\ 0 & 0 & i \end{pmatrix}$$

Check the correctness of the result:

$S^2$

$$\begin{pmatrix} 4 & 0 & 0 \\ 0 & 2 & 0 \\ 0 & 0 & -1 \end{pmatrix}$$

## Example 2

Compute the square root of the matrix

$$A = \begin{pmatrix} 2 & -2 & 0 \\ -1 & 3 & 0 \\ -\frac{1}{3} & \frac{5}{3} & 2 \end{pmatrix};$$

```
A := matrix([[2, -2, 0], [-1, 3, 0], [-1/3, 5/3, 2]]);
S := linalg::sqrtMatrix(A)
```

$$\begin{pmatrix} \frac{4}{3} & -\frac{2}{3} & 0 \\ -\frac{1}{3} & \frac{5}{3} & 0 \\ \frac{2\sqrt{2}}{3} - 1 & 1 - \frac{\sqrt{2}}{3} & \sqrt{2} \end{pmatrix}$$

If you compute the square of the matrix S and simplify the result, you obtain the matrix A:

```
simplify(S^2)
```

$$\begin{pmatrix} 2 & -2 & 0 \\ -1 & 3 & 0 \\ -\frac{1}{3} & \frac{5}{3} & 2 \end{pmatrix}$$

Using the function  $x \rightarrow -\sqrt{x}$  as second argument for the computation of the square root of the matrix A, obtain a different matrix, whose components are just the negative components of the original square root computed above:

```
S:= linalg::sqrtMatrix(A, x -> -sqrt(x));  
S, simplify(S^2);
```

$$\begin{pmatrix} -\frac{4}{3} & \frac{2}{3} & 0 \\ \frac{1}{3} & -\frac{5}{3} & 0 \\ 1 - \frac{2\sqrt{2}}{3} & \frac{\sqrt{2}}{3} - 1 & -\sqrt{2} \end{pmatrix}, \begin{pmatrix} 2 & -2 & 0 \\ -1 & 3 & 0 \\ -\frac{1}{3} & \frac{5}{3} & 2 \end{pmatrix}$$

## Parameters

**A**

A square matrix of a domain of category `Cat::Matrix`

**sqrtfunc**

A function satisfying  $\text{sqrtfunc}(a)^2 = a$  for every element  $a$  of the coefficient ring of  $A$  (i.e. the square root function of the coefficient domain of  $A$ ).

## Return Values

Matrix  $B$  with  $B^2 = A$  such that the eigenvalues of  $B$  are the square roots of the eigenvalues of  $A$  or FAIL if the square root of the matrix does not exist

## See Also

**MuPAD Functions**

`funm` | `linalg::eigenvalues` | `linalg::eigenvectors` | `linalg::jordanForm` |  
`numeric::eigenvalues` | `numeric::eigenvectors` | `numeric::expMatrix` |  
`numeric::fMatrix` | `solve`



# linalg::stackMatrix

Join matrices vertically

## Syntax

```
linalg::stackMatrix(A, <B1, B2, ...>)
```

## Description

`linalg::stackMatrix(A, B1, B2, ...)` returns the matrix formed by joining the matrices  $A$ ,  $B_1$ ,  $B_2$ , ... vertically.

The matrices  $B_1$ ,  $B_2$ , ... are converted into the matrix domain  $\text{Dom}::\text{Matrix}(R)$ , where  $R$  is the component ring of  $A$ .

An error message is raised if one of these conversions fails, or if the matrices do not have the same number of columns as the matrix  $A$ .

## Examples

### Example 1

We define a matrix:

```
A:= matrix( [[sin(x),x], [-x,cos(x)]] )
```

$$\begin{pmatrix} \sin(x) & x \\ -x & \cos(x) \end{pmatrix}$$

and append the 2×2 identity matrix to the lower end of the matrix  $A$ :

```
linalg::stackMatrix(A, matrix::identity(2))
```

$$\begin{pmatrix} \sin(x) & x \\ -x & \cos(x) \\ 1 & 0 \\ 0 & 1 \end{pmatrix}$$

## Example 2

We define a matrix from the ring of 2×2 square matrices:

```
SqMatQ := Dom::SquareMatrix(2,Dom::Rational):  
A := SqMatQ([[1, 2], [3, 4]])
```

$$\begin{pmatrix} 1 & 2 \\ 3 & 4 \end{pmatrix}$$

Note that the following operation:

```
AA := linalg::stackMatrix(A, A)
```

$$\begin{pmatrix} 1 & 2 \\ 3 & 4 \\ 1 & 2 \\ 3 & 4 \end{pmatrix}$$

returns a matrix of a different domain type as the input matrix:

```
domtype(AA)
```

```
Dom::Matrix(Dom::Rational)
```

## Parameters

A, <B<sub>1</sub>, B<sub>2</sub>, ...>

Matrices of a domain of category `Cat::Matrix`

## Return Values

Matrix of the domain type  $\text{Dom}::\text{Matrix}(R)$ , where  $R$  is the component ring of  $A$ .

## See Also

### MuPAD Functions

`linalg::concatMatrix`

## `linalg::submatrix`

Extract a submatrix or a subvector from a matrix or a vector, respectively

### Syntax

```
linalg::submatrix(A, r1 .. r2, c1 .. c2)
```

```
linalg::submatrix(A, rlist, clist)
```

```
linalg::submatrix(v, i1 .. i2)
```

```
linalg::submatrix(v, list)
```

### Description

`linalg::submatrix(A, r1.. r2, c1.. c2)` returns a copy of the submatrix of the matrix  $A$  obtained by selecting the rows  $r_1, r_1 + 1, \dots, r_2$  and the columns  $c_1, c_1 + 1, \dots, c_2$ .

`linalg::submatrix(v, i1.. i2)` returns a copy of the subvector of the vector  $\vec{v}$  obtained by selecting the components with indices  $i_1, i_1 + 1, \dots, i_2$ .

The index notation  $A[r_1.. r_2, c_1.. c_2]$  and  $v[i_1.. i_2]$ , respectively, can be used instead of `linalg::submatrix(A, r1.. r2, c1.. c2)` and `linalg::submatrix(v, i1.. i2)`.

`linalg::submatrix(A, rlist, clist)` returns the submatrix of the matrix  $A$  whose  $(i, j)$ -th component is  $a_{rlist_i, clist_j}$ .

`linalg::submatrix(v, list)` returns the subvector of the vector  $v$  whose  $i$ -th component is  $v_{list_i}$ .

If  $v$  is a row vector or a column vector, then `linalg::submatrix(v, 1..1, i1.. i2)` and `linalg::submatrix(v, i1.. i2, 1..1)`, respectively, are valid inputs, and they both are equivalent to the call `linalg::submatrix(v, i1.. i2)`.

## Examples

### Example 1

We define the following matrix:

```
A := matrix([[1, x, 0], [0, x^2, 1]])
```

$$\begin{pmatrix} 1 & x & 0 \\ 0 & x^2 & 1 \end{pmatrix}$$

The submatrix  $(a_{1,j})_{1 \leq j \leq 2}$  of A is given by:

```
linalg::submatrix(A, 1..1, 1..2)
```

$$(1 \ x)$$

Equivalent to the use of the index operator we obtain:

```
A[1..1, 1..2]
```

$$(1 \ x)$$

We extract the first and the third column of A and get the  $2 \times 2$  identity matrix:

```
linalg::submatrix(A, [1, 2], [1, 3])
```

$$\begin{pmatrix} 1 & 0 \\ 0 & 1 \end{pmatrix}$$

### Example 2

Vector components can be accessed by a single index or a range of indices. For example, to extract the first two components of the following vector:

```
v := matrix([1, 2, 3])
```

$$\begin{pmatrix} 1 \\ 2 \\ 3 \end{pmatrix}$$

just enter the command:

```
v[1..2]
```

$$\begin{pmatrix} 1 \\ 2 \end{pmatrix}$$

Of course, the same subvector can be extracted with the command `linalg::submatrix(v, 1..2)`.

The following input returns the vector comprising the first and the third component of  $v$ :

```
linalg::submatrix(v, [1, 3])
```

$$\begin{pmatrix} 1 \\ 3 \end{pmatrix}$$

## Parameters

**A**

An  $m \times n$  matrix of a domain of category `Cat::Matrix`

**v**

A vector with  $k$  components, i.e., a  $k \times 1$  or  $1 \times k$  matrix of a domain of category `Cat::Matrix`

**r<sub>1</sub> .. r<sub>2</sub>, c<sub>1</sub> .. c<sub>2</sub>**

Ranges of row/column indices: positive integers less or equal to  $m$  and  $n$ , respectively

**rlist, clist**

Lists of row/column indices: positive integers less or equal to  $m$  and  $n$ , respectively

$i_1 \dots i_2$

A range of vector indices: positive integers less or equal to  $k$

**list**

A list of vector indices: positive integers less or equal to  $k$

## Return Values

Matrix of the same domain type as  $A$  or a vector of the same domain type as  $v$ , respectively.

## See Also

### MuPAD Functions

`linalg::col` | `linalg::row` | `linalg::substitute`

## `linalg::substitute`

Replace a part of a matrix by another matrix

### Syntax

```
linalg::substitute(B, A, m, n)
```

### Description

`linalg::substitute(B, A, m, n)` returns a copy of the matrix  $B$ , where entries starting at position  $[m, n]$  are replaced by the entries of the matrix  $A$ , i.e.,  $B_{mn}$  is  $A_{11}$ .

If the matrices are defined over different component domains, then the entries of  $A$  are converted into elements of the component domain of the matrix  $B$ . If one of these conversions fails, then an error message is returned.

### Examples

#### Example 1

We define the following matrix:

```
B := matrix(  
  [[1, 2, 3, 4], [5, 6, 7, 8],  
   [9, 10, 11, 12], [13, 14, 15, 16]]  
)
```

$$\begin{pmatrix} 1 & 2 & 3 & 4 \\ 5 & 6 & 7 & 8 \\ 9 & 10 & 11 & 12 \\ 13 & 14 & 15 & 16 \end{pmatrix}$$

and copy the  $2 \times 2$  zero matrix into the matrix  $B$ , beginning at position  $[3, 3]$ :



```
A := matrix(2, 2):
linalg::substitute(B, A, 3, 3)
```

$$\begin{pmatrix} 1 & 2 & 3 & 4 \\ 5 & 6 & 7 & 8 \\ 9 & 10 & 0 & 0 \\ 13 & 14 & 0 & 0 \end{pmatrix}$$

Matrix entries out of range are ignored:

```
linalg::substitute(B, A, 4, 4)
```

$$\begin{pmatrix} 1 & 2 & 3 & 4 \\ 5 & 6 & 7 & 8 \\ 9 & 10 & 11 & 12 \\ 13 & 14 & 15 & 0 \end{pmatrix}$$

## Parameters

**A, B**

Matrices of a domain of category `Cat::Matrix`

**m, n**

Positive integers

## Return Values

Matrix of the same domain type as B.

## See Also

### MuPAD Functions

`linalg::concatMatrix` | `linalg::setCol` | `linalg::setRow` |  
`linalg::stackMatrix` | `linalg::submatrix`

## `linalg::sumBasis`

Basis for the sum of vector spaces

### Syntax

```
linalg::sumBasis(S1, S2, ...)
```

### Description

`linalg::sumBasis(S1, S2, ...)` returns a basis of the vector space  $V_1 + V_2 + \dots$ , where  $V_i$  denotes the vector space spanned by the vectors in  $S_i$ .

To obtain an ordered basis,  $S_1, S_2, \dots$  should be given as lists of vectors.

A basis of the zero-dimensional space is the empty set or list, respectively.

The given vectors must be defined over the same component ring, which must be a field, i.e., a domain of category `Cat::Field`.

### Examples

#### Example 1

We define three vectors  $\vec{v}_1, \vec{v}_2, \vec{v}_3$  over  $\mathbb{Q}$ :

```
MatQ := Dom::Matrix(Dom::Rational):  
v1 := MatQ([[3, -2]]); v2 := MatQ([[1, 0]]); v3 := MatQ([[5, -3]])
```

$(3 \ -2)$

$(1 \ 0)$

(5 -3)

A basis of the vector space  $V_1 + V_2 + V_3$  with

- $V_1$  generated by  $\vec{v}_1, \vec{v}_2, \vec{v}_3$
- $V_2$  generated by  $\vec{v}_1, \vec{v}_3$
- $V_3$  generated by  $\vec{v}_1 + \vec{v}_2, \vec{v}_2, \vec{v}_1 + \vec{v}_3$

is:

```
linalg::sumBasis([v1, v2, v3], [v1, v3], [v1 + v2, v2, v1 + v3])
```

[(3 -2), (1 0)]

## Example 2

The following set of two vectors:

```
MatQ := Dom::Matrix(Dom::Rational):
S1 := {MatQ([1, 2, 3]), MatQ([-1, 0, 2])}
```

$$\left\{ \begin{pmatrix} -1 \\ 0 \\ 2 \end{pmatrix}, \begin{pmatrix} 1 \\ 2 \\ 3 \end{pmatrix} \right\}$$

is a basis of a two-dimensional subspace of  $\mathbb{Q}^3$ :

```
linalg::rank(S1)
```

2

The same holds for the following set:

```
S2 := {MatQ([0, 2, 3]), MatQ([2, 4, 6])};
linalg::rank(S2)
```

$$\left\{ \begin{pmatrix} 0 \\ 2 \\ 3 \end{pmatrix}, \begin{pmatrix} 2 \\ 4 \\ 6 \end{pmatrix} \right\}$$

2

The sum of the corresponding two subspaces is the vector space  $\mathbb{Q}^3$ :

```
Q3 := linalg::sumBasis(S1, S2)
```

$$\left\{ \begin{pmatrix} -1 \\ 0 \\ 2 \end{pmatrix}, \begin{pmatrix} 0 \\ 2 \\ 3 \end{pmatrix}, \begin{pmatrix} 1 \\ 2 \\ 3 \end{pmatrix} \right\}$$

## Parameters

$S_1, S_2, \dots$

A set or list of vectors of the same dimension (a vector is a  $n \times 1$  or  $1 \times n$  matrix of a domain of category `Cat::Matrix`)

## Return Values

Set or a list of vectors, according to the domain type of the parameter  $S_1$ .

## See Also

### MuPAD Functions

`linalg::basis` | `linalg::intBasis` | `linalg::rank`

# linalg::swapCol

Swap two columns in a matrix

## Syntax

```
linalg::swapCol(A, c1, c2)
```

```
linalg::swapCol(A, c1, c2, r1 .. r2)
```

## Description

`linalg::swapCol(A, c1, c2)` returns a copy of the matrix  $A$  with the columns with indices  $c_1$  and  $c_2$  interchanged.

The effect of `linalg::swapCol(A, c1, c2, r1.. r2)` is that only the components from row  $r_1$  to row  $r_2$  of column  $c_1$  are interchanged with the corresponding components of column  $c_2$ .

## Examples

### Example 1

We consider the following matrix:

```
A := matrix(3, 3, (i, j) -> 3*(i - 1) + j)
```

$$\begin{pmatrix} 1 & 2 & 3 \\ 4 & 5 & 6 \\ 7 & 8 & 9 \end{pmatrix}$$

The following command interchanges the first and the second column of  $A$ . The result is the following matrix:

```
linalg::swapCol(A, 1, 2)
```

$$\begin{pmatrix} 2 & 1 & 3 \\ 5 & 4 & 6 \\ 8 & 7 & 9 \end{pmatrix}$$

If only the components in the first two rows should be affected, we enter:

```
linalg::swapCol(A, 1, 2, 1..2)
```

$$\begin{pmatrix} 2 & 1 & 3 \\ 5 & 4 & 6 \\ 7 & 8 & 9 \end{pmatrix}$$

The third row remains unchanged.

## Parameters

**A**

An  $m \times n$  matrix of a domain of category `Cat::Matrix`

**c<sub>1</sub>, c<sub>2</sub>**

The column indices: positive integers less or equal to  $n$

**r<sub>1</sub> .. r<sub>2</sub>**

A range of row indices (positive integers less or equal to  $m$ )

## Return Values

Matrix of the same domain type as A.

## See Also

### MuPAD Functions

`linalg::col` | `linalg::delCol` | `linalg::delRow` | `linalg::row` |  
`linalg::setCol` | `linalg::setRow` | `linalg::swapRow`

## **Topics**

“Swap and Delete Rows and Columns” (Symbolic Math Toolbox)

## `linalg::swapRow`

Swap two rows in a matrix

### Syntax

```
linalg::swapRow(A, r1, r2)
```

```
linalg::swapRow(A, r1, r2, c1 .. c2)
```

### Description

`linalg::swapRow(A, r1, r2)` returns a copy of the matrix  $A$  with the rows with indices  $r_1$  and  $r_2$  interchanged.

The effect of `linalg::swapRow(A, r1, r2, c1.. c2)` is that only the components from column  $c_1$  to column  $c_2$  of row  $r_1$  are interchanged with the corresponding components of row  $r_2$ .

### Examples

#### Example 1

We consider the following matrix:

```
A := matrix(3, 3, (i, j) -> 3*(i - 1) + j)
```

$$\begin{pmatrix} 1 & 2 & 3 \\ 4 & 5 & 6 \\ 7 & 8 & 9 \end{pmatrix}$$

The following command interchanges the first and the second row of  $A$ . The result is the following matrix:

```
linalg::swapRow(A, 1, 2)
```



$$\begin{pmatrix} 4 & 5 & 6 \\ 1 & 2 & 3 \\ 7 & 8 & 9 \end{pmatrix}$$

If only the components in the first two columns should be affected, we enter:

```
linalg::swapRow(A, 1, 2, 1..2)
```

$$\begin{pmatrix} 4 & 5 & 3 \\ 1 & 2 & 6 \\ 7 & 8 & 9 \end{pmatrix}$$

The third column remains unchanged.

## Parameters

**A**

An  $m \times n$  matrix of a domain of category `Cat::Matrix`

**r<sub>1</sub>, r<sub>2</sub>**

The row indices: positive integers less or equal to  $m$

**c<sub>1</sub> .. c<sub>2</sub>**

A range of column indices (positive integers less or equal to  $n$ )

## Return Values

Matrix of the same domain type as A.

## See Also

### MuPAD Functions

linalg::col | linalg::delCol | linalg::delRow | linalg::row |  
linalg::setCol | linalg::setRow | linalg::swapCol

**Topics**

“Swap and Delete Rows and Columns” (Symbolic Math Toolbox)

# **linalg::syvester**

Sylvester matrix of two polynomials

## **Syntax**

```
linalg::syvester(p, q)
```

```
linalg::syvester(f, g, x)
```

## **Description**

`linalg::syvester(p, q)` returns the Sylvester matrix of the two polynomials  $p$  and  $q$ .

If no variable is specified, then the polynomials  $p$  and  $q$  must be either of the domain `DOM_POLY` or from a domain of category `Cat::Polynomial`. Polynomial expressions are not allowed.

If the polynomials  $p$  and  $q$  are of the domain `DOM_POLY`, then they must be univariate polynomials. The component ring of the Sylvester matrix is the common coefficient ring  $R$  of  $p$  and  $q$ , except in the following two cases for built-in coefficient rings: If  $R$  is `Expr` then the domain `Dom::ExpressionField()` is the component ring of the Sylvester matrix. If  $R$  is `IntMod(m)`, then the Sylvester matrix is defined over the ring `Dom::IntegerMod(m)` (see "Example 2" on page 15-242 (Symbolic Math Toolbox)).

Otherwise, if the polynomials  $p$  and  $q$  are from a domain of category `Cat::Polynomial`, then the Sylvester matrix is computed with respect to the main variable of  $p$  and  $q$  (see the method "mainvar" of the category `Cat::Polynomial`). In the case of univariate polynomials the Sylvester matrix is defined over the common coefficient ring of  $p$  and  $q$ . In the case of multivariate polynomials, the Sylvester matrix is defined over the component ring `Dom::DistributedPolynomial(ind, R)`, where `ind` is the list of all variables of  $p$  and  $q$  except  $x$ , and  $R$  is the common coefficient ring of the polynomials.

If  $f$  and  $g$  are polynomial expressions or multivariate polynomials of type `DOM_POLY`, then you must specify the variable  $x$ .

In the case of polynomial expressions, the component ring of the Sylvester matrix is the domain `Dom::ExpressionField()` (see “Example 3” on page 15-243 (Symbolic Math Toolbox)).

In the case of multivariate polynomials the Sylvester matrix is defined over the component ring `Dom::DistributedPolynomial(ind, R)`, where `ind` is the list of all variables of `f` and `g` except `x`, and `R` is the common coefficient ring of the polynomials (see “Example 4” on page 15-244 (Symbolic Math Toolbox)).

At least one of the input polynomials must have positive degree with respect to the main variable or `x`, respectively, but it is not necessary that both of them have positive degree.

## Examples

### Example 1

The Sylvester matrix of the two polynomials  $p = x^2 + 2x - 1$  and  $q = x^4 + 1$  over  $\mathbb{Z}$  is the following  $6 \times 6$  matrix:

```
delete x: Z := Dom::Integer:
S := linalg::sylvester(poly(x^2 + 2*x - 1, Z), poly(x^4 + 1, Z))
```

$$\begin{pmatrix} 1 & 2 & -1 & 0 & 0 & 0 \\ 0 & 1 & 2 & -1 & 0 & 0 \\ 0 & 0 & 1 & 2 & -1 & 0 \\ 0 & 0 & 0 & 1 & 2 & -1 \\ 1 & 0 & 0 & 0 & 1 & 0 \\ 0 & 1 & 0 & 0 & 0 & 1 \end{pmatrix}$$

### Example 2

If the polynomials have the built-in coefficient ring `IntMod(m)`, then the Sylvester matrix is defined over the domain `Dom::IntegerMod(m)`:

```
delete x:
S:= linalg::sylvester(
    poly(x + 1, IntMod(7)), poly(x^2 - 2*x + 2, IntMod(7))
)
```

$$\begin{pmatrix} 1 \bmod 7 & 1 \bmod 7 & 0 \bmod 7 \\ 0 \bmod 7 & 1 \bmod 7 & 1 \bmod 7 \\ 1 \bmod 7 & 5 \bmod 7 & 2 \bmod 7 \end{pmatrix}$$

`domtype(S)`

`Dom::Matrix(Dom::IntegerMod(7))`

### Example 3

The Sylvester matrix of the following two polynomial expressions with respect to the variable  $x$  is:

```
delete x, y;
S := linalg::sylvester(x + y^2, 2*x^3 - 1, x)
```

$$\begin{pmatrix} 1 & y^2 & 0 & 0 \\ 0 & 1 & y^2 & 0 \\ 0 & 0 & 1 & y^2 \\ 2 & 0 & 0 & -1 \end{pmatrix}$$

`domtype(S)`

`Dom::Matrix()`

The Sylvester matrix of these two polynomials with respect to  $y$  is the following  $2 \times 2$  matrix:

```
linalg::sylvester(x + y^2, 2*x^3 - 1, y)
```

$$\begin{pmatrix} 2x^3 - 1 & 0 \\ 0 & 2x^3 - 1 \end{pmatrix}$$

## Example 4

Here is an example for computing the Sylvester matrix of multivariate polynomials:

```
delete x, y: Q := Dom::Rational:  
T := linalg::sylvester(poly(x^2 - x + y, Q), poly(x + 2, Q), x)
```

$$\begin{pmatrix} 1 & -1 & y \\ 1 & 2 & 0 \\ 0 & 1 & 2 \end{pmatrix}$$

```
domtype( T )
```

```
Dom::Matrix(Dom::DistributedPolynomial([y], Dom::Rational, LexOrder))
```

The Sylvester matrix of these two multivariate polynomials with respect to  $y$  is:

```
linalg::sylvester(poly(x^2 - x + y, Q), poly(x + 2, Q), y)
```

$$(x+2)$$

## Parameters

**p, q**

Polynomials

**f, g**

Polynomials or polynomial expressions of positive degree

**x**

A variable

## Return Values

Matrix of the domain `Dom::Matrix(R)`, where `R` is the coefficient domain of the polynomials (see below).

## See Also

### MuPAD Functions

`polylib::discrim` | `polylib::resultant`

# `linalg::tr`

Trace of a matrix

## Syntax

```
linalg::tr(A)
```

## Description

`linalg::tr(A)` returns the trace of the square matrix  $A$ , i.e., the sum of the diagonal elements of  $A$ .

## Examples

### Example 1

We compute the trace of the following matrix:

```
A := Dom::Matrix(Dom::Integer)
      (3, 3, (i, j) -> 3*(i - 1) + j)
```

$$\begin{pmatrix} 1 & 2 & 3 \\ 4 & 5 & 6 \\ 7 & 8 & 9 \end{pmatrix}$$

```
linalg::tr(A)
```

15



## Parameters

**A**

A square matrix of a domain of category `Cat::Matrix`

## Return Values

Element of the component ring of A.

## See Also

### MuPAD Functions

`det`

## Topics

“Compute Determinants and Traces of Square Matrices” (Symbolic Math Toolbox)

## linalg::toeplitz

Toeplitz matrix

### Syntax

`linalg::toeplitz(m, n, [t-k, ..., tk], <R>)`

`linalg::toeplitz(n, [t-k, ..., tk], <R>)`

`linalg::toeplitz(c, r)`

`linalg::toeplitz(r)`

### Description

`linalg::toeplitz(m, n, [t-k, ..., t-1, t0, t1, ..., tk])` returns the  $m \times n$  Toeplitz matrix

$$\begin{pmatrix} t_0 & t_1 & t_2 & \dots & \dots & \dots & t_k \\ t_{-1} & t_0 & t_1 & t_2 & \dots & \dots & t_{k-1} \\ t_{-2} & t_{-1} & t_0 & t_1 & t_2 & \dots & t_{k-2} \\ \vdots & \vdots & \vdots & \vdots & \vdots & \ddots & \vdots \\ \vdots & \vdots & \vdots & \vdots & \vdots & \vdots & \vdots \\ \vdots & \vdots & \vdots & \vdots & t_0 & t_1 & t_2 \\ \vdots & \vdots & \vdots & \vdots & t_{-1} & t_0 & t_1 \\ t_{-k} & \vdots & \vdots & \vdots & \vdots & t_{-2} & t_{-1} & t_0 \end{pmatrix}.$$

`linalg::toeplitz(n, [t-k, ..., tk])` returns the square Toeplitz matrix of dimension  $n \times n$ .

A number of entries  $[t_{-k}, \dots, t_k]$  must be an odd number  $2k + 1$ . There must be at least  $k$  diagonal bands above the diagonal and  $k$  diagonal bands below the diagonal:  $k$  must satisfy  $k \leq \min(m, n) - 1$ . Entries with matrix indices  $(i, j)$  satisfying  $|i - j| > k$  are set to 0.

Toeplitz matrices of dimension  $n \times n$  can be inverted with  $O(n^2)$  operations. See `linalg::toeplitzSolve`.

`linalg::toeplitz(c, r)` generates a nonsymmetric Toeplitz matrix having `c` as its first column and `r` as its first row. If the first elements of `c` and `r` differ, `toeplitz` issues a warning and uses the first element of the column.

`linalg::toeplitz(r)` generates a symmetric Toeplitz matrix if `r` is real. If `r` is complex, but its first element is real, then this syntax generates the Hermitian Toeplitz matrix formed from `r`. If the first element of `r` is complex, then the resulting matrix is Hermitian off the main diagonal, meaning that  $T_{ij} = \text{conjugate}(T_{ji})$  for  $i \neq j$ .

When you use matrices in MuPAD computations, both computational efficiency and memory use can depend on whether the matrix is sparse or dense. The first two syntaxes are optimized for generating sparse matrices and, therefore, these syntaxes are preferable. For details about improving performance when working with matrices, see “Use Sparse and Dense Matrices” (Symbolic Math Toolbox).

## Examples

### Example 1

Construct a 4×4 Toeplitz matrix with three bands:

```
linalg::toeplitz(4, [-1, 2, 1])
```

$$\begin{pmatrix} 2 & 1 & 0 & 0 \\ -1 & 2 & 1 & 0 \\ 0 & -1 & 2 & 1 \\ 0 & 0 & -1 & 2 \end{pmatrix}$$

Construct a 3×5 Toeplitz matrix with symbolic entries:

```
linalg::toeplitz(3, 5, [a, b, c])
```

$$\begin{pmatrix} b & c & 0 & 0 & 0 \\ a & b & c & 0 & 0 \\ 0 & a & b & c & 0 \end{pmatrix}$$

## Example 2

Construct a Toeplitz matrix by using a vector to specify its first row. For a real vector, the resulting matrix is symmetric:

```
r := matrix([1, 2, 3]):  
linalg::toeplitz(r)
```

$$\begin{pmatrix} 1 & 2 & 3 \\ 2 & 1 & 2 \\ 3 & 2 & 1 \end{pmatrix}$$

For a complex vector, the resulting matrix is Hermitian off the main diagonal:

```
r := matrix([1 + I, 2 + I, 3 + I]):  
T := linalg::toeplitz(r);  
htranspose(T)
```

$$\begin{pmatrix} 1+i & 2+i & 3+i \\ 2-i & 1+i & 2+i \\ 3-i & 2-i & 1+i \end{pmatrix}$$

$$\begin{pmatrix} 1-i & 2+i & 3+i \\ 2-i & 1-i & 2+i \\ 3-i & 2-i & 1-i \end{pmatrix}$$

## Example 3

Construct a Toeplitz matrix by using two vectors to specify its first column and first row:

```
c := matrix([1, a/2, b/2]):  
r := [1, a, b]:  
linalg::toeplitz(c, r)
```

$$\begin{pmatrix} 1 & \frac{a}{2} & \frac{b}{2} \\ a & 1 & \frac{a}{2} \\ b & a & 1 \end{pmatrix}$$

If the first elements of the vectors differ, `linalg::toeplitz` issues a warning and uses the first element of the column:

```
c := matrix([1, a/2, b/2]):
r := [2, a, b]:
linalg::toeplitz(c, r)
```

Warning: First element of given column does not match first element of given row. Column

$$\begin{pmatrix} 2 & \frac{a}{2} & \frac{b}{2} \\ a & 2 & \frac{a}{2} \\ b & a & 2 \end{pmatrix}$$

## Parameters

**m, n**

Row and column dimensions of the matrix: positive integers.

**t<sub>-k</sub>, ..., t<sub>k</sub>**

Arithmetical expressions (Symbolic Math Toolbox) or elements of the component ring  $R$ .

**R**

Component ring: a domain of category `Cat::Rng`. The default ring is `Dom::ExpressionField()`.

**c**

Vector specifying the first column of a Toeplitz matrix.

**r**

Vector specifying the first row of a Toeplitz matrix.

## Return Values

Matrix of the domain `Dom::Matrix(R)`.

## See Also

### MuPAD Functions

`linalg::hilbert` | `linalg::invhilbert` | `linalg::invpascal` |  
`linalg::invvandermonde` | `linalg::pascal` | `linalg::toeplitzSolve` |  
`linalg::vandermonde` | `linalg::vandermondeSolve`

# linalg::toeplitzSolve

Solve a linear Toeplitz system

## Syntax

`linalg::toeplitzSolve(t, y)`

## Description

`linalg::toeplitzSolve(t, y)` returns the solution  $\vec{x}$  of the linear Toeplitz system

$$\sum_{j=1}^n t_{i-j} x_j = y_i \text{ with } i = 1, \dots, n.$$

`linalg::toeplitzSolve(t, y)` with  $t = [t_k, \dots, t_0, \dots, t_{-k}]$  and  $y = [y_1, \dots, y_n]$  solves the  $n \times n$  Toeplitz system

$$\begin{pmatrix} t_0 & t_{-1} & \cdot & \cdot & \cdot & t_{-k} \\ t_1 & t_0 & t_{-1} & \cdot & \cdot & t_{-k} \\ \cdot & \cdot & \cdot & \cdot & \cdot & \cdot \\ \cdot & \cdot & \cdot & \cdot & \cdot & \cdot \\ \cdot & \cdot & \cdot & \cdot & \cdot & \cdot \\ t_k & t_{k-1} & \cdot & \cdot & \cdot & t_{-k} \\ \cdot & t_k & t_{k-1} & \cdot & \cdot & t_{-k} \\ \cdot & \cdot & t_k & t_{k-1} & \cdot & t_{-k} \\ \cdot & \cdot & \cdot & \cdot & \cdot & \cdot \\ \cdot & \cdot & \cdot & \cdot & \cdot & \cdot \\ \cdot & \cdot & \cdot & \cdot & \cdot & \cdot \end{pmatrix} \begin{pmatrix} x_1 \\ x_2 \\ \vdots \\ x_n \end{pmatrix} = \begin{pmatrix} y_1 \\ y_2 \\ \vdots \\ y_n \end{pmatrix}$$

with  $2k + 1$  bands.

`linalg::toeplitzSolve` implements the Levinson algorithm. It uses  $O(n^2)$  elementary operations to solve the Toeplitz system. The memory requirements are  $O(n)$ . For dense Toeplitz systems, it is faster than the general solver `solve` and the linear solvers `linsolve`, `numeric::linsolve`, `linalg::matlinsolve` and `numeric::matlinsolve`.

---

**Note** Note that the Levinson algorithm requires that all principal minors

$$t_0, \begin{pmatrix} t_0 & t_{-1} \\ t_1 & t_0 \end{pmatrix}, \begin{pmatrix} t_0 & t_{-1} & t_{-2} \\ t_1 & t_0 & t_{-1} \\ t_2 & t_1 & t_0 \end{pmatrix}, \text{ etc}$$

are non-singular.

---

If `linalg::toeplitzSolve` does not manage to find the solution due to this limitation, or if the system is very sparse with  $k$  smaller than  $\sqrt{n}$ , we recommend to generate the corresponding Toeplitz matrix via `linalg::toeplitz` and compute the solution via `linalg::matlinsolve` or `numeric::matlinsolve`, respectively. Cf. "Example 2" on page 15-255 (Symbolic Math Toolbox)

`linalg::toeplitzSolve` can solve Toeplitz systems over arbitrary coefficient rings. Just make sure that both the Toeplitz entries  $t$  as well as the components of the 'right hand side'  $y$  are elements of the desired coefficient ring. Cf. "Example 3" on page 15-256 (Symbolic Math Toolbox).

## Examples

### Example 1

The Toeplitz entries  $t$  and the right hand side  $y$  of the linear system are entered as row vectors:

```
t := matrix([4, 2, 1, 3, 5]):  
y := matrix([y1, y2, y3]):
```



The solution of the Toeplitz system is returned as a vector of the same type as the input vector  $y$ :

```
x := linalg::toeplitzSolve(t, y): x, domtype(x)
```

$$\begin{pmatrix} \frac{7 y_2}{25} - \frac{y_1}{5} + \frac{4 y_3}{25} \\ \frac{2 y_1}{5} - \frac{19 y_2}{25} + \frac{7 y_3}{25} \\ \frac{2 y_2}{5} - \frac{y_3}{5} \end{pmatrix}, \text{Dom::Matrix()}$$

If the input vector is a list on page 7-41, the output is a list, too:

```
x := linalg::toeplitzSolve(t, [y1, y2, y3]): x, domtype(x)
```

$$\left[ \frac{7 y_2}{25} - \frac{y_1}{5} + \frac{4 y_3}{25}, \frac{2 y_1}{5} - \frac{19 y_2}{25} + \frac{7 y_3}{25}, \frac{2 y_2}{5} - \frac{y_3}{5} \right], \text{DOM\_LIST}$$

```
delete t, y, x:
```

## Example 2

The Levinson algorithm cannot solve the following Toeplitz system because the first principal minor of the Toeplitz matrix (the central element of the Toeplitz entries) vanishes:

```
linalg::toeplitzSolve([1, 0, 1], [y1, y2, y3, y4])
```

FAIL

This does not necessarily imply that the Toeplitz system is not solvable. We generate the corresponding Toeplitz matrix and use a generic linear solver such as `linalg::matlinsolve`:

```
T := linalg::toeplitz(4, 4, [1, 0, 1])
```

$$\begin{pmatrix} 0 & 1 & 0 & 0 \\ 1 & 0 & 1 & 0 \\ 0 & 1 & 0 & 1 \\ 0 & 0 & 1 & 0 \end{pmatrix}$$

```
linalg::matlinsolve(T, matrix([y1, y2, y3, y4]))
```

$$\begin{pmatrix} y2 - y4 \\ y1 \\ y4 \\ y3 - y1 \end{pmatrix}$$

### Example 3

We solve a Toeplitz system over the field  $\mathbb{Z}_7$  (the integers modulo 7) represented by the domain `Dom::IntegerMod(7)`:

```
R := Dom::IntegerMod(7):  
t := [R(5), R(3), R(2), R(5), R(1)]:  
y := [R(1), R(2), R(3)]:  
linalg::toeplitzSolve(t, y)
```

```
[1 mod 7, 5 mod 7, 2 mod 7]
```

```
delete R, t, y:
```

## Parameters

**t**

A vector or a list with  $2k + 1$  elements. (A vector is a  $(2k + 1) \times 1$  or a  $1 \times (2k + 1)$  matrix of category `Cat::Matrix`).

**y**

A vector or a list with  $n$  elements

## Return Values

Vector or list with  $n$  elements of the same domain type as the elements of  $y$ . FAIL is returned if the algorithm does not succeed in finding a solution.

## See Also

### MuPAD Functions

`linalg::hilbert` | `linalg::invhilbert` | `linalg::invpascal` |  
`linalg::invvandermonde` | `linalg::matlinsolve` | `linalg::pascal` |  
`linalg::toeplitz` | `linalg::vandermonde` | `linalg::vandermondeSolve` |  
`linsolve` | `numeric::linsolve` | `numeric::matlinsolve` | `solve`

# linalg::transpose

Transpose of a matrix

## Syntax

```
linalg::transpose(A)
```

## Description

`linalg::transpose(A)` returns the transpose  $A^t$  of the matrix  $A$ .

`linalg::transpose` is an interface function for the method "transpose" of the matrix domain of  $A$ , i.e., instead of `linalg::transpose(A)` one may call `A::dom::transpose(A)` directly.

## Examples

### Example 1

We define a  $3 \times 4$  matrix:

```
A := matrix([[1, 2, 3, 4], [-1, 0, 1, 0], [3, 5, 6, 9]])
```

$$\begin{pmatrix} 1 & 2 & 3 & 4 \\ -1 & 0 & 1 & 0 \\ 3 & 5 & 6 & 9 \end{pmatrix}$$

Then the transpose of  $A$  is the  $4 \times 3$  matrix:

```
linalg::transpose(A)
```

$$\begin{pmatrix} 1 & -1 & 3 \\ 2 & 0 & 5 \\ 3 & 1 & 6 \\ 4 & 0 & 9 \end{pmatrix}$$

## Parameters

**A**

A matrix of a domain of category `Cat::Matrix`

## Return Values

Matrix of the same domain type as A.

## Algorithms

Let  $A = (a_{i,j})_{1 \leq i \leq m, 1 \leq j \leq n}$  be an  $m \times n$  matrix. Then the transpose of A is the  $n \times m$  matrix:

$$A^t = \begin{pmatrix} a_{1,1} & a_{1,2} & \cdots & a_{m,1} \\ a_{1,2} & a_{2,2} & \cdots & a_{m,2} \\ \cdot & \cdot & \cdots & \cdot \\ \cdot & \cdot & \cdots & \cdot \\ a_{1,n} & a_{2,n} & \cdots & a_{m,n} \end{pmatrix} .$$

## `linalg::vandermonde`

Vandermonde matrix

### Syntax

`linalg::vandermonde([v1, v2, ...], <R>)`

### Description

`linalg::vandermonde(v1, v2, ..., vn)` returns the  $n \times n$  Vandermonde matrix  $V$  with entries  $V_{ij} = v_i^{j-1}$ .

Use `linalg::vandermonde([v1, ..., vn], R)` to define the  $n \times n$  Vandermonde matrix over the field  $R$ . Note that the Vandermonde nodes  $v_i$  must be elements of  $R$  or must be convertible to elements of  $R$ .

Vandermonde matrices of dimension  $n \times n$  can be inverted with  $O(n^2)$  operations. Linear equations with a Vandermonde coefficient matrix can be solved via `linalg::vandermondeSolve`.

### Examples

#### Example 1

Create a  $3 \times 3$  Vandermonde matrix:

```
V := linalg::vandermonde([v1, v2, v3])
```

$$\begin{pmatrix} 1 & v_1 & v_1^2 \\ 1 & v_2 & v_2^2 \\ 1 & v_3 & v_3^2 \end{pmatrix}$$

$V$  is a matrix of the domain `Dom::Matrix()`.

```
domtype(V)
```

```
Dom::Matrix()
```

You can specify a special component ring for the matrices, provided the nodes can be converted to elements of the ring. For example, specification of the domain `Dom::Float` generates floating-point entries:

```
V := linalg::vandermonde([2, PI, 1/3], Dom::Float)
```

$$\begin{pmatrix} 1.0 & 2.0 & 4.0 \\ 1.0 & 3.141592654 & 9.869604401 \\ 1.0 & 0.3333333333 & 0.1111111111 \end{pmatrix}$$

```
domtype(V)
```

```
Dom::Matrix(Dom::Float)
```

```
delete V
```

## Parameters

$v_1, v_2, \dots$

The Vandermonde nodes: arithmetical expressions (Symbolic Math Toolbox)

**R**

The component ring: a domain of category `Cat::Rng`; default:  
`Dom::ExpressionField()`

## Return Values

$n \times n$  matrix of the domain `Dom::Matrix(R)`.

## Algorithms

Vandermonde matrices are notoriously ill-conditioned. The inverses of large floating-point Vandermonde matrices are subject to severe round-off effects.

## See Also

### MuPAD Functions

`linalg::hilbert` | `linalg::invhilbert` | `linalg::invpascal` |  
`linalg::invvandermonde` | `linalg::pascal` | `linalg::toeplitz` |  
`linalg::toeplitzSolve` | `linalg::vandermondeSolve`



# `linalg::invvandermonde`

Vandermonde matrices and their inverses

## Syntax

```
linalg::invvandermonde([v1, v2, ...], <R>)
```

## Description

`linalg::invvandermonde(v1, v2, ..., vn)` returns the inverse of the Vandermonde matrix with nodes  $v_i$ .

Use `linalg::invvandermonde([v1, ..., vn], R)` to define the  $n \times n$  inverse Vandermonde matrix over the field  $R$ . Note that the nodes  $v_i$  must be elements of  $R$  or must be convertible to elements of  $R$ .

Vandermonde matrices of dimension  $n \times n$  can be inverted with  $O(n^2)$  operations. Linear equations with a Vandermonde coefficient matrix can be solved via `linalg::vandermondeSolve`.

## Examples

### Example 1

Create a  $3 \times 3$  Vandermonde matrix:

```
V := linalg::vandermonde([v1, v2, v3])
```

$$\begin{pmatrix} 1 & v_1 & v_1^2 \\ 1 & v_2 & v_2^2 \\ 1 & v_3 & v_3^2 \end{pmatrix}$$

The inverse of this matrix is:

```
invV := linalg::invvandermonde([v1, v2, v3])
```

$$\begin{pmatrix} \frac{v_2 v_3}{\sigma_3} & -\frac{v_1 v_3}{\sigma_2} & \frac{v_1 v_2}{\sigma_1} \\ -\frac{v_2+v_3}{\sigma_3} & \frac{v_1+v_3}{\sigma_2} & -\frac{v_1+v_2}{\sigma_1} \\ \frac{1}{\sigma_3} & -\frac{1}{\sigma_2} & \frac{1}{\sigma_1} \end{pmatrix}$$

where

$$\sigma_1 = (v_1 - v_3) (v_2 - v_3)$$

$$\sigma_2 = (v_1 - v_2) (v_2 - v_3)$$

$$\sigma_3 = (v_1 - v_2) (v_1 - v_3)$$

V and its inverse are matrices of the domain `Dom::Matrix()`.

```
domtype(V), domtype(invV)
```

```
Dom::Matrix(), Dom::Matrix()
```

You can specify a special component ring for the matrices, provided the nodes can be converted to elements of the ring. For example, specification of the domain `Dom::Float` generates floating-point entries:

```
V := linalg::vandermonde([2, PI, 1/3], Dom::Float)
```

$$\begin{pmatrix} 1.0 & 2.0 & 4.0 \\ 1.0 & 3.141592654 & 9.869604401 \\ 1.0 & 0.3333333333 & 0.1111111111 \end{pmatrix}$$

```
domtype(V)
```

```
Dom::Matrix(Dom::Float)
```

It is faster to compute the inverse via `linalg::invvandermonde` than inverting the Vandermonde matrix by a generic inversion algorithm implemented by `V^(-1)`:

```
V^(-1) = linalg::invvandermonde([2, PI, 1/3], Dom::Float)
```

$$\begin{pmatrix} -0.5503876788 & 0.2079506905 & 1.342436988 \\ 1.826356876 & -0.7278274166 & -1.098529459 \\ -0.5255815182 & 0.3119260357 & 0.2136554825 \end{pmatrix} = \begin{pmatrix} -0.5503876788 & 0.2079506905 & 1.342436988 \\ 1.826356876 & -0.7278274166 & -1.098529459 \\ -0.5255815182 & 0.3119260357 & 0.2136554825 \end{pmatrix}$$

```
delete V, invV
```

## Parameters

$v_1, v_2, \dots$

The Vandermonde nodes: arithmetical expressions (Symbolic Math Toolbox)

**R**

The component ring: a domain of category `Cat::Rng`; default:  
`Dom::ExpressionField()`

## Return Values

$n \times n$  matrix of the domain `Dom::Matrix(R)`.

## Algorithms

Vandermonde matrices are notoriously ill-conditioned. The inverses of large floating-point Vandermonde matrices are subject to severe round-off effects.

## See Also

### MuPAD Functions

`linalg::hilbert` | `linalg::invhilbert` | `linalg::invpascal` | `linalg::pascal`  
| `linalg::toeplitz` | `linalg::toeplitzSolve` | `linalg::vandermonde` |  
`linalg::vandermondeSolve`

# linalg::vandermondeSolve

Solve a linear Vandermonde system

## Syntax

`linalg::vandermondeSolve(v, y, <Transposed>)`

## Description

`linalg::vandermondeSolve(v, y)` returns the solution  $\vec{x}$  of the linear Vandermonde

system  $\sum_{j=1}^n v_i^{j-1} x_j = y_i$  with  $i = 1, \dots, n$ .

`linalg::vandermondeSolve` uses  $O(n^2)$  elementary operations to solve the Vandermonde system. It is faster than the general solver `solve` and the linear solvers `linsolve`, `numeric::linsolve`, `linalg::matlinsolve` and `numeric::matlinsolve`.

The solution  $\vec{x} = (x_1, \dots, x_n)$  returned by `linalg::vandermondeSolve([v[i] $ i=1..n], [y[i] $ i=1..n])` yields the coefficients of the polynomial  $p(v) = x_1 + x_2 v + \dots + x_n v^{n-1}$  interpolating the data table  $(v_1, y_1), \dots, (v_n, y_n)$ , i.e.,

$$p(v_1) = y_1, \dots, p(v_n) = y_n.$$

See “Example 1” on page 15-267 (Symbolic Math Toolbox).

## Examples

### Example 1

The Vandermonde points  $v$  and the right hand side  $y$  of the linear system are entered as vectors:

```
delete y0, y1, y2:  
v := matrix([[0, 1, 2]]);  
y := matrix([[y0, y1, y2]])
```

$$(0 \ 1 \ 2)$$
$$(y_0 \ y_1 \ y_2)$$

The solution vector is:

```
x := linalg::vandermondeSolve(v, y)
```

$$\left( y_0 \ 2 y_1 - \frac{3 y_0}{2} - \frac{y_2}{2} \ \frac{y_0}{2} - y_1 + \frac{y_2}{2} \right)$$

The solution yields the coefficients of the interpolating polynomial:

```
P := v -> _plus(x[i+1]*v^i $ i=0..2):
```

through the points  $(0, y_0)$ ,  $(1, y_1)$ ,  $(2, y_2)$ :

```
P(v[1]), P(v[2]), P(v[3])
```

$$y_0, y_1, y_2$$

With the optional argument `Transposed`, the linear system with the transposed Vandermonde matrix corresponding to `v` is solved:

```
linalg::vandermondeSolve(v, y, Transposed)
```

$$\left( y_0 - \frac{3 y_1}{2} + \frac{y_2}{2} \ 2 y_1 - y_2 \ \frac{y_2}{2} - \frac{y_1}{2} \right)$$

```
delete v, y, x, P:
```

## Example 2

The Vandermonde points `v` and the right hand side `y` of the linear system are entered as  $2 \times 1$  matrices:

```

Mat := Dom::Matrix(Dom::ExpressionField(normal)):
delete v1, v2, y1, y2:
v := Mat([v1, v2]):
y := Mat([y1, y2]):

```

We define the vectors over the domain `Dom::ExpressionField(normal)` in order to simplify intermediate computations.

Next, we compute the solution of the corresponding Vandermonde system:

```
x := linalg::vandermondeSolve(v, y)
```

$$\begin{pmatrix} \frac{v1 y2 - v2 y1}{v1 - v2} \\ \frac{y1 - y2}{v1 - v2} \end{pmatrix}$$

We construct the Vandermonde matrix `V` and verify the result:

```
V := Mat([[1, v[1]], [1, v[2]]])
```

$$\begin{pmatrix} 1 & v1 \\ 1 & v2 \end{pmatrix}$$

```
V * x
```

$$\begin{pmatrix} y1 \\ y2 \end{pmatrix}$$

```
delete Mat, v, y, x, V:
```

### Example 3

We solve a Vandermonde system over the field  $\mathbb{Z}_7$  (the integers modulo 7) represented by the domain `Dom::IntegerMod(7)`:

```

MatZ7 := Dom::Matrix(Dom::IntegerMod(7)):
v := MatZ7([1, 2, 3]): y := MatZ7([0, 1, 2]):
linalg::vandermondeSolve(v, y)

```

$$\begin{pmatrix} 6 \bmod 7 \\ 1 \bmod 7 \\ 0 \bmod 7 \end{pmatrix}$$

delete MatZ7, v, y:

## Parameters

**v**

A vector with distinct elements (a vector is an  $n \times 1$  or  $1 \times n$  matrix of category `Cat::Matrix`). Alternatively, a list with  $n$  distinct elements is also accepted.

**y**

A vector of the same dimension and domain type as **v**. Alternatively, a list with  $n$  elements is also accepted.

## Options

### Transposed

Returns the solution  $\vec{x}$  of the transposed system  $\sum_{j=1}^n v_j^{i-1} x_j = y_i$  with  $i = 1, \dots, n$ .

## Return Values

Vector of the same domain type as **y**.

## Algorithms

The Vandermonde matrix



$$V = \begin{pmatrix} 1 & v_1 & v_1^2 & \dots & v_1^{n-1} \\ 1 & v_2 & v_2^2 & \dots & v_2^{n-1} \\ \dots & \dots & \dots & \dots & \dots \\ 1 & v_n & v_n^2 & \dots & v_n^{n-1} \end{pmatrix}$$

generated by  $v = [v_1, \dots, v_n]$  is invertible if and only if the  $v_i$  are distinct.

The vector  $\vec{x}$  returned by `linalg::vandermondeSolve(x, y)` is the unique solution of  $V \vec{x} = \vec{y}$ .

The vector  $x$  returned by `linalg::vandermondeSolve(x, y, Transposed)` is the unique solution of  $V^t \vec{x} = \vec{y}$ .

## See Also

### MuPAD Functions

interpolate | linalg::invhilbert | linalg::invpascal |  
 linalg::invvandermonde | linalg::matlinsolve | linalg::pascal |  
 linalg::toeplitz | linalg::toeplitzSolve | linalg::vandermonde |  
 linalg::vandermondeSolve | linsolve | numeric::linsolve |  
 numeric::matlinsolve | solve

## `linalg::vecdim`

Number of components of a vector

### Syntax

```
linalg::vecdim(v)
```

### Description

`linalg::vecdim(v)` returns the number of elements of the vector  $\vec{v}$ .

### Examples

#### Example 1

We define a column vector with two elements and a row vector with four elements:

```
v1 := matrix([1, 0]); v2 := matrix([[1, 2, 3, 4]])
```

$$\begin{pmatrix} 1 \\ 0 \end{pmatrix}$$

$$(1 \ 2 \ 3 \ 4)$$

`linalg::vecdim` gives us the number of elements, i.e., the dimension of these vectors:

```
linalg::vecdim(v1), linalg::vecdim(v2)
```

$$2, 4$$

In contrast, the function `linalg::matdim` returns the number of rows and columns of these vectors:

```
linalg::matdim(v1), linalg::matdim(v2)
```

```
[2, 1], [1, 4]
```

## Parameters

**v**

A vector, i.e., an  $n \times 1$  or  $1 \times n$  matrix of a domain of category `Cat::Matrix`

## Return Values

Positive integer.

## See Also

### MuPAD Functions

`linalg::matdim` | `linalg::ncols` | `linalg::nrows`

## **linalg::vectorOf**

Type specifier for vectors

### **Syntax**

```
linalg::vectorOf(R)
```

```
linalg::vectorOf(R, n)
```

### **Description**

`linalg::vectorOf(R)` is a type specifier representing all objects of a domain of category `Cat::Matrix` with component ring `R` and number of rows or number of columns equal to one.

`linalg::vectorOf(R, n)` is a type specifier representing all objects of a domain of category `Cat::Matrix` with component ring `R` and number of rows equal to `n` and number of columns equal to one, or vice versa.

`linalg::vectorOf(Type::AnyType, n)` is a type specifier representing all objects of a domain of category `Cat::Matrix` with an arbitrary component ring `R` and number of rows equal to `n` and number of columns equal to one, or vice versa.

### **Examples**

#### **Example 1**

`linalg::vectorOf` can be used together with `testtype` to check whether a MuPAD object is a vector:

```
MatZ := Dom::Matrix(Dom::Integer):  
v := MatZ([1, 0, -1])
```

$$\begin{pmatrix} 1 \\ 0 \\ -1 \end{pmatrix}$$

The following yields FALSE because v is 3-dimensional vector:

```
testtype(v, linalg::vectorOf(Dom::Integer, 4))
```

FALSE

The following yields FALSE because v is defined over the integers:

```
testtype(v, linalg::vectorOf(Dom::Rational))
```

FALSE

Of course, v can be converted into a vector over the rationals, as shown by the following call:

```
bool(coerce(v, Dom::Matrix(Dom::Rational)) <> FAIL)
```

TRUE

This shows that `testtype` in conjunction with `linalg::vectorOf(R)` does not check whether an object can be converted into a vector over the specified component ring R. It checks only if the object is a vector whose component ring is R.

The following test returns TRUE because v is a 3-dimensional vector:

```
testtype(v, linalg::vectorOf(Type::AnyType, 3))
```

TRUE

## Example 2

`linalg::vectorOf` can also be used for checking parameters of procedures. The following procedure computes the orthogonal complement of a 2-dimensional vector:

```
orth := proc(v:linalg::vectorOf(Type::AnyType, 2))
begin
    [v[1], v[2]] := [-v[2],v[1]];
    return(v)
end:

u := matrix([[1, 2]]); u_ := orth(u)
```

( 1 2 )

( -2 1 )

Calling the procedure `orth` with an invalid parameter leads to an error message:

```
orth([1, 2])
```

```
Error: Invalid object '[1, 2]'. Type of argument number 1 must be 'slot(Type, vectorOf
Evaluating: orth
```

## Parameters

**R**

The component ring: a library domain

**n**

A positive integer

## Return Values

Type expression of the domain type `Type` (Symbolic Math Toolbox).

## See Also

### MuPAD Functions

testtype

## `linalg::wiedemann`

Solving linear systems by Wiedemann's algorithm

### Syntax

```
linalg::wiedemann(A, b, <mult>, <prob>)
```

### Description

`linalg::wiedemann(A, b, mult, ...)` tries to find a vector  $\vec{x}$  that satisfies the equation  $A\vec{x} = \vec{b}$  by using Wiedemann's algorithm.

The parameter `mult` must be a function such that the result of `mult(A, y)` equals  $A\vec{y}$  for every  $n$ -dimensional column vector  $\vec{y}$ . The parameter `y` is of the same domain type as `A`. The argument `mult` does not need to handle other types of parameters, nor does it need to handle other matrices than `A`.

`linalg::wiedemann` uses a probabilistic algorithm. For a deterministic variant enter `FALSE` for the optional parameter `prob`.

If the system  $A\vec{x} = \vec{b}$  does not have a solution, then `linalg::wiedemann` returns `FAIL`.

If the system  $A\vec{x} = \vec{b}$  has more than one solution, then a random one is returned.

Due to the probabilistic nature of Wiedemann's algorithm, the computation may fail with small probability. In this case `FAIL` is returned. If the deterministic variant is chosen, then the algorithm may be slower for a small number of matrices.

The vector `b` must be defined over the component ring of `A`.

The coefficient ring of `A` must be a field, i.e., a domain of category `Cat::Field`.



It is recommended to use `linalg:wiedemann` only if `mult` uses significantly less than  $O(n^2)$  field operations.

## Examples

### Example 1

We define a matrix and a column vector over the finite field with 29 elements:

```
MatZ29 := Dom::Matrix(Dom::IntegerMod(29)):
A := MatZ29([[1, 2, 3], [4, 7, 8], [9, 12, 17]]);
b := MatZ29([1, 2, 3])
```

$$\begin{pmatrix} 1 \bmod 29 & 2 \bmod 29 & 3 \bmod 29 \\ 4 \bmod 29 & 7 \bmod 29 & 8 \bmod 29 \\ 9 \bmod 29 & 12 \bmod 29 & 17 \bmod 29 \end{pmatrix}$$

$$\begin{pmatrix} 1 \bmod 29 \\ 2 \bmod 29 \\ 3 \bmod 29 \end{pmatrix}$$

Since  $A$  does not have a special form that would allow a fast matrix-vector multiplication, we simply use `_mult`. Wiedemann's algorithm works in this case, although it is less efficient than Gaussian elimination:

```
linalg:wiedemann(A, b, _mult)
```

$$\left[ \begin{pmatrix} 24 \bmod 29 \\ 21 \bmod 29 \\ 17 \bmod 29 \end{pmatrix}, \text{TRUE} \right]$$

### Example 2

Now let us define another matrix that has a special form:

```
MatZ29 := Dom::Matrix(Dom::IntegerMod(29));  
A := MatZ29([[1, 0, 0], [0, 1, 2], [0, 0, 1]]);  
b := MatZ29(3, 1, [1, 2, 3]):
```

$$\begin{pmatrix} 1 \bmod 29 & 0 \bmod 29 & 0 \bmod 29 \\ 0 \bmod 29 & 1 \bmod 29 & 2 \bmod 29 \\ 0 \bmod 29 & 0 \bmod 29 & 1 \bmod 29 \end{pmatrix}$$

For this particular matrix, it is easy to define an efficient multiplication method:

```
mult := proc(dummy, y)  
begin  
  y[2]:=y[2]+2*y[3];  
  y  
end:  
linalg::wiedemann(A, b, mult)
```

$$\left[ \begin{pmatrix} 1 \bmod 29 \\ 25 \bmod 29 \\ 3 \bmod 29 \end{pmatrix}, \text{TRUE} \right]$$

## Parameters

### **A**

An  $n \times n$  matrix of a domain of category `Cat::Matrix`

### **b**

An  $n$ -dimensional column vector, i.e., an  $n \times 1$  matrix of a domain of category `Cat::Matrix`

### **mult**

A matrix-vector multiplication method: function or functional expression; default: `_mult`

**prob**

TRUE or FALSE (default: TRUE)

**Return Values**

Either the list  $[x, \text{TRUE}]$  if a solution for the system  $A \vec{x} = \vec{b}$  has been found, or the list  $[x, \text{FALSE}]$  if a non-zero solution for the corresponding homogeneous system  $A \vec{x} = \vec{0}$  has been found, or the value FAIL (see below).

**Algorithms**

The expected running time for the probabilistic algorithm is  $O(n^2 + nM)$ , and the running time for the deterministic variant is  $O(n^2 M)$  in the worst case, but only  $O(n^2 + nM)$  on average. Here,  $M$  is the number of field operations that the matrix-vector multiplication routine `mult` uses.

The basic idea of the algorithm is to solve a linear system  $A \vec{x} = \vec{b}$  by finding the minimal polynomial  $f(y)$  that solves  $f(A) \vec{b} = \vec{0}$ . If the constant coefficient  $c = f(0)$  is non-zero and  $g(y) := f(y) - c$ , the equality  $g(A) \vec{b} = -c \vec{b}$  implies that  $\vec{x} = -\frac{1}{c} \left(\frac{g}{y}\right)(A)$  is the solution.

The polynomial  $f$  is found by looking for the minimal polynomial  $h$  satisfying

$\vec{u} h(A) \vec{b} = \vec{0}$  for some randomly chosen row vector  $\vec{u}$ . This may yield  $h \neq f$  in unlucky cases, but in general the probability for this is small.

**References**

- [1] Douglas Wiedemann: "Solving Sparse Linear equations over Finite Fields", IEEE Transactions on Information Theory, vol. 32, no.1, Jan. 1986.

## See Also

### MuPAD Functions

`linalg::matlinsolve` | `linalg::vandermondeSolve`

# linopt - Linear Optimization

---

## linopt::corners

Return the feasible corners of a linear program

### Syntax

```
linopt::corners([constr, obj], vars, <All>, <Logic>)
```

```
linopt::corners([constr, obj, <NonNegative>, <seti>], vars, <All>, <Logic>)
```

```
linopt::corners([constr, obj, <NonNegative>, <All>], vars, <All>, <Logic>)
```

```
linopt::corners([constr, obj, <setn>, <seti>], vars, <All>, <Logic>)
```

```
linopt::corners([constr, obj, <setn>, <All>], vars, <All>, <Logic>)
```

### Description

`linopt::corners([constr, obj], vars)` returns all valid corners of the linear program.

`linopt::corners([constr, obj], vars, All)` returns all corners of the linear program.

`[constr, obj]` is a linear program of the same structure like in `linopt::maximize`. The second parameter `vars` specifies the order in which the components of the corners found are printed; if e.g.  $\{x=1, y=2\}$  is a corner and `[x,y]` was entered, `[1,2]` will be returned.

As options, for finding the corners, one may use `All` and/or `Logic`. `All` causes the output of non-feasible corners, too, `Logic` allows the algorithm to search for corners in planes like  $x=0$ , too, although  $x \geq 0$  is not part of the input. This guarantees that for all non-empty feasible regions a corner will be found.

As the result of `linopt::corners` a triple consisting of the set of corners, the maximal objective function value found and the corner associated to it is returned. If there is no feasible corner found, only the empty set is returned.

## Examples

### Example 1

We compute all valid corners of a small linear program:

```
k := [{4 <= 2*x + 2*y, -2 <= 4*y - 2*x, -8 <= y - 2*x,
      y - 2*x <= -2, y <= 6}, x + y]:
linopt::corners(k, [x, y])
```

$$\left[ \left\{ \left[ \frac{4}{3}, \frac{2}{3} \right], \left[ \frac{5}{3}, \frac{1}{3} \right], [4, 6], [5, 2], [7, 6] \right\}, 13, [7, 6] \right]$$

Now we compute all corners, also the ones which are not valid. We see that we now get e.g. also the corner which is given by the cut of  $-2x + 4y = 2$  and  $-2x + y \leq -2$ . Here we see that the invalid corner (13,6) has the maximal objective function value 19:

```
k := [{4 <= 2*x + 2*y, -2 <= 4*y - 2*x, -8 <= y - 2*x,
      y - 2*x <= -2, y <= 6}, x + y]:
linopt::corners(k, [x, y], All)
```

$$\left[ \left\{ [-4, 6], [1, 0], \left[ \frac{4}{3}, \frac{2}{3} \right], \left[ \frac{5}{3}, \frac{1}{3} \right], \left[ \frac{10}{3}, -\frac{4}{3} \right], [4, 6], [5, 2], [7, 6], [13, 6] \right\}, 19, [13, 6] \right]$$

delete k:

### Example 2

As one can see the linear program given by the constraints  $x + y \geq -1$  and  $x + y \leq 3$  and the linear objective function  $x + 2y$  has no corners:

```
l := [{-1 <= x + y, x + y <= 3}, x + 2*y]:
linopt::corners(l, [x, y]), linopt::corners(l, [x, y], All)
```

$$\emptyset, \emptyset$$

If one also assumes a cut with a coordinate plane as a corner, some corners exist. One can use `linopt::plot_data` to visualize this problem:

```
linopt::corners(l, [x,y], Logic)
```

```
[[[-1, 0], [0, 0], [0, -1], [0, 3], [3, 0]], 6, [0, 3]]
```

```
delete l:
```

## Parameters

### **constr**

A set or list of linear constraints

### **obj**

A linear expression

### **seti**

A set which contains identifiers interpreted as indeterminants

### **setn**

A set which contains identifiers interpreted as indeterminants

### **vars**

A list containing the variables of the linear program described by `constr` and `obj` and the existing options

## Options

### **All**

This option can appear at two different places in the call of `linopt::corners`. If it is part of the linear program it means that all variables are constrained to be integers. If it appears as the third or fourth argument of the call it means that all corners, not only the valid ones should be computed by `linopt::corners`.



### **NonNegative**

All variables are constrained to be nonnegative

### **Logic**

This allows the algorithm to search for corners in planes like  $x=0$  too, although  $x \geq 0$  is not part of the linear program.

## **Return Values**

Set or a list with 3 elements.

## **References**

Papadimitriou, Christos H; Steiglitz, Kenneth: Combinatorial Optimization; Algorithms and Complexity. Prentice-Hall, 1982.

Nemhauser, George L; Wolsey, Laurence A: Integer and Combinatorial Optimization. New York, Wiley, 1988.

Salkin, Harvey M; Mathur, Kamlesh: Foundations of Integer Programming. North-Holland, 1989.

Neumann, Klaus; Morlock, Martin: Operations-Research. Munich, Hanser, 1993.

Duerr, Walter; Kleibohm, Klaus: Operations Research; Lineare Modelle und ihre Anwendungen. Munich, Hanser, 1992.

Suhl, Uwe H: MOPS - Mathematical OPTimization System. European Journal of Operational Research 72(1994)312-322. North-Holland, 1994.

Suhl, Uwe H; Szymanski, Ralf: Supernode Processing of Mixed Integer Models. Boston, Kluwer Academic Publishers, 1994.

## See Also

### MuPAD Functions

`linopt::maximize` | `linopt::minimize` | `linopt::plot_data`

# linopt::maximize

Maximize a linear or mixed-integer program

## Syntax

```
linopt::maximize([constr, obj], <DualPrices>)  
linopt::maximize([constr, obj, <NonNegative>, <seti>])  
linopt::maximize([constr, obj, <NonNegative>, <All>])  
linopt::maximize([constr, obj, <setn>, <seti>])  
linopt::maximize([constr, obj, <setn>, <All>])  
linopt::maximize([constr, obj, <NonNegative>], DualPrices)  
linopt::maximize([constr, obj, <set>], DualPrices)
```

## Description

`linopt::maximize([constr, obj])` returns the solution of the linear or mixed-integer program given by the constraints `constr` and the linear objective function `obj` which should be maximized.

The expression `obj` is the linear objective function to be maximized subject to the linear constraints `constr`. The function `linopt::maximize` returns a triple consisting of the state of the output, `OPTIMAL`, `EMPTY` or `UNBOUNDED`, a set of equations which describes the optimal solution of the specified linear program, which is empty or depends on a free variable  $\Phi$  subject to the state, and finally the maximal objective function value, which can be either a number, `-infinity` or a linear function in  $\Phi$ .

The states `OPTIMAL`, `EMPTY` or `UNBOUNDED` have the following meanings. `OPTIMAL` means an optimal solution for the linear program was found. If the state is `EMPTY` no optimal solution was found and if it is `UNBOUNDED` then the solution has no upper bound.

If the option `NonNegative` is used all variables are constrained to be nonnegative. If instead of `NonNegative` a set `setn` is given then only the variables from `setn` are constrained to be nonnegative.

If the option `All` is used all variables are constrained to be integers. If instead of `All` a set `seti` is given, then only the variables from `seti` are constrained to be integers.

As a second parameter for `linopt::maximize` the option `DualPrices` is provided for the linear case (the first parameter therefore must not have more than three elements). This option causes the output of the dual-prices in addition to the solution-triplet. In this case the result of `linopt::maximize` is a sequence of a list containing the solution-triplet and a set containing the dual prices. See "Example 4" on page 16-9 (Symbolic Math Toolbox).

## Examples

### Example 1

We try to solve the linear program

$$2c_1 \leq 1$$

$$2c_2 \leq 1$$

with the linear objective function  $c_1 + 2c_2$ :

```
linopt::maximize([2*c1 <= 1, 2*c2 <= 1], c1 + 2*c2)
```

$$\left[ \text{OPTIMAL}, \left\{ c_1 = \frac{1}{2}, c_2 = \frac{1}{2} \right\}, \frac{3}{2} \right]$$

### Example 2

Now let's have a look at the linear program

$$3x + 4y - 3z \leq 23$$

$$5x - 4y - 3z \leq 10$$

$$7x + 4y + 11z \leq 30$$

with the linear objective function  $-x + y + 2z$ . If we make no restriction to the variables the result is unbounded:

```
c := [{3*x + 4*y - 3*z <= 23, 5*x - 4*y - 3*z <= 10,
      7*x + 4*y + 11*z <= 30}, -x + y + 2*z]:
linopt::maximize(c)
```

$$\left[ \text{UNBOUNDED}, \left\{ x = -\text{PHI1}, y = 0, z = \frac{7 \text{PHI1}}{11} + \frac{30}{11} \right\}, \frac{25 \text{PHI1}}{11} + \frac{60}{11} \right]$$

But if all variables are constrained to be nonnegative, we get a result. That's also the case if only  $x$  and  $y$  are constrained to be nonnegative:

```
linopt::maximize(append(c, NonNegative));
linopt::maximize(append(c, {x, y}))
```

$$\left[ \text{OPTIMAL}, \left\{ x = 0, y = \frac{49}{8}, z = \frac{1}{2} \right\}, \frac{57}{8} \right]$$

$$\left[ \text{OPTIMAL}, \left\{ x = 0, y = \frac{49}{8}, z = \frac{1}{2} \right\}, \frac{57}{8} \right]$$

```
delete c:
```

### Example 3

The following linear program do not have a solution:

```
linopt::maximize([{x <= -1, x >= 0}, x])
```

$$[\text{EMPTY}, \emptyset, -\infty]$$

### Example 4

The output of the dual prices can be enforced with the option `DualPrices`:

```
linopt::maximize([{2*c1 <= 1, 2*c2 <= 1}, c1 + 2*c2],
                 DualPrices)
```

$[\text{OPTIMAL}, \{c_1 = \frac{1}{2}, c_2 = \frac{1}{2}\}, \frac{3}{2}], \{[c_1 \leq \frac{1}{2}, 1], [c_2 \leq \frac{1}{2}, 2]\}$

## Example 5

We have a look at the knapsack problem with  $x_1, x_2, x_3, x_4 \in \{0, 1\}$ :

```
c := {20*x1 + 15*x2 + 20*x3 + 5*x4 <= 25}:
c := c union {x1 <= 1, x2 <= 1, x3 <= 1, x4 <= 1}:
f := 10*x1 + 15*x2 + 16*x3 + x4:
linopt::maximize([c, f, NonNegative, All])
```

$[\text{OPTIMAL}, \{x_1 = 0, x_2 = 0, x_3 = 1, x_4 = 1\}, 17]$

```
delete c, f:
```

## Parameters

### **constr**

A set or list of linear constraints

### **obj**

A linear expression

### **seti**

A set which contains identifiers interpreted as indeterminates

### **setn**

A set which contains identifiers interpreted as indeterminates

## Options

### **All**

All variables are constrained to be integers

### **NonNegative**

All variables are constrained to be nonnegative

### **DualPrices**

This option is only available in the linear case. It causes the output of the dual-prices in addition to the solution-triple.

## Return Values

List or a sequence of a list and a set containing the solution of the linear or mixed-integer program.

## References

Papadimitriou, Christos H; Steiglitz, Kenneth: Combinatorial Optimization; Algorithms and Complexity. Prentice-Hall, 1982.

Nemhauser, George L; Wolsey, Laurence A: Integer and Combinatorial Optimization. New York, Wiley, 1988.

Salkin, Harvey M; Mathur, Kamlesh: Foundations of Integer Programming. North-Holland, 1989.

Neumann, Klaus; Morlock, Martin: Operations-Research. Munich, Hanser, 1993.

Duerr, Walter; Kleibohm, Klaus: Operations Research; Lineare Modelle und ihre Anwendungen. Munich, Hanser, 1992.

Suhl, Uwe H: MOPS - Mathematical OPTimization System. European Journal of Operational Research 72(1994)312-322. North-Holland, 1994.

Suhl, Uwe H; Szymanski, Ralf: Supernode Processing of Mixed Integer Models. Boston, Kluwer Academic Publishers, 1994.

## **See Also**

### **MuPAD Functions**

`linopt::corners` | `linopt::minimize` | `linopt::plot_data`



# linopt::minimize

Minimize a linear or mixed-integer program

## Syntax

```
linopt::minimize([constr, obj], <DualPrices>)  
linopt::minimize([constr, obj, <NonNegative>, <seti>])  
linopt::minimize([constr, obj, <NonNegative>, <All>])  
linopt::minimize([constr, obj, <setn>, <seti>])  
linopt::minimize([constr, obj, <setn>, <All>])  
linopt::minimize([constr, obj, <NonNegative>], DualPrices)  
linopt::minimize([constr, obj, <set>], DualPrices)
```

## Description

`linopt::minimize([constr, obj])` returns the solution of the linear or mixed-integer program given by the constraints `constr` and the linear objective function `obj` which should be minimized.

The expression `obj` is the linear objective function to be minimized subject to the linear constraints `constr`. The function `linopt::minimize` returns a triple consisting of the state of the output, `OPTIMAL`, `EMPTY` or `UNBOUNDED`, a set of equations which describes the optimal solution of the specified linear program, which is empty or depends on a free variable  $\Phi$  subject to the state, and finally the minimal objective function value, which can be either a number, `infinity` or a linear function in  $\Phi$ .

The states `OPTIMAL`, `EMPTY` or `UNBOUNDED` have the following meanings. `OPTIMAL` means an optimal solution for the linear program was found. If the state is `EMPTY` no optimal solution was found and if it is `UNBOUNDED` then the solution has no upper bound.

If the option `NonNegative` is used all variables are constrained to be nonnegative. If instead of `NonNegative` a set `setn` is given then only the variables from `setn` are constrained to be nonnegative.

If the option `All` is used all variables are constrained to be integers. If instead of `All` a set `seti` is given, then only the variables from `seti` are constrained to be integers.

As a second parameter for `linopt::minimize` the option `DualPrices` is provided for the linear case (the first parameter therefore must not have more than three elements). This option causes the output of the dual-prices in addition to the solution-triplet. In this case the result of `linopt::minimize` is a sequence of a list containing the solution-triplet and a set containing the dual prices. See "Example 4" on page 16-15 (Symbolic Math Toolbox).

## Examples

### Example 1

We try to solve the linear program

$$\begin{aligned}c_1 + c_2 &\leq 3 \\c_2 &\leq 9\end{aligned}$$

with the linear objective function  $-c_1 - c_2$ :

```
linopt::minimize([c1 + c2 <= 3, c2 <= 9], -c1 - c2)
```

```
[OPTIMAL, {c1 = 0, c2 = 3}, -3]
```

### Example 2

Now let's have a look at the linear program

$$\begin{aligned}3x + 4y - 3z &\leq 23 \\5x - 4y - 3z &\leq 10 \\7x + 4y + 11z &\leq 30\end{aligned}$$

with the linear objective function  $-x + y + 2z$ . If we make no restriction to the variables the result is unbounded:

```
c := [{3*x + 4*y - 3*z <= 23, 5*x - 4*y - 3*z <= 10,
      7*x + 4*y + 11*z <= 30}, -x + y + 2*z]:
linopt::minimize(c)
```

$$\left[ \text{UNBOUNDED}, \left\{ y = -\text{PHI1}, x = -4 \text{PHI1} - \frac{13}{2}, \right. \right. \\ \left. \left. z = -\frac{16 \text{PHI1}}{3} - \frac{85}{6} \right\}, -\frac{23 \text{PHI1}}{3} - \frac{131}{6} \right]$$

But if all variables are constrained to be nonnegative, we get a result. That's also the case if only  $x$  and  $y$  are constrained to be nonnegative:

```
linopt::minimize(append(c, NonNegative));
linopt::minimize(append(c, {x, y}))
```

$$[\text{OPTIMAL}, \{x = 2, y = 0, z = 0\}, -2]$$

$$[\text{OPTIMAL}, \left\{ x = 0, y = \frac{13}{8}, z = -\frac{11}{2} \right\}, -\frac{75}{8}]$$

```
delete c:
```

### Example 3

The following linear program does not have a solution:

```
linopt::minimize([{x <= -1, x >= 0}, x])
```

$$[\text{EMPTY}, \emptyset, \infty]$$

### Example 4

The output of the dual prices can be enforced with the option `DualPrices`:

```
linopt::minimize([{c1 + c2 <= 3, c2 <= 9}, -c1 - c2],  
                DualPrices)  
  
[OPTIMAL, {c1 = 0, c2 = 3}, -3], {[c1 + c2 ≤ 3, 1], [c2 ≤ 9, 0]}
```

## Parameters

### **constr**

A set or list of linear constraints

### **obj**

A linear expression

### **seti**

S set which contains identifiers interpreted as indeterminates

### **setn**

A set which contains identifiers interpreted as indeterminates

## Options

### **ALL**

All variables are constrained to be integer

### **NonNegative**

All variables are constrained to be nonnegative

### **DualPrices**

This option is only available in the linear case. It causes the output of the dual-prices in addition to the solution-triplet.

## Return Values

List or a sequence of a list and a set containing the solution of the linear or mixed-integer program.

## References

Papadimitriou, Christos H; Steiglitz, Kenneth: Combinatorial Optimization; Algorithms and Complexity. Prentice-Hall, 1982.

Nemhauser, George L; Wolsey, Laurence A: Integer and Combinatorial Optimization. New York, Wiley, 1988.

Salkin, Harvey M; Mathur, Kamlesh: Foundations of Integer Programming. North-Holland, 1989.

Neumann, Klaus; Morlock, Martin: Operations-Research. Munich, Hanser, 1993.

Duerr, Walter; Kleibohm, Klaus: Operations Research; Lineare Modelle und ihre Anwendungen. Munich, Hanser, 1992.

Suhl, Uwe H: MOPS - Mathematical OPTimization System. European Journal of Operational Research 72(1994)312-322. North-Holland, 1994.

Suhl, Uwe H; Szymanski, Ralf: Supernode Processing of Mixed Integer Models. Boston, Kluwer Academic Publishers, 1994.

## See Also

### **MuPAD Functions**

`linopt::corners` | `linopt::maximize` | `linopt::plot_data`

## linopt::plot\_data

Plot the feasible region of a linear program

### Syntax

```
linopt::plot_data([constr, obj, <NonNegative>, <seti>], vars)
```

```
linopt::plot_data([constr, obj, <NonNegative>, <All>], vars)
```

```
linopt::plot_data([constr, obj, <setn>, <seti>], vars)
```

```
linopt::plot_data([constr, obj, <setn>, <All>], vars)
```

### Description

`linopt::plot_data([constr, obj], vars)` returns a graphical description of the feasible region of the linear program `[constr, obj]`, and the line vertical to the objective function vector through the corner with the maximal objective function value found.

`[constr, obj]` is a linear program with exactly two variables. The problem has the same structure like in `linopt::maximize`. The second parameter `vars` specifies which variable belongs to the horizontal and vertical axis.

### Examples

#### Example 1

We plot the feasible region of the given linear program. Here the valid corners of the linear program are easy to see:

```
k := [{2*x + 2*y >= 4, -2*x + 4*y >= -2, -2*x + y >= -8,  
      -2*x + y <= -2, y <= 6}, x + y, NonNegative]:  
g := linopt::plot_data(k, [x, y]):  
plot(g):
```

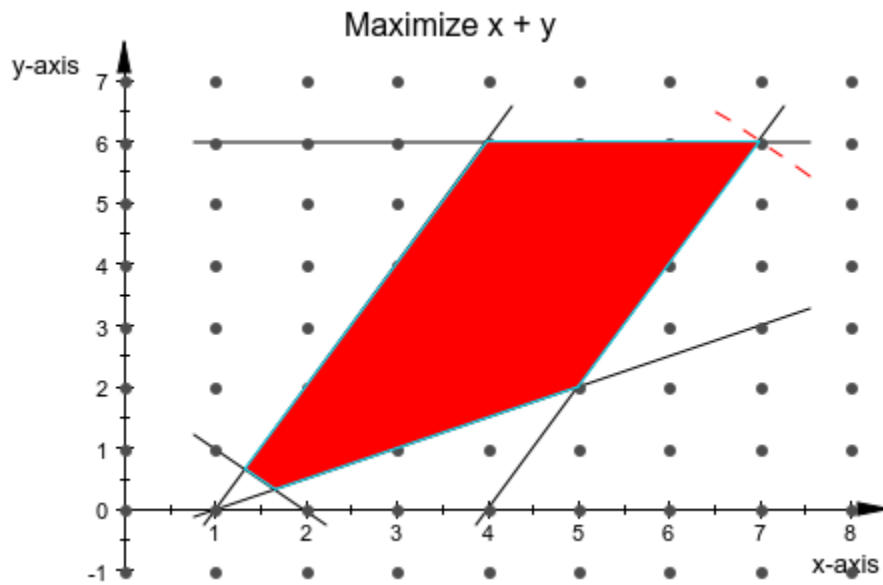

In this example there is no difference if the Option NonNegative is given for the linear program or not:

```
k := [{2*x + 2*y >= 4, -2*x + 4*y >= -2, -2*x + y >= -8,
      -2*x + y <= -2, y <= 6}, x + y]:
g := linopt::plot_data(k, [x, y]):
plot(g):
```

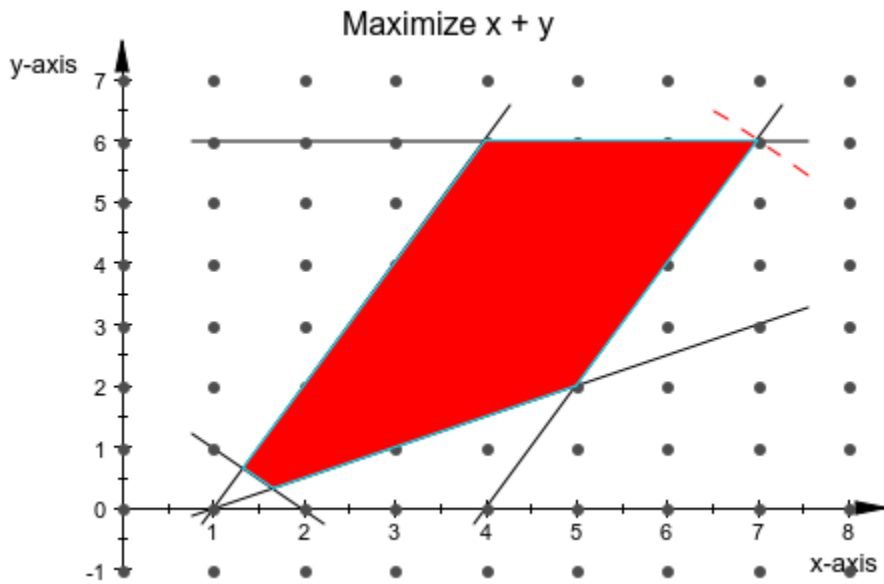

delete k, g:

## Example 2

Now we give an example where one can see a difference if the variables are constrained to be nonnegative:

```
k := [{x + y >= -1, x + y <= 3}, x + 2*y]:
g := linopt::plot_data(k, [x, y]):
plot(g):
```



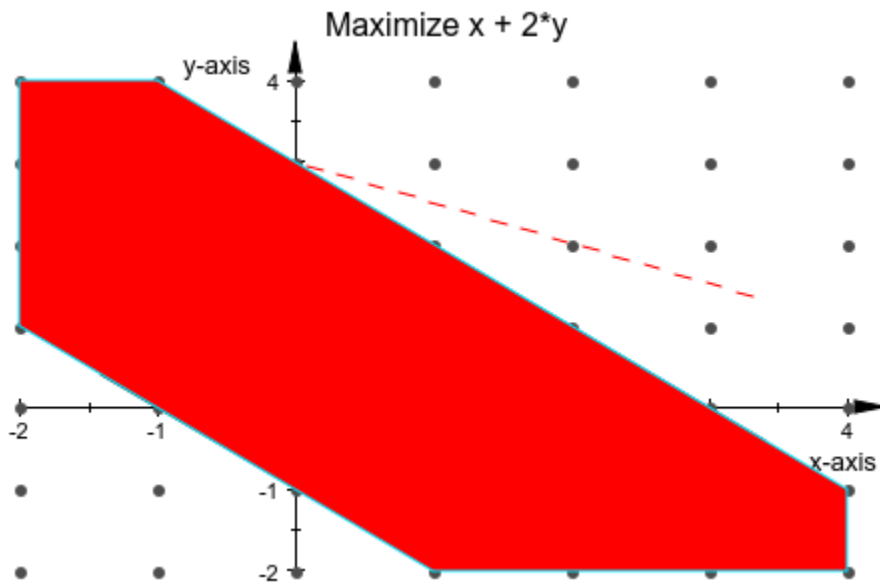

```
k := [{x + y >= -1, x + y <= 3}, x + 2*y, NonNegative]:  
g := linopt::plot_data(k, [x, y]):  
plot(g):
```

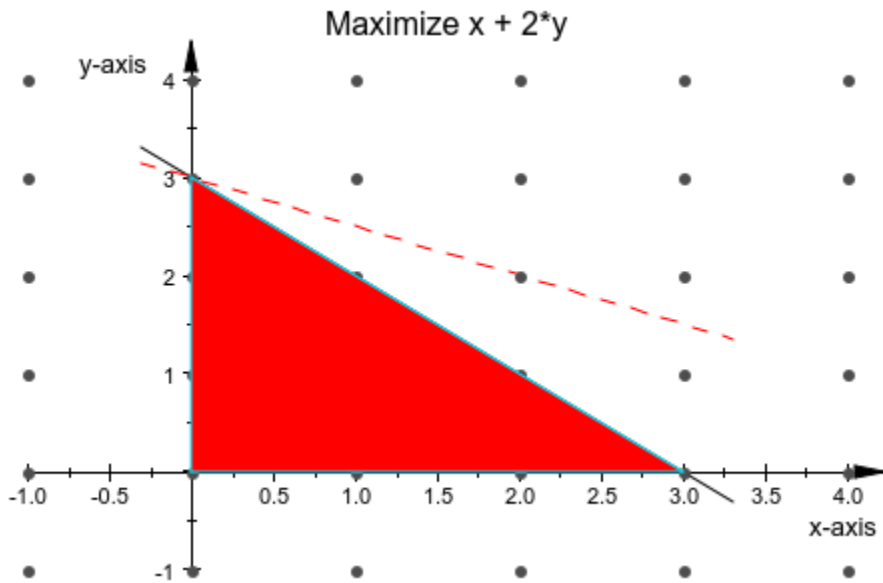

delete k, g:

## Parameters

### **constr**

A set or list of linear constraints

### **obj**

A linear expression

### **seti**

A set which contains identifiers interpreted as indeterminates

### **setn**

A set which contains identifiers interpreted as indeterminates

**vars**

A list containing the two variables of the linear program described by `constr` and `obj` and the existing options

## Options

**All**

All variables are constrained to be integer

**NonNegative**

All variables are constrained to be nonnegative

## Return Values

Expression describing a graphical object which can be used by `plot`.

## References

Papadimitriou, Christos H; Steiglitz, Kenneth: Combinatorial Optimization; Algorithms and Complexity. Prentice-Hall, 1982.

Nemhauser, George L; Wolsey, Laurence A: Integer and Combinatorial Optimization. New York, Wiley, 1988.

Salkin, Harvey M; Mathur, Kamlesh: Foundations of Integer Programming. North-Holland, 1989.

Neumann, Klaus; Morlock, Martin: Operations-Research. Munich, Hanser, 1993.

Duerr, Walter; Kleibohm, Klaus: Operations Research; Lineare Modelle und ihre Anwendungen. Munich, Hanser, 1992.

Suhl, Uwe H: MOPS - Mathematical OPTimization System. European Journal of Operational Research 72(1994)312-322. North-Holland, 1994.

Suhl, Uwe H; Szymanski, Ralf: Supernode Processing of Mixed Integer Models. Boston, Kluwer Academic Publishers, 1994.

## **See Also**

### **MuPAD Functions**

`linopt::corners` | `linopt::maximize` | `linopt::minimize`

# linopt::Transparent

Return the ordinary simplex tableau of a linear program

## Syntax

```
linopt::Transparent([constr, obj, <NonNegative>, <seti>])
```

```
linopt::Transparent([constr, obj, <NonNegative>, <All>])
```

```
linopt::Transparent([constr, obj, <setn>, <seti>])
```

```
linopt::Transparent([constr, obj, <setn>, <All>])
```

## Description

`linopt::Transparent([constr, obj])` returns the ordinary simplex tableau of the given linear program given by the constraints `constr` and the linear objective function `obj`.

`[constr, obj]` is a Linear Optimization Problem of the same structure like in `linopt::maximize`. As the result the ordinary simplex tableau of the given problem is returned; this means that equations will be replaced by two unequations and unbounded variables will be replaced by two new variables.

Internally the tableau returned consists of more information than viewable on the screen. Therefore `linopt::Transparent::convert` is provided to perform the transduction into the structure of the screen-tableau. (This can be necessary if the returned tableau shall serve as an input-parameter for another function — e.g. a user defined procedure for the selection of pivot elements.) If an ordinary simplex with two phases is wished, the next step should be the call of `linopt::Transparent::phaseI_tableau`.

All functions of the `linopt` library using the tableau returned by `linopt::Transparent` try to minimize the problem! Therefore it can be necessary to multiply the objective function with `-1` first.

In the simplex tableau returned a special notation is used. "linopt" stands for the tableau them self, "obj" describes the linear objective function, "restr" stands for the vector of

restrictions, `slk[1]`, `slk[2]`, ... are the slack variables and the names of the other variables stand for themselves. Variables which are given as row labels indicate that they are part of the base.

## Examples

### Example 1

First a small example, returning the ordinary simplex tableau of the given linear program. One can see that the slack variables are forming the basis:

```
k := [{x + y >= -1, x + y <= 3}, x + 2*y, NonNegative]:
linopt::Transparent(k)
```

$$\begin{pmatrix} \text{"linopt"} & \text{"restr"} & \text{slk}_1 & \text{slk}_2 & y & x \\ \text{"obj"} & & 0 & 0 & 2 & 1 \\ \text{slk}_1 & & 1 & 1 & 0 & -1 & -1 \\ \text{slk}_2 & & 3 & 0 & 1 & 1 & 1 \end{pmatrix}$$

It follows a little bit larger example:

```
k := [{3*x + 4*y - 3*z <= 23, 5*x - 4*y - 3*z <= 10,
       7*x + 4*y + 11*z <= 30}, -x + y + 2*z, NonNegative]:
linopt::Transparent(k)
```

$$\begin{pmatrix} \text{"linopt"} & \text{"restr"} & \text{slk}_1 & \text{slk}_2 & \text{slk}_3 & y & x & z \\ \text{"obj"} & & 0 & 0 & 0 & 1 & -1 & 2 \\ \text{slk}_1 & & 23 & 1 & 0 & 4 & 3 & -3 \\ \text{slk}_2 & & 10 & 0 & 1 & 0 & -4 & 5 & -3 \\ \text{slk}_3 & & 30 & 0 & 0 & 1 & 4 & 7 & 11 \end{pmatrix}$$

The result of `linopt::Transparent` is of domain type `linopt::Transparent`. So it can be used as input for other `linopt::Transparent::*` function, e.g. for `linopt::Transparent::suggest`:

```
k := [{x + y >= -1, x + y <= 3}, x + 2*y, NonNegative]:  
t := linopt::Transparent(k):  
domtype(t), linopt::Transparent::suggest(t)
```

linopt::Transparent, OPTIMAL

delete k, t:

## Parameters

### **constr**

A set or list of linear constraints

### **obj**

A linear expression

### **seti**

A set which contains identifiers interpreted as indeterminates

### **setn**

A set which contains identifiers interpreted as indeterminates

## Options

### **All**

All variables are constrained to be integer

### **NonNegative**

All variables are constrained to be nonnegative

## Return Values

Simplex tableau of domain type `linopt::Transparent`.

## References

Papadimitriou, Christos H; Steiglitz, Kenneth: Combinatorial Optimization; Algorithms and Complexity. Prentice-Hall, 1982.

Nemhauser, George L; Wolsey, Laurence A: Integer and Combinatorial Optimization. New York, Wiley, 1988.

Salkin, Harvey M; Mathur, Kamlesh: Foundations of Integer Programming. North-Holland, 1989.

Neumann, Klaus; Morlock, Martin: Operations-Research. Munich, Hanser, 1993.

Duerr, Walter; Kleibohm, Klaus: Operations Research; Lineare Modelle und ihre Anwendungen. Munich, Hanser, 1992.

Suhl, Uwe H: MOPS - Mathematical OPTimization System. European Journal of Operational Research 72(1994)312-322. North-Holland, 1994.

Suhl, Uwe H; Szymanski, Ralf: Supernode Processing of Mixed Integer Models. Boston, Kluwer Academic Publishers, 1994.

## See Also

### **MuPAD Functions**

`linopt::Transparent::autostep` | `linopt::Transparent::convert` |  
`linopt::Transparent::dual_prices` |  
`linopt::Transparent::phaseII_tableau` |  
`linopt::Transparent::phaseI_tableau` | `linopt::Transparent::result` |  
`linopt::Transparent::simplex` | `linopt::Transparent::suggest` |  
`linopt::Transparent::userstep`



# linopt::Transparent::autostep

Perform the next simplex step

## Syntax

```
linopt::Transparent::autostep(tableau)
```

## Description

`linopt::Transparent::autostep(tableau)` performs the next step of the simplex algorithm. This is the same step that `linopt::Transparent::suggest` would suggest for the given simplex tableau `tableau`.

Normally `linopt::Transparent::autostep` returns the next simplex tableau. If the calculation of the simplex algorithm is finished `linopt::Transparent::autostep` returns a set containing a solution of the given linear program described by `tableau`.

## Examples

### Example 1

The ordinary simplex tableau of a given linear program is created:

```
k := [{x + y >= 2}, x, NonNegative];
t := linopt::Transparent(k)
```

$$\begin{pmatrix} \text{"linopt"} & \text{"restr"} & \text{slk}_1 & y & x \\ \text{"obj"} & 0 & 0 & 0 & 1 \\ \text{slk}_1 & -2 & 1 & -1 & -1 \end{pmatrix}$$

The next two steps of the simplex algorithm are executed for the given simplex tableau:

```
linopt::Transparent::autostep(t);
linopt::Transparent::autostep(%)
```

$$\begin{pmatrix} \text{"linopt"} & \text{"restr"} & \text{slk}_1 & y & x \\ \text{"obj"} & & -2 & 1 & -1 & 0 \\ x & & 2 & -1 & 1 & 1 \end{pmatrix}$$

$$\begin{pmatrix} \text{"linopt"} & \text{"restr"} & \text{slk}_1 & y & x \\ \text{"obj"} & & 0 & 0 & 0 & 1 \\ y & & 2 & -1 & 1 & 1 \end{pmatrix}$$

```
delete k, t:
```

## Example 2

The ordinary simplex tableau of a given linear program is created:

```
k := [{x + y >= -1, x + y <= 3}, x + 2*y, NonNegative]:  
t := linopt::Transparent(k)
```

$$\begin{pmatrix} \text{"linopt"} & \text{"restr"} & \text{slk}_1 & \text{slk}_2 & y & x \\ \text{"obj"} & & 0 & 0 & 0 & 2 & 1 \\ \text{slk}_1 & & 1 & 1 & 0 & -1 & -1 \\ \text{slk}_2 & & 3 & 0 & 1 & 1 & 1 \end{pmatrix}$$

If the end of the simplex algorithm is reached, `linopt::Transparent::autostep` returns a solution of the given linear program:

```
linopt::Transparent::suggest(t),  
linopt::Transparent::autostep(t)
```

```
OPTIMAL, {x = 0, y = 0}
```

```
delete k, t:
```

## Parameters

### **tableau**

A simplex tableau of domain type `linopt::Transparent`

## Return Values

Simplex tableau of domain type `linopt::Transparent` or a set which contains the solution of the linear program.

## References

Papadimitriou, Christos H; Steiglitz, Kenneth: Combinatorial Optimization; Algorithms and Complexity. Prentice-Hall, 1982.

Nemhauser, George L; Wolsey, Laurence A: Integer and Combinatorial Optimization. New York, Wiley, 1988.

Salkin, Harvey M; Mathur, Kamlesh: Foundations of Integer Programming. North-Holland, 1989.

Neumann, Klaus; Morlock, Martin: Operations-Research. Munich, Hanser, 1993.

Duerr, Walter; Kleibohm, Klaus: Operations Research; Lineare Modelle und ihre Anwendungen. Munich, Hanser, 1992.

Suhl, Uwe H: MOPS - Mathematical OPTimization System. European Journal of Operational Research 72(1994)312-322. North-Holland, 1994.

Suhl, Uwe H; Szymanski, Ralf: Supernode Processing of Mixed Integer Models. Boston, Kluwer Academic Publishers, 1994.

## See Also

### **MuPAD Functions**

`linopt::Transparent` | `linopt::Transparent::convert` |  
`linopt::Transparent::dual_prices` | `linopt::Transparent::phaseI_tableau`

```
| linopt::Transparent::result | linopt::Transparent::simplex |  
linopt::Transparent::suggest | linopt::Transparent::userstep
```

# linopt::Transparent::clean\_basis

Delete all slack variables of the first phase from the basis

## Syntax

```
linopt::Transparent::clean_basis(tableau)
```

## Description

`linopt::Transparent::clean_basis(tableau)` removes the additional slack variables of the phase one of the simplex algorithm from the optimal basic (described by `tableau`) calculated by `linopt::Transparent::phaseI_tableau` and `linopt::Transparent::simplex`.

At the end of the phase one of the 2-phase simplex algorithm, explicitly started by using `linopt::Transparent::phaseI_tableau`, it is necessary to eliminate all artificial variables from the optimal basis before phase two can be started by using `linopt::Transparent::phaseII_tableau`. `linopt::Transparent::clean_basis` performs some pivot steps until all phase one slack variables do not occur in the basis any longer.

## Examples

### Example 1

In this example we first compute an optimal basis for the first phase of the simplex algorithm:

```
t := linopt::Transparent([{x <= 1, y <= 1, x + y >= 2},  
                        0, NonNegative]):  
t := linopt::Transparent::phaseI_tableau(t):  
t := linopt::Transparent::simplex(t)
```

$$\begin{pmatrix} \text{"linopt"} & \text{"restr"} & \text{slk}_4 & \text{slk}_5 & \text{slk}_6 & \text{slk}_1 & \text{slk}_2 & \text{slk}_3 & y & x \\ \text{"obj"} & & 0 & 2 & 2 & 0 & 1 & 1 & 1 & 0 & 0 \\ x & & 1 & 1 & 0 & 0 & 1 & 0 & 0 & 0 & 1 \\ y & & 1 & 0 & 1 & 0 & 0 & 1 & 0 & 1 & 0 \\ \text{slk}_6 & & 0 & -1 & -1 & 1 & -1 & -1 & -1 & 0 & 0 \end{pmatrix}$$

As we can see the artificial slack variable `slk[6]` is an element of the optimal basis. An error message is returned if we apply `linopt::Transparent::phaseII_tableau` or `linopt::Transparent::simplex` to this simplex tableau:

```
linopt::Transparent::phaseII_tableau(t);
```

Error: Clean the basis from phase I slack variables first. [linopt::Transparent::phaseII\_tableau]

So we have to use `linopt::Transparent::clean_basis` before continuing with the appropriate function:

```
t := linopt::Transparent::clean_basis(t);
linopt::Transparent::phaseII_tableau(t)
```

$$\begin{pmatrix} \text{"linopt"} & \text{"restr"} & \text{slk}_4 & \text{slk}_5 & \text{slk}_6 & \text{slk}_1 & \text{slk}_2 & \text{slk}_3 & y & x \\ \text{"obj"} & & 0 & 1 & 1 & 1 & 0 & 0 & 0 & 0 & 0 \\ x & & 1 & 0 & -1 & 1 & 0 & -1 & -1 & 0 & 1 \\ y & & 1 & 0 & 1 & 0 & 0 & 1 & 0 & 1 & 0 \\ \text{slk}_1 & & 0 & 1 & 1 & -1 & 1 & 1 & 1 & 0 & 0 \end{pmatrix}$$

$$\begin{pmatrix} \text{"linopt"} & \text{"restr"} & \text{slk}_1 & \text{slk}_2 & \text{slk}_3 & y & x \\ \text{"obj"} & & 0 & 0 & 0 & 0 & 0 & 0 \\ x & & 1 & 0 & -1 & -1 & 0 & 1 \\ y & & 1 & 0 & 1 & 0 & 1 & 0 \\ \text{slk}_1 & & 0 & 1 & 1 & 1 & 0 & 0 \end{pmatrix}$$

```
delete t;
```

## Parameters

### **tableau**

A simplex tableau of domain type `linopt::Transparent`

## Return Values

Simplex tableau of domain type `linopt::Transparent`.

## References

Papadimitriou, Christos H; Steiglitz, Kenneth: Combinatorial Optimization; Algorithms and Complexity. Prentice-Hall, 1982.

Nemhauser, George L; Wolsey, Laurence A: Integer and Combinatorial Optimization. New York, Wiley, 1988.

Salkin, Harvey M; Mathur, Kamlesh: Foundations of Integer Programming. North-Holland, 1989.

Neumann, Klaus; Morlock, Martin: Operations-Research. Munich, Hanser, 1993.

Duerr, Walter; Kleibohm, Klaus: Operations Research; Lineare Modelle und ihre Anwendungen. Munich, Hanser, 1992.

Suhl, Uwe H: MOPS - Mathematical OPTimization System. European Journal of Operational Research 72(1994)312-322. North-Holland, 1994.

Suhl, Uwe H; Szymanski, Ralf: Supernode Processing of Mixed Integer Models. Boston, Kluwer Academic Publishers, 1994.

## See Also

### **MuPAD Functions**

`linopt::Transparent` | `linopt::Transparent::autostep` |  
`linopt::Transparent::convert` | `linopt::Transparent::dual_prices` |

```
linopt::Transparent::phaseII_tableau | linopt::Transparent::result |  
linopt::Transparent::simplex | linopt::Transparent::suggest |  
linopt::Transparent::userstep
```



# linopt::Transparent::convert

Transform the given tableau into a structure printable on screen

## Syntax

```
linopt::Transparent::convert(tableau)
```

## Description

`linopt::Transparent::convert` converts `tableau` into a two dimensional array which corresponds with the screen-tableau. One can now access the element in the  $i$ -th row and  $j$ -th column of the simplex tableau by accessing the corresponding element of the array.

Internally the given `tableau` of domain type `linopt::Transparent` contains a lot of more information than the simplex tableau which is printed by some functions of the `linopt` library, e.g. `linopt::Transparent::simplex`, and which is visible on the screen. Furthermore it is not possible to access the element in the  $i$ -th row and  $j$ -th column of `tableau` to get the corresponding element from the simplex tableau which is visible on the screen.

While the internal structure of `tableau` is not known the structure of the two dimensional array is well defined. So it can be easily used in own procedures. See "Example 2" on page 16-38 (Symbolic Math Toolbox).

## Examples

### Example 1

We convert a simplex tableau of domain type `linopt::Transparent` into a two dimensional array:

```
k := [{x + y >= 2}, x, NonNegative]:  
t := linopt::Transparent(k):
```

```
a := linopt::Transparent::convert(t):  
t, domtype(t);  
a, domtype(a)
```

$$\begin{pmatrix} \text{"linopt"} & \text{"restr"} & \text{slk}_1 & y & x \\ \text{"obj"} & 0 & 0 & 0 & 1 \\ \text{slk}_1 & -2 & 1 & -1 & -1 \end{pmatrix}, \text{linopt::Transparent}$$

$$\begin{pmatrix} \text{"linopt"} & \text{"restr"} & \text{slk}_1 & y & x \\ \text{"obj"} & 0 & 0 & 0 & 1 \\ \text{slk}_1 & -2 & 1 & -1 & -1 \end{pmatrix}, \text{DOM\_ARRAY}$$

```
delete a, k, t:
```

## Example 2

We will write another simplex routine `mysimplex` for solving a linear program. For this we define the function `eigenpivot` for finding the pivot element of a given simplex tableau. `eigenpivot` assumes that the simplex tableau is given as a two dimensional array.

Here is the procedure `eigenpivot`, which is not coded in every detail, e.g., the error checking isn't implemented completely:

```
eigenpivot := proc(T: DOM_ARRAY)  
  local i,j,m,n,k,l,mini;  
  begin  
    m := op(T,[0,2,2]):  
    n := op(T,[0,3,2]):  
    k := 0:  
    l := 0:  
    mini := unbesetzt:  
  
    for j from 3 to n do  
      if T[2,j] < 0 then  
        l := j:  
        break  
      end_if:  
    end_for:  
    if l=0 then return(OPTIMAL) end_if:
```

```

    for i from 3 to m do
      if T[i,l] > 0 and (mini=unbesetzt or T[i,2]/T[i,l] < mini) then
        k := i:
        mini := T[k,2]/T[k,l]
      end_if
    end_for:
    if k=0 then return(UNBOUNDED) end_if:
    return(T[k,1],T[1,l]):
end_proc:

```

This is the new simplex algorithm `mysimplex` which uses `eigenpivot` and some function from the `linopt` library:

```

mysimplex := proc(P)
  local T;
  begin
    T := linopt::Transparent(P):
    T := linopt::Transparent::phaseI_tableau(T):
    piv := eigenpivot(linopt::Transparent::convert(T)):
    while piv <> OPTIMAL and piv <> UNBOUNDED do
      T := linopt::Transparent::userstep(T,piv):
      piv := eigenpivot(linopt::Transparent::convert(T))
    end_while:

    if piv = UNBOUNDED then
      error(" Phase I unbounded !?")
    end_if:
    if T[2,2] <> 0
      then return(EMPTY)
    end_if:
    T := linopt::Transparent::clean_basis(T):

    T := linopt::Transparent::phaseII_tableau(T):
    piv := eigenpivot(linopt::Transparent::convert(T)):
    while piv <> OPTIMAL and piv <> UNBOUNDED do
      T := linopt::Transparent::userstep(T,piv):
      piv := eigenpivot(linopt::Transparent::convert(T))
    end_while:

    if piv = OPTIMAL
      then return(linopt::Transparent::result(T))
      else return(UNBOUNDED)
    end_if
  end_proc:

```

We now apply `mysimplex` to a linear program:

```
k := [{2*x + 2*y >= 4, -2*x + 4*y >= -2, -2*x + y >= -8,  
      -2*x + y <= -2, y <= 6}, -x - y]:  
k := append(k, NonNegative):  
mysimplex(k);
```

$\{x=7, y=6\}$

```
delete k, eigenpivot, mysimplex:
```

## Parameters

### `tableau`

A simplex tableau of domain type

## Return Values

Two dimensional array, representing the given simplex tableau `tableau`.

## References

Papadimitriou, Christos H; Steiglitz, Kenneth: Combinatorial Optimization; Algorithms and Complexity. Prentice-Hall, 1982.

Nemhauser, George L; Wolsey, Laurence A: Integer and Combinatorial Optimization. New York, Wiley, 1988.

Salkin, Harvey M; Mathur, Kamlesh: Foundations of Integer Programming. North-Holland, 1989.

Neumann, Klaus; Morlock, Martin: Operations-Research. Munich, Hanser, 1993.

Duerr, Walter; Kleibohm, Klaus: Operations Research; Lineare Modelle und ihre Anwendungen. Munich, Hanser, 1992.

Suhl, Uwe H: MOPS - Mathematical OPTimization System. European Journal of Operational Research 72(1994)312-322. North-Holland, 1994.

Suhl, Uwe H; Szymanski, Ralf: Supernode Processing of Mixed Integer Models. Boston, Kluwer Academic Publishers, 1994.

## See Also

### **MuPAD Functions**

linopt::Transparent | linopt::Transparent::autostep |  
linopt::Transparent::phaseII\_tableau |  
linopt::Transparent::phaseI\_tableau | linopt::Transparent::suggest |  
linopt::Transparent::userstep

## linopt::Transparent::dual\_prices

Get the dual solution belonging to the given tableau

### Syntax

```
linopt::Transparent::dual_prices(tableau)
```

### Description

`linopt::Transparent::dual_prices(tableau)` returns the dual solution of the linear optimization problem given by `tableau`.

This procedure returns the dual solution belonging to the given tableau in form of a set of lists containing two elements, the first one is a restriction and the second one is the value belonging to the slack variable connected to the restriction in the dual solution.

### Examples

#### Example 1

Here it is demonstrated that the dual solution of the final tableau is similar to the second element of the result of `linopt::minimize` using the option `DualPrices`:

First we compute the final tableau of the simplex algorithm:

```
k := [{x <= 2, y <= 2, x + 2*y >= 4}, - x + y, NonNegative]:  
t := linopt::Transparent(k):  
t := linopt::Transparent::simplex(t)
```

$$\begin{pmatrix} \text{"linopt"} & \text{"restr"} & \text{slk}_1 & \text{slk}_2 & \text{slk}_3 & y & x \\ \text{"obj"} & & 1 & \frac{3}{2} & 0 & \frac{1}{2} & 0 & 0 \\ x & & 2 & 1 & 0 & 0 & 0 & 1 \\ \text{slk}_2 & & 1 & \frac{1}{2} & 1 & \frac{1}{2} & 0 & 0 \\ y & & 1 & -\frac{1}{2} & 0 & -\frac{1}{2} & 1 & 0 \end{pmatrix}$$

Now we compute the solutions:

```
linopt::Transparent::dual_prices(t);
linopt::minimize(k, DualPrices)[2]
```

$$\left\{ \left[ 4 \leq x + 2y, \frac{1}{2} \right], [0 \leq x, 0], \left[ x \leq 2, \frac{3}{2} \right], [0 \leq y, 0], [y \leq 2, 0] \right\}$$

$$\left\{ \left[ 4 \leq x + 2y, \frac{1}{2} \right], [0 \leq x, 0], \left[ x \leq 2, \frac{3}{2} \right], [0 \leq y, 0], [y \leq 2, 0] \right\}$$

delete k, t:

## Example 2

We compute the dual solution of another linear program:

```
k := [{x <= 2, y <= 2, x + 2*y >= 4}, -x + y, NonNegative];
t := linopt::Transparent(k);
linopt::Transparent::dual_prices(t)
```

$$\begin{pmatrix} \text{"linopt"} & \text{"restr"} & \text{slk}_1 & \text{slk}_2 & \text{slk}_3 & y & x \\ \text{"obj"} & & 0 & 0 & 0 & 0 & 1 & -1 \\ \text{slk}_1 & & 2 & 1 & 0 & 0 & 0 & 1 \\ \text{slk}_2 & & 2 & 0 & 1 & 0 & 1 & 0 \\ \text{slk}_3 & & -4 & 0 & 0 & 1 & -2 & -1 \end{pmatrix}$$

$$\{[4 \leq x + 2y, 0], [0 \leq x, -1], [x \leq 2, 0], [0 \leq y, 1], [y \leq 2, 0]\}$$

delete k, t:

## Parameters

### tableau

A simplex tableau of domain type `linopt::Transparent`

## Return Values

Set of lists, each containing 2 elements.

## References

Papadimitriou, Christos H; Steiglitz, Kenneth: Combinatorial Optimization; Algorithms and Complexity. Prentice-Hall, 1982.

Nemhauser, George L; Wolsey, Laurence A: Integer and Combinatorial Optimization. New York, Wiley, 1988.

Salkin, Harvey M; Mathur, Kamlesh: Foundations of Integer Programming. North-Holland, 1989.

Neumann, Klaus; Morlock, Martin: Operations-Research. Munich, Hanser, 1993.

Duerr, Walter; Kleibohm, Klaus: Operations Research; Lineare Modelle und ihre Anwendungen. Munich, Hanser, 1992.

Suhl, Uwe H: MOPS - Mathematical OPTimization System. European Journal of Operational Research 72(1994)312-322. North-Holland, 1994.

Suhl, Uwe H; Szymanski, Ralf: Supernode Processing of Mixed Integer Models. Boston, Kluwer Academic Publishers, 1994.



## See Also

### MuPAD Functions

`linopt::Transparent` | `linopt::Transparent::result`

## linopt::Transparent::phaseI\_tableau

Start an ordinary phase one of a 2-phase simplex algorithm

### Syntax

```
linopt::Transparent::phaseI_tableau(tableau)
```

### Description

`linopt::Transparent::phaseI_tableau` explicitly starts an (ordinary) phase one of the simplex algorithm, i.e. rows associated with infeasible basic variables are multiplied with -1 and another identity matrix with new slack variables is added to the given tableau. As soon as an optimal tableau with relative costs 0 is found the calculation can be continued with `linopt::Transparent::clean_basis` and the second phase of the simplex algorithm (`linopt::Transparent::phaseII_tableau`).

### Examples

#### Example 1

The first simplex tableau is created and the first phase of the simplex algorithm is started:

```
t := linopt::Transparent([{x + y >= 2}, x, NonNegative]);
t := linopt::Transparent::phaseI_tableau(t)
```

$$\begin{pmatrix} \text{"linopt"} & \text{"restr"} & \text{slk}_1 & y & x \\ \text{"obj"} & 0 & 0 & 0 & 1 \\ \text{slk}_1 & -2 & 1 & -1 & -1 \end{pmatrix}$$

$$\begin{pmatrix} \text{"linopt"} & \text{"restr"} & \text{slk}_2 & \text{slk}_1 & y & x \\ \text{"obj"} & -2 & 0 & 1 & -1 & -1 \\ \text{slk}_2 & 2 & 1 & -1 & 1 & 1 \end{pmatrix}$$

We can see that a new slack variable,  $slk_2$ , was added to the tableau. And if we now execute `linopt::Transparent::simplex` we can see that we have just finished the first phase of the simplex algorithm:

```
linopt::Transparent::suggest(t);
t := linopt::Transparent::simplex(t);
linopt::Transparent::suggest(t)
```

$slk_2, y$

"linopt::Transparent::phaseII\_tableau"

We continue the simplex algorithm by executing `linopt::Transparent::clean_basis`, `linopt::Transparent::phaseII_tableau` and `linopt::Transparent::simplex`. Observe in this special case `linopt::Transparent::clean_basis` is not necessary:

```
t := linopt::Transparent::clean_basis(t);
t := linopt::Transparent::phaseII_tableau(t);
t := linopt::Transparent::simplex(t);
linopt::Transparent::suggest(t)
```

$$\begin{pmatrix} \text{"linopt"} & \text{"restr"} & slk_1 & y & x \\ \text{"obj"} & 0 & 0 & 0 & 1 \\ y & 2 & -1 & 1 & 1 \end{pmatrix}$$

OPTIMAL

```
delete t;
```

## Parameters

### tableau

A simplex tableau of domain type `linopt::Transparent`

## Return Values

Simplex tableau of domain type `linopt::Transparent`.

## References

Papadimitriou, Christos H; Steiglitz, Kenneth: Combinatorial Optimization; Algorithms and Complexity. Prentice-Hall, 1982.

Nemhauser, George L; Wolsey, Laurence A: Integer and Combinatorial Optimization. New York, Wiley, 1988.

Salkin, Harvey M; Mathur, Kamlesh: Foundations of Integer Programming. North-Holland, 1989.

Neumann, Klaus; Morlock, Martin: Operations-Research. Munich, Hanser, 1993.

Duerr, Walter; Kleibohm, Klaus: Operations Research; Lineare Modelle und ihre Anwendungen. Munich, Hanser, 1992.

Suhl, Uwe H: MOPS - Mathematical OPTimization System. European Journal of Operational Research 72(1994)312-322. North-Holland, 1994.

Suhl, Uwe H; Szymanski, Ralf: Supernode Processing of Mixed Integer Models. Boston, Kluwer Academic Publishers, 1994.

## See Also

### **MuPAD Functions**

`linopt::Transparent` | `linopt::Transparent::autostep` |  
`linopt::Transparent::clean_basis` | `linopt::Transparent::convert` |  
`linopt::Transparent::dual_prices` |  
`linopt::Transparent::phaseII_tableau` | `linopt::Transparent::result` |  
`linopt::Transparent::simplex` | `linopt::Transparent::suggest` |  
`linopt::Transparent::userstep`

# linopt::Transparent::phaseII\_tableau

Start phase two of a 2-phase simplex algorithm

## Syntax

```
linopt::Transparent::phaseII_tableau(tableau)
```

## Description

`linopt::Transparent::phaseII_tableau(tableau)` starts the second phase of the simplex algorithm on the given simplex tableau `tableau`.

After the explicitly started first phase of the simplex algorithm (see `linopt::Transparent::phaseI_tableau`) terminated with an optimal tableau with associated costs 0 and no phase one slack variables in the basis (see `linopt::Transparent::clean_basis`) this procedure can be used to start phase II. The procedure eliminates all artificial variables of phase I and their associated columns and reenters the old objective function modified for the new basis.

## Examples

### Example 1

The first simplex tableau is created and the first phase of the simplex algorithm is finished:

```
t := linopt::Transparent([{x + y >= 2}, x, NonNegative]):
t := linopt::Transparent::simplex(
  linopt::Transparent::phaseI_tableau(t))
```

$$\begin{pmatrix} \text{"linopt"} & \text{"restr"} & \text{slk}_2 & \text{slk}_1 & y & x \\ \text{"obj"} & 0 & 1 & 0 & 0 & 0 \\ y & 2 & 1 & -1 & 1 & 1 \end{pmatrix}$$

One sees that the artificial slack variable `slk[2]` of the first phase is removed by `linopt::Transparent::phaseII_tableau`. In this example it is not necessary to use `linopt::Transparent::clean_basis` for cleaning the basis:

```
linopt::Transparent::phaseII_tableau(t)
```

$$\begin{pmatrix} \text{"linopt"} & \text{"restr"} & \text{slk}_1 & y & x \\ \text{"obj"} & 0 & 0 & 0 & 1 \\ y & 2 & -1 & 1 & 1 \end{pmatrix}$$

```
delete t:
```

## Example 2

Again the first simplex tableau is created and the first phase of the simplex algorithm is finished:

```
t := linopt::Transparent([{x <= 1, y <= 1, x + y >= 2},
                          0, NonNegative]):
t := linopt::Transparent::phaseI_tableau(t):
t := linopt::Transparent::simplex(t)
```

$$\begin{pmatrix} \text{"linopt"} & \text{"restr"} & \text{slk}_4 & \text{slk}_5 & \text{slk}_6 & \text{slk}_1 & \text{slk}_2 & \text{slk}_3 & y & x \\ \text{"obj"} & 0 & 2 & 2 & 0 & 1 & 1 & 1 & 0 & 0 \\ x & 1 & 1 & 0 & 0 & 1 & 0 & 0 & 0 & 1 \\ y & 1 & 0 & 1 & 0 & 0 & 1 & 0 & 1 & 0 \\ \text{slk}_6 & 0 & -1 & -1 & 1 & -1 & -1 & -1 & 0 & 0 \end{pmatrix}$$

In this example the artificial slack variable `slk[6]` is an element of the optimal basis. So we have to use `linopt::Transparent::clean_basis` before continuing with `linopt::Transparent::phaseII_tableau`, otherwise we will get an error message:

```
linopt::Transparent::phaseII_tableau(t)
```

```
Error: Clean the basis from phase I slack variables first. [linopt::Transparent::phaseII_tableau(t)]
```

```
t := linopt::Transparent::clean_basis(t):
linopt::Transparent::phaseII_tableau(t)
```

$$\begin{pmatrix} \text{"linopt"} & \text{"restr"} & \text{slk}_1 & \text{slk}_2 & \text{slk}_3 & y & x \\ \text{"obj"} & 0 & 0 & 0 & 0 & 0 & 0 \\ x & 1 & 0 & -1 & -1 & 0 & 1 \\ y & 1 & 0 & 1 & 0 & 1 & 0 \\ \text{slk}_1 & 0 & 1 & 1 & 1 & 0 & 0 \end{pmatrix}$$

delete t:

## Parameters

### tableau

A simplex tableau of domain type `linopt::Transparent`

## Return Values

Simplex tableau of domain type `linopt::Transparent`.

## References

Papadimitriou, Christos H; Steiglitz, Kenneth: Combinatorial Optimization; Algorithms and Complexity. Prentice-Hall, 1982.

Nemhauser, George L; Wolsey, Laurence A: Integer and Combinatorial Optimization. New York, Wiley, 1988.

Salkin, Harvey M; Mathur, Kamlesh: Foundations of Integer Programming. North-Holland, 1989.

Neumann, Klaus; Morlock, Martin: Operations-Research. Munich, Hanser, 1993.

Duerr, Walter; Kleibohm, Klaus: Operations Research; Lineare Modelle und ihre Anwendungen. Munich, Hanser, 1992.

Suhl, Uwe H: MOPS - Mathematical OPTimization System. European Journal of Operational Research 72(1994)312-322. North-Holland, 1994.

Suhl, Uwe H; Szymanski, Ralf: Supernode Processing of Mixed Integer Models. Boston, Kluwer Academic Publishers, 1994.

## See Also

### MuPAD Functions

`linopt::Transparent` | `linopt::Transparent::autostep` |  
`linopt::Transparent::clean_basis` | `linopt::Transparent::convert` |  
`linopt::Transparent::dual_prices` | `linopt::Transparent::phaseI_tableau`  
| `linopt::Transparent::result` | `linopt::Transparent::simplex` |  
`linopt::Transparent::suggest` | `linopt::Transparent::userstep`



# linopt::Transparent::result

Get the basic feasible solution belonging to the given simplex tableau

## Syntax

```
linopt::Transparent::result(tableau)
```

## Description

`linopt::Transparent::result(tableau)` returns the basic feasible solution belonging to the given simplex tableau `tableau`.

Only the user defined variables are taken into account - the dual prices can be achieved by use of `linopt::Transparent::dual_prices`.

## Examples

### Example 1

We first compute an edge for an initial simplex tableau:

```
k := [{x <= 1, y <= 1, x + y >= 2}, 0, NonNegative]:
t := linopt::Transparent(k):
linopt::Transparent::result(t)
```

$$\{x=0, y=0\}$$

Now we compute the edge for the final tableau, which is identical to the optimal solution of the linear program given by `k`. We get the final simplex tableau by using `linopt::Transparent::simplex`:

```
t := linopt::Transparent(k):
t := linopt::Transparent::simplex(t):
linopt::Transparent::result(t)
```

$\{x = 1, y = 1\}$

`linopt::minimize(k)`

$[\text{OPTIMAL}, \{x = 1, y = 1\}, 0]$

`delete k, t:`

## Parameters

### **tableau**

A simplex tableau of domain type `linopt::Transparent`

## Return Values

Set containing the values of the user defined variables for the feasible solution.

## References

Papadimitriou, Christos H; Steiglitz, Kenneth: Combinatorial Optimization; Algorithms and Complexity. Prentice-Hall, 1982.

Nemhauser, George L; Wolsey, Laurence A: Integer and Combinatorial Optimization. New York, Wiley, 1988.

Salkin, Harvey M; Mathur, Kamlesh: Foundations of Integer Programming. North-Holland, 1989.

Neumann, Klaus; Morlock, Martin: Operations-Research. Munich, Hanser, 1993.

Duerr, Walter; Kleibohm, Klaus: Operations Research; Lineare Modelle und ihre Anwendungen. Munich, Hanser, 1992.

Suhl, Uwe H: MOPS - Mathematical OPTimization System. European Journal of Operational Research 72(1994)312-322. North-Holland, 1994.

Suhl, Uwe H; Szymanski, Ralf: Supernode Processing of Mixed Integer Models. Boston, Kluwer Academic Publishers, 1994.

## See Also

### **MuPAD Functions**

`linopt::Transparent` | `linopt::Transparent::dual_prices`

## linopt::Transparent::simplex

Finish the current phase of the 2-phase simplex algorithm

### Syntax

```
linopt::Transparent::simplex(tableau)
```

### Description

`linopt::Transparent::simplex` runs the current phase of the 2-phase simplex algorithm until the end, i.e. if phase I was explicitly started (see `linopt::Transparent::phaseI_tableau`) the first phase will lead the optimal tableau. Sometimes it can be necessary to eliminate some slack variables of phase one by using `linopt::Transparent::clean_basis`.

If there was no phase I started by the user, `(linopt::Transparent)::simplex` returns the last optimal tableau or the empty set if there was no feasible solution found.

### Examples

#### Example 1

We apply `linopt::Transparent::simplex` to an ordinary simplex tableau of a linear program and we get the optimal tableau:

```
k := [{x + y >= 2}, x, NonNegative];  
t := linopt::Transparent(k);  
t := linopt::Transparent::simplex(t)
```

$$\begin{pmatrix} \text{"linopt"} & \text{"restr"} & \text{slk}_1 & y & x \\ \text{"obj"} & 0 & 0 & 0 & 1 \\ \text{slk}_1 & -2 & 1 & -1 & -1 \end{pmatrix}$$

$$\begin{pmatrix} \text{"linopt"} & \text{"restr"} & \text{slk}_1 & y & x \\ \text{"obj"} & 0 & 0 & 0 & 1 \\ y & 2 & -1 & 1 & 1 \end{pmatrix}$$

Let us proof the obtained result:

```
linopt::Transparent::suggest(t)
```

OPTIMAL

```
delete k, t:
```

## Example 2

If the first phase of the simplex algorithm was started explicitly, `linopt::Transparent::simplex` returns only the optimal tableau of the first phase:

```
k := [{x + y >= 2}, y, NonNegative]:
t := linopt::Transparent(k):
t := linopt::Transparent::phaseI_tableau(t):
t := linopt::Transparent::simplex(t)
```

$$\begin{pmatrix} \text{"linopt"} & \text{"restr"} & \text{slk}_2 & \text{slk}_1 & y & x \\ \text{"obj"} & -2 & 0 & 1 & -1 & -1 \\ \text{slk}_2 & 2 & 1 & -1 & 1 & 1 \end{pmatrix}$$

$$\begin{pmatrix} \text{"linopt"} & \text{"restr"} & \text{slk}_2 & \text{slk}_1 & y & x \\ \text{"obj"} & 0 & 1 & 0 & 0 & 0 \\ y & 2 & 1 & -1 & 1 & 1 \end{pmatrix}$$

The next step of the simplex algorithm is computed:

```
linopt::Transparent::suggest(t)
```

`"linopt::Transparent::phaseII_tableau"`

With `linopt::Transparent::autostep` we execute the first step of the second phase of the simplex algorithm. One can see that the simplex algorithm is not finished yet:

```
t := linopt::Transparent::autostep(t);  
linopt::Transparent::suggest(t);
```

`y, x`

If we then apply `linopt::Transparent::simplex` again we get the optimal solution. Here we don't had to use `linopt::Transparent::clean_basis`, before using `linopt::Transparent::autostep`, because there are no artificial variables in the basis computed by the first `linopt::Transparent::simplex` call above:

```
t := linopt::Transparent::simplex(t);  
linopt::Transparent::suggest(t)
```

`( "linopt" "restr" slk1 y x )`  
`( "obj" 0 0 1 0 )`  
`( x 2 -1 1 1 )`

OPTIMAL

```
delete k, t;
```

## Parameters

### tableau

A simplex tableau of domain type `linopt::Transparent`

## Return Values

Simplex tableau of domain type `linopt::Transparent` or the empty set if there was no feasible solution found.

## References

Papadimitriou, Christos H; Steiglitz, Kenneth: Combinatorial Optimization; Algorithms and Complexity. Prentice-Hall, 1982.

Nemhauser, George L; Wolsey, Laurence A: Integer and Combinatorial Optimization. New York, Wiley, 1988.

Salkin, Harvey M; Mathur, Kamlesh: Foundations of Integer Programming. North-Holland, 1989.

Neumann, Klaus; Morlock, Martin: Operations-Research. Munich, Hanser, 1993.

Duerr, Walter; Kleibohm, Klaus: Operations Research; Lineare Modelle und ihre Anwendungen. Munich, Hanser, 1992.

Suhl, Uwe H: MOPS - Mathematical OPTimization System. European Journal of Operational Research 72(1994)312-322. North-Holland, 1994.

Suhl, Uwe H; Szymanski, Ralf: Supernode Processing of Mixed Integer Models. Boston, Kluwer Academic Publishers, 1994.

## See Also

### MuPAD Functions

linopt::Transparent | linopt::Transparent::autostep |  
linopt::Transparent::convert | linopt::Transparent::dual\_prices |  
linopt::Transparent::phaseI\_tableau | linopt::Transparent::result |  
linopt::Transparent::suggest | linopt::Transparent::userstep

## linopt::Transparent::suggest

Suggest the next step in the simplex algorithm

### Syntax

```
linopt::Transparent::suggest(tableau)
```

### Description

`linopt::Transparent::suggest(tableau)` suggests the next step in the simplex algorithm for the given simplex tableau `tableau`.

Normally this suggestion will be a pivot element, i.e. a sequence of a basic and a non-basic variable. If a phase I of the 2-phase simplex algorithm was started explicitly (see `linopt::Transparent::phaseI_tableau`) and the current tableau belongs to a feasible solution the suggestion will be the string "`linopt::Transparent::phaseII_tableau`". At the end of the calculation the 'suggestion' is the identifier `OPTIMAL`.

The result of `linopt::Transparent::suggest` can be influenced if the global identifier `OPTIMAL` has a value. For this reason the identifier `OPTIMAL` is protected on page 1-1679.

### Examples

#### Example 1

We have a look at a linear program where the ordinary simplex tableau of the given problem is not the last tableau during the computation of the simplex algorithm. Looking at the ordinary simplex tableau we see that the element of the `slk[2]`-labeled row and the `x`-labeled column is a pivot element:

```
k := [{3*x + 4*y - 3*z <= 23, 5*x - 4*y - 3*z <= 10,  
      7*x + 4*y + 11*z <= 30}, -x + y + 2*z, NonNegative]:
```



```
t := linopt::Transparent(k);
linopt::Transparent::suggest(t)
```

$$\begin{pmatrix} \text{"linopt"} & \text{"restr"} & \text{slk}_1 & \text{slk}_2 & \text{slk}_3 & y & x & z \\ \text{"obj"} & 0 & 0 & 0 & 0 & 1 & -1 & 2 \\ \text{slk}_1 & 23 & 1 & 0 & 0 & 4 & 3 & -3 \\ \text{slk}_2 & 10 & 0 & 1 & 0 & -4 & 5 & -3 \\ \text{slk}_3 & 30 & 0 & 0 & 1 & 4 & 7 & 11 \end{pmatrix}$$

slk<sub>2</sub>, x

```
delete k, t:
```

## Example 2

Here the ordinary simplex tableau still contains the solution of the linear program if the linear objective function is to minimize (see `linopt::Transparent` for more information):

```
k := [{x+y>=-1, x+y<=3}, x+2*y, NonNegative]:
t := linopt::Transparent(k);
linopt::Transparent::suggest(t)
```

$$\begin{pmatrix} \text{"linopt"} & \text{"restr"} & \text{slk}_1 & \text{slk}_2 & y & x \\ \text{"obj"} & 0 & 0 & 0 & 2 & 1 \\ \text{slk}_1 & 1 & 1 & 0 & -1 & -1 \\ \text{slk}_2 & 3 & 0 & 1 & 1 & 1 \end{pmatrix}$$

OPTIMAL

```
delete k, t:
```

## Example 3

Here we explicitly start the first phase of the simplex algorithm. If we want a solution of the original linear program we have to apply the second phase of the simplex algorithm:

```
k := [{3*x + 4*y - 3*z <= 23, 5*x - 4*y - 3*z <= 10,  
      7*x + 4*y + 11*z <= 30}, -x + y + 2*z, NonNegative]:  
t := linopt::Transparent(k):  
t := linopt::Transparent::phaseI_tableau(t):  
t := linopt::Transparent::simplex(t):  
linopt::Transparent::suggest(t)
```

```
"linopt::Transparent::phaseII_tableau"
```

```
delete k, t:
```

## Parameters

### tableau

A simplex tableau of domain type `linopt::Transparent`

## Return Values

Sequence of 2 identifiers, the identifier `OPTIMAL` or the string `"linopt::Transparent::phaseII_tableau"`.

## References

Papadimitriou, Christos H; Steiglitz, Kenneth: Combinatorial Optimization; Algorithms and Complexity. Prentice-Hall, 1982.

Nemhauser, George L; Wolsey, Laurence A: Integer and Combinatorial Optimization. New York, Wiley, 1988.

Salkin, Harvey M; Mathur, Kamlesh: Foundations of Integer Programming. North-Holland, 1989.

Neumann, Klaus; Morlock, Martin: Operations-Research. Munich, Hanser, 1993.

Duerr, Walter; Kleibohm, Klaus: Operations Research; Lineare Modelle und ihre Anwendungen. Munich, Hanser, 1992.

Suhl, Uwe H: MOPS - Mathematical OPTimization System. European Journal of Operational Research 72(1994)312-322. North-Holland, 1994.

Suhl, Uwe H; Szymanski, Ralf: Supernode Processing of Mixed Integer Models. Boston, Kluwer Academic Publishers, 1994.

## See Also

### **MuPAD Functions**

linopt::Transparent | linopt::Transparent::autostep |  
linopt::Transparent::convert | linopt::Transparent::dual\_prices |  
linopt::Transparent::phaseI\_tableau | linopt::Transparent::result |  
linopt::Transparent::simplex | linopt::Transparent::userstep

## linopt::Transparent::userstep

Perform a user defined simplex step

### Syntax

```
linopt::Transparent::userstep(tableau, basvar, nonbasvar)
```

### Description

`linopt::Transparent::userstep(tableau, basvar, nonbasvar)` performs a user defined simplex step in the `tableau` with the pivot element defined by `basvar` and `nonbasvar`.

### Examples

#### Example 1

We execute the simplex step given by the pivot element (`slk[1], x`):

```
k := [{x + y >= 2}, x, NonNegative]:  
t:= linopt::Transparent(k);  
linopt::Transparent::userstep(t, slk[1], x)
```

$$\begin{pmatrix} \text{"linopt"} & \text{"restr"} & \text{slk}_1 & y & x \\ \text{"obj"} & 0 & 0 & 0 & 1 \\ \text{slk}_1 & -2 & 1 & -1 & -1 \end{pmatrix}$$

$$\begin{pmatrix} \text{"linopt"} & \text{"restr"} & \text{slk}_1 & y & x \\ \text{"obj"} & -2 & 1 & -1 & 0 \\ x & 2 & -1 & 1 & 1 \end{pmatrix}$$

## Example 2

If we specify a wrong pivot element, we will get an error message:

```
k := [{3*x + 4*y - 3*z <= 23, 5*x - 4*y - 3*z <= 10,
      7*x + 4*y + 11*z <= 30}, -x + y + 2*z, NonNegative]:
t:= linopt::Transparent(k);
linopt::Transparent::userstep(t, x, y)
```

$$\begin{pmatrix} \text{"linopt"} & \text{"restr"} & \text{slk}_1 & \text{slk}_2 & \text{slk}_3 & y & x & z \\ \text{"obj"} & 0 & 0 & 0 & 0 & 1 & -1 & 2 \\ \text{slk}_1 & 23 & 1 & 0 & 0 & 4 & 3 & -3 \\ \text{slk}_2 & 10 & 0 & 1 & 0 & -4 & 5 & -3 \\ \text{slk}_3 & 30 & 0 & 0 & 1 & 4 & 7 & 11 \end{pmatrix}$$

Error: Pivot element not specified or specified incorrectly. [linopt::Transparent::userstep]

delete k, t:

## Parameters

### tableau

A simplex tableau of domain type `linopt::Transparent`

### basvar

A basic variable represented by an identifier that has to leave the basis

### nonbasvar

A non-basic variable represented by an identifier that has to enter the basis

## Return Values

Simplex tableau of domain type `linopt::Transparent`.

## References

Papadimitriou, Christos H; Steiglitz, Kenneth: Combinatorial Optimization; Algorithms and Complexity. Prentice-Hall, 1982.

Nemhauser, George L; Wolsey, Laurence A: Integer and Combinatorial Optimization. New York, Wiley, 1988.

Salkin, Harvey M; Mathur, Kamlesh: Foundations of Integer Programming. North-Holland, 1989.

Neumann, Klaus; Morlock, Martin: Operations-Research. Munich, Hanser, 1993.

Duerr, Walter; Kleibohm, Klaus: Operations Research; Lineare Modelle und ihre Anwendungen. Munich, Hanser, 1992.

Suhl, Uwe H: MOPS - Mathematical OPTimization System. European Journal of Operational Research 72(1994)312-322. North-Holland, 1994.

Suhl, Uwe H; Szymanski, Ralf: Supernode Processing of Mixed Integer Models. Boston, Kluwer Academic Publishers, 1994.

## See Also

### **MuPAD Functions**

`linopt::Transparent` | `linopt::Transparent::autostep` |  
`linopt::Transparent::convert` | `linopt::Transparent::dual_prices` |  
`linopt::Transparent::phaseI_tableau` | `linopt::Transparent::result` |  
`linopt::Transparent::simplex` | `linopt::Transparent::suggest`

# listlib - Manipulating Lists

---

## listlib::insert

Insert an element into a list

### Syntax

```
listlib::insert(list, element, <function>)
```

### Description

`listlib::insert(list, element)` inserts `element` into `list`.

With the function `listlib::insert` any element can be inserted into any list.

With the third optional argument a function can be given that compare the elements of the list with the element to insert and therewith determines the position, the element is inserted. The given function is called with two elements and have to return `TRUE`, if the two elements are in the right order, otherwise `FALSE` (see next paragraph).

The given function is called step by step with an element of the list as first argument and the given element as second argument, until it returns `FALSE`. Then the given element is inserted into the list in *front* of the last proved element (see “Example 2” on page 17-3 (Symbolic Math Toolbox)).

---

**Note** The list must be ordered with regard to the order function, otherwise the element could be inserted at the wrong place.

---

If no third argument is given the function `_less` is used. If no order of the elements with regard to `_less` is defined, a function must be given, otherwise an error appears. The system function `sysorder` always can be used.



## Examples

### Example 1

Insert 3 into the given ordered list:

```
listlib::insert([1, 2, 4, 5, 6], 3)
```

```
[1, 2, 3, 4, 5, 6]
```

Insert 3 into the given descending ordered list. The insert function represents and preserves the order of the list:

```
listlib::insert([6, 5, 4, 2, 1], 3, _not@_less)
```

```
[6, 5, 4, 3, 2, 1]
```

Because identifiers cannot be ordered by `_less`, another function must be given, e.g., the function that represents the systems internal order:

```
listlib::insert([a, b, d, e, f], c, sysorder)
```

```
[a, b, c, d, e, f]
```

### Example 2

Because no function is given as third argument, the function `_less` is used. `_less` is called: `_less(1, 3)`, `_less(2, 3)`, `_less(4, 3)` and then 3 is inserted in front of 4:

```
listlib::insert([1, 2, 4], 3)
```

```
[1, 2, 3, 4]
```

If the list is not ordered right, then the insert position could be wrong:

```
listlib::insert([4, 1, 2], 3)
```

```
[3, 4, 1, 2]
```

### Example 3

The following example shows, how expressions can be ordered by a user defined priority. This order is given by the function named `priority`, which returns a smaller number, when the expression has a type with higher priority:

```
priority := X -> contains(["_power", "_mult", "_plus"], type(X)):
priority(x^2), priority(x + 2)
```

```
1, 3
```

The function `sortfunc` returns `TRUE`, if the both given arguments are in the right order, i.e., the first argument has a higher (or equal) priority than the second argument:

```
sortfunc := (X, Y) -> bool(priority(Y) > priority(X)):
sortfunc(x^2, x + 2), sortfunc(x + 2, x*2)
```

```
TRUE, FALSE
```

Now the expression `x*2` is inserted at the “right” place in the list:

```
listlib::insert([x^y, x^2, x*y, -y, x + y], x*2, sortfunc)
```

```
[x^y, x^2, 2 x, x y, -y, x + y]
```

## Parameters

### **list**

MuPAD list

### **element**

MuPAD expression to insert

**function**

Function that determines the insert position

**Return Values**

Given list enlarged with the inserted element

**See Also****MuPAD Functions**

`_concat` | `append` | `listlib::insertAt`

## listlib::insertAt

Insert an element into a list at a given position

### Syntax

```
listlib::insertAt(list, element, <pos>)
```

### Description

`listlib::insertAt(list, element, pos)` inserts `element` into `list` at position `pos`.

With the function `listlib::insertAt` any element can be inserted into any list at a specified place.

The third argument (the “insert index”) determines the place to insert the element into the given list.

If the insert index is less than 1 the element is inserted in front of the list. If the insertion index is greater than `nops(list)` the element is appended to the list. To append an element to a list the kernel function `append` is faster.

If no third argument is given, the given element is inserted in front of the list.

If the argument `element` is a list too, the elements of this list will be inserted (or appended) instead of the whole list by preserving the order.

### Examples

#### Example 1

Insertion 2 at the third place of the given list:

```
listlib::insertAt([1, 1, 1], 2, 3)
```

```
[1, 1, 2, 1]
```

Insertion of an element in front of a list. The third argument is optional in this case:

```
listlib::insertAt([1, 1, 3, 1], 2, 0), listlib::insertAt([1, 1, 3, 1], 2)
```

```
[2, 1, 1, 3, 1], [2, 1, 1, 3, 1]
```

Appending of an element. This could be done faster with `append`:

```
listlib::insertAt([1, 2, 3], 4, 1000), append([1, 2, 3], 4)
```

```
[1, 2, 3, 4], [1, 2, 3, 4]
```

## Parameters

### **list**

A list

### **element**

Any MuPAD object

### **pos**

Any integer

## Return Values

Given list enlarged with the inserted element

## See Also

### MuPAD Functions

`_concat` | `append` | `listlib::insert`

# listlib::merge

Merging two ordered lists

## Syntax

```
listlib::merge(list1, list2, <function>)
```

## Description

`listlib::merge(list1, list2)` merges both lists into one list.

With the third optional argument a function can be given that compare the elements of the lists and therewith determines the order of the elements. The given function is called with two elements and have to return `TRUE`, if the two elements are in the right order, otherwise `FALSE` (see next paragraph).

The given function is called step by step with an element of the first list as first argument and an element of the second list as second argument, until it returns `FALSE`. Then the element of the second list is inserted into the first list in *front* of the last proved element (see “Example 2” on page 17-10 (Symbolic Math Toolbox)).

---

**Note** The lists must be ordered with regard to the order function, otherwise the elements could be inserted at the wrong place.

---

If no third argument is given the function `_less` is used. If no order of the elements with regard to `_less` is defined, a function must be given, otherwise an error appears. The system function `sysorder` always can be used.

## Examples

### Example 1

Merging two ascending ordered lists:

```
listlib::merge([1, 3, 5, 7], [2, 4, 6, 8])
```

```
[1, 2, 3, 4, 5, 6, 7, 8]
```

Merging two descending ordered lists:

```
listlib::merge([7, 5, 3, 1], [8, 6, 4, 2], _not@_less)
```

```
[8, 7, 6, 5, 4, 3, 2, 1]
```

## Example 2

The following example shows, how expressions can be ordered by a user defined priority. This order is given by the function named `priority`, which returns a smaller number, when the expression has a type with higher priority:

```
priority := X -> contains(["_power", "_mult", "_plus"], type(X)):  
priority(x^2), priority(x + 2)
```

```
1, 3
```

The function `sortfunc` returns TRUE, if the both given arguments are in the right order, i.e., the first argument has a higher (or equal) priority than the second argument:

```
sortfunc := (X, Y) -> bool(priority(Y) > priority(X)):  
sortfunc(x^2, x + 2), sortfunc(x + 2, x*2)
```

```
TRUE, FALSE
```

Now the both lists are merged with regard to the given priority:

```
listlib::merge([x^y, x*2, -y], [x^2, x*y, x + y], sortfunc)
```

```
[x^y, x^2, 2 x, -y, x y, x + y]
```

```
delete priority, sortfunc:
```



## Parameters

**list1, list2**

A MuPAD list

**function**

A function that determines the merging order

## Return Values

Ordered list that contains the elements of both lists

## See Also

**MuPAD Functions**

`_concat` | `listlib::insert` | `listlib::singleMerge` | `zip`

## listlib::removeDuplicates

Removes duplicate entries

### Syntax

```
listlib::removeDuplicates(list, <KeepOrder>)
```

### Description

`listlib::removeDuplicates(list)` removes all duplicates of each entry of the list `list`. The new list is build up from right to left with the order of the *last* occurrence of each entry in `list`. Cf. “Example 1” on page 17-0 (Symbolic Math Toolbox).

A faster possibibliy to remove duplicate entries is to convert the list into a `set` and back into a list. You will loose the order of the list entries in this case. Cf. “Example 3” on page 17-13 (Symbolic Math Toolbox).

### Examples

#### Example 1

Per default `listlib::removeDuplicates` removes duplicate entries in reverse order:

```
list:= [1, 1, 1, 3, 1, 5, 5, 1, 3, 3, 1, 7]:  
listlib::removeDuplicates(list)
```

```
[5, 3, 1, 7]
```

#### Example 2

With option `KeepOrder` entries are selected in the order of their occurrence:

```
list:= [1, 1, 1, 3, 1, 5, 5, 1, 3, 3, 1, 7]:  
listlib::removeDuplicates(list, KeepOrder)
```

```
[1, 3, 5, 7]
```

### Example 3

If you don't need the order of list entries any more, you may convert the list into a set and back into a list, this is much faster:

```
list:= [1, 1, 1, 3, 1, 5, 5, 1, 3, 3, 1, 7]:  
[op({op(list)})]
```

```
[1, 3, 5, 7]
```

## Parameters

### list

A MuPAD list

## Options

### KeepOrder

`listlib::removeDuplicates(list, KeepOrder)` returns a list of the entries of `list` in the order of their *first* occurrence. The list is build up from left to right. See "Example 2" on page 17-12 (Symbolic Math Toolbox).

## Return Values

List that contains each entry only once

## See Also

### **MuPAD Domains**

DOM\_LIST

### **MuPAD Functions**

listlib::removeDupSorted

# listlib::removeDupSorted

Remove duplicates of any element from ordered lists

## Syntax

```
listlib::removeDupSorted(list)
```

## Description

`listlib::removeDupSorted(list)` removes all duplicates of any element of the ordered list `list`.

`listlib::removeDupSorted` does the same as `listlib::removeDuplicates`, but it assumes that the list is sorted and, therefore, it is faster. A notable gain will only occur, if there are only few duplicates in a long list.

## Examples

### Example 1

`listlib::removeDupSorted` removes all duplicates from the given list:

```
listlib::removeDupSorted([1, 1, 1, 3, 5, 5, 5, 5, 5, 5, 5, 7, 7, 7])
```

```
[1, 3, 5, 7]
```

If the list is not ordered, `listlib::removeDupSorted` fails:

```
listlib::removeDupSorted([1, 3, 5, 7, 1, 3, 5, 7, 1, 3, 5, 7])
```

```
[1, 3, 5, 7, 1, 3, 5, 7, 1, 3, 5, 7]
```

## **Parameters**

**list**

An ordered MuPAD list

## **Return Values**

List that contains every element only once

## **See Also**

**MuPAD Functions**

`listlib::removeDuplicates`

# listlib::setDifference

Remove elements from a list

## Syntax

```
listlib::setDifference(list1, list2)
```

## Description

`listlib::setDifference(list1, list2)` removes all elements from `list1`, that are given by `list2`.

---

**Note** The order of the list is not preserved.

---

## Examples

### Example 1

`listlib::setDifference` removes 2, 4, 6 and 8 from the given list:

```
listlib::setDifference([1, 2, 3, 4, 5, 6, 7, 8], [2, 4, 6, 8])
```

```
[1, 3, 5, 7]
```

## Parameters

`list1, list2`

A MuPAD list

## **Return Values**

First list without all elements of the second list

## **See Also**

### **MuPAD Functions**

minus



# listlib::singleMerge

Merging of two ordered lists without duplicates

## Syntax

```
listlib::singleMerge(list1, list2, <function>)
```

## Description

`listlib::singleMerge(list1, list2)` merges the both lists into one list. It is assumed that the lists are “disjunct”, no element appears in both lists. Otherwise such elements are inserted only once in the result list.

With the third optional argument a function can be given that compare the elements of the lists and therewith determines the order of the elements. The given function is called with two elements and have to return `TRUE`, if the two elements are in the right order, otherwise `FALSE` (see next paragraph).

The given function is called step by step with an element of the first list as first argument and an element of the second list as second argument, until it returns `FALSE`. Then the element of the second list is inserted into the first list in *front* of the last proved element (see “Example 3” on page 17-20 (Symbolic Math Toolbox)).

---

**Note** The lists must be ordered with regard to the order function, otherwise the elements could be inserted at the wrong place.

---

If no third argument is given the function `_less` is used. If no order of the elements with regard to `_less` is defined, a function must be given, otherwise an error appears. The system function `sysorder` always can be used.

## Examples

### Example 1

Merging two ascending ordered lists:

```
listlib::singleMerge([1, 3, 5, 7], [2, 4, 6, 8])
```

```
[1, 2, 3, 4, 5, 6, 7, 8]
```

Merging two descending ordered lists:

```
listlib::singleMerge([7, 5, 3, 1], [8, 6, 4, 2], _not@_less)
```

```
[8, 7, 6, 5, 4, 3, 2, 1]
```

### Example 2

Merging two ascending ordered lists with duplicates:

```
listlib::singleMerge([1, 2, 5, 7], [2, 5, 6, 8])
```

```
[1, 2, 5, 6, 7, 8]
```

But the following lists does not contain mutual equal elements:

```
listlib::singleMerge([1, 1, 3, 3], [2, 2, 4, 4])
```

```
[1, 1, 2, 2, 3, 3, 4, 4]
```

### Example 3

The following example shows, how expressions can be ordered by a user defined priority. This order is given by the function named `priority`, which returns a smaller number when the expression has a type with higher priority:

```
priority := X -> contains(["_power", "_mult", "_plus"], type(X)):
priority(x^2), priority(x + 2)
```

1, 3

The function `sortfunc` returns TRUE, if the both given arguments are in the right order, i.e., the first argument has a higher (or equal) priority than the second argument:

```
sortfunc := (X, Y) -> bool(priority(Y) > priority(X)):
sortfunc(x^2, x + 2), sortfunc(x + 2, x^2)
```

TRUE, FALSE

Now the both lists are merged with regard to the given priority:

```
listlib::singleMerge([x^y, x*2, -y], [x^2, x*y, x + y], sortfunc)
```

$[x^y, x^2, 2x, -y, xy, x+y]$

```
delete priority, sortfunc:
```

## Parameters

**list1, list2**

A MuPAD list

**function**

A function that determines the merging order

## Return Values

Ordered list that contains the elements of both lists

## See Also

### MuPAD Functions

`_concat` | `listlib::insert` | `listlib::merge` | `zip`

# listlib::sublist

Search sublists

## Syntax

```
listlib::sublist(list1, list2, <index>, <Consecutive>)
```

## Description

`listlib::sublist(list1, list2)` determines, whether the list `list1` contains another list `list2`.

With `listlib::sublist` the position of the first appearance of a list in another list can be determined.

The position that was found is returned as integer. If the given list does not contain the given `sublist`, the number `0` is returned.

If an `index` is given, the search starts at this position. There with multiple occurrence of a `sublist` can be determined.

With the option `Consecutive`, the list must contain the `sublist` in one piece without elements in between.

## Examples

### Example 1

The `sublist` is a part of the list, but not in one piece:

```
listlib::sublist([1, 2, 3, 4, 5, 6, 7, 8], [2, 3, 5, 6])
```

```
listlib::sublist([1, 2, 3, 4, 5, 6, 7, 8], [2, 3, 5, 6], Consecutive)
```

```
0
```

The list contains the sublist, coherent and incoherent:

```
listlib::sublist([1, 2, 3, 4, 5, 1, 3, 5], [1, 3, 5])
```

```
1
```

```
listlib::sublist([1, 2, 3, 4, 5, 1, 3, 5], [1, 3, 5], Consecutive)
```

```
6
```

## Example 2

Find the last occurrence of the sublist inside of the list:

```
POS:= 0:  
while listlib::sublist([1, 2, 3, 1, 3, 1, 2, 3], [1, 2, 3], POS + 1) > 0 do  
  POS:= listlib::sublist([1, 2, 3, 1, 3, 1, 2, 3], [1, 2, 3], POS + 1)  
end_while:  
POS
```

```
6
```

```
delete POS:
```

## Parameters

**list1, list2**

MuPAD list

**index**

Integer that determines the first search position

## Options

### Consecutive

Determines that the sublist `list2` is containing coherent in `list1`

## Return Values

Position of the first element of the containing sublist or zero

## See Also

### MuPAD Functions

`contains` | `op`





## **misc - Miscellanea**

---

## misc::breakmap

Stops the mapping currently done by maprec

### Syntax

```
misc::breakmap()
```

### Description

misc::breakmap() stops the recursive application of a function to all subexpressions of an expression that misc::maprec is just working on.

misc::breakmap is useful as a command inside the procedure mapped by misc::maprec in case we know that we are finished with our work and the remaining recursive mapping is not necessary.

### Examples

#### Example 1

We want to know whether a given expression contains a particular type `t`. As soon as we have found the first occurrence of `t`, we can terminate our search.

```
myfound := FALSE:
misc::maprec(hold(((23+5.0)/3+4*I)*PI),
             {DOM_COMPLEX}=proc()
               begin
                 myfound := misc::breakmap();
                 args()
               end_proc):
myfound

TRUE
```

What did we do? We told `misc::maprec` just to go down the expression tree and look for subexpressions of type `DOM_COMPLEX`; and, whenever such subexpression should be found, to apply a certain procedure to it. That procedure stops the recursive mapping, remembers that we have found the type we had searched for, and returns exactly its argument such that the result returned by `misc::maprec` equals the input. In the example below, we test whether our given expression contains the type `DOM_POLY`.

```
myfound := FALSE:
misc::maprec(hold(((23+5.0)/3+4*I)*PI),
             {DOM_POLY}=proc()
               begin
                 myfound := misc::breakmap();
                 args()
               end_proc):
myfound
```

FALSE

Note that you do not need to use this method when searching for subexpressions of a given type; calling `hasType` is certainly more convenient.

## Return Values

`misc::breakmap` always returns `TRUE`.

## See Also

### MuPAD Functions

`misc::maprec`

## misc::genassop

Generates an n-ary associative operator from a binary one

### Syntax

```
misc::genassop(binaryop, zeroelement)
```

### Description

`misc::genassop(binaryop, zeroelement)` generates an n-ary associative operator from the binary operator `binaryop`, where `zeroelement` is a neutral element for `binaryop`.

`binaryop` must be a function taking two arguments (no matter of what kind) and returning a valid argument to itself. It must satisfy the associative law  $\text{binaryop}(\text{binaryop}(a, b), c) = \text{binaryop}(a, \text{binaryop}(b, c))$ .

`zeroelement` is an object such that  $\text{binaryop}(a, \text{zeroelement}) = a$  holds for every `a`.

`misc::genassop` returns a procedure which returns `zeroelement` if it is called without arguments and the argument if it is called with one argument.

---

**Note** `misc::genassop` doesn't check whether `binaryop` is really associative and whether `zeroelement` is really a neutral element for `binaryop`.

---

### Examples

#### Example 1

We know that `_plus` is an n-ary operator anyway, but let us assume that `_plus` was only a binary operator. We can create an own n-ary addition as follows:

```
myplus := misc::genassop(_plus, 0)
```

```
proc genericAssop() ... end
```

Now we make `myplus` add some values.

```
myplus(3, 4, 8), myplus(-5), myplus()
```

```
15, -5, 0
```

As mentioned in the “Details” section, `myplus` returns the argument if is called with exactly one argument, and it returns the zeroelement `0` if it is called without arguments.

## Parameters

### **binaryop**

A function

### **zeroelement**

An object

## Return Values

`misc::genassop` returns a procedure `f`. That procedure accepts an arbitrary number of arguments of the same kind `binaryop` does; it returns `zeroelement` if it is called without argument, and its only argument if it is called with one argument; its value on  $n$  arguments is inductively defined by  $f(x_1, \dots, x_n) = f(\text{binaryop}(x_1, x_2), x_3, \dots, x_n)$ .

## See Also

### **MuPAD Functions**

operator

## misc::maprec

Map a function to subexpressions of an expression

### Syntax

```
misc::maprec(ex, selector = funci, ..., <PreMap | PostMap>, <NoOperators>, <Unsimplified>
```

### Description

`misc::maprec(ex, selector=funci)` maps the function `funci` to all subexpressions of the expression `ex` that satisfy a given criterion (defined by `selector`) and replaces each selected subexpression `s` by `funci(s)`.

Several different functions may be mapped to subexpressions satisfying different selection criteria.

`misc::maprec(ex, selector1 = funci1, ..., selectorn = funcin)` does two steps: it tests whether `ex` meets a selection criterion defined by some selector `selectork` (and, if yes, replaces `ex` by `funcik(ex)`); and it applies itself recursively to all operands of `ex`. The order of these steps is determined by the options `PreMap` and `PostMap`.

Selectors are applied from left to right; if the expression meets some selection criterion, no further selectors are tried.

`selector` can have two forms. It can be a set  $\{t_1, \dots, t_n\}$ . Here a subexpression `s` of `ex` is selected if `type(s)` is one of the types  $t_1, \dots, t_n$ . If it is not a set, a subexpression `s` of `ex` is selected if `p(s)` returns `TRUE`. As every MuPAD object may be applied as a function to `s`, `p` may be of any type in the latter case.

In order not to select a subexpression, the selector need not return `FALSE`; it suffices that it does not return `TRUE`.

If neither the option `PreMap` nor the option `PostMap` is given, then `PreMap` is used.

Use a `misc::breakmap` command inside `funci` in order to stop the recursive mapping. See the help page of `misc::breakmap` for an example.

---

**Note** Only subexpressions of domain type `DOM_ARRAY`, `DOM_EXPR`, `DOM_LIST`, `DOM_SET`, and `DOM_TABLE` are mapped recursively, as well as domain elements of a domain `T` for which a slot `T::enableMaprec` exists and equals `TRUE`; a slot `T::map` working properly must then exist, too. To subexpressions of other types, `selector` is applied, but `misc::maprec` is not mapped to their operands. (This is to avoid unwanted substitutions.) If you want to recurse on them, either add an `enableMaprec`-slot, or use a `selector` that selects such subexpressions, and make `funci` initiate another recursive mapping.

---

`misc::maprec` is overloadable. If the domain of a subexpression has a method `"maprec"`, then this method is called with the subexpression and the other arguments of the call.

---

**Note** The subexpression is replaced by the result, but `misc::maprec` is not mapped to its operands; such recursive mapping must be done by the domain method if desired.

---



---

**Note** The operators of expressions (`op(expression, 0)`) are also mapped recursively like all the other operands. Use `NoOperators` to switch this off.

---

## Examples

### Example 1

In the following example every integer of the given expression `a+3+4` is substituted by the value 10. Since `10(n)` returns 10 for every integer `n`, it suffices to write 10 instead of `n -> 10` here.

```
misc::maprec(hold(a+3+4), {DOM_INT} = 10)
```

`a + 20`

In the example above, we used `hold` to suppress the evaluation of the expression because otherwise `a+3+4` is evaluated to `a+7` and we get the result:

```
misc::maprec(a+3+4, {DOM_INT} = 10)
```

$a + 10$ 

The simplification of the resulting  $10 + 10$  to  $20$  can be avoided by using the option `Unsimplified`:

```
misc::maprec(hold(a+3+4), {DOM_INT} = 10, Unsimplified)
```

 $a + 10 + 10$ 

## Example 2

Now we give an example where the `selector` is a function. We want to eliminate all the prime numbers from an expression.

```
misc::maprec(hold(_plus)(i $ i=1..20), isprime= null(), PostMap)
```

133

Here `isprime` returns `TRUE` for every prime number between 1 and 20. Every prime number between 1 and 20 is replaced by `null()` (since `null() (p)` gives `null()`) which means the above call computes the sum of all non-prime numbers between 1 and 20.

## Example 3

Normally, `misc::maprec` recurses also into the operators of subexpressions. This may be unwanted in many cases:

```
misc::maprec(a+b, {DOM_IDENT}= (x -> x.1))
```

 $_plus(a, b)$ 

We just wanted to replace the summands, but not the operator. Using the option `NoOperators` helps:

```
misc::maprec(a+b, {DOM_IDENT}= (x -> x.1), NoOperators)
```

 $a + b$



## Parameters

### **ex**

Any MuPAD object

### **selector**

Any MuPAD object

### **funci**

Any MuPAD object

## Options

### **PreMap**

For each subexpressions  $s$  of  $ex$ , the selector is applied to it *after* visiting all of its subexpressions;  $s$  may have changed at that time due to substitutions in the subexpressions.

### **PostMap**

For each subexpressions  $s$  of  $ex$ , the selector is applied to it *before* visiting its subexpressions. If  $s$  is selected by **selector**, it is replaced by **funci**( $s$ ), and **misc::maprec** is *not* recursively applied to the operands of **funci**( $s$ ); otherwise, **misc::maprec** is recursively applied to the operands of  $s$ .

### **NoOperators**

The selector is not applied to the operator of  $ex$ .

### **Unsimplified**

The resulting expressions are not further simplified.

## Return Values

**misc::maprec** may return any MuPAD object.

## Overloaded By

ex

## See Also

### MuPAD Functions

map | mapcoeffs | misc::breakmap

# misc::pslq

Heuristic detection of relations between real numbers

## Syntax

`misc::pslq(numberlist, precision)`

## Description

`misc::pslq(numberlist, precision)` returns a list of integers  $[k_1, \dots, k_n]$  such that — denoting the elements of `numberlist` by  $a_1, \dots, a_n$  — the absolute

value of  $\sum_{k=1}^n a_k$  is less than  $\frac{1}{\text{precision}}$  times the Euclidean norm of `numberlist`, or FAIL if such integers could not be detected.

This method can be used to get an idea about linear dependencies, before proving them.

## Environment Interactions

`misc::pslq` is *not* affected by the current value of `DIGITS`. Numerical computations are carried out with more significant digits such that the output meets the specification given above.

## Examples

### Example 1

Does  $\pi$  satisfy a polynomial equation of degree at most 2 ?

```
misc::pslq([1, PI, PI^2], 20)
```

FAIL

## Example 2

Having forgotten the relation between sine and cosine, we can try the heuristic way.

```
misc::pslq([1, sin(0.32), sin(0.32)^2, cos(0.32), cos(0.32)^2], 10)
```

```
(1 0 -1 0 -1)
```

## Parameters

### **numberlist**

List of real numbers or objects that can be converted to real numbers by the function `float`.

### **precision**

Positive integer

## Return Values

List of integers, or FAIL

## Algorithms

This function has been written by Raymond Manzoni.

The algorithm has been taken from Bailey and Plouffe, *Recognizing numerical constants*. See also Helaman R.P. Ferguson and David Bailey, *A Polynomial Time, Numerically Stable Integer Relation Algorithm*, RNR Technical Report RNR-92-032.

# numeric - Numerical Algorithms

---

## numeric::butcher

Butcher parameters of Runge-Kutta schemes

### Syntax

`numeric::butcher(EULER1 | RKF43 | xRKF43 | RK4 | RKF34 | xRKF34 | RKF54a | xRKF54a | R`

### Description

`numeric::butcher(method)` returns the Butcher parameters of the Runge-Kutta scheme named `method`.

An  $s$ -stage Runge-Kutta method for the numerical integration of a dynamical system

$\frac{dy}{dt} = f(t, y)$  with step size  $h$  is a map

$$(t, y) \rightarrow (t+h, y+h b_1 k_1 + \dots + h b_s k_s)$$

The “intermediate stages”  $k_1, \dots, k_s$  are defined as the solutions of the algebraic equations

$$k_i = f(t+c_i h, y+h a_{i1} k_1 + \dots + h a_{is} k_s), 1 \leq i \leq s$$

If the  $s \times s$  “Butcher matrix”  $a_{ij}$  is strictly lower triangular, the method is called “explicit”. In this case, the intermediate stages are computed recursively as:

$$k_1 = f(t, y)$$

$$k_2 = f(t+c_2 h, y+h a_{21} k_1)$$

$\vdots$

$$k_s = f\left(t+c_s h, y+h a_{s1} k_1 + \dots + h a_{s,s-1} k_{s-1}\right)$$

Various numerical schemes arise from different choices of the Butcher parameters: the  $s \times s$ -matrix  $a_{ij}$ , the weights  $b = [b_1, \dots, b_s]$  and the abscissae  $c = [c_1, c_2, \dots, c_s]$ .

Embedded pairs of Runge-Kutta methods consist of two methods that share the matrix  $a_{ij}$  and the abscissae  $c_i$ , but use different weights  $b_i$ .

The returned list  $[s, c, a, b_1, b_2, order_1, order_2]$  contains the Butcher data of the method:  $s$  is the number of stages,  $c$  is the list of abscissae,  $a$  is the Butcher matrix,  $b_1$  and  $b_2$  are lists of weights. The integers  $order_1$  and  $order_2$  are the orders of the scheme when using the weights  $b_1$  or  $b_2$ , respectively, in conjunction with the matrix  $a$  and the abscissae  $c$ .

The methods EULER1 (order 1), RK4 (order 4) and BUTCHER6 (order 6) are single methods with  $b_1 = b_2$  and  $order_1 = order_2$ . All other methods are embedded pairs of Runge-Kutta-Fehlberg (RKFxx), Dormand-Prince (DOPRIxx) or Cash-Karp (CKxx) type. The names indicate the orders of the subprocesses, e.g., CK45 is the Cash-Karp pair of orders 4 and 5. CK54 is the same pair with reversed ordering of the subprocesses. The second subprocess is used to produce a time step of the Runge-Kutta method, the first subprocess is used for estimating the error of the time step.

The methods GAUSS( $s$ ) or, equivalently, GAUSS =  $s$  are the implicit Gauss methods with  $s$  stages of order  $2s$ .

The data of all explicit methods are returned as exact rational numbers. The data of the Gauss methods are returned as floating-point numbers.

The Butcher data are called by the routines `numeric::odesolve`, `numeric::odesolve2`, and `numeric::odesolveGeometric`.

## Environment Interactions

When computing the data for GAUSS( $s$ ), the function is sensitive to the environment variable DIGITS, which determines the numerical working precision.

## Examples

### Example 1

The Butcher data of the classical 4 stage, 4th order Runge-Kutta scheme are:

```
numeric::butcher(RK4)
```

$$\left[ 4, \left( 0 \ \frac{1}{2} \ \frac{1}{2} \ 1 \right), \begin{pmatrix} 0 & 0 & 0 & 0 \\ \frac{1}{2} & 0 & 0 & 0 \\ 0 & \frac{1}{2} & 0 & 0 \\ 0 & 0 & 1 & 0 \end{pmatrix}, \left( \frac{1}{6} \ \frac{1}{3} \ \frac{1}{3} \ \frac{1}{6} \right), \left( \frac{1}{6} \ \frac{1}{3} \ \frac{1}{3} \ \frac{1}{6} \right), 4, 4 \right]$$

Note that the weights  $b_1$  and  $b_2$  coincide: this classical method does not provide an embedded pair.

The Butcher data of the (implicit) 3 stage Gauss method:

```
DIGITS := 5:  
numeric::butcher(GAUSS(3));  
delete DIGITS:
```

$$\left[ 3, \left( 0.1127 \ 0.5 \ 0.8873 \right), \begin{pmatrix} 0.13889 & -0.035977 & 0.0097894 \\ 0.30026 & 0.22222 & -0.022485 \\ 0.26799 & 0.48042 & 0.13889 \end{pmatrix}, \right. \\ \left. \left( 0.27778 \ 0.44444 \ 0.27778 \right), \left( 0.27778 \ 0.44444 \ 0.27778 \right), 6, 6 \right]$$

## Example 2

The Butcher data of the embedded Runge-Kutta-Fehlberg pair RKF34 of orders 3 and 4 are:

```
[s, c, a, b1, b2, order1, order2] := numeric::butcher(RKF34):
```

The number of stages  $s$  of the 4th order subprocess is 5, the abscissae  $c$  and the matrix  $a$  are given by:

```
s, c, a
```



$$5, \left( 0 \quad \frac{1}{4} \quad \frac{4}{9} \quad \frac{6}{7} \quad 1 \right), \begin{pmatrix} 0 & 0 & 0 & 0 & 0 \\ \frac{1}{4} & 0 & 0 & 0 & 0 \\ \frac{4}{81} & \frac{32}{81} & 0 & 0 & 0 \\ \frac{57}{98} & -\frac{432}{343} & \frac{1053}{686} & 0 & 0 \\ \frac{1}{6} & 0 & \frac{27}{52} & \frac{49}{156} & 0 \end{pmatrix}$$

Using these parameters with the weights

`b1, b2`

$$\left( \frac{1}{6} \quad 0 \quad \frac{27}{52} \quad \frac{49}{156} \quad 0 \right), \left( \frac{43}{288} \quad 0 \quad \frac{243}{416} \quad \frac{343}{1872} \quad \frac{1}{12} \right)$$

yields a numerical scheme of order 3 or 4, respectively:

`order1, order2`

`3, 4`

delete `s, c, a, b1, b2, order1, order2`:

### Example 3

We plot the stability regions of the two sub-methods of DOPRI78. The stability function of a Runge-Kutta scheme with Butcher parameters  $(c, a, b)$  is given by

$$p(z) = 1 + z \left( \left\langle b, \frac{e}{(1 - z a)} \right\rangle \right),$$

where  $e$  is the column vector  $(1, 1, \dots, 1)^T$ . For an explicit  $s$ -stage scheme (the matrix  $a$  is strictly lower triangular), this stability function reduces to the polynomial

$$p(z) = 1 + \left( \sum_{i=1}^s z^i \left( \left\langle b, a^{i-1} e \right\rangle \right) \right)$$

We compute the coefficients of the stability polynomials associated with the Butcher matrix  $a$  and the weights  $b_1$  and  $b_2$  of the sub-methods of DOPRI78:

```
[s, c, a, b1, b2, order1, order2] := numeric::butcher(DOPRI78):
e := matrix([1 $ s]):
a := float(matrix(a)):
b1 := linalg::transpose(float(matrix(b1))):
b2 := linalg::transpose(float(matrix(b2))):
for i from 1 to s do
    c1[i] := (b1*a^(i-1)*e)[1, 1];
    c2[i] := (b2*a^(i-1)*e)[1, 1];
end_for:
```

We define the stability polynomials:

```
z := x + I*y:
p1 := 1 + _plus(c1[i]*z^i $ i = 1..s):
p2 := 1 + _plus(c2[i]*z^i $ i = 1..s):
```

The boundary of the stability region  $\{z \in \mathbb{C} \mid |p(z)| < 1\}$  is the curve defined by  $|p(z)| = 1$ . We plot these implicit curves associated with the stability polynomials  $p_1(z)$  and  $p_2(z)$  defined above:

```
plot(plot::Implicit2d(abs(p1) = 1, x = -6..1, y = 0..6,
    Color = RGB::Red, Legend = "Order 7"),
    plot::Implicit2d(abs(p2) = 1, x = -6..1, y = 0..6,
    Color = RGB::Blue, Legend = "Order 8"),
    Scaling = Constrained):
```

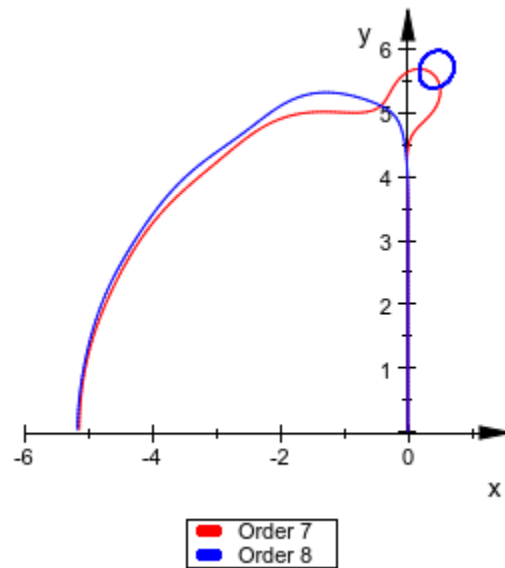

delete *s*, *c*, *a*, *b*<sub>1</sub>, *b*<sub>2</sub>, *order*<sub>1</sub>, *order*<sub>2</sub>, *e*, *c*<sub>1</sub>, *c*<sub>2</sub>, *z*, *p*<sub>1</sub>, *p*<sub>2</sub>:

## Parameters

**s**

The number of stages of the Gauss method: a positive integer

**digits**

The number of significant digits with which the Butcher data of the methods GAUSS(*s*) are computed. The default value for **digits** is the current value of the environment variable DIGITS. This argument is only relevant for the Gauss methods.

## Return Values

A list [*s*, *c*, *a*, *b*<sub>1</sub>, *b*<sub>2</sub>, *order*<sub>1</sub>, *order*<sub>2</sub>] is returned.

## References

J.C. Butcher: *The Numerical Analysis of Ordinary Differential Equations*, Wiley, Chichester (1987).

E. Hairer, S.P. Norsett and G. Wanner: *Solving Ordinary Differential Equations I*, Springer, Berlin (1993).

The methods DOPRI87 and DOPRI78 correspond to the method RK8(7)13M published in:

P.J. Prince and J.R. Dormand: *High order embedded Runge-Kutta formulae*, Journal of Computational and Applied Mathematics 7(1), 1981.

## Algorithms

The Butcher parameters provided in this original paper consist of rational *approximations* of solutions of the order equations of Runge-Kutta systems. The parameters provided by `numeric::butcher` are *exact* rational solutions of the order equations. The approximations given by Prince and Dormand coincide with the MuPAD exact values through 16 decimal digits.

## See Also

### MuPAD Functions

`numeric::odesolve` | `numeric::odesolve2` | `numeric::odesolveGeometric`

# numeric::complexRound

Round a complex number towards the real or imaginary axis

## Syntax

```
numeric::complexRound(z, <eps>)
```

## Description

`numeric::complexRound(z)` discards small real or imaginary parts of complex floating-point numbers  $z$ .

If the real part of  $z$  satisfies  $\Re(z) < \text{eps} |z|$ , then it is replaced by zero and  $\Im(z) i$  is returned.

If the imaginary part of  $z$  satisfies  $\Im(z) < \text{eps} |z|$ , then it is replaced by zero and  $\Re(z)$  is returned.

With the default of `eps=10-DIGITS`, this rounding changes a complex floating-point number by less than the relative standard precision.

Only precisions `eps >= 10-DIGITS` are accepted.

Numerical expressions such as `eps =  $\pi \sqrt{2} 10^{-10}$`  etc. are accepted as `eps`.

This function removes small real or imaginary parts of complex floating-points numbers generated by numerical roundoff. It is used to simplify the floating-point output of `numeric::fsolve`, `numeric::polyroots`, `numeric::polysysroots` and `numeric::sum`.

## Environment Interactions

The function is sensitive to the environment variable `DIGITS`.

## Examples

### Example 1

Exact numbers are not changed:

```
numeric::complexRound(2 + I/10^20)
```

$$2 + \frac{i}{100000000000000000000}$$

Also the following number has an exact imaginary part and is not rounded:

```
numeric::complexRound(2.0 + sqrt(2)*I/10^20)
```

$$2.0 + \frac{\sqrt{2} i}{100000000000000000000}$$

Rounding occurs for complex floats, if this does not change its value significantly:

```
numeric::complexRound(1.0 + 2.0*I/10^10),  
numeric::complexRound(1.0 + 2.0*I/10^11)
```

$$1.0 + 0.0000000002 i, 1.0$$

Note that rounding is based on relative precision, i.e., only the ratio of real and imaginary parts is relevant:

```
numeric::complexRound((1.0 + 2.0*I)/10^100)
```

$$1.0 \cdot 10^{-100} + 2.0 \cdot 10^{-100} i$$

```
numeric::complexRound((1.0 + 1.0/10^11*I)/10^100)
```

$$1.0 \cdot 10^{-100}$$

The relative precision for rounding may be reduced by the optional parameter `eps`:

```
numeric::complexRound(2.0/10^10 + I),  
numeric::complexRound(2.0/10^10 + I, PI/10^5)
```

```
0.0000000002 + 1.0 i, 1.0 i
```

## Parameters

**z**

An arbitrary MuPAD object

**eps**

A real number no less than  $\frac{1}{10^{\text{DIGITS}}}$

## Return Values

If  $z$  is a complex floating-point number, then a real or complex floating-point number is returned. For all other types,  $z$  is returned unchanged.

## See Also

### MuPAD Functions

ceil | floor | frac | round | trunc

## numeric::cubicSpline

Interpolation by cubic splines

### Syntax

```
numeric::cubicSpline([x0, y0], [x1, y1], ..., <BoundaryCondition>, <Symbolic>, <NoWarning>
```

```
numeric::cubicSpline([x0, x1, ...], [y0, y1, ...], <BoundaryCondition>, <Symbolic>, <NoWarni
```

```
numeric::cubicSpline([[x0, x1, ...], [y0, y1, ...]], <BoundaryCondition>, <Symbolic>, <NoWar
```

### Description

`numeric::cubicSpline([x0, y0], [x1, y1], ...)` returns the cubic spline function interpolating a sequence of coordinate pairs  $[x_i, y_i]$ .

The call `S := numeric::cubicSpline([x0, y0], ..., [xn, yn])` yields the cubic spline function  $S$  interpolating the data  $[x_0, y_0], \dots, [x_n, y_n]$ , i.e.,  $S(x_i) = y_i$  for  $i = 0, \dots, n$ . The spline function is a piecewise polynomial of degree  $\leq 3$  on the intervals

$(-\infty, x_1], [x_1, x_2], \dots, [x_{n-1}, \infty)$ .  $S$  and its first two derivatives  $S', S''$  are continuous at the points  $x_1, \dots, x_{n-1}$ . Note that  $S$  extends the polynomial representation on  $[x_0, x_1]$ ,

$[x_{n-1}, x_n]$  to  $(-\infty, x_0]$  and  $[x_{n-1}, \infty)$ , respectively.

By default, `NotAKnot` boundary conditions are assumed, i.e., the third derivative  $S'''$  is continuous at the points  $x_1$  and  $x_{n-1}$ . With this boundary condition,  $S$  is a cubic polynomial

on the intervals  $(-\infty, x_2]$  and  $[x_{n-2}, \infty)$ .

By default, all input data are converted to floating-point numbers. This conversion may be suppressed by the option `Symbolic`.

Without the option `Symbolic`, the abscissae  $x_i$  must be numerical real values in ascending order. If these data are not ordered, then `numeric::cubicSpline` reorders



the abscissae internally, issuing a warning. The warning may be switched off by the option `NoWarning`.

The function `S` returned by `numeric::cubicSpline` may be called with one, two or three arguments:

- The call `S(z)` returns an explicit expression or a number, if  $z$  is a real number. Otherwise, the symbolic call `S(z)` is returned.
- The call `S(z, [k])` with a nonnegative integer  $k$  returns the  $k$ -th derivative of `S`. Cf. “Example 4” on page 19-17 (Symbolic Math Toolbox). For  $k > 3$ , zero is returned for any  $z$ .
- The call `S(z, i)` is meant for symbolic arguments  $z$ . The argument  $i$  must be an integer. Internally,  $z$  is assumed to satisfy  $x_i \leq z < x_{i+1}$ , and `S(z, i)` returns the polynomial expression in  $z$  representing the spline function on this interval.
- The call `S(z, i, [k])` with an integer  $i$  and a nonnegative integer  $k$  returns the polynomial representation of the  $k$ -th derivative of the spline function on the interval  $x_i \leq z < x_{i+1}$ .

If `S` is generated with symbolic abscissae  $x_i$  (necessarily using the option `Symbolic`), then the call `S(z)` with numerical  $z$  leads to an error. The call `S(z, i)` must be used for symbolic abscissae!

---

**Note** Note that the interpolation of 2 points  $(x_0, y_0), (x_1, y_1)$  must be specified by `numeric::cubicSpline( [x0, y0] , [x1, y1] )`, not by `numeric::cubicSpline( [x0, x1] , [y0, y1] )`!

---

## Examples

### Example 1

We demonstrate some calls with numerical input data:

```
data := [i, sin(i*PI/20)] $ i= 0..40:
S1 := numeric::cubicSpline(data):
S2 := numeric::cubicSpline(data, Natural):
S3 := numeric::cubicSpline(data, Periodic):
S4 := numeric::cubicSpline(data, Complete = [3, PI]):
```

At the abscissae, the corresponding input data are reproduced:

`float(data[6][2]), S1(5), S2(5), S3(5), S4(5)`

`0.7071067812, 0.7071067812, 0.7071067812, 0.7071067812, 0.7071067812`

`0.7071067812, 0.7071067812, 0.7071067812, 0.7071067812, 0.7071067812`

Interpolation between the abscissae depends on the boundary condition:

`S1(4.5), S2(4.5), S3(4.5), S4(4.5)`

`0.6494470263, 0.6494470123, 0.6494470123, 0.6517696766`

These are the cubic polynomials in  $z$  defining the spline on the interval  $x_0 = 0 \leq z < x_1 = 1$ :

`expand(S1(z, 0)); expand(S2(z, 0));  
expand(S3(z, 0)); expand(S4(z, 0))`

`-0.000632116114 z3 - 0.00002961951081 z2 + 0.1570962007 z`

`0.1570790998 z - 0.0006446347923 z3`

`-0.0006446347923 z3 + 1.270549421 10-21 z2 + 0.1570790998 z`

`2.080517906 z3 - 4.924083441 z2 + 3.0 z`

`-0.000632116114 z3 - 0.00002961951081 z2 + 0.1570962007 z`

`0.1570790998 z - 0.0006446347923 z3`

`-0.0006446347923 z3 + 1.270549421 10-21 z2 + 0.1570790998 z`

$$2.080517906 z^3 - 4.924083441 z^2 + 3.0 z$$

delete data, S1, S2, S3, S4:

## Example 2

We demonstrate some calls with symbolic data:

```
S := numeric::cubicSpline([i, y.i] $ i = 0..3):
```

```
S(1/2)
```

$$0.3125 y_0 + 0.9375 y_1 - 0.3125 y_2 + 0.0625 y_3$$

This is the cubic polynomial in  $z$  defining the spline on the interval  $x_0 = 0 \leq z < x_1 = 1$ :

```
S(z, 0)
```

$$y_0 - z (1.833333333 y_0 - 3.0 y_1 + 1.5 y_2 - 0.3333333333 y_3 \\ + z (2.5 y_1 - 1.0 y_0 - 2.0 y_2 + 0.5 y_3 + z (0.1666666667 y_0 - 0.5 y_1 + 0.5 y_2 \\ - 0.1666666667 y_3)))$$

With the option `Symbolic`, exact arithmetic is used:

```
S := numeric::cubicSpline([i, y.i] $ i = 0..3, Symbolic):
```

```
S(1/2)
```

$$\frac{5 y_0}{16} + \frac{15 y_1}{16} - \frac{5 y_2}{16} + \frac{y_3}{16}$$

Also symbolic boundary data are accepted:

```
S := numeric::cubicSpline([i, exp(i)] $ i = 0..10,
                          Complete = [a, b]):
```

```
S(0.1)
```

$$0.08341154273 a + 0.00000005947817812 b + 1.020064753$$

```
S := numeric::cubicSpline([0, y0], [1, y1], [2, y2],
                          Symbolic, Complete = [a, 5]):
```

```
collect(S(z, 0), z)
```

$$\left(\frac{3a}{4} + \frac{5y_0}{4} - 2y_1 + \frac{3y_2}{4} - \frac{5}{4}\right) z^3 + \left(3y_1 - \frac{9y_0}{4} - \frac{7a}{4} - \frac{3y_2}{4} + \frac{5}{4}\right) z^2 + az + y_0$$

$$\left(\frac{3a}{4} + \frac{5y_0}{4} - 2y_1 + \frac{3y_2}{4} - \frac{5}{4}\right) z^3 + \left(3y_1 - \frac{9y_0}{4} - \frac{7a}{4} - \frac{3y_2}{4} + \frac{5}{4}\right) z^2 + az + y_0$$

```
delete S:
```

### Example 3

We demonstrate the use of symbolic abscissae. Here the option `Symbolic` is mandatory.

```
S := numeric::cubicSpline([x.i, y.i] $ i = 0..2, Symbolic):
```

The spline function `S` can only be called with 2 arguments. This is the cubic polynomial in `z` defining the spline on the interval  $x_0 \leq z < x_1$ :

```
S(z, 0)
```

$$y_0 + (x_0 - z) \left( (x_0 - z) \left( \frac{y_0 - y_1}{(x_0 - x_1)(x_0 - x_2)} - \frac{y_1 - y_2}{(x_0 - x_2)(x_1 - x_2)} \right) + \frac{(y_0 - y_1)(x_1 - 2x_0 + x_2)}{(x_0 - x_1)(x_0 - x_2)} + \frac{(x_0 - x_1)(y_1 - y_2)}{(x_0 - x_2)(x_1 - x_2)} \right)$$

$$y_0 + (x_0 - z) \left( (x_0 - z) \left( \frac{y_0 - y_1}{(x_0 - x_1)(x_0 - x_2)} - \frac{y_1 - y_2}{(x_0 - x_2)(x_1 - x_2)} \right) + \frac{(y_0 - y_1)(x_1 - 2x_0 + x_2)}{(x_0 - x_1)(x_0 - x_2)} + \frac{(x_0 - x_1)(y_1 - y_2)}{(x_0 - x_2)(x_1 - x_2)} \right)$$

```
delete S:
```

## Example 4

We plot a spline function together with its first three derivatives. The spline approximates the function  $\sin(x)$ :

```
n := 10:
x := array(0..n, [i/n*2*PI $ i = 0..n]):
S := numeric::cubicSpline([x[i], sin(x[i])] $ i = 0..n, Natural):
delete x:
plot(
  plot::Function2d(S(x), x = 0..2*PI, Color = RGB::Black),
  plot::Function2d(S(x, [1]), x = 0..2*PI, Color = RGB::Red),
  plot::Function2d(S(x, [2]), x = 0..2*PI, Color = RGB::Green,
    Mesh = 1000),
  plot::Function2d(S(x, [3]), x = 0..2*PI, Color = RGB::Blue,
    Mesh = 1000)
)
```

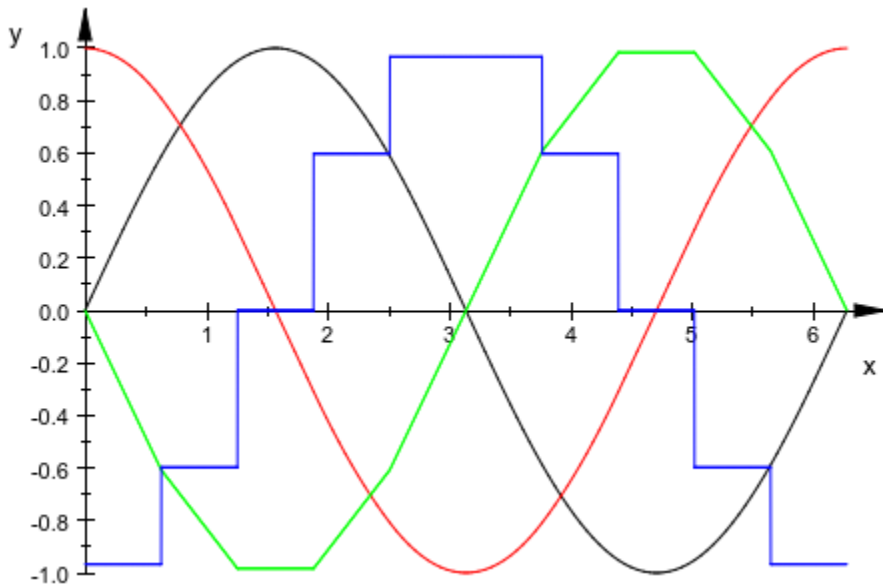

```
delete n, S:
```

## Example 5

We demonstrate how to generate a phase plot of the differential equation

$x''(t) + x(t)^3 = \sin(t)$ , with initial conditions  $x(0) = x'(0) = 0$ . First, we use `numeric::odesolve` to compute a numerical mesh of solution points

$[x_i, y_i] = [x(t_i), x'(t_i)]$  with  $n + 1$  equidistant time nodes  $t_0, \dots, t_n$  in the interval  $[0, 20]$ :

```
DIGITS := 4: n := 100:
for i from 0 to n do t[i] := 20/n*i: end_for:
f := (t, x) -> [x[2], sin(t) - x[1]^3]:
x[0] := 0: y[0] := 0:
for i from 1 to n do
  [x[i], y[i]] :=
  numeric::odesolve(t[i-1]..t[i], f, [x[i-1], y[i-1]]):
end_for:
```

The mesh of the  $(x(t), x'(t))$  phase plot consists of the following points:

```
Plotpoints := [[x[i], y[i]] $ i = 0..n]:
```

We wish to connect these points by a spline curve. We define a spline interpoland  $Sx(t)$  approximating the solution  $x(t)$  by interpolating the data  $[t_0, x_0], \dots, [t_n, x_n]$ . A spline interpoland  $Sy(t)$  approximating  $x'(t)$  is obtained by interpolating the data  $[t_0, y_0], \dots, [t_n, y_n]$ :

```
Sx := numeric::cubicSpline([t[i], x[i]] $ i = 0..n):
Sy := numeric::cubicSpline([t[i], y[i]] $ i = 0..n):
```

Finally, we plot the mesh points together with the interpolating spline curve:

```
plot(
  plot::PointList2d(Plotpoints, PointColor = RGB::Black),
  plot::Curve2d([Sx(z), Sy(z)], z = 0..20, Mesh = 5*(n - 1) + 1,
    LineColor = RGB::Red)
)
```

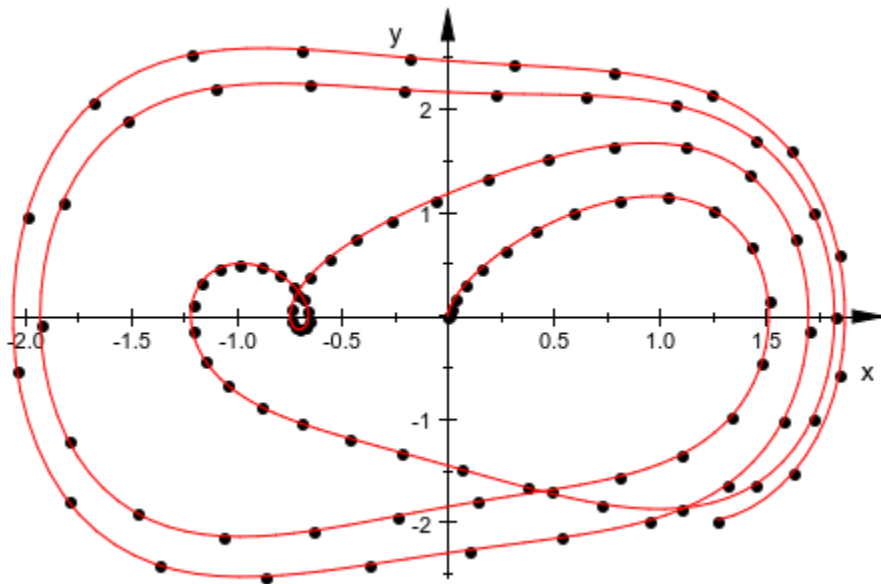

The functions `plot::Ode2d` and `plot::Ode3d` serve for displaying numerical solutions of ODEs. In fact, they are implemented as indicated by the previous commands. The following call produces the same plot:

```
plot(plot::Ode2d(  
  [t[i] $ i = 0..n], f, [x[0], y[0]],  
  [(t, x) -> [x[1], x[2]], Style = Points, Color = RGB::Black],  
  [(t, x) -> [x[1], x[2]], Style = Splines, Color = RGB::Red])):
```

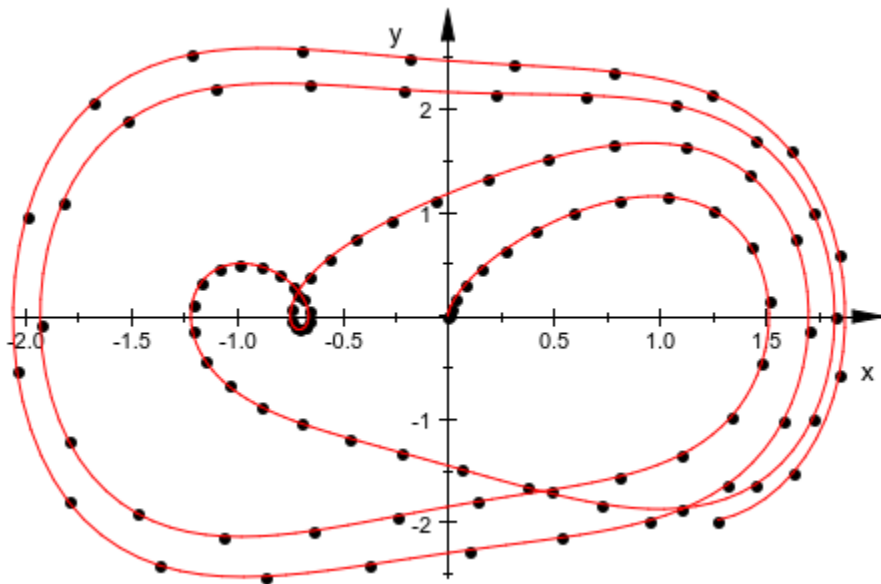

delete DIGITS, n, i, t, f, x, y, Plotpoints, Sx, Sy:

## Parameters

$x_0, x_1, \dots$

Numerical real values in ascending order

$y_0, y_1, \dots$

Arbitrary expressions

### BoundaryCondition

The type of the boundary condition: either NotAKnot, Natural, Periodic, or Complete  
= [a, b] with arbitrary arithmetical expressions a, b.



## Options

### Symbolic

With this option, no conversion of the input data to floating point numbers occurs.

Symbolic abscissae  $x_i$  are accepted.

The ordering  $x_0 < x_1 < \dots < x_n$  is assumed by `numeric::cubicSpline`. This ordering is not checked, even if the abscissae are numerical!

### NoWarning

The  $x$ -values of the interpolation points must be in ascending order. If the input data violate this condition, the routine issues a warning and reorders the data automatically. With this option, the warning is switched off.

### NotAKnot

With the default boundary condition `NotAKnot`, the third derivative  $S'''$  of the spline function is continuous at the points  $x_1$  and  $x_{n-1}$ . With this boundary condition,  $S$  is a

polynomial on the intervals  $(-\infty, x_2]$  and  $[x_{n-2}, \infty)$ .

### Natural

The boundary condition `Natural` produces a spline function  $S$  satisfying

$$S''(x_0) = S''(x_n) = 0.$$

### Periodic

The boundary condition `Periodic` produces a spline function  $S$  satisfying  $S(x_0) = S(x_n)$ ,

$S'(x_0) = S'(x_n)$ ,  $S''(x_0) = S''(x_n)$ . With this option, the input data  $y_0, y_n$  must coincide, otherwise an error is raised.

### Complete

Option, specified as `Complete = [a, b]`

The boundary condition `Complete = [a, b]` produces a spline function  $S$  satisfying

$$S'(x_0) = a, S'(x_n) = b. \text{ Symbolic data } a, b \text{ are accepted.}$$

## **Return Values**

Spline interpoland: a MuPAD procedure.

## **See Also**

### **MuPAD Functions**

`interpolate` | `numeric::cubicSpline2d`

# numeric::cubicSpline2d

Interpolation by 2-dimensional bi-cubic splines

## Syntax

numeric::cubicSpline2d([x<sub>0</sub>, x<sub>1</sub>, ..., x<sub>n</sub>], [y<sub>0</sub>, y<sub>1</sub>, ..., y<sub>m</sub>], z, <[xBC, yBC]>, <Symbolic>)

## Description

numeric::cubicSpline2d([ x<sub>0</sub>, x<sub>1</sub>, ...], [ y<sub>0</sub>, y<sub>1</sub>, ...], z) returns the bi-cubic spline function interpolating data z<sub>i,j</sub> over a rectangular mesh (x<sub>i</sub>, y<sub>j</sub>).

The call `S := numeric::cubicSpline2d([x0, ..., xn], [y0, ..., ym], z, Option)` yields the cubic spline function *S* interpolating the data (x<sub>i</sub>, y<sub>j</sub>, z<sub>i,j</sub>), i.e.  $S(x_i, y_j) = z_{i,j}$  for  $i = 0, \dots, n, j = 0, \dots, m$ . The spline function is a piecewise bi-cubic polynomial: on the 'patch'

$$P_{i,j} = \left\{ (x, y) \mid x_i \leq x < x_{i+1}, y_j \leq y < y_{j+1} \right\},$$

it has the representation

$$S(x, y) = \sum_{u=0}^3 \left( \sum_{v=0}^3 a_{i,j}^{(u,v)} (x-x_i)^u (y-y_j)^v \right)$$

with suitable coefficients  $a_{i,j}^{(u,v)}$  depending on the patch. The spline *S* and its partial derivatives  $S_x, S_y, S_{xx}, S_{xy}, S_{yy}, S_{xxy}, S_{xyy}, S_{xyxy}$  are continuous functions over the entire *x, y* plane. In the *x*-direction, *S* extends the polynomial representation on the boundary

patches  $[x_0, x_1]$  and  $[x_{i-1}, x_i]$  to  $(-\infty, x_1]$  and  $[x_{n-1}, \infty)$ , respectively. The same holds with respect to the *y*-direction.

By default, `NotAKnot` boundary conditions are assumed, i.e., the partial derivatives  $S_{xxx}, S_{yyy}, \dots, S_{xxxxyy}$  are continuous at the points with *x*-coordinates  $x_1$  and  $x_{n-1}$  or *y*-coordinates  $y_1$  and  $y_{m-1}$ .

By default, all input data are converted to floating-point numbers. This conversion may be suppressed by the option `Symbolic`.

Without the option `Symbolic`, the abscissae  $x_i, y_j$  must be numerical real values in ascending order. If these data are not ordered, then `numeric::cubicSpline2d` reorders the abscissae internally, issuing a warning.

The function `S` returned by `numeric::cubicSpline2d` may be called with two, three, four, or five arguments, respectively:

- The call `S(x, y)` returns an arithmetical expression if  $x$  and  $y$  are numerical expressions. A float is returned if either  $x$  or  $y$  is a float and all parameters involved can be converted to floats.

If either  $x$  or  $y$  contains symbolic objects, the symbolic call `S(x, y)` is returned.

- The call `S(x, y, [u, v])` with nonnegative integers  $u, v$  returns the partial

derivative  $\frac{\partial^v}{\partial x^u} S$  of the spline. If either  $x$  or  $y$  contain symbolic objects, the symbolic call `S(x, y, [u, v])` is returned. The result is 0 if either  $u > 3$  or  $v > 3$ . The calls `S(x, y, [0, 0])` and `S(x, y)` are equivalent.

- The call `S(x, y, i, j)` with nonnegative integers  $i, j$  returns the polynomial representation of the spline on the patch  $p_{i,j}$ . Here,  $x$  and  $y$  may be arbitrary numerical or symbolic arithmetical expressions. Internally,  $(x, y)$  are assumed to lie in the patch  $p_{i,j}$ .
- The call `S(x, y, i, j, [u, v])` with nonnegative integers  $i, j, u, v$  returns the polynomial representation of the partial derivatives of the spline function. In this call,  $x$  and  $y$  may be arbitrary numerical or symbolic arithmetical expressions which are assumed to lie in the patch  $p_{i,j}$ . The result is 0 if either  $u > 3$  or  $v > 3$ . The calls `S(x, y, i, j, [0, 0])` and `S(x, y, i, j)` are equivalent.

If `S` is generated with symbolic abscissae  $x_i, y_j$  (necessarily using the option `Symbolic`), the call `S(x, y, [u, v])` is returned symbolically. The call `S(x, y, i, j, [u, v])` must be used for symbolic abscissae!

## Examples

### Example 1

We demonstrate some calls with numerical input data. The function  $f(x, y) = \sin(2\pi(x + y))$  with  $0 \leq x \leq 1$ ,  $0 \leq y \leq 1$  is to be interpolated by  $n + 1 = 11$  equidistant points in the  $x$ -direction and  $m + 1 = 13$  equidistant points in the  $y$ -direction:

```
f := (x, y) -> sin((x + y)*2*PI):
n := 10: x := [i/n $ i = 0..n]:
m := 12: y := [j/m $ j = 0..m]:
z := array(0..n, 0..m, [[f(i/n, j/m) $ j = 0..m] $ i = 0..n]):
S1 := numeric::cubicSpline2d(x, y, z, [NotAKnot, NotAKnot]):
S2 := numeric::cubicSpline2d(x, y, z, [Natural, Natural]):
S3 := numeric::cubicSpline2d(x, y, z, [NotAKnot, Periodic]):
```

We consider Complete boundary conditions in the  $y$ -direction. They consist of the values  $f_y(x_i, y_0) = f_y(x_i, 0) = 2\pi \cos(2\pi x_i)$  and  $f_y(x_i, y_m) = f_y(x_i, 1) = 2\pi \cos(2\pi x_i)$ :

```
ybc:= [[2*PI*cos(2*PI*i/n) $ i = 0..n],
        [2*PI*cos(2*PI*i/n) $ i = 0..n]]:
S4 := numeric::cubicSpline2d(x, y, z, [Periodic, Complete = ybc]):
```

At the mesh points  $(x_i, y_j)$ , the input data  $z_{i,j}$  are reproduced:

```
x := 4/n: y := 8/m:
float(f(x, y), S1(x, y), S2(x, y), S3(x, y), S4(x, y))
```

0.4067366431, 0.4067366431, 0.4067366431, 0.4067366431, 0.4067366431

Interpolation between the mesh points depends on the boundary condition:

```
x := 0.92: y:= 0.55: S1(x, y), S2(x, y), S3(x, y), S4(x, y)
```

0.1879484554, 0.1897776244, 0.1879457306, 0.1873726747

The approximation of the function value  $f(0.92, 0.55)$  is good for the NotAKnot, Periodic, and Complete boundary conditions. The Natural boundary conditions are less appropriate because the second partial derivatives of the function  $f$  do not vanish at the boundaries. Consequently, the approximation error of S2 is larger than the other approximation errors:

```
z := float(f(x, y)):
S1(x, y) - z, S2(x, y) - z, S3(x, y) - z, S4(x, y) - z

0.0005671407743, 0.002396309797, 0.0005644160155, -0.00000863986878
```

This is the bi-cubic polynomial in  $X, Y$  defining the spline  $S1$  on the patch

$$x_0 = 0 \leq X < x_1 = \frac{1}{n}, y_3 = \frac{3}{m} \leq Y \leq y_4 = \frac{4}{m}:$$

```
expand(S1(X, Y, 0, 3))
```

$$\begin{aligned} & -804.8629918 X^3 Y^3 + 6.210308852 X^3 Y^2 + 323.2124519 X^3 Y - 39.06086335 X^3 \\ & - 373.407714 X^2 Y^3 + 770.1743348 X^2 Y^2 - 297.137889 X^2 Y + 7.665899226 X^2 \\ & + 260.7571691 X Y^3 - 199.7700052 X Y^2 + 10.51686235 X Y + 6.008422078 X \\ & + 10.65805697 Y^3 - 28.15535765 Y^2 + 12.07773495 Y - 0.426256024 \end{aligned}$$

```
delete f, n, m, ybc, x, y, z, S1, S2, S3, S4:
```

## Example 2

We demonstrate some calls with symbolic data. With the option `Symbolic`, exact arithmetic is used:

```
S := numeric::cubicSpline2d(
    [i $ i = 0..3],
    [j $ j = 0..4],
    array(0..3, 0..4, [[z.i.j $ j = 0..4] $ i = 0..3]),
    Symbolic
):
S(1/2, 3/2)
```

$$\begin{aligned} & \frac{5 z_{01}}{32} - \frac{15 z_{00}}{1024} + \frac{105 z_{02}}{512} - \frac{5 z_{03}}{128} + \frac{5 z_{04}}{1024} - \frac{45 z_{10}}{1024} + \frac{15 z_{11}}{32} + \frac{315 z_{12}}{512} - \frac{15 z_{13}}{128} \\ & + \frac{15 z_{14}}{1024} + \frac{15 z_{20}}{1024} - \frac{5 z_{21}}{32} - \frac{105 z_{22}}{512} + \frac{5 z_{23}}{128} - \frac{5 z_{24}}{1024} - \frac{3 z_{30}}{1024} + \frac{z_{31}}{32} + \frac{21 z_{32}}{512} - \frac{z_{33}}{128} \\ & + \frac{z_{34}}{1024} \end{aligned}$$

This is the bi-cubic polynomial in  $X, Y$  defining the spline with  $x_0 = 0 \leq X \leq x_1 = 1, y_1 = 1 \leq Y \leq y_2 = 2$ :

```
expand(S(X, Y, 0, 1))
```

$$z_{00} + X^2 z_{00} - \frac{X^3 z_{00}}{6} - \frac{5 X^2 z_{10}}{2} + \dots - \frac{X Y z_{34}}{36}$$

```
delete S:
```

### Example 3

We consider a spline interpolation of the function  $f(x, y) = \frac{1}{e^{x^2+y^2}}$  with  $-1 \leq x \leq 1, -1 \leq y \leq 1$ :

```
n := 10: xmesh := [-1 + 2*i/n $ i = 0..n]:
m := 12: ymesh := [-1 + 2*j/n $ j = 0..m]:
f := (x, y) -> exp(-x^2 - y^2):
z := array(0..n, 0..m,
  [[f(-1 + 2*i/n, -1 + 2*j/m) $ j=0..m] $ i = 0..n]):
S := numeric::cubicSpline2d(xmesh, ymesh, z):
```

We plot the spline function  $S(x, y)$ :

```
plotfunc3d(S(x, y), x = -1 .. 1, y = -1 .. 1):
```

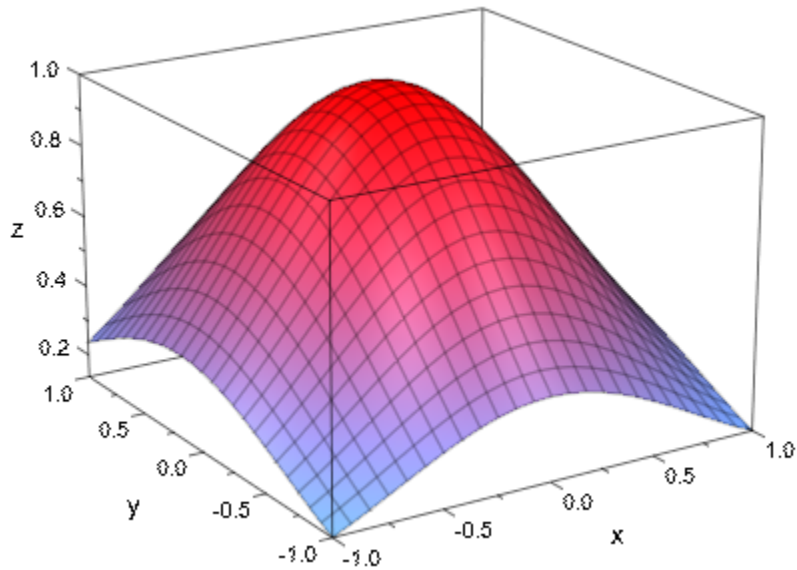

We plot the partial derivative  $S_{xyyy}(x, y)$ . It is constant on each patch with jumps at the boundaries of the patches. The renderer uses  $[5n + 1, 5m + 1]$  mesh points: in each direction, 4 extra points between adjacent mesh points of the spline are used for the graphical representation:

```
plotfunc3d(S(x, y, [3, 3])/10, x = -1 .. 1, y = -1 .. 1,  
           Mesh = [5*n + 1, 5*m+ 1])
```



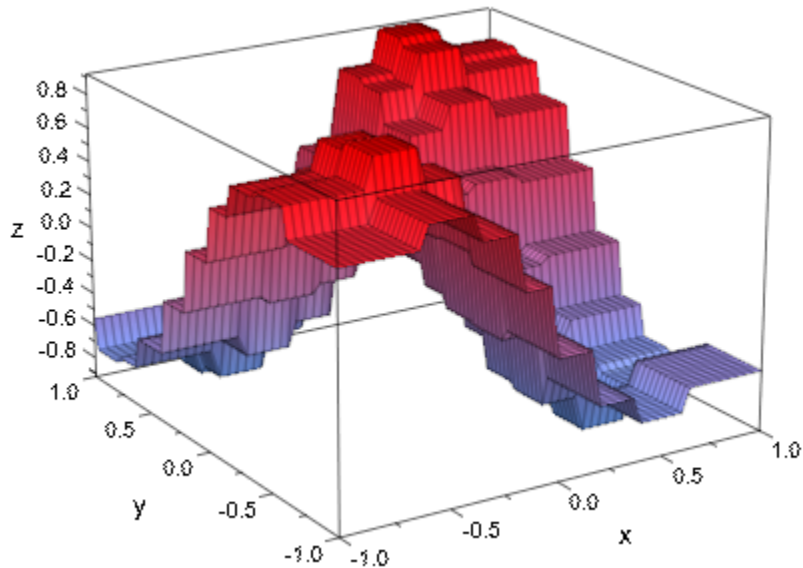

```
delete n, xmesh, m, ymesh, f, z, S:
```

## Example 4

We demonstrate the spline interpretation of a surface. We consider a sphere parametrized by spherical coordinates  $u, v$  with  $0 \leq u \leq 2\pi$ ,  $0 \leq v \leq \pi$ :

$$x = \cos(u) \sin(v), \quad y = \sin(u) \sin(v), \quad z = \cos(v)$$

We interpolate the functions  $x, y, z$  over a rectangular mesh in the  $u$ - $v$ -plane. Since  $x, y$  and (trivially)  $z$  are  $2\pi$ -periodic in  $u$ , we choose **Periodic** boundary conditions for  $u$ . For  $v$ , we choose **Complete** boundary conditions with boundary values of the first partial  $v$ -derivative fitting the parametrization:

```
x:= (u, v) -> cos(u)*sin(v): x_v := diff(x(u, v), v):
y:= (u, v) -> sin(u)*sin(v): y_v := diff(y(u, v), v):
z:= (u, v) -> cos(v): z_v := diff(z(u, v), v):
n := 4: umesh := [i*2*PI/n $ i = 0..n]:
m := 4: vmesh := [j*PI/m $ j = 0..m]:
```

```
vBC := Complete = [  
  [subs(x_v, u = umesh[i], v = vmesh[1]) $ i = 1 .. n+1],  
  [subs(x_v, u = umesh[i], v = vmesh[n + 1]) $ i = 1 .. n+1]]:  
X := numeric::cubicSpline2d(umesh, vmesh,  
  array(0..n, 0..m, [[x(i*2*PI/n, j*PI/m) $ j=0..m] $ i=0..n]),  
  [Periodic, vBC]):  
  
vBC := Complete = [  
  [subs(y_v, u = umesh[i], v = vmesh[1]) $ i = 1 .. n+1],  
  [subs(y_v, u = umesh[i], v = vmesh[n + 1]) $ i = 1 .. n+1]]:  
Y := numeric::cubicSpline2d(umesh, vmesh,  
  array(0..n, 0..m, [[y(i*2*PI/n, j*PI/m) $ j=0..m] $ i=0..n]),  
  [Periodic, vBC]):  
  
vBC := Complete = [  
  [subs(z_v, u = umesh[i], v = vmesh[1]) $ i = 1 .. n+1],  
  [subs(z_v, u = umesh[i], v = vmesh[n + 1]) $ i = 1 .. n+1]]:  
Z := numeric::cubicSpline2d(umesh, vmesh,  
  array(0..n, 0..m, [[z(i*2*PI/n, j*PI/m) $ j=0..m] $ i=0..n]),  
  [Periodic, vBC]):
```

With only  $(n + 1) \times (m + 1) = 5 \times 5$  mesh points, the spline surface yields a respectable approximation of a sphere. The interpolation nodes are added to the plot as blue points:

```
plot(  
  plot::Surface([X(u, v), Y(u, v), Z(u, v)],  
    u = 0..2*PI, v = 0..PI,  
    Mesh = [5*n + 1, 5*m + 1],  
    Color = RGB::Red),  
  plot::Point3d(x(umesh[i], vmesh[j]),  
    y(umesh[i], vmesh[j]),  
    z(umesh[i], vmesh[j]),  
    PointSize = 2*unit::mm,  
    Color = RGB::Blue  
  ) $ i = 1..n+1 $ j = 1..m+1  
):
```

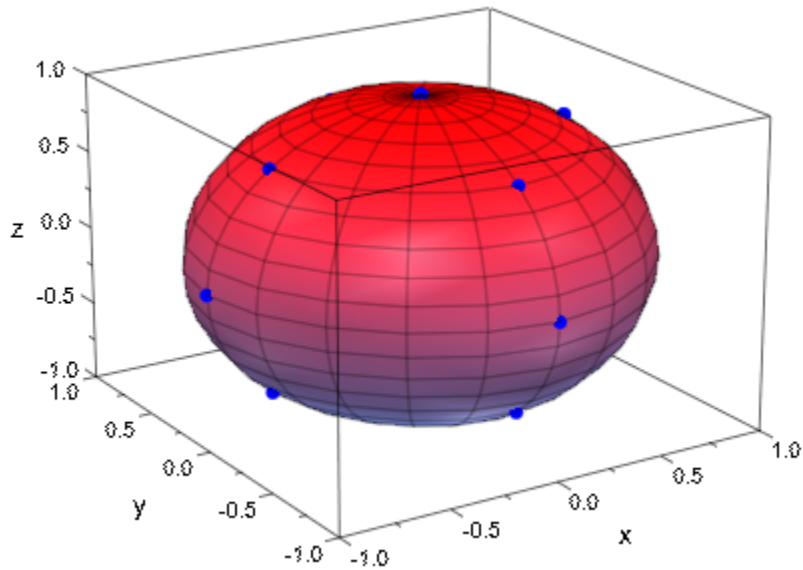

```
delete x, x_v, y, y_v, z, z_v, n, m,
       umesh, vmesh, vBC, X, Y, Z;
```

## Parameters

$x_0, x_1, \dots, x_n$

The  $x$ -coordinates of the nodes: distinct numerical real values in ascending order

$y_0, y_1, \dots, y_m$

The  $y$ -coordinates of the nodes: distinct numerical real values in ascending order

$z$

The function values: an array of the form `array(0..n, 0..m, [...])` with numerical or symbolic arithmetical expressions (Symbolic Math Toolbox).

### **xBC, yBC**

The type of the boundary condition: the boundary condition in the  $x$ - or  $y$ -direction may be one of the flags `NotAKnot`, `Natural`, `Periodic` or `Complete` = [...].

`Complete` boundary conditions consist of prescribed values for the derivatives  $S_x$  or  $S_y$ , respectively, along the mesh boundaries in the  $x$ - or  $y$ -direction, respectively. In the  $x$ -direction, these value may be passed in the form `Complete` =  $[[a_0, \dots, a_m], [b_0, \dots, b_m]]$  with arbitrary numerical or symbolic arithmetical expressions  $a_0, \dots, b_m$ .

In the  $y$ -direction, these value may be passed in the form `Complete` =  $[[a_0, \dots, a_n], [b_0, \dots, b_n]]$  with arbitrary numerical or symbolic arithmetical expressions  $a_0, \dots, b_n$ .

## **Options**

### **Symbolic**

With this option, no conversion of the input data to floating point numbers occurs.

Symbolic abscissae  $x_i, y_j$  are accepted.

The ordering  $x_0 < x_1 < \dots < x_n, y_0 < y_1 < \dots < y_m$  is assumed. This ordering is not checked even if the node coordinates are numerical!

### **NotAKnot**

With the default boundary condition `xBC = yBC = NotAKnot`, all partial derivatives of the spline function are continuous at the nodes with  $x$ -coordinates  $x_1$  and  $x_{n-1}$  or  $y$ -coordinates  $y_1$  and  $y_{m-1}$ , respectively. With this boundary condition,  $S$  is a polynomial on the union of the patches  $p_{0,j}, p_{1,j}$  and  $p_{n-2,j}, p_{n-1,j}$  or  $p_{i,0}, p_{i,1}$  and  $p_{i,m-2}, p_{i,m-1}$ , respectively.

This boundary condition is recommended if no information on the behaviour of the data near the mesh boundaries is available.

### **Natural**

The boundary condition `Natural` produces a spline function  $S$  with vanishing second partial derivatives at the boundary of the mesh.

This boundary condition is recommended if it is known that the data correspond to a surface with vanishing curvature near the mesh boundaries.

### Periodic

The boundary condition `Periodic` produces a spline function  $S$  satisfying

$$S(x_0, y) = S(x_n, y), S'(x_0, y) = S'(x_n, y), S''(x_0, y) = S''(x_n, y)$$

Or

$$S(x, y_0) = S(x, y_m), S'(x, y_0) = S'(x, y_m), S''(x, y_0) = S''(x, y_m),$$

Respectively. With this option, the input data  $z_{0,j}, z_{n,j}$  respectively  $z_{i,0}, z_{i,m}$  must coincide. Otherwise, an error is raised.

This boundary condition is recommended if the interpolation is to represent a periodic function.

### Complete

Option, specified as `Complete = [...]`

The xBC boundary condition `Complete = [[a0, ..., am], [b0, ..., bm]]` produces a spline function  $S$  satisfying  $S_x(x_0, y_j) = a_j, S_x(x_n, y_j) = b_j, j = 0, \dots, m$ .

The yBC boundary condition `Complete = [[a0, ..., an], [b0, ..., bn]]` produces a spline function  $S$  satisfying  $S_y(x_i, y_0) = a_i, S_y(x_i, y_m) = b_i, i = 0, \dots, n$ .

Symbolic data  $a_k, b_k$  are accepted.

This boundary condition is recommended if the data  $z_{i,j}$  correspond to a function with known values of the first partial derivatives at the mesh boundaries.

## Return Values

Spline function: a MuPAD procedure on page 1-1654.

## See Also

### MuPAD Functions

`interpolate` | `numeric::cubicSpline`

# numeric::det

Determinant of a matrix

## Syntax

```
numeric::det(A, <mode>, <MinorExpansion>, <NoWarning>)
```

## Description

`numeric::det(A)` returns the determinant of the matrix  $A$ .

Without the option `Symbolic`, all entries of  $A$  must be numerical. Numerical expressions such as  $e^x$ ,  $\sqrt{2}$  etc. are accepted and converted to floats. If symbolic entries are found in the matrix, `numeric::det` automatically switches to `Symbolic` issuing a warning.

The option `Symbolic` should be used if the matrix contains symbolic objects that cannot be converted to floating point numbers.

---

**Note** Matrices  $A$  of a matrix domain such as `Dom::Matrix(...)` or `Dom::SquareMatrix(...)` are internally converted to arrays over expressions via `expr(A)`. Note that `det` must be used, when the determinant is to be computed over the component domain. See “Example 2” on page 19-37 (Symbolic Math Toolbox). Note that the option `Symbolic` should be used if the entries cannot be converted to numerical expressions.

---

## Environment Interactions

Without the option `Symbolic`, the function is sensitive to the environment variable `DIGITS`, which determines the numerical working precision.

## Examples

### Example 1

Numerical matrices can be processed with or without the option `Symbolic`:

```
A := array(1..3, 1..3, [[1, 1, I], [1, exp(1), I], [1, 2, 2]]):
numeric::det(A), numeric::det(A, Symbolic)
```

$$3.436563657 - 1.718281828 i, e(2-i) - 2 + i$$

The option `Symbolic` must be used when the matrix has non-numerical entries:

```
A := array(1..2, 1..2, [[1/(x + 1), 1], [1/(x + 2), PI]]):
numeric::det(A, Symbolic)
```

$$-\frac{x - 2\pi - \pi x + 1}{(x + 1)(x + 2)}$$

If the option `MinorExpansion` is used, symbolic entries are accepted, even if the option `Symbolic` is not specified:

```
detN := numeric::det(A, MinorExpansion);
detS := numeric::det(A, Symbolic, MinorExpansion)
```

$$\frac{0.0000000008 (2676990817.0 x + 6603981634.0)}{(x + 1.0)(x + 2.0)}$$

$$-\frac{x - 2\pi - \pi x + 1}{(x + 1)(x + 2)}$$

Simplify these results using `Simplify`:

```
Simplify(detN), Simplify(detS)
```

$$\frac{3.141592654}{x + 1.0} - \frac{1.0}{x + 2.0}, \frac{\pi}{x + 1} - \frac{1}{x + 2}$$



```
delete A:
```

## Example 2

The following matrix has domain components:

```
A := Dom::Matrix(Dom::IntegerMod(7))([[6, -1], [1, 6]])
```

$$\begin{pmatrix} 6 \bmod 7 & 6 \bmod 7 \\ 1 \bmod 7 & 6 \bmod 7 \end{pmatrix}$$

Note that `numeric::det` computes the determinant of the following matrix:

```
expr(A), numeric::det(A)
```

$$\begin{pmatrix} 6 & 6 \\ 1 & 6 \end{pmatrix}, 30.0$$

`det` must be used, if the determinant is to be computed over the component domain `Dom::IntegerMod(7)`:

```
det(A)
```

$$2 \bmod 7$$

```
delete A:
```

## Example 3

We demonstrate the use of hardware floats. Hilbert matrices on page 15-93 are notoriously ill-conditioned: the computation of the determinant is subject to severe cancellation effects. The following results, both with `HardwareFloats` as well as with `SoftwareFloats`, are marred by numerical roundoff:

```
A := linalg::hilbert(15):
float(numeric::det(A, Symbolic)),
numeric::det(A, HardwareFloats),
numeric::det(A, SoftwareFloats)
```

$1.058542743 \cdot 10^{-124}$ ,  $-3.822215463 \cdot 10^{-121}$ ,  $3.277553006 \cdot 10^{-123}$

delete A:

## Parameters

**A**

A square matrix of domain type (Symbolic Math Toolbox) `DOM_ARRAY`, or `DOM_HFARRAY`, or of category `Cat::Matrix`

**mode**

One of the flags `Hard`, `HardwareFloats`, `Soft`, `SoftwareFloats`, or `Symbolic`

## Options

### **Hard, HardwareFloats, Soft, SoftwareFloats**

With `Hard` (or `HardwareFloats`), computations are done using fast hardware float arithmetic from within a MuPAD session. `Hard` and `HardwareFloats` are equivalent. With this option, the input data are converted to hardware floats and processed by compiled C code. The result is reconverted to MuPAD floats and returned to the MuPAD session.

With `Soft` (or `SoftwareFloats`) computations are done using software float arithmetic provided by the MuPAD kernel. `Soft` and `SoftwareFloats` are equivalent. `SoftwareFloats` is used by default if the current value of `DIGITS` is larger than 15 and the input matrix `A` is not of domain type `DOM_HFARRAY`.

Compared to the `SoftwareFloats` used by the MuPAD kernel, the computation with `HardwareFloats` may be many times faster. Note, however, that the precision of hardware arithmetic is limited to about 15 digits. Further, the size of floating-point numbers may not be larger than approximately  $10^{308}$  and not smaller than approximately  $10^{-308}$ .

If no `HardwareFloats` or `SoftwareFloats` are requested explicitly, the following strategy is used: If the current value of `DIGITS` is smaller than 16 or if the matrix `A` is a

hardware float array of domain type `DOM_HFARRAY`, then hardware arithmetic is tried. If this is successful, the result is returned.

If the result cannot be computed with hardware floats, software arithmetic by the MuPAD kernel is tried.

If the current value of `DIGITS` is larger than 15 and the input matrix `A` is not of domain type `DOM_HFARRAY`, or if one of the options `Soft`, `SoftwareFloats` or `Symbolic` is specified, MuPAD computes the result with its software arithmetic without trying to use hardware floats first.

There may be several reasons for hardware arithmetic to fail:

- The current value of `DIGITS` is larger than 15.
- The data contains symbolic objects.
- The data contains numbers larger than  $10^{308}$  or smaller than  $10^{-308}$  that cannot be represented by hardware floats.

If neither `HardwareFloats` nor `SoftwareFloats` is specified, the user is not informed whether hardware floats or software floats are used.

If `HardwareFloats` are specified but fail due to one of the reasons above, a warning is issued that the (much slower) software floating-point arithmetic of the MuPAD kernel is used.

Note that `HardwareFloats` can only be used if all input data can be converted to floating-point numbers.

The trailing digits in floating-point results computed with `HardwareFloats` and `SoftwareFloats` may differ.

---

**Note** For ill conditioned matrices the results returned with `HardwareFloats` and `SoftwareFloats` may differ significantly! See “Example 3” on page 19-37 (Symbolic Math Toolbox).

---

## Symbolic

This option prevents conversion of the input data to floats. With this option, symbolic entries are accepted. It overrides the option `HardwareFloats`.

---

**Note** This option should not be used for floating-point matrices! The `Symbolic` algorithm does not implement safeguards against numerical instabilities in floating-point operations.

---

### **MinorExpansion**

With this option, recursive minor expansion along the columns is used. This option may be useful for small matrices with symbolic entries.

This option implies `SoftwareFloats`.

With this option, symbolic entries are accepted even if the option `Symbolic` is not used.

### **NoWarning**

Suppresses warnings

## **Return Values**

By default, the determinant is returned as a floating-point number. With the option `Symbolic`, an expression is returned.

## **Algorithms**

Without the option `Symbolic`,  $QR$ -factorization of  $A$  via Householder transformations is used.

With `Symbolic`,  $LU$ -factorization of  $A$  is used.

## **See Also**

### **MuPAD Functions**

`det`

## **Topics**

“Compute Determinant Numerically” (Symbolic Math Toolbox)

## numeric::eigenvalues

Numerical eigenvalues of a matrix

### Syntax

```
numeric::eigenvalues(A, options)
```

### Description

`numeric::eigenvalues(A)` returns numerical eigenvalues of the matrix  $A$ .

All entries of  $A$  must be numerical. Numerical expressions such as  $e^{\pi}$ ,  $\sqrt{2}$  etc. are accepted and converted to floats. Non-numerical symbolic entries lead to an error.

---

**Note** Matrices  $A$  of a matrix domain such as `Dom::Matrix(...)` or `Dom::SquareMatrix(...)` are internally converted to arrays over expressions via `expr(A)`. Note that `linalg::eigenvalues` must be used, when the eigenvalues are to be computed over the component domain. Cf. "Example 2" on page 19-44 (Symbolic Math Toolbox).

---

The eigenvalues are sorted by `numeric::sort`.

---

**Note** Eigenvalues are approximated with an *absolute* precision of  $\frac{r}{\text{DIGITS}}$ , where  $r$  is the spectral radius of  $A$  (i.e.,  $r$  is the maximum of the absolute values of the eigenvalues). Consequently, large eigenvalues should be computed correctly to `DIGITS` decimal places. The numerical approximations of the small eigenvalues are less accurate.

---

### Environment Interactions

The function is sensitive to the environment variable `DIGITS`, which determines the numerical working precision.

## Examples

### Example 1

We compute the eigenvalues of the 3×3 Hilbert matrix on page 15-93:

```
numeric::eigenvalues(linalg::hilbert(3))
```

```
[1.408318927, 0.1223270659, 0.002687340356]
```

The following matrix is ill-conditioned. It has very large as well as very small eigenvalues:

```
A := array(1..3, 1..3,
           [[ I      ,      PI  ,  exp(1) ],
            [  2      ,  10^100 ,    1   ],
            [10^(-100), 10^(-100), 10^(-100)]
           ]):
```

Precision goal and working precision are set by DIGITS. With the standard setting of *DIGITS* = 10, the following result is computed with HardwareFloats:

```
numeric::eigenvalues(A)
```

```
[1.0 10100, 5.0 10-101, 1.0 i]
```

```
[1.0 10100, 5.0 10-101, 1.0 i]
```

Note that small eigenvalues may be influenced by roundoff. We increase the working precision by increasing *DIGITS*. The smallest of the eigenvalues is computed more accurately:

```
DIGITS := 200:
eigenvals := numeric::eigenvalues(A):
DIGITS := 5:
eigenvals;
```

```
[1.0 10100 + 6.2832 10-200 i, 1.0 10-100 + 2.7183 10-100 i, -6.2832 10-100 + 1.0 i]
```

```
delete A, eigenvals, DIGITS:
```

## Example 2

The following matrix has domain components:

```
A := Dom::Matrix(Dom::IntegerMod(7))(
    [[6, -1, 4], [0, 3, 3], [0, 0, 3]])
```

$$\begin{pmatrix} 6 \bmod 7 & 6 \bmod 7 & 4 \bmod 7 \\ 0 \bmod 7 & 3 \bmod 7 & 3 \bmod 7 \\ 0 \bmod 7 & 0 \bmod 7 & 3 \bmod 7 \end{pmatrix}$$

Note that `numeric::eigenvalues` computes the eigenvalues of the following matrix:

```
expr(A), numeric::eigenvalues(A)
```

$$\begin{pmatrix} 6 & 6 & 4 \\ 0 & 3 & 3 \\ 0 & 0 & 3 \end{pmatrix}, [6.0, 3.0, 3.0]$$

If the eigenvalues are to be computed over the component domain `Dom::IntegerMod(7)`, `linalg::eigenvalues` should be used:

```
linalg::eigenvalues(A, Multiple)
```

$$[[3 \bmod 7, 2], [6 \bmod 7, 1]]$$

```
delete A:
```

## Example 3

We demonstrate the use of hardware floats. Hilbert matrices on page 15-93 are notoriously ill-conditioned: the computation of small eigenvalues is subject to severe roundoff effects. In the following results, both with `HardwareFloats` as well as with `SoftwareFloats`, the small eigenvalues are marred by numerical roundoff:



```
A := linalg::hilbert(15):
numeric::eigenvalues(A, HardwareFloats),
numeric::eigenvalues(A, SoftwareFloats)
```

$$\left[ 1.845927746, \dots, 8.619013323 \cdot 10^{-17}, 2.268836709 \cdot 10^{-17} \right],$$

$$\left[ 1.845927746, \dots, 2.095930088 \cdot 10^{-18}, 6.646989777 \cdot 10^{-21} \right]$$

```
delete A:
```

## Parameters

**A**

A numerical matrix of domain type (Symbolic Math Toolbox) `DOM_ARRAY`, `DOM_HFARRAY`, or of category `Cat::Matrix`.

## Options

### Hard, HardwareFloats, Soft, SoftwareFloats

With `Hard` (or `HardwareFloats`), computations are done using fast hardware float arithmetic from within a MuPAD session. `Hard` and `HardwareFloats` are equivalent. With this option, the input data are converted to hardware floats and processed by compiled C code. The result is reconverted to MuPAD floats and returned to the MuPAD session.

With `Soft` (or `SoftwareFloats`) computations are done using software float arithmetic provided by the MuPAD kernel. `Soft` and `SoftwareFloats` are equivalent. `SoftwareFloats` is used by default if the current value of `DIGITS` is larger than 15 and the input matrix `A` is not of domain type `DOM_HFARRAY`.

Compared to the `SoftwareFloats` used by the MuPAD kernel, the computation with `HardwareFloats` may be many times faster. Note, however, that the precision of hardware arithmetic is limited to about 15 digits. Further, the size of floating-point numbers may not be larger than approximately  $10^{308}$  and not smaller than approximately  $10^{-308}$ .

If no `HardwareFloats` or `SoftwareFloats` are requested explicitly, the following strategy is used: If the current value of `DIGITS` is smaller than 16 or if the matrix `A` is a hardware float array of domain type `DOM_HFARRAY`, then hardware arithmetic is tried. If this is successful, the result is returned.

If the result cannot be computed with hardware floats, software arithmetic by the MuPAD kernel is tried.

If the current value of `DIGITS` is larger than 15 and the input matrix `A` is not of domain type `DOM_HFARRAY`, or if one of the options `Soft`, `SoftwareFloats` or `Symbolic` is specified, MuPAD computes the result with its software arithmetic without trying to use hardware floats first.

There may be several reasons for hardware arithmetic to fail:

- The current value of `DIGITS` is larger than 15.
- The data contains symbolic objects.
- The data contains numbers larger than  $10^{308}$  or smaller than  $10^{-308}$  that cannot be represented by hardware floats.

If neither `HardwareFloats` nor `SoftwareFloats` is specified, the user is not informed whether hardware floats or software floats are used.

If `HardwareFloats` are specified but fail due to one of the reasons above, a warning is issued that the (much slower) software floating-point arithmetic of the MuPAD kernel is used.

Note that `HardwareFloats` can only be used if all input data can be converted to floating-point numbers.

The trailing digits in floating-point results computed with `HardwareFloats` and `SoftwareFloats` may differ.

---

**Note** For ill conditioned matrices the results returned with `HardwareFloats` and `SoftwareFloats` may differ significantly! See “Example 3” on page 19-44 (Symbolic Math Toolbox).

---

### **NoWarning**

Suppresses warnings

## Return Values

Ordered list of numerical eigenvalues

## Algorithms

The function implements standard numerical algorithms from the Handbook of Automatic Computation by Wilkinson and Reinsch.

## See Also

### MuPAD Functions

`linalg::eigenvalues` | `linalg::eigenvectors` | `numeric::eigenvectors` |  
`numeric::singularvalues` | `numeric::singularvectors` |  
`numeric::spectralradius`

## Topics

“Compute Eigenvalues and Eigenvectors Numerically” (Symbolic Math Toolbox)

## numeric::eigenvectors

Numerical eigenvalues and eigenvectors of a matrix

### Syntax

```
numeric::eigenvectors(A, options)
```

### Description

`numeric::eigenvectors(A)` returns numerical eigenvalues and eigenvectors of the matrix  $A$ .

All entries of the matrix must be numerical. Numerical expressions such as  $e^x$ ,  $\sqrt{2}$  etc. are accepted and converted to floats. Non-numerical symbolic entries lead to an error.

The eigenvalues are sorted by `numeric::sort`.

The matrix  $X$  provides the eigenvectors: the  $i$ -th column of  $X$  is a numerical eigenvector corresponding to the eigenvalue  $d_i$ . Each column is either zero or normalized to the Euclidean length 1.0.

For matrices with multiple eigenvalues and an insufficient number of eigenvectors, some of the eigenvectors may coincide or may be zero, i.e.,  $X$  is not necessarily invertible.

The list of residues  $res = [res_1, res_2, \dots]$  provides some control over the quality of the numerical spectral data. The residues are given by

$$res_i = \|A x_i - d_i x_i\|_2,$$

where  $x_i$  is the normalized eigenvector (the  $i$ -th column of  $X$ ) associated with the numerical eigenvalue  $d_i$ . For Hermitian matrices,  $res_i$  provides an upper bound for the absolute error of  $d_i$ .

With the option `NoResidues`, the computation of the residues is suppressed, the returned value is `NIL`.

If no return type is specified via the option `ReturnType = t`, the domain type of the eigenvector matrix  $X$  depends on the type of the input matrix  $A$ :

- The eigenvectors of an array on page 7-2 are returned as an array on page 7-2.
- The eigenvectors of an hfarray on page 7-27 are returned as an hfarray on page 7-27.
- The eigenvectors of a dense matrix of type `Dom::DenseMatrix()` are returned as a dense matrix of type `Dom::DenseMatrix()` over the ring of expressions.
- For all other matrices of category `Cat::Matrix`, the eigenvectors are returned as matrices on page 1-1340 of type `Dom::Matrix()` over the ring of MuPAD expressions. This includes input matrices  $A$  of type `Dom::Matrix(...)`, `Dom::SquareMatrix(...)`, `Dom::MatrixGroup(...)` etc.

---

**Note** Matrices  $A$  of a matrix domain such as `Dom::Matrix(...)` or `Dom::SquareMatrix(...)` are internally converted to arrays over expressions via `expr(A)`. Note that `linalg::eigenvectors` must be used, when the eigenvalues/vectors are to be computed over the component domain. Cf. “Example 3” on page 19-51 (Symbolic Math Toolbox).

---

---

**Note** Eigenvalues are approximated with an *absolute* precision of  $\frac{r}{10^{\text{DIGITS}}}$ , where  $r$  is the spectral radius of  $A$  (i.e.,  $r$  is the maximal singular value on page 19-317 of *A*). Consequently, large eigenvalues should be computed correctly to `DIGITS` decimal places. The numerical approximations of the small eigenvalues are less accurate.

---

---

**Note** For a numerical algorithm, it is not possible to distinguish between badly separated distinct eigenvalues and multiple eigenvalues. For this reason, `numeric::eigenvectors` and `linalg::eigenvectors` use different return formats: the latter can provide information on the multiplicity of eigenvalues due to its internal exact arithmetic.

---

Use `numeric::eigenvalues` if only eigenvalues are to be computed.

## Environment Interactions

The function is sensitive to the environment variable `DIGITS`, which determines the numerical working precision.

## Examples

### Example 1

We compute the spectral data of the 2×2 Hilbert matrix on page 15-93:

```
A := linalg::hilbert(2)
```

$$\begin{pmatrix} 1 & \frac{1}{2} \\ \frac{1}{2} & \frac{1}{3} \end{pmatrix}$$

```
[d, X, res] := numeric::eigenvalues(A):
```

The eigenvalues:

```
d
```

```
[1.267591879, 0.06574145409]
```

The eigenvectors:

```
X
```

$$\begin{pmatrix} 0.8816745988 & -0.4718579255 \\ 0.4718579255 & 0.8816745988 \end{pmatrix}$$

Hilbert matrices are Hermitian, i.e., computing the spectral data is a numerically stable process. This is confirmed by the small residues:

```
res
```

```
[2.355138688 10-16, 1.388645872 10-16]
```

The routine `linalg::hilbert` provides the input as a matrix of type `Dom::Matrix()`. Consequently, the eigenvectors also consist of such a matrix. For further processing, we convert the list of eigenvalues to a diagonal matrix:

```
d := matrix(2, 2, d, Diagonal):
```

We reconstruct the matrix from its spectral data:

```
X*d*X^(-1)
```

$$\begin{pmatrix} 1.0 & 0.5 \\ 0.5 & 0.333333333333 \end{pmatrix}$$

We extract an eigenvector from the matrix X and doublecheck its numerical quality:

```
eigenvector1 := X::dom::col(X, 1);
norm(A*eigenvector1 - d[1, 1]*eigenvector1)
```

$$\begin{pmatrix} 0.8816745988 \\ 0.4718579255 \end{pmatrix}$$

$$1.769417945 \cdot 10^{-16}$$

```
delete A, d, X, res, eigenvector1:
```

## Example 2

We demonstrate a numerically ill-conditioned case. The following matrix has only one eigenvector and cannot be diagonalized. Numerically, the zero vector is returned as the second column of the eigenvector matrix:

```
A := array(1..2, 1..2, [[5, -1], [4, 1]]):
DIGITS := 6:
numeric::eigenvectors(A)
```

$$\left[ [3.0, 3.0], \begin{pmatrix} 0.447214 & 0 \\ 0.894427 & 0 \end{pmatrix}, [1.66533 \cdot 10^{-16}, 0.0] \right]$$

```
delete A, DIGITS:
```

## Example 3

The following matrix has domain components:

```
A := Dom::Matrix(Dom::IntegerMod(7))([[6, -1], [0, 3]])
```

$$\begin{pmatrix} 6 \bmod 7 & 6 \bmod 7 \\ 0 \bmod 7 & 3 \bmod 7 \end{pmatrix}$$

Note that `numeric::eigenvectors` computes the spectral data of the following matrix:

```
expr(A)
```

$$\begin{pmatrix} 6 & 6 \\ 0 & 3 \end{pmatrix}$$

```
numeric::eigenvectors(A, NoResidues)
```

$$\left[ [6.0, 3.0], \begin{pmatrix} 1.0 & 0.894427191 \\ 0 & -0.4472135955 \end{pmatrix}, \text{NIL} \right]$$

The routine `linalg::eigenvectors` should be used if the spectral data are to be computed over the component domain `Dom::IntegerMod(7)`:

```
linalg::eigenvectors(A)
```

$$\left[ \left[ 3 \bmod 7, 1, \left[ \begin{pmatrix} 5 \bmod 7 \\ 1 \bmod 7 \end{pmatrix} \right] \right], \left[ 6 \bmod 7, 1, \left[ \begin{pmatrix} 1 \bmod 7 \\ 0 \bmod 7 \end{pmatrix} \right] \right] \right]$$

```
delete A:
```

## Example 4

We demonstrate the use of hardware floats. The following matrix is degenerate: it has rank 1. For the double eigenvalue 0, different base vectors of the corresponding eigenspace are returned with `HardwareFloats` and `SoftwareFloats`, respectively:

```
A := array(1..3, 1..3, [[1, 2, 3], [2, 4, 6],  
                      [3*10^12, 6*10^12, 9*10^12]]):  
[d1, X1, res1] := numeric::eigenvectors(A, HardwareFloats):  
d1, X1
```



$$\left[ 9.0 \cdot 10^{12}, 0.0, -4.543838814 \cdot 10^{-16} \right],$$

$$\begin{pmatrix} 3.333333333 \cdot 10^{-13} & 0.9486832981 & 0.9621023987 \\ 6.666666667 \cdot 10^{-13} & -2.108185107 \cdot 10^{-13} & -0.1012739367 \\ 1.0 & -0.316227766 & -0.2531848418 \end{pmatrix}$$

```
[d2, X2, res2] := numeric::eigenvectors(A, SoftwareFloats):
d2, X2
```

$$\left[ 9.0 \cdot 10^{12}, 5.421010862 \cdot 10^{-20}, 0.0 \right], \begin{pmatrix} 0 & 0.9592641938 & 0.9486832981 \\ 0 & -0.06851887098 & 0 \\ 1.0 & -0.2740754839 & -0.316227766 \end{pmatrix}$$

```
delete A, d1, X1, res1, d2, X2, res2:
```

## Parameters

### A

A numerical matrix of domain type (Symbolic Math Toolbox) `DOM_ARRAY`, or `DOM_HFARRAY`, or of category `Cat::Matrix`.

## Options

### Hard, HardwareFloats, Soft, SoftwareFloats

With `Hard` (or `HardwareFloats`), computations are done using fast hardware float arithmetic from within a MuPAD session. `Hard` and `HardwareFloats` are equivalent. With this option, the input data are converted to hardware floats and processed by compiled C code. The result is reconverted to MuPAD floats and returned to the MuPAD session.

With `Soft` (or `SoftwareFloats`) computations are done using software float arithmetic provided by the MuPAD kernel. `Soft` and `SoftwareFloats` are equivalent.

`SoftwareFloats` is used by default if the current value of `DIGITS` is larger than 15 and the input matrix `A` is not of domain type `DOM_HFARRAY`.

Compared to the `SoftwareFloats` used by the MuPAD kernel, the computation with `HardwareFloats` may be many times faster. Note, however, that the precision of hardware arithmetic is limited to about 15 digits. Further, the size of floating-point numbers may not be larger than approximately  $10^{308}$  and not smaller than approximately  $10^{-308}$ .

If no `HardwareFloats` or `SoftwareFloats` are requested explicitly, the following strategy is used: If the current value of `DIGITS` is smaller than 16 or if the matrix `A` is a hardware float array of domain type `DOM_HFARRAY`, then hardware arithmetic is tried. If this is successful, the result is returned.

If the result cannot be computed with hardware floats, software arithmetic by the MuPAD kernel is tried.

If the current value of `DIGITS` is larger than 15 and the input matrix `A` is not of domain type `DOM_HFARRAY`, or if one of the options `Soft`, `SoftwareFloats` or `Symbolic` is specified, MuPAD computes the result with its software arithmetic without trying to use hardware floats first.

There may be several reasons for hardware arithmetic to fail:

- The current value of `DIGITS` is larger than 15.
- The data contains symbolic objects.
- The data contains numbers larger than  $10^{308}$  or smaller than  $10^{-308}$  that cannot be represented by hardware floats.

If neither `HardwareFloats` nor `SoftwareFloats` is specified, the user is not informed whether hardware floats or software floats are used.

If `HardwareFloats` are specified but fail due to one of the reasons above, a warning is issued that the (much slower) software floating-point arithmetic of the MuPAD kernel is used.

Note that `HardwareFloats` can only be used if all input data can be converted to floating-point numbers.

The trailing digits in floating-point results computed with `HardwareFloats` and `SoftwareFloats` may differ.

---

**Note** For ill conditioned matrices the results returned with `HardwareFloats` and `SoftwareFloats` may differ significantly! See “Example 4” on page 19-52 (Symbolic Math Toolbox).

---

### **NoResidues**

Suppresses the computation of error estimates

If no error estimates are required, this option may be used to suppress the computation of the residues `res`. The return values for these data are `NIL`.

The alternative option name `NoErrors` used in previous MuPAD versions is still available.

### **ReturnType**

Option, specified as `ReturnType = t`

Return the eigenvectors as a matrix of domain type (Symbolic Math Toolbox) `t`. The following return types `t` are available: `DOM_ARRAY`, `DOM_HFARRAY`, `Dom::Matrix()`, or `Dom::DenseMatrix()`.

### **NoWarning**

Suppresses warnings

## **Return Values**

List `[d, X, res]`. The list `d = [d1, d2, ...]` contains the numerical eigenvalue. The  $i$ -th column of the matrix `X` is the eigenvector associated with the eigenvalue `di`. The list of residues `res = [res1, res2, ...]` provides error estimates for the numerical eigenvalues.

## **Algorithms**

The routine implements standard numerical algorithms from the Handbook of Automatic Computation by Wilkinson and Reinsch.

## See Also

### MuPAD Functions

`linalg::eigenvalues` | `linalg::eigenvectors` | `numeric::eigenvalues` |  
`numeric::singularvalues` | `numeric::singularvectors` |  
`numeric::spectralradius`

### Topics

"Compute Eigenvalues and Eigenvectors Numerically" (Symbolic Math Toolbox)

# numeric::expMatrix

Exponential of a matrix

## Syntax

```
numeric::expMatrix(A, <mode>, <method>, options)
```

```
numeric::expMatrix(A, x, <mode>, <method>, options)
```

```
numeric::expMatrix(A, X, <mode>, <method>, options)
```

## Description

`numeric::expMatrix(A)` returns the exponential  $e^A$  of a square matrix  $A$ .

`numeric::expMatrix(A, x)` with a vector  $x$  returns the vector  $e^A x$ .

`numeric::expMatrix(A, X)` with a matrix  $X$  returns the matrix  $e^A X$ .

If no return type is specified via the option `ReturnType = d`, the domain type of the result depends on the type of the input matrix  $A$ :

- For an array on page 7-2  $A$ , the result is returned as an array on page 7-2.
- For an hfarray on page 7-2  $A$ , the result is returned as an hfarray on page 7-27.
- For a dense matrix on page 1-506A of type `Dom::DenseMatrix(Ring)`, the result is again a matrix of type `Dom::DenseMatrix()` over the ring of expressions.
- For all other matrices  $A$  of category `Cat::Matrix`, the result is returned as a matrix of type `Dom::Matrix()` over the ring of expressions. This includes input matrices  $A$  of type `Dom::Matrix(Ring)`, `Dom::SquareMatrix(Ring)`, `Dom::MatrixGroup(Ring)` etc.

The components of  $A$  must not contain symbolic objects which cannot be converted to

numerical values via `float`. Numerical symbolic expressions such as  $\pi$ ,  $\sqrt{2}$ ,  $e^{-1}$  etc. are accepted. They are converted to floats.

The specification of a method such as `TaylorExpansion` etc. implies `SoftwareFloats`, i.e., the result is computed via the software arithmetic of the MuPAD kernel.

The methods `Diagonalization` and `Interpolation` do not work for all matrices (see below).

With `SoftwareFloats`, special algorithms are implemented for traceless  $2 \times 2$  matrices and skew symmetric  $3 \times 3$  matrices. Specification of a particular method does not have any effect for such matrices.

If  $e^A x$  or  $e^A X$  is required, one should not compute  $e^A$  first and then multiply the resulting matrix with the vector/matrix  $x/X$ . In general, the call `numeric::expMatrix(A, x)` or `numeric::expMatrix(A, X)`, respectively, is faster.

## Environment Interactions

The function is sensitive to the environment variable `DIGITS`, which determines the numerical working precision.

## Examples

### Example 1

We consider a lower triangular matrix given by an array on page 7-2:

```
A := array(1..2, 1..2, [[1, 0] , [1, PI]]):  
expA := numeric::expMatrix(A)
```

$$\begin{pmatrix} 2.718281828 & 0 \\ 9.536085572 & 23.14069263 \end{pmatrix}$$

We consider a vector given by a list  $x_1$  and by an equivalent 1-dimensional array  $x_2$ , respectively:

```
x1 := [1, 1]:  
x2 := array(1..2, [1, 1]):
```

Further, an equivalent input vector  $X$  of type `Dom::Matrix()` is used:

```
X := matrix(x1):
```

The following three calls all yield a vector represented by an 2×1 array on page 7-2 corresponding to the type of the input matrix A:

```
numeric::expMatrix(A, x1),
numeric::expMatrix(A, x2, Krylov),
numeric::expMatrix(A, X, Diagonalization)
```

$$\begin{pmatrix} 2.718281828 \\ 32.6767782 \end{pmatrix}, \begin{pmatrix} 2.718281828 \\ 32.6767782 \end{pmatrix}, \begin{pmatrix} 2.718281828 \\ 32.6767782 \end{pmatrix}$$

For further processing, the array expA is converted to an element of the matrix domain Dom::Matrix():

```
expA := matrix(expA):
```

Now, the overloaded arithmetical operators +, \*, ^ etc. can be used for further computations:

```
expA*X
```

$$\begin{pmatrix} 2.718281828 \\ 32.6767782 \end{pmatrix}$$

```
delete A, expA, x1, x2, X:
```

## Example 2

We demonstrate the different precision goals of the methods. Note that software arithmetic is used when a method is specified:

```
A := array(1..3, 1..3, [[ 1000, 1, 0 ],
                        [ 0, 1, 1 ],
                        [1/10^100, 0, -1000]]):
```

The default method TaylorExpansion computes *each component* of  $e^A$  correctly:

```
numeric::expMatrix(A, SoftwareFloats)
```

$$\begin{pmatrix} 1.970071114 \cdot 10^{434} & 1.972043157 \cdot 10^{431} & 9.860215786 \cdot 10^{427} \\ 9.860215786 \cdot 10^{327} & 9.870085871 \cdot 10^{324} & 4.935042936 \cdot 10^{321} \\ 9.850355557 \cdot 10^{330} & 9.860215786 \cdot 10^{327} & 4.930107893 \cdot 10^{324} \end{pmatrix}$$

The method `Diagonalization` produces a result, which is accurate in the sense that

$\|error\|_F \leq \|e^A\|_F \frac{1}{\epsilon}$  holds. Indeed, the largest components of  $e^A$  are correct. However, `Diagonalization` does not even get the right order of magnitude of the smaller components:

```
numeric::expMatrix(A, Diagonalization)
```

$$\begin{pmatrix} 1.970071114 \cdot 10^{434} & 1.972043157 \cdot 10^{431} & 0 \\ 0 & 2.718281828 & 0 \\ 0 & 0 & 5.075958898 \cdot 10^{-435} \end{pmatrix}$$

Note that  $e^A$  is very sensitive to small changes in  $A$ . After elimination of the small lower triangular element, both methods yield the same result with correct digits for all entries:

```
B := array(1..3, 1..3, [[ 1000, 1, 0 ],
                        [ 0, 1, 1 ],
                        [ 0, 0, -1000]]):
numeric::expMatrix(B, SoftwareFloats)
```

$$\begin{pmatrix} 1.970071114 \cdot 10^{434} & 1.972043157 \cdot 10^{431} & 9.860215786 \cdot 10^{427} \\ 0 & 2.718281828 & 0.002715566262 \\ 0 & 0 & 5.075958897 \cdot 10^{-435} \end{pmatrix}$$

```
numeric::expMatrix(B, Diagonalization)
```



$$\begin{pmatrix} 1.970071114 \cdot 10^{434} & 1.972043157 \cdot 10^{431} & 9.860215786 \cdot 10^{427} \\ 0 & 2.718281828 & 0.002715566262 \\ 0 & 0 & 5.075958898 \cdot 10^{-435} \end{pmatrix}$$

delete A, B:

### Example 3

Hilbert matrices  $H_{ij} = \frac{1}{i+j-1}$  have real positive eigenvalues. For large dimension, most of these eigenvalues are small and may be regarded as a single cluster. Consequently, the option Krylov is useful:

```
numeric::expMatrix(linalg::hilbert(100), [1 $ 100], Krylov)
```

```
[25.47080919, 18.59337041, ..., 2.863083064, 2.848538965]
```

## Parameters

### A

A square  $n \times n$  matrix of domain type (Symbolic Math Toolbox) DOM\_ARRAY, DOM\_HFARRAY, or of category Cat::Matrix

### x

A vector represented by a list on page 7-41  $[x_1, \dots, x_n]$  or a 1-dimensional array on page 7-2 `array(1..n, [x1, ..., xn])`, or a 1-dimensional hfarray on page 7-27 `hfarray(1..n, [x1, ..., xn])`

### X

An  $n \times m$  matrix of domain type DOM\_ARRAY, DOM\_HFARRAY, Dom::Matrix(Ring) or Dom::DenseMatrix(Ring) with a suitable coefficient ring Ring

**mode**

One of the flags `Hard`, `HardwareFloats`, `Soft`, or `SoftwareFloats`

**method**

One of the flags `Diagonalization`, `Interpolation`, `Krylov`, or `TaylorExpansion`

## Options

### **Hard, HardwareFloats, Soft, SoftwareFloats**

With `Hard` (or `HardwareFloats`), computations are done using fast hardware float arithmetic from within a MuPAD session. `Hard` and `HardwareFloats` are equivalent. With this option, the input data are converted to hardware floats and processed by compiled C code. The result is reconverted to MuPAD floats and returned to the MuPAD session.

With `Soft` (or `SoftwareFloats`) computations are done using software float arithmetic provided by the MuPAD kernel. `Soft` and `SoftwareFloats` are equivalent. `SoftwareFloats` is used by default if the current value of `DIGITS` is larger than 15 and the input matrix `A` is not of domain type `DOM_HFARRAY`.

Compared to the `SoftwareFloats` used by the MuPAD kernel, the computation with `HardwareFloats` may be many times faster. Note, however, that the precision of hardware arithmetic is limited to about 15 digits. Further, the size of floating-point numbers may not be larger than approximately  $10^{308}$  and not smaller than approximately  $10^{-308}$ .

If no `HardwareFloats` or `SoftwareFloats` are requested explicitly, the following strategy is used: If the current value of `DIGITS` is smaller than 16 or if the matrix `A` is a hardware float array of domain type `DOM_HFARRAY`, then hardware arithmetic is tried. If this is successful, the result is returned.

If the result cannot be computed with hardware floats, software arithmetic by the MuPAD kernel is tried.

If the current value of `DIGITS` is larger than 15 and the input matrix `A` is not of domain type `DOM_HFARRAY`, or if one of the options `Soft`, `SoftwareFloats` or `Symbolic` is specified, MuPAD computes the result with its software arithmetic without trying to use hardware floats first.

There may be several reasons for hardware arithmetic to fail:

- The current value of DIGITS is larger than 15.
- The data contains symbolic objects.
- The data contains numbers larger than  $10^{308}$  or smaller than  $10^{-308}$  that cannot be represented by hardware floats.

If neither `HardwareFloats` nor `SoftwareFloats` is specified, the user is not informed whether hardware floats or software floats are used.

If `HardwareFloats` are specified but fail due to one of the reasons above, a warning is issued that the (much slower) software floating-point arithmetic of the MuPAD kernel is used.

Note that `HardwareFloats` can only be used if all input data can be converted to floating-point numbers.

The trailing digits in floating-point results computed with `HardwareFloats` and `SoftwareFloats` may differ.

### **Diagonalization, Interpolation, Krylov, TaylorExpansion**

The specification of a method implies `SoftwareFloats`, i.e., the result is always computed via the software arithmetic of the MuPAD kernel.

The method `TaylorExpansion` is the default algorithm. It produces fast results for matrices with small norms.

The default method `TaylorExpansion` computes *each individual component* of  $e^A$ ,  $e^A x$ ,  $e^A X$  to a relative precision of about  $10^{-(\text{DIGITS})}$ , unless numerical roundoff prevents reaching this precision goal. Roughly speaking: all digits of all components of the result are reliable up to roundoff effects.

---

**Note** The methods `Diagonalization`, `Interpolation`, and `Krylov` compute the

result to a relative precision w.r.t. the norm:  $\frac{\|\text{error}\|_\infty}{\|\text{result}\|_\infty} \leq \frac{1}{\text{DIGITS}}$ . Consequently, if the result has components of different orders of magnitude, then the smaller components have larger relative errors than the large components. Not all digits of the small components are reliable! Cf. "Example 2" on page 19-59 (Symbolic Math Toolbox).

---

---

**Note** The method `Diagonalization` only works for diagonalizable matrices. For matrices without a basis of eigenvectors, `numeric::expMatrix` may either produce an error or the returned result is dominated by roundoff effects. For symmetric/Hermitian or skew/skew-Hermitian matrices, this method produces reliable results.

---

---

**Note** The method `Interpolation` may become numerically unstable for certain matrices. The algorithm tries to detect such instabilities and stops with an error message.

---

The method `Krylov` is only available for computing  $e^A x$  with a vector  $x$ . Also vectors represented by  $n \times 1$  matrices are accepted.

This method is fast when  $x$  is spanned by few eigenvectors of  $A$ . Further, if  $A$  has only few clusters of similar eigenvalues, then this method can be much faster than the other methods. Cf. "Example 3" on page 19-61 (Symbolic Math Toolbox).

### **NoWarning**

Suppresses warnings

### **ReturnType**

Option, specified as `ReturnType = d`

Return the result matrix or vector as a matrix of domain type (Symbolic Math Toolbox)  $d$ . The following return types are available: `DOM_ARRAY`, `DOM_HFARRAY`, `Dom::Matrix()`, or `Dom::DenseMatrix()`.

## **Return Values**

All results are float matrices/vectors. For an  $n \times n$  matrix  $A$ :

- `numeric::expMatrix(A, method)` returns  $e^A$  as an  $n \times n$  matrix,
- `numeric::expMatrix(A, x, method)` returns  $e^A x$  as an  $n \times 1$  matrix,
- `numeric::expMatrix(A, X, method)` returns  $e^A X$  as an  $n \times m$  matrix.

The domain type of the result depends on the domain type of the input matrix  $A$  unless a return type is requested explicitly via `ReturnType = d`.

## References

Y. Saad, "Analysis of some Krylov Subspace Approximations to the Matrix Exponential Operator", SIAM Journal of Numerical Analysis 29 (1992).

## Algorithms

The method `TaylorExpansion` sums the usual Taylor series

$$e^A = 1 + A + \frac{A^2}{2} + \dots$$

in a suitable numerically stable way.

The method `Diagonalization` computes  $e^A = T \operatorname{diag}(e^{\lambda_1}, e^{\lambda_2}, \dots) T^{-1}$  by a diagonalization  $A = T \operatorname{diag}(\lambda_1, \lambda_2, \dots) T^{-1}$ .

The method `Interpolation` computes a polynomial  $P$  interpolating the function  $\exp$  at the eigenvalues of  $A$ . Evaluation of the matrix polynomial yields  $e^A = P(A)$ .

The method `Krylov` reduces  $A$  to a Hessenberg matrix  $H$  and computes an approximation of  $e^A x$  from  $e^H$ . Depending on  $A$  and  $x$ , the dimension of  $H$  may be smaller than the dimension of  $A$ .

`numeric::expMatrix` uses polynomial arithmetic to multiply matrices and vectors. Thus, sparse matrices are handled efficiently based on the MuPAD internal sparse representation of polynomials.

## See Also

### MuPAD Functions

`exp` | `funm` | `linalg::sqrtMatrix` | `numeric::fMatrix`

## numeric::factorCholesky

Cholesky factorization of a matrix

### Syntax

`numeric::factorCholesky(A, options)`

### Description

`numeric::factorCholesky(A)` returns the factor  $L$  of the Cholesky factorization  $A = L L^H$  of a positive definite Hermitian matrix  $A$ .

`numeric::factorCholesky(A, Symmetric)` returns the factor  $L$  of a Cholesky type factorization  $A = L L^T$  of a symmetric matrix  $A$ .

The Cholesky factorization of a square Hermitian matrix is  $A = L L^H$ , where  $L$  is a regular complex lower triangular matrix and  $L^H$  is the Hermitian transpose of  $L$  (i.e., the complex conjugate of the transpose of  $L$ ). Such a factorization only exists if  $A$  is positive definite.

By default, a numerical factorization is computed. If the option `Symbolic` is not used, all components of the matrix are converted to floating-point numbers. In this case, the matrix must not contain symbolic objects that cannot be converted to floats. Numerical symbolic expressions such as  $\pi$ ,  $\sqrt{2}$ ,  $e^{-1}$  etc. are accepted.

If no return type is specified via the option `ReturnType = d`, the domain type of the Cholesky factor  $L$  depends on the type of the input matrix  $A$ :

- The factor of an array on page 7-2 is returned as an array on page 7-2.
- The factor of an hffarray on page 7-27 is returned as an hffarray on page 7-27.
- The factor of a dense matrix of type `Dom::DenseMatrix()` is a dense matrix of type `Dom::DenseMatrix()` over the ring of MuPAD expressions.
- For all other matrices of category `Cat::Matrix`, the factor  $L$  is returned as a matrix of type `Dom::Matrix()` over the ring of MuPAD expressions. This includes input matrices  $A$  of type `Dom::Matrix(...)`, `Dom::SquareMatrix(...)`, `Dom::MatrixGroup(...)` etc.

The Cholesky factor returned by `numeric::factorCholesky` is normalized such that its diagonal elements are real and positive.

## Environment Interactions

Without the option `Symbolic`, the function is sensitive to the environment variable `DIGITS`, which determines the numerical working precision.

## Examples

### Example 1

We consider the matrix

```
A := array(1..2, 1..2, [[1, I] , [-I, PI]]):
```

We compute a numerical factorization

```
numeric::factorCholesky(A)
```

$$\begin{pmatrix} 1.0 & 0 \\ -1.0i & 1.46341814 \end{pmatrix}$$

and a symbolic factorization:

```
L := numeric::factorCholesky(A, Symbolic)
```

$$\begin{pmatrix} 1 & 0 \\ -i & \sqrt{\pi-1} \end{pmatrix}$$

For further processing, the Cholesky factor (of domain type `DOM_ARRAY`) is converted to an element of the matrix domain `Dom::Matrix()`:

```
L := matrix(L):
```

Now, the overloaded arithmetical operators `+`, `*`, `^` etc. can be used for further computations:

```
L*linalg::transpose(conjugate(L))
```

$$\begin{pmatrix} 1 & i \\ -i & \pi \end{pmatrix}$$

```
delete A, L:
```

## Example 2

The following matrix is not positive definite:

```
A := matrix([-2, sqrt(2)], [sqrt(2), 1]):  
numeric::factorCholesky(A)
```

```
Error: Matrix not positive definite within working precision. [stdlib::hfa::factorCh]  
Evaluating: numeric::factorCholesky
```

However, a symmetric factorization with a complex Cholesky factor does exist:

```
numeric::factorCholesky(A, Symmetric)
```

$$\begin{pmatrix} 1.414213562 i & 0 \\ -1.0 i & 1.414213562 \end{pmatrix}$$

```
delete A:
```

## Example 3

The option NoCheck should be used when the matrix contains symbolic objects:

```
assume(x > 0): assume(z > 0):  
A := array(1..2, 1..2, [[x, conjugate(y)], [y, z]]):  
numeric::factorCholesky(A, Symbolic, NoCheck)
```

$$\begin{pmatrix} \sqrt{x} & 0 \\ \frac{y}{\sqrt{x}} & \sqrt{z - \frac{|y|^2}{x}} \end{pmatrix}$$



Note that with `NoCheck`, it is assumed that the matrix is Hermitian and positive definite! All upper triangular entries are ignored. The following result implicitly assumes  $u = \text{conjugate}(y)$ :

```
A := array(1..2, 1..2, [[x, u], [y, z]]):
numeric::factorCholesky(A, Symbolic, NoCheck)
```

$$\begin{pmatrix} \sqrt{x} & 0 \\ \frac{y}{\sqrt{x}} & \sqrt{z - \frac{|y|^2}{x}} \end{pmatrix}$$

```
delete A:
```

## Example 4

We demonstrate the use of hardware floats. Hilbert matrices on page 15-93 are notoriously ill-conditioned and difficult to factor with low values of `DIGITS`. The following results, both with `HardwareFloats` as well as with `SoftwareFloats`, are marred by numerical roundoff. Consequently, the factorization with and without hardware floats, respectively, differ significantly:

```
A := linalg::hilbert(13):
L1 := numeric::factorCholesky(A, HardwareFloats):
L2 := numeric::factorCholesky(A, SoftwareFloats):
L1[13, 13] <> L2[13, 13]
```

```
0.0000001052365221 ≠ 0.00000007585706698
```

All Hilbert matrices are positive definite. However, in the following call, numerical roundoff makes the hardware floating-point tool think that the matrix is not definite:

```
numeric::factorCholesky(linalg::hilbert(14), HardwareFloats):
```

```
Error: Matrix not positive definite within working precision. [stdlib::hfa::factorCh]
Evaluating: numeric::factorCholesky
```

A factorization is computed successfully with `SoftwareFloats`:

```
L := numeric::factorCholesky(linalg::hilbert(14), SoftwareFloats):  
norm(linalg::hilbert(14) - L*linalg::transpose(L))
```

```
1.084202172 10-18
```

```
delete A, L1, L2, L:
```

## Parameters

### A

A square matrix of domain type (Symbolic Math Toolbox) `DOM_ARRAY`, `DOM_HFARRAY`, or of category `Cat::Matrix`

## Options

### Hard, HardwareFloats, Soft, SoftwareFloats

With `Hard` (or `HardwareFloats`), computations are done using fast hardware float arithmetic from within a MuPAD session. `Hard` and `HardwareFloats` are equivalent. With this option, the input data are converted to hardware floats and processed by compiled C code. The result is reconverted to MuPAD floats and returned to the MuPAD session.

With `Soft` (or `SoftwareFloats`) computations are done using software float arithmetic provided by the MuPAD kernel. `Soft` and `SoftwareFloats` are equivalent. `SoftwareFloats` is used by default if the current value of `DIGITS` is larger than 15 and the input matrix `A` is not of domain type `DOM_HFARRAY`.

Compared to the `SoftwareFloats` used by the MuPAD kernel, the computation with `HardwareFloats` may be many times faster. Note, however, that the precision of hardware arithmetic is limited to about 15 digits. Further, the size of floating-point numbers may not be larger than approximately  $10^{308}$  and not smaller than approximately  $10^{-308}$ .

If no `HardwareFloats` or `SoftwareFloats` are requested explicitly, the following strategy is used: If the current value of `DIGITS` is smaller than 16 or if the matrix `A` is a

hardware float array of domain type `DOM_HFARRAY`, then hardware arithmetic is tried. If this is successful, the result is returned.

If the result cannot be computed with hardware floats, software arithmetic by the MuPAD kernel is tried.

If the current value of `DIGITS` is larger than 15 and the input matrix `A` is not of domain type `DOM_HFARRAY`, or if one of the options `Soft`, `SoftwareFloats` or `Symbolic` is specified, MuPAD computes the result with its software arithmetic without trying to use hardware floats first.

There may be several reasons for hardware arithmetic to fail:

- The current value of `DIGITS` is larger than 15.
- The data contains symbolic objects.
- The data contains numbers larger than  $10^{308}$  or smaller than  $10^{-308}$  that cannot be represented by hardware floats.

If neither `HardwareFloats` nor `SoftwareFloats` is specified, the user is not informed whether hardware floats or software floats are used.

If `HardwareFloats` are specified but fail due to one of the reasons above, a warning is issued that the (much slower) software floating-point arithmetic of the MuPAD kernel is used.

Note that `HardwareFloats` can only be used if all input data can be converted to floating-point numbers.

The trailing digits in floating-point results computed with `HardwareFloats` and `SoftwareFloats` may differ.

---

**Note** For ill conditioned matrices the results returned with `HardwareFloats` and `SoftwareFloats` may differ significantly! See “Example 4” on page 19-69 (Symbolic Math Toolbox).

---

## Symbolic

Prevents the conversion of the input data to floating-point numbers. Exact arithmetic is used. This option overrides `HardwareFloats` and `SoftwareFloats`.

The usual arithmetic for MuPAD expressions is used. With this option, the matrix  $A$  may contain symbolic objects. Note that the option `NoCheck` must be used for the Hermitian factorization when non-numerical symbolic objects are present.

### **Symmetric**

Makes `numeric::factorCholesky` compute a symmetric factorization  $A = LL^T$  rather than a Hermitian factorization  $A = LL^H$

The symmetric Cholesky factorization of a square symmetric matrix is  $A = LL^T$ , where  $L$  is a regular complex lower triangular matrix and  $L^T$  is the transpose of  $L$ . The matrix  $A$  does not have to be positive definite. Consequently, with the option `Symmetric` no internal check is performed whether  $A$  is positive definite. Note that the symmetric factorization with regular  $L$  does not exist for all matrices.

For real symmetric positive definite matrices  $A$  the Cholesky factor  $L$  is real and the Hermitian factorization  $A = LL^H$  coincides with the symmetric factorization  $A = LL^T$ .

### **NoCheck**

Prevents `numeric::factorCholesky` from checking that the matrix is Hermitian and positive definite

Without the option `Symmetric`, `numeric::factorCholesky` checks that the matrix  $A$  is Hermitian and positive definite. The option `NoCheck` may be used to suppress these checks. It must be used when the matrix contains symbolic objects. Elements in the upper triangular part of the matrix will never be touched by the algorithm!

---

**Note** With this option, `numeric::factorCholesky` returns a result for matrices that are not Hermitian or not positive definite (i.e., no Cholesky factorization exists)! When using this option, it is the user's responsibility to make sure that the input matrix is appropriate.

---

This option has no effect when the option `Symmetric` is used.

### **NoWarning**

Suppresses warnings

If symbolic coefficients are found, `numeric::factorCholesky` automatically switches to the `Symbolic` mode with a warning. With this option, this warning is suppressed; the

routine still uses the symbolic mode for symbolic coefficients, i.e., exact arithmetic without floating-point conversions is used.

### **ReturnType**

Option, specified as `ReturnType = d`

Return the Cholesky factor as a matrix of domain type (Symbolic Math Toolbox) `d`. The following return types are available: `DOM_ARRAY`, `DOM_HFARRAY`, `Dom::Matrix()`, or `Dom::DenseMatrix()`.

## **Return Values**

Depending on the type of the input matrix  $A$ , the lower triangular Cholesky factor  $L$  is returned as a matrix of domain type `DOM_ARRAY`, `DOM_HFARRAY`, `Dom::Matrix()`, or `Dom::DenseMatrix()`. Its components are real or complex floats, unless the option `Symbolic` is used. Without the option `NoCheck`, an error is raised if the matrix is not Hermitian or not positive definite.

## **See Also**

### **MuPAD Functions**

`linalg::factorCholesky` | `numeric::factorLU` | `numeric::factorQR`

### **Topics**

“Compute Factorizations Numerically” (Symbolic Math Toolbox)

## numeric::factorLU

LU factorization of a matrix

### Syntax

```
numeric::factorLU(A, options)
```

### Description

`numeric::factorLU(A)` returns a  $LU$  factorization of the matrix  $A$ .

The  $LU$  factorization of a real or complex  $m \times n$  matrix  $A$  is  $PA = LU$ . The  $m \times m$  matrix  $L$  is lower triangular, normalized to 1 along the diagonal. The  $m \times n$  matrix  $U$  is upper triangular, i.e.,  $U_{ij} = 0$  for  $j < i$ . The list  $\mathbf{p} = [p_1, \dots, p_m]$  returned by `numeric::factorLU` is a permutation of the numbers  $1, \dots, m$  corresponding to row exchanges of  $A$ . It represents the following  $m \times m$  permutation matrix  $P$  (we assume that the matrix indices range from 1 to  $m$ ):

$$P_{ij} = \delta_{p_i j} = \begin{cases} 1 & \text{if } j = p_i \\ 0 & \text{if } j \neq p_i \end{cases}.$$

Left multiplication of matrices and vectors with  $P$  is realized easily using the permutation list  $\mathbf{p}$ :  $Y_{i,j} := X_{p_i,j}$  defines the row permutation  $Y = PX$  of a matrix  $X$ ,  $y_i := x_{p_i}$  defines the row permutation  $\mathbf{y} = P\mathbf{x}$  of a vector  $\mathbf{x}$ .

By default, a numerical factorization with partial pivoting is computed. If the option `Symbolic` is not used, all components of the matrix are converted to floating-point numbers. In this case, the matrix must not contain symbolic objects that cannot be converted to floats. Numerical symbolic expressions such as  $\pi$ ,  $\sqrt{2}$ ,  $\mathbf{e}^{-1}$  etc. are accepted.

The factorization depends on the pivoting strategy. The results obtained with/without the option `Symbolic` may differ. See “Example 2” on page 19-76 (Symbolic Math Toolbox). For numerical factorizations, the results obtained with `HardwareFloats` and

SoftwareFloats, respectively, may differ. See “Example 3” on page 19-77 (Symbolic Math Toolbox).

If no return type is specified via the option `ReturnType = d`, the domain type of the factors  $L$  and  $U$  depends on the type of the input matrix  $A$ :

- The factors of an array on page 7-2 are returned as arrays on page 7-2.
- The factors of an hfarray on page 7-27 are returned as hfarray on page 7-27s.
- The factors of a dense matrix of type `Dom::DenseMatrix()` are again dense matrices of type `Dom::DenseMatrix()` over the ring of MuPAD expressions.
- For all other matrices of category `Cat::Matrix`, the factors are returned as matrices on page 1-1340 of type `Dom::Matrix()` over the ring of MuPAD expressions. This includes input matrices  $A$  of type `Dom::Matrix(...)`, `Dom::SquareMatrix(...)`, `Dom::MatrixGroup(...)` etc.

## Environment Interactions

Without the optional argument `Symbolic`, the function is sensitive to the environment variable `DIGITS`, which determines the numerical working precision.

## Examples

### Example 1

We factor a matrix specified by an array on page 7-2:

```
A := array(1..3, 1..3, [[1, 2, 3], [2, 4, 6], [4, 8, 9]]):
[L, U, p] := numeric::factorLU(A)
```

$$\left[ \left( \begin{array}{ccc} 1.0 & 0 & 0 \\ 0.5 & 1.0 & 0 \\ 0.25 & 0 & 1.0 \end{array} \right), \left( \begin{array}{ccc} 4.0 & 8.0 & 9.0 \\ 0 & 0 & 1.5 \\ 0 & 0 & 0.75 \end{array} \right), [3, 2, 1] \right]$$

The factors (of domain type `DOM_ARRAY`) are converted to elements of the matrix domain `Dom::Matrix()`. After the conversion, the overloaded arithmetical operators `+`, `*`, `^` etc. can be used for further processing:

```
L := matrix(L): U := matrix(U):  
L*U
```

$$\begin{pmatrix} 4.0 & 8.0 & 9.0 \\ 2.0 & 4.0 & 6.0 \\ 1.0 & 2.0 & 3.0 \end{pmatrix}$$

The product  $LU$  coincides with  $A$  after exchanging the rows according to the permutation stored in the list  $p$ :

```
PA := array(1..3, 1..3, [[A[p[i], j] $ j=1..3] $ i=1..3])
```

$$\begin{pmatrix} 4 & 8 & 9 \\ 2 & 4 & 6 \\ 1 & 2 & 3 \end{pmatrix}$$

```
delete A, L, U, p, PA:
```

## Example 2

We consider a non-square matrix of dimension  $3 \times 2$ :

```
A := matrix([[3*I, 10], [I, 1], [I, 1]]):  
[L1, U1, p1] := numeric::factorLU(A)
```

$$\left[ \begin{pmatrix} 1.0 & 0 & 0 \\ 3.0 & 1.0 & 0 \\ 1.0 & 0 & 1.0 \end{pmatrix}, \begin{pmatrix} 1.0 & 1.0 \\ 0 & 7.0 \\ 0 & 0 \end{pmatrix}, [2, 1, 3] \right]$$

Note that the symbolic factorization is different, because a different pivoting strategy is used:

```
[L2, U2, p2] := numeric::factorLU(A, Symbolic)
```

$$\left[ \begin{pmatrix} 1 & 0 & 0 \\ \frac{1}{3} & 1 & 0 \\ \frac{1}{3} & 1 & 1 \end{pmatrix}, \begin{pmatrix} 3 & 10 \\ 0 & -\frac{7}{3} \\ 0 & 0 \end{pmatrix}, [1, 2, 3] \right]$$



Here, the matrix factors are of type `Dom::Matrix()`, because the input matrix  $A$  was of this type. We can use the overloaded arithmetic directly. We convert the permutation lists  $p1$ ,  $p2$  to matrices on page 7-252 and verify the relation  $PA = LU$  for the factorization:

```
P1 := matrix(3, 3):
P2 := matrix(3, 3):
for i from 1 to 3 do
  P1[i, p1[i]] := 1;
  P2[i, p2[i]] := 1;
end_for:
P1*A - L1*U1, P2*A - L2*U2
```

$$\begin{pmatrix} 0 & 0 \\ 0 & 0 \\ 0 & 0 \end{pmatrix}, \begin{pmatrix} 0 & 0 \\ 0 & 0 \\ 0 & 0 \end{pmatrix}$$

```
delete A, L1, U1, p1, L2, U2, p2:
```

### Example 3

We demonstrate the use of hardware floats. The internal rounding of `HardwareFloats` and `SoftwareFloats` differs. Consequently, the following results do not coincide:

```
n := 14:
A := linalg::hilbert(n):
[L1, U1, p1] := numeric::factorLU(A, HardwareFloats):
[L2, U2, p2] := numeric::factorLU(A, SoftwareFloats):
p1, p2
```

```
[1, 2, 3, 4, 5, 6, 7, 8, 9, 10, 11, 12, 14, 13], [1, 2, 3, 4, 5, 6, 7, 8, 9, 10, 11, 12, 13, 14]
```

However, both factorizations satisfy  $PA = LU$  numerically:

```
P1A := matrix([[A[p1[i], j] $ j = 1..n] $ i = 1..n]):
P2A := matrix([[A[p2[i], j] $ j = 1..n] $ i = 1..n]):
norm(P1A - L1*U1), norm(P2A - L2*U2)
```

$$8.077306185 \cdot 10^{-17}, 4.33680869 \cdot 10^{-19}$$

```
delete n, A, L1, U1, p1, L2, U2, p2, P1A, P2A:
```

## Parameters

### A

An  $m \times n$  matrix of domain type (Symbolic Math Toolbox) `DOM_ARRAY`, `DOM_HFARRAY`, or of category `Cat::Matrix`

## Options

### Hard, HardwareFloats, Soft, SoftwareFloats

With `Hard` (or `HardwareFloats`), computations are done using fast hardware float arithmetic from within a MuPAD session. `Hard` and `HardwareFloats` are equivalent. With this option, the input data are converted to hardware floats and processed by compiled C code. The result is reconverted to MuPAD floats and returned to the MuPAD session.

With `Soft` (or `SoftwareFloats`) computations are done using software float arithmetic provided by the MuPAD kernel. `Soft` and `SoftwareFloats` are equivalent. `SoftwareFloats` is used by default if the current value of `DIGITS` is larger than 15 and the input matrix `A` is not of domain type `DOM_HFARRAY`.

Compared to the `SoftwareFloats` used by the MuPAD kernel, the computation with `HardwareFloats` may be many times faster. Note, however, that the precision of hardware arithmetic is limited to about 15 digits. Further, the size of floating-point numbers may not be larger than approximately  $10^{308}$  and not smaller than approximately  $10^{-308}$ .

If no `HardwareFloats` or `SoftwareFloats` are requested explicitly, the following strategy is used: If the current value of `DIGITS` is smaller than 16 or if the matrix `A` is a hardware float array of domain type `DOM_HFARRAY`, then hardware arithmetic is tried. If this is successful, the result is returned.

If the result cannot be computed with hardware floats, software arithmetic by the MuPAD kernel is tried.

If the current value of `DIGITS` is larger than 15 and the input matrix `A` is not of domain type `DOM_HFARRAY`, or if one of the options `Soft`, `SoftwareFloats` or `Symbolic` is specified, MuPAD computes the result with its software arithmetic without trying to use hardware floats first.

There may be several reasons for hardware arithmetic to fail:

- The current value of DIGITS is larger than 15.
- The data contains symbolic objects.
- The data contains numbers larger than  $10^{308}$  or smaller than  $10^{-308}$  that cannot be represented by hardware floats.

If neither `HardwareFloats` nor `SoftwareFloats` is specified, the user is not informed whether hardware floats or software floats are used.

If `HardwareFloats` are specified but fail due to one of the reasons above, a warning is issued that the (much slower) software floating-point arithmetic of the MuPAD kernel is used.

Note that `HardwareFloats` can only be used if all input data can be converted to floating-point numbers.

The trailing digits in floating-point results computed with `HardwareFloats` and `SoftwareFloats` may differ.

---

**Note** For ill conditioned matrices the results returned with `HardwareFloats` and `SoftwareFloats` may differ significantly! See “Example 3” on page 19-77 (Symbolic Math Toolbox).

---

### **Symbolic**

Prevents the conversion of the input data to floating-point numbers. Exact arithmetic is used. This option overrides `HardwareFloats` and `SoftwareFloats`.

The usual arithmetic for MuPAD expressions is used. With this option, the matrix *A* may contain symbolic objects.

With this option, no row exchanges are performed in the internal Gaussian elimination unless necessary.

### **NoWarning**

Suppresses warnings

If symbolic coefficients are found, `numeric::factorLU` automatically switches to the `Symbolic` mode with a warning. With this option, this warning is suppressed; the routine

still uses the symbolic mode for symbolic coefficients, i.e., exact arithmetic without floating-point conversions is used.

### **ReturnType**

Option, specified as `ReturnType = d`

Return the factors as matrices of domain type (Symbolic Math Toolbox) `d`. The following return types are available: `DOM_ARRAY`, `DOM_HFARRAY`, `Dom::Matrix()`, or `Dom::DenseMatrix()`.

## **Return Values**

List `[L, U, p]` is returned. The domain type of the  $m \times m$  matrix `L` and the  $m \times n$  matrix `U` depends on the type of the input matrix `A`; `p` is a list with  $m$  elements consisting of a permutation of the integers  $1, \dots, m$ . It represents row exchanges in pivoting steps. The components of `L` and `U` are real or complex floats, unless the option `Symbolic` is used.

## **See Also**

### **MuPAD Functions**

`linalg::factorLU` | `numeric::factorCholesky` | `numeric::factorQR`

### **Topics**

“Compute Factorizations Numerically” (Symbolic Math Toolbox)

# numeric::factorQR

QR factorization of a matrix

## Syntax

```
numeric::factorQR(A, options)
```

## Description

`numeric::factorQR(A)` returns a  $QR$  factorization  $A = QR$  of the matrix  $A$ .

The  $QR$  factorization of a real/complex  $m \times n$  matrix is  $A = QR$ , where the  $m \times m$  matrix  $Q$  is orthogonal/unitary and the  $m \times n$  matrix  $R$  is upper triangular (i.e.,  $R_{ij} = 0$  for  $j < i$ ).

By default, a numerical factorization is computed. The matrix must not contain symbolic objects that cannot be converted to floats. Numerical symbolic expressions such as  $\pi$ ,  $\sqrt{2}$ ,  $e^{-1}$  etc. are accepted. They will be converted to floats, unless the option `Symbolic` is used.

The  $R$  factor is normalized such that its diagonal elements  $R_{ii}$  with  $i = 1, \dots, \min(m, n)$  are real and nonnegative.

If no return type is specified via the option `ReturnType = d`, the domain type of the factors  $Q$  and  $R$  depends on the type of the input matrix  $A$ :

- The factors of an array on page 7-2 are returned as arrays on page 7-2.
- The factors of an hfarray on page 7-27 are returned as hfarray on page 7-27s.
- The factors of a dense matrix of type `Dom::DenseMatrix()` are dense matrices of type `Dom::DenseMatrix()` over the ring of expressions.
- For all other matrices of category `Cat::Matrix`, the factors are returned as matrices on page 1-1340 of type `Dom::Matrix()` over the ring of MuPAD expressions. This includes input matrices  $A$  of type `Dom::Matrix(...)`, `Dom::SquareMatrix(...)`, `Dom::MatrixGroup(...)`, etc.

## Environment Interactions

Without the option `Symbolic`, the function is sensitive to the environment variable `DIGITS`, which determines the numerical working precision.

## Examples

### Example 1

We consider a quadratic matrix:

```
A := array(1..2, 1..2, [[1, 0] , [1, PI]]):
```

First, we compute a numerical factorization:

```
[Q1, R1] := numeric::factorQR(A)
```

$$\left[ \begin{pmatrix} 0.7071067812 & -0.7071067812 \\ 0.7071067812 & 0.7071067812 \end{pmatrix}, \begin{pmatrix} 1.414213562 & 2.221441469 \\ 0 & 2.221441469 \end{pmatrix} \right]$$

Next, the symbolic factorization is computed:

```
[Q2, R2] := numeric::factorQR(A, Symbolic)
```

$$\left[ \begin{pmatrix} \frac{\sqrt{2}}{2} & -\frac{\sqrt{2}}{2} \\ \frac{\sqrt{2}}{2} & \frac{\sqrt{2}}{2} \end{pmatrix}, \begin{pmatrix} \sqrt{2} & \frac{\pi\sqrt{2}}{2} \\ 0 & \frac{\pi\sqrt{2}}{2} \end{pmatrix} \right]$$

For further processing, the factors (of domain type `DOM_ARRAY`) are converted to elements of the matrix domain `Dom::Matrix()`:

```
Q1 := matrix(Q1): R1 := matrix(R1):  
Q2 := matrix(Q2): R2 := matrix(R2):
```

Now, the overloaded arithmetical operators `+`, `*`, `^` etc. can be used for further computations:

```
Q1*R1, Q2*R2
```

$$\begin{pmatrix} 1.0 & -4.926614672 \cdot 10^{-16} \\ 1.0 & 3.141592654 \end{pmatrix}, \begin{pmatrix} 1 & 0 \\ 1 & \pi \end{pmatrix}$$

We finally verify the orthogonality of the factors Q1 and Q2:

```
Q1 * linalg::transpose(Q1), Q2 * linalg::transpose(Q2)
```

$$\begin{pmatrix} 1.0 & -1.569924746 \cdot 10^{-16} \\ -1.569924746 \cdot 10^{-16} & 1.0 \end{pmatrix}, \begin{pmatrix} 1 & 0 \\ 0 & 1 \end{pmatrix}$$

```
delete A, Q1, R1, Q2, R2;
```

## Example 2

We consider a non-square matrix of rank 1:

```
A := array(1..3, 1..2, [[0, 0], [I, 1], [I, 1]]):
numeric::factorQR(A, Symbolic)
```

$$\left[ \begin{pmatrix} 0 & 1 & 0 \\ \frac{\sqrt{2}i}{2} & 0 & \frac{\sqrt{2}}{2} \\ \frac{\sqrt{2}i}{2} & 0 & -\frac{\sqrt{2}}{2} \end{pmatrix}, \begin{pmatrix} \sqrt{2} & -\sqrt{2}i \\ 0 & 0 \\ 0 & 0 \end{pmatrix} \right]$$

In this case, the *QR* factorization is not unique. Note that the numerical factorization yields different factors:

```
numeric::factorQR(A)
```

$$\left[ \begin{pmatrix} 0 & 0.7071067812i & 0.7071067812i \\ 0.7071067812i & 0.5 & -0.5 \\ 0.7071067812i & -0.5 & 0.5 \end{pmatrix}, \begin{pmatrix} 1.414213562 & -1.414213562i \\ 0 & 0 \\ 0 & 0 \end{pmatrix} \right]$$

```
delete A:
```

### Example 3

We demonstrate the difference between hardware floats and software floats. For rank deficient matrices, the QR factorization is not unique. Depending on the options, different results are returned for the following matrix of rank 1:

```
A := matrix([[1, 1], [10^4, 10^4], [10^8, 10^8]]):  
[Q1, R1] := float(numeric::factorQR(A, Symbolic))
```

$$\left[ \begin{array}{ccc} 0.00000000999999995 & 1.0 & 0 \\ 0.0000999999995 & -9.9999999 \cdot 10^{-13} & 0.999999995 \\ 0.999999995 & -0.00000000999999999 & -0.0000999999995 \end{array} \right],$$
$$\left( \begin{array}{cc} 100000000.5 & 100000000.5 \\ 0 & 0 \\ 0 & 0 \end{array} \right)$$

```
[Q2, R2] := numeric::factorQR(A, SoftwareFloats)
```

$$\left[ \begin{array}{ccc} 0.00000000999999995 & -0.0000999999995 & -0.999999995 \\ 0.0000999999995 & 0.99999999 & -0.0000999999998 \\ 0.999999995 & -0.0000999999998 & 0.00000001999999975 \end{array} \right],$$
$$\left( \begin{array}{cc} 100000000.5 & 100000000.5 \\ 0 & 0 \\ 0 & 0 \end{array} \right)$$

```
[Q3, R3] := numeric::factorQR(A, HardwareFloats)
```



$$\left[ \begin{array}{ccc} \left( \begin{array}{ccc} 0.000000009999999939 & 0.9999999998 & -0.00002207031223 \\ 0.00009999999995 & -0.00002207031311 & -0.9999999948 \\ 0.9999999995 & -0.000000007792968604 & 0.0000999999997 \end{array} \right), \\ \left( \begin{array}{cc} 100000000.5 & 100000000.5 \\ 0 & 0.0000000149011613 \\ 0 & 0 \end{array} \right) \end{array} \right]$$

However, all factorizations satisfy  $A = QR$  numerically:

```
norm(A - Q1*R1), norm(A - Q2*R2), norm(A - Q3*R3)
```

```
3.469446952 10-18, 7.327374818 10-11, 0.00000001583248377
```

```
delete A, Q1, R1, Q2, R2, Q3, R3:
```

## Parameters

**A**

An  $m \times n$  matrix of domain type (Symbolic Math Toolbox) `DOM_ARRAY`, `DOM_HFARRAY`, or of category `Cat::Matrix`

## Options

### Hard, HardwareFloats, Soft, SoftwareFloats

With **Hard** (or **HardwareFloats**), computations are done using fast hardware float arithmetic from within a MuPAD session. **Hard** and **HardwareFloats** are equivalent. With this option, the input data are converted to hardware floats and processed by compiled C code. The result is reconverted to MuPAD floats and returned to the MuPAD session.

With **Soft** (or **SoftwareFloats**) computations are done using software float arithmetic provided by the MuPAD kernel. **Soft** and **SoftwareFloats** are equivalent.

`SoftwareFloats` is used by default if the current value of `DIGITS` is larger than 15 and the input matrix `A` is not of domain type `DOM_HFARRAY`.

Compared to the `SoftwareFloats` used by the MuPAD kernel, the computation with `HardwareFloats` may be many times faster. Note, however, that the precision of hardware arithmetic is limited to about 15 digits. Further, the size of floating-point numbers may not be larger than approximately  $10^{308}$  and not smaller than approximately  $10^{-308}$ .

If no `HardwareFloats` or `SoftwareFloats` are requested explicitly, the following strategy is used: If the current value of `DIGITS` is smaller than 16 or if the matrix `A` is a hardware float array of domain type `DOM_HFARRAY`, then hardware arithmetic is tried. If this is successful, the result is returned.

If the result cannot be computed with hardware floats, software arithmetic by the MuPAD kernel is tried.

If the current value of `DIGITS` is larger than 15 and the input matrix `A` is not of domain type `DOM_HFARRAY`, or if one of the options `Soft`, `SoftwareFloats` or `Symbolic` is specified, MuPAD computes the result with its software arithmetic without trying to use hardware floats first.

There may be several reasons for hardware arithmetic to fail:

- The current value of `DIGITS` is larger than 15.
- The data contains symbolic objects.
- The data contains numbers larger than  $10^{308}$  or smaller than  $10^{-308}$  that cannot be represented by hardware floats.

If neither `HardwareFloats` nor `SoftwareFloats` is specified, the user is not informed whether hardware floats or software floats are used.

If `HardwareFloats` are specified but fail due to one of the reasons above, a warning is issued that the (much slower) software floating-point arithmetic of the MuPAD kernel is used.

Note that `HardwareFloats` can only be used if all input data can be converted to floating-point numbers.

The trailing digits in floating-point results computed with `HardwareFloats` and `SoftwareFloats` may differ.

**Note** For ill conditioned matrices the results returned with `HardwareFloats` and `SoftwareFloats` may differ significantly! See “Example 3” on page 19-84 (Symbolic Math Toolbox).

---

### **Symbolic**

Prevents the conversion of the input data to floating-point numbers. Exact arithmetic is used. This option overrides `HardwareFloats` and `SoftwareFloats`.

The usual arithmetic for MuPAD expressions is used. With this option, the matrix  $A$  may contain symbolic objects.

### **NoWarning**

Suppresses warnings

If symbolic coefficients are found, `numeric::factorQR` automatically switches to the `Symbolic` mode with a warning. With this option, this warning is suppressed; the routine still uses the symbolic mode for symbolic coefficients, i.e., exact arithmetic without floating-point conversions is used.

### **ReturnType**

Option, specified as `ReturnType = d`

Return the Cholesky factor as a matrix of domain type (Symbolic Math Toolbox)  $d$ . The following return types are available: `DOM_ARRAY`, `DOM_HFARRAY`, `Dom::Matrix()`, or `Dom::DenseMatrix()`.

## **Return Values**

List  $[Q, R]$  with matrices  $Q$  and  $R$  is returned. The domain type of the orthogonal/unitary  $m \times m$  matrix  $Q$  and the upper triangular  $m \times n$  matrix  $R$  depends on the type of the input matrix  $A$ . The components of  $Q$  and  $R$  are real or complex floats, unless the option `Symbolic` is used.

## Algorithms

Householder transformations are used to compute the numerical factorization. With the option `Symbolic`, Gram-Schmidt orthonormalization of the columns of  $A$  is used.

For an invertible square matrix  $A$ , the  $QR$  factorization is unique up to scaling factors of modulus 1. The normalization of  $R$  to real positive diagonal elements determines the factorization uniquely. Consequently, the results obtained with/without the option `Symbolic` coincide for invertible square matrices.

For singular or non-square matrices, the factorization is not unique and the results obtained with/without the option `Symbolic` may differ. Cf. “Example 2” on page 19-83 (Symbolic Math Toolbox).

## See Also

### MuPAD Functions

`linalg::factorQR` | `numeric::factorCholesky` | `numeric::factorLU`

## Topics

“Compute Factorizations Numerically” (Symbolic Math Toolbox)

# numeric::fft

Fast Fourier Transform

## Syntax

`numeric::fft(L, <mode>, <ReturnType = t>, <Clean>)`

`numeric::fft(M, <mode>, <ReturnType = t>, <Clean>)`

`numeric::fft(A, <mode>, <ReturnType = t>, <Clean>)`

## Description

`numeric::fft(data)` returns the discrete Fourier transform of `data`.

The one-dimensional discrete Fourier transform  $F = \text{fft}(L)$  of  $N$  data elements  $L_j$  stored in the list  $L = [L_1, \dots, L_N]$  is the list  $F = [F_1, \dots, F_N]$  given by

$$F_k = \sum_{j=1}^N L_j e^{-\frac{i 2 \pi (j-1) (k-1)}{N}}, \quad k = 1, \dots, N$$

`fft` transforms the data by a Fast Fourier Transform (FFT) algorithm.

The  $d$ -dimensional discrete Fourier transform  $F = \text{fft}(A)$  of  $N = n_1 \times \dots \times n_d$  data elements  $(A_{j_1, \dots, j_d})$  stored in the array  $A$  is the array  $F = (F_{k_1, \dots, k_d})$  given by

$$F_{k_1, \dots, k_d} = \sum_{j_1=1}^{n_1} \dots \sum_{j_d=1}^{n_d} A_{j_1, \dots, j_d} e^{-i 2 \pi \left( \frac{(j_1-1) (k_1-1)}{n_1} + \dots + \frac{(j_d-1) (k_d-1)}{n_d} \right)}$$

with  $k_1 = 1, \dots, n_1, \dots, k_d = 1, \dots, n_d$ .

Data provided by a list, or one-dimensional array, or `hfarray` are transformed according to the one-dimensional transform. Data provided by matrices are transformed

according to the two-dimensional transform. Data provided by multidimensional arrays or `hfarrays` are transformed according to the multi-dimensional transform matching the format of the input array.

If the data size  $N$  factorizes as  $N = p q$ , the discrete Fourier transform can be computed by  $p$  different Fourier transforms of subsets of the data, each subset having the data size  $q$ . The corresponding 'divide and conquer' algorithm is known as FFT ('Fast Fourier Transform'). The `fft` routine employs the FFT algorithm. It is most efficient, when the data size  $N$  is an integer power of 2 ('radix 2 FFT'). In this case, the algorithm needs

$\mathcal{O}(N \log_2(N))$  elementary operations.

---

**Note** More generally, FFT is efficient, if the data size is the product of many small factors.

---

Following Bluestein, the Fourier transform is written as a convolution if the data size  $N$  is a prime. The data are zero-padded to a data length that is an integer power of 2. The convolution is then computed via radix 2 FFTs. Thus, the algorithm needs  $\mathcal{O}(N \log_2(N))$  elementary operations even if  $N$  is a prime.

## Environment Interactions

Without the option `Symbolic`, the function is sensitive to the environment variable `DIGITS`, which determines the numerical working precision.

## Examples

### Example 1

Compute one-dimensional transformations using lists. By default, numerical expressions are converted to floating-point values:

```
L := [1, 2^(1/2), 3*I, PI]:  
F := numeric::fft(L)
```

```
[5.555806216 + 3.0 i, 1.0 - 1.272620909 i, -3.555806216 + 3.0 i, 1.0 - 4.727379091 i]
```

To use exact arithmetic, specify the option `Symbolic`:

```
F := numeric::fft(L, Symbolic)
```

$$[\pi + \sqrt{2} + 1 + 3i, \pi i - \sqrt{2}i + 1 - 3i, 1 - \sqrt{2} - \pi + 3i, 1 + \sqrt{2}i - \pi i - 3i]$$

`numeric::fft` accepts symbolic expressions. Internally, the default method `HardwareFloats` (with `DIGITS < 16`) fails because of the symbolic parameter `x`. The following results are computed with the software arithmetic provided by the MuPAD kernel:

```
L := [x, 2, 3, x]:
numeric::fft(L)
```

$$[2x + 5.0, x(1.0 + 1.0i) - 3.0 - 2.0i, 1.0, x(1.0 - 1.0i) - 3.0 + 2.0i]$$

```
numeric::fft(L, Symbolic)
```

$$[2x + 5, x(1 + i) - 3 - 2i, 1, x(1 - i) - 3 + 2i]$$

```
delete L, F
```

## Example 2

Compute the following multidimensional transformations. First, compute a two-dimensional transformation using an array with two indices:

```
A := array(1..2, 1..4, [[1, 2, 3, 4], [a, b, c, d]]):
numeric::fft(A, Symbolic)
```

$$\begin{pmatrix} a + b + c + d + 10 & a - bi - c + di - 2 + 2i & a - b + c - d - 2 & a + bi - c - di - 2 - 2i \\ 10 - b - c - d - a & c + bi - a - di - 2 + 2i & b - a - c + d - 2 & c - bi - a + di - 2 - 2i \end{pmatrix}$$

Next, compute a transformation for a three-dimensional array:

```
A := array(1..2, 1..4, 1..2,
          [[sin(j1*PI/2)*cos(j2*3*PI/4)*sin(j3*PI/2)
           $ j3 = 1..2 ] $ j2 = 1..4 ] $ j1 = 1..2):
numeric::fft(A)
```

```
array(1..2, 1..4, 1..2,  
      (1, 1, 1) = -1.0  
  
      (1, 1, 2) = -1.0  
  
      (1, 2, 1) = - 1.414213562 - 1.0 I  
  
      (1, 2, 2) = - 1.414213562 - 1.0 I  
  
      (1, 3, 1) = 1.0  
  
      (1, 3, 2) = 1.0  
  
      (1, 4, 1) = - 1.414213562 + 1.0 I  
  
      (1, 4, 2) = - 1.414213562 + 1.0 I  
  
      (2, 1, 1) = -1.0  
  
      (2, 1, 2) = -1.0  
  
      (2, 2, 1) = - 1.414213562 - 1.0 I  
  
      (2, 2, 2) = - 1.414213562 - 1.0 I  
  
      (2, 3, 1) = 1.0  
  
      (2, 3, 2) = 1.0  
  
      (2, 4, 1) = - 1.414213562 + 1.0 I  
  
      (2, 4, 2) = - 1.414213562 + 1.0 I  
)
```

```
delete A
```

### Example 3

Data of arbitrary length can be transformed:

```
L := [1, 2 + I, PI/3]:  
numeric::fft(L)
```



[4.047197551 + 1.0 i, 0.3424266282 – 1.325151125 i, – 1.389624179 + 0.3251511255 i]

delete L

## Parameters

### L

A list on page 7-41, or a one-dimensional array on page 7-2(1 .. N, [Symbol::hellip]), or a one-dimensional hfarray on page 7-27(1 .. N, [Symbol::hellip]) of arithmetical expressions (Symbolic Math Toolbox).

### M

A matrix of category `Cat::Matrix` of arithmetical expressions (Symbolic Math Toolbox).

### A

A  $d$ -dimensional array( 1..n<sub>1</sub>,Symbol::hellip,1..n<sub>d</sub>, [Symbol::hellip] ) or a  $d$ -dimensional hfarray( 1..n<sub>1</sub>,Symbol::hellip,1..n<sub>d</sub>, [Symbol::hellip] ) of arithmetical expressions (Symbolic Math Toolbox).

### mode

One of the flags `Hard`, `HardwareFloats`, `Soft`, `SoftwareFloats`, or `Symbolic`

## Options

### Hard, HardwareFloats, Soft, SoftwareFloats

With `Hard` (or `HardwareFloats`), computations are done using fast hardware floating-point arithmetic from within a MuPAD session. `Hard` and `HardwareFloats` are equivalent. With this option, the input data are converted to hardware floating-point values and processed by compiled C code. The result is reconverted to MuPAD floating-point values and returned to the MuPAD session.

With `Soft` (or `SoftwareFloats`) computations are done using software floating-point arithmetic provided by the MuPAD kernel. `Soft` and `SoftwareFloats` are equivalent.

`SoftwareFloats` is used by default if the current value of `DIGITS` is larger than 15 and the input matrix `A` is not of domain type `DOM_HFARRAY`.

Compared to the `SoftwareFloats` used by the MuPAD kernel, the computation with `HardwareFloats` can be much faster. Note, however, that the precision of hardware arithmetic is limited to about 15 digits. Further, the size of floating-point numbers can not be larger than approximately  $10^{308}$  and not smaller than approximately  $10^{-308}$ .

If no `HardwareFloats` or `SoftwareFloats` are specified, the following strategy is used. If the current value of `DIGITS` is smaller than 16 or if the matrix `A` is a hardware floating-point array of domain type `DOM_HFARRAY`, then hardware arithmetic is tried. If this is successful, the result is returned.

If the result cannot be computed with hardware floating-point values, software arithmetic by the MuPAD kernel is tried.

If the current value of `DIGITS` is larger than 15 and the input matrix `A` is not of domain type `DOM_HFARRAY`, or if one of the options `Soft`, `SoftwareFloats` or `Symbolic` is specified, MuPAD computes the result with its software arithmetic without trying to use hardware arithmetic first.

There can be several reasons for hardware arithmetic to fail:

- The current value of `DIGITS` is larger than 15.
- The data contains symbolic objects.
- The data contains numbers larger than  $10^{308}$  or smaller than  $10^{-308}$  that cannot be represented by hardware floating-point values.

If neither `HardwareFloats` nor `SoftwareFloats` is specified, the function does not indicate whether hardware floating-point values or software floating-point values are used.

If `HardwareFloats` are specified but fail due to one of the reasons above, a warning is issued that the (much slower) software floating-point arithmetic of the MuPAD kernel is used.

Note that `HardwareFloats` can only be used if all input data can be converted to floating-point numbers.

With `Soft` and `SoftwareFloats`, symbolic objects are accepted even if they cannot be converted to floating-point numbers. The result consists of arithmetical expressions

involving both floating-point numbers as well as symbolic objects. See “Example 1” on page 19-90 (Symbolic Math Toolbox).

The trailing digits in floating-point results computed with `HardwareFloats` and `SoftwareFloats` can differ.

### **Symbolic**

This option prevents conversion of the input data to floating-point values.

Without this option, the floating-point converter `float` is applied to all input data. Use this option if no such conversion is desired. Exact arithmetic is used to compute the Fourier transformation.

### **ReturnType**

Option, specified as `ReturnType = t`

Return the result in a container of domain type (Symbolic Math Toolbox) `t`. The following return types `t` are available: `DOM_LIST`, or `DOM_ARRAY`, or `DOM_HFARRAY`, or `matrix`, or `densematrix`.

This option determines the domain type (Symbolic Math Toolbox) `t` of the result.

If no return type is specified by this option, the result is of the same type and format as the input data.

If the return type `DOM_LIST` is specified, the result is always a plain list of floating-point numbers. If the input data are given by a matrix or a multidimensional array, the returned list represents the operands of the multidimensional Fourier data. For example, if an  $n_1 \times n_2$  matrix is entered, the return value is a list with  $n_1 n_2$  values representing the entries of a  $n_1 \times n_2$  matrix. The first  $n_2$  entries of the list represent the first row of the result, the next  $n_2$  entries represent the second row, and so on.

With `ReturnType = matrix` or `ReturnType = densematrix`, only the results of one- and two-dimensional Fourier transformations can be represented.

### **Clean**

Reduce roundoff garbage in the result. All entries of the result with absolute values smaller than  $10^{(-DIGITS)}$  times the maximal absolute value of all operands of the result are set to `0.0`. Further, the routine `numeric::complexRound` is applied to all entries of the result.

---

**Note** The postprocessing of the result is done on the software level. When using hardware floating-point values, this option can increase the runtime significantly.

---

This option is ignored when used in conjunction with the option `Symbolic`.

## Return Values

List, array, hfarray, or matrix of the same length and format as the first input parameter `L`, `A`, or `M`, respectively. The type of the return value can be changed with the option `ReturnType`.

## See Also

**MuPAD Functions**  
`numeric::invfft`

## Topics

“Discrete Fourier Transforms” (Symbolic Math Toolbox)

# numeric::invfft

Inverse Fast Fourier Transform

## Syntax

```
numeric::invfft(L, <mode>, <ReturnType = t>, <Clean>)
```

```
numeric::invfft(M, <mode>, <ReturnType = t>, <Clean>)
```

```
numeric::invfft(A, <mode>, <ReturnType = t>, <Clean>)
```

## Description

`numeric::invfft(data)` returns the inverse discrete Fourier transform.

The one-dimensional inverse discrete Fourier transform  $L = \text{invfft}(F)$  of  $N$  data elements  $F_k$  stored in the list  $F = [F_1, \dots, F_N]$  is the list  $L = [L_1, \dots, L_N]$  given by

$$L_j = \frac{1}{N} \sum_{k=1}^N F_k e^{\frac{i 2 \pi (j-1)(k-1)}{N}}, j = 1, \dots, N$$

`invfft` transforms the data by a Fast Fourier Transform (FFT) algorithm.

The  $d$ -dimensional inverse discrete Fourier transform  $A = \text{invfft}(F)$  is given by

$$A_{j_1, \dots, j_d} = \frac{1}{N} \sum_{k_1=1}^{n_1} \dots \sum_{k_d=1}^{n_d} F_{k_1, \dots, k_d} e^{i 2 \pi \left( \frac{(j_1-1)(k_1-1)}{n_1} + \dots + \frac{(j_d-1)(k_d-1)}{n_d} \right)}$$

with  $j_1 = 1, \dots, n_1, \dots, j_d = 1, \dots, n_d$ .

Data provided by a list, or one-dimensional array, or `harray` are transformed according to the one-dimensional transform. Data provided by matrices are transformed

according to the two-dimensional transform. Data provided by multidimensional arrays or `hfarrays` are transformed according to the multidimensional transform matching the format of the input array.

If the data size  $N$  factorizes as  $N = p q$ , the inverse discrete Fourier transform can be computed by  $p$  different inverse Fourier transforms of subsets of the data, each subset having the data size  $q$ . The corresponding 'divide and conquer' algorithm is known as FFT ('Fast Fourier Transform'). The `invfft` routine employs the FFT algorithm. It is most efficient, when the data size  $N$  is an integer power of 2 ('radix 2 FFT'). In this case, the algorithm needs  $O(N \log_2(N))$  elementary operations.

---

**Note** More generally, FFT is efficient, if the data size is the product of many small factors.

---

Following Bluestein, the inverse Fourier transform is written as a convolution if the data size  $N$  is a prime. The data are zero-padded to a data length that is an integer power of 2. The convolution is then computed via radix 2 FFTs. Thus, the algorithm needs

$O(N \log_2(N))$  elementary operations even if  $N$  is a prime.

## Environment Interactions

Without the option `Symbolic`, the function is sensitive to the environment variable `DIGITS`, which determines the numerical working precision.

## Examples

### Example 1

Compute one-dimensional transformations using lists. By default, numerical expressions are converted to floating-point values:

```
L := [1, 2^(1/2), 3*I, PI]:  
F := numeric::fft(L)
```

```
[5.555806216 + 3.0 i, 1.0 - 1.272620909 i, -3.555806216 + 3.0 i, 1.0 - 4.727379091 i]
```

```
numeric::invfft(F)
```

$$\left[ 1.0, 1.414213562 + 2.513015626 \cdot 10^{-17} i, 3.0 i, 3.141592654 - 2.513015626 \cdot 10^{-17} i \right]$$

```
numeric::invfft(F, Clean)
```

$$[1.0, 1.414213562, 3.0 i, 3.141592654]$$

To use exact arithmetic, specify the option `Symbolic`:

```
F := numeric::fft(L, Symbolic)
```

$$[\pi + \sqrt{2} + 1 + 3 i, \pi i - \sqrt{2} i + 1 - 3 i, 1 - \sqrt{2} - \pi + 3 i, 1 + \sqrt{2} i - \pi i - 3 i]$$

```
numeric::invfft(F, Symbolic)
```

$$[1, \sqrt{2}, 3 i, \pi]$$

`numeric::invfft` accepts symbolic expressions. Internally, the default method `HardwareFloats` (with `DIGITS < 16`) fails because of the symbolic parameter `x`. The following results are computed with the software arithmetic provided by the MuPAD kernel:

```
L := [x, 2, 3, x]:
numeric::fft(L)
```

$$[2 x + 5.0, x (1.0 + 1.0 i) - 3.0 - 2.0 i, 1.0, x (1.0 - 1.0 i) - 3.0 + 2.0 i]$$

```
numeric::invfft(F)
```

$$\left[ 1.0, 1.414213562 + 5.288573187 \cdot 10^{-17} i, -1.110223025 \cdot 10^{-16} + 3.0 i, \right. \\ \left. 3.141592654 - 5.288573187 \cdot 10^{-17} i \right]$$

```
numeric::fft(L, Symbolic)
```

```
[2 x+5, x(1+i)-3-2 i, 1, x(1-i)-3+2 i]
```

```
numeric::invfft(F, Symbolic)
```

```
[1,  $\sqrt{2}$ , 3 i,  $\pi$ ]
```

```
delete L, F:
```

## Example 2

Compute the following two-dimensional transformation using an array with two indices:

```
A := array(1..2, 1..4, [[1, 2, 3, 4], [a, b, c, d]]):  
F := numeric::fft(A, Symbolic)
```

```
(
$$\begin{pmatrix} a+b+c+d+10 & a-bi-c+di-2+2i & a-b+c-d-2 & a+bi-c-d i-2-2i \\ 10-b-c-d-a & c+bi-a-di-2+2i & b-a-c+d-2 & c-bi-a+di-2-2i \end{pmatrix}$$
)
```

```
numeric::invfft(F, Symbolic)
```

```
(
$$\begin{pmatrix} 1 & 2 & 3 & 4 \\ a & b & c & d \end{pmatrix}$$
)
```

```
delete A, F
```

## Example 3

Data of arbitrary length can be transformed:

```
L := [1, 2 + I, PI/3]:  
numeric::fft(L)
```

```
[4.047197551 + 1.0 i, 0.3424266282 - 1.325151125 i, -1.389624179 + 0.3251511255 i]
```

```
delete L
```



## Parameters

### L

A list on page 7-41, or a one-dimensional array on page 7-2(1 .. N, [Symbol::hellip]), or a one-dimensional hfarray on page 7-27(1 .. N, [Symbol::hellip]) of arithmetical expressions (Symbolic Math Toolbox).

### M

A matrix of category `Cat::Matrix` of arithmetical expressions (Symbolic Math Toolbox).

### A

A  $d$ -dimensional array( 1..n\_1,Symbol::hellip,1..n\_d, [Symbol::hellip] ) or a  $d$ -dimensional hfarray( 1..n\_1,Symbol::hellip,1..n\_d, [Symbol::hellip] ) of arithmetical expressions (Symbolic Math Toolbox).

### mode

One of the flags `Hard`, `HardwareFloats`, `Soft`, `SoftwareFloats`, or `Symbolic`

## Options

### Hard, HardwareFloats, Soft, SoftwareFloats

With `Hard` (or `HardwareFloats`), computations are done using fast hardware floating-point arithmetic from within a MuPAD session. `Hard` and `HardwareFloats` are equivalent. With this option, the input data are converted to hardware floating-point values and processed by compiled C code. The result is reconverted to MuPAD floating-point values and returned to the MuPAD session.

With `Soft` (or `SoftwareFloats`) computations are done using software floating-point arithmetic provided by the MuPAD kernel. `Soft` and `SoftwareFloats` are equivalent. `SoftwareFloats` is used by default if the current value of `DIGITS` is larger than 15 and the input matrix `A` is not of domain type `DOM_HFARRAY`.

Compared to the `SoftwareFloats` used by the MuPAD kernel, the computation with `HardwareFloats` can be much faster. Note, however, that the precision of hardware

arithmetic is limited to about 15 digits. Further, the size of floating-point numbers can not be larger than approximately  $10^{308}$  and not smaller than approximately  $10^{-308}$ .

If no `HardwareFloats` or `SoftwareFloats` are specified, the following strategy is used. If the current value of `DIGITS` is smaller than 16 or if the matrix `A` is a hardware floating-point array of domain type `DOM_HFARRAY`, then hardware arithmetic is tried. If this is successful, the result is returned.

If the result cannot be computed with hardware floating-point values, software arithmetic by the MuPAD kernel is tried.

If the current value of `DIGITS` is larger than 15 and the input matrix `A` is not of domain type `DOM_HFARRAY`, or if one of the options `Soft`, `SoftwareFloats` or `Symbolic` is specified, MuPAD computes the result with its software arithmetic without trying to use hardware arithmetic first.

There can be several reasons for hardware arithmetic to fail:

- The current value of `DIGITS` is larger than 15.
- The data contains symbolic objects.
- The data contains numbers larger than  $10^{308}$  or smaller than  $10^{-308}$  that cannot be represented by hardware floating-point values.

If neither `HardwareFloats` nor `SoftwareFloats` is specified, the function does not indicate whether hardware floating-point values or software floating-point values are used.

If `HardwareFloats` are specified but fail due to one of the reasons above, a warning is issued that the (much slower) software floating-point arithmetic of the MuPAD kernel is used.

Note that `HardwareFloats` can only be used if all input data can be converted to floating-point numbers.

With `Soft` and `SoftwareFloats`, symbolic objects are accepted even if they cannot be converted to floating-point numbers. The result consists of arithmetical expressions involving both floating-point numbers as well as symbolic objects. See “Example 1” on page 19-90 (Symbolic Math Toolbox).

The trailing digits in floating-point results computed with `HardwareFloats` and `SoftwareFloats` can differ.

## Symbolic

This option prevents conversion of the input data to floating-point values.

Without this option, the floating-point converter `float` is applied to all input data. Use this option if no such conversion is desired. Exact arithmetic is used to compute the Fourier transformation.

## ReturnType

Option, specified as `ReturnType = t`

Return the result in a container of domain type (Symbolic Math Toolbox) `t`. The following return types `t` are available: `DOM_LIST`, or `DOM_ARRAY`, or `DOM_HFARRAY`, or `matrix`, or `densematrix`.

This option determines the domain type (Symbolic Math Toolbox) `t` of the result.

If no return type is specified by this option, the result is of the same type and format as the input data.

If the return type `DOM_LIST` is specified, the result is always a plain list of floating-point numbers. If the input data are given by a matrix or a multidimensional array, the returned list represents the operands of the multidimensional Fourier data. For example, if an  $n_1 \times n_2$  matrix is entered, the return value is a list with  $n_1 n_2$  values representing the entries of a  $n_1 \times n_2$  matrix. The first  $n_2$  entries of the list represent the first row of the result, the next  $n_2$  entries represent the second row, and so on.

With `ReturnType = matrix` or `ReturnType = densematrix`, only the results of one- and two-dimensional Fourier transformations can be represented.

## Clean

Reduce roundoff garbage in the result. All entries of the result with absolute values smaller than  $10^{(-DIGITS)}$  times the maximal absolute value of all operands of the result are set to `0.0`. Further, the routine `numeric::complexRound` is applied to all entries of the result.

---

**Note** The postprocessing of the result is done on the software level. When using hardware floating-point values, this option can increase the runtime significantly.

---

This option is ignored when used in conjunction with the option `Symbolic`.

## Return Values

List, array, hfarray, or matrix of the same length and format as the first input parameter `L`, `A`, or `M`, respectively. The type of the return value can be changed with the option `ReturnType`.

## See Also

### MuPAD Functions

`numeric::fft`

### Topics

“Discrete Fourier Transforms” (Symbolic Math Toolbox)

# numeric::fMatrix

Functional calculus for numerical square matrices

## Syntax

`numeric::fMatrix(f, A, p1, p2, ..., options)`

## Description

`numeric::fMatrix(f, A)` computes the matrix  $f(A)$  with a function  $f$  and a square matrix  $A$ .

If no return type is specified via the option `ReturnType = d`, the domain type of the result depends on the type of the input matrix  $A$ :

- For an array on page 7-2  $A$ , the result is returned as an array on page 7-2.
- For an hfarray on page 7-27  $A$ , the result is returned as an array on page 7-2.
- For a dense matrix on page 1-506  $A$  of type `Dom::DenseMatrix()` the result is a dense matrix of type `Dom::DenseMatrix()` over the ring of MuPAD expressions.
- For all other matrices  $A$  of category `Cat::Matrix`, the result is returned as a `matrix` of type `Dom::Matrix()` over the ring of MuPAD expressions. This includes input matrices  $A$  of type `Dom::Matrix(...)`, `Dom::SquareMatrix(...)`, `Dom::MatrixGroup(...)` etc.

The components of  $A$  must not contain symbolic objects which cannot be converted to numerical values via `float`. Numerical symbolic expressions such as  $\pi$ ,  $\sqrt{2}$ ,  $e^{-1}$  etc. are accepted. They are converted to floats.

---

**Note** When you use `numeric::fMatrix`, the matrix must be diagonalizable, and all its elements must be convertible to floating-point numbers. Otherwise, use `funm`.

If `numeric::fMatrix` detects numerically that  $A$  is not diagonalizable, it aborts with an error message. Nevertheless, the numerical algorithm often fails to detect that the matrix is not diagonalizable, and the returned matrix is dominated by round-off effects.

When using `numeric::fMatrix`, ensure the diagonalization is possible and well conditioned.

---

Symmetric/Hermitian and skew/skew Hermitian matrices can always be diagonalized in a numerically stable way; `numeric::fMatrix` produces reliable numerical results for such matrices.

The procedure `f` must accept complex floating-point numbers as first argument. It may return arbitrary MuPAD expressions, provided these can be multiplied with floating-point numbers.

The parameters  $p_1, p_2, \dots$  may be numerical or symbolic objects. They must be accepted by `f` as 2nd argument, 3rd argument etc.

In contrast to the components of  $A$ , numerical symbolic objects such as  $\pi, \sqrt{2}$  etc. passed as parameters  $p_1, p_2, \dots$  are not converted to floats.

Inversion or exponentiation of a matrix may be realized with the functions  $a \rightarrow \frac{1}{a}$  and `exp`, respectively. However, it is recommended to use the specialized algorithms<sup>a</sup> `numeric::inverse` and `numeric::expMatrix` instead. Also matrix evaluation of low degree polynomials should be done with standard matrix arithmetic rather than with `numeric::fMatrix`.

## Environment Interactions

The function is sensitive to the environment variable `DIGITS`, which determines the numerical working precision.

## Examples

### Example 1

We compute the matrix power  $A^{100}$ :

```
A := array(1..2, 1..2, [[2, PI], [exp(-10), 0]]):  
numeric::fMatrix(x -> x^100, A)
```

$$\begin{pmatrix} 1.272133133 \cdot 10^{30} & 1.998190806 \cdot 10^{30} \\ 2.887634784 \cdot 10^{25} & 4.535724387 \cdot 10^{25} \end{pmatrix}$$

Alternatively, you may use the function `_power` which takes the exponent as a second parameter:

```
numeric::fMatrix(_power, A, 100)
```

$$\begin{pmatrix} 1.272133133 \cdot 10^{30} & 1.998190806 \cdot 10^{30} \\ 2.887634784 \cdot 10^{25} & 4.535724387 \cdot 10^{25} \end{pmatrix}$$

```
delete A:
```

## Example 2

We compute the square root of a matrix:

```
A := matrix([[0, 1], [-1, 1]]):
B := numeric::fMatrix(sqrt, A)
```

$$\begin{pmatrix} 0.5773502692 & 0.5773502692 + 1.110223025 \cdot 10^{-16} i \\ -0.5773502692 + 5.551115123 \cdot 10^{-17} i & 1.154700538 - 1.110223025 \cdot 10^{-16} i \end{pmatrix}$$

The small imaginary parts are caused by numerical round-off. We eliminate them by extracting the real parts of the components:

```
B := map(B, Re)
```

$$\begin{pmatrix} 0.5773502692 & 0.5773502692 \\ -0.5773502692 & 1.154700538 \end{pmatrix}$$

We verify that  $B^2$  is  $A$ . Since  $A$  was passed as a matrix of type `Dom::Matrix()`, the matrix  $B$  is also of this type. We may compute the square by the overloaded standard arithmetic using the operator `^`:

B<sup>2</sup>

$$\begin{pmatrix} -1.283695372 \cdot 10^{-16} & 1.0 \\ -1.0 & 1.0 \end{pmatrix}$$

delete A, B:

### Example 3

We compute  $e^{t\pi A}$  with a symbolic parameter  $t$ :

```
A := array(1..2, 1..2, [[0, 1], [-1, 0]]):  
numeric::fMatrix(exp@_mult, A, t*PI)
```

$$\begin{pmatrix} \sigma_1 & 0.5 e^{-1.0 \pi t i} i - 0.5 e^{1.0 \pi t i} i \\ -0.5 e^{-1.0 \pi t i} i + 0.5 e^{1.0 \pi t i} i & \sigma_1 \end{pmatrix}$$

where

$$\sigma_1 = 0.5 e^{-1.0 \pi t i} + 0.5 e^{1.0 \pi t i}$$

delete A:

### Example 4

We demonstrate the difference between HardwareFloats and SoftwareFloats. The diagonalization of the following matrix is ill-conditioned. The result is dominated by round-off effects:

```
A := array(1..3, 1..3, [[10, 1, 1 ],  
                        [ 0, 1, 1 ],  
                        [ 1, 0, 10^(-14)]]):  
numeric::fMatrix(ln, A, SoftwareFloats)
```



$$\begin{pmatrix} 2.284572396 & 0.2635466905 & 0.2635466905 \\ -4.117444729 & 4.03009691 & 41.43799398 \\ 4.380991419 & -4.117444729 & -41.5253418 \end{pmatrix}$$

```
numeric::fMatrix(ln, A, HardwareFloats)
```

$$\begin{pmatrix} 2.284572396 & 0.2635466905 & 0.2635466905 \\ -3.532353481 & 3.445005663 & 35.5870815 \\ 3.795900172 & -3.532353481 & -35.67442932 \end{pmatrix}$$

In the following case, the round-off effects of SoftwareFloats makes the algorithm think that the matrix cannot be diagonalized. Consequently, FAIL is returned. With HardwareFloats, however, a result is computed:

```
A := array(1..3, 1..3, [[ 1, 1, 1 ],
                        [ 0, 1, 1 ],
                        [ 10^(-30), 0, 10^(-30)]]):
numeric::fMatrix(ln, A, SoftwareFloats)
```

FAIL

```
numeric::fMatrix(ln, A, HardwareFloats)
```

$$\begin{pmatrix} -5.469808086 \cdot 10^{-17} & 1.000000477 & 0.9999345993 \\ 9.98400946 \cdot 10^{-31} & -5.632422161 \cdot 10^{-17} & 69.07755279 \\ 0 & 0 & -69.07755279 \end{pmatrix}$$

```
delete A:
```

## Parameters

**f**

A procedure on page 1-1654 representing a scalar function  $f: \mathbb{C} \rightarrow \mathbb{C}$  or  $f: \mathbb{C} \times P \times \dots \times P \rightarrow \mathbb{C}$ , where  $P$  is a set of parameters

**A**

A square matrix of domain type on page 1-574 `DOM_ARRAY`, `DOM_HFARRAY`, or of category `Cat::Matrix`

**p<sub>1</sub>, p<sub>2</sub>, ...**

Arbitrary MuPAD objects accepted by  $f$  as additional input parameters

## Options

### **Hard, HardwareFloats, Soft, SoftwareFloats**

With **Hard** (or **HardwareFloats**), computations are done using fast hardware float arithmetic from within a MuPAD session. **Hard** and **HardwareFloats** are equivalent. With this option, the input data are converted to hardware floats and processed by compiled C code. The result is reconverted to MuPAD floats and returned to the MuPAD session.

With **Soft** (or **SoftwareFloats**) computations are done using software float arithmetic provided by the MuPAD kernel. **Soft** and **SoftwareFloats** are equivalent. **SoftwareFloats** is used by default if the current value of `DIGITS` is larger than 15 and the input matrix **A** is not of domain type `DOM_HFARRAY`.

Compared to the **SoftwareFloats** used by the MuPAD kernel, the computation with **HardwareFloats** may be many times faster. Note, however, that the precision of hardware arithmetic is limited to about 15 digits. Further, the size of floating-point numbers may not be larger than approximately  $10^{308}$  and not smaller than approximately  $10^{-308}$ .

If no **HardwareFloats** or **SoftwareFloats** are requested explicitly, the following strategy is used: If the current value of `DIGITS` is smaller than 16 or if the matrix **A** is a

hardware float array of domain type `DOM_HFARRAY`, then hardware arithmetic is tried. If this is successful, the result is returned.

If the result cannot be computed with hardware floats, software arithmetic by the MuPAD kernel is tried.

If the current value of `DIGITS` is larger than 15 and the input matrix `A` is not of domain type `DOM_HFARRAY`, or if one of the options `Soft`, `SoftwareFloats` or `Symbolic` is specified, MuPAD computes the result with its software arithmetic without trying to use hardware floats first.

There may be several reasons for hardware arithmetic to fail:

- The current value of `DIGITS` is larger than 15.
- The data contains symbolic objects.
- The data contains numbers larger than  $10^{308}$  or smaller than  $10^{-308}$  that cannot be represented by hardware floats.

If neither `HardwareFloats` nor `SoftwareFloats` is specified, the user is not informed whether hardware floats or software floats are used.

If `HardwareFloats` are specified but fail due to one of the reasons above, a warning is issued that the (much slower) software floating-point arithmetic of the MuPAD kernel is used.

---

**Note** For ill-conditioned matrices, the result is subject to round-off errors. The results returned with `HardwareFloats` and `SoftwareFloats` may differ! See “Example 4” on page 19-108 (Symbolic Math Toolbox).

---

### **NoWarning**

Suppresses warnings

### **ReturnType**

Option, specified as `ReturnType = d`

Return the result as a matrix of domain type (Symbolic Math Toolbox) `d`. The following return types are available: `DOM_ARRAY`, `DOM_HFARRAY`, `Dom::Matrix()`, or `Dom::DenseMatrix()`.

## Return Values

Depending on the type of the input matrix  $A$ , the matrix  $f(A)$  is returned as a matrix of type `DOM_ARRAY`, `DOM_HFARRAY`, `Dom::Matrix()` or `Dom::DenseMatrix()`. If the algorithm thinks that  $A$  is not diagonalizable, then `FAIL` is returned.

## Algorithms

A numerical diagonalization  $A = X \text{diag}(\lambda_1, \lambda_2, \dots) X^{-1}$  is computed. The columns of  $X$  are the (right) eigenvectors of  $A$ , the diagonal entries  $\lambda_1, \lambda_2, \dots$  are the corresponding eigenvalues. The function  $f$  is mapped to the eigenvalues, the matrix result is computed by

$$f(A, p_1, p_2, \dots) = X \text{diag}(f(\lambda_1, p_1, p_2, \dots), f(\lambda_2, p_1, p_2, \dots), \dots) X^{-1}$$

The eigenvector matrix  $X$  may be obtained via `numeric::eigenvectors(A)[2]`.

The condition number  $\|X\|_{\infty} \left\| \frac{1}{X} \right\|_{\infty}$  of the eigenvector matrix is a measure indicating how well conditioned the diagonalization of the matrix  $A$  is. If this number is larger than  $10^{\text{DIGITS}}$ , then not a single digit of the diagonalization data is trustworthy.

The call `numeric::fMatrix(exp, A)` corresponds to `numeric::expMatrix(A, Diagonalization)`.

## See Also

### MuPAD Functions

`funm` | `linalg::sqrtMatrix` | `numeric::expMatrix` | `numeric::inverse`

# numeric::fsolve

Search for a numerical root of a system of equations

## Syntax

```
numeric::fsolve(eq, x, options)
```

```
numeric::fsolve(eq, x = a, options)
```

```
numeric::fsolve(eq, x = a .. b, options)
```

```
numeric::fsolve(eqs, [x1, x2, ...], options)
```

```
numeric::fsolve(eqs, {x1, x2, ...}, options)
```

```
numeric::fsolve(eqs, [x1 = a1, x2 = a2, ...], options)
```

```
numeric::fsolve(eqs, {x1 = a1, x2 = a2, ...}, options)
```

```
numeric::fsolve(eqs, [x1 = a1 .. b1, x2 = a2 .. b2, ...], options)
```

```
numeric::fsolve(eqs, {x1 = a1 .. b1, x2 = a2 .. b2, ...}, options)
```

## Description

`numeric::fsolve(eqs, ...)` returns a numerical approximation of a solution of the system of equations `eqs`.

This is the MuPAD numerical solver for non-linear systems of equations.

---

**Note** By default, this routine returns only *one* numerical solution!

---

The equations must not contain symbolic objects other than the unknowns that cannot be converted to numerical values via `float`. Symbolic objects such as  $\pi$  or  $\sqrt{2}$  etc. are accepted. The same holds true for starting values and search ranges. Search ranges may contain  $\pm\infty$ . Cf. “Example 2” on page 19-117 (Symbolic Math Toolbox).

`numeric::fsolve` implements a purely numerical Newton type root search with a working precision set by the environment variable `DIGITS`. Well separated simple roots should be exact within this precision. However, multiple roots or badly separated roots may be computed with a restricted precision. Cf. “Example 3” on page 19-118 (Symbolic Math Toolbox).

---

**Note** For systems of equations, the expressions defining the equations must have a symbolic derivative!

---

Overdetermined systems (i.e., more equations than indeterminates) are not accepted. However, there may be more indeterminates than equations. Cf. “Example 4” on page 19-118 (Symbolic Math Toolbox).

Specifying indeterminates  $[x_1, x_2, \dots]$  without starting values or search ranges is equivalent to the search ranges  $[x_1 = -\text{infinity} .. \text{infinity}, x_2 = -\text{infinity} .. \text{infinity}, \dots]$ . Note, however, that the user should assist `numeric::fsolve` by providing specific search ranges whenever possible! If a complex starting point or a search range involving a complex number is specified for at least one of the unknowns, the search is extended to the entire complex plane for all variables for which no explicit search interval is given.

For real equations and real starting points or search ranges, the internal Newton iteration will usually produce real values, i.e., `numeric::fsolve` searches for real roots only (unless square roots, logarithms etc. happen to produce complex values from real input). Use complex starting points or search ranges to search for complex roots of real equations. Cf. “Example 5” on page 19-118 (Symbolic Math Toolbox).

Starting values and search ranges can be mixed. Cf. “Example 6” on page 19-119 (Symbolic Math Toolbox).

Search ranges should only be provided if a solution is known to exist inside the search range. Otherwise, the search may take some time before `numeric::fsolve` gives up.

Specification of a search range primarily means that starting points from this range are used for the internal Newton search. For sufficiently small search ranges enclosing a solution the search will usually pick out this solution. However, it may also happen that the Newton iteration drifts towards other solutions.

With the default search strategy `RestrictedSearch`, only solutions from the search range are accepted, even if solutions outside the search range are found internally. More

specifically, if a search range such as  $x = a \dots b$  is specified for the variable  $x$ , then solutions satisfying  $\min(\Re(a), \Re(b)) \leq \Re(x) \leq \max(\Re(a), \Re(b))$  and  $\min(\Im(a), \Im(b)) \leq \Im(x) \leq \max(\Im(a), \Im(b))$  are searched for. Thus, the values  $a$ ,  $b$  specify the bottom left and top right corner of a rectangular search area in the complex plane when the `RestrictedSearch` strategy is used.

With the search strategy `UnrestrictedSearch`, any solution inside or outside the search range is accepted and returned. Cf. “Example 7” on page 19-119 (Symbolic Math Toolbox).

If starting values for all indeterminates are provided, then a *single* Newton iteration with these initial data is launched. It either leads to a solution or `numeric::fsolve` gives up and returns `FAIL`. The same holds true if search ranges  $x = a \dots a$  or  $[x_1 = a_1 \dots a_1, x_2 = a_2 \dots a_2, \dots]$  of zero length are specified.

---

**Note** The risk of failure is high when providing bad starting values! Starting values are appropriate only if a sufficiently good approximation of the solution is known! On the other hand, providing good starting values is the fastest way to a solution. Cf. “Example 8” on page 19-120 (Symbolic Math Toolbox).

---

If at least one of the indeterminates has a non-trivial search range, then `numeric::fsolve` uses *several* Newton iterations with different starting values from the search range. Cf. “Example 9” on page 19-121 (Symbolic Math Toolbox). Search ranges in conjunction with the option `UnrestrictedSearch` provide a higher chance of detecting roots than (bad) starting values!

---

**Note** User defined assumptions such as `assume(x > 0)` are not taken into account in the numerical search! Provide search ranges instead! Cf. “Example 2” on page 19-117 (Symbolic Math Toolbox).

---

---

**Note** Convergence may be slow for multiple roots! Furthermore, `numeric::fsolve` may fail to detect such roots!

---

Use `linsolve` or `numeric::linsolve` for systems of *linear* equations.

Use `numeric::realroots`, if *all real roots* of a single non-polynomial real equation in a finite range are desired.

Use `polylib::realroots`, if *all real roots* of a real univariate polynomial are desired.

Use `numeric::polyroots`, if *all real and complex roots* of a univariate polynomial are desired.

Use `numeric::solve`, if *all roots* of a multivariate polynomial system are desired.

The routine `numeric::solve` provides a common interface to all these numerical solvers.

## Environment Interactions

The function is sensitive to the environment variable `DIGITS`, which determines the numerical working precision.

## Examples

### Example 1

We compute roots of the sine function:

```
numeric::fsolve(sin(x) = 0, x)
```

```
[x = 0.0]
```

With the option `Random`, several calls may result in different roots:

```
numeric::fsolve(sin(x), x, Random)
```

```
[x = -226.1946711]
```

```
numeric::fsolve(sin(x), x, Random)
```

```
[x = 97.38937226]
```



Particular solutions can be chosen by an appropriate starting point close to the wanted solution, or by a search interval:

```
numeric::fsolve(sin(x), x = 3),
numeric::fsolve(sin(x), x = -4 .. -3)
```

```
[x = 3.141592653], [x = -3.141592654]
```

The solutions found by `numeric::fsolve` can be used in `subs` and `assign` to substitute or assign the indeterminates:

```
eqs := [x^2 = sin(y), y^2 = cos(x)]:
solution := numeric::fsolve(eqs, [x, y])
```

```
[x = -0.8517004887, y = 0.8116062151]
```

```
eval(subs(eqs, solution))
```

```
[0.7253937224 = 0.7253937224, 0.6587046485 = 0.6587046485]
```

```
assign(solution): x, y
```

```
-0.8517004887, 0.8116062151
```

```
delete eqs, solution, x, y:
```

## Example 2

We demonstrate the use of search ranges. The following system has solutions with positive and negative  $x$ . The solution with  $x \geq 0$  is obtained with the search interval  $x = 0 .. \text{infinity}$ :

```
numeric::fsolve([x^2 = exp(x*y), x^2 = y^2], [x = 0 .. infinity, y])
```

```
[x = 0.753089165, y = -0.753089165]
```

We search for a solution with  $x \leq 0$ :

```
numeric::fsolve([x^2 = exp(x*y), x^2 = y^2], [x = -infinity .. 0, y])
```

```
[x = -0.753089165, y = 0.753089165]
```

### Example 3

Multiple roots can only be computed with a restricted precision:

```
numeric::fsolve(expand((x - 1/3)^5), x = 0.3)
```

```
[x = 0.3333672906]
```

### Example 4

The following system of equations is degenerate and has a 1-parameter family of solutions. Each call to `numeric::fsolve` picks out one random solution:

```
numeric::fsolve([x^2 - y^2, x^2 - y^2], [x, y], Random) $ i = 1 .. 3
```

```
[x = 34.70258251, y = 34.70258251], [x = -29.16650501, y = 29.16650501],  
[x = 5.933941324, y = -5.933941324]
```

The equation may also be specified as an underdetermined system:

```
numeric::fsolve([x^2 - y^2], [x, y])
```

```
[x = 0.0, y = 0.0]
```

### Example 5

The following equation has no real solution. Consequently, the numerical search with real starting values fails:

```
numeric::fsolve(sin(x) + cos(x)^2 = 3, x)
```

```
FAIL
```

With a complex starting value, a solution is found:

```
numeric::fsolve(sin(x) + cos(x)^2 = 3, x = I)
```

```
[x = 0.2972513613 + 1.128383965 i]
```

Also complex search ranges may be specified. In the following, the internal starting point is a random value on the line from  $2 + I$  to  $3 + 2I$ . Solutions are accepted if they lie in the complex rectangle with the bottom left corner  $2 + I$  and the top right corner  $3 + 2I$ :

```
numeric::fsolve(sin(x) + cos(x)^2 = 3, x = 2 + I .. 3 + 2*I)
```

```
[x = 2.844341292 + 1.128383965 i]
```

## Example 6

Starting values and search intervals can be mixed:

```
numeric::fsolve([x^2 + y^2 = 1, y^2 + z^2 = 1, x^2 + z^2 = 1],
                [x = 1, y = 0 .. 10, z])
```

```
[x = 0.7071067812, y = 0.7071067812, z = 0.7071067812]
```

## Example 7

With `UnrestrictedSearch`, search intervals are only used for choosing starting values for the internal Newton search. The numerical iteration may drift towards a solution outside the search range:

```
eqs := [x*sin(10*x) = y^3, y^2 = exp(-2*x/3)]:
numeric::fsolve(eqs, [x = 0 .. 1, y = -1 .. 0], UnrestrictedSearch)
```

```
[x = 1.232766201, y = -0.6630386021]
```

With the default strategy `RestrictedSearch`, only solutions inside the search range are accepted:

```
numeric::fsolve(eqs, [x = 0 .. 1, y = -1 .. 0])
```

```
[x = 0.9816416007, y = -0.7209295436]
```

In the last search, also the previous solution outside the search range was found. With the option `MultiSolutions`, `numeric::fsolve` returns a sequence of all solutions that were found in the internal search:

```
numeric::fsolve(eqs, [x = 0 .. 1, y = -1 .. 0], MultiSolutions)
```

```
[x = 0.9816416007, y = -0.7209295436], [x = 1.232766201, y = -0.6630386021]
```

```
delete eqs:
```

## Example 8

Usually, most of the time is spent internally searching for some (crude) approximations of the root. If high precision roots are required, it is recommended to compute first approximations with moderate values of `DIGITS` and use them as starting values for a refined search:

```
eq := exp(-x) = x:  
DIGITS := 10:  
firstApprox := numeric::fsolve(eq, x)
```

```
[x = 0.5671432904]
```

This output is suitable as input defining a starting value for `x`:

```
DIGITS := 1000: numeric::fsolve(eq, firstApprox)
```

```
[x = 0.5671432904097838729999686622103555497538...]
```

```
delete eq, firstApprox, DIGITS:
```

## Example 9

Specifying starting values for the indeterminates launches a *single* Newton iteration. This may fail, if the starting values are not sufficiently close to the solution:

```
eq := [x*y = x + y - 4, x/y = x - y + 4]:
numeric::fsolve(eq, [x = 1, y = 1])
```

FAIL

If a search range is specified for at least one of the unknowns, then *several* Newton iterations with random starting values in the search range are used, until a solution is found or until `numeric::fsolve` gives up:

```
numeric::fsolve(eq, [x = 1, y = 0 .. 10])
```

```
[x = 4.02644145 10-14, y = 4.0]
```

```
delete eq:
```

## Parameters

### eq

An arithmetical expression or an equation in one indeterminate  $x$ . An expression `eq` is interpreted as the equation  $eq = 0$ .

### eqs

A list on page 7-41, set on page 7-50, array, or matrix (`Cat::Matrix`) of expressions or equations in several indeterminates  $x_1, x_2, \dots$ . Expressions are interpreted as homogeneous equations.

### x, x<sub>1</sub>, x<sub>2</sub>, ...

Identifiers or indexed identifiers to be solved for.

**a, a<sub>1</sub>, a<sub>2</sub>, ...**

Real or complex numerical starting values for the internal search. Typically, crude approximations of solution.

**a .. b, a<sub>1</sub> .. b<sub>1</sub>, a<sub>2</sub> .. b<sub>2</sub>, ...**

Ranges of numerical values defining search intervals for the numerical root.

## Options

### RestrictedSearch

Makes `numeric::fsolve` return only numerical roots in the user-defined search range  $x = a \dots b$  and  $[x_1 = a_1 \dots b_1, x_2 = a_2 \dots b_2, \text{Symbol}::\text{hellip}]$ , respectively. This is the default search strategy, if a search range is specified for at least one of the unknowns.

Once a root with components  $(r_1, r_2, \dots)$  is found, it is checked whether  $\min(\Re(a_i), \Re(b_i)) \leq \Re(r_i) \leq \max(\Re(a_i), \Re(b_i))$  and  $\min(\Im(a_i), \Im(b_i)) \leq \Im(r_i) \leq \max(\Im(a_i), \Im(b_i))$  is satisfied. If the root is not inside the search range, the search is continued. Note that solutions outside the search range may be found internally. These may be accessed with the option `MultiSolutions`. See “Example 7” on page 19-119 (Symbolic Math Toolbox).

### UnrestrictedSearch

Allows `numeric::fsolve` to find and return solutions outside the specified search range. With this option, the search range is only used to choose random starting points for the internal numerical search.

This option switches off the search strategy `RestrictedSearch`. With `UnrestrictedSearch`, `numeric::fsolve` stops its internal search whenever a root is found, even if the root is not inside the specified search range. Starting points for the internal Newton search are taken from the search range.

### MultiSolutions

Makes `numeric::fsolve` return all solutions found in the internal search

This option only has an effect when used with the default search strategy `RestrictedSearch`. A sequence of all roots found in the internal search is returned. Cf. “Example 7” on page 19-119 (Symbolic Math Toolbox).

### Random

With this option, several calls to `numeric::fsolve` with the same input parameters may produce different roots.

With this option, random starting values are chosen for the internal search. Consequently, calling `numeric::fsolve` several times with the same parameters may lead to different solutions. This may be useful when several roots of one and the same equation or set of equations are desired.

## Return Values

Single numerical root is returned as a list of equations  $[x = \text{value}]$  or  $[x_1 = \text{value}_1, x_2 = \text{value}_2, \dots]$ , respectively. FAIL is returned if no solution is found. With the option `MultiSolutions`, sequences of solutions may be returned.

## Algorithms

Internally the set of equations  $f(x) = 0$  is solved by a modified Newton iteration

$x \rightarrow x - t f'(x)^{-1} f(x)$  with some adaptively chosen step size  $t$ . For degenerate or ill-conditioned Jacobians  $f'$  a minimization strategy for  $\langle f, f \rangle$  is implemented. For scalar real equations, `numeric::realroot` is used, if a real finite search range is specified.

## See Also

### MuPAD Functions

`linsolve` | `numeric::linsolve` | `numeric::polyroots` | `numeric::polysysroots` | `numeric::realroot` | `numeric::realroots` | `numeric::solve` | `polylib::realroots` | `solve`

**Topics**

“Solve Equations Numerically” (Symbolic Math Toolbox)



# numeric::gaussAGM

Gauss' arithmetic geometric mean

## Syntax

numeric::gaussAGM(a, b)

## Description

numeric::gaussAGM(a, b) computes the arithmetic geometric mean of the numbers  $a$  and  $b$ .

The iteration

$$a_{n+1} = \frac{a_n + b_n}{2}, b_{n+1} = (a_n + b_n) \sqrt{\frac{a_n b_n}{(a_n + b_n)^2}}$$

with the starting values  $a_0 = a, b_0 = b$  converges quadratically to some value

$\lim_{n \rightarrow \infty} a_n = \lim_{n \rightarrow \infty} b_n$ . This limit is called Gauss' arithmetic geometric mean of the starting values  $a, b$ .

If both arguments  $a$  and  $b$  can be converted to real or complex floating-point numbers, then a floating point value is computed and returned. Otherwise, the symbolic call numeric::gaussAGM(a, b) is returned.

If  $a = 0$  or  $b = 0$  or  $a + b = 0$ , then 0.0 is returned, even if  $a$  or  $b$  are symbolic objects.

The following relation to elliptic integrals on page 1-590 holds for all complex values  $a$  and  $b$ :

$$\text{numeric::gaussAGM}(a, b) = \frac{\pi}{4} \frac{a+b}{\text{ellipticK}\left(\frac{(a-b)^2}{(a+b)^2}\right)}$$

## Environment Interactions

The function is sensitive to the environment variable DIGITS.

## Examples

### Example 1

A floating-point number is returned if the arguments can be converted to floating-point numbers:

```
numeric::gaussAGM(0, 5)
```

```
0.0
```

```
numeric::gaussAGM(sqrt(2), PI)
```

```
2.192033978
```

```
numeric::gaussAGM(-10, PI)
```

```
-2.377943461 - 2.966350545 i
```

```
numeric::gaussAGM(1 + I, 1 + 2*I)
```

```
1.020054126 + 1.471349363 i
```

A symbolic call is returned if one of the arguments cannot be converted to a float:

```
numeric::gaussAGM(1, b)
```

```
numeric::gaussAGM(1, b)
```

For the special cases  $a = 0$ ,  $b = 0$  and  $a + b = 0$ , the result 0.0 is returned even for symbolic arguments:

```
numeric::gaussAGM(a, 0)
```

```
0.0
```

```
numeric::gaussAGM(a, -a)
```

```
0.0
```

## Parameters

**a, b**

arithmetical expressions (Symbolic Math Toolbox)

## Return Values

Floating point number or a symbolic call `numeric::gaussAGM(a, b)`.

## See Also

**MuPAD Functions**

ellipticK

## numeric::gldata

Weights and abscissae of Gauss-Legendre quadrature

### Syntax

```
numeric::gldata(n, digits)
```

### Description

`numeric::gldata(n, digits)` returns the weights and the abscissae of the Gauss-Legendre quadrature rule with  $n$  nodes with a precision of `digits` decimal digits.

The Gauss-Legendre quadrature rule  $\sum_{i=1}^n b_i f(c_i)$  produces the exact integral  $\int_0^1 f(x) dx$  for all polynomial integrands  $f(x)$  through degree  $2n - 1$ . The weights  $b_i$  and abscissae  $c_i$  are related to the roots of the  $n$ -th Legendre polynomial.

The weights and abscissae are computed by a straightforward numerical algorithm with a working precision set by the argument `digits`. The resulting floating-point numbers are correct to `digits` leading decimal places.

Typically, the argument `digits` is chosen as the current value of the environment variable `DIGITS`.

The data for  $n = 20, 40, 80, 160$  with `digits`  $\leq 200$  are stored internally. They are returned immediately without any computational costs.

Due to the internal remember mechanism, only the first call to `numeric::gldata` leads to computational costs. For any further call with the same arguments, the data are returned immediately.

For odd  $n$ , the abscissa  $c_{\frac{n+1}{2}} = \frac{1}{2}$  and the corresponding weight  $b_{\frac{n+1}{2}}$  are rational numbers.

## Environment Interactions

`numeric::gldata` is *not* sensitive to changes of the environment variable `DIGITS`, because the numerical working precision is specified by the second argument `digits`.

The function uses option `remember`.

## Examples

### Example 1

The following call computes the Gauss-Legendre data with a precision given by the current value of the environment variable `DIGITS` (the default value is `DIGITS = 10`):

```
[b, c] := numeric::gldata(4, DIGITS)

[[0.1739274226, 0.3260725774, 0.3260725774, 0.1739274226],
 [0.0694318442, 0.3300094782, 0.6699905218, 0.9305681558]]
```

The Gauss-Legendre data with 4 nodes provide exact numerical quadrature results for polynomials through degree 7:

```
f := x -> x^7:
int(f(x), x= 0..1) = _plus(b[i]*f(c[i]) $ i=1..4)
```

$$\frac{1}{8} = 0.125$$

```
delete b, c, f:
```

### Example 2

For odd  $n$ , exact rational data for  $\frac{c_{n+1}}{2}$  and  $\frac{b_{n+1}}{2}$  are returned. The other data are computed as floating-point approximations:

```
DIGITS := 4: numeric::gldata(5, DIGITS)
```

$$\left[ \left[ 0.1185, 0.2393, \frac{64}{225}, 0.2393, 0.1185 \right], \left[ 0.04691, 0.2308, \frac{1}{2}, 0.7692, 0.9531 \right] \right]$$

delete DIGITS:

## Parameters

**n**

The number of nodes: a positive integer

**digits**

The number of decimal digits: a positive integer

## Return Values

List [b, c] is returned. The lists  $b = [b_1, \dots, b_n]$  and  $c = [c_1, \dots, c_n]$  are numerical approximations of the weights and abscissae with `digits` significant digits.

## Algorithms

The numerical integrator `numeric::quadrature` calls `numeric::gldata` to provide the data for Gaussian quadrature.

## See Also

### MuPAD Functions

`numeric::gldata` | `numeric::int` | `numeric::ncdata` | `numeric::quadrature`

# numeric::gtdata

Weights and abscissae of Gauss-Tschebyscheff quadrature

## Syntax

`numeric::gtdata(n)`

## Description

`numeric::gtdata(n)` returns the weights and the abscissae of the Gauss-Tschebyscheff quadrature rule with  $n$  nodes.

The Gauss-Tschebyscheff quadrature rule  $\sum_{i=1}^n b_i f(c_i)$  produces the exact integral

$\int_0^1 f(x) dx$  for all integrands of the form  $f(x) = \frac{p(x)}{\sqrt{x(1-x)}}$  with polynomials  $p(x)$  through degree  $2n - 1$ .

The exact weights  $b = [b_1, \dots, b_n]$  and abscissae  $c = [c_1, \dots, c_n]$  are given by

$$b_i = \frac{\pi}{2n} \sin\left(\frac{(2i-1)\pi}{2n}\right), \quad c_i = \frac{1 + \cos\left(\frac{(2i-1)\pi}{2n}\right)}{2}$$

## Environment Interactions

`numeric::gtdata` is not sensitive to the environment variable DIGITS.

The function uses option `remember`.

## Examples

### Example 1

The following call produces exact data for the quadrature rule with two nodes:

```
numeric::gtdata(2)
```

$$\left[ \left[ \frac{\pi\sqrt{2}}{8}, \frac{\pi\sqrt{2}}{8} \right], \left[ \frac{\sqrt{2}}{4} + \frac{1}{2}, \frac{1}{2} - \frac{\sqrt{2}}{4} \right] \right]$$

## Parameters

**n**

The number of nodes: a positive integer

## Return Values

List  $[b, c]$  is returned. The lists  $b = [b_1, \dots, b_n]$  and  $c = [c_1, \dots, c_n]$  are the exact weights and abscissae of the Gauss-Tschebyscheff quadrature rule, respectively.

## Algorithms

The numerical integrator `numeric::quadrature` calls `numeric::gtdata` to provide the data for Gauss-Tschebyscheff quadrature.

## See Also

### MuPAD Functions

`numeric::gldata` | `numeric::int` | `numeric::ncdata` | `numeric::quadrature`



# numeric::indets

Search for indeterminates

## Syntax

```
numeric::indets(object)
```

## Description

`numeric::indets(object)` returns a set of the indeterminates contained in the object.

This is an auxiliary routine used by `numeric::polyroots`, `numeric::quadrature`, `numeric::realroots`, `numeric::solve` etc. to find indeterminates.

It recursively searches the operands of `object` for indeterminates. In particular, the search is applied to the elements of lists, sets, arrays, tables, etc.

Following objects are regarded as indeterminates: identifiers, indexed identifiers and the indeterminates of `DOM_POLY` objects. Also coefficients of such polynomials are searched for indeterminates.

The following objects are *not* regarded as indeterminates: the numerical constants `PI` (Symbolic Math Toolbox), `EULER` (Symbolic Math Toolbox), and `CATALAN` (Symbolic Math Toolbox) (cf. `Type::ConstantIdents`) and zero operands of expressions and subexpressions (i.e., the function names in unevaluated function calls such as `f(2)`, `sin(PI/13)` etc.). Also integration variables in unevaluated calls of `int`, `numeric::int` and `numeric::quadrature` and summation indices in unevaluated calls of `sum` and `numeric::sum` are not considered.

## Examples

### Example 1

Identifiers and indexed identifiers are regarded as indeterminates:

```
numeric::indets([{a + b*PI}, sin(c + sqrt(2) + EULER),  
                table(1 = d - cos(e), 2 = f + 0.1*I),  
                array(1..2, [g, h]), F(i[2], i[2]),  
                D([1], G)(j[1]), k[3 + L[4]])])
```

$$\{a, b, c, d, e, f, g, h, i_2, j_1, k_{L_4+3}\}$$

Both indeterminates as well as symbolic coefficients are considered in polynomials of domain type DOM\_POLY:

```
numeric::indets(poly(a[1]*x^2 + a[2]*x + a, [x, y]))
```

$$\{a, x, y, a_1, a_2\}$$

### Example 2

The zero operands of unevaluated function calls such as  $f(\dots)$  or  $\sin(\dots)$  are not regarded as indeterminates:

```
numeric::indets(f(a + sin(b)) + PI + EULER)
```

$$\{a, b\}$$

Integration variables and summation indices are not regarded as indeterminates:

```
numeric::indets({int(f(x), x = a..b),  
                sum(f(i), i = c..infinity)})
```

$$\{a, b, c\}$$

## Parameters

### **object**

An arbitrary MuPAD object

## Return Values

Set of indeterminates is returned, if the argument is an object of some basic data type of the kernel. The empty set is returned, if the object is from some library domain.

## See Also

### **MuPAD Functions**

freeIndets | indets

## numeric::int

Numerical integration (the Float attribute of Int )

### Syntax

```
numeric::int(f(x), x = a .. b, options)
float(holdint(f(x), x = a .. b, options))
float(freezeint(f(x), x = a .. b, options))
```

### Description

`numeric::int(f(x), x = a..b)` computes a numerical approximation of  $\int_a^b f(x) dx$ .

The calls `numeric::int(...)`, `float ( freeze(int)(...))`, and `float ( hold(int)(...))` are equivalent.

The calls `numeric::int(...)` and `numeric::quadrature(...)` are almost equivalent: `numeric::int` calls `numeric::quadrature`. A numerical result produced by `numeric::quadrature` is returned as is. Otherwise, `hold(numeric::int)(...)` is returned.

See the help page of `numeric::quadrature` for details.

### Environment Interactions

The function is sensitive to the environment variable `DIGITS`, which determines the numerical working precision.

## Examples

### Example 1

We demonstrate some equivalent calls for numerical integration:

```
numeric::int(exp(x^2), x = -1..1),
float(hold(int)(exp(x^2), x = -1..1)),
float(freeze(int)(exp(x^2), x = -1..1)),
numeric::quadrature(exp(x^2), x = -1..1)
```

2.925303492, 2.925303492, 2.925303492, 2.925303492

```
numeric::int(max(1/10, cos(PI*x)), x = -2..0.0123),
float(hold(int)(max(1/10, cos(PI*x)), x = -2..0.0123)),
float(freeze(int)(max(1/10, cos(PI*x)), x = -2..0.0123)),
numeric::quadrature(max(1/10, cos(PI*x)), x = -2..0.0123)
```

0.752102471, 0.752102471, 0.752102471, 0.752102471

```
numeric::int(exp(-x^2), x = -2..infinity),
float(hold(int)(exp(-x^2), x = -2..infinity)),
float(freeze(int)(exp(-x^2), x = -2..infinity)),
numeric::quadrature(exp(-x^2), x = -2..infinity)
```

1.768308316, 1.768308316, 1.768308316, 1.768308316

```
numeric::int(sin(x)/x, x = -1..10, GaussLegendre = 5),
float(hold(int)(sin(x)/x, x = -1..10, GaussLegendre = 5)),
float(freeze(int)(sin(x)/x, x = -1..10, GaussLegendre = 5)),
numeric::quadrature(sin(x)/x, x = -1..10, GaussLegendre = 5)
```

2.604430665, 2.604430665, 2.604430665, 2.604430665

The calls `numeric::int(...)`, `float(hold(int)(...))`, and `numeric::quadrature(...)` are equivalent in multiple numerical integrations, too:

```
numeric::int(numeric::int(x*y, x = 0..y), y = 0..1),
numeric::int(numeric::quadrature(x*y, x = 0..y), y = 0..1),
```

```
float(freeze(int)(numeric::int(x*y, x = 0..y), y = 0..1)),  
float(hold(int)(numeric::quadrature(x*y, x = 0..y), y = 0..1)),  
numeric::quadrature(numeric::int(x*y, x = 0..y), y = 0..1),  
numeric::quadrature(numeric::quadrature(x*y, x = 0..y), y = 0..1)
```

0.125, 0.125, 0.125, 0.125, 0.125, 0.125

## Example 2

The following integral do not exist. Consequently, numerical integration runs into problems:

```
numeric::quadrature(1/x, x = 0..infinity)
```

Warning: Precision goal not achieved after 10000 function calls. Increase 'MaxCalls' and

FAIL

Note that `numeric::int` handles errors produced by `numeric::quadrature` and returns a symbolic call to `numeric::int`:

```
numeric::int(1/x, x = 0..infinity)
```

$\text{numeric::int}\left(\frac{1}{x}, x = 0..∞\right)$

## Parameters

**f(x)**

An arithmetical expression (Symbolic Math Toolbox) in  $x$

**x**

An identifier on page 7-29 or an indexed identifier on page 1-1017

**a, b**

arithmetical expressions (Symbolic Math Toolbox)

## Options

All options of `numeric::quadrature` can be used.

## Return Values

Floating point number or a symbolic call `numeric::int(f(x), x = a..b)` if the integral cannot be evaluated numerically.

## See Also

### MuPAD Functions

`int` | `numeric::quadrature`

## Topics

“Integration” (Symbolic Math Toolbox)

## numeric::inverse

Inverse of a matrix

### Syntax

```
numeric::inverse(A, options)
```

### Description

`numeric::inverse(A)` returns the inverse of the matrix `A`.

If no return type is specified via the option `ReturnType = t`, the domain type of the inverse depends on the type of the input matrix `A`:

- The inverse of an array on page 7-2 is returned as an array on page 7-2.
- The inverse of an `hfarray` on page 7-27 is returned as an `hfarray` on page 7-27.
- The inverse of a dense matrix of type `Dom::DenseMatrix()` is a dense matrix of type `Dom::DenseMatrix()` over the ring of MuPAD expressions.
- For all other matrices of category `Cat::Matrix`, the inverse is returned as a `matrix` of type `Dom::Matrix()` over the ring of MuPAD expressions. This includes input matrices `A` of type `Dom::Matrix(...)`, `Dom::SquareMatrix(...)`, `Dom::MatrixGroup(...)` etc.

The option `Symbolic` should be used if the matrix contains symbolic objects that cannot be converted to floating point numbers.

Without the option `Symbolic`, all entries of `A` must be numerical. Floating point arithmetic is used, the working precision is set by the environment variable `DIGITS`.

Exact numerical expressions such as  $\pi + \sqrt{2}$ , `sin(3)` etc. are accepted and converted to floats. If symbolic entries are found in the matrix, `numeric::inverse` automatically switches to `Symbolic`, issuing a warning. This warning may be suppressed via the option `NoWarning`.



---

**Note** Invertibility of the matrix can only be safely detected with exact arithmetic, i.e., using the option `Symbolic`. See “Example 2” on page 19-142 (Symbolic Math Toolbox).

---

**Note** Matrices `A` of a matrix domain such as `Dom::Matrix(..)` or `Dom::SquareMatrix(..)` are internally converted to arrays over expressions via `expr(A)`. Note that `Symbolic` should be used if the entries cannot be converted to numerical expressions.

Note that `1/A` must be used, when the inverse is to be computed over the component domain. See “Example 3” on page 19-145 (Symbolic Math Toolbox).

---

We recommend to use `numeric::linsolve` or `numeric::matlinsolve` if a sparse system of linear equations is to be solved. In particular, these routines are more efficient than `numeric::inverse` for large sparse systems.

`numeric::linsolve` uses sparse input and output via symbolic equations and features internal sparse arithmetic.

Alternatively, sparse matrices of domain type `Dom::Matrix()` may be used with `numeric::matlinsolve`.

## Environment Interactions

Without the option `Symbolic`, the function is sensitive to the environment variable `DIGITS`, which determines the numerical working precision.

## Examples

### Example 1

Numerical matrices can be processed with or without the option `Symbolic`. In the following, the inverses are returned as arrays because the input matrix is an array:

```
A := array(1..2, 1..2, [[1, 2], [3, PI]]):  
numeric::inverse(A), numeric::inverse(A, Symbolic)
```

$$\begin{pmatrix} -1.099071012 & 0.6996903372 \\ 1.049535506 & -0.3498451686 \end{pmatrix}, \begin{pmatrix} \frac{\pi}{\pi-6} & -\frac{2}{\pi-6} \\ -\frac{3}{\pi-6} & \frac{1}{\pi-6} \end{pmatrix}$$

Matrices of category `Cat::Matrix` are accepted. The inverse is returned as a corresponding matrix:

```
A := Dom::Matrix()([[2, PI], [0, 1]]):  
numeric::inverse(A); domtype(%)
```

$$\begin{pmatrix} 0.5 & -1.570796327 \\ 0 & 1.0 \end{pmatrix}$$

```
Dom::Matrix()
```

```
delete A:
```

## Example 2

The following matrix is not invertible:

```
A := linalg::hilbert(6):  
A[6,6] := 5773/63504:  
A
```

$$\begin{pmatrix} 1 & \frac{1}{2} & \frac{1}{3} & \frac{1}{4} & \frac{1}{5} & \frac{1}{6} \\ \frac{1}{2} & \frac{1}{3} & \frac{1}{4} & \frac{1}{5} & \frac{1}{6} & \frac{1}{7} \\ \frac{1}{3} & \frac{1}{4} & \frac{1}{5} & \frac{1}{6} & \frac{1}{7} & \frac{1}{8} \\ \frac{1}{4} & \frac{1}{5} & \frac{1}{6} & \frac{1}{7} & \frac{1}{8} & \frac{1}{9} \\ \frac{1}{5} & \frac{1}{6} & \frac{1}{7} & \frac{1}{8} & \frac{1}{9} & \frac{1}{10} \\ \frac{1}{6} & \frac{1}{7} & \frac{1}{8} & \frac{1}{9} & \frac{1}{10} & \frac{5773}{63504} \end{pmatrix}$$

With exact arithmetic, `numeric::inverse` detects this fact:

```
numeric::det(A, Symbolic), numeric::inverse(A, Symbolic)
```

**0, FAIL**

Due to internal round-off, the matrix is regarded as invertible if float arithmetic is used:

```
numeric::det(A, HardwareFloats), numeric::inverse(A, HardwareFloats);
```

$$\begin{aligned} & -3.239912837 \cdot 10^{-28}, [[-1.339975706 \cdot 10^{11}, 4.019927119 \cdot 10^{12}, \sigma_2, 7.503863956 \cdot 10^{13}, \sigma_4, \\ & 3.37673878 \cdot 10^{13}], \\ & [4.019927119 \cdot 10^{12}, -1.205978136 \cdot 10^{14}, 8.441846951 \cdot 10^{14}, \sigma_3, 2.532554085 \cdot 10^{15}, \sigma_5], \\ & [\sigma_2, 8.441846951 \cdot 10^{14}, -5.909292865 \cdot 10^{15}, 1.575811431 \cdot 10^{16}, \sigma_1, 7.091151439 \cdot 10^{15}], \\ & [7.503863956 \cdot 10^{13}, \sigma_3, 1.575811431 \cdot 10^{16}, -4.202163815 \cdot 10^{16}, 4.727434292 \cdot 10^{16}, \sigma_6], \\ & [\sigma_4, 2.532554085 \cdot 10^{15}, \sigma_1, 4.727434292 \cdot 10^{16}, -5.318363579 \cdot 10^{16}, 2.127345432 \cdot 10^{16}], \\ & [3.37673878 \cdot 10^{13}, \sigma_5, 7.091151439 \cdot 10^{15}, \sigma_6, 2.127345432 \cdot 10^{16}, -8.509381726 \cdot 10^{15}]] \end{aligned}$$

where

$$\sigma_1 = -1.77278786 \cdot 10^{16}$$

$$\sigma_2 = -2.813948983 \cdot 10^{13}$$

$$\sigma_3 = -2.251159187 \cdot 10^{15}$$

$$\sigma_4 = -8.441846951 \cdot 10^{13}$$

$$\sigma_5 = -1.013021634 \cdot 10^{15}$$

$$\sigma_6 = -1.890973717 \cdot 10^{16}$$

With SoftwareFloats, the internal rounding is slightly different and the kernel of the matrix is detected:

```
numeric::det(A, SoftwareFloats), numeric::inverse(A, SoftwareFloats)
```

$-3.731550906 \cdot 10^{-30}$ , FAIL

delete A:

### Example 3

The following matrix has domain components:

```
A := Dom::Matrix(Dom::IntegerMod(7))([[6, -1], [1, 6]])
```

$$\begin{pmatrix} 6 \bmod 7 & 6 \bmod 7 \\ 1 \bmod 7 & 6 \bmod 7 \end{pmatrix}$$

Note that `numeric::inverse` computes the inverse of the following matrix:

```
expr(A), numeric::inverse(A)
```

$$\begin{pmatrix} 6 & 6 \\ 1 & 6 \end{pmatrix}, \begin{pmatrix} 0.2 & -0.2 \\ -0.033333333333 & 0.2 \end{pmatrix}$$

The overloaded arithmetic should be used if the inverse is to be computed over the component domain `Dom::IntegerMod(7)`:

```
1/A
```

$$\begin{pmatrix} 3 \bmod 7 & 4 \bmod 7 \\ 3 \bmod 7 & 3 \bmod 7 \end{pmatrix}$$

delete A:

### Example 4

The option `Symbolic` should not be used for float matrices because no internal pivoting is used to stabilize the numerical algorithm:

```
A := matrix([[1.0/10^20, 1.0], [1.0, 1.0]]):  
bad = numeric::inverse(A, Symbolic),  
good = numeric::inverse(A)
```

$$\text{bad} = \begin{pmatrix} 0 & 1.0 \\ 1.0 & -1.0 \cdot 10^{-20} \end{pmatrix}, \text{good} = \begin{pmatrix} -1.0 & 1.0 \\ 1.0 & -1.0 \cdot 10^{-20} \end{pmatrix}$$

```
delete A:
```

## Example 5

We demonstrate the use of hardware floats. Hilbert matrices on page 15-93 are notoriously ill-conditioned and difficult to invert with low values of DIGITS. The following results, both with `HardwareFloats` as well as with `SoftwareFloats`, are marred by numerical round-off. Consequently, the inverses with and without hardware floats, respectively, differ significantly:

```
A := linalg::hilbert(10):  
DIGITS := 10:  
B1 := numeric::inverse(A, HardwareFloats):  
B2 := numeric::inverse(A, SoftwareFloats):  
B1[8, 8] <> B2[8, 8]
```

$$3.267405722 \cdot 10^{12} \neq 3.26785917 \cdot 10^{12}$$

```
norm(B1 - B2)
```

```
1681640193.0
```

```
delete A, B1, B2:
```

## Parameters

### A

A square matrix of domain type (Symbolic Math Toolbox) `DOM_ARRAY`, `DOM_HFARRAY`, or of category `Cat::Matrix`

## Options

### Hard, HardwareFloats, Soft, SoftwareFloats

With **Hard** (or **HardwareFloats**), computations are done using fast hardware float arithmetic from within a MuPAD session. **Hard** and **HardwareFloats** are equivalent. With this option, the input data are converted to hardware floats and processed by compiled C code. The result is reconverted to MuPAD floats and returned to the MuPAD session.

With **Soft** (or **SoftwareFloats**) computations are done using software float arithmetic provided by the MuPAD kernel. **Soft** and **SoftwareFloats** are equivalent. **SoftwareFloats** is used by default if the current value of **DIGITS** is larger than 15 and the input matrix **A** is not of domain type **DOM\_HFARRAY**.

Compared to the **SoftwareFloats** used by the MuPAD kernel, the computation with **HardwareFloats** may be many times faster. Note, however, that the precision of hardware arithmetic is limited to about 15 digits. Further, the size of floating-point numbers may not be larger than approximately  $10^{308}$  and not smaller than approximately  $10^{-308}$ .

If no **HardwareFloats** or **SoftwareFloats** are requested explicitly, the following strategy is used: If the current value of **DIGITS** is smaller than 16 or if the matrix **A** is a hardware float array of domain type **DOM\_HFARRAY**, then hardware arithmetic is tried. If this is successful, the result is returned.

If the result cannot be computed with hardware floats, software arithmetic by the MuPAD kernel is tried.

If the current value of **DIGITS** is larger than 15 and the input matrix **A** is not of domain type **DOM\_HFARRAY**, or if one of the options **Soft**, **SoftwareFloats** or **Symbolic** is specified, MuPAD computes the result with its software arithmetic without trying to use hardware floats first.

There may be several reasons for hardware arithmetic to fail:

- The current value of **DIGITS** is larger than 15.
- The data contains symbolic objects.
- The data contains numbers larger than  $10^{308}$  or smaller than  $10^{-308}$  that cannot be represented by hardware floats.

If neither `HardwareFloats` nor `SoftwareFloats` is specified, the user is not informed whether hardware floats or software floats are used.

If `HardwareFloats` are specified but fail due to one of the reasons above, a warning is issued that the (much slower) software floating-point arithmetic of the MuPAD kernel is used.

Note that `HardwareFloats` can only be used if all input data can be converted to floating-point numbers.

The trailing digits in floating-point results computed with `HardwareFloats` and `SoftwareFloats` may differ.

---

**Note** For ill-conditioned matrices, the result is subject to round-off errors. The results returned with `HardwareFloats` and `SoftwareFloats` may differ! See “Example 2” on page 19-142 (Symbolic Math Toolbox) and “Example 5” on page 19-146 (Symbolic Math Toolbox).

---

### **Symbolic**

Prevents the conversion of the input data to floating-point numbers. Exact arithmetic is used. This option overrides `HardwareFloats` and `SoftwareFloats`.

This option prevents conversion of the input data to floats. With this option, symbolic entries are accepted.

---

**Note** This option should not be used for floating-point matrices! No internal pivoting is used, unless necessary. Consequently, numerical instabilities may occur in floating-point operations. See “Example 4” on page 19-145 (Symbolic Math Toolbox).

---

### **NoWarning**

Without the option `Symbolic`, `numeric::inverse` automatically switches to the `Symbolic` mode with a warning if symbolic coefficients are found. With the option `NoWarning`, this warning is suppressed. Note, however, that `numeric::inverse` still uses the symbolic mode for symbolic coefficients, i.e., exact arithmetic without floating-point conversions is used.



## ReturnType

Option, specified as `ReturnType = t`

Return the inverse as a matrix of domain type (Symbolic Math Toolbox) `t`. The following return types are available: `DOM_ARRAY`, `DOM_HFARRAY`, `Dom::Matrix()`, or `Dom::DenseMatrix()`.

## Return Values

Depending on the type of the input matrix `A`, the inverse is returned as a matrix of domain type `DOM_ARRAY`, `DOM_HFARRAY`, `Dom::Matrix()`, or `Dom::DenseMatrix()`. `FAIL` is returned if the inverse cannot be computed.

## Algorithms

Gaussian elimination with partial pivoting is used. Partial pivoting is switched off by the option `Symbolic`.

## See Also

### MuPAD Functions

`linalg::matlinsolve` | `linsolve` | `numeric::linsolve` | `numeric::matlinsolve` | `solve`

## numeric::leastSquares

Least squares solution of linear equations

### Syntax

`numeric::leastSquares(A, B, <mode>, <method>, options)`

### Description

`numeric::leastSquares(A, B)` computes a matrix  $X$  that solves the linear matrix equation  $AX = B$  in the least squares sense: the columns  $X_j$  of  $X$  minimize  $\|AX_j - B_j\|_2$  where the  $B_j$  are the columns of  $B$ .

For a given vector  $B$ , a vector  $X$  minimizes  $\|AX - B\|_2$  if and only if  $X$  is a solution of the “normal equations”  $A^HAX = A^HB$ , where  $A^H$  is the Hermitian transpose of the  $m \times n$  matrix  $A$ . The solution is unique if  $\text{rank}(A) = n$ .

`numeric::leastSquares` allows to solve several least squares problems simultaneously by combining several ‘right hand sides’  $B_j$  columnwise to a matrix  $B$ .

If no return type is specified via the option `ReturnType = d`, the domain type of the return data depends on the type of the input matrix  $A$ :

- The special solution  $X$  as well as the kernel of an array on page 7-2  $A$  are returned as arrays on page 7-2.
- The special solution and the kernel of an harray on page 7-27 of domain type `DOM_HFARRAY` are returned as hfarrays on page 7-2.
- For a dense matrix on page 1-506  $A$  of type `Dom::DenseMatrix()`, both the special solution  $X$  as well as the kernel are returned as matrices of type `Dom::DenseMatrix()` over the ring of MuPAD expressions.
- For all other matrices of category `Cat::Matrix`, both the special solution  $X$  as well as the kernel are returned as matrices on page 1-1340 of type `Dom::Matrix()` over the ring of MuPAD expressions. This includes input matrices  $A$  of type `Dom::Matrix(...)`, `Dom::SquareMatrix(...)`, `Dom::MatrixGroup(...)` etc.

Without `Symbolic`, the input data are converted to floating-point numbers. The matrix  $A$  must not contain non-convertible parameters, unless `Symbolic` is used. If such objects are found, `numeric::leastSquares` automatically switches to its symbolic mode, issuing a warning. This warning may be suppressed via `NoWarning`.

Symbolic parameters in  $B$  are accepted without warning. However, `HardwareFloats` cannot be used if there are any symbolic parameters in  $A$  or  $B$ .

If  $A^H A$  has a non-trivial kernel, the least squares solution  $X$  is not unique. The return value  $X$  is a *special* solution of the equation  $A^H A X = A^H B$ . With the SVD method,  $X$  is the special solution with columns of minimal Euclidean length.

---

**Note** The result computed with `HardwareFloats` may differ from the solution computed with `SoftwareFloats` or `Symbolic`! In particular, this is the case for systems with a non-trivial kernel. Further, the results computed with QRD and SVD may differ.

---

The kernel is computed only in the symbolic mode (option `Symbolic`). All floating-point methods return the value `NIL` for the kernel.

With `Symbolic`, the  $n \times d$  matrix `KernelBasis` is the most general solution of  $A^H A X = 0$ . Its columns span the  $d$ -dimensional kernel of  $A^H A$ .

If the kernel is 0-dimensional, the return value of `KernelBasis` is the integer 0. If `KernelBasis` is returned as an array on page 7-2, the dimension  $d$  of the kernel is `d = op(KernelBasis, [0, 3, 2])`. If `KernelBasis` is returned as a matrix of type `Dom::Matrix()` or `Dom::DenseMatrix()`, the dimension  $d$  of the kernel is `d = KernelBasis::dom::matdim(KernelBasis)[2]`.

---

**Note** Without the option `Symbolic`, the implemented algorithms take care of numerical stabilization.

With `Symbolic`, exact data are assumed. The least squares solutions is computed via `numeric::matlinsolve( A^H A, A^H B, Symbolic)`. The symbolic strategy tries to maximize speed and does not take care of numerical stabilization! Do not use `Symbolic` for systems involving floating-point entries! In particular, due to round-off, it may happen that no solution of  $A^H A X = A^H B$  is found. In such a case, `[FAIL, NIL, NIL]` is returned. Cf. "Example 4" on page 19-155 (Symbolic Math Toolbox).

---

All entries of  $A$  and  $B$  must be arithmetical expressions (Symbolic Math Toolbox).

**Note** Apart from matrices of type `Dom::Matrix(...)`, `Cat::Matrix` objects `A` from matrix domains such as `Dom::DenseMatrix(...)` or `Dom::SquareMatrix(...)` are internally converted to arrays over expressions via `expr(A)`. Note that the option `Symbolic` should be used if the entries cannot be converted to numerical expressions.

The same holds true for matrices `B` passed as `Cat::Matrix` objects.

---

## Environment Interactions

The function is sensitive to the environment variable `DIGITS`, which determines the numerical working precision.

## Examples

### Example 1

We consider a matrix `A` of rank 1:

```
A := array(1..3, 1..2, [[1, 2], [1, 2], [1, 2]]):  
B := [3, 4, 5]:
```

The normal equations have a 1-parameter set of solutions:

```
[X, KernelBasis, Res] := numeric::leastSquares(A, B, Symbolic)
```

$$\left[ \begin{pmatrix} 4 \\ 0 \end{pmatrix}, \begin{pmatrix} -2 \\ 1 \end{pmatrix}, [\sqrt{2}] \right]$$

The numerical method `QRD` produces a special solution:

```
[X, KernelBasis, Res] := numeric::leastSquares(A, B, QRD)
```

$$\left[ \begin{pmatrix} 4.0 \\ 0 \end{pmatrix}, \text{NIL}, [1.414213562] \right]$$

The numerical method `SVD` produces a solution `X` of minimal norm:

```
[X, KernelBasis, Res] := numeric::leastSquares(A, B, SVD)
```

$$\left[ \begin{pmatrix} 0.8 \\ 1.6 \end{pmatrix}, \text{NIL}, [1.414213562] \right]$$

```
delete A, B, X, KernelBasis, Res:
```

## Example 2

We consider an ill-conditioned least squares problem. By construction, the following overdetermined system has an exact solution  $X = [1, 2, \dots, n]$ :

```
m := 10: n := 8:
A := array(1..m, 1..n, [[1/(i + j + 100) $ j=1..n] $ i=1..m]):
B := array(1..m, [_plus(A[i,j]*j $ j=1..n) $ i=1..m]):
numeric::leastSquares(A, B, Symbolic)
```

$$\left[ \begin{pmatrix} 1 \\ 2 \\ 3 \\ 4 \\ 5 \\ 6 \\ 7 \\ 8 \end{pmatrix}, 0, [0] \right]$$

The coefficient matrix  $A$  is rather ill-conditioned:

```
singvals := numeric::singularvalues(A):
conditionOfA := max(op(singvals))/min(op(singvals))
```

$$6.31539107 \cdot 10^{16}$$

Consequently, round-off has a drastic effect in a numerical approximation. The methods yield results of different quality:

```
numeric::leastSquares(A, B, QRD)
```

$$\left[ \begin{pmatrix} 205.7634088 \\ -506.7540812 \\ 336.9881724 \\ 0 \\ 0 \\ 0 \\ 0 \\ 0 \end{pmatrix}, \text{NIL}, [0.000000007174860922] \right]$$

```
numeric::leastSquares(A, B, SVD)
```

$$\left[ \begin{pmatrix} 44440.34961 \\ -36432.38255 \\ -44826.69677 \\ -14839.48585 \\ 23895.8882 \\ 45730.9635 \\ 28571.67227 \\ -46506.25357 \end{pmatrix}, \text{NIL}, [0.0000007416898216] \right]$$

```
delete m, n, A, B, singvals, conditionOfA:
```

### Example 3

This example involves a symbolic parameter  $c$  in the matrix  $A$ . The option `Symbolic` must be used:

```
A:= matrix([[c, 2], [1/3, 2/3], [1/7, 2/7]]):  
B:= [1, 2, 3]:  
numeric::leastSquares(A, B, Symbolic)
```

$$\left[ \left( \begin{array}{c} -\frac{425}{58(c-1)} \\ \frac{483c-58}{116(c-1)} \end{array} \right), 0, \left[ \text{sqrt} \left( \left| \frac{425c}{58(c-1)} - \frac{483c-58}{58(c-1)} + 1 \right|^2 + \left| \frac{425}{174(c-1)} - \frac{483c-58}{174(c-1)} + 2 \right|^2 + \left| \frac{425}{406(c-1)} - \frac{483c-58}{406(c-1)} + 3 \right|^2 \right) \right] \right]$$

normal(%)

$$\left[ \left( \begin{array}{c} -\frac{425}{58(c-1)} \\ \frac{483c-58}{116(c-1)} \end{array} \right), 0, \left[ \frac{15\sqrt{58}}{58} \right] \right]$$

delete A, B:

## Example 4

Floating point entries may cause problems in conjunction with the option `Symbolic`, because the computation is not stabilized numerically in the symbolic node. The following matrix `A` has rank 2:

```
A := matrix([[1, 30], [10.0^(-15), 31*10.0^(-15)]]):
```

However, due to round-off, the 'normal matrix'  $A^H A$  has rank 1. No solution is found with `Symbolic`:

```
A::dom::transpose(A) * A
```

$$\begin{pmatrix} 1.0 & 30.0 \\ 30.0 & 900.0 \end{pmatrix}$$

```
numeric::leastSquares(A, [31, 32*10^5], Symbolic)
```

```
[FAIL, NIL, NIL]
```

No such problem arises in the numerical schemes. Note, however, that the numerical methods yield different results in this extremely ill-conditioned problem:

```
numeric::leastSquares(A, [31, 32*10^5], QRD)
```

$$\left[ \left( \begin{array}{c} -9.6 \cdot 10^{22} \\ 3.2 \cdot 10^{21} \end{array} \right), \text{NIL}, [31.0] \right]$$

```
numeric::leastSquares(A, [31, 32*10^5], SVD)
```

$$\left[ \left( \begin{array}{c} 0.03440621532 \\ 1.03218646 \end{array} \right), \text{NIL}, [3200000.0] \right]$$

```
delete A:
```

## Parameters

### A

An  $m \times n$  matrix of domain type (Symbolic Math Toolbox) `DOM_ARRAY` or of category `Cat::Matrix`

### B

An  $m \times p$  matrix of domain type `DOM_ARRAY` or of category `Cat::Matrix`. Column vectors `B` may also be represented by a 1-dimensional array(`1..m, [B1, B2, ...]`) or by a list `[B1, B2, ...]`.

### mode

One of the flags `Hard`, `HardwareFloats`, `Soft`, `SoftwareFloats`, or `Symbolic`

### method

One of the flags `QRD`, `SVD`



## Options

### Hard, HardwareFloats, Soft, SoftwareFloats

With **Hard** (or **HardwareFloats**), computations are done using fast hardware float arithmetic from within a MuPAD session. **Hard** and **HardwareFloats** are equivalent. With this option, the input data are converted to hardware floats and processed by compiled C code. The result is reconverted to MuPAD floats and returned to the MuPAD session.

With **Soft** (or **SoftwareFloats**) computations are done using software float arithmetic provided by the MuPAD kernel. **Soft** and **SoftwareFloats** are equivalent. **SoftwareFloats** is used by default if the current value of **DIGITS** is larger than 15 and the input matrix **A** is not of domain type **DOM\_HFARRAY**.

Compared to the **SoftwareFloats** used by the MuPAD kernel, the computation with **HardwareFloats** may be many times faster. Note, however, that the precision of hardware arithmetic is limited to about 15 digits. Further, the size of floating-point numbers may not be larger than approximately  $10^{308}$  and not smaller than approximately  $10^{-308}$ .

If no **HardwareFloats** or **SoftwareFloats** are requested explicitly, the following strategy is used: If the current value of **DIGITS** is smaller than 16 or if the matrix **A** is a hardware float array of domain type **DOM\_HFARRAY**, then hardware arithmetic is tried. If this is successful, the result is returned.

If the result cannot be computed with hardware floats, software arithmetic by the MuPAD kernel is tried.

If the current value of **DIGITS** is larger than 15 and the input matrix **A** is not of domain type **DOM\_HFARRAY**, or if one of the options **Soft**, **SoftwareFloats** or **Symbolic** is specified, MuPAD computes the result with its software arithmetic without trying to use hardware floats first.

There may be several reasons for hardware arithmetic to fail:

- The current value of **DIGITS** is larger than 15.
- The data contains symbolic objects.
- The data contains numbers larger than  $10^{308}$  or smaller than  $10^{-308}$  that cannot be represented by hardware floats.

If neither `HardwareFloats` nor `SoftwareFloats` is specified, the user is not informed whether hardware floats or software floats are used.

If `HardwareFloats` are specified but fail due to one of the reasons above, a warning is issued that the (much slower) software floating-point arithmetic of the MuPAD kernel is used.

Note that `HardwareFloats` can only be used if all input data can be converted to floating-point numbers.

The trailing digits in floating-point results computed with `HardwareFloats` and `SoftwareFloats` may differ.

### **Symbolic**

Prevents the conversion of the input data to floating-point numbers. Exact arithmetic is used. This option overrides `HardwareFloats` and `SoftwareFloats`.

This option *must* be used, if the matrix  $A$  contains symbolic parameters that cannot be converted to floating-point numbers.

The normal equations  $A^H A X = A^H B$  are passed to `numeric::matlinsolve` with the option `Symbolic`.

If the least squares problem does not have a unique solution, a special solution  $X$  is returned together with the kernel of  $A^H A$ . Cf. "Example 1" on page 19-152 (Symbolic Math Toolbox).

---

**Note** This option should not be used for systems with floating-point coefficients! Numerical instabilities may occur in floating-point operations. Further, if the rank of  $A$  is not maximal, then `numeric::leastSquares` may fail to find a solution due to numerical round-off. In such a case, `[FAIL, NIL, NIL]` is returned. Cf. "Example 4" on page 19-155 (Symbolic Math Toolbox).

---

### **QRD**

Use a QR decomposition on page 19-81. All entries of  $A$  must be convertible to floating-point values.

This is the default method.

The matrix  $A$  must not contain symbolic parameters that cannot be converted to floating point numbers. If such objects are found, then `numeric::leastSquares` automatically switches to its `Symbolic` mode, issuing a warning. The computation proceeds with exact arithmetic, using the input data without floating-point conversions.

The warning may be suppressed by the option `NoWarning`.

Symbolic parameters in  $B$  are accepted without warning. They are processed by the floating-point algorithm.

Numerical expressions such as  $e^{\pi}$ ,  $\sqrt{2}$  etc. are accepted and converted to floats.

If the least squares problem does not have a unique solution, only a special solution is returned. The kernel is not computed: it is returned as `NIL`.

The method `QRD` provides a numerically stable way of solving the normal equations  $A^H A X = A^H B$  by a QR decomposition on page 19-81. In extremely ill-conditioned situations, it may be worthwhile to consider the slower, yet more stable method `SVD`.

The conditioning is given by the ratio of the largest singular value on page 19-317 of  $A$  divided by the smallest singular value of  $A$ . If this value is large, the problem is ill-conditioned.

Cf. "Example 2" on page 19-153 (Symbolic Math Toolbox).

## **SVD**

Use a singular value decomposition on page 19-323. All entries of  $A$  must be convertible to floating-point values.

The matrix  $A$  must not contain symbolic parameters that cannot be converted to floating point numbers. If such objects are found, then `numeric::leastSquares` automatically switches to its `symbolic` mode, issuing a warning. The computation proceeds with exact arithmetic, using the input data without floating point conversions.

The warning may be suppressed by the option `NoWarning`.

Symbolic parameters in  $B$  are accepted without warning. They are processed by the floating-point algorithm.

Numerical expressions such as  $e^{\pi}$ ,  $\sqrt{2}$  etc. are accepted and converted to floats.

If the least squares problem does not have a unique solution, the columns  $X_j$  of the solution  $X$  have a minimal Euclidean length  $\|X_j\|_2$ .

The kernel is not computed: it is returned as NIL.

A singular value decomposition on page 19-323  $A = U D V^H$  is used to solve the normal equations in the form  $D^2 V^H X = D U^H B$ . For small or zero singular values  $d_j$  in  $D = \text{diag}(d_1, d_2, \dots)$ , the corresponding components of  $V^H x$  are set to zero.

Usually, the numerical method SVD is slower than the default method QRD. However, in ill-conditioned situations, it is numerically more stable.

The conditioning is given by the ratio of the largest singular value on page 19-317 of  $A$  divided by the smallest singular value of  $A$ . If this value is large, the problem is ill-conditioned.

### **NoWarning**

Suppresses warnings

If symbolic coefficients are found in  $A$ , `numeric::leastSquares` automatically switches to the `Symbolic` mode with a warning. With this option, this warning is suppressed.

### **ReturnType**

Option, specified as `ReturnType = d`

Return the (special) solution and the kernel as matrices of domain type (Symbolic Math Toolbox)  $d$ . The following return types  $d$  are available: `DOM_ARRAY`, or `DOM_HFARRAY`, `Dom::Matrix()`, or `Dom::DenseMatrix()`.

## **Return Values**

A list `[X, KernelBasis, Residues]` is returned.

The (special) least squares solution  $X$  is an  $n \times p$  matrix.

With `Symbolic`, `KernelBasis` is an  $n \times d$  matrix ( $d$  is the dimension of the kernel of  $A^H A$ ). Its columns span the kernel of  $A^H A$ . If the kernel is trivial, `KernelBasis` is the integer 0.

Without `Symbolic`, the kernel is not computed. The value `NIL` is returned for the `KernelBasis`.

The list of arithmetical expressions (Symbolic Math Toolbox) `Residues` consists of the minimized least squares deviations  $\|A X_j - B_j\|_2$  corresponding to the columns of `X` and `B`.

## See Also

### MuPAD Functions

`numeric::factorQR` | `numeric::linsolve` | `numeric::matlinsolve` |  
`numeric::singularvalues` | `numeric::singularvectors`

## numeric::linsolve

Solve a system of linear equations

### Syntax

```
numeric::linsolve(eqs, <vars>, options)
```

### Description

`numeric::linsolve(eqs, vars)` solves a system of linear equations `eqs` for the unknowns `vars`.

`numeric::linsolve` is a fast numerical linear solver. It is also a recommended solver for linear systems with exact or symbolic coefficients (using `Symbolic`).

Expressions are interpreted as homogeneous equations. E.g., the input `[x = y - 1, x - y]` is interpreted as the system of equations `[x = y - 1, x - y = 0]`.

---

**Note** Without the option `Symbolic`, the input data are converted to floating-point numbers. The coefficient matrix  $A$  of the system  $Ax = b$  represented by `eqs` must not contain non-convertible parameters, unless the option `Symbolic` is used! If such objects are found, then `numeric::linsolve` automatically switches to its symbolic mode, issuing a warning. This warning may be suppressed via `NoWarning`. Symbolic parameters in the “right hand side”  $b$  are accepted without warning.

---

The numerical working precision is set by the environment variable `DIGITS`.

The solutions are returned as a list of solved equations of the form

$$[x_1 = \text{value}_1, x_2 = \text{value}_2, \dots],$$

where  $x_1, x_2, \dots$  are the unknowns. These simplified equations should be regarded as constraints on the unknowns. E.g., if an unknown  $x_1$ , say, does not turn up in the form `[x1 = ..., ...]` in the solution, then there is no constraint on this unknown; it is an arbitrary

parameter. Generally, all unknowns that do not turn up on the left hand side of the solved equations are arbitrary parameters spanning the solution space. Cf. “Example 9” on page 19-171 (Symbolic Math Toolbox).

In particular, if the empty list is returned as the solution, there are no constraints whatsoever on the unknowns, i.e., the system is trivial.

The ordering of the solved equations corresponds to the ordering of the unknowns `vars`. It is recommended that the user specifies `vars` by a *a list* of unknowns. This guarantees that the solved equations are returned in the expected order. If `vars` are specified by a set, or if no `vars` are specified at all, then an internal ordering is used.

If no unknowns are specified by `vars`, `numeric::linsolve` solves for all symbolic objects in `eqs`. The unknowns are determined internally by `indets(eqs, PolyExpr)`.

`numeric::linsolve` returns the general solution of the system `eqs`. It is valid for arbitrary complex values of the symbolic parameters which may be present in `eqs`. If no such solution exists, `FAIL` is returned. Solutions that are valid only for special values of the symbolic parameters may be obtained with the option `ShowAssumptions`. See “Example 2” on page 19-165 (Symbolic Math Toolbox), “Example 3” on page 19-166 (Symbolic Math Toolbox), “Example 4” on page 19-166 (Symbolic Math Toolbox), and “Example 11” on page 19-173 (Symbolic Math Toolbox).

The solved equations representing the solution are suitable as input for `assign` and `subs`. See “Example 8” on page 19-171 (Symbolic Math Toolbox).

`numeric::linsolve` is suitable for solving large sparse systems. See “Example 6” on page 19-168 (Symbolic Math Toolbox).

If `eqs` represents a system with a banded coefficient matrix, then this is detected and used by `numeric::linsolve`. Note that in this case, it is important to specify both the equations as well as the unknowns by lists to guarantee the desired form of the coefficient matrix. When using sets, the data may be reordered internally leading to a loss of band structure and, consequently, of efficiency. See “Example 6” on page 19-168 (Symbolic Math Toolbox).

---

**Note** `numeric::linsolve` is tuned for speed. For this reason, it does not check systematically that the equations `eqs` are indeed linear in the unknowns! For non-linear equations, strange things may happen; `numeric::linsolve` might even return wrong results! See “Example 5” on page 19-167 (Symbolic Math Toolbox).

---

---

**Note** `numeric::linsolve` does not react to any properties of the unknowns or of symbolic parameters that are set via `assume`.

---

---

**Note** Gaussian elimination with partial pivoting is used. Without the option `Symbolic`, floating-point arithmetic is used and the pivoting strategy takes care of numerical stabilization. With `Symbolic`, exact data are assumed and the pivoting strategy tries to maximize speed, not taking care of numerical stabilization! See “Example 7” on page 19-170 (Symbolic Math Toolbox).

---

## Environment Interactions

Without the option `Symbolic`, the function is sensitive to the environment variable `DIGITS`, which determines the numerical working precision.

## Examples

### Example 1

Equations and variables may be entered as sets or lists:

```
numeric::linsolve({x = y - 1, x + y = z}, {x, y});  
numeric::linsolve([x = y - 1, x + y = z], {x, y});  
numeric::linsolve({x = y - 1, x + y = z}, [x, y]);  
numeric::linsolve([x = y - 1, x + y = z], [x, y])
```

$[x = 0.5 z - 0.5, y = 0.5 z + 0.5]$

$[x = 0.5 z - 0.5, y = 0.5 z + 0.5]$

$[x = 0.5 z - 0.5, y = 0.5 z + 0.5]$

$[x = 0.5 z - 0.5, y = 0.5 z + 0.5]$



With the option `Symbolic`, exact arithmetic is used. The following system has a 1-parameter set of solution; the unknown  $x_3$  is arbitrary:

```
numeric::linsolve([x[1] + x[2] = 2, x[1] - x[2] = 2*x[3]],
                  [x[1], x[2], x[3]], Symbolic)
```

$$[x_1 = x_3 + 1, x_2 = 1 - x_3]$$

The unknowns may be expressions:

```
numeric::linsolve([f(0) - sin(x + 1) = 2, f(0) = 1 - sin(x + 1)],
                  [f(0), sin(x + 1)])
```

$$[f(0) = 1.5, \sin(x + 1) = -0.5]$$

The following system does not have a solution:

```
numeric::linsolve([x + y = 1, x + y = 2], [x, y])
```

FAIL

## Example 2

We demonstrate some examples with symbolic coefficients. Note that the option `Symbolic` has to be used:

```
eqs := [x + a*y = b, x + A*y = b]:
numeric::linsolve(eqs, [x, y], Symbolic)
```

$$[x = b, y = 0]$$

Note that for  $a = A$ , this is not the general solution. Using the option `ShowAssumptions`, it turns out that the above result is the general solution subject to the assumption  $a \neq A$ :

```
numeric::linsolve(eqs, [x, y], Symbolic, ShowAssumptions)
```

$$[[x = b, y = 0], [], [A - a \neq 0]]$$

delete eqs:

### Example 3

We give a further demonstration of the option `ShowAssumptions`. The following system does not have a solution for all values of the parameter `a`:

```
numeric::linsolve([x + y = 1, x + y = a], [x, y], Symbolic)
```

FAIL

With `ShowAssumptions`, `numeric::linsolve` investigates under which conditions (on the parameter `a`) there is a solution:

```
numeric::linsolve([x + y = 1, x + y = a], [x, y], Symbolic,  
                  ShowAssumptions)
```

$[[x = 1 - y], [a - 1 = 0], []]$

We conclude that there is a 1-parameter set of solutions for  $a = 1$ . The constraint in `a` is a linear equation, since the parameter `a` enters the equations linearly. If `a` is regarded as an unknown rather than as a parameter, the constraint becomes part of the solution:

```
numeric::linsolve([x + y = 1, x + y = a], [x, y, a], Symbolic,  
                  ShowAssumptions)
```

$[[x = 1 - y, a = 1], [], []]$

### Example 4

With exact arithmetic, `PI` (Symbolic Math Toolbox) is regarded as a symbolic parameter. The following system has a solution subject to the constraint  $PI = 1$ :

```
numeric::linsolve([x = x - y + 1, y = PI], [x, y],  
                  Symbolic, ShowAssumptions)
```

$[[y = \pi], [1 - \pi = 0], []]$

With floating-point arithmetic, PI (Symbolic Math Toolbox) is converted to 3.1415....  
The system has no solution:

```
numeric::linsolve([x = x - y + 1, y = PI], [x, y],
                  ShowAssumptions)
```

```
[FAIL, [], []]
```

## Example 5

Since `numeric::linsolve` does not do a systematic internal check for non-linearities, the user should make sure that the equations to be solved are indeed linear in the unknowns. Otherwise, strange things may happen. Garbage is produced for the following non-linear systems:

```
a := sin(x):
numeric::linsolve([y = 1 - a, x = y], [x, y], Symbolic)
```

```
[x = 1 - sin(x173), y = 1 - sin(x173)]
```

```
numeric::linsolve([a*x + y = 1, x = y], [x, y], Symbolic)
```

```
[x =  $\frac{1}{\sin(x18^3) + 1}$ , y =  $\frac{1}{\sin(x18^3) + 1}$ ]
```

Polynomial non-linearities are usually detected. Regarding  $x$ ,  $y$ ,  $c$  as unknowns, the following quadratic system yields an error:

```
numeric::linsolve([x*c + y = 1, x = y], Symbolic)
```

```
Error: This system does not seem to be linear. [numeric::linsolve]
```

```
Error:
This system does not seem to be linear. [numeric::linsolve]
```

This system is linear in  $x$ ,  $y$  if  $c$  is regarded as a parameter:

```
numeric::linsolve([x*c + y = 1, x = y], [x, y], Symbolic)
```

$$\left[ x = \frac{1}{c+1}, y = \frac{1}{c+1} \right]$$

delete a:

## Example 6

We solve a large sparse system. The coefficient matrix has only 3 diagonal bands. Note that both the equations as well as the variables are passed as lists. This guarantees that the band structure is not lost internally:

```
n := 500: x[0] := 0: x[n + 1] := 0:
eqs := [x[i-1] - 2*x[i] + x[i+1] = 1 $ i = 1..n]:
vars := [x[i] $ i = 1..n]:
numeric::linsolve(eqs, vars)
```

```
[x1 = -250.0, x2 = -499.0, x3 = -747.0, x4 = -994.0, ..., x498 = -747.0, x499 = -499.0,
x500 = -250.0]
```

The band structure is lost if the equations or the unknowns are specified by sets. The following call takes more time than the previous call:

```
numeric::linsolve({op(eqs)}, {x[i] $ i = 1..n})
```

```
[x1 = -250.0, x2 = -499.0, x3 = -747.0, x4 = -994.0, ..., x498 = -747.0, x499 = -499.0,
x500 = -250.0]
```

[ $x_1 = -250.0, x_2 = -499.0, x_3 = -747.0, x_4 = -994.0, x_5 = -1240.0, x_6 = -1485.0,$   
 $x_7 = -1729.0, x_8 = -1972.0, x_9 = -2214.0, x_{10} = -2455.0, x_{11} = -2695.0,$   
 $x_{12} = -2934.0, x_{13} = -3172.0, x_{14} = -3409.0, x_{15} = -3645.0, x_{16} = -3880.0,$   
 $x_{17} = -4114.0, x_{18} = -4347.0, x_{19} = -4579.0, x_{20} = -4810.0, x_{21} = -5040.0,$   
 $x_{22} = -5269.0, x_{23} = -5497.0, x_{24} = -5724.0, x_{25} = -5950.0, x_{26} = -6175.0,$   
 $x_{27} = -6399.0, x_{28} = -6622.0, x_{29} = -6844.0, x_{30} = -7065.0, x_{31} = -7285.0,$   
 $x_{32} = -7504.0, x_{33} = -7722.0, x_{34} = -7939.0, x_{35} = -8155.0, x_{36} = -8370.0,$   
 $x_{37} = -8584.0, x_{38} = -8797.0, x_{39} = -9009.0, x_{40} = -9220.0, x_{41} = -9430.0,$   
 $x_{42} = -9639.0, x_{43} = -9847.0, x_{44} = -10054.0, x_{45} = -10260.0, x_{46} = -10465.0,$   
 $x_{47} = -10669.0, x_{48} = -10872.0, x_{49} = -11074.0, x_{50} = -11275.0, x_{51} = -11475.0,$   
 $x_{52} = -11674.0, x_{53} = -11872.0, x_{54} = -12069.0, x_{55} = -12265.0, x_{56} = -12460.0,$   
 $x_{57} = -12654.0, x_{58} = -12847.0, x_{59} = -13039.0, x_{60} = -13230.0, x_{61} = -13420.0,$   
 $x_{62} = -13609.0, x_{63} = -13797.0, x_{64} = -13984.0, x_{65} = -14170.0, x_{66} = -14355.0,$   
 $x_{67} = -14539.0, x_{68} = -14722.0, x_{69} = -14904.0, x_{70} = -15085.0, x_{71} = -15265.0,$   
 $x_{72} = -15444.0, x_{73} = -15622.0, x_{74} = -15799.0, x_{75} = -15975.0, x_{76} = -16150.0,$   
 $x_{77} = -16324.0, x_{78} = -16497.0, x_{79} = -16669.0, x_{80} = -16840.0, x_{81} = -17010.0,$   
 $x_{82} = -17179.0, x_{83} = -17347.0, x_{84} = -17514.0, x_{85} = -17680.0, x_{86} = -17845.0,$   
 $x_{87} = -18009.0, x_{88} = -18172.0, x_{89} = -18334.0, x_{90} = -18495.0, x_{91} = -18655.0,$   
 $x_{92} = -18814.0, x_{93} = -18972.0, x_{94} = -19129.0, x_{95} = -19285.0, x_{96} = -19440.0,$   
 $x_{97} = -19594.0, x_{98} = -19747.0, x_{99} = -19899.0, x_{100} = -20050.0, x_{101} = -20200.0,$   
 $x_{102} = -20349.0, x_{103} = -20497.0, x_{104} = -20644.0, x_{105} = -20790.0, x_{106} = -20935.0,$   
 $x_{107} = -21079.0, x_{108} = -21222.0, x_{109} = -21364.0, x_{110} = -21505.0, x_{111} = -21645.0,$   
 $x_{112} = -21784.0, x_{113} = -21922.0, x_{114} = -22059.0, x_{115} = -22195.0, x_{116} = -22330.0,$   
 $x_{117} = -22464.0, x_{118} = -22597.0, x_{119} = -22729.0, x_{120} = -22860.0, x_{121} = -22990.0,$   
 $x_{122} = -23119.0, x_{123} = -23247.0, x_{124} = -23374.0, x_{125} = -23500.0, x_{126} = -23625.0,$   
 $x_{127} = -23749.0, x_{128} = -23872.0, x_{129} = -23994.0, x_{130} = -24115.0, x_{131} = -24235.0,$   
 $x_{132} = -24354.0, x_{133} = -24472.0, x_{134} = -24589.0, x_{135} = -24705.0, x_{136} = -24820.0,$   
 $x_{137} = -24934.0, x_{138} = -25047.0, x_{139} = -25159.0, x_{140} = -25270.0, x_{141} = -25380.0,$   
 $x_{142} = -25489.0, x_{143} = -25597.0, x_{144} = -25704.0, x_{145} = -25810.0, x_{146} = -25915.0,$   
 $x_{147} = -26019.0, x_{148} = -26122.0, x_{149} = -26224.0, x_{150} = -26325.0, x_{151} = -26425.0,$   
 $x_{152} = -26524.0, x_{153} = -26622.0, x_{154} = -26719.0, x_{155} = -26815.0, x_{156} = -26910.0,$   
 $x_{157} = -27004.0, x_{158} = -27097.0, x_{159} = -27189.0, x_{160} = -27280.0, x_{161} = -27370.0,$   
 $x_{162} = -27459.0, x_{163} = -27547.0, x_{164} = -27634.0, x_{165} = -27720.0, x_{166} = -27805.0,$   
 $x_{167} = -27889.0, x_{168} = -27972.0, x_{169} = -28054.0, x_{170} = -28135.0, x_{171} = -28215.0,$   
 $x_{172} = -28294.0, x_{173} = -28372.0, x_{174} = -28449.0, x_{175} = -28525.0, x_{176} = -28600.0,$   
 $x_{177} = -28674.0, x_{178} = -28747.0, x_{179} = -28819.0, x_{180} = -28890.0, x_{181} = -28960.0,$   
 $x_{182} = -29029.0, x_{183} = -29097.0, x_{184} = -29164.0, x_{185} = -29230.0, x_{186} = -29295.0,$   
 $x_{187} = -29359.0, x_{188} = -29422.0, x_{189} = -29484.0, x_{190} = -29545.0, x_{191} = -29605.0,$   
 $x_{192} = -29664.0, x_{193} = -29722.0, x_{194} = -29779.0, x_{195} = -29835.0, x_{196} = -29890.0,$   
 $x_{197} = -29944.0, x_{198} = -29997.0, x_{199} = -30049.0, x_{200} = -30100.0, x_{201} = -30150.0,$   
 $x_{202} = -30199.0, x_{203} = -30247.0, x_{204} = -30294.0, x_{205} = -30340.0, x_{206} = -30385.0,$   
 $x_{207} = -30429.0, x_{208} = -30472.0, x_{209} = -30514.0, x_{210} = -30555.0, x_{211} = -30595.0,$   
 $x_{212} = -30634.0, x_{213} = -30672.0, x_{214} = -30709.0, x_{215} = -30745.0, x_{216} = -30780.0,$   
 $x_{217} = -30814.0, x_{218} = -30847.0, x_{219} = -30879.0, x_{220} = -30910.0, x_{221} = -30940.0,$   
 $x_{222} = -30969.0, x_{223} = -30997.0, x_{224} = -31024.0, x_{225} = -31050.0, x_{226} = -31075.0,$   
 $x_{227} = -31099.0, x_{228} = -31122.0, x_{229} = -31144.0, x_{230} = -31165.0, x_{231} = -31185.0,$

```
delete n, x, eqs, vars:
```

## Example 7

The option `Symbolic` should not be used for equations with floating-point coefficients, because the symbolic pivoting strategy favors efficiency instead of numerical stability.

```
eqs := [x + 1020*y = 1020, x + y = 0]:
```

The float approximation of the exact solution is:

```
map(numeric::linsolve(eqs, [x, y], Symbolic), map, float)
```

```
[x = -1.0, y = 1.0]
```

We now convert the exact coefficients to floating-point numbers:

```
feqs := map(eqs, map, float)
```

```
[x + 1.0 1020 y = 1.0 1020, x + y = 0.0]
```

The default pivoting strategy stabilizes floating-point operations. Consequently, one gets a correct result:

```
numeric::linsolve(feqs, [x, y])
```

```
[x = -1.0, y = 1.0]
```

With `Symbolic`, the pivoting strategy optimizes speed, assuming exact arithmetic. Numerical instabilities may occur if floating-point coefficients are involved. The following incorrect result is caused by internal round-off effects (“cancellation”):

```
numeric::linsolve(feqs, [x, y], Symbolic)
```

```
[x = 0.0, y = 1.0]
```

```
delete eqs, feqs:
```

## Example 8

We demonstrate that the simplified equations representing the solution can be used for further processing with `subs`:

```
eqs := [x + y = 1, x + y = a]:
[Solution, Constraints, Pivots] :=
  numeric::linsolve(eqs, [x, y], ShowAssumptions)
```

```
[[x = 1.0 - 1.0 y], [1.0 a - 1.0 = 0], []]
```

```
subs(eqs, Solution)
```

```
[1.0 = 1, 1.0 = a]
```

The solution can be assigned to the unknowns via `assign`:

```
assign(Solution):
x, y, eqs
```

```
1.0 - 1.0 y, y, [1.0 = 1, 1.0 = a]
```

```
delete eqs, Solution, Constraints, Pivots, x:
```

## Example 9

If the solution of the linear system is not unique, then some of the unknowns are used as “free parameters” spanning the solution space. In the following example, the unknowns  $z$ ,  $w$  are such parameters. They do not turn up on the left hand side of the solved equations:

```
eqs := [x + y = z, x + 2*y = 0, 2*x - z = -3*y, y + z = 0]:
vars := [x, y, z, w]:
Solution := numeric::linsolve(eqs, vars, Symbolic)
```

```
[x = 2 z, y = -z]
```

You may define a function such as the following `NewSolutionList` to rename your free parameters to "myName1", "myName2" etc. and fill up your list of solved equations accordingly:

```
NewSolutionList :=
proc(Solution : DOM_LIST, vars : DOM_LIST, myName : DOM_STRING)
local i, solvedVars, newEquation;
begin
  solvedVars := map(Solution, op, 1);
  for i from 1 to nops(vars) do
    if not has(solvedVars, vars[i]) then
      newEquation := vars[i] = genident(myName);
      Solution := listlib::insertAt(
        subs(Solution, newEquation), newEquation, i)
    end_if
  end_for:
  Solution
end_proc:

NewSolutionList(Solution, vars, "FreeParameter")
```

```
[x = 2 FreeParameter1, y = -FreeParameter1, z = FreeParameter1, w = FreeParameter2]
```

```
delete eqs, vars, Solution, NewSolutionList:
```

## Example 10

We demonstrate the difference between hardware and software arithmetic. The following problem is very ill-conditioned. The results, both with `HardwareFloats` as well as with `SoftwareFloats`, are marred by numerical round-off:

```
n:= 10:
eqs:= [(_plus(x[j]/(i + j -1) $ j = 1..n) = 1) $ i = 1..n]:
vars:= [x[i] $ i = 1..n]:
numeric::linsolve(eqs, vars, SoftwareFloats);
numeric::linsolve(eqs, vars, HardwareFloats)
```

```
[x1 = -9.999986342, x2 = 989.9988244, x3 = -23759.97502, x4 = 240239.7733,
x5 = -1261258.92, x6 = 3783777.035, x7 = -6726715.139, x8 = 7001275.306,
x9 = -3938217.537, x10 = 923779.4586]
```



```
[x1 = -9.997364824, x2 = 989.7718609, x3 = -23755.13378, x4 = 240195.7143,
x5 = -1261048.597, x6 = 3783198.501, x7 = -6725765.49, x8 = 7000357.238,
x9 = -3937735.418, x10 = 923673.4085]
```

This is the exact solution:

```
numeric::linsolve(eqs, vars, Symbolic);
```

```
[x1 = -10, x2 = 990, x3 = -23760, x4 = 240240, x5 = -1261260, x6 = 3783780,
x7 = -6726720, x8 = 7001280, x9 = -3938220, x10 = 923780]
```

```
delete eqs, vars:
```

## Example 11

We demonstrate how a complete solution of the following linear system in  $x, y$  with symbolic parameters  $a, b, c, d$  may be found:

```
eqs := [x + y = d, a*x + b*y = 1, x + c*y = 1]:
numeric::linsolve(eqs, [x, y], Symbolic, ShowAssumptions)
```

$$\left[ \left[ x = -\frac{bd-1}{a-b}, y = \frac{ad-1}{a-b} \right], [a-b+c+bd-acd-1=0], [b-a \neq 0] \right]$$

This is the general solution, assuming  $a \neq b$ . We now set  $b = a$  to investigate further solution branches:

```
eqs := subs(eqs, b = a):
numeric::linsolve(eqs, [x, y], Symbolic, ShowAssumptions)
```

$$\left[ \left[ x = \frac{cd-1}{c-1}, y = -\frac{d-1}{c-1} \right], [1-ad=0], [c-1 \neq 0] \right]$$

This is the general solution for  $a = b$ , assuming  $c \neq 1$ . We finally set  $c = 1$  to obtain the last solution branch:

```
eqs := subs(eqs, c = 1):
numeric::linsolve(eqs, [x, y], Symbolic, ShowAssumptions)
```

```
[[x = d - y], [1 - a d = 0, 1 - d = 0], []]
```

From the constraints on the symbolic parameters  $a$  and  $d$ , we conclude that there is a special 1-parameter solution  $x = 1 - y$  for  $a = b = c = d = 1$ .

`delete eqs:`

## Parameters

### `eqs`

A list on page 7-41, set on page 7-50, `array`, or `matrix` (`Cat::Matrix`) of linear equations or arithmetical expressions (Symbolic Math Toolbox)

### `vars`

A list on page 7-41 or set on page 7-50 of unknowns to solve for. Unknowns may be identifiers on page 7-29 or indexed identifiers on page 1-1017 or arithmetical expressions (Symbolic Math Toolbox).

## Options

### `Hard`, `HardwareFloats`, `Soft`, `SoftwareFloats`

With `Hard` (or `HardwareFloats`), computations are done using fast hardware float arithmetic from within a MuPAD session. `Hard` and `HardwareFloats` are equivalent. With this option, the input data are converted to hardware floats and processed by compiled C code. The result is reconverted to MuPAD floats and returned to the MuPAD session.

With `Soft` (or `SoftwareFloats`) computations are done using software float arithmetic provided by the MuPAD kernel. `Soft` and `SoftwareFloats` are equivalent. `SoftwareFloats` is used by default if the current value of `DIGITS` is larger than 15 and the input matrix  $A$  is not of domain type `DOM_HFARRAY`.

Compared to the `SoftwareFloats` used by the MuPAD kernel, the computation with `HardwareFloats` may be many times faster. Note, however, that the precision of hardware arithmetic is limited to about 15 digits. Further, the size of floating-point

numbers may not be larger than approximately  $10^{308}$  and not smaller than approximately  $10^{-308}$ .

If no `HardwareFloats` or `SoftwareFloats` are requested explicitly, the following strategy is used: If the current value of `DIGITS` is smaller than 16 or if the matrix `A` is a hardware float array of domain type `DOM_HFARRAY`, then hardware arithmetic is tried. If this is successful, the result is returned.

If the result cannot be computed with hardware floats, software arithmetic by the MuPAD kernel is tried.

If the current value of `DIGITS` is larger than 15 and the input matrix `A` is not of domain type `DOM_HFARRAY`, or if one of the options `Soft`, `SoftwareFloats` or `Symbolic` is specified, MuPAD computes the result with its software arithmetic without trying to use hardware floats first.

There may be several reasons for hardware arithmetic to fail:

- The current value of `DIGITS` is larger than 15.
- The data contains symbolic objects.
- The data contains numbers larger than  $10^{308}$  or smaller than  $10^{-308}$  that cannot be represented by hardware floats.

If neither `HardwareFloats` nor `SoftwareFloats` is specified, the user is not informed whether hardware floats or software floats are used.

If `HardwareFloats` are specified but fail due to one of the reasons above, a warning is issued that the (much slower) software floating-point arithmetic of the MuPAD kernel is used.

Note that `HardwareFloats` can only be used if all input data can be converted to floating-point numbers.

The trailing digits in floating-point results computed with `HardwareFloats` and `SoftwareFloats` may differ.

---

**Note** For ill-conditioned systems, the result is subject to round-off errors. The results returned with `HardwareFloats` and `SoftwareFloats` may differ significantly! See "Example 10" on page 19-172 (Symbolic Math Toolbox).

---

### Symbolic

Prevents conversion of input data to floating-point numbers. This option overrides `HardwareFloats` and `SoftwareFloats`.

This option *must* be used if the coefficients of the equations contain symbolic parameters that cannot be converted to floating-point numbers.

---

**Note** This option should not be used for equations with floating-point coefficients! Numerical instabilities may occur in floating-point operations. See “Example 7” on page 19-170 (Symbolic Math Toolbox).

---

### ShowAssumptions

Returns information on internal assumptions on symbolic parameters in `eqs`.

This option is only useful if the equations contain symbolic parameters. Consequently, it should only be used in conjunction with the option `Symbolic`.

---

**Note** The format of the return value is changed to `[Solution, Constraints, Pivots]`.

---

`Solution` is a set of simplified equations representing the general solution subject to `Constraints` and `Pivots`.

`Constraints` is a list of equations for symbolic parameters in `eqs`, which are necessary and sufficient to make the system solvable.

Such constraints arise if Gaussian elimination of the original equations leads to equations of the form  $0 = c$ , where  $c$  is some expression involving symbolic parameters in the “right hand side” of the system. All such equations are collected in `Constraints`. `numeric::linsolve` assumes that these equations are satisfied and returns a solution.

If no such constraints arise, the return value of `Constraints` is the empty list.

`Pivots` is a list of inequalities involving symbolic parameters in the coefficient matrix  $A$  of the linear system  $Ax = b$  represented by `eqs`. Internally, division by pivot elements occurs in the Gaussian elimination. The expressions collected in `Pivots` are the

numerators of the pivot elements that contain symbolic parameters. If only numerical pivot elements were used, the return value of `Pivots` is the empty list.

---

**Note** The option `ShowAssumptions` changes the return strategy for “unsolvable” systems. Without the option `Symbolic`, `FAIL` is returned whenever Gaussian elimination produces an equation  $0 = c$  with non-zero  $c$ . With `ShowAssumptions`, such equations are returned via `Constraints`, provided  $c$  involves symbolic parameters.

---

If  $c$  is a purely numerical value, then `[FAIL, [], []]` is returned.

---

See “Example 2” on page 19-165 (Symbolic Math Toolbox), “Example 3” on page 19-166 (Symbolic Math Toolbox), “Example 4” on page 19-166 (Symbolic Math Toolbox), and “Example 11” on page 19-173 (Symbolic Math Toolbox).

### **NoWarning**

Suppresses warnings

If symbolic coefficients are found, `numeric::linsolve` automatically switches to the `Symbolic` mode with a warning. With this option, this warning is suppressed; `numeric::linsolve` still uses the symbolic mode for symbolic coefficients, i.e., exact arithmetic without floating-point conversions is used.

## **Return Values**

Without the option `ShowAssumptions`, a list of simplified equations is returned. It represents the general solution of the system `eqs`. `FAIL` is returned if the system is not solvable.

With `ShowAssumptions`, a list `[Solution, Constraints, Pivots]` is returned. `Solution` is a list of simplified equations representing the general solution of `eqs`. The lists `Constraints` and `Pivots` contain equations and inequalities involving symbolic parameters in `eqs`. Internally, these were assumed to hold true when solving the system.

`[FAIL, [], []]` is returned if the system is not solvable.

## See Also

### MuPAD Functions

`isolate` | `linalg::matlinsolve` | `linsolve` | `numeric::fsolve` |  
`numeric::inverse` | `numeric::matlinsolve` | `numeric::polyroots` |  
`numeric::polysysroots` | `numeric::realroots` | `polylib::realroots` | `solve`

# numeric::matlinsolve

Solve a linear matrix equation

## Syntax

```
numeric::matlinsolve(A, B, options)
```

## Description

`numeric::matlinsolve(A, B)` returns the matrix solution  $X$  of the matrix equation  $AX = B$  together with the kernel of the matrix  $A$ .

`numeric::matlinsolve` is a fast numerical linear solver for both sparse and dense systems. It is also a recommended solver for linear systems with exact or symbolic coefficients (use option `Symbolic`).

If no return type is specified via the option `ReturnType = d`, the domain type of the return data depends on the type of the input matrix  $A$ :

- The special solution  $X$  as well as the kernel of an array on page 7-2  $A$  are returned as arrays on page 7-2.
- The special solution  $X$  as well as the kernel of an hfarray on page 7-27  $A$  are returned as hfarrays on page 7-27.
- For a dense matrix on page 1-506A of type `Dom::DenseMatrix()`, both the special solution  $X$  as well as the kernel of  $A$  are returned as matrices of type `Dom::DenseMatrix()` over the ring of MuPAD expressions.
- For all other matrices of category `Cat::Matrix`, both the special solution  $X$  as well as the kernel of  $A$  are returned as matrices on page 1-1340 of type `Dom::Matrix()` over the ring of MuPAD expressions. This includes input matrices  $A$  of type `Dom::Matrix(...)`, `Dom::SquareMatrix(...)`, `Dom::MatrixGroup(...)` etc.

Without `Symbolic`, exact numerical input data such as  $\pi + \sqrt{2}$ ,  $\sin(3)$  etc. are converted to floating-point numbers. Floating point arithmetic is used. Its precision is given the environment variable `DIGITS`. If symbolic data are found that cannot be

converted to floating-point numbers, `numeric::matlinsolve` automatically switches to its symbolic mode, issuing a warning. This warning may be suppressed via `NoWarning`.

With `Symbolic`, symbolic parameters in the coefficient matrix  $A$  as well as in the right hand side  $B$  are accepted and processed without a warning.

With `SoftwareFloats`, the right hand side  $B$  may contain symbolic parameters that cannot be converted to floating-point numbers. All entries of the coefficient matrix  $A$ , however, must be convertible to floating-point numbers.

With `HardwareFloats`, neither  $A$  nor  $B$  must contain symbolic parameters that cannot be converted to floating-point numbers.

$X$  is a *special* solution of the equation  $AX = B$ . If  $A$  has a non-trivial kernel, the solution  $X$  is not unique.

---

**Note** The result computed with `HardwareFloats` may differ from the solution computed with `SoftwareFloats` or `Symbolic`! In particular, this is the case for systems with a non-trivial kernel.

---

Cf. “Example 9” on page 19-188 (Symbolic Math Toolbox).

The  $n \times d$  matrix `KernelBasis` is the most general solution of  $AX = 0$ . Its columns span the  $d$ -dimensional kernel of  $A$ .

Thus, the kernel of  $A$  may be computed via `numeric::matlinsolve(A, [0, ..., 0])[2]`.

If the kernel is 0-dimensional, the return value of `KernelBasis` is the integer 0. If `KernelBasis` is returned as an array on page 7-2, the dimension  $d$  of the kernel is `d = op(KernelBasis, [0, 3, 2])`. If `KernelBasis` is returned as a matrix of type `Dom::Matrix()` or `Dom::DenseMatrix()`, the dimension  $d$  of the kernel is `d = KernelBasis::dom::matdim(KernelBasis)[2]`.

---

**Note** Due to round-off errors, some or all basis vectors in the kernel of  $A$  may be missed in the numerical modes.

---

The special solution  $X$  in conjunction with `KernelBasis` provides the general solution of  $AX = B$ . Solutions generated without the option `ShowAssumptions` are valid for



arbitrary complex values of the symbolic parameters which may be present in A and B. If no such solution exists, then [FAIL,NIL] is returned. Solutions that are valid only for special values of the symbolic parameters may be obtained with ShowAssumptions. See “Example 3” on page 19-183 (Symbolic Math Toolbox), “Example 4” on page 19-184 (Symbolic Math Toolbox), and “Example 7” on page 19-186 (Symbolic Math Toolbox).

numeric::matlinsolve internally uses a sparse representation of the matrices. It is suitable for solving large sparse systems. See “Example 5” on page 19-185 (Symbolic Math Toolbox).

---

**Note** numeric::matlinsolve does not react to any assumptions on symbolic parameters in A, B that are set via assume.

---

---

**Note** Gaussian elimination with partial pivoting is used. Without the option Symbolic, the pivoting strategy takes care of numerical stabilization. With Symbolic, exact data are assumed. The symbolic pivoting strategy tries to maximize speed and does not take care of numerical stabilization! Do not use Symbolic for linear systems involving floating-point entries! See “Example 6” on page 19-185 (Symbolic Math Toolbox).

---

---

**Note** Apart from matrices of type Dom::Matrix(...), Cat::Matrix objects A from matrix domains such as Dom::DenseMatrix(...) or Dom::SquareMatrix(...) are internally converted to arrays over expressions via expr(A). Note that the option Symbolic should be used if the entries cannot be converted to numerical expressions.

Note that linalg::matlinsolve must be used, when the solution is to be computed over the component domain. See “Example 8” on page 19-187 (Symbolic Math Toolbox).

---

## Environment Interactions

Without the option Symbolic, the function is sensitive to the environment variable DIGITS, which determines the numerical working precision.

## Examples

### Example 1

We use equivalent input formats ( $B_1$ ,  $B_2$ ) to represent a vector with components  $[a, \pi]$ . First, this vector is defined as a 2-dimensional array:

```
A := array(1..2, 1..3, [[1, 2, 3],[1, 1, 2]]):  
B1 := array(1..2, 1..1, [[a], [PI]]):  
numeric::matlinsolve(A, B1)
```

$$\left[ \left( \begin{array}{c} 6.283185307 - 1.0 a \\ 1.0 a - 3.141592654 \\ 0 \end{array} \right), \left( \begin{array}{c} -1.0 \\ -1.0 \\ 1.0 \end{array} \right) \right]$$

Next, we use a 1-dimensional array and compute an exact solution:

```
B2 := array(1..2, [a, PI]):  
numeric::matlinsolve(A, B2, Symbolic)
```

$$\left[ \left( \begin{array}{c} 2 \pi - a \\ a - \pi \\ 0 \end{array} \right), \left( \begin{array}{c} -1 \\ -1 \\ 1 \end{array} \right) \right]$$

Now, a list is used to specify the vector. No internal assumptions were used by `numeric::matlinsolve` to obtain the solution:

```
B3 := [a, PI]:  
numeric::matlinsolve(A, B3, ShowAssumptions)
```

$$\left[ \left( \begin{array}{c} 6.283185307 - 1.0 a \\ 1.0 a - 3.141592654 \\ 0 \end{array} \right), \left( \begin{array}{c} -1.0 \\ -1.0 \\ 1.0 \end{array} \right), [], [] \right]$$

Finally, we use `Dom::Matrix` objects to specify the system. Note that the results are returned as corresponding matrix objects:

```
A := matrix([[1, 2, 3],[1, 1, 2]]):
B4 := matrix([a, PI]):
numeric::matlinsolve(A, B4)
```

$$\left[ \begin{pmatrix} 6.283185307 - 1.0 a \\ 1.0 a - 3.141592654 \\ 0 \end{pmatrix}, \begin{pmatrix} -1.0 \\ -1.0 \\ 1.0 \end{pmatrix} \right]$$

```
delete A, B1, B2, B3, B4:
```

## Example 2

We invert a matrix by solving  $AX = 1$ :

```
A := hfarray(1..3, 1..3, [[1, 1, 0], [0, 1, 1], [0, 0, 1]]):
B := matrix::identity(3, 3):
InverseOfA := numeric::matlinsolve(A, B, Symbolic)[1]
```

$$\begin{pmatrix} 1.0 & -1.0 & 1.0 \\ 0.0 & 1.0 & -1.0 \\ 0.0 & 0.0 & 1.0 \end{pmatrix}$$

```
delete A, B, InverseOfA:
```

## Example 3

We solve an equation with a symbolic parameter  $x$ :

```
A := matrix([[2, 2, 3], [1, 1, 2], [3, 3, 5]]):
B := matrix([sin(x)^2, cos(x)^2, 0]):
[X, Kernel, Constraints, Pivots] :=
numeric::matlinsolve(A, B, Symbolic, ShowAssumptions)
```

$$\left[ \begin{pmatrix} 5 \sin(x)^2 \\ 0 \\ -3 \sin(x)^2 \end{pmatrix}, \begin{pmatrix} -1 \\ 1 \\ 0 \end{pmatrix}, [\cos(x)^2 + \sin(x)^2 = 0], \square \right]$$

This solution holds subject to the constraint  $\sin(x)^2 + \cos(x)^2 = 0$  on the parameter  $x$ . `numeric::matlinsolve` does not investigate the `Constraints` and does not realize that they cannot be satisfied. We check the consistency of the “result” by inserting the solution into the original system. Since the input matrix  $A$  was of type `Dom::Matrix()`, the results  $X$  and `Kernel` were returned as corresponding matrices. The overloaded operators `*` and `-` for matrix multiplication and subtraction can be used:

```
A*X - B, A*Kernel
```

$$\begin{pmatrix} 0 \\ -\cos(x)^2 - \sin(x)^2 \\ 0 \end{pmatrix}, \begin{pmatrix} 0 \\ 0 \\ 0 \end{pmatrix}$$

```
delete A, B, X, Kernel, Constraints, Pivots:
```

## Example 4

We give a further demonstration of the option `ShowAssumptions`. The following system does not have a solution for all values of the parameter  $a$ :

```
A := array(1..2, 1..2, [[1, 1], [1, 1]]):  
B := array(1..2, 1..1, [[1], [a]]):  
numeric::matlinsolve(A, B, Symbolic)
```

```
[FAIL, NIL]
```

With `ShowAssumptions`, `numeric::matlinsolve` investigates under which conditions (on the parameter  $a$ ) there is a solution:

```
numeric::matlinsolve(A, B, Symbolic, ShowAssumptions)
```

$$\left[ \begin{pmatrix} 1 \\ 0 \end{pmatrix}, \begin{pmatrix} -1 \\ 1 \end{pmatrix}, [a - 1 = 0], [] \right]$$

We conclude that there is a 1-dimensional solution space for  $a = 1$ .

```
delete A, B:
```

## Example 5

We solve a sparse system with 3 diagonal bands:

```
n := 100:
A := matrix(n, n, [1, -2, 1], Banded):
B := array(1..n, [1 $ n]):
numeric::matlinsolve(A, B)
```

$$\left[ \begin{pmatrix} -50.0 \\ -99.0 \\ -147.0 \\ \dots \\ -147.0 \\ -99.0 \\ -50.0 \end{pmatrix}, 0 \right]$$

```
delete n, A, B:
```

## Example 6

The option `Symbolic` should not be used for equations with floating-point coefficients, because the symbolic pivoting strategy favors efficiency instead of numerical stability.

```
A := array(1..2, 1..2, [[1, 10^20], [1, 1]]):
B := array(1..2, 1..1, [[10^20], [0]]):
```

The float approximation of the exact solution is:

```
map(numeric::matlinsolve(A, B, Symbolic)[1], float)
```

$$\begin{pmatrix} -1.0 \\ 1.0 \end{pmatrix}$$

We now convert the exact input data to floating-point approximations:

```
A := map(A, float): B := map(B, float):
```

The default pivoting strategy of the floating-point algorithm stabilizes floating-point operations. Consequently, one gets a correct result:

```
numeric::matlinsolve(A, B)[1]
```

$$\begin{pmatrix} -1.0 \\ 1.0 \end{pmatrix}$$

With the option `Symbolic`, however, the pivoting strategy optimizes speed, assuming exact arithmetic. Numerical instabilities may occur if floating-point coefficients are involved. The following result is caused by internal round-off effects (“cancellation”):

```
numeric::matlinsolve(A, B, Symbolic)[1]
```

$$\begin{pmatrix} 0 \\ 1.0 \end{pmatrix}$$

We need to increase `DIGITS` to obtain a better result:

```
DIGITS := 20:  
numeric::matlinsolve(A, B, Symbolic)[1]
```

$$\begin{pmatrix} -1.0000000149011611938 \\ 1.0 \end{pmatrix}$$

```
delete A, B, DIGITS:
```

## Example 7

We demonstrate how a complete solution of the following linear system with symbolic parameters may be found:

```
A := array(1..3, 1..2, [[1, 1], [a, b], [1, c]]):  
B := array(1..3, 1..1, [[1], [1], [1]]):  
numeric::matlinsolve(A, B, Symbolic, ShowAssumptions)
```

$$\left[ \begin{pmatrix} -\frac{b-1}{a-b} \\ \frac{a-1}{a-b} \end{pmatrix}, 0, [-(a-1)(c-1)=0], [b-a \neq 0] \right]$$

This is the general solution assuming  $a \neq b$ . We now set  $b = a$  to investigate further solution branches:

```
A := subs(A, b = a):
numeric::matlinsolve(A, B, Symbolic, ShowAssumptions)
```

$$\left[ \begin{pmatrix} 1 \\ 0 \end{pmatrix}, 0, [1 - a = 0], [c - 1 \neq 0] \right]$$

This is the general solution for  $a = b$ , assuming  $c \neq 1$ . We finally set  $c = 1$  to obtain the last solution branch:

```
A := subs(A, c = 1):
numeric::matlinsolve(A, B, Symbolic, ShowAssumptions)
```

$$\left[ \begin{pmatrix} 1 \\ 0 \end{pmatrix}, \begin{pmatrix} -1 \\ 1 \end{pmatrix}, [1 - a = 0], [] \right]$$

From the constraint on  $a$ , we conclude that there is a 1-dimensional solution space for the special values  $a = b = c = 1$  of the symbolic parameters.

```
delete A, B:
```

## Example 8

Matrices from a domain such as `Dom::Matrix(...)` are converted to arrays with numbers or expressions. Hence, `numeric::matlinsolve` finds no solution for the following system:

```
M := Dom::Matrix(Dom::IntegerMod(7)):
A := M([[1, 4], [6, 3], [3, 2]]):
B := M([[9], [5], [0]]):
numeric::matlinsolve(A, B)
```

[FAIL, NIL]

Use `linalg::matlinsolve` to solve the system over the coefficient field of the matrices. A solution does exist over the field `Dom::IntegerMod(7)`:

```
linalg::matlinsolve(A, B)
```

$$\begin{pmatrix} 1 \bmod 7 \\ 2 \bmod 7 \end{pmatrix}$$

```
delete M, A, B:
```

## Example 9

We demonstrate the difference between Symbolic, HardwareFloats, and SoftwareFloats. The following matrix  $A$  has a 1-dimensional kernel. Due to round-off, a further spurious kernel vector appears with SoftwareFloats. No kernel vector is detected with HardwareFloats:

```
A := matrix([[2*10^14 + 2, 2*10^(-9), 2*10^(-4)],
             [3*10^15 + 3, 3*10^(-8), 3*10^(-3)],
             [4*10^16 + 4, 4*10^(-7), 4*10^(-2)]
            ]):
b := matrix([2*10^(-9), 3*10^(-8), 4*10^(-7)]):
float(numeric::matlinsolve(A, b, Symbolic));
numeric::matlinsolve(A, b, SoftwareFloats);
numeric::matlinsolve(A, b, HardwareFloats)
```

$$\left[ \begin{pmatrix} 0 \\ 1.0 \\ 0 \end{pmatrix}, \begin{pmatrix} 0 \\ -100000.0 \\ 1.0 \end{pmatrix} \right]$$

$$\left[ \begin{pmatrix} 1.0 \cdot 10^{-23} \\ 0 \\ 0 \end{pmatrix}, \begin{pmatrix} -1.0 \cdot 10^{-23} & -1.0 \cdot 10^{-18} \\ 1.0 & 0 \\ 0 & 1.0 \end{pmatrix} \right]$$

$$\left[ \begin{pmatrix} 0 \\ 1.0 \\ 0 \end{pmatrix}, 0 \right]$$

```
delete A, b:
```



## Parameters

### A

An  $m \times n$  matrix of domain type (Symbolic Math Toolbox) `DOM_ARRAY`, `DOM_HFARRAY`, or of category `Cat::Matrix`

### B

An  $m \times p$  matrix of domain type `DOM_ARRAY`, `DOM_HFARRAY`, or of category `Cat::Matrix`. Column vectors `B` may also be represented by a 1-dimensional `array(1..m, [B1, B2, ...] )`, a 1-dimensional `harray(1..m, [B1, B2, ...] )`, or by a list `[B1, B2, ...]`.

## Options

### Hard, HardwareFloats, Soft, SoftwareFloats

With `Hard` (or `HardwareFloats`), computations are done using fast hardware float arithmetic from within a MuPAD session. `Hard` and `HardwareFloats` are equivalent. With this option, the input data are converted to hardware floats and processed by compiled C code. The result is reconverted to MuPAD floats and returned to the MuPAD session.

With `Soft` (or `SoftwareFloats`) computations are done using software float arithmetic provided by the MuPAD kernel. `Soft` and `SoftwareFloats` are equivalent. `SoftwareFloats` is used by default if the current value of `DIGITS` is larger than 15 and the input matrix `A` is not of domain type `DOM_HFARRAY`.

Compared to the `SoftwareFloats` used by the MuPAD kernel, the computation with `HardwareFloats` may be many times faster. Note, however, that the precision of hardware arithmetic is limited to about 15 digits. Further, the size of floating-point numbers may not be larger than approximately  $10^{308}$  and not smaller than approximately  $10^{-308}$ .

If no `HardwareFloats` or `SoftwareFloats` are requested explicitly, the following strategy is used: If the current value of `DIGITS` is smaller than 16 or if the matrix `A` is a hardware float array of domain type `DOM_HFARRAY`, then hardware arithmetic is tried. If this is successful, the result is returned.

If the result cannot be computed with hardware floats, software arithmetic by the MuPAD kernel is tried.

If the current value of `DIGITS` is larger than 15 and the input matrix `A` is not of domain type `DOM_HFARRAY`, or if one of the options `Soft`, `SoftwareFloats` or `Symbolic` is specified, MuPAD computes the result with its software arithmetic without trying to use hardware floats first.

There may be several reasons for hardware arithmetic to fail:

- The current value of `DIGITS` is larger than 15.
- The data contains symbolic objects.
- The data contains numbers larger than  $10^{308}$  or smaller than  $10^{-308}$  that cannot be represented by hardware floats.

If neither `HardwareFloats` nor `SoftwareFloats` is specified, the user is not informed whether hardware floats or software floats are used.

If `HardwareFloats` are specified but fail due to one of the reasons above, a warning is issued that the (much slower) software floating-point arithmetic of the MuPAD kernel is used.

Note that `HardwareFloats` can only be used if all input data can be converted to floating-point numbers.

The trailing digits in floating-point results computed with `HardwareFloats` and `SoftwareFloats` may differ.

---

**Note** For ill-conditioned matrices, the results returned with `HardwareFloats` and `SoftwareFloats` may differ significantly! See “Example 9” on page 19-188 (Symbolic Math Toolbox).

---

## Symbolic

Prevents the conversion of the input data to floating-point numbers. Exact arithmetic is used. This option overrides `HardwareFloats` and `SoftwareFloats`.

This option *must* be used if the matrix `A` contains symbolic parameters that cannot be converted to floating-point numbers.

---

**Note** This option should not be used for matrices with floating-point entries! Numerical instabilities may occur in floating-point operations. Cf. “Example 6” on page 19-185 (Symbolic Math Toolbox).

---

### ShowAssumptions

Returns information on internal assumptions on symbolic parameters in  $A$  and  $B$ . With this option, either exact arithmetic or `SoftwareFloats` are used.

This option is only useful if the matrices contain symbolic parameters. Consequently, it should only be used in conjunction with the option `Symbolic`.

---

**Note** This option changes the format of the return value to  $[X, \text{KernelBasis}, \text{Constraints}, \text{Pivots}]$ .

---

$X$  and `KernelBasis` represent the general solution subject to `Constraints` and `Pivots`.

`Constraints` is a list of equations for symbolic parameters in  $B$  which are necessary and sufficient for  $AX = B$  to be solvable.

Such constraints arise if Gaussian elimination leads to equations of the form  $0 = c$ , where  $c$  is some expression involving symbolic parameters contained in  $B$ . All such equations are collected in `Constraints`; `numeric::matlinsolve` assumes that these equations are satisfied and returns a special solution  $X$ .

If no such constraints arise, the return value of `Constraints` is the empty list.

`Pivots` is a list of inequalities involving symbolic parameters in  $A$ . Internally, division by pivot elements occurs in the Gaussian elimination. The expressions collected in `Pivots` are the numerators of those pivot elements that involve symbolic parameters contained in  $A$ . If only numerical pivot elements are used, then the return value of `Pivots` is the empty list.

---

**Note** `Constraints` usually is a list of *non-linear* equations for the symbolic parameters. It is not investigated by `numeric::matlinsolve`, i.e., solutions may be returned, even if the `Constraints` cannot be satisfied. See “Example 3” on page 19-183 (Symbolic Math Toolbox).

---

---

**Note** This option changes the return strategy for “unsolvable” systems. Without the option `ShowAssumptions`, the result `[FAIL, NIL]` is returned, whenever Gaussian elimination produces an equation  $0 = c$  with non-zero  $c$ . With `ShowAssumptions`, such equations are returned via `Constraints`, provided  $c$  involves symbolic parameters. If  $c$  is a purely numerical value, then `[FAIL, NIL, [], []]` is returned.

---

See “Example 3” on page 19-183 (Symbolic Math Toolbox), “Example 4” on page 19-184 (Symbolic Math Toolbox), and “Example 7” on page 19-186 (Symbolic Math Toolbox).

### **NoWarning**

Suppresses warnings

If symbolic coefficients are found, `numeric::matlinsolve` automatically switches to the Symbolic mode with a warning. With this option, this warning is suppressed; `numeric::matlinsolve` still uses the symbolic mode for symbolic coefficients, i.e., exact arithmetic without floating-point conversions is used.

### **ReturnType**

Option, specified as `ReturnType = d`

Return the (special) solution and the kernel as matrices of domain type (Symbolic Math Toolbox)  $d$ . The following return types  $d$  are available: `DOM_ARRAY`, `DOM_HFARRAY`, `Dom::Matrix()`, or `Dom::DenseMatrix()`.

### **Sparse**

Use a sparse internal representation for matrices.

This option only has an effect when used in conjunction with `HardwareFloats`. With the `Sparse` option, the linear solver uses a sparse representation of the matrices to save memory and increase efficiency. However, if the coefficient matrix is not sparse, this option will cost some additional memory and runtime.

## **Return Values**

Without the option `ShowAssumptions`, a list `[X, KernelBasis]` is returned. The (special) solution  $X$  is an  $n \times p$  matrix. `KernelBasis` is an  $n \times d$  matrix ( $d$  is the dimension

of the kernel of  $A$ ). Its columns span the kernel of  $A$ . If the kernel is trivial, `KernelBasis` is the integer 0.

`[FAIL, NIL]` is returned if the system is not solvable.

With `ShowAssumptions`, a list `[X, KernelBasis, Constraints, Pivots]` is returned. The lists `Constraints` and `Pivots` contain equations and inequalities involving symbolic parameters in  $A$  and  $B$ . Internally these were assumed to hold true when solving the system. `[FAIL, NIL, [], []]` is returned if the system is not solvable.

## See Also

### MuPAD Functions

`linalg::matlinsolve` | `linsolve` | `numeric::inverse` | `numeric::linsolve` | `solve`

## numeric::ncdata

Weights and abscissae of Newton-Cotes quadrature

### Syntax

```
numeric::ncdata(n)
```

### Description

`numeric::ncdata(n)` returns the weights and the abscissae of the Newton-Cotes quadrature rule with  $n$  equidistant nodes.

The Newton-Cotes quadrature rule  $\sum_{i=1}^n b_i f(c_i)$  produces the exact integral  $\int_0^1 f(x) dx$  for all polynomials  $f$  through degree  $n-1$ . If  $n$  is odd, then the quadrature rule is exact through degree  $n$ .

The equidistant abscissae  $c = [c_1, \dots, c_n]$  are given by  $c_i = \frac{i-1}{n-1}$ .

### Environment Interactions

`numeric::ncdata` is not sensitive to the environment variable `DIGITS`.

The function uses option `remember`.

### Examples

#### Example 1

The following call produces exact data for the quadrature rule with four nodes:

```
numeric::ncdata(4)
```

$$\left[\left[\frac{1}{8}, \frac{3}{8}, \frac{3}{8}, \frac{1}{8}\right], \left[0, \frac{1}{3}, \frac{2}{3}, 1\right]\right]$$

## Parameters

**n**

The number of nodes: a positive integer

## Return Values

List  $[b, c]$  is returned. The lists  $b = [b_1, \dots, b_n]$  and  $c = [c_1, \dots, c_n]$  are the rational weights and abscissae of the Newton-Cotes quadrature rule, respectively.

## Algorithms

The numerical integrator `numeric::quadrature` calls `numeric::ncdata` to provide the data for Newton-Cotes quadrature.

## See Also

### MuPAD Functions

`numeric::gldata` | `numeric::gtdata` | `numeric::int` | `numeric::quadrature`

## numeric::odesolve

Numerical solution of an ordinary differential equation

### Syntax

`numeric::odesolve(f, t0 .. t, Y0, <method>, <RelativeError = rtol>, <AbsoluteError = atol>)`

`numeric::odesolve(t0 .. t, f, Y0, <method>, <RelativeError = rtol>, <AbsoluteError = atol>)`

### Description

`numeric::odesolve(f, t0..t, Y0)` returns a numerical approximation of the solution

$Y(t)$  of the first order differential equation (dynamical system)  $\frac{dY}{dt} = f(t, Y)$ ,  $Y(t_0) = Y_0$

with  $t, t_0 \in \mathbb{R}$  and  $Y(t), Y_0 \in \mathbb{C}^n$ .

`numeric::odesolve` is a general purpose solver able to deal with initial value problems

of various kinds of ordinary differential equations. Equations  $y^{(p)} = f(t, y, y', \dots, y^{(p-1)})$  of order  $p$  can be solved by `numeric::odesolve` after reformulation to dynamical system form. This can always be achieved by writing the equation as a first order system

$$\frac{d}{dt} \begin{pmatrix} Y_1 \\ \dots \\ Y_{p-1} \\ Y_p \end{pmatrix} = \begin{pmatrix} Y_2 \\ \dots \\ Y_p \\ f(t, Y_1, \dots, Y_p) \end{pmatrix}$$

for the vector  $Y = [Y_1, \dots, Y_p] = [y, y', \dots, y^{(p-1)}]$ . See "Example 4" on page 19-201 (Symbolic Math Toolbox).

The following single-step Runge-Kutta-type methods are implemented:



- EULER1 (order 1)
- RKF43 (order 3)
- xRKF43 (order 3)
- RKF34 (order 4)
- xRKF34 (order 4)
- RK4 (order 4)
- RKF54a (order 4)
- RKF54b (order 4)
- DOPRI54 (order 4)
- xDOPRI54 (order 4)
- CK54 (order 4)
- xRKF54a (order 4)
- xRKF54b (order 4)
- xCK54 (order 4)
- RKF45a (order 5)
- RKF45b (order 5)
- DOPRI45 (order 5)
- CK45 (order 5)
- xRKF45a (order 5)
- xRKF45b (order 5)
- xDOPRI45 (order 5)
- xCK45 (order 5)
- DOPRI65 (order 5)
- xDOPRI65 (order 5)
- DOPRI56 (order 6)
- xDOPRI56 (order 6)
- BUTCHER6 (order 6)
- RKF87 (order 7)
- xRKF87 (order 7)
- DOPRI87 (order 7)

- xDOPRI87 (order 7)
- RKF78 (order 8)
- xRKF78 (order 8)
- DOPRI78 (order 8)
- xDOPRI78 (order 8)
- GAUSS(s) (order 2s)
- GAUSS = s

For the Gauss methods, GAUSS(s) is equivalent to GAUSS = s. The positive integer s indicates the number of stages. The order of the s stage Gauss method is 2s.

The utility function `numeric::ode2vectorfield` may be used to produce the input parameters  $f$ ,  $t_0$ ,  $Y_0$  from a set of differential expressions representing the ODE. See "Example 1" on page 19-200 (Symbolic Math Toolbox).

The input data  $t_0$ ,  $t$  and  $Y_0$  must not contain symbolic objects which cannot be converted to floating point values via `float`. Numerical expressions such as  $e^x$ ,  $\sqrt{2}$  etc. are accepted.

The vector field  $f$  defining the dynamical system  $Y' = f(t, Y)$  must be represented by a procedure with two input parameters: the scalar time  $t$  and the vector  $Y$ . `numeric::odesolve` internally calls this function with real floating-point values  $t$  and a list  $Y$  of floating-point values. It has to return the vector  $f(t, Y)$  either as a list or as a 1-dimensional array. The output of  $f$  may contain numerical expressions such as  $\pi$ ,  $e^2$  etc. However, all values must be convertible to real or complex floating point numbers by `float`.

Autonomous systems, where  $f(t, Y)$  does not depend on  $t$ , must also be represented by a procedure with 2 arguments  $t$  and  $Y$ .

Scalar functions  $Y$  also must be represented by a list or an array with one element. For instance, the input data for the scalar initial value problem  $y' = t \sin(y)$ ,  $y(0) = 1$  may be of the form

```
f := proc(t,Y)                                     /* Y is a 1-dimensional vector */
local y;                                           /* represented by a list with */
```

```

begin                                     /* one element: Y = [y]. */
    y := Y[1];
    [t*sin(y)]                             /* the output is a list with 1 element */
end_proc:
Y0 := [1]:                                 /* the initial value */

```

The numerical precision is controlled by the global variable DIGITS: an adaptive control of the step size keeps local relative discretization errors below  $\text{rtol}=10^{-\text{DIGITS}}$ , unless a different tolerance is specified via the option `RelativeError = rtol`. For small values of the solution vector  $Y$ , the absolute discretization error can be bounded by the threshold `atol` specified via the option `AbsoluteError = atol`.

If `AbsoluteError` is not specified, only relative discretization errors are controlled and kept below `rtol`.

The error control may be switched off by specifying a fixed `Stepsize = h`.

---

**Note** Only local errors are controlled by the adaptive mechanism. No control of the global error is provided!

---

With `Y := t -> numeric::odesolve(f, t_0..t, Y_0)`, the numerical solution can be represented by a MuPAD function: the call `Y(t)` will start the numerical integration from  $t_0$  to  $t$ . A more sophisticated form of this function may be generated via `Y := numeric::odesolve2(f, t_0, Y_0)`.

This equips  $Y$  with a remember mechanism that uses previously computed values to speed up the computation. See “Example 2” on page 19-200 (Symbolic Math Toolbox).

For systems of the special form  $Y' = f(t, Y) Y$  with a matrix valued function  $f(t, Y)$ , there is a special solver `numeric::odesolveGeometric` which preserves geometric features of the system more faithfully than `numeric::odesolve`.

## Environment Interactions

The function is sensitive to the environment variable DIGITS, which determines the numerical working precision.

## Examples

### Example 1

We compute the numerical solution  $y(10)$  of the initial value problem  $y' = t \sin(y)$ ,  $y(0) = 2$ :

```
f := proc(t, Y) begin [t*sin(Y[1])] end_proc:
numeric::odesolve(f, 0..10, [2])
```

```
[3.141592654]
```

Alternatively, the utility function `numeric::ode2vectorfield` can be used to generate the input parameters in a more intuitive way:

```
[f, t0, Y0] :=
[numeric::ode2vectorfield({y'(t) = t*sin(y(t)), y(0) = 2}, [y(t)])]
```

```
[proc f(t, Y) ... end, 0, [2]]
```

```
numeric::odesolve(f, t0..10, Y0)
```

```
[3.141592654]
```

```
delete f, t0, Y0:
```

### Example 2

We consider  $y' = y$ ,  $y(0) = 1$ . The numerical solution may be represented by the function

```
Y := t -> numeric::odesolve((t,Y) -> Y, 0..t, [1]):
```

Calling `Y(t)` starts the numerical integration:

```
Y(-5), Y(0), Y(1), Y(PI)
```

```
[0.006737946999], [1.0], [2.718281828], [23.14069263]
```

```
delete Y:
```

### Example 3

We compute the numerical solution  $Y(\pi) = [x(\pi), y(\pi)]$  of the system

$$x' = x + y, y' = x - y, x(0) = 1, y(0) = \sqrt{-1}$$

```
f := (t, Y) -> [Y[1] + Y[2], Y[1] - Y[2]]: Y0 := [1, I]:
numeric::odesolve(f, 0..PI, Y0)
```

```
[72.57057163 + 30.05484302 i, 30.05484302 + 12.46088558 i]
```

The solution of a linear dynamical system  $Y' = A Y$  with a constant matrix  $A$  is

$Y(t) = e^{tA} Y_0$ . The solution of the system above can also be computed by:

```
t := PI: tA := array(1..2, 1..2, [[t, t], [t, -t]]):
numeric::expMatrix(tA, Y0)
```

```
( 72.57057163 + 30.05484303 i
 30.05484303 + 12.46088558 i)
```

```
delete f, Y0, t, tA:
```

### Example 4

We compute the numerical solution  $y(1)$  of the differential equation  $y'' = y^2$  with initial conditions  $y(0) = 0, y'(0) = 1$ . The second order equation is converted to a first order system for the vector  $Y = [y, y'] = [y, z]$ :

$$y' = z, z' = y^2, y(0) = 0, z(0) = 1$$

```
f := proc(t, Y) begin [Y[2], Y[1]^2] end_proc:
Y0 := [0, 1]:
numeric::odesolve(f, 0..1, Y0)
```

```
[1.087473533, 1.362851121]
```

```
delete f, Y0:
```

## Example 5

We demonstrate how numerical data can be obtained on a user defined time mesh  $t[i]$ . The initial value problem is  $y' = \sin(t) - y$ ,  $y(0) = 1$ , the sample points are  $t_0 = 0.0$ ,  $t_1 = 0.1$ , ...,  $t_{100} = 10.0$ . First, we define the differential equation and the initial condition:

```
f := (t, Y) -> [sin(t) - Y[1]]:  
Y[0] := [1]:
```

We define the time mesh:

```
for i from 0 to 100 do t[i] := i/10 end_for:
```

The equation is integrated iteratively from  $t[i-1]$  to  $t[i]$  with a working precision of 4 significant decimal places:

```
DIGITS := 4:  
for i from 1 to 100 do  
  Y[i] := numeric::odesolve(f, t[i-1]..t[i], Y[i-1])  
end_for:
```

The following mesh data are produced:

```
[t[i], Y[i]] $ i = 0..100
```

```
[0, [1]], [1/10, [0.9097]], [1/5, [0.8374]], [3/10, [0.7813]], [2/5, [0.7397]], ...,  
[99/10, [0.2159]], [10, [0.1476]]]
```

$[0, [1]], \left[\frac{1}{10}, [0.9097]\right], \left[\frac{1}{5}, [0.8374]\right], \left[\frac{3}{10}, [0.7813]\right], \left[\frac{2}{5}, [0.7397]\right], \left[\frac{1}{2}, [0.7107]\right],$   
 $\left[\frac{3}{5}, [0.6929]\right], \left[\frac{7}{10}, [0.6846]\right], \left[\frac{4}{5}, [0.6843]\right], \left[\frac{9}{10}, [0.6907]\right], [1, [0.7024]],$   
 $\left[\frac{11}{10}, [0.7181]\right], \left[\frac{6}{5}, [0.7366]\right], \left[\frac{13}{10}, [0.7568]\right], \left[\frac{7}{5}, [0.7776]\right], \left[\frac{3}{2}, [0.7981]\right],$   
 $\left[\frac{8}{5}, [0.8172]\right], \left[\frac{17}{10}, [0.8343]\right], \left[\frac{9}{5}, [0.8485]\right], \left[\frac{19}{10}, [0.8591]\right], [2, [0.8657]],$   
 $\left[\frac{21}{10}, [0.8677]\right], \left[\frac{11}{5}, [0.8647]\right], \left[\frac{23}{10}, [0.8564]\right], \left[\frac{12}{5}, [0.8425]\right], \left[\frac{5}{2}, [0.8229]\right],$   
 $\left[\frac{13}{5}, [0.7976]\right], \left[\frac{27}{10}, [0.7665]\right], \left[\frac{14}{5}, [0.7298]\right], \left[\frac{29}{10}, [0.6876]\right], [3, [0.6402]],$   
 $\left[\frac{31}{10}, [0.5879]\right], \left[\frac{16}{5}, [0.5311]\right], \left[\frac{33}{10}, [0.4702]\right], \left[\frac{17}{5}, [0.4057]\right], \left[\frac{7}{2}, [0.3381]\right],$   
 $\left[\frac{18}{5}, [0.2681]\right], \left[\frac{37}{10}, [0.1962]\right], \left[\frac{19}{5}, [0.1231]\right], \left[\frac{39}{10}, [0.04945]\right], [4, [-0.02411]],$   
 $\left[\frac{41}{10}, [-0.09687]\right], \left[\frac{21}{5}, [-0.1682]\right], \left[\frac{43}{10}, [-0.2373]\right], \left[\frac{22}{5}, [-0.3037]\right],$   
 $\left[\frac{9}{2}, [-0.3667]\right], \left[\frac{23}{5}, [-0.4257]\right], \left[\frac{47}{10}, [-0.4801]\right], \left[\frac{24}{5}, [-0.5295]\right],$   
 $\left[\frac{49}{10}, [-0.5733]\right], [5, [-0.6112]], \left[\frac{51}{10}, [-0.6428]\right], \left[\frac{26}{5}, [-0.6677]\right], \left[\frac{53}{10}, [-0.6858]\right],$   
 $\left[\frac{27}{5}, [-0.697]\right], \left[\frac{11}{2}, [-0.701]\right], \left[\frac{28}{5}, [-0.6979]\right], \left[\frac{57}{10}, [-0.6877]\right], \left[\frac{29}{5}, [-0.6705]\right],$   
 $\left[\frac{59}{10}, [-0.6466]\right], [6, [-0.6161]], \left[\frac{61}{10}, [-0.5794]\right], \left[\frac{31}{5}, [-0.5368]\right], \left[\frac{63}{10}, [-0.4888]\right],$   
 $\left[\frac{32}{5}, [-0.4358]\right], \left[\frac{13}{2}, [-0.3785]\right], \left[\frac{33}{5}, [-0.3173]\right], \left[\frac{67}{10}, [-0.2529]\right],$   
 $\left[\frac{34}{5}, [-0.186]\right], \left[\frac{69}{10}, [-0.1171]\right], [7, [-0.04709]], \left[\frac{71}{10}, [0.02345]\right], \left[\frac{36}{5}, [0.09378]\right],$   
 $\left[\frac{73}{10}, [0.1632]\right], \left[\frac{37}{5}, [0.231]\right], \left[\frac{15}{2}, [0.2965]\right], \left[\frac{38}{5}, [0.3591]\right], \left[\frac{77}{10}, [0.4181]\right],$   
 $\left[\frac{39}{5}, [0.4729]\right], \left[\frac{79}{10}, [0.523]\right], [8, [0.5679]], \left[\frac{81}{10}, [0.6072]\right], \left[\frac{41}{5}, [0.6404]\right],$

These data can be displayed by a list plot:

```
plotpoints := [[t[i], op(Y[i])] $ i = 0..100]:  
plot(plot::PointList2d(plotpoints, PointColor = RGB::Black)):
```

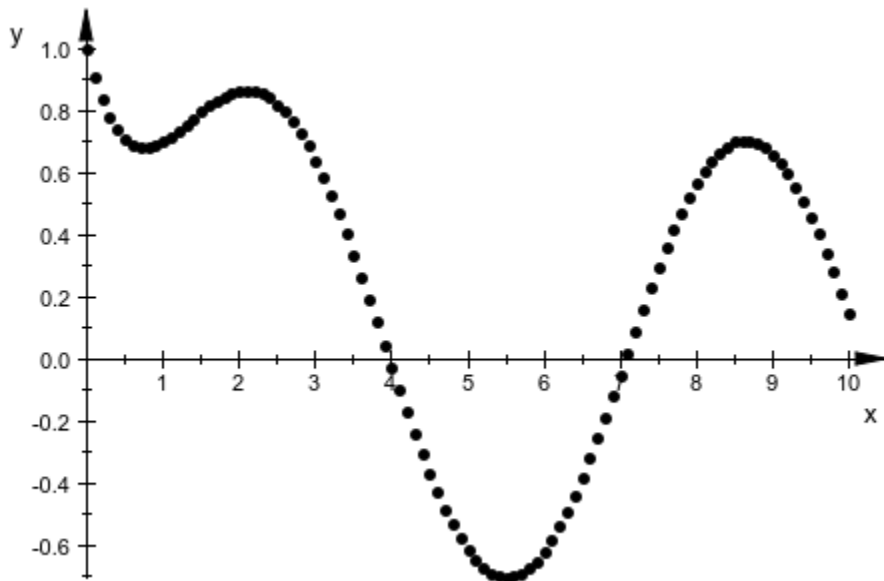

The same plot can be obtained directly via `plot::Ode2d`:

```
plot(plot::Ode2d(  
    [t[i] $ i = 0..100], f, Y[0],  
    [(t, Y) -> [t, Y[1]], Style = Points, Color = RGB::Black]))
```



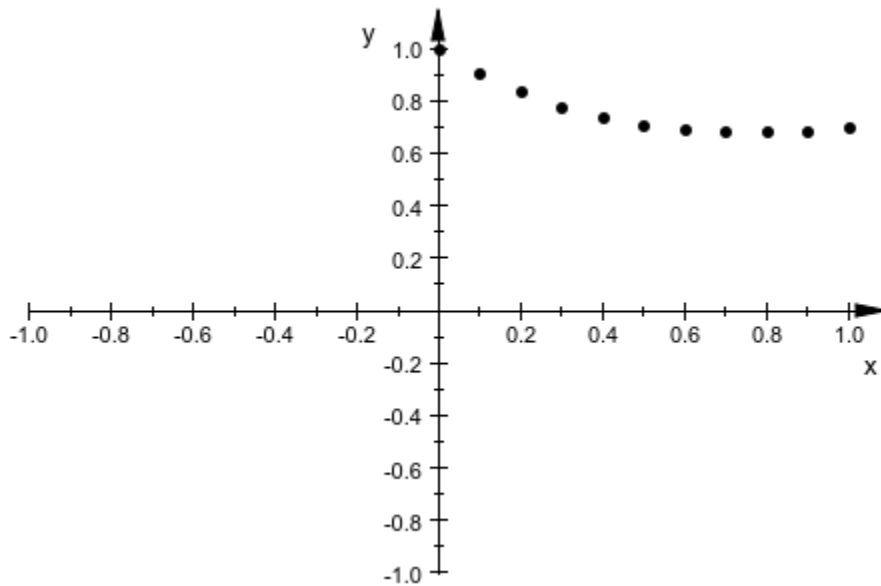

```
delete f, t, DIGITS, Y, plotpoints:
```

## Example 6

We compute the numerical solution  $y(1)$  of  $y' = y$ ,  $y(0) = 1$  by the classical 4-th order Runge-Kutta method RK4. By internal local extrapolation, its effective order is 5:

```
f := (t, Y) -> Y:
DIGITS := 13:
numeric::odesolve(f, 0..1, [1], RK4)
```

```
[2.718281828459]
```

Next, we use local extrapolation xRK78 of the 8-th order submethod of the Runge-Kutta-Fehlberg pair RKF78. This scheme has effective order 9:

```
numeric::odesolve(f, 0..1, [1], xRK78)
```

```
[2.718281828459]
```

Both methods yield the same result because of the internal adaptive error control. However, due to its higher order, the method xRK78 is faster.

```
delete f, DIGITS:
```

## Example 7

We consider the stiff ODE  $y' = 10^4 (\cos(t) - y)$ ,  $y(0) = 1$ . The default method DOPRI78 is explicit and not very efficient in solving very stiff problems:

```
f := (t, Y) -> [10^4*(cos(t) - Y[1])]:  
t0 := time():  
numeric::odesolve(f, 0..1, [1]), (time() - t0)*msec
```

```
[0.5403864476], 16065.004 msec
```

We use the implicit A-stable method GAUSS(6). For this stiff problem, it is more efficient than the default method DOPRI78:

```
t0 := time():  
numeric::odesolve(f, 0..1, [1], GAUSS(6)), (time() - t0)*msec
```

```
[0.5403864476], 796.05 msec
```

```
delete t0:
```

## Example 8

We consider the initial value problem  $y' = -10^{20} y (1 - \cos(y))$ ,  $y(0) = 1$ . We note that the numerical evaluation of the right hand side of the equation suffers from cancellation effects, when  $|y|$  is small.

```
f := (t, Y) -> [-10^20*Y[1]*(1 - cos(Y[1]))]:  
Y0 := [1]:
```

We first attempt to compute  $y(1)$  with a working precision of 6 digits using the default setting `RelativeError = 10^-DIGITS=10^(-6)`:

```
DIGITS := 6: numeric::odesolve(f, 0..1, Y0)
```

```
[0.000000000329271]
```

Due to numerical round-off in the internal steps, no digit of this result is correct. Next, we use a working precision of 20 significant decimal places to eliminate roundoff effects:

```
DIGITS := 20:
numeric::odesolve(f, 0..1, Y0, RelativeError = 10^(-6))
```

```
[0.00000000010000000007495004558]
```

Since relative local discretization errors are of the magnitude  $10^{-6}$ , not all displayed digits are trustworthy. We finally use a working precision of 20 digits and constrain the local relative discretization errors by the tolerance  $10^{-10}$ :

```
numeric::odesolve(f, 0..1, Y0, RelativeError = 10^(-10))
```

```
[0.00000000010000000000003105061]
```

```
delete f, Y0, DIGITS:
```

## Example 9

We compute the numerical solution  $y(1)$  of  $y' = y$ ,  $y(0) = 1$  with various methods and various constant step sizes. We compare the result with the exact solution

$y(1) = e = 2.718281828\dots$

```
f := (t, Y) -> Y:
Y0 := [1]:
```

We first use the Euler method of order 1 with two different step sizes:

```
Y := numeric::odesolve(f, 0..1, Y0, EULER1, StepSize = 0.1):
Y, globalerror = float(exp(1)) - Y[1]
```

```
[2.59374246], globalerror = 0.1245393684
```

Decreasing the step size by a factor of 10 should reduce the global error by a factor of 10. Indeed:

```
Y := numeric::odesolve(f, 0..1, Y0, EULER1, Stepsize = 0.01):  
Y, globalerror = float(exp(1)) - Y[1]
```

```
[2.704813829], globalerror = 0.01346799904
```

Next, we use the classical Runge-Kutta method of order 4 with two different step sizes:

```
Y := numeric::odesolve(f, 0..1, Y0, RK4, Stepsize = 0.1):  
Y, globalerror = float(exp(1)) - Y[1]
```

```
[2.718279744], globalerror = 0.00000208432388
```

Decreasing the step size by a factor of 10 in a 4-th order scheme should reduce the global error by a factor of  $10^4$ . Indeed:

```
Y := numeric::odesolve(f, 0..1, Y0, RK4, Stepsize = 0.01):  
Y, globalerror = float(exp(1)) - Y[1]
```

```
[2.718281828], globalerror = 0.000000002246438591
```

```
delete f, Y0, Y:
```

## Example 10

We integrate  $y' = y^2$ ,  $y(0) = 1$  over the interval  $t \in [0, 0.99]$  with a working precision of 4 digits. The exact solution is  $y(t) = \frac{1}{1-t}$ . Note the singularity at  $t = 1$ .

```
DIGITS := 4:  
f := (t, Y) -> [Y[1]^2]:  
Y0 := [1]:
```

The option `Alldata`, equivalent to `Alldata = 1`, yields all mesh data generated during the internal adaptive process:

```
numeric::odesolve(f, 0..0.99, Y0, Alldata)
```

```
[[[0.0, [1.0]], [0.4933, [1.974]], [0.74, [3.846]], [0.8633, [7.314]], [0.9249, [13.32]],  
[0.9558, [22.61]], [0.9712, [34.71]], [0.9866, [74.68]], [0.99, [99.97]]]
```

With `Alldata = 2`, only each second point is returned:

```
numeric::odesolve(f, 0..0.99, Y0, Alldata = 2)
```

```
[[0.0, [1.0]], [0.74, [3.846]], [0.9249, [13.32]], [0.9712, [34.71]], [0.99, [99.97]]]
```

One can control the time mesh using the option `Stepsize = h`:

```
numeric::odesolve(f, 0..0.99, Y0, Stepsize=0.1, Alldata = 1)
```

```
[[0.0, [1.0]], [0.1, [1.111]], [0.2, [1.25]], [0.3, [1.429]], [0.4, [1.667]], [0.5, [2.0]],  
 [0.6, [2.5]], [0.7, [3.333]], [0.8, [5.0]], [0.9, [10.0]], [0.99, [94.3]]]
```

However, with the option `Stepsize = h`, no automatic error control is provided by `numeric::odesolve`. Note the poor approximation  $y(t) = 94.3$  for  $t = 0.99$  (the exact value is  $y(0.99) = 100.0$ ). The next computation with smaller step size yields better results:

```
numeric::odesolve(f, 0..0.99, Y0, Stepsize = 0.01, Alldata = 10)
```

```
[[0.0, [1.0]], [0.1, [1.111]], [0.2, [1.25]], [0.3, [1.429]], [0.4, [1.667]], [0.5, [2.0]],  
 [0.6, [2.5]], [0.7, [3.333]], [0.8, [5.0]], [0.9, [10.0]], [0.99, [100.0]]]
```

“Example 5” on page 19-202 (Symbolic Math Toolbox) demonstrates how accurate numerical data on a user defined time mesh can be generated using the automatic error control of `numeric::odesolve`.

```
delete DIGITS, f, Y0:
```

## Example 11

The second order equation  $y'' + \sin(y) = 0$  is written as the dynamical system  $y' = z$ ,  $z' = -\sin(y)$  for the vector  $Y = [y, z]$ . A single symbolic step

$$[y(t_0), z(t_0)] \rightarrow [y(t_0 + h), z(t_0 + h)]$$

of the Euler method is computed:

```
f := proc(t, Y) begin [Y[2], -sin(Y[1])] end_proc:  
numeric::odesolve(f, t0..t0+h, [y0, z0], EULER1, Symbolic)
```

```
[y0 + h z0, z0 - h sin(y0)]
```

```
delete f:
```

## Parameters

**f**

A procedure representing the vector field

**t<sub>0</sub>**

A numerical real value for the initial time

**t**

A numerical real value (the “time”)

**Y<sub>0</sub>**

A list or 1-dimensional array of numerical values representing the initial condition

**method**

One of the Runge-Kutta schemes listed below.

## Options

**BUTCHER6, CK45, CK54, DOPRI45, DOPRI54, DOPRI56, DOPRI65, DOPRI78, DOPRI87, EULER1, RK4, RKF34, RKF43, RKF45a, RKF45b, RKF54a, RKF54b, RKF78, RKF87, xCK45, xCK54, xDOPRI45, xDOPRI54, xDOPRI56, xDOPRI65, xDOPRI78, xDOPRI87, xRKF34, xRKF43, xRKF45a, xRKF45b, xRKF54a, xRKF54b, xRKF78, xRKF87**

Name of the Runge-Kutta scheme. See “Example 6” on page 19-205 (Symbolic Math Toolbox). For details on these schemes, see the Algorithms section.

**GAUSS**

Name of the Runge-Kutta scheme specified as `GAUSS(s)` or `GAUSS = s`.

The methods `GAUSS(s)` or, equivalently, `GAUSS = s` are the implicit Gauss methods with `s` stages of order  $2s$ .

These methods are implicit A-stable schemes. The time steps are rather costly to compute. The Gauss methods are useful for integrating stiff ODEs. For non-stiff ODEs, there is usually no need to change the default method `DOPRI78`. This method is an embedded Runge-Kutta pair of orders 7 and 8.

Further, the Gauss methods are symplectic methods. When used with constant step size (`Stepsize = h`), numerical integration of Hamiltonian systems benefits from this property.

See “Example 7” on page 19-206 (Symbolic Math Toolbox).

**RelativeError, AbsoluteError**

Option specified as `RelativeError = rtol` forces internal numerical Runge-Kutta steps to use step sizes with relative local discretization errors below `rtol`. This tolerance

must be a positive numerical real value not smaller than  $\frac{1}{10^{\text{DIGITS}}}$ . The default tolerance is `RelativeError = 10(-DIGITS)`.

Option specified as `AbsoluteError = atol` forces internal numerical Runge-Kutta steps to use step sizes with absolute local discretization errors below `atol`. This tolerance must be a nonnegative numerical real value. The default tolerance is `AbsoluteError = 10(-10*DIGITS)`.

The internal control mechanism estimates the local discretization error of a Runge-Kutta step and adjusts the step size adaptively to keep this error below the specified tolerances `rtol` or `atol`, respectively. The code uses the criterion

$$\|\text{discretization error}\|_{\infty} = \max(\|Y\|_{\infty} \text{rtol}, \text{atol})$$

For accepting a solution vector  $Y$ . Roughly speaking, the relative error is controlled when the solution  $Y$  is sufficiently large. For very small solution values  $Y$ , absolute discretization errors are kept below the threshold `atol`.

Specify `AbsoluteError = 0` if only control of the relative discretization errors is desired.

The error control may be switched off by specifying a fixed `Stepsize = h`.

The default setting of  $\text{rtol} = \frac{1}{10^{\text{DIGITS}}}$ ,  $\text{atol} = \frac{1}{10^{\text{DIGITS}}}$  ensures that the local discretization errors are of the same order of magnitude as numerical roundoff.

Usually there is no need to use these options to change this setting. However, occasionally the numerical evaluation of the Runge-Kutta steps may be ill-conditioned or step sizes are so small that the time parameter cannot be incremented by the step size within working precision. In such a case these options may be used to bound the local discretization errors and use a higher working precision given by `DIGITS`.

Only positive real numerical values  $\text{rtol} \geq \frac{1}{10^{\text{DIGITS}}}$  are accepted.

---

**Note** The global error of the result returned by `numeric::odesolve` is usually larger than the local errors bounded by `rtol`, `atol`, respectively. Although the result is displayed with `DIGITS` decimal places one should not expect that all of them are correct. The relative precision of the final result is `rtol` at best!

---

See “Example 8” on page 19-206 (Symbolic Math Toolbox).

### Stepsize

Option, specified as `Stepsize = h`

Switches off the internal error control and uses a Runge-Kutta iteration with constant step size `h` which must be a positive numerical value.

By default, `numeric::odesolve` uses an adaptive step size control mechanism in the numerical iteration. The option `Stepsize = h` switches off this adaptive mechanism and uses the Runge-Kutta method specified (or the default method `DOPRI78`) with constant step size `h`.

A final step with smaller step size is used to match the end `t` of the integration interval

`t_0 . . t` if  $\frac{t-t_0}{h}$  is not an integer.



**Note** With this option, there is no automatic error control! Depending on the problem and on the order of the method the result may be a poor numerical approximation of the exact solution.

---

There is usually no need to invoke this option. However, occasionally the built-in adaptive error control mechanism may fail when integrating close to a singularity. In such a case this option may be used to customize a control mechanism for the global error by using different step sizes and investigating the convergence of the corresponding results.

Cf. “Example 9” on page 19-207 (Symbolic Math Toolbox).

### **MaxStepsize**

Option, specified as `MaxStepsize = hmax`

Restricts adaptive step sizes to values not larger than `h_max`; `h_max` must be a positive numerical value.

By default, `numeric::odesolve` uses an adaptive step size control mechanism in the numerical iteration. The option `MaxStepsize = hmax` restricts the adaptive step size to values no larger than `hmax`.

If a larger stepsize `h` is requested explicitly by `Stepsize = h`, the option `MaxStepsize = hmax` reduces `h` to `hmax`.

### **Alldata**

Option, specified as `Alldata = n`

Makes `numeric::odesolve` return a list of numerical mesh points generated by the internal Runge-Kutta iteration. The integer `n` controls the size of the output list.

With this option, `numeric::odesolve` returns a list of numerical mesh points `[[t0, Y0], [t1, Y1], ..., [t, Y(t)]]` generated by the internal Runge-Kutta iteration.

The integer `n` controls the size of the output list. For `n = 1`, all internal mesh points are returned. This case may also be invoked by entering the simplified option `Alldata`, which is equivalent to `Alldata = 1`. For `n > 1`, only each `n`-th mesh point is stored in the list. The list always contains the initial point `[t0, Y0]` and the final point `[t, Y(t)]`. For `n ≤ 0`, only the data `[[t0, Y0], [t, Y(t)]]` are returned.

The output list may be useful to inspect the internal numerical process. Also further graphical processing of the mesh data may be useful.

Cf. "Example 10" on page 19-208 (Symbolic Math Toolbox).

### **Symbolic**

Makes `numeric::odesolve` return a vector of symbolic expressions representing a single symbolic step of the Runge-Kutta iteration.

The call `numeric::odesolve(f, t0..t, Y0, < method >, Symbolic)` returns a vector (list or array) of expressions representing a single step of the numerical scheme with step size  $t - t_0$ . In this mode symbolic values for  $t_0$ ,  $t$  and the components of  $Y_0$  are accepted.

This option may be useful if the specified numerical method applied to a given differential equation is to be investigated symbolically.

Cf. "Example 11" on page 19-209 (Symbolic Math Toolbox).

## **Return Values**

The solution vector  $Y(t)$  is returned as a list or as a 1-dimensional array of floating-point values. The type of the result vector coincides with the type of the input vector  $Y_0$ .

With the option `Alldata`, a list of mesh data is returned.

## **References**

J.C. Butcher: "The Numerical Analysis of Ordinary Differential Equations", Wiley, Chichester (1987).

E. Hairer, S.P. Norsett and G. Wanner: "Solving Ordinary Differential Equations I", Springer, Berlin (1993).

## Algorithms

All methods presently implemented are adaptive versions of Runge-Kutta type single step schemes.

The methods RKF43, RKF34, RKF54a, RKF54b, RKF45a, RKF45b, RKF87, RKF78, DOPRI54, DOPRI45, DOPRI65, DOPRI56, DOPRI87, DOPRI78, CK54, CK45 are embedded pairs of Runge-Kutta-Fehlberg, Dormand-Prince and Cash-Karp type, respectively. Estimates of the local discretization error are obtained in the usual way by comparing the results of the two submethods of the pair. The names indicate the orders of the subprocesses. For instance, RKF34 and RKF43 denote the same embedded Runge-Kutta-Fehlberg pair with orders 3 and 4. In RKF34 the result of the fourth order submethod is accepted, whereas RKF43 advances using the result of the third order submethod. In both cases the discretization error of the lower order subprocess is estimated and controlled.

For the single methods EULER1 (the first order Euler scheme), RK4 (the classical fourth order Runge-Kutta scheme) and BUTCHER6 (a Runge-Kutta scheme of order 6), the relative local error is controlled by comparing steps with different step sizes. The effective order of these methods is increased by one through local extrapolation.

Local extrapolation is also available for the submethods of the embedded pairs. For instance, the method xRKF78 uses extrapolation of the 8-th order subprocess of RKF78, yielding a method of effective order 9. The 7-th order subprocess is ignored. The cheap error estimate based on the embedded pair is not used implying some loss of efficiency when comparing RKF78 (order 8) and xRKF78 (effective order 9).

The call `numeric::butcher(method)` returns the Butcher data of the methods used in `numeric::odesolve`. Here `method` is one of EULER1, RKF43, RK4, RKF34, RKF54a, RKF54b, DOPRI54, CK54, RKF45a, RKF45b, DOPRI45, CK45, DOPRI65, DOPRI56, BUTCHER6, RKF87, DOPRI87, RKF78, DOPRI78.

---

**Note** Only local errors are controlled by the adaptive mechanism. No control of the global error is provided!

---

---

**Note** The run time of the numerical integration with a method of order  $p$  grows like

$O\left(10^{\frac{\text{DIGITS}}{p+1}}\right)$ , when DIGITS is increased. Computations with high precision goals are very expensive! High order methods such as the default method DOPRI78 should be used.

---

Presently, only single step methods of Runge-Kutta type are implemented. Stiff problems cannot be handled efficiently with explicit methods such as the default method DOPRI78. For stiff problems, one may use one of the implicit A-stable methods GAUSS(s). See “Example 7” on page 19-206 (Symbolic Math Toolbox).

For problems of the special type  $Y' = f(t, Y) Y$  with a matrix valued function  $f(t, Y)$ , there is a specialized (“geometric”) integration routine `numeric::odesolveGeometric`. Generally, `numeric::odesolve` is faster than the geometric integrator. However, `odesolveGeometric` preserves certain invariants of the system more faithfully.

## See Also

### MuPAD Functions

`numeric::butcher` | `numeric::odesolve2` | `numeric::odesolveGeometric`

### MuPAD Graphical Primitives

`plot::ode2d` | `plot::ode3d`

## Topics

“Solve Equations Numerically” (Symbolic Math Toolbox)

# numeric::odesolve2

Numerical solution of an ordinary differential equation

## Syntax

`numeric::odesolve2(f, t0, Y0, <method>, <RememberLast>, <RelativeError = rtol>, <Absolu`

## Description

`numeric::odesolve2( f, t0, Y0, ... )` returns a function representing the numerical solution  $Y(t)$  of the first order differential equation (dynamical system)  $\frac{dY}{dt} = f(t, Y)$ ,  $Y(t_0) = Y_0$  with  $t, t_0 \in \mathbb{R}$  and  $Y(t), Y_0 \in \mathbb{C}^n$ .

The utility function `numeric::ode2vectorfield` may be used to produce the input parameters `f`, `t0`, `Y0` from a set of differential expressions representing the ODE. Cf. "Example 1" on page 19-218 (Symbolic Math Toolbox).

The function generated by `Y := numeric::odesolve2(f, t0, Y0)` is essentially

`Y := t -> numeric::odesolve(t_0..t, f, Y_0)`.

Numerical integration is launched, when `Y` is called with a real numerical argument. The call `Y(t)` returns the solution vector in a format corresponding to the type of the initial condition  $Y_0$  with which `Y` was defined: `Y(t)` either yields a list or a 1-dimensional array.

If `t` is not a real numerical value, then `Y(t)` returns a symbolic function call.

See the help page of `numeric::odesolve` for details on the parameters and the options.

The options `Alldata = n` and `Symbolic` accepted by `numeric::odesolve` have no effect: `numeric::odesolve2` ignores these options.

---

**Note** Without `RememberLast`, the function `Y` remembers all values it has computed. When calling `Y(T)`, it searches its remember table for the time  $t_0 < T < t$  closest to  $t$ , and

integrates from  $T$  to  $t$  using the previously computed  $Y(T)$  as initial value. Here,  $t_0$  is the time for which the initial value of the ODE is given. This reduces the costs of a call considerably, if  $Y$  must be evaluated many times, for example, when plotting the ODE solution. The best approach is to call  $Y$  only with a monotonically increasing (or decreasing) sequence of values  $t$  starting from  $t_0$ . Further, the function must be re-initialized whenever DIGITS is increased. See “Example 3” on page 19-221 (Symbolic Math Toolbox).

---

## Environment Interactions

The function returned by `numeric::odesolve2` is sensitive to the environment variable DIGITS, which determines the numerical working precision.

Without `RememberLast`, the function returned by `numeric::odesolve2` uses option `remember`.

## Examples

### Example 1

The numerical solution of the initial value problem  $y' = t \sin(y)$ ,  $y(0) = 2$  is represented by the following function  $Y = [y]$ :

```
f := (t, Y) -> [t*sin(Y[1])]:
```

Alternatively, the utility function `numeric::ode2vectorfield` can be used to generate the input parameters in a more intuitive way:

```
[f, t0, Y0] :=  
  [numeric::ode2vectorfield({y'(t) = t*sin(y(t)), y(0) = 2}, [y(t)])]
```

```
  [proc f(t, Y) ... end, 0, [2]]
```

```
Y := numeric::odesolve2(f, t0, Y0)
```

```
  proc Y(t) ... end
```

The procedure `Y` starts the numerical integration when called with a numerical argument:

```
Y(-2), Y(0), Y(0.1), Y(PI + sqrt(2))
```

```
[2.968232567], [2.0], [2.004541745], [3.141552691]
```

Calling `Y` with a symbolic argument yields a symbolic call:

```
Y(t), Y(t + 5), Y(t^2 - 4)
```

```
Y(t), Y(t+5), Y(t^2-4)
```

```
eval(subs(%, t = PI))
```

```
[3.132357009], [3.141592654], [3.141592611]
```

The numerical solution can be plotted. Note that `Y(t)` returns a list, so we plot the list element `Y(t)[1]`:

```
plotfunc2d(Y(t)[1], t = -5..5):
```

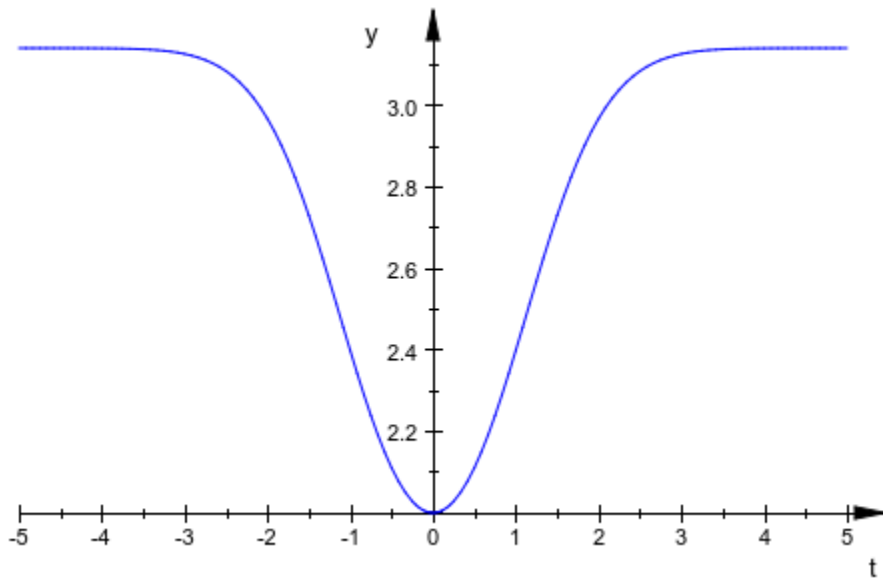

```
delete f, t0, Y0, Y:
```

## Example 2

We consider the differential equation  $y'' = y^2$  with initial conditions  $y(0) = 0$ ,  $y'(0) = 1$ .

The second order equation is converted to a first order system for  $Y = [Y_1, Y_2] = [y, y']$ :

$$Y_1' = Y_2, Y_2' = Y_1^2, Y_1(0) = 0, Y_2(0) = 1$$

```
f := (t, Y) -> [Y[2], Y[1]^2]:
t0 := 0: Y0 := [0, 1]:
Y := numeric::odesolve2(f, t0, Y0):
Y(1), Y(PI)
```

```
[1.087473533, 1.362851121], [1274.867469, 37166.52262]
```

```
delete f, t0, Y0, Y:
```



### Example 3

We consider the system

$$x' = x + y, y' = x - y, x(0) = 1, y(0) = \sqrt{-1} .$$

```
f := (t, Y) -> [Y[1] + Y[2], Y[1] - Y[2]]:
Y := numeric::odesolve2(f, 0, [1, I]):
DIGITS := 5:
Y(1)
```

```
[3.5465 + 1.3683 i, 1.3683 + 0.80988 i]
```

Increasing DIGITS does not lead to a more accurate result because of the remember mechanism:

```
DIGITS := 15: Y(1)
```

```
[3.54648112716477 + 1.36829878277279 i, 1.36829878277279 + 0.809883561619181 i]
```

This is the previous value computed with 5 digits, printed with 15 digits. Indeed, only 5 digits are correct. For getting a result that is accurate to full precision, one has to erase the remember table via `Y:=subsop(Y,5=NIL)`. Alternatively, one may create a new numerical solution with a fresh (empty) remember table:

```
Y := numeric::odesolve2(f, 0, [1, I]):
Y(1)
```

```
[3.54648242861716 + 1.36829887200859 i, 1.36829887200859 + 0.80988468459998 i]
```

```
delete f, Y, DIGITS:
```

### Example 4

We demonstrate the effect of the option RememberLast. We consider the ODE

$$y'(t) = -y + \sin(t), y(0) = 1 .$$

```
f := (t, Y) -> [-Y[1] + sin(t)]:  
Y := numeric::odesolve2(f, 0, [1]):  
Z := numeric::odesolve2(f, 0, [1], RememberLast):
```

After many calls of Y, its remember table has grown large. In each call, searching the remember table for input parameters close to the present time value becomes expensive. Created with RememberLast, the procedure Z does not remember all its previously computed values apart from the last one. Consequently, it becomes faster than Y:

```
time(for i from 1 to 1000 do Y(i/100) end)*msec,  
time(for i from 1 to 1000 do Z(i/100) end)*msec
```

11592.724 msec, 4352.272 msec

Apart from the efficiency, the values returned by Y and Z coincide:

```
Y(10.5), Z(10.5)
```

$[-0.2020381113], [-0.2020381113]$

```
delete f, Y, Z, i:
```

## Parameters

**f**

A procedure representing the vector field of the dynamical system

**$t_0$**

A numerical real value for the initial time

**$Y_0$**

A list or 1-dimensional array of numerical values representing the initial value

**method**

One of the Runge-Kutta schemes listed below.

## Options

BUTCHER6, CK45, CK54, DOPRI45, DOPRI54, DOPRI56, DOPRI65, DOPRI78, DOPRI87, EULER1, GAUSS, RK4, RKF34, RKF43, RKF45a, RKF45b, RKF54a, RKF54b, RKF78, RKF87, xCK45, xCK54, xDOPRI45, xDOPRI54, xDOPRI56, xDOPRI65, xDOPRI78, xDOPRI87, xRKF34, xRKF43, xRKF45a, xRKF45b, xRKF54a, xRKF54b, xRKF78, xRKF87

Option, specified as `GAUSS = s`

Name of the Runge-Kutta scheme. For details, see the documentation of `numeric::odesolve`.

### RememberLast

Modifies the internal remember mechanism: the procedure returned by `numeric::odesolve2` does not remember the results of all previous calls, but only the result of the last call.

Without this option, the procedure returned by `numeric::odesolve2` employs option `remember` to remember the results of all preceding calls. If the function is called very often (hundreds or thousands of times), the remember table grows large and searching this table for entries close to the current time value may become costly. With `RememberLast`, the procedure returned by `numeric::odesolve2` does not use option `remember` to remember *all* previous results but implements a very simple and inexpensive mechanism to remember only the result of the very last call.

This option is highly recommended when the numerical procedure returned by `numeric::odesolve2` is to be called often (hundreds of thousands of times) with monotonically increasing or decreasing time values. Cf. “Example 4” on page 19-221 (Symbolic Math Toolbox).

### RelativeError

Option, specified as `RelativeError = rtol`

Forces internal numerical Runge-Kutta steps to use step sizes with relative local discretization errors below `rtol`. This tolerance must be a positive numerical real value

not smaller than  $\frac{1}{2^{DIGITS}}$ . The default tolerance is `RelativeError = 10(-DIGITS)`. See the help page of `numeric::odesolve` for further details.

**AbsoluteError**

Option, specified as `AbsoluteError = atol`

Forces internal numerical Runge-Kutta steps to use step sizes with absolute local discretization errors below `atol`. This tolerance must be a non-negative numerical real value. The default tolerance is `AbsoluteError = 10^(-10*DIGITS)`. See the help page of `numeric::odesolve` for further details.

**Stepsize**

Option, specified as `Stepsize = h`

Switches off the internal error control and uses a Runge-Kutta iteration with constant step size `h`. `h` must be a positive real value. See the help page of `numeric::odesolve` for further details.

**MaxStepsize**

Option, specified as `MaxStepsize = hmax`

Restricts adaptive step sizes to values not larger than  $h_{\max}$ ;  $h_{\max}$  must be a positive numerical value. See the help page of `numeric::odesolve` for further details.

**Return Values**

Procedure.

**See Also****MuPAD Functions**

`numeric::ode2vectorfield` | `numeric::odesolve` |  
`numeric::odesolveGeometric`

**MuPAD Graphical Primitives**

`plot::ode2d` | `plot::ode3d`

## **Topics**

“Solve Equations Numerically” (Symbolic Math Toolbox)

## numeric::odesolveGeometric

Numerical solution of an ordinary differential equation on a homogeneous manifold

### Syntax

`numeric::odesolveGeometric(f, t0 .. t, Y0, <LieGroupAction = LAMBDA>, <method>, <Relati`

`numeric::odesolveGeometric(t0 .. t, f, Y0, <LieGroupAction = LAMBDA>, <method>, <Relati`

### Description

`numeric::odesolveGeometric(f, t0..t, Y0 )` approximates the solution of

$\frac{dY(t)}{dt} = f(t, Y(t)) Y(t)$ , where  $f(t, Y(t))$  returns  $n \times n$  matrices and  $Y \in \mathbb{C}^{n \times m}$ .

`numeric::odesolveGeometric` is a “geometrical integrator” for ordinary differential equations on homogeneous manifolds embedded in the space of  $n \times m$  matrices.

The call `numeric::odesolveGeometric(f, t0..t, Y0 )` returns a numerical approximation of the solution  $Y(t)$  of the first order differential equation (dynamical system)

$$\frac{dY(t)}{dt} = f(t, Y(t)) Y(t), Y(t_0) = Y_0$$

with  $t, t_0 \in \mathbb{R}$ . Here,  $Y(t)$  is a curve of  $n \times m$  matrices ( or vectors in  $\mathbb{R}^n$  or  $\mathbb{C}^n$ ). The function  $f$  must produce  $n \times n$  matrices as return values.

The following geometrical feature is preserved by the numerical solution: If the matrices produced by  $f$  lie in some Lie subalgebra  $g$  of the  $n \times n$  matrices, then, within the numerical working precision, the approximation produced by

`numeric::odesolveGeometric` stays on the homogeneous manifold  $\{m Y_0 \mid m \in G\}$ , where  $G$  is the matrix Lie group of  $g$ .

As an introductory example, consider the ODE  $\frac{dY}{dt} = f(t, Y) Y$ , where  $Y$  is a vector in  $\mathbb{R}^n$  and  $f$  produces skew symmetric matrices. The solution lies on the orbit of the orthogonal group  $SO(n)$  generated by the skew symmetric matrices through the initial point  $Y_0 \in \mathbb{R}^n$ . Here,  $SO(n)$  acts on  $\mathbb{R}^n$  by standard matrix multiplication. The homogeneous manifold given by the orbit of  $SO(n)$  through  $Y_0$  is the sphere

$$\{G Y_0 \mid G \in SO(n)\} = \{Y \in \mathbb{R}^n \mid \langle Y, Y \rangle = \langle Y_0, Y_0 \rangle\}$$

Using standard numerical schemes, the numerical solution drifts away from this manifold in the course of the integration. The geometrical “Lie group” integrator `numeric::odesolveGeometric`, however, produces a numerical solution that stays on this manifold, preserving the invariants of the group action. In this case, the invariant  $\langle Y, Y \rangle$  is preserved numerically. See “Example 1” on page 19-230 (Symbolic Math Toolbox).

With  $Y(t) = G(t) Y_0$ , the matrix ODE

$$\frac{dG(t)}{dt} = f(t, G(t) Y_0) G(t), \quad G(t_0) = 1_{n,n}$$

is solved on the space  $\mathbb{C}^{n \times n}$  of the complex  $n \times n$  matrices ( $1_{n,n}$  is the identity matrix).

Following Munthe-Kaas [1], the ansatz  $G(t) = e^{u(t)}$  reduces a time step for the ode above to the solution of the matrix ODE

$$\frac{du}{dt} = \text{dexpinv}(u, f) = f - \frac{[u, f]}{2} + \frac{[u, [u, f]]}{12} + \dots, \quad u(t_0) = 0$$

where  $f = f(t, e^{u(t)} Y_0)$  and  $[u, f] = uf - fu$  is the commutator on the Lie algebra of  $n \times n$  matrices. In each step, the ODE for  $u$  is solved numerically in a classical way by the Runge-Kutta scheme specified by the parameter `method`. Finally,

`numeric::odesolveGeometric` performs the time step  $t_0 \rightarrow t_0 + h$  by computing

$$Y(t_0 + h) = G(t_0 + h) Y_0 = e^{u(h)} Y_0.$$

If the matrices produced by  $f(t, Y)$  lie in a Lie subalgebra  $g$  of the  $n \times n$  matrices, then the numerical solution  $u$  also lies in  $g$ . The matrix  $G = e^u$  is an element of the corresponding Lie group, and  $Y = G Y_0$  lies on the orbit of the Lie group through the initial value  $Y_0$ . Thus, the geometrical invariants of the homogeneous manifold are preserved in the course of the numerical integration.

The input data  $t_0$  and  $t$  must not contain symbolic objects which cannot be converted to floating point values via `float`. Numerical expressions such as  $e^x$ ,  $\sqrt{2}$  etc. are accepted.

The initial condition  $Y_0$  defines the space in which the homogeneous manifold containing the solution is embedded.

If  $Y_0$  is a list with  $n$  entries or a 1-dimensional array `array(1..n)`, then the solution  $Y(t)$  consists of vectors from a submanifold of  $\mathbb{R}^n$  or  $\mathbb{C}^n$ , respectively.

If  $Y_0$  is specified as a 2-dimensional array `array(1..n, 1..m)` or as a matrix of the corresponding dimension generated by the function `matrix`, then the solution  $Y(t)$  consists of matrices from a submanifold of the space  $\mathbb{C}^{n \times m}$  of  $n \times m$  matrices.

Internally, 2-dimensional  $n \times m$  arrays are used to represent the points on the manifold where  $m = 1$  for vectors in  $\mathbb{R}^n$  or  $\mathbb{C}^n$ . It is recommended to specify  $Y_0$  in the form `array(1..n, 1..m)` in order to avoid the overhead of internal conversions.

The “vector field”  $f$  defining the dynamical system  $\frac{dY}{dt} = f(t, Y) Y$  must be represented by a procedure with two input parameters: the scalar time  $t$  and the matrix or vector  $Y$ . Internally,  $f$  is called with real floating-point values  $t$  and matrices/vectors  $Y$  of the same domain (Symbolic Math Toolbox) type as the initial condition  $Y_0$ .

The procedure  $f$  has to return an  $n \times n$  matrix either as an array `array(1..n, 1..n)` or as a corresponding matrix object of category `Cat::Matrix` (generated by the function `matrix`).

It is recommended that the procedure returns an array of the type `array(1..n, 1..n)`. This avoids the overhead of internal conversions.

The return value of  $f$  may contain numerical expressions such as  $\pi$ ,  $\sqrt{2}$  etc. However, all values must be convertible to real or complex floating point numbers by `float`.



Autonomous systems, where  $f(t, Y)$  does not depend on  $t$ , must be represented by a procedure with two arguments  $t$  and  $Y$ , too.

The optional arguments `method`, `RelativeError = tol`, and `Stepsize = h`

determine how the ODE  $\frac{du}{dt} = \text{dexpinv}(u, f)$  is solved. They correspond to the methods of the classical ODE solver `numeric::odesolve`.

The numerical precision is controlled by the global variable `DIGITS`: an adaptive control of the step size keeps local relative discretization errors below  $\text{tol} = \frac{1}{\text{DIGITS}}$ , unless a different tolerance is specified via the option `RelativeError = tol`. The error control may be switched off by specifying a fixed `Stepsize = h`.

---

**Note** Only local errors are controlled by the adaptive mechanism. No control of the global error is provided!

---

With `Y := t -> numeric::odesolveGeometric(f, t_0..t, Y_0)`, the numerical solution can be represented by a MuPAD function: the call `Y(t)` will start the numerical integration from  $t_0$  to  $t$ .

Classical integration preserves the geometrical invariants up to the relative precision of the solution whereas the geometrical integrator preserves the invariants independent of  $tol$  up to the working precision set by `DIGITS`: departure from the homogeneous manifold is a pure roundoff effect.

`numeric::odesolveGeometric` is useful when a tolerance  $tol$  much larger than

$\frac{1}{\text{DIGITS}}$  is specified by `RelativeError = tol`. For small tolerances, you may consider to use the classical solver `numeric::odesolve` instead.

Since classical integration is significantly faster, larger values of `DIGITS` and smaller tolerances for the discretization error may be used in `numeric::odesolve`. Depending on the concrete problem, this may lead to better results than produced by `numeric::odesolveGeometric`.

## Environment Interactions

The function is sensitive to the environment variable DIGITS, which determines the numerical working precision.

## Examples

### Example 1

We consider the initial value problem

$$\frac{dY}{dt} = \begin{pmatrix} (J_2 - J_3) Y_2 Y_3 \\ (J_3 - J_1) Y_3 Y_1 \\ (J_1 - J_2) Y_1 Y_2 \end{pmatrix}, Y(0) = \begin{pmatrix} 1 \\ 1 \\ 1 \end{pmatrix}$$

for  $Y = [Y_1, Y_2, Y_3] \in \mathbb{R}^3$  with fixed parameters  $J_1 = \frac{1}{2}, J_2 = 1, J_3 = 2$ . Writing this ODE as

$$\frac{dY}{dt} = \begin{pmatrix} 0 & -J_3 Y_3 & J_2 Y_2 \\ J_3 Y_3 & 0 & -J_1 Y_1 \\ -J_2 Y_2 & J_1 Y_1 & 0 \end{pmatrix} \begin{pmatrix} Y_1 \\ Y_2 \\ Y_3 \end{pmatrix} = f_1(t, Y) Y$$

it is clear that the solution is restricted to the orbit of the orthogonal group  $SO(3)$  through the initial point ( $f_1$  produces skew symmetric matrices). The invariant of this action is

$H_1(Y) = \langle Y, Y \rangle = Y_1^2 + Y_2^2 + Y_3^2$ , i.e., the solution is restricted to a sphere. Writing the ODE as

$$\frac{dY}{dt} = \begin{pmatrix} 0 & J_2 Y_3 & -J_3 Y_2 \\ -J_1 Y_3 & 0 & J_3 Y_1 \\ J_1 Y_2 & -J_2 Y_1 & 0 \end{pmatrix} \begin{pmatrix} Y_1 \\ Y_2 \\ Y_3 \end{pmatrix} = f_2(t, Y) Y$$

$$= \begin{pmatrix} 0 & Y_3 & -Y_2 \\ -Y_3 & 0 & Y_1 \\ Y_2 & -Y_1 & 0 \end{pmatrix} \begin{pmatrix} J_1 & 0 & 0 \\ 0 & J_2 & 0 \\ 0 & 0 & J_3 \end{pmatrix} \begin{pmatrix} Y_1 \\ Y_2 \\ Y_3 \end{pmatrix}$$

it is clear that the solution is also restricted to the orbit of the “J-orthogonal” group  $SO(J, 3)$  through the initial point. This group consists of matrices  $G$  satisfying  $G^T J G = J$ , where  $J = \text{diag}(J_1, J_2, J_3)$ . The invariant of this group action is

$H_2(Y) = \langle Y, J Y \rangle = J_1 Y_1^2 + J_2 Y_2^2 + J_3 Y_3^2$ , i.e., the solution is restricted to an ellipsoid.

We consider the first representation and compute a numerical solution that is restricted to a sphere:

```
f1 := proc(t, Y) begin
    array(1..3, 1..3, [ [ 0, -J3*Y[3], J2*Y[2]],
                       [ J3*Y[3], 0, -J1*Y[1]],
                       [-J2*Y[2], J1*Y[1], 0 ]])
end_proc:
J1 := 1/2: J2 := 1: J3 := 2:
tol := 10^(-2):
Gsolve:= (f, t0_t, Y0) ->
    numeric::odesolveGeometric(f, t0_t, Y0, RelativeError = tol):

Y(0) := [1.0, 1.0, 1.0];
Y(1) := Gsolve(f1, 0..1, Y(0));
Y(2) := Gsolve(f1, 1..2, Y(1));
Y(3) := Gsolve(f1, 2..3, Y(2));
Y(4) := Gsolve(f1, 3..4, Y(3));
Y(5) := Gsolve(f1, 4..5, Y(4))
```

[1.0, 1.0, 1.0]

[-0.1234874253, 1.573899124, 0.7124551935]

[-1.188837997, 0.6164504304, 1.098477621]

```
[-0.7811791671, -1.258922776, 0.8971468953]
```

```
[0.3530511101, -1.520952843, 0.7497048516]
```

```
[1.281782142, -0.1892246302, 1.149447075]
```

The invariant  $H_1$  is preserved numerically up to the working precision set by DIGITS:

```
H1 := Y -> Y[1]^2 + Y[2]^2 + Y[3]^2:  
H1(Y(i)) - H1(Y(0)) $ i = 1..5
```

```
3.045480534 10-14, -2.691596945 10-14, 4.011374566 10-14, 3.491859579 10-13,  
2.851746617 10-13
```

The invariant  $H_2$  is only preserved within the relative precision of the solution set by the option `RelativeError = tol`:

```
H2 := Y -> J1*Y[1]^2 + J2*Y[2]^2 + J3*Y[3]^2:  
H2(Y(i)) - H2(Y(0)) $ i = 1..5
```

```
-0.00003216929769, -0.00001480619998, -0.0002478937317, -0.0002651787298,  
-0.0002541517488
```

Now, we solve the ODE using the second representation:

```
f2 := proc(t, Y) begin  
    array(1..3, 1..3, [ [ 0      , J2*Y[3], -J3*Y[2]],  
                       [-J1*Y[3], 0      , J3*Y[1]],  
                       [ J1*Y[2], -J2*Y[1], 0      ]])  
end_proc:  
  
Y(0) := [1.0, 1.0, 1.0];  
Y(1) := Gsolve(f2, 0..1, Y(0));  
Y(2) := Gsolve(f2, 1..2, Y(1));  
Y(3) := Gsolve(f2, 2..3, Y(2));  
Y(4) := Gsolve(f2, 3..4, Y(3));  
Y(5) := Gsolve(f2, 4..5, Y(4))
```

```
[1.0, 1.0, 1.0]
```

```
[-0.1234661822, 1.573904531, 0.7124614294]
```

```
[-1.188842584, 0.6165012417, 1.098465492]
```

```
[-0.7810696492, -1.258800682, 0.8973254548]
```

```
[0.3534089311, -1.520647212, 0.7500610376]
```

```
[1.28178089, -0.1880404787, 1.149599855]
```

Now, the invariant  $H_2$  is preserved to working precision, whilst  $H_1$  is only preserved to the tolerance specified by `RelativeError = tol`:

```
H2(Y(i)) - H2(Y(0)) $ i = 1..5
```

```
2.70894418 10-14, 5.287437155 10-15, 2.071884331 10-13, 1.704608676 10-13,  
2.268046861 10-13
```

```
H1(Y(i)) - H1(Y(0)) $ i = 1..5
```

```
0.0000206606336, 0.00004690748333, -0.0001580733145, -0.0001426238818,  
-0.0000987012679
```

```
delete J1, J2, J3, Gsolve, f1, f2, Y, H1, H2:
```

## Example 2

We consider the “Toda lattice equations”

$$\frac{da_i}{dt} = a_i (b_i - b_{i+1}), i \in \{1, \dots, n-1\}$$

$$\frac{db_i}{dt} = 2 (a_{i-1}^2 - a_i^2), i \in \{1, \dots, n\}$$

with  $a_0 = a_n = 0$ . Introducing the tridiagonal  $n \times n$  matrices

$$Y = \begin{pmatrix} b_1 & a_1 & & & \\ a_1 & \dots & & & \\ & \dots & \dots & & \\ & & & a_{n-1} & \\ & & & a_{n-1} & b_n \end{pmatrix}, f(Y) = \begin{pmatrix} 0 & -a_1 & & & \\ a_1 & \dots & & & \\ & \dots & \dots & & \\ & & & -a_{n-1} & \\ & & & a_{n-1} & 0 \end{pmatrix}$$

these equations can be encoded by the matrix ODE  $\frac{dY}{dt} = f(Y) Y - Y f(Y)$ . The solution  $Y(t)$  is known to be “isospectral”, i.e., the eigenvalues of  $Y(t)$  do not depend on the time parameter  $t$ . As mentioned in the description of the option `LieGroupAction`, the solution of this type of matrix ODE is given by the group action  $Y(t) = G(t) Y(0) G(t)^{-1} = G(t) Y(0) G(t)^T$ , where  $G(t)$  are orthogonal matrices (note that  $f(Y)$  is skew symmetric). The eigenvalues of the matrices  $Y(t)$  are invariants of the group action.

The exact dynamics also preserves the tridiagonal form of the matrices. The numerical dynamics, however, fills in further elements. The following vector field  $f$  ignores all elements outside the central bands:

```
f := proc(t, Y)
local i, r;
begin
  r := array(1..n, 1..n, [[0 $ n] $ n]);
  for i from 1 to n - 1 do
    r[i + 1, i] := Y[i, i + 1];
    r[i, i + 1] := -Y[i, i + 1];
  end_for;
  return(r)
end_proc;
```

In the following, the initial value  $Y(0)$  is specified by a matrix generated by the function `matrix`. Consequently, both arguments  $G$  and  $Y$  are passed to the Lie group action

LAMBDA as corresponding matrices. They can be multiplied by the multiplication operator \*:

```
LAMBDA:= proc(G, Y)
begin
  G*Y*(G::dom::transpose(G))
end_proc:
```

We define the initial value:

```
n := 3:
Y(0) := matrix(n, n, [1, 1, 1], Banded)
```

$$\begin{pmatrix} 1 & 1 & 0 \\ 1 & 1 & 1 \\ 0 & 1 & 1 \end{pmatrix}$$

Now, the dynamics is integrated from  $t = 0$  to  $t = 1$ :

```
tol := 10^(-4):
Y(1) := numeric::odesolveGeometric(f, 0..1, Y(0),
  LieGroupAction = LAMBDA, RelativeError = tol)
```

$$\begin{pmatrix} -0.256354686 & 0.4591148565 & -1.716329601 \cdot 10^{-14} \\ 0.4591148565 & 1.0 & 0.4591148565 \\ -1.716329601 \cdot 10^{-14} & 0.4591148565 & 2.256354686 \end{pmatrix}$$

The invariants of the dynamics are the eigenvalues of the matrices  $Y(t)$ . They are preserved numerically:

```
numeric::eigenvalues(Y(0)) = numeric::eigenvalues(Y(1))
```

$$[2.414213562, 1.0, -0.4142135624] = [2.414213562, 1.0, -0.4142135624]$$

For comparison, we also solve the Toda lattice equations by classical numerics using `numeric::odesolve`. The system is encoded by a vector  $Y = [b_1, \dots, b_n, a_1, \dots, a_{n-1}]$  in  $\mathbb{R}^{2n-1}$ .

```

f := proc(t, Y)
local a, b, i;
begin
  b := [Y[i] $ i = 1..n];
  a := [Y[n + i] $ i = 1..n-1];
  [-2*a[1]^2, // = d/dt b[1]
  2*(a[i-1]^2 - a[i]^2) $ i = 2..n-1, // = d/dt b[i]
  2*a[n-1]^2, // = d/dt b[n]
  a[i]*(b[i] - b[i+1]) $ i = 1..n-1 // = d/dt a[i]
  ]
end_proc:

solution := numeric::odesolve(f, 0..1, [1 $ 2*n - 1],
                             RelativeError = tol);

```

```
[-0.2563650696, 1.0, 2.25636507, 0.459099923, 0.459099923]
```

The invariants are only preserved up to the precision of the solution determined by the tolerance set via `RelativeError = tol`:

```

Y(1) := array(1..n, 1..n, [[0 $ n] $ n]):
for i from 1 to n do
  Y(1)[i, i] := solution[i];
end_for:
for i from 1 to n-1 do
  Y(1)[i, i + 1] := solution[n + i];
  Y(1)[i + 1, i] := solution[n + i];
end_for:

Y(1)

```

$$\begin{pmatrix} -0.2563650696 & 0.459099923 & 0 \\ 0.459099923 & 1.0 & 0.459099923 \\ 0 & 0.459099923 & 2.25636507 \end{pmatrix}$$

```
numeric::eigenvalues(Y(1))
```

```
[2.414213091, 1.0, -0.4142130909]
```



Comparing these data with the previously computed eigenvalues of the initial condition  $Y(0)$ , one sees that the invariants are not preserved numerically to the working precision determined by DIGITS.

```
delete f, LAMBDA, n, Y, tol, solution, i:
```

## Parameters

**f**

A procedure on page 1-1654 accepting two parameters ( $t$ ,  $Y$ )

**$t_0$**

A numerical real value for the initial time

**t**

A numerical real value (the “time”)

**$Y_0$**

The initial condition: a list on page 7-41, a 1-dimensional array(1..n), a 2-dimensional array(1..n, 1..m), or an  $n \times m$  matrix of category `Cat::Matrix` with numerical entries

## Options

### LieGroupAction

Option, specified as `LieGroupAction = LAMBDA`

The procedure on page 1-1654 `LAMBDA = proc(G, Y) ... end_proc` defines the action of the group element  $G$  (an  $n \times n$  matrix) on the point  $Y$  on the homogeneous manifold (an  $n \times m$  matrix or an  $n$  dimensional vector). This procedure must return a corresponding point (a matrix or a vector).

The default action is the usual matrix multiplication  $(G, Y) \rightarrow G Y$ .

With this option, the default group action  $LAMBDA: (G, Y) \rightarrow G Y$  of the  $n \times n$  matrices  $G$  acting on the  $n \times m$  matrices or  $n$  dimensional vectors  $Y$  by left multiplication may be replaced by other group actions.

As a group action, the procedure on page 1-1654  $LAMBDA$  must satisfy  $LAMBDA(1_{n, n}, Y) = Y$  and

$$LAMBDA(G_2, LAMBDA(G_1, Y)) = LAMBDA(G_2 G_1, Y).$$

`numeric::odesolveGeometric` computes the solution of the matrix ODE

$$\frac{dG(t)}{dt} = f(t, LAMBDA(G(t), Y_0)) \quad G(t), \quad G(t_0) = 1_{n, n}$$

On the space  $\mathbb{C}^{n \times n}$  of the  $n \times n$  matrices and returns  $Y(t) = LAMBDA(G(t), Y_0)$ .

For the standard group action  $LAMBDA(G, Y) = G Y$ , this is the solution of the ODE

$$\frac{dY}{dt} = f(t, Y) Y.$$

For homogeneous manifolds embedded in the  $n \times n$  matrices, the group action  $LAMBDA(G, Y) = G Y G^{-1}$  may be considered. For this action, the curve  $Y(t) = LAMBDA(G(t), Y_0)$  returned by `numeric::odesolveGeometric` is the solution of the ODE

$$\frac{dY}{dt} = f(t, Y) Y - Y f(t, Y). \quad \text{Cf. "Example 2" on page 19-233 (Symbolic Math Toolbox).}$$

$LAMBDA(G, Y)$  is called with  $n \times m$  matrices or  $n$  dimensional vectors  $Y$  of the same domain (Symbolic Math Toolbox) type as the initial condition  $Y_0$ . If  $Y_0$  is a matrix generated by the function `matrix`, then also the  $n \times n$  matrix  $G$  is passed to  $LAMBDA$  as such a matrix object. In all other cases,  $G$  is passed as a 2-dimensional array (1..n, 1..m).

The procedure  $LAMBDA$  should return a 2-dimensional array (1..n, 1..m) or a corresponding matrix of category `Cat::Matrix`.

If the initial condition  $Y_0$  is specified by a list or a 1-dimensional array (1..n),  $LAMBDA$  may also return a corresponding list or array.

Internally, the return value of  $LAMBDA$  is converted to a 2-dimensional array (1..n, 1..m) where  $m = 1$  if a list or a 1-dimensional array is returned.

It is recommended that LAMBDA returns a 2-dimensional array(1..n, 1..m) in order to avoid the overhead of internal conversions.

### RelativeError

Option, specified as `RelativeError = tol`

Forces internal numerical Runge-Kutta steps to use step sizes with local discretization

errors below `tol`. This tolerance must be a numerical real value  $\geq \frac{1}{10^{\text{DIGITS}}}$ . The default

tolerance is  $\frac{1}{10^{\text{DIGITS}}}$ .

The internal control mechanism estimates the local relative discretization error of a Runge-Kutta step and adjusts the step size adaptively to keep this error below `tol`.

The default setting of `tol =  $\frac{1}{10^{\text{DIGITS}}}$`  ensures that the local discretization errors are of the same order of magnitude as numerical roundoff.

Usually there is no need to use this option to change this setting. However, occasionally the numerical evaluation of the Runge-Kutta steps may be ill-conditioned or step sizes are so small that the time parameter cannot be incremented by the step size within working precision. In such a case, this option may be used to bound the local discretization error by `tol` and use a higher working precision given by `DIGITS`.

Only real numerical values `tol  $\geq \frac{1}{10^{\text{DIGITS}}}$`  are accepted.

---

**Note** Usually, the global error of the numeric approximation returned by `numeric::odesolveGeometric` is larger than the local errors bounded by `tol`. Although the result is displayed with `DIGITS` decimal places, one should not expect that all of them are correct. The relative precision of the final result is `tol` at best!

---

### Stepsize

Option, specified as `Stepsize = h`

Switches off the internal error control and uses a Runge-Kutta iteration with constant step size `h`. `h` must be a numerical real value.

By default, `numeric::odesolveGeometric` uses an adaptive step size control mechanism in the numerical iteration. The option `Stepsize = h` switches off this adaptive mechanism and uses the Runge-Kutta method specified by `method` (or the default method DOPRI78) with constant step size  $h$ .

A final step with smaller step size is used to match the end  $t$  of the integration interval

$t_0 \dots t$ , if  $\frac{t-t_0}{h}$  is not an integer.

---

**Note** With this option, there is no automatic error control! Depending on the problem and on the order of the method, the result may be a poor numerical approximation of the exact solution.

---

There is usually no need to invoke this option. However, occasionally the builtin adaptive error control mechanism may fail when integrating close to a singularity. In such a case, this option may be used to customize a control mechanism for the global error by using different step sizes and investigating the convergence of the corresponding results.

### Alldata

Option, specified as `Alldata = n`

With this option, `numeric::odesolveGeometric` returns a list of numerical mesh points  $[[t_0, Y_0], [t_1, Y_1], \dots, [t, Y(t)]]$  generated by the internal Runge-Kutta iteration.

The integer  $n$  controls the size of the output list. For  $n = 1$ , all internal mesh points are returned. This case may also be invoked by entering the simplified option `Alldata`, which is equivalent to `Alldata = 1`. For  $n > 1$ , only each  $n$ -th mesh point is stored in the list. The list always contains the initial point  $[t_0, Y_0]$  and the final point  $[t, Y(t)]$ . For  $n \leq 0$ , only the data  $[[t_0, Y_0], [t, Y(t)]]$  are returned.

The output list may be useful to inspect the internal numerical process. Also further graphical processing of the mesh data may be useful.

## Return Values

The solution  $Y(t)$  is returned as a list or as an array of floating-point values. The type of the result matrix/vector coincides with the type of the input matrix/vector  $Y_0$ .

With the option `Alldata`, a list of mesh data is returned.

## References

[1] H. Munthe-Kaas and A. Zanna: “Numerical integration of differential equations on homogeneous manifolds”, in F. Cucker (ed.), *Foundations of Computational Mathematics*, Springer (1997), pp. 305-315.

## See Also

### MuPAD Functions

`numeric::butcher` | `numeric::odesolve` | `numeric::odesolve2`

### MuPAD Graphical Primitives

`plot::ode2d` | `plot::ode3d`

## numeric::ode2vectorfield

Convert an ode system to vectorfield notation

### Syntax

```
numeric::ode2vectorfield(IVP, fields)
```

### Description

`numeric::ode2vectorfield` converts a system of ordinary differential equations of arbitrary order to a vector field representation suitable for the numerical ODE solver `numeric::odesolve2`.

`numeric::ode2vectorfield` is a utility function to generate input parameters for the numerical ODE solver `numeric::odesolve2`. This solver requires a procedure representing the vectorfield  $f(t, Y)$  of a first order system of differential equations

(dynamic system)  $\frac{dY}{dt} = f(t, Y)$  and initial data  $Y_0 = Y(t_0)$ . Given an initial value problem IVP consisting of (possibly higher order) differential expressions together with initial conditions, `numeric::ode2vectorfield` converts the higher order equations to an equivalent system of first order ODEs and returns the input parameters for `numeric::odesolve2`.

Higher-order differential equations can always be represented as an equivalent dynamic system  $\frac{dY}{dt} = f(t, Y)$  with some vector  $Y$ . E.g., the  $n$ -th order equation

$$y^{(n)} = g\left(t, y, y', \dots, y^{(n-1)}\right)$$

may be written as the first order system

$$\frac{dY}{dt} = \left[ y', \dots, y^{(n-1)}, g\left(t, y, \dots, y^{(n-1)}\right) \right]$$

for the vector  $Y = [y, y', \dots, y^{(n-1)}]$ .

The input list `fields` corresponds to the vector  $Y$ . It must be a *complete* specification of all functions and their derivatives through but *not including the highest derivatives* of the unknown functions. E.g., for the second order differential equation  $y''(t) = y(t)$ , the appropriate list of unknown fields is `[y(t), y'(t)]`. The differential equations  $y''(t) = z(t)$ ,  $z'(t) = y(t)$  are of second order in  $y$  and of first order in  $z$ . Hence, the appropriate list of unknown fields is `[y(t), y'(t), z(t)]`.

The ordering of the fields in `list` determines the ordering of the components of the list that the numerical solver produces as the solution vector. Cf. "Example 2" on page 19-245 (Symbolic Math Toolbox).

The differential equations must be linear in the highest derivatives of the unknown functions involved. E.g., the ODE  $y'(t)^2 = y(t)$  is not admitted. However, equations such as  $y_2(t) y_1'(t) = y_1(t)$ ,  $y_1(t) y_2'(t) = y_2(t)$  are accepted and converted to

$$y_1'(t) = \frac{y_1(t)}{y_2(t)}, y_2'(t) = \frac{y_2(t)}{y_1(t)}.$$

A *complete* specification of initial conditions must be contained in IVP: for each component in `list`, an initial value must be provided. The initial conditions may be specified by linear equations which will be solved for the initial values of the unknown fields automatically. E.g., for `fields = [y(t), y'(t), z(t)]`, initial conditions may be specified explicitly by  $y(t_0) = 1$ ,  $y'(t_0) = 2$ ,  $z(t_0) = 3$ , say, or via linear equations such as  $y(t_0) + z(t_0) = y'(t_0)$ ,  $y(t_0) = z(t_0)$ ,  $z(t_0) = 2 y(t_0)$ . Cf. "Example 3" on page 19-246 (Symbolic Math Toolbox).

The differential equations, the initial 'time'  $t_0$ , and the initial conditions may involve symbolic parameters. However, such parameters must evaluate to numerical objects, when the sequence returned by `numeric::ode2vectorfield` is passed to the numerical solver.

The vectorfield procedure `f` and the initial values  $Y_0$  returned by `numeric::ode2vectorfield` can also be used by the functions `numeric::odesolve`, `plot::Ode2d`, `plot::Ode3d`. Cf. "Example 3" on page 19-246 (Symbolic Math Toolbox).

`numeric::ode2vectorfield` and `numeric::odeToVectorField` are equivalent.

## Examples

### Example 1

We consider the initial value problem

$$y'(t) = t \sin(y(t)), y(0) = 1$$

The solver `numeric::odesolve2` requires the procedure  $f:(t, Y) \rightarrow t \sin(Y_1)$  for the 1-dimensional vector  $Y = [y(t)]$  specified by `fields`. The utility `numeric::ode2vectorfield` accepts a more convenient representation via arithmetical expressions:

```
IVP := {y'(t) = t*sin(y(t)), y(t0) = y0}:  
fields := [y(t)]:  
IVP := numeric::ode2vectorfield(IVP, fields)
```

```
proc(t, Y) ... end, t0, [y0]
```

This sequence may be passed to the numerical solver which returns a procedure representing the numerical solution:

```
t0 := 0: y0 := 1:  
Y := numeric::odesolve2(IVP)
```

```
proc Y(t) ... end
```

Calling the numerical solution `Y` invokes the numerical integration from the initial 'time'  $t_0 = 0$  to the 'time' specified in the call to `Y`:

```
Y(0), Y(1), Y(2), Y(3)
```

```
[1.0], [1.466404006], [2.655911348], [3.100928494]
```

```
delete IVP, fields, Y:
```



## Example 2

We consider the second order initial value problem

$$y''(t) = t \sin(y(t)), y(0) = 1, y'(0) = 0$$

The corresponding vectorfield representation involves the vector  $Y = [y(t), y'(t)]$  specified by `fields`:

```
IVP := {y''(t) = t*sin(y(t)), y(0) = 1, y'(0) = 0}:
fields := [y(t), y'(t)]:
numeric::ode2vectorfield(IVP, fields)
```

```
proc(t, Y) ... end, 0, [1, 0]
```

This sequence is accepted by `numeric::odesolve2`. The numerical solution `Y` returns lists representing the components of the vector specified by `fields`:

```
Y := numeric::odesolve2(%):
Y(5)
```

```
[1.916536393, -0.8765542819]
```

With a reordering of the unknown fields, the numerical solver returns the solution vector with rearranged components:

```
fields := [y'(t), y(t)]:
Y := numeric::odesolve2(numeric::ode2vectorfield(IVP, fields)):
Y(5)
```

```
[-0.8765542819, 1.916536393]
```

```
delete IVP, fields, Y:
```

### Example 3

The following IVP involves the unknown fields  $u(t)$ ,  $v(t)$ ,  $w(t)$ . Since it is of second order in  $u$ , of first order in  $v$  and of third order in  $w$ , the list of unknowns  $[y(t), y'(t), v(t), w(t), w'(t), w''(t)]$  is appropriate:

```
IVP := {u''(t) - u(t)*v'(t) = exp(-t)*v'(t), v'(t) = w''(t),  
        u'(t)*w'''(t) = t + u'(t),  
        u(PI) = 3, u'(PI) = 1,  
        v(PI) = 0,  
        w(PI) = w'(PI), w'(PI) = 2 - w(PI), w''(PI) = 3*w(PI)}:  
fields := [u(t), u'(t), v(t), w(t), w'(t), w''(t)]:  
ivp := numeric::ode2vectorfield(IVP, fields)
```

```
proc(t, Y) ... end, pi, [3, 1, 0, 1, 1, 3]
```

```
Y := numeric::odesolve2(ivp):  
Y(5)
```

```
[195.9501263, 604.3872242, 13.15053015, 13.29454726, 14.15053015, 10.04763196]
```

We plot the components  $v$ ,  $w$ , and  $w''$  of the solution vector:

```
plotfunc2d(Y(t)[3], Y(t)[4], Y(t)[6], t = PI .. 5,  
           Colors = [RGB::Red, RGB::Green, RGB::Blue]):
```

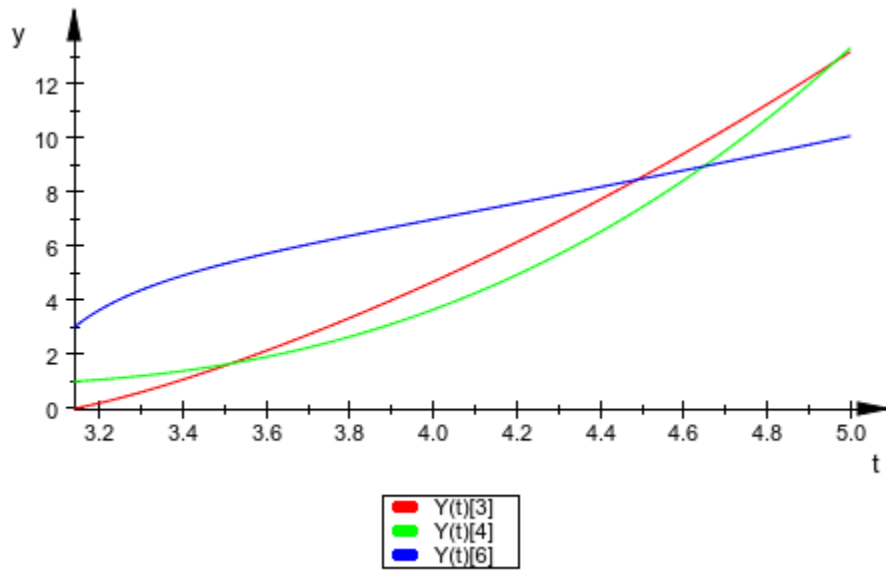

Alternatively, we use the vectorfield procedure `ivp[1]` and the initial conditions `ivp[3]` as input parameters for `plot::Ode2d`:

```
plot(plot::Ode2d([PI + i*(5 - PI)/30 $ i = 0..30],
                 ivp[1], ivp[3],
                 [(t, Y) -> [t, Y[3]], Color = RGB::Red],
                 [(t, Y) -> [t, Y[4]], Color = RGB::Green],
                 [(t, Y) -> [t, Y[6]], Color = RGB::Blue])):
```

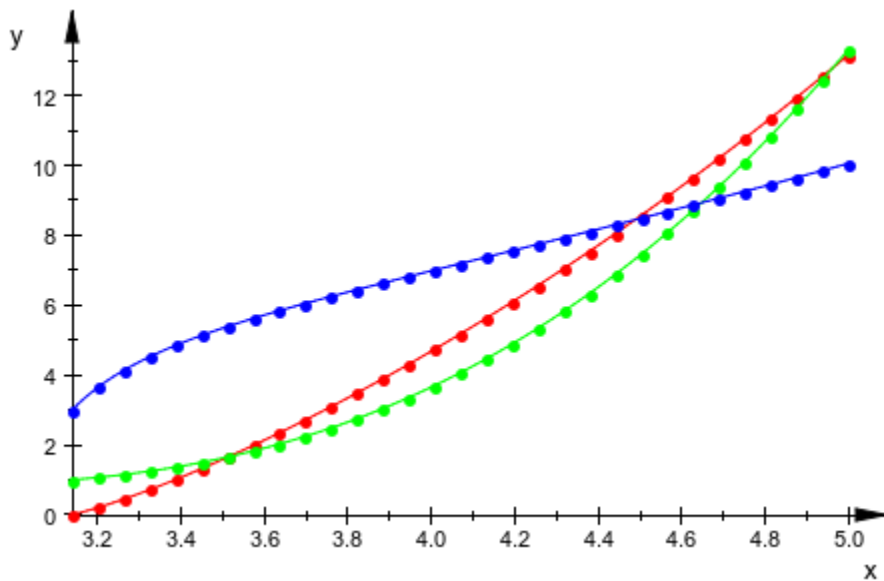

delete IVP, fields, ivp, Y:

## Parameters

### IVP

The initial value problem: a list or a set of equations on page 1-19 involving univariate

function calls  $y_1(t)$ ,  $y_2(t)$  etc. and derivatives  $y_1'(t)$ ,  $y_1''(t)$ , ...,  $y_2'(t)$ ,  $y_2''(t)$  etc. The differential equations must be quasi-linear: the highest derivative of each of the dependent functions  $y_1(t)$ ,  $y_2(t)$  etc. must enter the equations linearly. IVP must also contain corresponding initial conditions specified by linear equations in the expressions

$y_1(t_0)$ ,  $y_1'(t_0)$ , ...,  $y_2(t_0)$ ,  $y_2'(t_0)$  etc. Alternatively, arithmetical expressions (Symbolic Math Toolbox) may be specified which are interpreted as equations with vanishing right hand side.

## fields

The vector of the dynamical system equivalent to IVP: a list of symbolic function calls such as `[y_1(t), y_1'(t), dots, y_2(t), y_2'(t), dots]` representing the unknown fields to be solved for.

## Return Values

Sequence `f`, `t_0`, `Y_0`. These data represent the dynamical system  $\frac{dY}{dt} = f(t, Y)$  with the initial condition  $Y(t_0) = Y_0$  equivalent to IVP. The vectorfield `f:(t, Y) → f(t, Y)` is a procedure on page 1-1654, `t_0` is a numerical expression representing the initial 'time', and `Y_0` is a list of numerical expressions representing the components of the initial vector `Y_0`.

## See Also

### MuPAD Functions

`numeric::odeToVectorField` | `numeric::odesolve` | `numeric::odesolve2` | `numeric::odesolveGeometric`

### MuPAD Graphical Primitives

`plot::ode2d` | `plot::ode3d`

## Topics

"Solve Equations Numerically" (Symbolic Math Toolbox)

## numeric::odeToVectorField

Convert an ode system to vectorfield notation

### Syntax

```
numeric::odeToVectorField(IVP, fields)
```

### Description

`numeric::odeToVectorField` and `numeric::ode2vectorfield` are equivalent. For details and examples, see `numeric::ode2vectorfield`.

### Parameters

#### IVP

The initial value problem: a list or a set of equations on page 1-19 involving univariate

function calls  $y_1(t)$ ,  $y_2(t)$  etc. and derivatives  $y_1'(t)$ ,  $y_1''(t)$ , ...,  $y_2'(t)$ ,  $y_2''(t)$  etc. The differential equations must be quasi-linear: the highest derivative of each of the dependent functions  $y_1(t)$ ,  $y_2(t)$  etc. must enter the equations linearly. IVP must also contain corresponding initial conditions specified by linear equations in the expressions

$y_1(t_0)$ ,  $y_1'(t_0)$ , ...,  $y_2(t_0)$ ,  $y_2'(t_0)$  etc. Alternatively, arithmetical expressions (Symbolic Math Toolbox) may be specified which are interpreted as equations with vanishing right hand side.

#### fields

The vector of the dynamical system equivalent to IVP: a list of symbolic function calls such as `[y_1(t), y_1'(t), dots, y_2(t), y_2'(t), dots]` representing the unknown fields to be solved for.

## Return Values

Sequence  $f$ ,  $t_0$ ,  $Y_0$ . These data represent the dynamical system  $\frac{dY}{dt} = f(t, Y)$  with the initial condition  $Y(t_0) = Y_0$  equivalent to IVP. The vectorfield  $f: (t, Y) \rightarrow f(t, Y)$  is a procedure on page 1-1654,  $t_0$  is a numerical expression representing the initial 'time', and  $Y_0$  is a list of numerical expressions representing the components of the initial vector  $Y_0$ .

## See Also

### MuPAD Functions

`numeric::ode2vectorfield` | `numeric::odesolve` | `numeric::odesolve2` |  
`numeric::odesolveGeometric`

### MuPAD Graphical Primitives

`plot::Ode2d` | `plot::Ode3d`

## Topics

"Solve Equations Numerically" (Symbolic Math Toolbox)

## numeric::polyrootbound

Bound for the roots of a univariate polynomial

### Syntax

```
numeric::polyrootbound(p)
```

### Description

`numeric::polyrootbound(p)` returns a bound  $b$ , such that all real and complex roots  $z$  of the univariate polynomial  $p$  satisfy  $|z| \leq b$ .

The coefficients of  $p$  may be real or complex numbers. Also exact numerical coefficients such as  $\pi$ ,  $\sqrt{2}$  etc. are accepted if they can be converted to floats.

For non-zero constant polynomials, `numeric::polyrootbound` returns infinity.

For monomials  $p(x) = c_n x^n$  with  $n > 0$ , `numeric::polyrootbound` returns  $0.0$ .

Consider the polynomial  $p(z) = z^n + c_{n-1}z^{n-1} + \dots + c_0$ . If  $\max(|c_{n-1}|, \dots, |c_0|) > 0$ , the polynomial

$$z^n - |c_{n-1}|z^{n-1} - \dots - |c_0|$$

has a single real root  $b > 0$  which is an upper bound for the absolute values of all real and complex roots of  $p$ . The bound returned by `numeric::polyrootbound(p)` approximates  $b$  to about 3 leading decimal digits.

### Environment Interactions

The function is sensitive to the environment variable `DIGITS`, which determines the numerical working precision.



## Examples

### Example 1

Both polynomial expressions as well as DOM\_POLY objects may be used to specify the polynomial:

```
p := x^3 + PI*x - sqrt(2): numeric::polyrootbound(p)
```

```
1.966316026
```

```
p := poly(p, [x]): numeric::polyrootbound(p)
```

```
1.966316026
```

The absolute values of all real and complex roots of  $p$  are bounded by this number:

```
numeric::polyroots(p)
```

```
[0.4256164232, -0.2128082116 + 1.810374176 i, -0.2128082116 - 1.810374176 i]
```

```
max(abs(z) $ z in %)
```

```
1.822838993
```

```
delete p:
```

## Parameters

**p**

A univariate polynomial expression or a univariate polynomial of domain type DOM\_POLY.

## Return Values

Nonnegative real floating-point number or infinity.

## See Also

### MuPAD Functions

RootOf | numeric::fsolve | numeric::polyroots | numeric::polysysroots |  
numeric::realroot | numeric::realroots | polylib::realroots | solve

# numeric::polyroots

Numerical roots of a univariate polynomial

## Syntax

```
numeric::polyroots(eqs, <FixedPrecision>, <SquareFree>, <Factor>, <NoWarning>)
```

## Description

`numeric::polyroots(eqs)` returns numerical approximations of all real and complex roots of the univariate polynomials *eqs*.

The coefficients may be real or complex numbers. Also symbolic coefficients are accepted if they can be converted to floats.

The trivial polynomial  $eqs = 0$  results in an error message. The empty list is returned for constant polynomials  $eqs \neq 0$ .

Multiple roots are listed according to their multiplicities, i.e., the length of the root list coincides with the degree of *eqs*.

The root list is sorted by `numeric::sort`.

Up to roundoff effects, the numerical roots should be accurate to DIGITS significant digits, unless the option `FixedPrecision` is used.

All floating-point entries in *eqs* are internally approximated by rational numbers: `numeric::polyroots(eqs)` computes the roots of `numeric::rationalize(eqs, Minimize)`.

For polynomial expressions in factored form, the numerical search is applied to each factor separately.

It is recommended to use `numeric::realroots` or `polylib::realroots` if *eqs* is a real polynomial and only real roots are of interest.

## Environment Interactions

The function is sensitive to the environment variable DIGITS, which determines the numerical working precision.

## Examples

### Example 1

Both polynomial expressions as well as DOM\_POLY objects may be used to specify the polynomial:

```
numeric::polyroots(x^3 - 3*x - sqrt(2))
```

```
[1.931851653, -0.5176380902, -1.414213562]
```

```
numeric::polyroots(PI*z^4 + I*z + 0.1)
```

```
[0.5936837297 - 0.3729248918 i, 0.6455316068 i,  
0.1003181767 i, -0.5936837297 - 0.3729248918 i]
```

```
numeric::polyroots(poly(x^5 - x^2, [x]))
```

```
[1.0, 0.0, 0.0, -0.5 + 0.8660254038 i, -0.5 - 0.8660254038 i]
```

### Example 2

The following polynomial has exact coefficients:

```
p := poly((x - 1)*(x - PI)^3, [x]):  
numeric::polyroots(p)
```

```
[3.141592654, 3.141592654, 3.141592654, 1.0]
```

Note that roundoff errors in the coefficients of eqs have a dramatic effect on multiple roots:

```
p := poly((x - 1.0)*(x - float(PI))^3, [x]):
numeric::polyroots(p)
```

```
[3.144422386, 3.140177788 - 0.00244957836 i, 3.140177788 + 0.00244957836 i,
0.9999999995]
```

These are the roots of the following rationalized polynomial:

```
numeric::rationalize(p, Minimize)
```

$$\text{poly}\left(x^4 - \frac{461286}{44249}x^3 + \frac{176627}{4525}x^2 - \frac{2515405}{41498}x + \frac{1837649}{59267}, [x]\right)$$

```
delete p:
```

### Example 3

The multiple root  $\frac{i}{3}$  of the following polynomial can only be computed with restricted precision by fixed precision arithmetic:

```
p := poly((x^2 - 6*x + 8)*(x - I/3)^5, [x]):
numeric::polyroots(p, FixedPrecision)
```

```
[4.0, 2.0, 0.006617926628 + 0.330782186 i, 0.004459639998 + 0.3388505458 i,
-0.0003838250804 + 0.3262671926 i, -0.003866386513 + 0.3392634968 i,
-0.006827355033 + 0.3315032456 i]
```

Without the option FixedPrecision, the working precision is increased internally to compute better approximations:

```
numeric::polyroots(p)
```

```
[4.0, 2.0, 0.3333333333 i, 0.3333333333 i, 0.3333333333 i, 0.3333333333 i, 0.3333333333 i]
```

```
delete p:
```

## Example 4

The following polynomial has badly separated roots. `numeric::polyroots` does not manage to separate them properly:

```
p := poly(_mult((x - 1 - i/10^9) $ i=0..5), [x]):  
numeric::polyroots(p)
```

```
[1.000000003, 1.000000003, 1.000000003, 1.000000003, 1.000000003, 0.9999999987]
```

One can preprocess the polynomial by a symbolic factorization:

```
numeric::polyroots(p, Factor)
```

```
[1.000000005, 1.000000004, 1.000000003, 1.000000002, 1.000000001, 1.0]
```

Alternatively, one can increase the working precision to separate the roots:

```
DIGITS := 20:  
numeric::polyroots(p)
```

```
[1.000000005, 1.000000004, 1.000000003, 1.000000002, 1.000000001, 1.0]
```

```
delete p, DIGITS:
```

## Parameters

### eqs

A univariate polynomial expression or a univariate polynomial of domain type `DOM_POLY`. The function also accepts a list on page 7-41, set on page 7-50, array, or matrix (`Cat::Matrix`) of polynomial expressions.

## Options

### FixedPrecision

This option provides the fastest way to obtain approximations of the roots by a numerical search with a fixed internal precision of 2 *DIGITS* decimal places.

Note that badly isolated roots or multiple roots will usually not be approximated to *DIGITS* decimals when using this option. The problem of finding such roots is numerically ill-conditioned, i.e., such roots cannot be found to full precision with fixed precision

arithmetic. Typically, a  $q$ -fold root will be approximated only to about  $\frac{2 \text{ DIGITS}}{q}$  decimal places. Cf. “Example 3” on page 19-257 (Symbolic Math Toolbox).

Without this option, `numeric::polyroots` internally increases the working precision until all roots are found to *DIGITS* decimal places.

### SquareFree

With this option, a symbolic square free factorization is computed via `polylib::sqrfree(eqs)`. The numerical root finding algorithm is then applied to each square free factor.

This option is recommended, when  $p$  is known to have multiple roots. Such roots force `numeric::polyroots` to increase the working precision internally increasing the costs of the numerical search. A square free factorization reduces the multiplicity of each root to one, speeding up the final numerical search.

For polynomials with real rational coefficients, a square free factorization is always used, i.e., this option does not have any effect for such polynomials. For all other types of coefficients, a square free factorization may be costly and must be requested by this option.

Multiple roots of `eqs` can be successfully dealt with by this option. However, for badly separated distinct roots the square free factorization will not improve the performance of the numerical search.

### Factor

With this option, a symbolic factorizations of `eqs` via `factor` are computed. The numerical root finding algorithm is then applied to each factor.

This option is useful, when eqs can be successfully factorized (e.g., when each expression from eqs has multiple roots). The numerical search on the factors is much more efficient than the search on the original polynomial. On the other hand, symbolic factorization of eqs may be costly.

**NoWarning**

Suppresses warnings

**Return Values**

List of numerical roots.

**Algorithms**

The numerical root finding algorithm implemented by `numeric::polyroots` is Laguerre's method: W.H. Press, B.P. Flannery, S.A. Teukolsky and W.T. Vetterling: *Numerical Recipes in C*, Cambridge University Press, 1988.

**See Also****MuPAD Functions**

`RootOf` | `numeric::fsolve` | `numeric::polysysroots` | `numeric::realroot` | `numeric::realroots` | `polylib::realroots` | `solve`



# numeric::polysysroots

Numerical roots of a system of polynomial equations

## Syntax

```
numeric::polysysroots(eqs, <NoWarning>)
```

```
numeric::polysysroots(eqs, vars, <NoWarning>)
```

## Description

`numeric::polysysroots(eqs, ...)` returns numerical approximations of all real and complex roots of the polynomial system of equations `eqs`.

The coefficients of the polynomials may contain symbolic parameters.

If no unknowns are specified by `vars`, then `numeric::indets(eqs)` is used in place of `vars`.

In most cases, the solution is returned as a set of lists of solved equations of the form

$$[x_1 = \text{value}_1, x_2 = \text{value}_2, \dots],$$

where  $x_1, x_2, \dots$  are the unknowns. These simplified equations should be regarded as constraints on the unknowns. E.g., if an unknown  $x_1$ , say, does not turn up in the form  $x_1 = \dots$  in the solution, then there is no constraint on this unknown and it is an arbitrary parameter. This holds true in general for all unknowns that do not turn up on the left hand side of the solved equations. Cf. "Example 2" on page 19-263 (Symbolic Math Toolbox).

If no explicit solutions can be computed, expressions of the form  $(x_1, x_2, \dots) \in S$  may be returned, where  $S$  is the solution set.

The ordering of the unknowns in `vars` determines the ordering of the solved equations. If a `setvars` is used, then an internal ordering is used.

**Note** If the solution set of `eqs` is not finite, then `numeric::polysysroots` may return solutions with some of the unknowns remaining as free parameters. In this case the representation of the solution depends on the ordering of the unknowns! Cf. “Example 3” on page 19-263 (Symbolic Math Toolbox). Further, if higher degree polynomials are involved, then `numeric::polysysroots` may fail to compute roots. Cf. “Example 5” on page 19-264 (Symbolic Math Toolbox). The same may happen, when `eqs` contains symbolic parameters.

---

You may try `numeric::fsolve` to compute a single numerical root, if `numeric::polysysroots` cannot compute all roots of the system. Note, however, that `numeric::fsolve` does not accept symbolic parameters in the equations.

We recommend to use `numeric::polyroots` to compute all roots of a single univariate polynomial with numerical coefficients.

`numeric::polysysroots` is a hybrid routine: it calls the symbolic solver `solve(eqs, vars, BackSubstitution = FALSE)` and processes its symbolic result numerically. Cf. “Example 4” on page 19-264 (Symbolic Math Toolbox).

## Environment Interactions

The function is sensitive to the environment variable `DIGITS`, which determines the numerical working precision.

## Examples

### Example 1

Equations, expressions as well as `DOM_POLY` objects may be used to specify the polynomials:

```
numeric::polysysroots(x^2 = PI^2, x)
```

```
{[x = -3.141592654], [x = 3.141592654]}
```

```
numeric::polysysroots({x^2 + y^2 - 1, x^2 - y^2 = 1/2}, [x, y])
```

$$\{[x = -0.8660254038, y = -0.5], [x = -0.8660254038, y = 0.5], [x = 0.8660254038, y = -0.5], [x = 0.8660254038, y = 0.5]\}$$

```
numeric::polysysroots({poly(x^2 + y + 1), y^2 + x = 1}, [x, y])
```

$$\{[x = -0.4533976515, y = -1.20556943], [x = 0.2266988258 - 1.467711509 i, y = 1.102784715 + 0.6654569512 i], [x = 0.2266988258 + 1.467711509 i, y = 1.102784715 - 0.6654569512 i], [x = 0, y = -1.0]\}$$

Symbolic parameters are accepted:

```
numeric::polysysroots(x^2 + y + exp(z), [x, y])
```

$$\left\{ \left[ x = \sqrt{-1.0 y - 1.0 e^z} \right], \left[ x = -1.0 \sqrt{-1.0 y - 1.0 e^z} \right] \right\}$$

## Example 2

The returned solutions may contain some of the unknowns remaining as free parameters:

```
numeric::polysysroots({x^2 + y^2 = z}, [x, y, z])
```

$$\left\{ \left[ x = -1.0 \sqrt{z - 1.0 y^2} \right], \left[ x = \sqrt{z - 1.0 y^2} \right] \right\}$$

## Example 3

The ordering of the unknowns determines the representation of the solution, if the solution set is not finite. First, the following equation is solved for x leaving y as a free parameter:

```
numeric::polysysroots({x^3 = y^2}, [x, y])
```

$$\left\{ \left[ x = (y^2)^{1/3} \right], \left[ x = (y^2)^{1/3} (-0.5 - 0.8660254038 i) \right], \left[ x = (y^2)^{1/3} (-0.5 + 0.8660254038 i) \right] \right\}$$

Reordering the unknowns leads to a representation with  $x$  as a free parameter:

```
numeric::polysysroots({x^3 = y^2}, [y, x])
```

$$\{[y = \sqrt{x^3}], [y = -1.0 \sqrt{x^3}]\}$$

### Example 4

The symbolic solver produces a `RootOf` solution of the following system:

```
eqs := {y^2 - y = x, x^3 = y^3 + x}:
solve(eqs, BackSubstitution = FALSE)
```

$$\begin{pmatrix} x \\ y \end{pmatrix} \in \left\{ \begin{pmatrix} 0 \\ 0 \end{pmatrix} \right\} \cup \left\{ \begin{pmatrix} y^2 - y \\ z_1 \end{pmatrix} \mid z_1 \in \text{RootOf}(z^5 - 3z^4 + 3z^3 - 2z^2 - z + 1, z) \right\}$$

Internally, `numeric::polysysroots` calls `solve` and processes this result numerically:

```
numeric::polysysroots(eqs, [x, y])
```

$$\{[x = 2.237302267, y = 2.077118343], [x = 0.8911259621, y = -0.5682349751], [x = -0.2383289841, y = 0.6080324763], [x = -1.445049623 + 0.1279930535 i, y = 0.441542078 - 1.094745154 i], [x = -1.445049623 - 0.1279930535 i, y = 0.441542078 + 1.094745154 i], [x = 0, y = 0]\}$$

```
delete eqs:
```

### Example 5

The following equation is solved for the first of the specified unknowns:

```
eqs := y^5 - PI*y = x:
solve(eqs, [x, y])
```

$$\{[x = z^5 - \pi z, y = z]\}$$

`numeric::polysysroots` processes this output numerically:

```
numeric::polysysroots(eqs, [x, y])
```

$$\{[x = y^5 - 3.141592654 y]\}$$

The equation is solved for  $y$  when the unknowns are reordered. However, no simple representation of the solution exists, so a `RootOf` object is returned:

```
solve(eqs, [y, x])
```

$$\begin{pmatrix} y \\ x \end{pmatrix} \in \bigcup_{z2 \in \mathbb{C}} \left\{ \begin{pmatrix} z1 \\ z2 \end{pmatrix} \mid z1 \in \text{RootOf}(z^5 - \pi z - z2, z) \right\}$$

The roots represented by the `RootOf` expression cannot be computed numerically, because the symbolic parameter  $x$  is involved:

```
numeric::polysysroots(eqs, [y, x])
```

$$\begin{pmatrix} y \\ x \end{pmatrix} \in \bigcup_{z2 \in \mathbb{C}} \left\{ \begin{pmatrix} z1 \\ z2 \end{pmatrix} \mid z1 \in \text{RootOf}(z^5 - \pi z - z2, z) \right\}$$

```
delete eqs:
```

## Parameters

### eqs

A polynomial equation or a list on page 7-41, set on page 7-50, `array`, or `matrix` (`Cat::Matrix`) of such equations. Also expressions and polynomials of domain type `DOM_POLY` are accepted wherever an equation is expected. They are interpreted as homogeneous equations.

### vars

An unknown or a list or set of unknowns. Unknowns may be identifiers or indexed identifiers.

## Options

### NoWarning

By default, the roots are double-checked, automatically. Warnings are issued if a solution seems to be marred by some numerical instability. With this option, this check is suppressed and no warnings will be issued.

## Return Values

A set of lists of equations or an expression of the form  $(x_1, x_2, \dots) \in S$ , where  $x_1, x_2, \dots$  are the unknowns and  $S$  is the solution set.

The set `{[]}` containing an empty list is returned, if no solutions can be computed.

## See Also

### MuPAD Functions

`linsolve` | `numeric::fsolve` | `numeric::linsolve` | `numeric::polyroots` |  
`numeric::realroot` | `numeric::realroots` | `polylib::realroots` | `solve`

# numeric::product

Numerical approximation of products

## Syntax

```
numeric::product(f, i = a .. b)
numeric::product(f, i in RootOf(p, <x>))
numeric::product(f, i = RootOf(p, <x>))
numeric::product(f, i in {x1, x2, ...})
numeric::product(f, i = {x1, x2, ...})
```

## Description

`numeric::product(f, i = a..b)` computes a numerical approximation of  $\prod_{i=a}^b f(i)$ .

`numeric::product(f, i = RootOf(p, x))` computes a numerical approximation of the product of  $f$  over the roots of the polynomial  $p$ .

`numeric::product(f, i in { x1, x2, ...})` computes a numerical approximation of

$$\prod_{i \in \{x_1, x_2, \dots\}} f(i).$$

The call `numeric::product(...)` is equivalent to calling the `float` attribute of `product` via `float ( hold( product )(...)), float ( freeze( product ) (...))` or `product::float(...)`.

If there are other symbolic parameters in  $f$ , apart from the variable  $i$ , a symbolic call to `numeric::product` is returned. Numerical expressions such as  $e^x$ ,  $\sqrt{2}$  etc. are accepted and converted to floating-point numbers.

---

**Note** For finite products, `numeric::product` just returns `_mult ( float(f) $ i=a..b)`. Cf. “Example 3” on page 19-270 (Symbolic Math Toolbox).

---

The call `numeric::product(f, i = { x1, x2, ...})` computes numerical approximations of `x[1]`, `x[2]` etc., substitutes these values into  $f(i)$  and multiplies the results.

The calls `numeric::product(f, i in { x1, x2, ...})` and `numeric::product(f, i = { x1, x2, ...})` are equivalent.

The call `numeric::product (f, i in RootOf(p, x))` computes numerical approximations of all roots of  $p$ , substitutes these values into  $f(i)$  and multiplies the results. Cf. “Example 2” on page 19-269 (Symbolic Math Toolbox).

The calls `numeric::product(f, i in RootOf(p, x))` and `numeric::product(f, i = RootOf(p, x))` are equivalent.

## Environment Interactions

The function is sensitive to the environment variable `DIGITS`, which determines the numerical working precision and influences the maximum number of steps used in the computation.

## Examples

### Example 1

We demonstrate some equivalent calls for numerical products:

```
numeric::product(1+1/k^2, k = 1..infinity),  
float(hold(product)(1+1/k^2, k = 1..infinity)),  
float(freeze(product)(1+1/k^2, k = 1..infinity)),  
product::float(1+1/k^2, k = 1..infinity);
```

3.67607791, 3.67607791, 3.67607791, 3.67607791

`product` fails to find a closed form for the following product:



```
product(1 - 1/4^k, k = 1..infinity);
```

$$\prod_{k=1}^{\infty} \frac{2^{2k} - 1}{2^{2k}}$$

float implicitly uses numeric::product to compute a numerical approximation:

```
float(%);
```

```
0.6885375371
```

The exact value of the following infinite product is  $e^{(1-\sqrt{2})\zeta(\frac{1}{2})}$ :

```
numeric::product(exp((-1)^(k+1)*k^(-1/2)), k = 1..infinity)
= float(exp((1-sqrt(2))*zeta(1/2)))
```

```
1.831066609 = 1.831066609
```

## Example 2

We calculate an approximation of the product over the roots of a polynomial:

```
numeric::product(sin(r), r = RootOf(x^2 - PI^2/4, x))
```

```
-1.0
```

If the polynomial expression contains additional indeterminates, a symbolic call to numeric::product is returned:

```
numeric::product(r+PI, r = RootOf(x^8 + c*x - PI^2/4, x))
```

```
numeric::product(r + 3.141592654, r = RootOf(x^8 + c x - 2.4674011, x))
```

### Example 3

`numeric::product` can also be used to compute finite products:

```
numeric::product(1-1/k^2, k = 2..10^n) $ n in { 2, 3, 4 }
```

0.505, 0.5005, 0.50005

However, since `numeric::product` uses `_mult` internally anyway, it is more efficient to call `_mult` directly:

```
_mult(float(1-1/k^2) $ k = 2..10^n) $ n in { 2, 3, 4 }
```

0.505, 0.5005, 0.50005

### Example 4

The following product is returned symbolically because it contains the additional indeterminate `k`:

```
numeric::product(1-1/n^k, n = 2..infinity)
```

$$\text{numeric::product} \left( 1.0 - \frac{1.0}{n^{1.0 k}}, n = 2.. \infty \right)$$

## Parameters

**f**

An arithmetical expression (Symbolic Math Toolbox) depending on `i`

**i**

The product index: an identifier on page 7-29 or indexed identifier on page 1-1017

**a, b**

integers on page 7-31 or  $\pm\infty$  satisfying  $a \leq b$

**p**

A univariate polynomial expression (Symbolic Math Toolbox) in  $x$

**x**

Indeterminate

 **$x_1, x_2, \dots$** 

numerical expressions (Symbolic Math Toolbox)

## Return Values

floating-point number on page 7-23 or a symbolic expression of type `numeric::product`.

## Algorithms

Infinite products are calculated by summing the series  $\sum_{i=a}^{\infty} \ln(f)$  via `numeric::sum`.

`numeric::product` uses `numeric::polyroots` to calculate numerical approximations to the roots of a polynomials.

## See Also

### MuPAD Functions

`_mult` | `numeric::polyroots` | `numeric::sum` | `product`

## numeric::quadrature

Numerical integration ( Quadrature )

### Syntax

`numeric::quadrature(f(x), x = a .. b, <GaussLegendre = n | GaussTschebyscheff = n | New`

### Description

`numeric::quadrature(f(x), x = a..b)` computes a numerical approximation of

$$\int_a^b f(x) dx.$$

`numeric::quadrature` returns itself symbolically if the integrand  $f(x)$  contains symbolic objects apart from the integration variable  $x$  that cannot be converted to numerical values via `float`. Symbolic objects such as  $\pi$  or  $\sqrt{2}$  etc. are accepted.

The integrand  $f(x)$  should be integrable in the Riemann sense. In particular,  $f(x)$  should be bounded on the integration interval  $x = a..b$ . Certain types of mild singularities are handled, but numerical convergence is not guaranteed and will be slow in most cases. Also discontinuities and singularities of (higher) derivatives of  $f(x)$  slow down numerical convergence. For integrands with irregular points, it is recommended to split the integration into several parts, using subintervals on which the integrand is smooth. Cf. "Example 4" on page 19-277 (Symbolic Math Toolbox).

Integrands given by user-defined procedures can be handled. See "Example 4" on page 19-277 (Symbolic Math Toolbox) and "Example 5" on page 19-277 (Symbolic Math Toolbox).

`numeric::quadrature` returns itself symbolically if the boundaries  $a, b$  contain symbolic objects that cannot be converted to numerical values via `float`. Symbolic objects such as  $\pi$  or  $\sqrt{2}$  etc. as well as `infinity` and `-infinity` are accepted.

---

**Note** For infinite ranges, the user should make sure that the integral exists! If  $f(x)$  does

not decay as fast as  $o\left(\frac{1}{|x|^2}\right)$  at infinity, then convergence may be slow.

---

Boundaries  $a > b$  are accepted, using  $\int_a^b f(x) dx = -\int_b^a f(x) dx$ .

For complex values of  $a, b$ , the integration is to be understood as a contour integral along a straight line from  $a$  to  $b$ . Complex boundaries must not involve infinity.

Multi-dimensional integration such as

```
numeric::quadrature ( numeric::quadrature(f(x,y), y = A(x)..B(x)), x
= a..b)
```

is possible. See “Example 3” on page 19-275 (Symbolic Math Toolbox) and “Example 5” on page 19-277 (Symbolic Math Toolbox).

Internally, an adaptive mechanism based on a fixed quadrature rule specified by `method`

`= n` is used. It tries to keep the relative quadrature error of the result below  $\frac{1}{10^{\text{DIGITS}}}$ . The last digit(s) of the result may be incorrect due to roundoff effects.

The routine `numeric::quadrature` is purely numerical: no symbolic check for singularities etc. is carried out.

## Environment Interactions

The function is sensitive to the environment variable `DIGITS`, which determines the numerical working precision.

## Examples

### Example 1

We demonstrate the standard calls for adaptive numerical integration:

```
numeric::quadrature(exp(x^2), x = -1..1)
```

```
2.925303492
```

```
numeric::quadrature(max(1/10, cos(PI*x)), x = -2..0.0123)
```

0.752102471

```
numeric::quadrature(exp(-x^2), x = -2..infinity)
```

1.768308316

The precision goal is set by DIGITS:

```
DIGITS := 50:  
numeric::quadrature(besselJ(0, x), x = 0..PI)
```

1.3475263146739901712314731279612149642205400522774

Note that due to the internal adaptive mechanism, the choice of different methods should not have any significant effect on the quadrature result:

```
DIGITS := 10:  
numeric::quadrature(sin(x)/x, x = -1..10, GaussLegendre = 5),  
numeric::quadrature(sin(x)/x, x = -1..10, GaussLegendre = 160),  
numeric::quadrature(sin(x)/x, x = -1..10, NewtonCotes = 8)
```

2.604430665, 2.604430665, 2.604430665

## Example 2

The user should make sure that the integrand is well defined and sufficiently regular. The following fails, because Newton-Cotes quadrature tries to evaluate the integrand at the boundaries:

```
numeric::quadrature(sin(x)/x, x = 0..1, NewtonCotes = 8)
```

```
Error: Division by zero. [_power]  
Evaluating: Quadsum
```

One may cure this problem by assigning a value to  $f(0)$ . The integrand is passed to the integrator as `hold(f)` to prevent premature evaluation of  $f(x)$  to  $\sin(x)/x$ . Internally, `numeric::quadrature` replaces  $x$  by numerical values and then evaluates the integrand. Note that one has to define  $f(0.0) := 1$  rather than  $f(0) := 1$ :

```
f := x -> sin(x)/x:
f(0.0) := 1:
numeric::quadrature(hold(f)(x), x = 0..1, NewtonCotes = 8)
```

0.9460830704

The default method (Gauss-Legendre quadrature) does not evaluate the integrand at the end points:

```
numeric::quadrature(sin(x)/x, x = 0..1)
```

0.9460830704

Nevertheless, problems may still arise for improper integrals:

```
numeric::quadrature(ln((1 + x^4)^2 - 1), x = 0 .. 1)
```

Warning: Precision goal not achieved after 10000 function calls. Increase 'MaxCalls' and

FAIL

In this example, the integrand is evaluated close to 0. The expression  $(1 + x^4)^2 - 1$  suffers from severe numerical cancellation and is dominated by round-off. A numerically stable representation is  $(1 + x^4)^2 - 1 = x^4(x^4 + 2)$ :

```
numeric::quadrature(ln(x^4*(x^4 + 2)), x = 0..1)
```

-3.218234378

Note that convergence is rather slow, because the integrand is not bounded.

```
delete f:
```

### Example 3

We demonstrate multi-dimensional quadrature:

```
Q := numeric::quadrature:  
Q(Q(exp(x*y), x = 0..y), y = 0..1)
```

0.6589510757

Also more complex types of nested calls are possible. We use numerically defined functions

```
b := y -> Q(exp(-t^2-t*y), t = y..infinity):
```

and

```
f := y -> cos(y^2) + Q(exp(x*y), x = 0..b(y)):
```

for the following quadrature:

```
Q(f(y), y = 0..1)
```

1.261578952

Multi dimensional quadrature is computationally expensive. Note that a call to `numeric::quadrature` evaluates the integrand at least  $3n$  times, where  $n$  is the number of nodes of the internal quadrature rule (by default,  $n = 20$  for  $DIGITS \leq 10$ ). The following triple quadrature would call the `exp` function no less than  $(3 \cdot 20)^3 = 216000$  times!

```
Q(Q(Q(exp(x*y*z), x = 0..y+z), y = 0..z), z = 0..1)
```

For low precision goals, low order quadrature rules suffice. In the following, we reduce the computational costs by using Gauss-Legendre quadrature with 5 nodes. We use the shorthand notation `GL` to specify the `GaussLegendre` method:

```
DIGITS := 4:  
Q(Q(Q(exp(x*y*z), x=0..y+z, GL=5), y=0..z, GL=5), z=0..1, GL=5)
```

0.665

```
delete Q, b, f, DIGITS:
```



## Example 4

We demonstrate how integrands given by user-defined procedures should be handled. The following integrand

```
f := proc(x) begin
    if x<1 then sin(x^2) else cos(x^5) end_if
end_proc:
```

cannot be called with a symbolic argument:

```
f(x)
```

```
Error: Unable to evaluate to Boolean. [_less]
Evaluating: f
```

Consequently, one must use `hold` to prevent premature evaluation of `f(x)`:

```
numeric::quadrature(hold(f)(x), x = -1..PI/2)
```

```
0.5354101317
```

Note that the above integrand is discontinuous at  $x = 1$ , causing slow convergence of the numerical quadrature. It is much more efficient to split the integral into two subquadratures with smooth integrands:

```
numeric::quadrature(sin(x^2), x = -1..1) +
numeric::quadrature(cos(x^5), x = 1..PI/2)
```

```
0.5354101318
```

See “Example 5” on page 19-277 (Symbolic Math Toolbox) for multi-dimensional quadrature of user-defined procedures.

```
delete f:
```

## Example 5

The following integrand

```
f := proc(x, y) begin
    if x<y then x-y else (x-y) + (x-y)^5 end_if
end_proc:
```

can only be called with numerical arguments and must be delayed twice for 2-dimensional quadrature:

```
Q := numeric::quadrature:
Q(Q(hold(hold(f)))(x, y), x = 0..1, y = 0..1)
```

0.02380952381

Note that delaying the integrand via `hold` will not work for triple or higher-dimensional quadrature! The user can handle this by making sure that the integrand can also be evaluated for symbolic arguments:

```
f := proc(x, y, z)
begin
    if not testtype([args()], Type::ListOf(Type::Numeric))
    then return(procname(args()))
    end_if;
    if x^2 + y^2 + z^2 <= 1
    then return(1)
    else return(0)
    end_if
end_proc:
```

Note that this function is not continuous, implying slow convergence of the numerical quadrature. For this reason, we use a low precision goal of only 2 digits and reduce the costs by using a low order quadrature rule:

```
DIGITS := 2:
Q(Q(Q(f(x, y, z), x=0..1, GL=5), y=0..1, GL=5), z=0..1, GL=5)
```

0.52

```
delete f, Q, DIGITS:
```

## Example 6

The following example uses non-adaptive Gauss-Tschebyscheff quadrature with an increasing number of nodes. The results converge quickly to the exact value:

```
a := exp(x)/sqrt(1 - x^2), x = -1..1:
numeric::quadrature(a, Adaptive = FALSE, GT = n) $ n = 3..7
```

```
3.97732196, 3.977462635, 3.977463259, 3.977463261, 3.977463261
```

```
delete a:
```

## Example 7

The improper integral  $\int_0^1 \frac{1}{x} dx = 10$  exists. Numerical convergence, however, is rather slow because of the singularity at  $x = 0$ :

```
numeric::quadrature(x^(-9/10), x = 0..1)
```

```
Warning: Precision goal not achieved after 10000 function calls. Increase 'MaxCalls' and
```

```
FAIL
```

We remove the limit for the number of function calls and let `numeric::quadrature` grind along until a result is found. The time for the computation grows accordingly, the last digit is incorrect due to roundoff effects:

```
numeric::quadrature(x^(-9/10), x = 0..1, MaxCalls = infinity)
```

```
9.999999993
```

## Example 8

The following integral does not exist in the Riemann sense, because the integrand is not bounded:

```
numeric::quadrature(1/x, x = -1..2)
```

Warning: Precision goal not achieved after 10000 function calls. Increase 'MaxCalls' and

FAIL

We increase `MaxCalls`. There is no convergence of the numerical algorithm, because the integral does not exist. Consequently, some internal problem must arise:  
`numeric::quadrature` reaches its maximal recursive depth:

```
numeric::quadrature(1/x, x = -1..2, MaxCalls = infinity)
```

Warning: Precision goal not achieved after 'MAXDEPTH=500' recursive calls. There might

FAIL

## Parameters

**f(x)**

An arithmetical expression (Symbolic Math Toolbox) in  $x$

**x**

An identifier on page 7-29 or an indexed identifier on page 1-1017

**a, b**

Real or complex numerical values or  $\pm\infty$

## Options

**GaussLegendre, GaussTschebyscheff, NewtonCotes**

Options, specified as `GaussLegendre = n, GaussTschebyscheff = n, NewtonCotes = n`

The name of the underlying quadrature scheme. Each quadrature rule can be used with an arbitrary number of nodes specified by the positive integer  $n$ .

Usually there is no need to use this option to change the default method `GaussLegendre = n` with  $n = 20, 40, 80$  or  $160$ , depending on the precision goal determined by the environment variable `DIGITS`. Due to the corresponding high quadrature orders  $40, 80, 160$  or  $320$ , respectively, the default settings are suitable for high precision computations.

With `GaussLegendre = n`, an adaptive version of Gauss-Legendre quadrature with  $n$  nodes is used.

For  $DIGITS \leq 200$ , the weights and abscissae of Gaussian quadrature with  $n = 20, 40, 80$ , and  $160$  nodes are available and the integration starts immediately.

For  $DIGITS > 200$ , the routine `numeric::gldata` is called to compute the Gaussian data before the actual integration starts. This will be noted by some delay in the first call of `numeric::quadrature`.

For `DIGITS` much larger than  $200$ , it is recommended not to use the default setting but to use `GaussLegendre = n` with sufficiently high  $n$  instead. A reasonable choice is  $n \approx DIGITS$ .

With `GaussTschebyscheff = n`, non-adaptive Gauss-Tschebyscheff quadrature with  $n$  nodes is used. This method may only be used in conjunction with `Adaptive = FALSE`.

---

**Note** With `NewtonCotes = n`, an adaptive version of Newton-Cotes quadrature with  $n$  nodes is used. Note that these quadrature rules become numerically unstable for large  $n$  ( $n$  much larger than  $10$ ).

---

Following alternative names for the methods are accepted:

`GaussLegendre`, `Gauss`, `GL`,

`GaussTschebyscheff`, `GT`, `GaussChebyshev`, `GC`,

`NewtonCotes`, `NC`.

### **Adaptive**

Option, specified as `Adaptive = v`

v may be TRUE or FALSE. With `Adaptive = FALSE`, the internal error control is switched off.

The default setting is `Adaptive = TRUE`. An adaptive quadrature scheme with automatic control of the quadrature error is used.

The call `numeric::quadrature(f(x), x = a..b, method = n, Adaptive =`

`FALSE)` returns the quadrature sum  $(b-a) \left( \sum_{i=1}^n B_i f(a+C_i(b-a)) \right)$  approximating  $\int_a^b f(x) dx$  without any control of the quadrature error. The weights  $B_i$  and abscissae  $C_i$  are determined by the quadrature rule given by `method = n`. For the methods `GaussLegendre`, `GaussTschebyscheff` and `NewtonCotes`, these data are available via `numeric::gldata`, `numeric::gtdata` and `numeric::ncdata`, respectively.

`Adaptive = FALSE` may only be used in conjunction with `method = n`.

Usually there is no need to switch off the internal adaptive quadrature via `Adaptive = FALSE`. This option is meant to give easy access to standard non-adaptive quadrature rules of Gauss-Legendre, Gauss-Tschebyscheff and Newton-Cotes type, respectively. The user may want to build his own adaptive quadrature based on these non-adaptive rules. Cf. "Example 6" on page 19-279 (Symbolic Math Toolbox).

### MaxCalls

Option, specified as `MaxCalls = m`

`m` must be a (large) positive integer or infinity. It is the maximal number of evaluations of the integrand, before `numeric::quadrature` gives up.

When called interactively, `numeric::quadrature` returns the approximation it has computed so far and issues a warning. See "Example 7" on page 19-279 (Symbolic Math Toolbox). When called from inside a procedure, `numeric::quadrature` returns FAIL.

The default value is `m = MAXDEPTH*n`. The environment variable `MAXDEPTH` (default value 500) represents the maximal recursive depth of a function. `n` is the number of nodes of the basic quadrature rule specified by the optional argument `method = n`. If no such method is specified by the user, then Gauss-Legendre quadrature is used with  $n = 20$  for  $DIGITS \leq 10$ ,  $n = 40$  for  $10 < DIGITS \leq 50$ ,  $n = 80$  for  $50 < DIGITS \leq 100$ ,  $n = 160$  for  $100 < DIGITS$ . Thus, for  $DIGITS = 10$ , the default setting is `MaxCalls = 10000`.

The default value of `m` ensures that the `MaxCalls` limit is reached before `numeric::quadrature` reaches its maximal internal recursive depth. Specifying

`MaxCalls = infinity` removes this restriction and `numeric::quadrature` computes until it obtains an approximation with about `DIGITS` correct digits or until it runs into an internal error. The typical error that may occur is the evaluation of the integrand at a singularity. There also is the danger of `numeric::quadrature` reaching its maximal internal recursive depth. When called interactively, `numeric::quadrature` returns the approximation it has computed so far and issues a warning. See “Example 8” on page 19-279 (Symbolic Math Toolbox). When called from inside a procedure, `numeric::quadrature` returns `FAIL`.

## Return Values

Floating point number is returned, unless non-numerical symbolic objects in the integrand  $f(x)$  or in the boundaries  $a, b$  prevent numerical evaluation. In this case, `numeric::quadrature` returns itself symbolically. If numerical problems occur, then `FAIL` is returned.

## See Also

### MuPAD Functions

`int` | `numeric::gldata` | `numeric::gtdata` | `numeric::int` | `numeric::ncdata`

## numeric::rank

Numerical estimate of the rank of a matrix

### Syntax

```
numeric::rank(A, <eps>, options)
```

### Description

`numeric::rank(A)` returns an integer indicating the rank of the matrix  $A$ .

All entries of the input matrix must be numerical, i.e., they must be floating-point numbers or expressions that can be converted to floating-point numbers.

The rank of a matrix coincides with the number of non-zero singular values.

A numerical estimate of the rank is computed by counting all singular values that are larger than  $\text{eps } s_{max}$ , where  $s_{max}$  is the largest singular value. (All smaller singular values are regarded as round-off artifacts and treated as zero.)

### Environment Interactions

The function is sensitive to the environment variable `DIGITS`, which determines the numerical working precision.

### Examples

#### Example 1

We consider a quadratic matrix of rank 2:

```
A := matrix([[1, 1, 1],  
            [1, 2, 3],
```



```

[2, 4, 6]]):
numeric::rank(A)

```

2

Hilbert matrices have full rank. However, they are extremely ill-conditioned and it is difficult to compute their rank numerically. The  $10 \times 10$  Hilbert matrix has rank 10. Numerically, however, some of the singular values are so small that they may be regarded as zero resulting in a smaller numerical rank. In particular, with the default value  $\text{eps} =$

$\frac{1}{2^{53}}$ , two singular values are smaller than  $\text{eps} s_{\max}$  where  $s_{\max} = 1.7519\dots$  is the maximal singular value:

```

A := linalg::hilbert(10):
numeric::singularvalues(A)

```

```

[1.75191967, 0.3429295485, 0.03574181627, 0.002530890769, 0.0001287496143,
0.000004729689293, 0.0000001228967739, 0.000000002147438818, 2.26674678 10-11,
1.093197787 10-13]

```

```

numeric::rank(A)

```

8

We specify a second argument  $\text{eps} = 10^{-14}$  to allow smaller singular values to be regarded as non-zero. Now, the numerical rank is 10:

```

numeric::rank(A, 10(-14))

```

10

```

delete A:

```

## Example 2

We consider a non-square matrix of rank 1:

```
A := matrix([[0, 0],  
            [I, 1],  
            [I, 1]]):  
numeric::rank(A)
```

1

```
delete A:
```

## Example 3

We demonstrate the difference between hardware floats and software floats:

```
A := linalg::hilbert(15):  
numeric::rank(A, 10^(-20), SoftwareFloats),  
numeric::rank(A, 10^(-20), HardwareFloats)
```

14, 15

```
delete A:
```

## Parameters

**A**

An  $m \times n$  matrix of domain type (Symbolic Math Toolbox) `DOM_ARRAY`, `DOM_HFARRAY`, or of category `Cat::Matrix`

**eps**

Relative tolerance: regard all singular values  $s$  of  $A$  as zero if they satisfy  $s \leq \text{eps } s_{max}$ ,

where  $s_{max}$  is the largest singular value of  $A$ . The default value of `eps` is  $\frac{1}{10^{\text{DIGITS}}}$ .

## Options

### Hard, HardwareFloats, Soft, SoftwareFloats

With **Hard** (or **HardwareFloats**), computations are done using fast hardware float arithmetic from within a MuPAD session. **Hard** and **HardwareFloats** are equivalent. With this option, the input data are converted to hardware floats and processed by compiled C code. The result is reconverted to MuPAD floats and returned to the MuPAD session.

With **Soft** (or **SoftwareFloats**) computations are done using software float arithmetic provided by the MuPAD kernel. **Soft** and **SoftwareFloats** are equivalent. **SoftwareFloats** is used by default if the current value of **DIGITS** is larger than 15 and the input matrix **A** is not of domain type **DOM\_HFARRAY**.

Compared to the **SoftwareFloats** used by the MuPAD kernel, the computation with **HardwareFloats** may be many times faster. Note, however, that the precision of hardware arithmetic is limited to about 15 digits. Further, the size of floating-point numbers may not be larger than approximately  $10^{308}$  and not smaller than approximately  $10^{-308}$ .

If no **HardwareFloats** or **SoftwareFloats** are requested explicitly, the following strategy is used: If the current value of **DIGITS** is smaller than 16 or if the matrix **A** is a hardware float array of domain type **DOM\_HFARRAY**, then hardware arithmetic is tried. If this is successful, the result is returned.

If the result cannot be computed with hardware floats, software arithmetic by the MuPAD kernel is tried.

If the current value of **DIGITS** is larger than 15 and the input matrix **A** is not of domain type **DOM\_HFARRAY**, or if one of the options **Soft**, **SoftwareFloats** or **Symbolic** is specified, MuPAD computes the result with its software arithmetic without trying to use hardware floats first.

There may be several reasons for hardware arithmetic to fail:

- The current value of **DIGITS** is larger than 15.
- The data contains symbolic objects.
- The data contains numbers larger than  $10^{308}$  or smaller than  $10^{-308}$  that cannot be represented by hardware floats.

If neither `HardwareFloats` nor `SoftwareFloats` is specified, the user is not informed whether hardware floats or software floats are used.

If `HardwareFloats` are specified but fail due to one of the reasons above, a warning is issued that the (much slower) software floating-point arithmetic of the MuPAD kernel is used.

Note that `HardwareFloats` can only be used if all input data can be converted to floating-point numbers.

---

**Note** For ill-conditioned matrices, the results returned with `HardwareFloats` and `SoftwareFloats` may differ significantly! See “Example 3” on page 19-286 (Symbolic Math Toolbox).

---

## Return Values

Positive integer.

## See Also

### MuPAD Functions

`linalg::rank`

# numeric::rationalize

Approximate a floating-point number by a rational number

## Syntax

```
numeric::rationalize(object, <Exact | Minimize | Restore>, <digits>)
```

## Description

`numeric::rationalize(object)` replaces all floating-point numbers in `object` by rational numbers.

An object of a library domain, characterized by `domtype(extop(object, 0))=DOM_DOMAIN` is returned unchanged. For all other objects, `numeric::rationalize` is applied recursively to all operands. Objects of library domains can be rationalized if the domain has an appropriate `map` method. See “Example 5” on page 19-293 (Symbolic Math Toolbox).

A floating-point number  $f$  is approximated by a rational number  $r$  satisfying  $|f - r| < \varepsilon |f|$ .

---

**Note** With the options `Exact` and `Minimize`, the guaranteed precision is  $\varepsilon = \frac{1}{10^{\text{digits}}}$ .

With `Restore`, the guaranteed precision is only  $\varepsilon = \frac{1}{10^{\frac{\text{digits}}{2}}}$ .

The default precision is `digits = DIGITS`.

The user defined precision must not be larger than the internal floating-point precision set by `DIGITS`: an error occurs for `digits > DIGITS`.

## Environment Interactions

The function is sensitive to the environment variable `DIGITS`.



$$76923100000, \frac{769231}{100000000000000000000}$$

### Example 3

We demonstrate the strategy `Minimize` for minimizing the complexity of the resulting rational number:

```
numeric::rationalize(1/13.0, 5),
numeric::rationalize(1/13.0, Minimize, 5),
numeric::rationalize(0.333331, 5),
numeric::rationalize(0.333331, Minimize, 5),
numeric::rationalize(14.285, 5),
numeric::rationalize(14.2857, Minimize, 5),
numeric::rationalize(1234.1/56789.2),
numeric::rationalize(1234.1/56789.2, Minimize)
```

$$\frac{769231}{10000000}, \frac{1}{13}, \frac{333331}{1000000}, \frac{1}{3}, \frac{2857}{200}, \frac{100}{7}, \frac{21731244673}{1000000000000}, \frac{12341}{567892}$$

We compute rational approximations of  $\pi$  with various precisions:

```
numeric::rationalize(float(PI), Minimize, i) $ i = 1..10
```

$$3, \frac{22}{7}, \frac{22}{7}, \frac{355}{113}, \frac{355}{113}, \frac{355}{113}, \frac{355}{113}, \frac{102573}{32650}, \frac{104348}{33215}, \frac{208341}{66317}$$

### Example 4

We demonstrate the strategy `Restore` for restoring rational numbers after elementary float operations. In many cases, also the `Minimize` strategy restores:

```
numeric::rationalize(1/7.3, Exact),
numeric::rationalize(1/7.3, Minimize),
numeric::rationalize(1/7.3, Restore)
```

$$\frac{13698630137}{1000000000000}, \frac{10}{73}, \frac{10}{73}$$

However, using `Restore` improves the chances of recovering from roundoff effects:

```
numeric::rationalize(10^9/13.0, Minimize),  
numeric::rationalize(10^9/13.0, Restore)
```

$$\frac{923076923}{12}, \frac{1000000000}{13}$$

```
DIGITS:= 11:  
numeric::rationalize(1234.56/12345.67, Minimize),  
numeric::rationalize(1234.56/12345.67, Restore)
```

$$\frac{88183}{881835}, \frac{123456}{1234567}$$

In some cases, `Restore` manages to recover from roundoff error propagation in composite arithmetical operations:

```
DIGITS:= 10:  
x:= float(122393/75025):  
y:= float(121393/75025):  
z := (x^2 - y^2)/(x + y)
```

0.01332889037

```
numeric::rationalize(z, Restore)
```

$$\frac{40}{3001}$$

The result with `Restore` corresponds to exact arithmetic:

```
rx := numeric::rationalize(x, Restore):  
ry := numeric::rationalize(y, Restore):  
rx, ry, (rx^2 - ry^2)/(rx + ry)
```

$$\frac{122393}{75025}, \frac{121393}{75025}, \frac{40}{3001}$$

Note that an approximation with `Restore` may have a reduced precision of only `digits/2`:



```
x := 1.0 + 1/10^6:
numeric::rationalize(x, Exact),
numeric::rationalize(x, Restore)
```

$$\frac{1000001}{1000000}, 1$$

```
delete x, y, z, rx, ry:
```

## Example 5

The floats inside objects of library domains are not rationalized directly. However, for most domains the corresponding `map` method can forward `numeric::rationalize` to the operands:

```
Dom::Multiset(0.2, 0.2, 1/5, 0.3)
```

$$\{[0.2, 2], [\frac{1}{5}, 1], [0.3, 1]\}$$

```
numeric::rationalize(%), map(% , numeric::rationalize, Restore)
```

$$\{[0.2, 2], [\frac{1}{5}, 1], [0.3, 1]\}, \{[\frac{1}{5}, 3], [\frac{3}{10}, 1]\}$$

## Parameters

### object

An arbitrary MuPAD object

### digits

A positive integer (the number of decimal digits) not bigger than the environment variable DIGITS. It determines the precision of the rational approximation.

## Options

### Exact

Specifies the strategy for approximating floating-point numbers by rational numbers. This is the default strategy, so there is no real need to pass `Exact` as a parameter to `numeric::rationalize`.

Any real floating-point number  $f \neq 0.0$  has a unique representation

$$f = \text{sign}(f) \text{ mantissa } 10^{\text{exponent}}$$

With integer exponent and  $1.0 \leq \text{mantissa} < 10.0$ . With the option `Exact`, the float mantissa is replaced by the rational approximation

$$\frac{\text{round}(\text{mantissa } 10^{\text{digits}})}{10^{\text{digits}}}$$

This guarantees a relative precision of `digits` significant decimals of the rational approximation.

### Minimize

Specifies the strategy for approximating floating-point numbers by rational numbers. This strategy tries to minimize the complexity of the rational approximation, i.e., numerators and denominators are to be small.

The guaranteed precision of the rational approximation is `digits`.

See “Example 3” on page 19-291 (Symbolic Math Toolbox).

### Restore

Specifies the strategy for approximating floating-point numbers by rational numbers. This strategy tries to restore rational numbers obtained after *elementary* arithmetical operations applied to floating-point numbers. E.g., for rational  $r$ , the float division  $f = 1/\text{float}(r)$  introduces additional roundoff, which the `Restore` algorithm tries to eliminate: `numeric::rationalize(f, Restore) = 1/r`. This strategy, however, is purely heuristic and will not succeed when significant roundoff is caused by arithmetical float operations!

---

**Note** The guaranteed precision of the rational approximation is only `digits/2!`

---

See “Example 4” on page 19-291 (Symbolic Math Toolbox).

## Return Values

If the argument is an object of some kernel domain, then it is returned with all floating-point operands replaced by rational numbers. An object of some library domain is returned unchanged.

## Overloaded By

object

## Algorithms

Continued fraction (CF) expansion is used with the options `Minimize` and `Restore`.

With `Minimize`, the first CF approximation satisfying the precision criterion is returned.

The `Restore` algorithm stops, when large coefficients of the CF expansion are found.

## numeric::realroot

Numerical search for a real root of a real univariate function

### Syntax

```
numeric::realroot(f(x), x = a .. b, <SearchLevel = s>)
```

### Description

`numeric::realroot(f(x), x = a..b)` computes a numerical real root of  $f(x)$  in the interval  $[a, b]$ .

The expression  $f(x)$  must not contain symbolic objects other than the indeterminate  $x$  that cannot be converted to numerical values via `float`. Symbolic objects such as  $\pi$  or  $\sqrt{2}$  etc. are accepted. The same holds true for the boundaries  $a$ ,  $b$  of the search interval.

The function must produce real values. If `float(f(x))` does not yield real floating-point numbers for all real floating-point numbers  $x$  from the interval  $[a, b]$ , internal problems may occur. See “Example 5” on page 19-299 (Symbolic Math Toolbox).

`numeric::realroot` never tries to evaluate  $f(x)$  outside the search interval. Consequently, singularities outside the interval do not cause any problems. In many cases also singularities inside the interval do not affect the numerical search. However, `numeric::realroot` is not guaranteed to work in such a case. An error may occur, if the internal search accidentally hits a singularity. See “Example 5” on page 19-299 (Symbolic Math Toolbox).

Up to roundoff effects numerical roots  $r$  with  $|r| \geq \frac{1}{\text{DIGITS}}$  are computed to a relative precision of `DIGITS` significant decimal places. Roots of smaller absolute size are

computed to an absolute precision of  $\frac{1}{10}$ . These precision goals are not achieved, if significant roundoff occurs in the numerical evaluation of  $f(x)$ .

If  $f$  takes opposite signs at the endpoints  $a$ ,  $b$  of the search interval and does not have zero-crossing singularities, then `numeric::realroot` is bound to find a root in the interval  $[a, b]$ .

User defined functions can be handled. See “Example 2” on page 19-298 (Symbolic Math Toolbox).

---

**Note** `numeric::realroot` approximates a point where  $f(x)$  changes its sign. This is a root only if the function  $f$  is continuous. See “Example 3” on page 19-298 (Symbolic Math Toolbox).

---

Note that `numeric::realroots` may be used to isolate *all* real roots. However, this function is much slower than `numeric::realroot`, if  $f$  is not a polynomial.

For univariate polynomials we recommend to use `numeric::realroots` or `polylib::realroots` rather than `numeric::realroot`.

## Environment Interactions

The function is sensitive to the environment variable `DIGITS`, which determines the numerical working precision.

## Examples

### Example 1

The following functions assume different signs at the boundaries, so the searches are bound to succeed:

```
numeric::realroot(x^3 - exp(3), x = -PI..10)
```

```
2.718281828
```

```
numeric::realroot(exp(-x[1]) = x[1], x[1] = 0..1)
```

0.5671432904

## Example 2

The following function cannot be evaluated for non-numerical  $x$ . So one has to delay evaluation via `hold`:

```
f := proc(x) begin
    if x<0 then 1 - x else exp(x) - 10*x end_if
end_proc:
numeric::realroot(hold(f)(x), x = -10..10)
```

0.1118325592

```
delete f:
```

## Example 3

`numeric::realroot` approximates a point, where  $f(x)$  changes its sign. For the following function this happens at the discontinuity  $x = 1$ :

```
f := proc(x) begin if x<1 then -1 else x end_if end_proc:
numeric::realroot(hold(f)(x), x = 0..3)
```

1.0

```
delete f:
```

## Example 4

The following function does not have a real root. Consequently, `numeric::realroot` fails:

```
numeric::realroot(x^2 + 1, x = -2..2)
```

FAIL

The following function does not have a real root in the search interval:

```
numeric::realroot(x^2 - 1, x = 2..3)
```

FAIL

## Example 5

The following function is complex valued for  $x^2 < 3.5$ . An error occurs, when the internal search hits such a point:

```
numeric::realroot(ln(x^2 - 3.5), x = -2..3)
```

```
Error: Unable to evaluate to Boolean. [_less]
Evaluating: numeric::BrentFindRoot
```

The singularity at  $x = 1$  does not cause any problem in the following call:

```
numeric::realroot((x-2)/(x-1), x = -10..10)
```

2.0

However, the singularity may be hit accidentally in the internal search:

```
numeric::realroot((x-2)/(x-1), x = 0..3)
```

```
Error: Division by zero. [_power]
Evaluating: f
```

## Example 6

The following function has a root close to 1.0, which is difficult to detect. With the default search level  $s = 1$ , this root is not found:

```
f := 2 - exp(-100*(x - 2)^2) - 2*exp(-1000*(x - 1)^2):
numeric::realroot(f, x = 0..5)
```

FAIL

The root is detected with an increased search level:

```
numeric::realroot(f, x = 0..5, SearchLevel = 3)
```

```
1.0
```

```
delete f:
```

## Parameters

### **f(x)**

An arithmetical expression in one unknown  $x$  or a list on page 7-41, set on page 7-50, array, or matrix (`Cat::Matrix`) of expressions. Alternatively, equations in the form  $f_1(x) = f_2(x)$  equivalent to the expressions  $f_1(x) - f_2(x)$ .

### **x**

An identifier or an indexed identifier

### **a, b**

Finite real numerical values

## Options

### **SearchLevel**

Option, specified as `SearchLevel = s`

The nonnegative integer  $s$  controls the internal refinement of the search. The default value is  $s = 1$ . Increasing  $s$  increases the chance of finding roots that are difficult to detect numerically. See "Example 6" on page 19-299 (Symbolic Math Toolbox).

Note that increasing  $s$  by 1 may quadruple the time before FAIL is returned, if no real root is found. For this reason we recommend to restrict  $s$  to small values ( $s \leq 5$ , say).



## Return Values

Single numerical real root of domain type DOM\_FLOAT. If no solution is found, then FAIL is returned.

## Algorithms

A mixture of bisectioning, secant steps and quadratic interpolation is used by numeric::realroot.

## See Also

### MuPAD Functions

numeric::fsolve | numeric::polyroots | numeric::realroots |  
polylib::realroots | solve

## Topics

“Solve Equations Numerically” (Symbolic Math Toolbox)

## numeric::realroots

Isolate intervals containing real roots of a univariate function

### Syntax

```
numeric::realroots(f(x), <x = a .. b>, <eps>, <Merge = c>)
```

### Description

`numeric::realroots(f(x), x = a..b)` searches for real roots of  $f(x)$  in the interval  $[a, b]$ . It returns a list of subintervals in which real roots of  $f(x)$  may exist. It is guaranteed that there are no real roots in the interval  $[a, b]$  lying outside the union of the returned subintervals.

With `Merge = FALSE`, all intervals returned by `numeric::realroots` have length  $b_i - a_i < eps$  with a default value  $eps = 0.01$ . The absolute precision of the root isolation may be redefined using the optional parameter `eps`.

---

**Note** The intervals returned by `numeric::realroots` define a subset of  $[a, b]$  that may contain real roots. For polynomial expressions  $f(x)$ , each of the subintervals of  $[a, b]$  returned by `numeric::realroots` is guaranteed to contain exactly one root. For non-polynomial expressions  $f(x)$ , however, some of the subintervals may contain no root! Cf. "Example 6" on page 19-306 (Symbolic Math Toolbox).

---

In any case, the complement  $[a, b] \setminus (\bigcup_i [a_i, b_i])$  of the subintervals  $[a_i, b_i]$  returned by `numeric::realroots` is guaranteed to contain no real roots. In particular, from the return value `[]`, one may positively conclude that no root exists in the search interval  $[a, b]$ . Cf. "Example 2" on page 19-304 (Symbolic Math Toolbox).

Symbolic parameters in  $f(x)$  are not allowed: `float(f(x))` must evaluate to a floating point number for all  $x$  from the interval  $[a, b]$ .

Infinite intervals of the form  $x = -\text{infinity}..b$  are not refined if  $b \leq -10^5$ .

Infinite intervals of the form  $x = a.. \text{infinity}$  are not refined if  $a \geq 10^5$ .

Such intervals are returned directly if `numeric::realroots` thinks that they may contain roots. Cf. "Example 5" on page 19-305 (Symbolic Math Toolbox).

$f(x)$  may contain complex expressions. Only the search parameter  $x$  is assumed to be real. For complex expressions  $f(x)$ , the intervals are returned where both the real and the imaginary part of the expression vanish simultaneously.

---

**Note** The expression  $f(x)$  must be suitable for interval arithmetic on page 7-33. In particular, MuPAD must be able to evaluate  $f(a..b)$ . Note that not all MuPAD functions support this kind of arithmetic.

---

Presently, the following special functions support interval arithmetic: `abs`, `arccos`, `arccosh`, `arccoth`, `arccot`, `arccsc`, `arccsch`, `arcsec`, `arcsech`, `arcsin`, `arcsinh`, `arctan`, `arctanh`, `arg`, `beta`, `ceil`, `cos`, `cosh`, `cot`, `coth`, `csc`, `csch`, `dirac`, `exp`, `floor`, `gamma`, `Im`, `ln`, `Re`, `round`, `sec`, `sech`, `sin`, `sinh`, `sqrt`, `tan`, `tanh`, `trunc`. Real roots can be searched for any expression that is built from these functions using the standard arithmetical operations `+`, `-`, `*`, `/`, `^`.

The default value is  $\text{eps} = 0.01$ . User defined precision goals must satisfy  $\text{eps} \geq \frac{1}{10^{\text{DIGITS}}}$ .

## Environment Interactions

The function is sensitive to the environment variable `DIGITS`, which determines the numerical working precision.

## Examples

### Example 1

The following expression has integer zeros. The solutions in the specified interval are approximated to the default precision 0.01:

```
numeric::realroots(sin(PI*x), x = -2..sqrt(2))
```

```
[[[-2.0, -1.993331614], [-1.006410506, -0.9997421204],  
  [-0.006152626661, 0.000515759203], [0.9941052529, 1.000773639]]]
```

The following equation is solved with an absolute precision of 7 digits:

```
numeric::realroots(x*sin(x) = exp(-x), x = -1..1, 10^(-7))
```

```
[[0.7271005511, 0.7271006107]]
```

## Example 2

The following expression does not have a real root:

```
numeric::realroots(exp(x) + x^2, x = -100..100)
```

```
[]
```

## Example 3

We demonstrate the option `Merge`. If interval arithmetic can not isolate roots to the desired precision *eps* (default 0.01), then adjacent intervals are produced, each of length smaller than *eps*. This happens in the following example:

```
numeric::realroots(ln(x^2 - 2*x + 2) = 0, x = -10..10,  
                  Merge = FALSE)
```

```
[[[0.869140625, 0.87890625], [0.87890625, 0.888671875], [0.888671875, 0.8984375], ...,  
  [1.123046875, 1.1328125], [1.1328125, 1.142578125]]]
```

With `Merge = TRUE`, these intervals are combined to a single larger interval. Since `Merge = TRUE` is the default setting for non-polynomial functions, it suffices to omit the option `Merge = FALSE`:

```
numeric::realroots(ln(x^2 - 2*x + 2) = 0, x = -10..10)
```

```
[[0.869140625, 1.142578125]]
```

## Example 4

The following expression has infinitely many solutions  $x = \frac{1}{n}$  with  $n = 1, 2, \dots$  in the search interval  $[0, 1]$ :

```
numeric::realroots(sin(PI/x), x = 0..1, 0.1, Merge = FALSE)
```

```
[[0.0, 0.0625], [0.0625, 0.125], [0.125, 0.1875], [0.1875, 0.25], [0.25, 0.3125],  
 [0.3125, 0.375], [0.4375, 0.5], [0.5, 0.5625], [0.9375, 1.0]]
```

Omitting `Merge = FALSE`, adjacent intervals are merged to larger intervals. The first of the following intervals contains infinitely many roots:

```
numeric::realroots(sin(PI/x), x = 0..1, 0.1)
```

```
[[0.0, 0.375], [0.4375, 0.5625], [0.9375, 1.0]]
```

## Example 5

If no search interval is specified, the entire real line is considered:

```
numeric::realroots(x^3 = exp(x))
```

```
[[1.841783524, 1.871585846], [4.523992538, 4.553794861], [100000.0, ∞]]
```

Apart from two finite intervals, `numeric::realroots` tells us that there may be a root close to infinity (but that there is positively no root close to -infinity). Analytically, it is clear that the subinterval `[10000.0, ∞]` cannot contain a root, since  $e^x$  grows much faster than  $x^3$  as  $x$  goes to infinity. If a finite upper limit for the search interval is specified, this fact is detected:

```
numeric::realroots(x^3 = exp(x), x = -infinity .. 10^100)
```

```
[[1.842076975, 1.877795331], [4.512024084, 4.556672029]]
```

We isolate the two finite roots more closely by specifying a precision goal of  $\frac{1}{10^{\text{DIGITS}}}$ :

```
numeric::realroots(x^3 = exp(x), x = -infinity .. 10^100,  
                  10^(-DIGITS))
```

```
[[1.85718386, 1.85718386], [4.536403655, 4.536403655]]
```

## Example 6

The following equation has no root close to 0. However, interval arithmetic does not produce realistic values of  $\frac{\sin(\pi x)}{x}$  for small intervals containing  $x = 0$ , so an isolating interval around 0 is returned:<sup>x</sup>

```
numeric::realroots(sin(PI*x)/x = 0, x = -1..1.2)
```

```
[[[-1.0, -0.99140625], [-0.003125, 0.00546875], [0.99375, 1.00234375]]]
```

A similar phenomenon occurs with  $x^x = e^{x \ln(x)}$  in a neighbourhood of  $x = 0$ . An isolating interval around 0 is returned, although no solution exists there:

```
numeric::realroots(x^x*cos(PI*x) = tan(x), x = 0..1)
```

```
[[[0.0, 0.0078125], [0.328125, 0.3359375]]]
```

This cannot be cured by increasing the precision goal:

```
numeric::realroots(x^x*cos(PI*x) = tan(x), x = 0..1,  
                  10^(-DIGITS))
```

```
[[[0.0, 5.820766091 10-11], [0.3334737903, 0.3334737903]]]
```

## Parameters

### **f(x)**

An expression in one indeterminate  $x$  or a list on page 7-41, set on page 7-50, array, or matrix (Cat::Matrix) of expressions. Alternatively, equations in the form  $f_1(x) = f_2(x)$  equivalent to the expressions  $f_1(x) - f_2(x)$ .

### **x**

An identifier on page 7-29 or an indexed identifier on page 1-1017

### **a, b**

Real numbers or numerical expressions satisfying  $a < b$ . Also - infinity and infinity may be used.

### **eps**

A (small) positive real numerical value defining the precision goal. The default value is 0.01.

## Options

### **Merge**

Option, specified as Merge = b

b can be TRUE or FALSE. With Merge = FALSE, numeric::realroots returns subintervals of length not larger than eps. With Merge = TRUE, numeric::realroots merges adjacent subintervals to larger intervals, i.e., subintervals of length larger than eps may be returned.

The default setting is Merge = FALSE for polynomial functions  $f(x)$ . Otherwise, it is Merge = TRUE.

numeric::realroots isolates intervals  $[a_i, b_i]$  that may contain roots. Internally, all these intervals satisfy  $b_i - a_i < eps$  where  $eps$  is the precision goal.

With Merge = FALSE, these intervals are returned.

With `Merge = TRUE`, adjacent intervals  $[a_i, b_i], [a_{i+1}, b_{i+1}]$  with  $b_i = a_{i+1}$  are combined to larger intervals  $[a_i, b_{i+1}]$ . See “Example 3” on page 19-304 (Symbolic Math Toolbox) and “Example 4” on page 19-305 (Symbolic Math Toolbox).

The default setting is `Merge = FALSE` for polynomial functions. Otherwise, it is `Merge = TRUE`.

## Return Values

List  $[[a_1, b_1], [a_2, b_2], \dots]$  of disjoint floating-point intervals  $[a_i, b_i] \subset [a, b]$  which may contain roots of  $f(x)$ . The empty list is returned if no root exists in the search interval  $[a, b]$ .

## Algorithms

Let  $X$  be a subset of the real numbers. Interval arithmetic produces a set  $F(X)$  such that the set of image values  $\{f(x) \mid x \in X\}$  is contained in  $F(X)$ . The MuPAD domain `DOM_INTERVAL` facilitates this kind of arithmetic. The routine `numeric::realroots` computes  $F := f(a_i, \dots, b_i)$  for various subintervals  $[a_i, b_i]$  of  $[a, b]$ . If  $F$  does not contain zero, then this subinterval is eliminated from the search interval. Otherwise, the subinterval is returned as a candidate for containing zeros of  $f(x)$ . However, one cannot conclude that  $F$  does indeed contain at least one zero, since  $F$  is usually larger than the true image set  $\{f(x) \mid x \in [a_i, b_i]\}$  (‘overestimation’).

For polynomials  $f(x)$ , the routine `polylib::realroots` is called. Its results are intersected with the search interval  $[a, b]$ . No interval arithmetic is used for polynomial expressions. For polynomial equations, each isolating interval returned by `numeric::realroots` is guaranteed to contain at least one root if `Merge = TRUE` is specified. With the default setting of `Merge = FALSE` for polynomials, each isolating interval is guaranteed to contain exactly one root.



## See Also

### MuPAD Domains

DOM\_INTERVAL

### MuPAD Functions

numeric::fsolve | numeric::polyroots | numeric::realroot |  
polylib::realroots | solve

## Topics

“Solve Equations Numerically” (Symbolic Math Toolbox)

## numeric::rotationMatrix

Orthogonal matrix of the rotation about an axis

### Syntax

```
numeric::rotationMatrix(angle, axis, <Symbolic>, <ReturnType = t>)
```

### Description

`numeric::rotationMatrix(angle, axis)` returns an orthogonal matrix corresponding to the rotation about the given axis by the given angle.

The rotation by the angle  $\alpha$  about the axis given by the vector  $[x, y, z]$  of Euclidean length 1 is given by the rotation matrix

$$e^{\alpha \begin{pmatrix} 0 & -z & y \\ z & 0 & -x \\ -y & x & 0 \end{pmatrix}} = \begin{pmatrix} tx^2+c & txy-sz & txz+sy \\ txy+sz & ty^2+c & tyz-sx \\ txz-sy & tyz+sx & tz^2+c \end{pmatrix}$$

with  $c = \cos(\alpha)$ ,  $s = \sin(\alpha)$ , and  $t = 1 - c = 2 \sin\left(\frac{\alpha}{2}\right)^2$ .

The rotation is implemented following the “right hand rule”: Stretch the thumb of your right hand and bend the fingers. When the thumb points into the direction of the rotation axis, your finger tips indicate the direction of the rotation.

Use negative angles to rotate in the opposite direction.

The axis parameter of the routine does not need to be normalized to the Euclidean length 1. However, it must not be of zero length.

If no return type is specified via the option `ReturnType = t`, the domain type of the result depends on the type of the input matrix `axis`:

- If the axis is of domain type array on page 7-2, then the rotation matrix is returned as an array on page 7-2.
- If the axis is of domain type hfarray on page 7-27, then the result is returned as an hfarray on page 7-27.
- If the axis is of domain type `Dom::DenseMatrix()`, then the rotation matrix is returned as a matrix of type `Dom::DenseMatrix()` over the ring of MuPAD expressions.
- If axis is of any different matrix type, the result is a matrix of type `Dom::Matrix()` over the ring of MuPAD expressions. This includes input matrices axis of type `Dom::Matrix(...)`, `Dom::SquareMatrix(...)`, `Dom::MatrixGroup(...)` etc.
- If axis is a list with 3 elements, the rotation matrix is also returned as an `Dom::Matrix()` over the ring of MuPAD expressions.

Without the option `Symbolic`, all arguments are automatically converted to floating-point arguments (if possible). Use the option `Symbolic` if no such conversion is desired.

## Environment Interactions

The function is sensitive to the environment variable `DIGITS`, which determines the numerical working precision.

## Examples

### Example 1

The rotation around the z axis by 45 degrees is given by the following matrix:

```
numeric::rotationMatrix(PI/4, [0, 0, 1])
```

$$\begin{pmatrix} 0.7071067812 & -0.7071067812 & 0 \\ 0.7071067812 & 0.7071067812 & 0 \\ 0 & 0 & 1.0 \end{pmatrix}$$

Symbolic arguments are accepted:

```
numeric::rotationMatrix(a, [1, 2, 3])
```

```
[[0.9285714286 cos(a) + 0.07142857143, 0.1428571429 - 0.8017837257 sin(a)
 - 0.1428571429 cos(a), 0.5345224838 sin(a) - 0.2142857143 cos(a) + 0.2142857143],
 [0.8017837257 sin(a) - 0.1428571429 cos(a) + 0.1428571429,
 0.7142857143 cos(a) + 0.2857142857, 0.4285714286 - 0.2672612419 sin(a)
 - 0.4285714286 cos(a)], [0.2142857143 - 0.5345224838 sin(a) - 0.2142857143 cos(a),
 0.2672612419 sin(a) - 0.4285714286 cos(a) + 0.4285714286,
 0.3571428571 cos(a) + 0.6428571429]]
```

With the option `Symbolic`, no automatic conversion to floating-point numbers occurs:

```
numeric::rotationMatrix(a, [1, 2, 3], Symbolic)
```

$$\begin{pmatrix} \frac{13 \cos(a)}{14} + \frac{1}{14} & \frac{1}{7} - \sigma_1 - \frac{\cos(a)}{7} & \frac{\sigma_4}{7} - \sigma_2 + \frac{3}{14} \\ \sigma_1 - \frac{\cos(a)}{7} + \frac{1}{7} & \frac{5 \cos(a)}{7} + \frac{2}{7} & \frac{3}{7} - \frac{\sigma_4}{14} - \sigma_3 \\ \frac{3}{14} - \frac{\sigma_4}{7} - \sigma_2 & \frac{\sigma_4}{14} - \sigma_3 + \frac{3}{7} & \frac{5 \cos(a)}{14} + \frac{9}{14} \end{pmatrix}$$

where

$$\sigma_1 = \frac{3 \sqrt{14} \sin(a)}{14}$$

$$\sigma_2 = \frac{3 \cos(a)}{14}$$

$$\sigma_3 = \frac{3 \cos(a)}{7}$$

$$\sigma_4 = \sqrt{14} \sin(a)$$

## Example 2

The return type coincides with the type of the input parameter representing the axis:

```
numeric::rotationMatrix(0.3, matrix([1,2,3]))
```

$$\begin{pmatrix} 0.9585267399 & -0.2305627908 & 0.1675329472 \\ 0.2433237939 & 0.9680974922 & -0.05983959278 \\ -0.1483914426 & 0.0981226021 & 0.9840487461 \end{pmatrix}$$

```
domtype(%)
```

```
Dom::Matrix()
```

```
numeric::rotationMatrix(0.3, hfarray(1..3, [1,2,3]))
```

$$\begin{pmatrix} 0.9585267399 & -0.2305627908 & 0.1675329472 \\ 0.2433237939 & 0.9680974922 & -0.05983959278 \\ -0.1483914426 & 0.0981226021 & 0.9840487461 \end{pmatrix}$$

```
domtype(%)
```

```
DOM_HFARRAY
```

The option `ReturnType` allows to specify the type of the result:

```
numeric::rotationMatrix(0.3, hfarray(1..3, [1,2,3]),
                        ReturnType = matrix)
```

$$\begin{pmatrix} 0.9585267399 & -0.2305627908 & 0.1675329472 \\ 0.2433237939 & 0.9680974922 & -0.05983959278 \\ -0.1483914426 & 0.0981226021 & 0.9840487461 \end{pmatrix}$$

```
domtype(%)
```

```
Dom::Matrix()
```

### Example 3

The direction of the rotation is given by the “right hand rule”: Stretch the thumb of your right hand and bend the fingers. When the thumb points into the direction of the rotation axis, your finger tips indicate the direction of the rotation:

```
axis := matrix([0, 0, 1]):  
vector := matrix([1, 0, 0]):  
Q := numeric::rotationMatrix(PI/4, axis):  
plot(plot::Arrow3d(axis, Color = RGB::Blue),  
      plot::Arrow3d(vector, Color = RGB::Red),  
      plot::Arrow3d(Q*vector, Color = RGB::Red),  
      plot::Text3d("axis", [0.01, 0.01, 0.5]),  
      plot::Text3d("vector", [1.05, 0, 0]),  
      plot::Text3d("rotated vector", [0.75, 0.75, 0]),  
      CameraDirection = [1, -2, 4],  
      Scaling = Constrained, Axes = None):
```

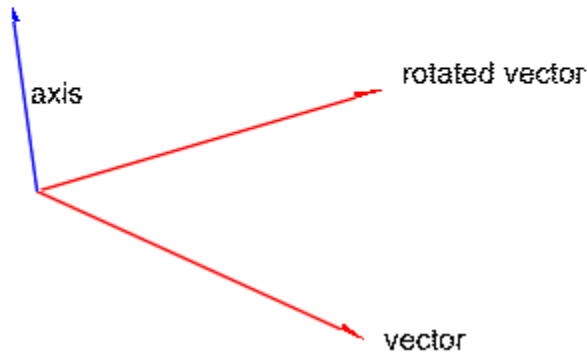

Use negative angles to rotate in the opposite direction:

```
axis := matrix([0, 0, 1]):  
vector := matrix([1, 0, 0]):
```

```
Q := numeric::rotationMatrix(-PI/4, axis):
plot(plot::Arrow3d(axis, Color = RGB::Blue),
      plot::Arrow3d(vector, Color = RGB::Red),
      plot::Arrow3d(Q*vector, Color = RGB::Red),
      plot::Text3d("axis", [0.01, 0.01, 0.5]),
      plot::Text3d("vector", [1.05, 0, 0]),
      plot::Text3d("rotated vector", [0.75, -0.75, 0]),
      CameraDirection = [1, -2, 4],
      Scaling = Constrained, Axes = None):
```

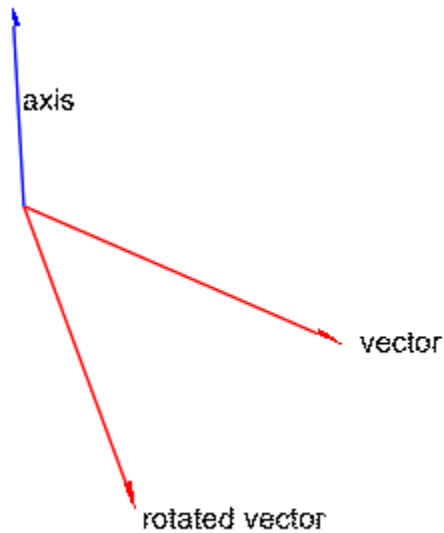

```
delete axis, vector, Q:
```

## Parameters

### angle

An arithmetical expression (Symbolic Math Toolbox)

**axis**

A vector represented by a list with 3 entries or by a  $3 \times 1$  matrix of domain type (Symbolic Math Toolbox) `DOM_ARRAY`, `DOM_HFARRAY`, or of category `Cat::Matrix`

## Options

**Symbolic**

Prevents the conversion of the input data to floating-point numbers. Exact arithmetic is used.

**ReturnType**

Option, specified as `ReturnType = t`

Return the result as a matrix of domain type (Symbolic Math Toolbox) `t`. The following return types are available: `DOM_ARRAY`, `DOM_HFARRAY`, `matrix`, or `densematrix`.

## Return Values

Depending on the type of the input matrix `axis`, the  $3 \times 3$  rotation matrix is returned as a matrix of domain type `DOM_ARRAY`, `DOM_HFARRAY`, `Dom::Matrix()`, or `Dom::DenseMatrix()`.



# numeric::singularvalues

Numerical singular values of a matrix

## Syntax

```
numeric::singularvalues(A, <Hard | HardwareFloats | Soft | SoftwareFloats>)
```

## Description

`numeric::singularvalues(A)` returns numerical singular values of the matrix  $A$ .

The singular values of an  $m \times n$  matrix  $A$  are the  $p = \min(m, n)$  real nonnegative square roots of the eigenvalues of  $A^H A$  (for  $p = n$ ) or of  $A A^H$  (for  $p = m$ ). The Hermitian transpose  $A^H$  is the complex conjugate of the transpose of  $A$ .

`numeric::singularvalues` returns a list of real singular values  $[d_1, \dots, d_p]$  sorted by `numeric::sort`, i.e.,  $d_1 \geq \dots \geq d_p \geq 0.0$ .

All entries of  $A$  must be numerical. Numerical expressions such as  $e^{\pi}$ ,  $\sqrt{2}$  etc. are accepted and converted to floats. Non-numerical symbolic entries lead to an error.

`Cat::Matrix` objects, i.e., matrices  $A$  of a matrix domain such as `Dom::Matrix(...)` or `Dom::SquareMatrix(...)` are internally converted to arrays over expressions via `expr(A)`.

---

**Note** Singular values are approximated with an *absolute* precision of  $\frac{1}{10^{\text{DIGITS}}}$ , where  $r$  is largest singular value of  $A$ . Consequently, large singular values should be computed correctly to DIGITS decimal places. The numerical approximations of small singular values are less accurate.

---

Singular values may also be computed via `map ( numeric::eigenvalues( A A^H ), sqrt )` or `map ( numeric::eigenvalues( A^H A ), sqrt )`, respectively. The use of `numeric::singularvalues` avoids the costs of the matrix multiplication. Further,

the eigenvalue routine requires about twice as many DIGITS to compute small singular values with the same precision as `numeric::singularvalues`. Cf. “Example 2” on page 19-318 (Symbolic Math Toolbox).

## Environment Interactions

The function is sensitive to the environment variable DIGITS, which determines the numerical working precision.

## Examples

### Example 1

The singular values of  $A$  and  $A^H$  coincide:

```
A := array(1..3, 1..2, [[1, 2*I], [2, 3],[3, sqrt(2)]]):  
numeric::singularvalues(A)  
  
[4.994802008, 2.012946323]
```

The Hermitian transpose  $B = A^H$ :

```
B := array(1..2, 1..3, [[1, 2, 3], [-2*I, 3, sqrt(2)]]):  
numeric::singularvalues(B)  
  
[4.994802008, 2.012946323]
```

```
delete A, B:
```

### Example 2

We use `numeric::eigenvalues` to compute singular values:

```
A := matrix([[1/15, 2/15*I],
             [PI, 314159265358980/50000000000000*I],
             [2, 4*I]]):
```

The Hermitian transpose  $B = A^H$  can be computed by the methods `conjugate` and `transpose` of the matrix domain:

```
B := A::dom::conjugate(A::dom::transpose(A)):
```

Note that  $A^H A$  is positive semi-definite and cannot have negative eigenvalues. However, computing small eigenvalues is numerically ill-conditioned, and a small negative value occurs due to roundoff:

```
numeric::eigenvalues(B*A)
```

```
[69.37024423, -2.310493271 10-15]
```

Consequently, an (incorrect) imaginary singular value is computed:

```
map(%, sqrt)
```

```
[8.32888013, 0.0000004806759065 i]
```

We have to increase `DIGITS` in order to compute this value more accurately:

```
DIGITS := 22:
map(numeric::eigenvalues(B*A), sqrt)
```

```
[8.328880130465871055353, 3.293453726225542754196 10-15]
```

With `numeric::singularvalues`, the standard precision suffices:

```
DIGITS := 10:
numeric::singularvalues(A, SoftwareFloats)
```

```
[8.32888013, 3.249076763 10-15]
```

```
numeric::singularvalues(A, HardwareFloats)
```

$$\left[ 8.32888013, 3.6920369 \cdot 10^{-15} \right]$$

```
delete A, B;
```

### Example 3

We demonstrate the use of hardware floats. Hilbert matrices on page 15-93 are notoriously ill-conditioned: the computation of the small singular values is subject to severe roundoff effects. In the following results, both with `HardwareFloats` as well as with `SoftwareFloats`, the small singular values are dominated by numerical roundoff. Consequently, the results with `HardwareFloats` differ from those with `SoftwareFloats`:

```
numeric::singularvalues(linalg::hilbert(13))
```

$$\left[ 1.813830119, 0.396833076, \dots, 8.878210699 \cdot 10^{-16}, 3.222901015 \cdot 10^{-18} \right]$$

```
A := linalg::hilbert(15);  
numeric::singularvalues(A, HardwareFloats);  
numeric::singularvalues(A, SoftwareFloats)
```

$$\left[ 1.845927746, 0.426627957, 0.05721209253, \dots, 1.351581189 \cdot 10^{-17}, 5.696479572 \cdot 10^{-18} \right]$$
$$\left[ 1.845927746, 0.426627957, 0.05721209253, \dots, 9.682265893 \cdot 10^{-19}, 3.017915363 \cdot 10^{-21} \right]$$

```
delete A;
```

## Parameters

**A**

A numerical matrix of domain type (Symbolic Math Toolbox) `DOM_ARRAY`, `DOM_HFARRAY`, or of category `Cat::Matrix`

## Options

### Hard, HardwareFloats, Soft, SoftwareFloats

With **Hard** (or **HardwareFloats**), computations are done using fast hardware float arithmetic from within a MuPAD session. **Hard** and **HardwareFloats** are equivalent. With this option, the input data are converted to hardware floats and processed by compiled C code. The result is reconverted to MuPAD floats and returned to the MuPAD session.

With **Soft** (or **SoftwareFloats**) computations are done using software float arithmetic provided by the MuPAD kernel. **Soft** and **SoftwareFloats** are equivalent. **SoftwareFloats** is used by default if the current value of **DIGITS** is larger than 15 and the input matrix **A** is not of domain type **DOM\_HFARRAY**.

Compared to the **SoftwareFloats** used by the MuPAD kernel, the computation with **HardwareFloats** may be many times faster. Note, however, that the precision of hardware arithmetic is limited to about 15 digits. Further, the size of floating-point numbers may not be larger than approximately  $10^{308}$  and not smaller than approximately  $10^{-308}$ .

If no **HardwareFloats** or **SoftwareFloats** are requested explicitly, the following strategy is used: If the current value of **DIGITS** is smaller than 16 or if the matrix **A** is a hardware float array of domain type **DOM\_HFARRAY**, then hardware arithmetic is tried. If this is successful, the result is returned.

If the result cannot be computed with hardware floats, software arithmetic by the MuPAD kernel is tried.

If the current value of **DIGITS** is larger than 15 and the input matrix **A** is not of domain type **DOM\_HFARRAY**, or if one of the options **Soft**, **SoftwareFloats** or **Symbolic** is specified, MuPAD computes the result with its software arithmetic without trying to use hardware floats first.

There may be several reasons for hardware arithmetic to fail:

- The current value of **DIGITS** is larger than 15.
- The data contains symbolic objects.
- The data contains numbers larger than  $10^{308}$  or smaller than  $10^{-308}$  that cannot be represented by hardware floats.

If neither `HardwareFloats` nor `SoftwareFloats` is specified, the user is not informed whether hardware floats or software floats are used.

If `HardwareFloats` are specified but fail due to one of the reasons above, a warning is issued that the (much slower) software floating-point arithmetic of the MuPAD kernel is used.

Note that `HardwareFloats` can only be used if all input data can be converted to floating-point numbers.

The trailing digits in floating-point results computed with `HardwareFloats` and `SoftwareFloats` may differ.

---

**Note** For ill-conditioned matrices, the result is subject to roundoff errors. The results returned with `HardwareFloats` and `SoftwareFloats` may differ! See “Example 3” on page 19-320 (Symbolic Math Toolbox).

---

## Return Values

Ordered list of real floating-point values.

## Algorithms

The code implements standard numerical algorithms from the Handbook of Automatic Computation by Wilkinson and Reinsch.

## See Also

### MuPAD Functions

`linalg::eigenvalues` | `linalg::eigenvectors` | `numeric::eigenvalues` |  
`numeric::eigenvectors` | `numeric::singularvectors` |  
`numeric::spectralradius`

## Topics

“Compute Factorizations Numerically” (Symbolic Math Toolbox)

# numeric::singularvectors

Numerical singular value decomposition of a matrix

## Syntax

```
numeric::singularvectors(A, options)
```

## Description

`numeric::singularvectors(A)` and the equivalent call `numeric::svd(A)` return numerical singular values and singular vectors of the matrix  $A$ .

All entries of  $A$  must be numerical. Numerical expressions such as  $e^{\pi}$ ,  $\sqrt{2}$  etc. are accepted and converted to floats. Non-numerical symbolic entries lead to an error.

`Cat::Matrix` objects, i.e., matrices  $A$  of a matrix domain such as `Dom::Matrix(...)` or `Dom::SquareMatrix(...)` are internally converted to arrays over expressions via `expr(A)`.

The list  $[U, d, V, res_U, res_V]$  returned by `numeric::singularvectors` corresponds to the singular data of an  $m \times n$  matrix  $A$  as described below.

Let  $V^H$  denote the Hermitian transpose of the matrix  $V$ , i.e., the complex conjugate of the transpose. The singular value decomposition of an  $m \times n$  matrix  $A$  is a factorization  $A = U D V^H$ .  $D$  is an  $m \times n$  "diagonal" matrix with real nonnegative entries  $D_{ii} = d_i$ ,  $i = 1, \dots, p$  where  $p = \min(m, n)$ :

$$D = \begin{pmatrix} d_1 & & 0 \\ & \dots & \\ & & d_p \\ 0 & & & 0 \end{pmatrix}$$

or

$$D = \begin{pmatrix} d_1 & & 0 \\ & \dots & \\ 0 & & d_p & 0 \end{pmatrix},$$

respectively. The list  $d = [d_1, \dots, d_p]$  returned by `numeric::singularvectors` are the “singular values” of  $A$ . They are sorted by `numeric::sort`, i.e.,  $d_1 \geq \dots \geq d_p \geq 0.0$ .

$U$  is a unitary  $m \times m$  matrix. Its  $i$ -th column is an eigenvector of  $AA^H$  associated with the eigenvalue  $d_i^2$  ( $d_i = 0$  for  $i > p$ ). These are the “left singular vectors” of  $A$ . They are returned by `numeric::singularvectors` as a matrix of floating-point numbers.

$V$  is a unitary  $n \times n$  matrix. Its  $i$ -th column is an eigenvector of  $A^H A$  associated with the eigenvalue  $d_i^2$  ( $d_i = 0$  for  $i > p$ ). These are the “right singular vectors” of  $A$ . They are returned by `numeric::singularvectors` as an array of floating-point numbers. The matrix  $V$  is normalized such that, in each column, the first entry of absolute size larger

than  $\frac{1}{10^{\text{DIGITS}}}$  is real and positive.

If no return type is specified via the option `ReturnType = t`, the domain type of the singular vectors  $U$  and  $V$  depends on the type of the input matrix  $A$ :

- The singular vectors of an array on page 7-2 are returned as arrays on page 7-2.
- The singular vectors of an harray on page 7-27 are returned as harrays on page 7-27.
- The singular vectors of a dense matrix of type `Dom::DenseMatrix()` are returned as dense matrices of type `Dom::DenseMatrix()` over the ring of MuPAD expressions.
- For all other matrices of category `Cat::Matrix`, the singular vectors are returned as matrices on page 1-1340 of type `Dom::Matrix()` over the ring of MuPAD expressions. This includes input matrices  $A$  of type `Dom::Matrix(...)`, `Dom::SquareMatrix(...)`, `Dom::MatrixGroup(...)` etc.

$res_U = [resU_1, \dots, resU_m]$  is a list of float residues associated with the left singular vectors:

$$resU_i = \langle A^H u_i, A^H u_i \rangle - d_i^2, 1 \leq i \leq m$$

Here,  $u_i$  is the (normalized)  $i$ -th column of  $U$ ,  $\langle \dots, \dots \rangle$  is the usual complex Euclidean scalar product and  $d_i = 0$  for  $p < i \leq m$ .



$res_V = [res_{V_1}, \dots, res_{V_n}]$  is a list of float residues associated with the right singular vectors:

$$res_{V_i} = |A v_p - A v_i| - d_i^2, 1 \leq i \leq n$$

Here,  $v_i$  is the (normalized)  $i$ -th column of  $V$ ,  $d_i = 0$  for  $p < i \leq n$ .

The residues  $res_U$ ,  $res_V$  vanish for exact singular data  $U$ ,  $d$ ,  $V$ . Their sizes indicate the quality of the numerical data  $U$ ,  $d$ ,  $V$ .

---

**Note** Singular values are approximated with an *absolute* precision of  $\frac{1}{DIGITS}$ , where  $r$  is the largest singular value of  $A$ . Consequently, large singular values should be computed correctly to  $DIGITS$  decimal places. The numerical approximations of small singular values are less accurate.

---

Singular data may also be computed via  $[d2, U, resU] := \text{numeric::eigenvectors}(A^*A^H)$  or  $[d2, V, resV] := \text{numeric::eigenvectors}(A^H A)$ , respectively. The list  $d2$  is related to the singular values by

$$d2 = [d_1^2, d_2^2, \dots, d_p^2, 0, \dots, 0]$$

The use of `numeric::singularvectors` avoids the costs of the matrix multiplication. Further, the eigenvector routine requires about twice as many `DIGITS` to compute the data associated with small singular values with the same precision as `numeric::singularvectors`. Also note that the normalization of  $U$  and  $V$  may be different.

## Environment Interactions

The function is sensitive to the environment variable `DIGITS`, which determines the numerical working precision.

## Examples

### Example 1

Numerical expressions are converted to floats:

```
DIGITS := 5:  
A := array(1..3, 1..2, [[1, PI], [2, 3], [3, exp(sqrt(2))]]):  
[U, d, V, resU, resV] := numeric::singularvectors(A):
```

The singular data are:

```
U, d, V
```

$$\begin{pmatrix} 0.45729 & -0.88078 & 0.12293 \\ 0.51483 & 0.14947 & -0.84416 \\ 0.72515 & 0.44932 & 0.5218 \end{pmatrix}, [6.9986, 0.89905], \begin{pmatrix} 0.5233 & 0.85215 \\ 0.85215 & -0.5233 \end{pmatrix}$$

The small residues indicate that these results are not severely affected by roundoff:

```
resU, resV
```

$$\left[ 2.247 \cdot 10^{-14}, 2.247 \cdot 10^{-14}, 3.898 \cdot 10^{-32} \right], \left[ 5.6175 \cdot 10^{-15}, 5.6175 \cdot 10^{-15} \right]$$

```
delete DIGITS, A, U, d, V, resU, resV:
```

### Example 2

We demonstrate how to reconstruct a matrix from its singular data. With the specified `ReturnType`, the singular vectors are returned as matrices of type `Dom::Matrix()` and can be handled with the overloaded arithmetic:

```
DIGITS := 3:  
A := array(1..2, 1..3, [[1.0, I, PI], [2, 3, I]]):  
[U, d, V, resU, resV] := numeric::singularvectors(A, NoResidues,  
    ReturnType = Dom::Matrix())
```

$$\left[ \begin{array}{c} \left( \begin{array}{cc} 0.514 - 0.028 i & -0.788 + 0.336 i \\ 0.857 + 0.014 i & 0.487 - 0.168 i \end{array} \right), [3.9, 3.27], \\ \left( \begin{array}{ccc} 0.571 & 0.0568 & 0.819 \\ 0.652 - 0.121 i & 0.55 + 0.0871 i & -0.493 + 0.0785 i \\ 0.418 - 0.242 i & -0.81 + 0.174 i & -0.236 + 0.157 i \end{array} \right), \text{NIL}, \text{NIL} \end{array} \right]$$

A “diagonal” matrix is built from the singular values:

```
d := matrix(2, 3, d, Diagonal)
```

$$\begin{pmatrix} 3.9 & 0 & 0 \\ 0 & 3.27 & 0 \end{pmatrix}$$

We use the methods `conjugate` and `transpose` of the matrix domain to compute the Hermitian transpose of `V` and reconstruct `A`. Numerical roundoff is eliminated via `numeric::complexRound`:

```
VH := V::dom::conjugate(V::dom::transpose(V)):
map(U*d*VH, numeric::complexRound)
```

$$\begin{pmatrix} 1.0 & 1.0 i & 3.14 \\ 2.0 & 3.0 & 1.0 i \end{pmatrix}$$

```
delete DIGITS, A, U, d, V, resU, resV, VH:
```

### Example 3

We demonstrate the use of hardware floats. The following matrix `A` is degenerate: it has rank 1. For the double eigenvalue 0 of the matrix  $A^H A$ , different base vectors of the corresponding eigenspace are returned with `HardwareFloats` and `SoftwareFloats`, respectively:

```
A := array(1..2, 1..3, [[1, 2, 3], [30, 60, 90]]):
[U1, d1, V1, resU1, resV1] :=
    numeric::singularvectors(A, HardwareFloats):
```

```
[U2, d2, V2, resU2, resV2] :=  
    numeric::singularvectors(A, SoftwareFloats):  
V1, V2
```

$$\begin{pmatrix} 0.2672612419 & 0.5345224838 & 0.8017837257 \\ 0.5345224838 & -0.7745419206 & 0.3381871191 \\ 0.8017837257 & 0.3381871191 & -0.4927193213 \end{pmatrix},$$
$$\begin{pmatrix} 0.2672612419 & 0.9561828875 & 0.1195228609 \\ 0.5345224838 & -0.04390192219 & -0.8440132318 \\ 0.8017837257 & -0.289459681 & 0.5228345342 \end{pmatrix}$$

```
delete A, U1, d1, V1, resU1, resV1, U2, d2, V2, resU2, resV2:
```

## Parameters

**A**

A numerical matrix of domain type (Symbolic Math Toolbox) `DOM_ARRAY`, `DOM_HFARRAY`, or of category `Cat::Matrix`.

## Options

### Hard, HardwareFloats, Soft, SoftwareFloats

With `Hard` (or `HardwareFloats`), computations are done using fast hardware float arithmetic from within a MuPAD session. `Hard` and `HardwareFloats` are equivalent. With this option, the input data are converted to hardware floats and processed by compiled C code. The result is reconverted to MuPAD floats and returned to the MuPAD session.

With `Soft` (or `SoftwareFloats`) computations are done using software float arithmetic provided by the MuPAD kernel. `Soft` and `SoftwareFloats` are equivalent. `SoftwareFloats` is used by default if the current value of `DIGITS` is larger than 15 and the input matrix `A` is not of domain type `DOM_HFARRAY`.

Compared to the `SoftwareFloats` used by the MuPAD kernel, the computation with `HardwareFloats` may be many times faster. Note, however, that the precision of

hardware arithmetic is limited to about 15 digits. Further, the size of floating-point numbers may not be larger than approximately  $10^{308}$  and not smaller than approximately  $10^{-308}$ .

If no `HardwareFloats` or `SoftwareFloats` are requested explicitly, the following strategy is used: If the current value of `DIGITS` is smaller than 16 or if the matrix `A` is a hardware float array of domain type `DOM_HFARRAY`, then hardware arithmetic is tried. If this is successful, the result is returned.

If the result cannot be computed with hardware floats, software arithmetic by the MuPAD kernel is tried.

If the current value of `DIGITS` is larger than 15 and the input matrix `A` is not of domain type `DOM_HFARRAY`, or if one of the options `Soft`, `SoftwareFloats` or `Symbolic` is specified, MuPAD computes the result with its software arithmetic without trying to use hardware floats first.

There may be several reasons for hardware arithmetic to fail:

- The current value of `DIGITS` is larger than 15.
- The data contains symbolic objects.
- The data contains numbers larger than  $10^{308}$  or smaller than  $10^{-308}$  that cannot be represented by hardware floats.

If neither `HardwareFloats` nor `SoftwareFloats` is specified, the user is not informed whether hardware floats or software floats are used.

If `HardwareFloats` are specified but fail due to one of the reasons above, a warning is issued that the (much slower) software floating-point arithmetic of the MuPAD kernel is used.

Note that `HardwareFloats` can only be used if all input data can be converted to floating-point numbers.

The trailing digits in floating-point results computed with `HardwareFloats` and `SoftwareFloats` may differ.

---

**Note** For ill-conditioned matrices, the result is subject to roundoff errors. The results returned with `HardwareFloats` and `SoftwareFloats` may differ! See “Example 3” on page 19-327 (Symbolic Math Toolbox).

---

**NoLeftVectors**

Suppresses the computation of left singular vectors

If only right singular vectors are required, this option may be used to suppress the computation of  $U$  and the corresponding residues  $\text{res}_U$ . The return values for these data are NIL.

Depending on the size of  $U$ , this option may speed up the computation considerably.

**NoRightVectors**

Suppresses the computation of right singular vectors

If only left singular vectors are required, this option may be used to suppress the computation of  $V$  and the corresponding residues  $\text{res}_V$ . The return values for these data are NIL.

Depending on the size of  $V$ , this option may speed up the computation considerably.

**NoResidues**

Suppresses the computation of error estimates

If no error estimates are required, this option may be used to suppress the computation of the residues  $\text{res}_U$  and  $\text{res}_V$ . The return values for these data are NIL.

The alternative option name `NoErrors` used in previous MuPAD versions is still available.

**ReturnType**

Option, specified as `ReturnType = t`

Return the left and right singular vectors as matrices of domain type (Symbolic Math Toolbox)  $t$ . The following return types  $t$  are available: `DOM_ARRAY`, or `DOM_HFARRAY`, or `Dom::Matrix()`, or `Dom::DenseMatrix()`.

This option determines the domain type (Symbolic Math Toolbox) of the matrices containing the singular vectors.

**NoWarning**

Suppresses warnings

## Return Values

List  $[U, d, V, res_U, res_V]$ .  $U$  is a unitary square float matrix whose columns are left singular vectors. The list  $d$  contains the singular values.  $V$  is a unitary square float matrix whose columns are right singular vectors. The lists of float residues  $res_U$  and  $res_V$  provide error estimates for the numerical data.

## See Also

### MuPAD Functions

`linalg::eigenvalues` | `linalg::eigenvectors` | `numeric::eigenvalues` |  
`numeric::eigenvectors` | `numeric::singularvalues` |  
`numeric::spectralradius` | `numeric::svd`

## Topics

“Compute Factorizations Numerically” (Symbolic Math Toolbox)

## numeric::svd

Numerical singular value decomposition of a matrix

### Syntax

```
numeric::svd(A, options)
```

### Description

`numeric::svd` is equivalent to `numeric::singularvectors`. For details and examples, see `numeric::singularvectors`.

### Parameters

**A**

A numerical matrix of domain type (Symbolic Math Toolbox) `DOM_ARRAY`, `DOM_HFARRAY`, or of category `Cat::Matrix`.

### Return Values

List `[U, d, V, resU, resV]`. `U` is a unitary square float matrix whose columns are left singular vectors. The list `d` contains the singular values. `V` is a unitary square float matrix whose columns are right singular vectors. The lists of float residues `resU` and `resV` provide error estimates for the numerical data.

### See Also

#### MuPAD Functions

`linalg::eigenvalues` | `linalg::eigenvectors` | `numeric::eigenvalues` |  
`numeric::eigenvectors` | `numeric::singularvalues` |  
`numeric::singularvectors` | `numeric::spectralradius`



## **Topics**

“Compute Factorizations Numerically” (Symbolic Math Toolbox)

## numeric::solve

Numerical solution of equations (the float attribute of solve)

### Syntax

```
numeric::solve(eqs, <vars>, options)
float(holdsolve(eqs, <vars>, options))
float(freesolve(eqs, <vars>, options))
```

### Description

`numeric::solve` computes numerical solutions of equations. For polynomial equations, *all* solutions are returned. For non-polynomial equations, only *one* solution, if any, is returned unless the option `AllRealRoots` is used.

---

**Note** Note that only for polynomial/rational equations *all* solutions are searched for. For non-polynomial/non-rational equations, only one solution, if any, is returned unless the option `AllRealRoots` is used.

---

If the equations contain non-polynomial expressions, it is in general not possible to isolate

*all* roots numerically. Think of equations such as  $\sin\left(\frac{1}{x}\right) = 0$  that have infinitely many real solutions around the origin! If a complete set of *all* real solutions of a single non-polynomial/non-rational equation in one unknown is desired, you may try the option `AllRealRoots`. With this option, a heuristics tries to isolate all real solutions of the equation. This, however, is purely heuristical: there is no rigor in the algorithm and it is not guaranteed that all solutions are found. Alternatively, you may also use the routine `numeric::realroots` to isolate the intervals in which solutions may exist.

`numeric::solve` is a simple interface function unifying the functionality of the numerical solvers `numeric::fsolve`, `numeric::linsolve`, `numeric::polyroots`, and `numeric::polysysroots`. The return format of these routines is changed to make it consistent with the return values of the symbolic solver `solve`.

You may call the specialized numerical solvers directly. However, note the return types specific to each of these solvers.

`numeric::solve` classifies the equations as follows:

- If `eqs` is a single univariate polynomial equation, then it is directly passed to `numeric::polyroots`. Cf. “Example 2” on page 19-337 (Symbolic Math Toolbox). The roots are returned as a set or as a `Dom::Multiset` if `Multiple` is used.
- If `eqs` is a multivariate polynomial equation or a list or set of such equations, then the equations and the appropriate optional arguments are passed to either `numeric::linsolve` or `numeric::polysysroots`. Cf. “Example 3” on page 19-337 (Symbolic Math Toolbox). The roots are returned as a set or as a `Dom::Multiset` if `Multiple` is used.
- A rational equation or a set or list of rational equations is replaced by its/their numerator(s). Such equations are processed like polynomial equations.
- If `eqs` is a non-polynomial/non-rational equation or a set or list containing such an equation, then the equations and the appropriate optional arguments are passed to the numerical solver `numeric::fsolve`.

---

**Note** For non-polynomial equations, only a single numerical root is returned, unless `AllRealRoots` is specified! Cf. “Example 4” on page 19-338 (Symbolic Math Toolbox).

---

---

**Note** For non-polynomial equations, there must not be more equations than unknowns!

---

Using `Multiple` for non-polynomial equations leads to an error, unless the option `AllRealRoots` is specified, too!

---

**Note** For systems of multivariate non-polynomial equations, MuPAD uses a Newton search. It must be able to evaluate the partial derivatives of the equations with respect to the variables to be solved for.

---

For a single univariate equation, first a bisectioning scheme with quadratic interpolation is used that does not require any differentiation of the equation. If this is not successful, a Newton search is started that requires the derivative of the functions involved.

For convenience, also polynomials (Symbolic Math Toolbox) of domain type `DOM_POLY` are accepted, wherever an equation is expected.

---

**Note** In contrast to the symbolic solver `solve`, the numerical solver does not react to properties of identifiers set via `assume`. The only exception where `numeric::solve` reacts to properties of identifiers is for systems of polynomial equations (only where there is more than one variable).

To react to properties of identifiers, instead call `float ( hold( solve ) (arguments) )`.

---

If the user does not specify indeterminates to be solved for, then the indeterminates are internally chosen by `numeric::indets(eqs)`.

Starting points such as `x = a` or search ranges such as `x = a..b` specified in `vars` are ignored if `eqs` is a polynomial equation or a system of polynomial equations.

## Environment Interactions

The function is sensitive to the environment variable `DIGITS`, which determines the numerical working precision.

## Examples

### Example 1

The following three solver calls are equivalent:

```
eqs := {x^2 = sin(y), y^2 = cos(x)}:  
numeric::solve(eqs, {x, y}),  
float(hold(solve)(eqs, {x, y})),  
float(freeze(solve)(eqs, {x,y}))
```

```
{[x = -0.8517004887, y = 0.8116062151]}, {[x = -0.8517004887, y = 0.8116062151]},  
{[x = -0.8517004887, y = 0.8116062151]}
```

delete eqs:

## Example 2

We demonstrate the root search for univariate polynomials:

```
numeric::solve(x^6 - PI*x^2 = sin(3), x)
```

```
{-1.339589766, 1.339589766, -1.322706294 i, -0.2120113223 i, 0.2120113223 i,
 1.322706295 i}
```

Polynomials of type DOM\_POLY can be used as input:

```
numeric::solve(poly((x - 1/3)^3, [x]), x)
```

```
{0.3333333333}
```

With `Multiple`, a `Dom::Multiset` is returned, indicating the multiplicity of the root:

```
numeric::solve(x^3 - x^2 + x/3 - 1/27, x, Multiple)
```

```
{[0.3333333333, 3]}
```

## Example 3

We demonstrate the root search for polynomial systems. Note that the symbolic solver `solve` is involved if the system is nonlinear. Symbolic parameters are accepted:

```
numeric::solve({x^2 + y^2 = 1, x^2 - y^2 = exp(z)}, {x, y})
```

$$\left\{ \left[ x = -0.7071067812 \sqrt{e^z + 1.0}, y = -\sigma_1 \right], \left[ x = -0.7071067812 \sqrt{e^z + 1.0}, y = \sigma_1 \right], \right. \\ \left. \left[ x = 0.7071067812 \sqrt{e^z + 1.0}, y = -\sigma_1 \right], \left[ x = 0.7071067812 \sqrt{e^z + 1.0}, y = \sigma_1 \right] \right\}$$

where

$$\sigma_1 = 0.7071067812 \sqrt{1.0 - 1.0 e^z}$$

#### Example 4

We demonstrate the root search for non-polynomial equations. Without the option `AllRealRoots`, only one solution is searched for:

```
eq := exp(-x) - 10*x^2:  
numeric::solve(eq, x)
```

```
{0.2755302947}
```

Since `numeric::solve` just calls the root finder `numeric::fsolve`, one may also use this routine directly. Note the different output format:

```
numeric::fsolve(eq, x)
```

```
[x = 0.2755302947]
```

The input syntax of `numeric::solve` and `numeric::fsolve` are identical, i.e., starting points, search ranges and options may be used. E.g., another solution of the previous equation is found by a restricted search over the interval  $[-1, 0]$ :

```
numeric::solve(eq, x = -1..0, RestrictedSearch)
```

```
{-0.3829657727}
```

We use the option `AllRealRoots` to isolate all real solutions of the equation:

```
numeric::solve(eq, x, AllRealRoots)
```

```
{-5.827897796, -0.3829657727, 0.2755302947}
```

With the following call we restrict the search to the negative semi-axis:

```
numeric::solve(eq, x = -infinity..0, AllRealRoots)
```

```
{-5.827897796, -0.3829657727}
```

## Example 5

For the following system, `numeric::solve` finds the solution with positive  $y$ :

```
eqs := [exp(x) = 2*y^2, sin(y) = y*x^3]:
numeric::solve(eqs, [x, y])
```

```
{[x = 0.9290711314, y = 1.125201325]}
```

Another solution with negative  $y$  is found with an appropriate search range:

```
numeric::solve(eqs, [x = 1, y = -infinity..0])
```

```
{[x = 0.9290711314, y = -1.125201325]}
```

```
delete eq, eqs:
```

## Parameters

### eqs

An equation, a list on page 7-41, set on page 7-50, array, or matrix (`Cat::Matrix`) of equations. Also arithmetical expressions (Symbolic Math Toolbox) are accepted and interpreted as homogeneous equations.

**vars**

An unknown, a list of unknowns or a set of unknowns. Unknowns may be identifiers on page 7-29 or indexed identifiers on page 1-1017. Also equations of the form  $x=a$  or  $x=a..b$  are accepted wherever an unknown  $x$  is expected. This way, starting points and search ranges are specified for the numerical search. They must be numerical; infinite search ranges are accepted.

## Options

**AllRealRoots**

Only to be used if `eqs` is a single equation in one unknown. With this option, a *heuristics* is used to find *all* real solutions of the equation.

---

**Note** Note that there is no guarantee that all real solutions will be found.

---

---

**Note** Interval arithmetic on page 7-33 is used to isolate search intervals for the solutions. The expressions in `eqs` must be suitable for such arithmetic. Internally, the procedure `numeric::realroots` is called. See the help page of `numeric::realroots` for restrictions on the expressions in `eqs`.

---

---

**Note** The equation must be suitable for evaluation with interval arithmetic on page 7-33. See `numeric::realroots` for restrictions on the expressions in the equation.

---

With `AllRealRoots`, only the additional options `Multiple` and `NoWarning` have an effect. All other options such as `UnrestrictedSearch` etc. are ignored.

It is highly recommend to specify a search interval by a call such as `numeric::solve(f(x), x = a..b, AllRealRoots)`. In this case, only the real solutions between `a` and `b` are searched for.

The search for all real solutions may be very time consuming!



**Multiple**

Only to be used if `eqs` is a polynomial equation or a system of polynomial equations or in conjunction with the option `AllRealRoots`. With this option, information on the multiplicity of degenerate polynomial roots is returned.

It changes the return type from `DOM_SET` to `Dom::Multiset`.

**FixedPrecision**

Only to be used if `eqs` is a single univariate polynomial. It launches a quick numerical search with fixed internal precision.

It is passed to `numeric::polyroots`, which uses a numerical search with fixed internal precision. This is fast, but degenerate roots may be returned with a restricted precision. See the help page of `numeric::polyroots` for details.

**SquareFree**

Only to be used if `eqs` is a single univariate polynomial. Symbolic square free factorization is applied, before the numerical search starts.

It is passed to `numeric::polyroots`, which preprocesses the polynomial by a symbolic square free factorization. See the help page of `numeric::polyroots` for details.

**Factor**

Only to be used if `eqs` is a single univariate polynomial. Symbolic factorization is applied, before the numerical search starts.

It is passed to `numeric::polyroots`, which preprocesses the polynomial by a symbolic factorization. See the help page of `numeric::polyroots` for details.

**RestrictedSearch**

The numerical search is restricted to the search ranges specified in `vars`.

This option is passed to `numeric::fsolve`, which uses a corresponding search strategy when looking for roots in the search range specified in `vars`. It must be used only in conjunction with search range and only for non-polynomial equations.

See `numeric::fsolve` for details.

### **UnrestrictedSearch**

The numerical search may return results outside the search ranges specified in `vars`.

This option is passed to `numeric::fsolve`, which uses a corresponding search strategy when looking for roots in the search range specified in `vars`. It must be use only in conjunction with search ranges and only for non-polynomial equations.

See `numeric::fsolve` for details.

### **MultiSolutions**

Only to be used for non-polynomial equations in conjunction with `RestrictedSearch`. Several roots may be returned.

It is passed to `numeric::fsolve`, which returns a sequence of all roots found in the internal search. See the help page of `numeric::fsolve` for details.

### **Random**

Only to be used for non-polynomial equations. With this option, several calls to `numeric::solve` may lead to different solutions of the equation(s).

It is passed to `numeric::fsolve` which switches to a random search strategy. See the help page of `numeric::fsolve` for details.

### **NoWarning**

This option only has an effect when it is used for polynomial equations in conjunction with `AllRealRoots`. When you use `AllRealRoots`, warnings are issued if interval arithmetic indicates technical difficulties such as serious overestimation (for example, when encountering multiple roots). With this option, the warnings are suppressed.

---

**Note** This option has an effect if `eqs` is a multivariate polynomial system or a univariate polynomial with a symbolic parameter.

---

In such a case, this option is passed to `numeric::polysysroots`.

## Return Values

Set of numerical solutions. With the option `Multiple`, a set of domain type `Dom::Multiset` is returned.

## See Also

### MuPAD Functions

`isolate` | `linsolve` | `numeric::fsolve` | `numeric::linsolve` |  
`numeric::polyroots` | `numeric::polysysroots` | `numeric::realroot` |  
`numeric::realroots` | `polylib::realroots` | `solve`

## Topics

“Solve Equations Numerically” (Symbolic Math Toolbox)

## **numeric::sort**

Sort a numerical list

### **Syntax**

```
numeric::sort(list)
```

### **Description**

`numeric::sort(list)` sorts the elements in `list`.

The elements of the list are sorted such that their real parts are descending. Elements with the same real part are sorted from large absolute value to small absolute value. In case of a tie (i.e., two elements form a complex conjugate pair), the element with positive imaginary part comes first.

The elements of the list are converted to floating-point numbers via `float`. Elements that cannot be converted lead to an error.

This function is used to sort the return values of `numeric::eigenvalues`, `numeric::eigenvectors`, `numeric::polyroots`, `numeric::singularvalues`, and `numeric::singularvectors`.

### **Environment Interactions**

The function is sensitive to the environment variable `DIGITS`.

### **Examples**

#### **Example 1**

The elements in the sorted list have descending real parts:

```
numeric::sort([1, 2.0, I, -3, -I, PI, sqrt(2)])
```

```
[3.141592654, 2.0, 1.414213562, 1.0, 1.0 i, -1.0 i, -3.0]
```

In the following example, the sorting criterion does not seem to be satisfied. Elements with the same real part are supposed to be ordered from large absolute values to small absolute values:

```
x := sin(PI/3):
L := numeric::sort([x, sin(float(PI/3)) - I, x + I])
```

```
[0.8660254038 + 1.0 i, 0.8660254038 - 1.0 i, 0.8660254038]
```

This is explained by the fact that the floating-point numbers internally have a more accurate representation than shown on the screen. The real part of the last element is indeed a little bit smaller than the other real parts:

```
DIGITS := 20:
L
```

```
[0.8660254037844386469 + 1.0 i, 0.8660254037844386469 - 1.0 i, 0.8660254037844386469]
```

```
delete x, L, DIGITS:
```

## Parameters

### list

A list of numbers or numerical expressions

## Return Values

Sorted list.

## **See Also**

**MuPAD Functions**

sort

# numeric::spectralradius

Spectral radius of a matrix

## Syntax

```
numeric::spectralradius(A, <x0>, <n>, <mode>, <ReturnType = t>, <NoWarning>)
```

## Description

`numeric::spectralradius(A)` returns data corresponding to the eigenvalue of the matrix `A` that has the largest absolute value.

The spectral radius of a matrix with eigenvalues  $\lambda_i$  is  $\max(|\lambda_i|)$ .

The return value `lambda` is an approximation of the corresponding eigenvalue: `abs(lambda)` is the spectral radius.

The return value `x` is the corresponding normalized eigenvector:  $\|x\|_2 = 1$ .

The return value `residue =  $\|Ax - \lambda x\|_2$`  provides an error estimate for the eigenvalue. For Hermitian matrices this is a rigorous upper bound for the error  $|\lambda - \lambda_{exact}|$ , where  $\lambda_{exact}$  is the exact eigenvalue.

`numeric::spectralradius` implements the power method to compute the eigenvalue and the associated eigenvector defining the spectral radius: the vector iteration

$x_i = \frac{A^i x_0}{\|A^i x_0\|_2}$  “converges” towards the eigenspace associated with the spectral radius. The starting vector  $x_0$  is provided by the second argument of `numeric::spectralradius`. If no starting vector is provided by the user, a randomly chosen vector is used.

---

**Note** The iteration does not converge (converges slowly), if the spectral radius is generated by several distinct eigenvalues with the same (similar) absolute value.

---

Internally, the iteration stops, when the approximation of the eigenvalue becomes stationary within the relative precision given by DIGITS. If this does not happen within  $n$  iterations, then a warning is issued and the present values are returned. Cf. “Example 4” on page 19-351 (Symbolic Math Toolbox).

`numeric::spectralradius` and `numeric::spectralRadius` are equivalent.

## Environment Interactions

The function is sensitive to the environment variable DIGITS, which determines the numerical working precision.

## Examples

### Example 1

We let the routine choose a random starting vector:

```
A := matrix(2, 2, [[10, 1], [1, 20]]):  
numeric::spectralradius(A)
```

$$\left[ 20.09901951, \left( \begin{array}{c} 0.0985376181 \\ 0.9951333267 \end{array} \right), 0.000000001332123191 \right]$$

We define a starting vector as a 1-dimensional array and allow a maximum of 1000 internal iterations:

```
A := array(1..2, 1..2, [[1, 2], [5, -10]]):  
x0 := array(1..2, [1, 1]):  
numeric::spectralradius(A, x0, 1000)
```

$$\left[ -10.84428877, \left( 0.1665007247 - 0.9860413321i \right), 7.808576008 \cdot 10^{-11} \right]$$

Next, we use a list to specify a starting vector:

```
A := array(1..2, 1..2, [[I, 3], [3, I]]):  
numeric::spectralradius(A, [1, 1], 1000)
```



```
[3.0 + 1.0 i, [0.7071067812, 0.7071067812], 0.0]
```

```
delete A, x0:
```

## Example 2

With the default setting of DIGITS = 10, the following result is computed using HardwareFloats.

```
A := hfarray(1..2, 1..2, [[10^4, 10^4], [50, 60]]):
x0 := array(1..2, [1, 1]):
numeric::spectralradius(A, x0)
```

```
[10050.0498, ( 0.9999874753 0.00500491737 ), 0.000000004820940092]
```

We request SoftwareFloats in the next call. Note the difference in the trailing digits:

```
numeric::spectralradius(A, x0, Soft)
```

```
[10050.0498, ( 0.9999874753 0.00500491737 ), 0.000000004820942201]
```

```
delete DIGITS, A, x0:
```

## Example 3

The eigenvector that is returned can have various types. If no starting vector is provided, the type of the matrix determines the type of the eigenvector:

```
A:= array(1..2, 1..2, [[1, 2], [3, 4]]):
[l, x, residue]:= numeric::spectralradius(A);
```

```
[5.372281324, ( 0.4159735579 0.9093767091 ), 0.0000000002881934691]
```

```
domtype(x)
```

```
DOM_ARRAY
```

```
A:= hfarray(1..2, 1..2, [[1, 2], [3, 4]]):  
[l, x, residue]:= numeric::spectralradius(A):  
domtype(x)
```

### DOM\_HFARRAY

```
A:= matrix(2, 2, [[1, 2], [3, 4]]):  
[l, x, residue]:= numeric::spectralradius(A):  
domtype(x)
```

### Dom::Matrix()

If a starting vector is provided, its type determines the type of the return vector:

```
A:= hfarray(1..2, 1..2, [[1, 2], [3, 4]]):  
x0:= [1, 1]:  
[l, x, residue]:= numeric::spectralradius(A, x0):  
domtype(x)
```

### DOM\_LIST

```
x0:= array(1..2, [1, 1]):  
[l, x, residue]:= numeric::spectralradius(A, x0):  
domtype(x)
```

### DOM\_ARRAY

```
x0:= hfarray(1..2, [1, 1]):  
[l, x, residue]:= numeric::spectralradius(A, x0):  
domtype(x)
```

### DOM\_HFARRAY

```
x0:= matrix([1, 1]):  
[l, x, residue]:= numeric::spectralradius(A, x0):  
domtype(x)
```

### Dom::Matrix()

The return type can be requested explicitly:

```
[l, x, residue] :=
  numeric::spectralradius(A, x0, ReturnType = DOM_LIST):
  domtype(x)
```

DOM\_LIST

```
[l, x, residue] :=
  numeric::spectralradius(A, x0, ReturnType = DOM_HFARRAY):
  domtype(x)
```

DOM\_HFARRAY

```
delete A, x0, l, x, residue:
```

## Example 4

The following matrix has two distinct eigenvalues 1 and -1 of the same absolute value. The power method must fail.

```
A := array(1..2, 1..2, [[1, 0], [0, -1]]):
```

We allow a maximum of 1000 internal steps. The call results in a warning. The large residue also indicates that the power method did not converge:

```
numeric::spectralradius(A, [1, 1], 1000)
```

```
Warning: No convergence of vector iteration. [numeric::spectralradius]
```

```
[1.0, [0.7071067812, -0.7071067812], 1.414213562]
```

```
delete A:
```

## Parameters

### **A**

An  $m \times m$  array of domain type `DOM_ARRAY` or `DOM_HFARRAY` or a matrix of category `Cat::Matrix`

### **$x_0$**

A starting vector: a 1-dimensional array, or an `hfarray`, or a list of length  $m$ . Also 2-dimensional arrays (`array(1..m, 1..1, ...)`, `hfarray(1..m, 1..1, ...)`) and matrices representing vectors are accepted.

### **n**

The maximal number of iterations: a positive integer. The default value is 1000.

### **mode**

One of the flags `Hard`, `HardwareFloats`, `Soft`, or `SoftwareFloats`

## Options

### **Hard, HardwareFloats, Soft, SoftwareFloats**

With `Hard` (or `HardwareFloats`), computations are done using fast hardware float arithmetic from within a MuPAD session. `Hard` and `HardwareFloats` are equivalent. With this option, the input data are converted to hardware floats and processed by compiled C code. The result is reconverted to MuPAD floats and returned to the MuPAD session.

With `Soft` (or `SoftwareFloats`) computations are done using software float arithmetic provided by the MuPAD kernel. `Soft` and `SoftwareFloats` are equivalent. `SoftwareFloats` is used by default if the current value of `DIGITS` is larger than 15 and the input matrix `A` is not of domain type `DOM_HFARRAY`.

Compared to the `SoftwareFloats` used by the MuPAD kernel, the computation with `HardwareFloats` may be many times faster. Note, however, that the precision of hardware arithmetic is limited to about 15 digits. Further, the size of floating-point numbers may not be larger than approximately  $10^{308}$  and not smaller than approximately  $10^{-308}$ .

If no `HardwareFloats` or `SoftwareFloats` are requested explicitly, the following strategy is used: If the current value of `DIGITS` is smaller than 16 or if the matrix `A` is a hardware float array of domain type `DOM_HFARRAY`, then hardware arithmetic is tried. If this is successful, the result is returned.

If the result cannot be computed with hardware floats, software arithmetic by the MuPAD kernel is tried.

If the current value of `DIGITS` is larger than 15 and the input matrix `A` is not of domain type `DOM_HFARRAY`, or if one of the options `Soft`, `SoftwareFloats` or `Symbolic` is specified, MuPAD computes the result with its software arithmetic without trying to use hardware floats first.

There may be several reasons for hardware arithmetic to fail:

- The current value of `DIGITS` is larger than 15.
- The data contains symbolic objects.
- The data contains numbers larger than  $10^{308}$  or smaller than  $10^{-308}$  that cannot be represented by hardware floats.

If neither `HardwareFloats` nor `SoftwareFloats` is specified, the user is not informed whether hardware floats or software floats are used.

If `HardwareFloats` are specified but fail due to one of the reasons above, a warning is issued that the (much slower) software floating-point arithmetic of the MuPAD kernel is used.

Note that `HardwareFloats` can only be used if all input data can be converted to floating-point numbers.

The trailing digits in floating-point results computed with `HardwareFloats` and `SoftwareFloats` may differ.

### **ReturnType**

Option, specified as `ReturnType = t`

Return the eigenvector associated with the spectral radius as a vector of domain type (Symbolic Math Toolbox) `t`. The following return types are available: `DOM_ARRAY`, or `DOM_HFARRAY`, or `DOM_LIST`, or `Dom::Matrix()`, or `Dom::DenseMatrix()`.

**NoWarning**

Suppresses warnings

**Return Values**

A list [`lambda`, `x`, `residue`] is returned. The floating-point number `lambda` is an approximation of the eigenvalue of largest absolute value. The vector `x` is a numerical eigenvector corresponding to `lambda`. `residue` is a floating-point number indicating the numerical quality of `lambda` and `x`.

If no return type is requested via the `ReturnType` option, the type of the returned vector `x` coincides with the type of the input vector  $x_0$  (i.e., it is a 1-dimensional array of type `DOM_ARRAY` or `DOM_HFARRAY`, respectively, or a list on page 7-41, or a column vector of type `matrix` or `densematrix`). If no starting vector is specified, the type of `x` is determined by the type of `A`.

**See Also****MuPAD Functions**

`linalg::eigenvalues` | `linalg::eigenvectors` | `numeric::eigenvalues` |  
`numeric::eigenvectors` | `numeric::singularvalues` |  
`numeric::singularvectors` | `numeric::spectralRadius` | `numeric::svd`

# numeric::spectralRadius

Spectral radius of a matrix

## Syntax

```
numeric::spectralRadius(A, <x0>, <n>, <mode>, <ReturnType = t>, <NoWarning>)
```

## Description

`numeric::spectralRadius` and `numeric::spectralradius` are equivalent. For details and examples, see `numeric::spectralradius`.

## Environment Interactions

The function is sensitive to the environment variable `DIGITS`, which determines the numerical working precision.

## Parameters

### A

An  $m \times m$  array of domain type `DOM_ARRAY` or `DOM_HFARRAY` or a matrix of category `Cat::Matrix`

### $x_0$

A starting vector: a one-dimensional array, or an `hfarray`, or a list of length  $m$ . Also two-dimensional arrays (`array(1..m, 1..1, ...)`, `hfarray(1..m, 1..1, ...)`) and matrices representing vectors are accepted.

### n

The maximal number of iterations: a positive integer. The default value is 1000.

**mode**

One of the flags `Hard`, `HardwareFloats`, `Soft`, or `SoftwareFloats`

## Return Values

A list `[lambda, x, residue]` is returned. The floating-point number `lambda` is an approximation of the eigenvalue of largest absolute value. The vector `x` is a numerical eigenvector corresponding to `lambda`. `residue` is a floating-point number indicating the numerical quality of `lambda` and `x`.

If no return type is requested via the `ReturnType` option, the type of the returned vector `x` coincides with the type of the input vector  $x_0$  (i.e., it is a one-dimensional array of type `DOM_ARRAY` or `DOM_HFARRAY`, respectively, or a list on page 7-41, or a column vector of type `matrix` or `densematrix`. If no starting vector is specified, the type of `x` is determined by the type of `A`.

## See Also

**MuPAD Functions**

`linalg::eigenvalues` | `linalg::eigenvectors` | `numeric::eigenvalues` |  
`numeric::eigenvectors` | `numeric::singularvalues` |  
`numeric::singularvectors` | `numeric::spectralradius` | `numeric::svd`



## numeric::sum

Numerical approximation of sums (the Float attribute of Sum )

### Syntax

```

numeric::sum(f(x), x = a .. b)
numeric::sum(f(x), x in {x1, x2, ...})
numeric::sum(f(x), x = {x1, x2, ...})
numeric::sum(f(x), x in RootOf(p(X), X))
numeric::sum(f(x), x = RootOf(p(X), X))
float(hold(sum)(f(x), x = a .. b))
float(hold(sum)(f(x), x in {x1, x2, ...}))
float(hold(sum)(f(x), x = {x1, x2, ...}))
float(hold(sum)(f(x), x in RootOf(p(X), X)))
float(hold(sum)(f(x), x = RootOf(p(X), X)))
float(freeze(sum)(f(x), x = a .. b))
float(freeze(sum)(f(x), x in {x1, x2, ...}))
float(freeze(sum)(f(x), x = {x1, x2, ...}))
float(freeze(sum)(f(x), x in RootOf(p(X), X)))
float(freeze(sum)(f(x), x = RootOf(p(X), X)))

```

### Description

`numeric::sum(f(i), i=a..b)` computes a numerical approximation of  $\sum_{i=a}^b f(i)$ .

`numeric::sum(f(x), x ∈ {x1, x2, ...})` computes a numerical approximation of

$$\sum_{x \in \{x_1, x_2, \dots\}} f(x).$$

`numeric::sum(f(x), x in RootOf(p(X), X))` computes a numerical approximation

of 
$$\sum_{x \in \text{RootOf}(p(X), X)} f(x).$$

The call `numeric::sum(...)` is equivalent to calling the `float` attribute of `sum` via `float ( hold( sum )(...))` or `float ( freeze( sum )(...))`.

If there are other symbolic parameters in  $f(x)$ , apart from the summation variable  $x$ , a symbolic sum is returned. Numerical expressions such as  $e^{\pi}$ ,  $\sqrt{2}$  etc. are accepted and converted to floating-point numbers.

---

**Note** For infinite sums, the expression  $f(i)$  with integer  $i$  must have an extension  $f(x)$  to all real  $x$  in the interval  $[a, b]$ . Internally, the integral  $\int_a^b f(x) dx$  is computed numerically and used in the approximation process.

---

---

**Note** For finite sums, `numeric::sum` just returns `_plus ( float(f(i)$i=a..b)`. Note that numerical cancellation may occur! If  $f(i)$  does not contain floating-point numbers, cancellation can be avoided summing the symbolic terms by `_plus(f(i)$i=a..b)` instead. Cf. "Example 3" on page 19-360 (Symbolic Math Toolbox).

---

Convergence is fast, if  $f(x)$  decays rapidly for  $x \rightarrow \text{infinity}$  or  $|x| \rightarrow \text{infinity}$ , respectively

---

**Note** Convergence may be slow for alternating sums containing expressions such as  $(-1)^i$ . Such sums are also often subject to cancellation problems!

---

The call `numeric::sum(f(x), x = {x1, x2, ...})` computes numerical approximations of  $x_1, x_2$  etc., substitutes these values into  $f(x)$  and adds up the results. This process may be subject to cancellation problems!

The calls `numeric::sum(f(x), x ∈ {x1, x2, ...})` and `numeric::sum(f(x), x = {x1, x2, ...})` are equivalent.

The call `numeric::sum(f(x), x in RootOf(p(X), X))` computes numerical approximations of all roots of  $p$ , substitutes these values into  $f(x)$  and adds up the results. Cf. “Example 4” on page 19-361 (Symbolic Math Toolbox). This process may be subject to cancellation problems!

The calls `numeric::sum(f(x), x in RootOf(p(X), X))` and `numeric::sum(f(x), x = RootOf(p(X), X))` are equivalent.

## Environment Interactions

The function is sensitive to the environment variable `DIGITS`, which determines the numerical working precision.

## Examples

### Example 1

We demonstrate some equivalent calls for numerical summation:

```
numeric::sum(1/i!, i = 0..infinity),
float(hold(sum)(1/i!, i = 0..infinity)),
float(freeze(sum)(1/i!, i = 0..infinity))
```

2.718281828, 2.718281828, 2.718281828

The MuPAD symbolic summation `sum` does not find a simple representation of the following sum:

```
sum(1/i!/(i^2+1)!, i = 0..infinity)
```

$$\sum_{i=0}^{\infty} \frac{1}{(i^2+1)! i!}$$

The following float evaluation calls `numeric::sum`:

```
float(%)
```

1.504166713

The exact value of the following sum is  $\pi \coth(\pi)$ :

```
numeric::sum(1/(1+i^2), i = -infinity..infinity) =  
float(PI*coth(PI))
```

3.153348095 = 3.153348095

## Example 2

The following sum cannot be evaluated numerically because of the symbolic parameter  $x$ :

```
numeric::sum(1/(x+i^2), i = -infinity..infinity)
```

$$\text{numeric::sum}\left(\frac{1}{i^2 + x}, i = -\infty.. \infty\right)$$

## Example 3

We demonstrate numerical cancellation when summing the Taylor series for  $e^{-20}$ :

```
exp(-20.0) <> numeric::sum((-20)^i/i!, i = 0..100)
```

0.000000002061153622  $\neq$  0.000000002148938644

Also the infinite sum suffers from cancellation:

```
exp(-20.0) <> numeric::sum((-20)^i/i!, i = 0..infinity)
```

0.000000002061153622  $\neq$  0.000000002205327316

Cancellation can be avoided using a finite sum with exact terms:

```
exp(-20.0) = float(_plus((-20)^i/i! $ i = 0..100))
```

0.000000002061153622 = 0.000000002061153622

## Example 4

The following call computes the numerical roots of the polynomial in the `RootOf` expression and sums over all the roots:

```
numeric::sum(exp(x)/x, x in RootOf(X^10 - X - PI, X))
```

9.681693381

## Parameters

**f(x)**

An arithmetical expression (Symbolic Math Toolbox) in  $x$

**i, x**

Summation variables: identifiers or indexed identifiers

**a, b**

Integers or  $\pm\text{infinity}$  satisfying  $a \leq b$

**x<sub>1</sub>, x<sub>2</sub>, ...**

Numerical expressions

**p(X)**

A univariate polynomial expression in  $X$

**X**

The indeterminate of  $p$ : an identifier or an indexed identifier

## Return Values

Floating point number or a symbolic expression of type `numeric::sum`.

## Algorithms

Depending on whether the series is alternating or monotone, `numeric::sum` tries a number of strategies to calculate its limit: Levin's u transformation, the Euler-MacLaurin formula or van Wijngaarden's trick.

The Euler-MacLaurin formula is

$$\sum_{i=a}^b f(i) = \frac{f(a) + f(b)}{2} + \int_a^b f(x) dx + \left( \sum_{m=1}^M \frac{B_{2m}}{(2m)!} \left( f(b)^{(2m-1)} - f(a)^{(2m-1)} \right) \right) + \dots$$

involving the Bernoulli numbers on page 1-297  $B_{2m}$ .

## See Also

### MuPAD Functions

`_plus` | `int` | `numeric::product` | `numeric::quadrature` | `sum`

### Topics

"Compute Symbolic Sums" (Symbolic Math Toolbox)

"Approximate Sums Numerically" (Symbolic Math Toolbox)

# numlib - Number Theory

---

# numlib::checkPrimalityCertificate

Test the primality certificate

## Syntax

```
numlib::checkPrimalityCertificate(certificate)
```

## Description

`numlib::checkPrimalityCertificate` tests the certificate of primality returned by `numlib::proveprime`. For large prime numbers, the `numlib::proveprime` function generates certificates that provide all data you need for proving primality of a number by the Atkin-Goldwasser-Kilian-Morain algorithm. See “Example 1” on page 20-2 (Symbolic Math Toolbox).

For small prime numbers, `numlib::proveprime` does not return a certificate of primality. Instead, it returns `TRUE`. For nonprime numbers `numlib::proveprime` returns `FALSE`. In both cases, you do not need to use `numlib::checkPrimalityCertificate`.

## Examples

### Example 1

Use the `numlib::proveprime` function to check the primality of the number 1299709. The function returns the following sequence of lists. This sequence is the certificate of primality:

```
certificate := numlib::proveprime(1299709)
```

```
[1299709, 15, [2, 2, 2, 2, 2, 107, 379], 700619, 67686, 0, 796444, [107, 379]]
```

The certificate provides all data that you need for proving primality of 1299709 by the Atkin-Goldwasser-Kilian-Morain algorithm. You can substitute the numbers into the



algorithm and verify the primality of the number. Alternatively, you can verify the certificate by using the `numlib::checkPrimalityCertificate` function:

```
numlib::checkPrimalityCertificate(certificate)
```

```
TRUE
```

## Parameters

**certificate**

A list or a sequence of lists returned by `numlib::proveprime`

## Return Values

TRUE or FALSE

## See Also

**MuPAD Functions**

`ifactor` | `numlib::proveprime`

## Topics

“Primes and Factorizations” (Symbolic Math Toolbox)

## numlib::contfrac

Domain of continued fractions

### Syntax

numlib::contfrac(x, <n>)

### Description

numlib::contfrac(x) creates a continued fraction approximation for the real number x.

If x is an integer or a rational number and n is not specified, a continued fraction is returned that represents x exactly. Cf. “Example 1” on page 20-5 (Symbolic Math Toolbox).

Irrational numerical values x such as  $1 + \text{sqrt}(2)$  or  $\text{PI}/3$  are first converted to floating-point numbers. The first n significant decimals of floating-point numbers are taken into account. If n is not specified,  $n = \text{DIGITS}$  is used. The value of the continued fraction (given by numlib::contfrac ::rational) satisfies

$$|x - \text{numlib::contfrac::rational}(x)| \leq |x| \frac{1}{10^n}.$$

Integers or rational numbers are also converted to floating point numbers, if a precision n is specified.

Objects of type numlib::contfrac can be handled by the usual arithmetical operations. They are sensitive to the environment variable DIGITS if floating-point numbers or irrational numerical values are involved.

Use contfrac to compute continued fraction approximations of expressions involving symbolic parameters.

## Examples

### Example 1

For rational numbers, exact representations are returned:

```
numlib::contfrac(123/1234)
```

$$10 + \frac{1}{30 + \frac{1}{1 + \frac{1}{3 + \dots}}}$$

The rational representation (the second operand of the continued fraction) coincides with the original rational:

```
numlib::contfrac::rational(%), expr(%), op(%, 2)
```

$$\frac{123}{1234}, \frac{123}{1234}, \frac{123}{1234}$$

Restricted continued fraction approximations can be computed by passing a precision as second argument:

```
numlib::contfrac(123/1234, 2),
numlib::contfrac(123/1234, 3),
numlib::contfrac(123/1234, 5)
```

$$\frac{1}{10 + \dots}, \frac{1}{10 + \frac{1}{30 + \dots}}, \frac{1}{10 + \frac{1}{30 + \frac{1}{1 + \frac{1}{3 + \dots}}}}$$

$$\frac{1}{10 + \dots}, \frac{1}{10 + \frac{1}{30 + \dots}}, \frac{1}{10 + \frac{1}{30 + \frac{1}{1 + \frac{1}{3 + \dots}}}}$$

## Example 2

The coefficients are extracted by the method `nthcoeff`:

```
cf := numlib::contfrac(12/123)
```

$$\frac{1}{10 + \frac{1}{4 + \dots}}$$

```
nthcoeff(cf, 1), nthcoeff(cf, 2), nthcoeff(cf, 3), nthcoeff(cf, 4)
```

```
0, 10, 4, FAIL
```

The internal list of coefficients can also be queried via `op`:

```
op(cf, 1)
```

```
[0, 10, 4]
```

```
delete cf:
```

## Example 3

`numlib::contfrac` can also compute continued fraction approximations of irrational numbers:

```
numlib::contfrac(PI, 2),  
numlib::contfrac(PI, 4),  
numlib::contfrac(PI, 5)
```

$$3 + \frac{1}{7 + \dots}, 3 + \frac{1}{7 + \frac{1}{15 + \dots}}, 3 + \frac{1}{7 + \frac{1}{15 + \frac{1}{1 + \dots}}}$$

$$3 + \frac{1}{7 + \dots}, 3 + \frac{1}{7 + \frac{1}{15 + \dots}}, 3 + \frac{1}{7 + \frac{1}{15 + \frac{1}{1 + \dots}}}$$

A finite continued fraction approximation may be regarded as an interval of numbers (the symbol ... represents a number between 0 and 1):

```
numlib::contfrac::rationalInterval(numlib::contfrac(PI, 2));
```

$$\left[ \frac{25}{8}, \frac{22}{7} \right]$$

```
float(%)
```

$$[3.125, 3.142857143]$$

## Example 4

All basic arithmetical operations are available for continued fractions:

```
x := numlib::contfrac(PI, 3):
y := numlib::contfrac(1/12):
DIGITS:= 3: 3/x + sqrt(2)*y^(1/3)
```

$$1 + \frac{1}{1 + \frac{1}{1 + \frac{1}{2 + \frac{1}{1 + \frac{1}{26 + \dots}}}}}}$$

$$1 + \frac{1}{1 + \frac{1}{1 + \frac{1}{2 + \frac{1}{1 + \frac{1}{26 + \dots}}}}}}$$

```
delete x, y, DIGITS:
```

## Example 5

We search for a simple continued fraction in an interval:

```
numlib::contfrac::convert(1/2 - 1/10^8, 1/2 + 1/10^8)
```

$$\frac{1}{2 + \dots}$$

$$\frac{1}{2 + \dots}$$

```
numlib::contfrac::convert(PI, PI + 1/10^10)
```

$$3 + \frac{1}{7 + \frac{1}{15 + \frac{1}{1 + \frac{1}{292 + \frac{1}{1 + \frac{1}{1 + \frac{1}{1 + \dots}}}}}}}}$$

$$3 + \frac{1}{7 + \frac{1}{15 + \frac{1}{1 + \frac{1}{292 + \frac{1}{1 + \frac{1}{1 + \frac{1}{1 + \dots}}}}}}}}$$

## Parameters

**x**

A real numerical expression

**n**

The number of significant digits: a positive integer greater one

## Methods

### Mathematical Methods

**\_plus** — Sum of two continued fractions

`_plus(x, y)`

**\_mult** — Product of two continued fractions

`_mult(x, y)`

**\_invert** — Reciprocal of a continued fraction

`_invert(x)`

Inverting a continued fraction means a shift of the coefficients by one to the left or to the right.

If  $x$  is an exact representation of a rational number, the continued fraction expansion of the reciprocal is also an exact representation.

**\_power** — Power of a continued fraction

`_power(x, m)`

### Access Methods

**print** — Print a continued fraction

`print(cf)`

### See Also

#### MuPAD Functions

`contfrac` | `numeric::rationalize`

## numlib::contfracPeriodic

Periodic continued fraction expansions

### Syntax

```
numlib::contfracPeriodic(p, q, n)
```

### Description

`numlib::contfracPeriodic(p, q, n)` returns the continued fraction expansion of  $p + q\sqrt{n}$  as a sequence of two lists: the first one contains the non-periodic part, the second one contains the periodic part of the expansion.

The non-periodic part may be an empty list. No periodic part is returned for rational input, i.e.,  $q = 0$  or  $n$  square.

### Examples

#### Example 1

The non-periodic part may start with zero. All other coefficients of a continued fraction expansion are positive:

```
numlib::contfracPeriodic(2/7, 1/7, 2)
```

```
[0, 2, 19], [1, 8, 1, 18]
```

The result agrees with that one of `contfrac`:

```
op(contfrac(2/7 + 1/7 *sqrt(2)), 1)
```

```
[0, 2, 19, 1, 8, 1, 18, 1, 8, 1]
```



## Example 2

The golden mean is famous for its simple continued fraction expansion:

```
numlib::contfracPeriodic(1/2, 1/2, 5)
```

```
[], [1]
```

## Example 3

Since 81 is a perfect square, there is no periodic part in the continued fraction expansion of its square root:

```
numlib::contfracPeriodic(0, 1, 81)
```

```
[9]
```

## Parameters

**p**

A rational number

**q**

A rational number

**n**

A positive integer

## Return Values

If  $p + q\sqrt{n}$  is a rational number, then `numlib::contfracPeriodic` returns one list, otherwise two lists of integers.

## Algorithms

A real number has a periodic continued fraction expansion if and only if it is of the form  $p + q\sqrt{n}$ .

## See Also

### MuPAD Functions

`numlib::contfrac` | `numlib::sqrt2cfrac`

# numlib::cornacchia

Cornachia's algorithm

## Syntax

```
numlib::cornacchia(a, b, m)
```

## Description

`numlib::cornacchia(a, b, m)` returns all pairs of positive and relatively prime integers  $x, y$  that solve the equation  $ax^2 + by^2 = m$ .

The arguments  $a, b, m$  must be pairwise relatively prime.

## Examples

### Example 1

We compute the solutions to  $3x^2 + 5y^2 = 74533332452454382449233$ :

```
numlib::cornacchia(3, 5, 74533332452454382449233)
```

```
{[22457088474, 120847316879]}
```

### Example 2

For non-prime  $m$ , there may be many solutions:

```
numlib::cornacchia(1, 4, 5*13*17*29*73)
```

```
{[103, 763], [151, 761], [217, 757], [521, 719], [553, 713], [583, 707], [809, 649],  
[887, 623], [1081, 541], [1127, 517], [1159, 499], [1367, 343], [1369, 341], [1463, 223],  
[1481, 191], [1529, 19]}
```

## Parameters

**a**

A positive integer

**b**

A positive integer

**m**

A positive integer

## Return Values

numlib::cornacchia returns a set each element of which is a list of two positive integers.

## See Also

### **MuPAD Functions**

numlib::msqrts

# numlib::decimal

Infinite representation of rational numbers

## Syntax

```
numlib::decimal(q)
```

## Description

`numlib::decimal(q)` computes the decimal expansion of a rational number  $q$ .

If  $q$  is a nonnegative rational number whose decimal expansion is finite, then `numlib::decimal(q)` returns the expression sequence starting with the integral part of  $q$  and followed by the digits after the decimal point.

If  $q$  is a nonnegative rational number whose decimal expansion is infinite, then `numlib::decimal(q)` returns the expression sequence starting with the integral part of  $q$ , followed by the digits of the pre-period and terminated with a list, containing the digits of a minimal period.

## Examples

### Example 1

Computing the decimal expansion of 1999:

```
numlib::decimal(1999)
```

```
1999
```

### Example 2

Computing the (finite) decimal expansion of  $\frac{52187}{78125}$ :

```
numlib::decimal(52187/78125)
```

```
0, 6, 6, 7, 9, 9, 3, 6
```

### Example 3

Computing the (infinite) decimal expansion of  $\frac{111}{7}$ :

```
numlib::decimal(111/7)
```

```
15, [8, 5, 7, 1, 4, 2]
```

### Example 4

Computing the (infinite) decimal expansion of  $\frac{37}{28}$ :

```
numlib::decimal(37/28)
```

```
1, 3, 2, [1, 4, 2, 8, 5, 7]
```

## Parameters

**q**

Nonnegative rational number

## Return Values

`numlib::decimal(q)` returns an expression sequence consisting of nonnegative integers or an expression sequence consisting of nonnegative integers and terminated by a list of nonnegative integers.

# numlib::divisors

Divisors of an integer

## Syntax

```
numlib::divisors(n)
```

## Description

`numlib::divisors(n)` returns the list of positive divisors of `n`.

If `a` is a non-zero integer then `numlib::divisors(a)` returns the sorted list of all positive divisors of `a`.

`numlib::divisors(0)` returns `[0]`.

`numlib::divisors` returns an error if the argument evaluates to a number of wrong type.

## Examples

### Example 1

We compute the list of all positive divisors of 72:

```
numlib::divisors(72)
```

```
[1, 2, 3, 4, 6, 8, 9, 12, 18, 24, 36, 72]
```

### Example 2

`numlib::divisors` returns the positive divisors of negative numbers, too:

```
numlib::divisors(-63)
[1, 3, 7, 9, 21, 63]
```

## Parameters

**n**

Integer

## Return Values

numlib::divisors returns a list of nonnegative integers.

## Algorithms

Internally, ifactor is used for factoring n.

## See Also

### MuPAD Functions

ifactor | numlib::numdivisors | numlib::numprimedivisors |  
numlib::primedivisors | numlib::tau | polylib::divisors



# numlib::factorGaussInt

Factorization of Gaussian integers

## Syntax

```
numlib::factorGaussInt(n)
```

## Description

`numlib::factorGaussInt(n)` returns the factorization of the Gaussian integer  $n$  into Gaussian primes. Among associate primes, that one with smallest polar angle is chosen.

## Examples

### Example 1

In the Gaussian integers, 3 remains prime while 5 does not:

```
numlib::factorGaussInt(3), numlib::factorGaussInt(5)
```

```
[1, 3, 1], [-i, 1 + 2 i, 1, 2 + i, 1]
```

### Example 2

The argument to `numlib::factorGaussInt` may be any Gaussian integer, that is, every complex number of the form  $a + bi$  where  $a$  and  $b$  are integers:

```
numlib::factorGaussInt(2+2*I)
```

```
[-i, 1 + i, 3]
```

## Parameters

**n**

An integer, or a complex number whose real and imaginary part are integers

## Return Values

`numlib::factorGaussInt` returns a list  $[u, p_1, a_1, \dots, p_k, a_k]$  where  $u$  is a unit in the Gaussian integers, the  $p_i$  are Gaussian primes and the  $a_i$  are positive integers,

such that  $n = u \left( \prod_{i=1}^k p_i^{a_i} \right)$ .

## Algorithms

The function `ifactor` is used to factor the norm; this step takes most of the running time. Hence, the running time of the algorithm mainly depends on the size of the prime factors of the norm of  $n$ .

## See Also

### MuPAD Functions

`factor`

# numlib::fibonacci

Fibonacci numbers

## Syntax

```
numlib::fibonacci(n)
```

## Description

`numlib::fibonacci(n)` returns the  $n$ -th Fibonacci number.

If  $n$  is a nonnegative integer then `numlib::fibonacci(n)` returns the  $n$ -th Fibonacci number.

`numlib::fibonacci` returns an error if the argument evaluates to a number of wrong type. `numlib::fibonacci` returns the unevaluated function call if  $n$  does not evaluate to a number.

## Examples

### Example 1

We compute the 201st Fibonacci number:

```
numlib::fibonacci(201)
```

```
453973694165307953197296969697410619233826
```

## Parameters

**n**

A nonnegative integer

## Return Values

Nonnegative integer, or the function call with its arguments evaluated.

## Algorithms

The  $n$ -th Fibonacci number  $F_n$  is defined by the recursion formula  $F_0 = 0$ ,  $F_1 = 1$ , and  $F_{n+2} = F_n + F_{n+1}$ .

`numlib::fibonacci` uses quadratic recursion formulas.

# numlib::fromAscii

Decoding of ASCII codes

## Syntax

```
numlib::fromAscii(listOfCodes)
```

## Description

If  $L$  is a list of ASCII codes then `numlib::fromAscii(L)` returns the string coded by  $L$ .

ASCII codes of non-printable characters, i. e., codes between 0 and 8 and between 11 and 31, are ignored.

`numlib::fromAscii` returns an error if its argument is not a list of integers between 0 and 127, i. e., not a list of legal ASCII codes.

## Examples

### Example 1

Non-printable characters are ignored, but tabulator and newline characters are decoded.

```
L := [0,1,2,3,9,10,31,10,9,32,45,32,101,105,110,32,  
      84,101,115,116,32,61,32,97,32,116,101,115,116]:
```

```
numlib::fromAscii(L)
```

```
"      - ein Test = a test"
```

## **Parameters**

### **listOfCodes**

A list of ASCII codes

## **Return Values**

String

## **See Also**

**MuPAD Functions**  
numlib::toAscii

# numlib::g\_adic

G-adic representation of a nonnegative integer

## Syntax

```
numlib::g_adic(number, base)
```

## Description

numlib::g\_adic(0, g) returns [0].

numlib::g\_adic returns an error if the arguments evaluate to numbers which are not both of the correct type.

If  $a$  is a natural number and  $g$  is an integer such that  $|g| > 1$ , numlib::g\_adic( $a$ ,  $g$ ) returns the  $g$ -adic representation of  $a$  as a list  $[a_0, \dots, a_r]$  such that

$$a = a_0 + a_1 g + a_2 g^2 + \dots + a_r g^r$$

and  $0 \leq a_i < |g|$  für  $i = 0, \dots, r - 1$  and  $0 < a_r < |g|$ .

## Examples

### Example 1

Computing the dyadic representation of 1994:

```
numlib::g_adic(1994, 2)
```

```
[0, 1, 0, 1, 0, 0, 1, 1, 1, 1, 1]
```

## Example 2

Computing the hexadecimal representation of 2001:

```
numlib::g_adic(2001, 16)
```

```
[1, 13, 7]
```

## Parameters

### **number**

An nonnegative integer

### **base**

An integer with absolute value is greater than 1

## Return Values

List of nonnegative integers, or the function call with evaluated arguments if one of the arguments is not a number.

## See Also

### **MuPAD Functions**

genpoly | int2text | text2int



# numlib::ichrem

Chinese remainder theorem for integers

## Syntax

```
numlib::ichrem(a, m)
```

## Description

numlib::ichrem(a, m) returns the least nonnegative integer  $x$  such that

$x \equiv a_i \pmod{m_i}$  for  $i = 1, \dots, \text{nops}(m)$  if such a number exists; otherwise numlib::ichrem(a, m) returns FAIL.

The entries in  $m$  need not be pairwise coprime.

numlib::ichrem(a, m) returns an error if  $a$  is not a list of integers or  $m$  is not a list of natural numbers or  $a$  and  $m$  are not lists of the same length.

## Examples

### Example 1

Here the moduli are pairwise coprime. In this case, a solution always exists:

```
numlib::ichrem([2,3,2],[3,5,7])
```

23

### Example 2

Here the moduli are not pairwise coprime, and a solution does not exist:

```
numlib::ichrem([5,6,8],[20,21,22])
```

FAIL

### Example 3

Also here the moduli are not pairwise coprime, but a solution nevertheless exists:

```
numlib::ichrem([5,6,7],[20,21,22])
```

4605

## Parameters

**a**

A list of integers

**m**

A list of natural numbers of the same length as **a**

## Return Values

Either a nonnegative integer or FAIL.

## See Also

### MuPAD Functions

numlib::lincongruence

# numlib::igcdmult

Extended Euclidean algorithm for integers

## Syntax

```
numlib::igcdmult(par1, par2, ...)
```

## Description

numlib::igcdmult is an extension of the kernel function igcdex.

numlib::igcdmult returns an error if the arguments evaluate to numbers which are not all of the correct type.

For integers  $a_1, a_2, \dots, a_n$ , numlib::igcdmult( $a_1, a_2, \dots, a_n$ ) returns a list  $[d, v_1, \dots, v_n]$  of integers such that  $d$  is the nonnegative greatest common divisor of  $a_1, a_2, \dots, a_n$  and  $d = a_1 v_1 + a_2 v_2 + \dots + a_n v_n$ .

For integers  $a_1, a_2, \dots, a_n$ , numlib::igcdmult( $a_1, a_2, \dots, a_n$ ) returns a list  $[d, v_1, \dots, v_n]$  of integers such that  $d$  is the nonnegative greatest common divisor of  $a_1, a_2, \dots, a_n$  and  $d = a_1 v_1 + a_2 v_2 + \dots + a_n v_n$ .

## Examples

### Example 1

Computing the greatest non-negative common divisor  $d$  of 455, 385, 165, 273 and integers  $v_1, v_2, v_3, v_4$  such that  $d = 455 v_1 + 385 v_2 + 165 v_3 + 273 v_4$ :

```
numlib::igcdmult(455,385,165,273)
```

```
[1, -7630, 9156, -327, 2]
```

## Parameters

**par1**

Integer

**par2, ...**

Integers

## Return Values

List of integers, or the function call with evaluated arguments if some argument is not a number.

## See Also

**MuPAD Functions**

igcd | igcdex

# numlib::invphi

Inverse of the Euler phi function

## Syntax

```
numlib::invphi(n)
```

## Description

numlib::invphi(n) computes all positive integers  $i$  with  $\varphi(i) = n$ .

## Examples

### Example 1

We compute all numbers  $i$  with  $\varphi(i) = 500$ :

```
s := numlib::invphi(500)
```

```
[625, 753, 1004, 1250, 1506]
```

Test for correctness:

```
map(s, numlib::phi)
```

```
[500, 500, 500, 500, 500]
```

## Parameters

**n**

A positive integer

## **Return Values**

List of positive integer numbers.

## **See Also**

### **MuPAD Functions**

`numlib::phi`

# numlib::ispower

Test for perfect powers

## Syntax

```
numlib::ispower(n)
```

## Description

`numlib::ispower(n)` tests whether  $n$  is of the form  $a^k$  for some integers  $a, k$  with  $a, k \geq 2$ .

`numlib::ispower` returns `FALSE` if  $n$  is not a perfect power.

Among several pairs  $(a, k)$  for which  $n = a^k$ , that one with minimal  $a$  is returned.

## Examples

### Example 1

This number is a perfect power:

```
numlib::ispower(1977326743)
```

```
7, 11
```

This number is not a perfect power:

```
numlib::ispower(1977326744)
```

```
FALSE
```

## Parameters

**n**

An integer

## Return Values

`numlib::ispower` returns a sequence of two positive integers greater than 1, or `FALSE` if `n` is not a perfect power.

## See Also

### **MuPAD Functions**

`_power` | `ifactor` | `isqrt`



# numlib::isquadres

Test for quadratic residues

## Syntax

```
numlib::isquadres(a, m)
```

## Description

If the integer number  $a$  is a quadratic residue modulo the natural number  $m$ , `numlib::isquadres(a,m)` returns TRUE, and if  $a$  is a quadratic non-residue modulo  $m$ , `numlib::isquadres(a,m)` returns FALSE.

If  $a$  and  $m$  are not coprime `numlib::isquadres(a,m)` returns an error.

`numlib::isquadres` returns an error if the arguments evaluate to numbers which are not both of the correct type.

`numlib::isquadres` returns the function call with its arguments evaluated if the arguments do not evaluate to numbers.

## Examples

### Example 1

132132 is a quadratic residue modulo 3231227:

```
numlib::isquadres(132132, 3231227)
```

TRUE

## Example 2

222222 is a quadratic non-residue modulo 324899:

```
numlib::isquadres(222222,324899)
```

FALSE

## Example 3

37 is a quadratic residue modulo 48884:

```
numlib::isquadres(37,48884)
```

TRUE

## Parameters

**a**

An integer

**m**

A natural number coprime to a

## Return Values

numlib::isquadres returns TRUE, FALSE, or the function call with its arguments evaluated.

## See Also

### MuPAD Functions

numlib::jacobi | numlib::legendre | numlib::msqrts

## numlib::issqr

Test for perfect squares

### Syntax

```
numlib::issqr(a)
```

### Description

numlib::issqr(a) returns TRUE if a is the square of an integer, and FALSE otherwise.

### Examples

#### Example 1

361 is the square of 19:

```
numlib::issqr(361)
```

TRUE

#### Example 2

362 is not a square:

```
numlib::issqr(362)
```

FALSE

#### Example 3

Negative integers are not squares:

```
numlib::issqr(-361)
```

```
FALSE
```

## Parameters

**a**

An integer

## Return Values

numlib::issqr returns TRUE, FALSE, or the unevaluated call.

## See Also

### MuPAD Functions

isqrt | numlib::ispower | sqrt

# numlib::jacobi

Jacobi symbol

## Syntax

```
numlib::jacobi(a, m)
```

## Description

`numlib::jacobi(a,m)` returns the Jacobi symbol  $(a \mid m)$ .

`numlib::jacobi` returns an error if one of its arguments evaluates to a number of wrong type.

## Examples

### Example 1

Computing the Jacobi symbol  $(222222 \mid 304679)$ :

```
numlib::jacobi(222222, 304679)
```

```
-1
```

### Example 2

Computing the Jacobi-Symbol  $(222222 \mid 324889)$ :

```
numlib::jacobi(222222, 324899)
```

```
1
```

## Example 3

Computing the Jacobi symbol (222222 | 333333):

```
numlib::jacobi(222222, 333333)
```

```
0
```

## Parameters

**a**

An integer

**m**

An odd positive integer

## Return Values

numlib::jacobi(a,m) returns 0, 1, or -1, or the function call with evaluated arguments if one of the arguments is not a number.

## Algorithms

numlib::jacobi doesn't use ifactor.

If  $a$  is an integer and  $m$  is an odd integer not coprime to  $a$  then by definition the Jacobi Symbol  $(a | m)$  is zero.

## See Also

### MuPAD Functions

numlib::isquadres | numlib::legendre

## numlib::Lambda

Von Mangoldt's function

### Syntax

```
numlib::Lambda(m)
```

### Description

`numlib::Lambda(m)` returns the value of von Mangoldt's function at  $m$ .

It is an error if  $m$  is a number but not a natural number.

If  $m$  is not a number, `numlib::Lambda` returns the unevaluated function call.

### Examples

#### Example 1

`numlib::Lambda` takes on non-zero values only for prime powers:

```
numlib::Lambda(49)
```

```
ln(7)
```

```
numlib::Lambda(48)
```

```
0
```

#### Example 2

`numlib::Lambda` returns the function call if its argument is not a number:



```
numlib::Lambda(3+n^4)
```

```
numlib::Lambda( $n^4 + 3$ )
```

## Parameters

$m$

Arithmetical expression

## Return Values

numlib::Lambda returns an arithmetical expression

## Algorithms

The function value of Lambda at  $m$  is defined to be  $\log p$  if  $m = p^n$  for some prime number  $p$  and some positive integer  $n$ , and to be zero for positive integers that are not prime powers.

## See Also

**MuPAD Functions**

numlib::ispower

## numlib::lambda

Carmichael function

### Syntax

```
numlib::lambda(n)
```

### Description

`numlib::lambda(n)` returns the value of the Carmichael function at  $n$ .

If  $m$  is a natural number then `numlib::lambda(m)` returns the value of the Carmichael function in  $m$ , i. e., the maximal order of an element in the group of units modulo  $m$ .

`numlib::lambda` returns an error if the argument evaluates to a number of wrong type. `numlib::lambda` returns the function call with its argument evaluated if  $m$  is not a number.

### Examples

#### Example 1

We compute the value of the Carmichael function  $\lambda$  in 97:

```
numlib::lambda(97)
```

96

#### Example 2

We compute the value of the Carmichael function  $\lambda$  in 96:

```
numlib::lambda(96)
```

8

## Parameters

**n**

A natural number

## Return Values

`numlib::lambda(n)` returns a natural number, or the function call with its argument evaluated.

## Algorithms

Internally, `ifactor` is used for factoring `n`.

## See Also

**MuPAD Functions**`numlib::order` | `numlib::phi`

## numlib::legendre

Legendre symbol

### Syntax

```
numlib::legendre(a, p)
```

### Description

numlib::legendre(a, p) returns the Legendre symbol  $(a \mid p)$ .

numlib::legendre returns an error if one of its arguments evaluates to a number of wrong type.

numlib::legendre returns the function call with evaluated arguments if at least one of its arguments does not evaluate to a number.

### Examples

#### Example 1

Computing the Legendre symbol  $(132132 \mid 3231277)$ :

```
numlib::legendre(132132,3231277)
```

1

#### Example 2

Computing the Legendre symbol  $(132131 \mid 3231277)$ :

```
numlib::legendre(132131,3231277)
```

-1

### Example 3

Computing the Legendre symbol  $(-303 \mid 101)$ :

```
numlib::legendre(-303,101)
```

0

## Parameters

**a**

An integer

**p**

An odd prime

## Return Values

`numlib::legendre(a,p)` returns -1, 0, 1, or the function call with evaluated arguments.

## Algorithms

If  $p$  is an odd prime and if  $a$  is an integer divisible by  $p$  then by definition the Legendre symbol  $(a \mid p)$  is zero.

## See Also

### MuPAD Functions

numlib::isquadres | numlib::jacobi

# numlib::lincongruence

Linear congruence

## Syntax

```
numlib::lincongruence(a, b, m)
```

## Description

`numlib::lincongruence(a,b,m)` returns an error if one of the arguments evaluates to a number of wrong type.

For integers  $a$  and  $b$  and a non-zero integer  $m$  `numlib::lincongruence(a,b,m)` returns the sorted list of all solutions  $x \in \{0, 1, \dots, m - 1\}$  of the linear congruence  $ax \equiv b \pmod{m}$  if this congruence is solvable. Otherwise FAIL is returned.

For integers  $a$  and  $b$  and a non-zero integer  $m$  `numlib::lincongruence(a,b,m)` returns the sorted list of all solutions  $x \in \{0, 1, \dots, m - 1\}$  of the linear congruence  $ax \equiv b \pmod{m}$  if this congruence is solvable. Otherwise FAIL is returned.

## Examples

### Example 1

A linear congruence possessing one solution:

```
numlib::lincongruence(7,19,23)
```

[6]

## Example 2

A linear congruence possessing several solutions:

```
numlib::lincongruence(77,209,253)
```

```
[6, 29, 52, 75, 98, 121, 144, 167, 190, 213, 236]
```

## Example 3

A linear congruence possessing no solutions:

```
numlib::lincongruence(77,208,253)
```

```
FAIL
```

## Parameters

**a**

An integer

**b**

An integer

**m**

A non-zero integer

## Return Values

`numlib::lincongruence(a,b,m)` returns a list of nonnegative integers if the linear congruence is solvable.

`numlib::lincongruence(a,b,m)` returns `FAIL` if the linear congruence is not solvable.



numlib::lincongruence(a,b,m) returns the function call with its arguments evaluated if one of the arguments is a symbolic expression.

## See Also

### MuPAD Functions

numlib::ichrem | numlib::mroots | numlib::msqrts

## numlib::mersenne

Mersenne primes

### Syntax

```
numlib::mersenne(n)
```

```
numlib::mersenne()
```

### Description

`numlib::mersenne()` returns the list of known Mersenne primes  $p$ . For these numbers, the Mersenne number  $2^p - 1$  is prime.

`numlib::mersenne(n)` returns the  $n$ th currently known Mersenne prime. The numbers of the Mersenne primes after the 40th prime can change in the future. More Mersenne primes might be found.

### Examples

#### Example 1

The following primes  $p$  are known to have the property that the Mersenne number  $2^p - 1$  is prime:

```
numlib::mersenne()
```

```
[2, 3, 5, 7, 13, 17, 19, 31, 61, 89, 107, 127, 521, 607, 1279, 2203, 2281, 3217, 4253,  
4423, 9689, 9941, 11213, 19937, 21701, 23209, 44497, 86243, 110503, 132049, 216091,  
756839, 859433, 1257787, 1398269, 2976221, 3021377, 6972593, 13466917, 20996011,  
24036583, 25964951, 30402457, 32582657, 37156667, 42643801, 43112609, 57885161,  
74207281, 77232917]
```

## Example 2

Display the 10th Mersenne prime:

```
numlib::mersenne(10)
```

89

## Return Values

Natural number or a list of natural numbers.

## References

See <http://www.mersenne.org/>

## numlib::moebius

Möbius function

### Syntax

```
numlib::moebius(n)
```

### Description

`numlib::moebius(n)` returns the value of the Möbius function at  $n$ .

`numlib::moebius` returns an error if the argument evaluates to a number of wrong type.

If  $n$  is a natural number `numlib::moebius(n)` returns the value of the Möbius function in  $n$ .

If  $n$  is not a number, `numlib::moebius(n)` returns the function call with its argument evaluated.

### Examples

#### Example 1

Computing the value of the Möbius function  $\mu$  at 99937:

```
numlib::moebius(99937)
```

```
0
```

#### Example 2

`numlib::moebius` works for arbitrarily large integers:

```
numlib::moebius(453973694165307953197296969697410619233826)
```

```
-1
```

## Parameters

**n**

A natural number

## Return Values

`numlib::moebius(n)` returns a nonnegative integer.

## Algorithms

Internally, `ifactor` is used for factoring `n`.

## See Also

### MuPAD Functions

`numlib::lambda` | `numlib::phi`

## numlib::mroots

Modular roots of polynomials

### Syntax

numlib::mroots(P, m)

### Description

numlib::mroots(P, m) returns an error if P is not a polynomial over the integers or m is not a natural number.

For a univariate polynomial P over the integers and for a natural number m the function call numlib::mroots(P, m) returns the sorted list of all integers  $x \in \{0, 1, \dots, m - 1\}$  such that  $P(x) \equiv 0 \pmod{m}$ .

For a multivariate polynomial P, numlib::mroots(P, m) returns a lexicographically sorted list of all lists  $[x_1, \dots, x_n]$  of integers between 0 and  $m - 1$  such that

$$P(x_1, \dots, x_n) \equiv 0 \pmod{m}.$$

For a univariate polynomial P over the integers and for a natural number m the function call numlib::mroots(P, m) returns the sorted list of all integers  $x \in \{0, 1, \dots, m - 1\}$  such that  $P(x) \equiv 0 \pmod{m}$ .

For a multivariate polynomial P, numlib::mroots(P, m) returns a lexicographically sorted list of all lists  $[x_1, \dots, x_n]$  of integers between 0 and  $m - 1$  such that

$$P(x_1, \dots, x_n) \equiv 0 \pmod{m}.$$

### Examples

#### Example 1

Defining a polynomial

```
P := poly(3*T^7 + 2*T^2 + T - 17, [T])
```

```
poly(3 T^7 + 2 T^2 + T - 17, [T])
```

and computing its roots modulo 1751:

```
numlib::mroots(P, 1751)
```

```
[221, 260, 612, 736, 1127, 1496]
```

The polynomial P doesn't have roots modulo 1994:

```
numlib::mroots(P, 1994)
```

□

## Example 2

We use numlib::mroots to find all points on a particular elliptic curve modulo 13:

```
numlib::mroots(poly(y^2 - x^3 - x - 2, [x, y]), 13)
```

```
[[1, 2], [1, 11], [2, 5], [2, 8], [6, 4], [6, 9], [7, 1], [7, 12], [9, 5], [9, 8], [12, 0]]
```

## Parameters

**P**

A polynomial over the integers

**m**

A natural number

## Return Values

If  $P$  is univariate, `numlib::mroots` returns a list of nonnegative integers. If  $P$  has more than one variable, `numlib::mroots` returns a list of lists of nonnegative integers.

## Algorithms

`numlib::mroots` uses `factor`.

## See Also

### MuPAD Functions

`numlib::lincongruence` | `numlib::msqrts`



# numlib::msqrts

Modular square roots

## Syntax

```
numlib::msqrts(a, m)
```

## Description

`numlib::msqrts(a, m)` returns the list of all integers  $x \in \{0, 1, \dots, m - 1\}$  such that  $x^2 \equiv a \pmod{m}$ .

## Examples

### Example 1

Computing the square roots of 132132 modulo 3231227:

```
numlib::msqrts(132132, 3231227)
```

```
[219207, 3012020]
```

### Example 2

There are no square roots of 222222 modulo 324899:

```
numlib::msqrts(222222, 324899)
```

```
[]
```

### Example 3

48884 is a composite number, so a number can have more than two square roots modulo 48884:

```
numlib::msqrts(37,48884)
```

```
[383, 585, 23857, 24059, 24825, 25027, 48299, 48501]
```

### Parameters

**a**

An integer

**m**

A natural number relatively prime to a

### Return Values

`numlib::msqrts(a,m)` returns a list of nonnegative integers

### Algorithms

`numlib::msqrts` uses D. Shanks' algorithm RESSOL.

### See Also

#### **MuPAD Functions**

`numlib::lincongruence` | `numlib::mroots`

# numlib::numdivisors

Number of divisors of an integer

## Syntax

```
numlib::numdivisors(n)
```

## Description

`numlib::numdivisors(n)` returns the number of positive divisors of  $n$ .

`numlib::numdivisors(0)` returns 0.

`numlib::numdivisors` returns the function call with evaluated argument if the argument is not a number.

`numlib::numdivisors` returns an error if the argument evaluates to a number of wrong type.

`numlib::numdivisors` is the same function as `numlib::tau`.

## Examples

### Example 1

We compute the number of positive divisors of the number 6746328388800 (one of the highly composite numbers studied by S. Ramanujan in 1915):

```
numlib::numdivisors(6746328388800)
```

```
10080
```

## Parameters

**n**

An integer

## Return Values

`numlib::numdivisors(n)` returns a nonnegative integer.

## Algorithms

Internally, `ifactor` is used for factoring `n`.

## See Also

### **MuPAD Functions**

`numlib::divisors` | `numlib::numprimedivisors` | `numlib::primedivisors`

# numlib::numprimedivisors

Number of prime factors of an integer

## Syntax

```
numlib::numprimedivisors(n)
```

## Description

`numlib::numprimedivisors(n)` returns the number of prime factors of the integer `n`, counted without multiplicity.

`numlib::numprimedivisors(0)` returns `0`.

`numlib::numprimedivisors` returns the function call with evaluated argument if the argument is not a number.

`numlib::numprimedivisors` returns an error if the argument evaluates to a number of wrong type.

`numlib::numprimedivisors` and `numlib::omega` are equivalent.

## Examples

### Example 1

Compute the number of primes dividing 6746328388800:

```
numlib::numprimedivisors(6746328388800)
```

## Parameters

**n**

An integer

## Return Values

`numlib::numprimedivisors(n)` returns a nonnegative integer.

## Algorithms

Internally, `ifactor` is used for factoring `n`.

## See Also

### **MuPAD Functions**

`numlib::numdivisors` | `numlib::omega` | `numlib::primedivisors`

# numlib::omega

Number of prime factors of an integer

## Syntax

```
numlib::omega(n)
```

## Description

numlib::omega and numlib::numprimedivisors are equivalent. For details and examples, see numlib::numprimedivisors.

## Parameters

**n**

An integer

## Return Values

numlib::numprimedivisors(n) returns a nonnegative integer.

## See Also

### MuPAD Functions

numlib::numdivisors | numlib::numprimedivisors | numlib::primedivisors

## numlib::Omega

Number of prime divisors (with multiplicity)

### Syntax

```
numlib::Omega(a)
```

### Description

`numlib::Omega(a)` returns, for a given positive integer  $a$ , the finite sum  $\sum_p \alpha(p, a)$ , where  $p$  runs through all primes, and  $\alpha(p, a)$  denotes the highest exponent for which  $p^\alpha$  divides  $a$ .

### Examples

#### Example 1

In contrast to `numlib::numprimedivisors`, the prime factor 2 of 120 is counted thrice:

```
numlib::Omega(120)
```

5

The same happens here:

```
numlib::Omega(8)
```

3



## Parameters

**a**

Positive integer

## Return Values

numlib::Omega returns a positive integer.

## See Also

### **MuPAD Functions**

numlib::numprimedivisors

## numlib::order

Order of a residue class

### Syntax

```
numlib::order(a, m)
```

### Description

`numlib::order(a, m)` returns the order of the residue class modulo  $m$  of  $a$  in the group of units modulo  $m$  if  $a$  and  $m$  are coprime.

`numlib::order(a, m)` returns the function call with its arguments evaluated if  $a$  or  $m$  is not a number.

`numlib::order` returns an error if one of the arguments evaluates to a number of wrong type.

### Examples

#### Example 1

We compute the order of the residue class of 23 in the unit group modulo 2161:

```
numlib::order(23, 2161)
```

```
2160
```

#### Example 2

We compute the order of all elements in the unit group modulo 13:

```
map([$ 1..12], numlib::order, 13)
```

```
[1, 12, 3, 6, 4, 12, 12, 4, 3, 6, 12, 2]
```

### Example 3

The residue class of 7 is not a unit in the ring  $\mathbb{Z}$  modulo 21:

```
numlib::order(7,21)
```

```
FAIL
```

## Parameters

**a**

An integer

**m**

A natural number

## Return Values

`numlib::order(a,m)` returns a natural number if  $a$  is coprime to  $m$ , and FAIL if  $a$  is not coprime to  $m$ .

## Algorithms

`numlib::order` uses `ifactor` and `numlib::phi`.

## See Also

### MuPAD Functions

`numlib::lambda` | `numlib::phi`

## numlib::phi

Euler phi function

### Syntax

```
numlib::phi(n)
```

### Description

`numlib::phi(n)` calculates the Euler  $\varphi$  function of the argument  $n$ , i.e. the number of numbers smaller than  $|n|$  which are relatively prime to  $n$ . Cf. “Example 1” on page 20-70 (Symbolic Math Toolbox).

`numlib::phi` returns an error if the argument is a number but not an integer unequal to zero.

`numlib::phi` returns the function call with evaluated arguments if the argument is not a number. Cf. “Example 2” on page 20-70 (Symbolic Math Toolbox).

### Examples

#### Example 1

`numlib::phi` works on integers unequal zero:

```
numlib::phi(-7), numlib::phi(10)
```

```
6, 4
```

#### Example 2

`numlib::phi` is returned as a function call with evaluated argument:

```
x := a: numlib::phi(x)
```

```
numlib::phi(a)
```

## Parameters

**n**

Integer not equal to zero

## Return Values

numlib::phi returns a positive integer, if the argument evaluates to an integer unequal zero. If the argument cannot be evaluate to a number, the function call with evaluated arguments is returned .

## Overloaded By

n

## See Also

**MuPAD Functions**

numlib::invphi

## numlib::pi

Number of primes up to a given bound

### Syntax

```
numlib::pi(x)
```

### Description

`numlib::pi(x)` returns the number of primes not exceeding  $x$ .

If the argument  $x$  is a real number (an integer, rational, or floating-point number), then the number of primes below  $x$  is returned. If  $x$  is a complex number, `numlib::pi` stops with an error. For every other kind of arithmetical expression  $x$ , an unevaluated call is returned.

`numlib::pi` becomes slightly faster if the internal prime number table is large. `ifactor(PrimeLimit)` displays the limit of the internal prime number table; it can be set by the user via the command line flag `-L`.

Internally, a fast kernel function with constant memory consumption is used for the computation.

### Examples

#### Example 1

There are two primes less or equal 3:

```
numlib::pi(3)
```

2

## Example 2

Also larger inputs can be handled fast:

```
numlib::pi(150000000)
```

```
8444396
```

## Example 3

Floating point arguments are allowed, too.

```
numlib::pi(28.72)
```

```
9
```

## Parameters

**x**

An arithmetical expression (Symbolic Math Toolbox)

## Return Values

Non-negative integer or an unevaluated call to `numlib::pi`

## Algorithms

A Lehmer-type algorithm is used, with no precomputed sieve array and no remember tables. In contrast to the algorithm in “Computing  $\pi$ : The Meissel-Lehmer method”, this means constant memory consumption, at the price of slowness.

## References

- [1] Lagarias, J.C., V.S. Miller, and A.M. Odlyzko. "Computing  $\pi$ : The Meissel-Lehmer method", Math. Comp., Vol. 44, No. 170 (1985), pp. 537-560

## See Also

### **MuPAD Functions**

`isprime` | `ithprime` | `nextprime` | `prevprime`



# numlib::proveprime

Primality proving using elliptic curves

## Syntax

```
numlib::proveprime(n)
```

## Description

`numlib::proveprime(n)` tests whether `n` is a prime. Unlike `isprime`, `numlib::proveprime` always returns a correct answer.

`numlib::proveprime` returns the following values:

- TRUE when it can prove that the number is a prime.
- FALSE when it can prove that the number is not a prime.
- FAIL when it cannot prove that the number is a prime and cannot prove otherwise. In such cases, the input most likely is a prime.
- A primality certificate, which is a list or a sequence of lists containing proof for the primality of the number. Typically, `numlib::proveprime` returns primality certificates for very large numbers.

A primality certificate is a sequence of lists of the form  $[N, D, l_m, a, b, x, y, l_s]$ , where

- $N$  is a pseudoprime
- $D$  is an integer (fundamental discriminant)
- $l_m$  is a list of prime factors
- $a, b, x, y$  are integers modulo  $N$
- $l_s$  is another list of prime factors (subset of the factors in  $l_m$ )

`numlib::checkPrimalityCertificate` checks primality certificates produced by `numlib::proveprime`.

## Examples

### Example 1

Proving that 1159523 is prime can be reduced to proving that 10343 is prime:

```
certificate := numlib::proveprime(1159523)
```

```
[1159523, 7, [2, 2, 2, 2, 7, 10343], 1012280, 1061361, 0, 726669, [10343]]
```

### Example 2

Typically, the primality of the input is reduced to the primality of a smaller integer, the primality of that integer is reduced to the primality of an even smaller integer, and so on.

```
numlib::proveprime(179424673)
```

```
[179424673, 7, [2, 2, 2, 2, 11213771], 116768436, 77845624, 1, 110562161, [11213771]],  
[11213771, 7, [2, 2, 2, 2, 487, 1439], 9255809, 9908463, 2, 1041453, [487, 1439]]
```

Use `numlib::checkPrimalityCertificate` to check the result:

```
numlib::checkPrimalityCertificate(%)
```

```
TRUE
```

## Parameters

**n**

Positive integer.

## Return Values

TRUE, FALSE, FAIL, or a list or sequence of lists.

## References

numlib::proveprime implements the Atkin-Goldwasser-Kilian-Morain algorithm for proving primality. For information about primality proving and this particular algorithm, see:

- Atkin, A. O., and F. Morain. "Elliptic curves and primality proving." *Mathematics of Computation*. Vol. 61, Number 203, 1993.
- Goldwasser, S., and J. Kilian. "Almost all primes can be quickly certified". *Proceedings of the 18th annual ACM symposium on theory of computing*. Berkeley, CA, US, 1986, pp. 316-329.

## See Also

### MuPAD Functions

ifactor | isprime | ithprime | nextprime | prevprime

## numlib::primedivisors

Prime factors of an integer

### Syntax

```
numlib::primedivisors(n)
```

### Description

`numlib::primedivisors(n)` returns a list containing the different prime divisors of the integer  $n$ .

If  $a$  is a non-zero integer then, `numlib::primedivisors(a)` returns the sorted list of the different prime divisors of  $a$ .

`numlib::primedivisors(0)` returns `[0]`.

`numlib::primedivisors` returns the function call with evaluated argument if the argument is not a number.

`numlib::primedivisors` returns an error if the argument evaluates to a number of wrong type.

### Examples

#### Example 1

We compute the list of prime divisors of the number 6746328388800 (one of the highly composite numbers studied by S. Ramanujan in 1915):

```
numlib::primedivisors(6746328388800)
```

```
[2, 3, 5, 7, 11, 13, 17, 19, 23]
```

## Parameters

**n**

An integer

## Return Values

`numlib::primedivisors(n)` returns a list of nonnegative integers.

## Algorithms

Internally, `ifactor` is used for factoring `n`.

## See Also

### **MuPAD Functions**

`ifactor` | `isprime` | `numlib::divisors` | `numlib::numdivisors` |  
`numlib::numprimedivisors` | `numlib::proveprime`

# numlib::primroot

Primitive roots

## Syntax

```
numlib::primroot(m)
```

```
numlib::primroot(a, m)
```

## Description

`numlib::primroot(m)` returns the least positive primitive root modulo  $m$  if there exist primitive roots modulo  $m$ .

`numlib::primroot(a, m)` returns the least primitive root modulo  $m$  not smaller than  $a$  if there exist primitive roots modulo  $m$ .

## Examples

### Example 1

We compute the least positive primitive root modulo the prime number 40487:

```
numlib::primroot(40487)
```

5

### Example 2

We compute the least primitive root modulo  $40487^2 = 1639197169$ :

```
numlib::primroot(1639197169)
```

10

### Example 3

Now we compute least primitive root modulo 40487 which is  $\geq 111111111$ :

```
numlib::primroot(111111111,40487)
```

11111116

### Example 4

There are no primitive roots modulo 324013370:

```
numlib::primroot(324013370)
```

FAIL

## Parameters

**a**

An integer

**m**

A natural number

## Return Values

numlib::primroot returns an integer or FAIL.

## Algorithms

numlib::primroot uses ifactor.

## See Also

### MuPAD Functions

numlib::order



# numlib::reconstructRational

Rational number reconstruction

## Syntax

`numlib::reconstructRational(a,n)`

## Description

`numlib::reconstructRational(a,n)` returns two integers  $p, q$  of absolute value smaller than  $\sqrt{n/2}$  with  $p$  congruent to  $a \cdot q$  modulo  $n$ . It returns FAIL if such  $p, q$  do not exist.

`numlib::reconstructRational(a,n)` returns  $p, q$  by solving  $p \equiv a q \pmod{n}$ .

The solution  $p, q$  satisfies the following conditions:  $p$  is strictly between  $-\sqrt{n/2}$  and  $\sqrt{n/2}$ ,  $q$  is strictly between  $0$  and  $\sqrt{n/2}$ .

If several pairs  $p, q$  satisfy these conditions, then their ratios  $p/q$  are the same. In such case, `numlib::reconstructRational` returns the smallest of these pairs.

## Examples

### Example 1

Solve this linear congruence:  $p \equiv 7 q \pmod{12}$ .

`numlib::reconstructRational(7, 12)`

2, 2

Modulo 98, the same congruence has no small solution. The solution  $p=7, q=1$  is not small enough as 7 is not smaller than  $\sqrt{98/2}$  but just equal.

```
numlib::reconstructRational(7, 98)
```

FAIL

## Example 2

Rational number reconstruction is mostly used as the last step of a modular algorithm. For example, find the greatest common divisors of the following polynomials.

```
f:= poly(x^5 + 22/35*x^3 + 3/8*x^2 + 3/35*x + 9/56, [x]):
g:= poly(x^5 + 2/5*x^4 + 22/35*x^3 + 153/280*x^2 + 3/35*x + 9/56,
[x]):
```

Typically, you can use `gcd` for this task. However, suppose you know that the greatest common divisor has small coefficients with numerator and denominator both smaller than 10. Then you can use a modular algorithm with a smaller modulus than `gcd` would do: to be able to reconstruct these from their residue class modulo  $n$ , it is sufficient that

$\sqrt{\frac{n}{2}} > 10$ , e.g.,  $n=211$ .

```
gcd(poly(f, IntMod(211)), poly(g, IntMod(211)))
```

$\text{poly}(x^2 - 90, [x], \text{IntMod}(211))$

Rational number reconstruction shows that the constant coefficient must be  $3/7$ :

```
numlib::reconstructRational(-90, 211)
```

3, 7

```
gcd(f,g)
```

$\text{poly}(x^2 + \frac{3}{7}, [x])$

## Parameters

**a**

An integer

**n**

A positive integer

## Return Values

Sequence consisting of an integer and a positive integer, or FAIL

## References

- [1] Davenport, J. H. , Y.Siret, and E.Tournier “Computer Algebra: Systems and Algorithms for Algebraic Computation”. Academic Press Inc, 1988, p.142

## See Also

### **MuPAD Functions**

numlib::lincongruence

## numlib::sigma

Sum of divisors of an integer

### Syntax

```
numlib::sigma(n)
```

```
numlib::sigma(n, k)
```

### Description

`numlib::sigma(n)` returns the sum of the positive divisors of  $n$ .

`numlib::sigma(n, k)` returns the sum of the  $k$ -th powers of the positive divisors of  $n$ .

`numlib::sigma(0)` returns 0.

`numlib::sigma` returns the function call with evaluated argument if at least one argument is not a number.

`numlib::sigma` returns an error if one of its arguments evaluates to a number of wrong type.

`numlib::sigma(n, 0)` is the same as `numlib::numdivisors(n)` and `numlib::tau(n)`.

`numlib::sigma(n, 1)` is the same function as `numlib::sumdivisors(n)` and `numlib::sigma(n)`.

### Examples

#### Example 1

The sum of the positive divisors of 120 is 360:

```
numlib::sigma(120)
```

```
360
```

## Example 2

The sum of the fifth powers of the positive divisors of 120 is 25799815800:

```
numlib::sigma(120,5)
```

```
25799815800
```

## Parameters

**n**

An integer

**k**

A nonnegative integer

## Return Values

`numlib::sigma` returns an integer.

## Algorithms

Internally, `ifactor` is used for factoring `n`.

## See Also

### MuPAD Functions

`numlib::divisors` | `numlib::numdivisors`

# numlib::sqrt2cfrac

Continued fraction expansion of square roots

## Syntax

```
numlib::sqrt2cfrac(a)
```

## Description

numlib::sqrt2cfrac(a) returns the continued fraction expansion of the square root of a as a sequence of two lists: the first one contains the non-periodic (integer) part, the second one contains the periodic part of the expansion.

## Examples

### Example 1

The square root of 87 can be written as  $9 + q$ , where  $q$  is a number satisfying

$$q = \frac{1}{3 + \frac{1}{18 + q}}$$

```
numlib::sqrt2cfrac(87)
```

```
[9], [3, 18]
```

### Example 2

Since 81 is a perfect square, there is no periodic part in the continued fraction expansion of its square root:

```
numlib::sqrt2cfrac(81)
```

[9]

## Parameters

**a**

A positive integer

## Return Values

If  $a$  is a perfect square, `numlib::sqrt2cfrac` returns a list with one entry; otherwise `numlib::sqrt2cfrac` returns a sequence of two lists, the first consisting of one integer, the second consisting of one or more integers.

## See Also

**MuPAD Functions**

`numlib::contfrac`



# numlib::sqrtmodp

Square root of a quadratic residue modulo a prime

## Syntax

```
numlib::sqrtmodp(a, p)
```

## Description

`numlib::sqrtmodp(a, p)` computes a solution  $x$  to the congruence  $x^2 \equiv a \pmod{p}$ .

`numlib::sqrtmodp(a, p)` computes an integer  $x$  that satisfies  $x^2 \equiv a \pmod{p}$ .

$a$  must be a quadratic residue modulo  $p$ , and  $p$  must be a prime. This is not checked! Unless this is known to be the case, `numlib::msqrts` must be used. On the other hand, `numlib::sqrtmodp` is faster than `numlib::msqrts`.

## Examples

### Example 1

One square root of 132132 modulo 3231227 is 3012020:

```
numlib::sqrtmodp(132132, 3231227)
```

```
3012020
```

## Parameters

**a**

An integer

**p**

A prime unequal to 2

## Return Values

`numlib::sqrtmodp` returns an integer.

## Algorithms

`numlib::sqrtmodp` uses D. Shanks' algorithm RESSOL.

## See Also

**MuPAD Functions**

`numlib::msqrts`

# numlib::sumdivisors

Sum of divisors of an integer

## Syntax

```
numlib::sumdivisors(n)
```

## Description

`numlib::sumdivisors(n)` returns the sum of the positive divisors of the integer  $n$ .

`numlib::sumdivisors(0)` returns 0.

`numlib::sumdivisors` returns the function call with evaluated argument if the argument is not a number.

`numlib::sumdivisors` returns an error if the argument evaluates to a number of wrong type.

`numlib::sumdivisors(n)` is the same as `numlib::sigma(n, 1)`.

## Examples

### Example 1

The sum of the positive divisors of 120 is 360:

```
numlib::sumdivisors(120)
```

```
360
```

## Example 2

The sum of the positive divisors of - 63 is 104:

```
numlib::sumdivisors(-63)
```

104

## Parameters

**n**

An integer

## Return Values

numlib::sumdivisors(n) returns a nonnegative integer.

## Algorithms

Internally, ifactor is used for factoring n.

## See Also

### MuPAD Functions

numlib::divisors | numlib::numdivisors | numlib::sigma

# numlib::sumOfDigits

Sum of digits of an integer

## Syntax

```
numlib::sumOfDigits(n, <base>)
```

## Description

`numlib::sumOfDigits(n, base)` computes the sum of digits of  $n$  in the given base  $base$ ; if the base is not given, it defaults to 10.

The sum of digits may be larger than the base. For certain purposes (testing divisibility by  $b - 1$ , where  $b$  is the base), it may be useful to apply `numlib::sumOfDigits` over and over to the result. This is not done automatically. See “Example 2” on page 20-95 (Symbolic Math Toolbox).

## Examples

### Example 1

We compute the decimal and the binary sum of digits of 11:

```
numlib::sumOfDigits(11), numlib::sumOfDigits(11, 2)
```

```
2, 3
```

### Example 2

We want to test whether 9 divides a given number, using the school method:

```
n:= 24373463462374324:  
repeat n:= numlib::sumOfDigits(n); print(n) until n < 10 end:  
delete n:
```

67

13

4

This only makes sense for demonstration purposes, as the following command achieves the same but much faster:

```
24373463462374324 mod 9
```

4

## Parameters

**n**

Non-negative integer

**base**

Integer greater than one

## Return Values

Non-negative integer

## See Also

### MuPAD Functions

numlib::g\_adic

## numlib::tau

Number of divisors of an integer

### Syntax

```
numlib::tau(n)
```

### Description

numlib::tau(n) returns the number of positive divisors of n.

numlib::tau(0) returns 0.

numlib::tau returns the function call with evaluated argument if the argument is not a number.

numlib::tau returns an error if the argument evaluates to a number of wrong type.

numlib::tau is the same function as numlib::numdivisors.

### Examples

#### Example 1

We compute the number of positive divisors of the number 6746328388800 (one of the highly composite numbers studied by S. Ramanujan in 1915):

```
numlib::tau(6746328388800)
```

```
10080
```



## Parameters

**n**

An integer

## Return Values

numlib::tau returns a nonnegative integer.

## Algorithms

Internally, ifactor is used for factoring n.

## See Also

### **MuPAD Functions**

numlib::divisors | numlib::numprimedivisors | numlib::primedivisors

## numlib::toAscii

ASCII encoding of a string

### Syntax

```
numlib::toAscii(s)
```

### Description

`numlib::toAscii(s)` returns the list of ASCII codes of the characters in the string `s`.

`numlib::toAscii` returns an error if its argument is not a string.

### Examples

#### Example 1

The ASCII coding of a well-known name:

```
numlib::toAscii("MuPAD - Multi Processing Algebra Data Tool")
```

```
[77, 117, 80, 65, 68, 32, 45, 32, 77, 117, 108, 116, 105, 32, 80, 114, 111, 99, 101, 115,  
115, 105, 110, 103, 32, 65, 108, 103, 101, 98, 114, 97, 32, 68, 97, 116, 97, 32, 84, 111,  
111, 108]
```

and the ASCII coding of an empty string:

```
numlib::toAscii("")
```

```
[]
```

## Parameters

**s**

A string

## Return Values

numlib::toAscii(s) returns a list of nonnegative integers.

## See Also

### **MuPAD Functions**

numlib::fromAscii



# ode - Ordinary Differential Equations

---

## ode::companionSystem

Companion matrix of a linear homogeneous ordinary differential equation

### Syntax

```
ode::companionSystem(Ly, y(x), <R>)
```

### Description

`ode::companionSystem(Ly, y(x))` returns the companion matrix associated to `Ly`. If the optional argument `R` is given, the elements of the matrix are in `R`.

### Examples

#### Example 1

We compute the companion matrix of the following differential equation:

```
Ly := 4*x^2*diff(y(x),x$3)+diff(y(x),x$2)+4*x*diff(y(x),x)-y(x)
```

$$4x \frac{\partial}{\partial x} y(x) - y(x) + 4x^2 \frac{\partial^3}{\partial x^3} y(x) + \frac{\partial^2}{\partial x^2} y(x)$$

```
ode::companionSystem(Ly, y(x))
```

$$\begin{pmatrix} 0 & 1 & 0 \\ 0 & 0 & 1 \\ \frac{1}{4x^2} & -\frac{1}{x} & -\frac{1}{4x^2} \end{pmatrix}$$

## Parameters

**L** $y$

A linear homogeneous ordinary differential equation.

**y**(**x**)

The dependent function of  $L y$ .

**R**

A field of functions or numbers of characteristic zero, default is `Dom::ExpressionField(normal)`.

## Return Values

Object of type `Dom::Matrix`.

## ode::cyclicVector

Transforms a linear differential system to an equivalent linear differential system with a companion matrix.

### Syntax

```
ode::cyclicVector(A, x, <v>)
```

### Description

`ode::cyclicVector(A, x, v)` converts a first order homogeneous differential system  $Y' = AY$  into a corresponding first order homogeneous differential system  $Z' = BZ$ , where  $B$  is a companion matrix, by substituting  $Z = PY$  using the potential cyclic vector  $v$ . If  $v$  is not cyclic then an empty list is returned otherwise a list is returned whose first element is a list corresponding to the last row of  $B$  and second element is the invertible matrix  $P$ .

When the optional argument  $v$  is not given then the vector  $[1, 0, \dots, 0]$  is tested. If it is not cyclic then a suitable one is determined randomly by the procedure.

### Examples

#### Example 1

We compute a differential system equivalent to the following differential system:

```
A := matrix( [ [x^2-1,1,0], [0,x^2+5*x+1/3,1], [0,0,2] ] )
```

$$\begin{pmatrix} x^2 - 1 & 1 & 0 \\ 0 & x^2 + 5x + \frac{1}{3} & 1 \\ 0 & 0 & 2 \end{pmatrix}$$



```
ode::cyclicVector(A, x)
```

$$\left[ \left[ 2x^4 + 6x^3 - \frac{49x^2}{3} - \frac{38x}{3} + \frac{19}{3}, -x^4 - 5x^3 - \frac{10x^2}{3} + x + \frac{20}{3}, 2x^2 + 5x + \frac{4}{3} \right], \right. \\ \left. \begin{pmatrix} 1 & 0 & 0 \\ x^2 - 1 & 1 & 0 \\ 2x - 2x^2 + x^4 + 1 & 5x + 2x^2 - \frac{2}{3} & 1 \end{pmatrix} \right]$$

So  $[1, 0, 0]$  is a cyclic vector;  $[x, 0, 0]$  is also a cyclic vector:

```
l := ode::cyclicVector(A, x, [x,0,0])
```

$$\left[ \left[ \frac{6x^7 + 21x^6 - 34x^5 - 28x^4 + 28x^3 + 10x^2 + 8x + 18}{3x^3}, \right. \right. \\ \left. \left. - \frac{3x^6 + 15x^5 + 10x^4 + 9x^3 + 10x^2 + 8x + 18}{3x^2}, \frac{6x^3 + 15x^2 + 4x + 9}{3x} \right], \right. \\ \left. \begin{pmatrix} x & 0 & 0 \\ -x + x^3 + 1 & x & 0 \\ x + 4x^2 - 2x^3 + x^5 - 2 & -\frac{2x}{3} + 5x^2 + 2x^3 + 2x \end{pmatrix} \right]$$

And we can build easily a linear homogeneous differential equation associated to it (c.f.

```
ode::mkODE):
```

```
-ode::mkODE(l[1].[-1], y, x)
```

$$\frac{(3x^6 + 15x^5 + 10x^4 + 9x^3 + 10x^2 + 8x + 18) \frac{\partial}{\partial x} y(x)}{3x^2}$$
$$- \frac{(6x^3 + 15x^2 + 4x + 9) \frac{\partial^2}{\partial x^2} y(x)}{3x}$$
$$- \frac{y(x) (6x^7 + 21x^6 - 34x^5 - 28x^4 + 28x^3 + 10x^2 + 8x + 18)}{3x^3} + \frac{\partial^3}{\partial x^3} y(x)$$

## Parameters

**A**

A square matrix of type `Dom::Matrix`.

**x**

The independent variable.

**v**

A list of size the dimension of A, default is `[1, 0, ..., 0]`.

## Return Values

List, possibly empty, of two lists.

## See Also

### MuPAD Functions

`ode::scalarEquation`

# ode::dAlembert

D'Alembert reduction of a linear homogeneous ordinary differential equation

## Syntax

```
ode::dAlembert(Ly, y(x), v)
```

## Description

`ode::dAlembert(Ly, y(x), v)` returns the reduced differential equation of `Ly` using the method of reduction of d'Alembert and the function `v`. If `v` is a solution of `Ly` and `u` is a solution of the reduced differential equation then  $v \in t u$  is another solution of `Ly`.

## Examples

### Example 1

Consider the following differential equation:

```
Ly := 2/x^3*y(x)-2/x^2*diff(y(x),x)+1/x*diff(y(x),x$2)+
diff(y(x),x$3)
```

$$\frac{2 y(x)}{x^3} - \frac{2 \frac{\partial}{\partial x} y(x)}{x^2} + \frac{\frac{\partial^2}{\partial x^2} y(x)}{x} + \frac{\partial^3}{\partial x^3} y(x)$$

We easily check that `x` is a particular solution of `Ly`:

```
ode::evalOde(Ly, y(x)=x)
```

0

Then we reduce the equation Ly using this special solution:

`R := ode::dAlembert(Ly, y(x), x)`

$$\frac{4 \frac{\partial}{\partial x} y(x)}{x} + \frac{\partial^2}{\partial x^2} y(x)$$

The solutions of the equation R are not too hard to find:

`ode::eval0de(R, y(x)=1), ode::eval0de(R, y(x)=1/x^3)`

0, 0

So a basis of solutions of Ly is therefore  $\left\{x, x \int 1 dx = x^2, x \int \frac{1}{x^3} dx = -\frac{1}{2x}\right\}$  which can be checked directly:

`ode::solve(Ly, y(x))`

$$\left\{ \frac{C3}{x} - \frac{x(C2 + 2 C1 x)}{6} \right\}$$

## Parameters

**Ly**

A homogeneous linear differential equation.

**y(x)**

The dependent function of Ly.

**v**

An expression.

## Return Values

Expression.

## ode::evalOde

Applies an expression at a linear ordinary differential equation

### Syntax

```
ode::evalOde(Ly, y(x))
```

### Description

`ode::evalOde(Ly, y(x) = v)` evaluates `Ly` replacing `y(x)` by `v` and simplifying the result. This can be useful to check a solution candidate, for example.

### Examples

#### Example 1

We evaluate the following differential equation for various expressions:

```
Ly := (x^2+1)*diff(y(x),x$2)+x*diff(y(x),x)-4*y(x)
```

$$(x^2 + 1) \frac{\partial^2}{\partial x^2} y(x) + x \frac{\partial}{\partial x} y(x) - 4 y(x)$$

```
ode::evalOde(Ly, y(x) = 2*x^2+1),  
ode::evalOde(Ly, y(x) = exp(x)),  
ode::evalOde(Ly, y(x) = RootOf(Z^3+x*Z+1, Z))
```

$$0, e^x (x^2 + x - 3), -18 Z^2 x^4 - 54 Z^2 x^2 + 243 Z^2 x - 60 Z x^6 - 4 Z x^4 - 756 Z x^3 + 54 Z x \\ - 2916 Z - 12 x^5 - 36 x^3 + 162 x^2$$

## Parameters

**Ly**

A linear ordinary differential equation.

**y(x)**

The dependent function of Ly.

**v**

An expression.

## Return Values

Expression.

## ode::exponentialSolutions

Exponential solutions of a homogeneous linear ordinary differential equation

### Syntax

```
ode::exponentialSolutions(Ly, y(x), <Generic>)
```

### Description

`ode::exponentialSolutions(Ly, y(x))` returns a fundamental set of the exponential solutions of `Ly`, i.e. solutions  $z$  such that  $\frac{z'}{z}$  is a rational function of  $x$ . When the option `Generic` is given, a generic form of them is returned.

---

**Note** `ode::exponentialSolutions` does not return any eventual solution that is exponential over the algebraic closure of  $\mathbb{Q}(x)$  but not over  $\mathbb{Q}(x)$ .

---

### Examples

#### Example 1

We compute the exponential solutions of the following differential equation :

```
Ly:=diff(y(x),x$4)-2*x*diff(y(x),x$3)+(-x+x^2-5)*diff(y(x),x$2)+  
(4*x+2*x^2)*diff(y(x),x)+(2+x-x^3)*y(x)
```

$$\frac{\partial^4}{\partial x^4} y(x) - 2x \frac{\partial^3}{\partial x^3} y(x) - (-x^2 + x + 5) \frac{\partial^2}{\partial x^2} y(x) + (2x^2 + 4x) \frac{\partial}{\partial x} y(x) + y(x) (-x^3 + x + 2)$$



```
ode::exponentialSolutions(Ly, y(x)),
ode::exponentialSolutions(Ly, y(x), Generic)
```

$$\left\{ e^{\frac{x^2}{2}}, x e^{\frac{x^2}{2}} \right\}, C_2 e^{\frac{x^2}{2}} + C_1 x e^{\frac{x^2}{2}}$$

## Example 2

No exponential solution over the algebraic closure of  $\mathbb{Q}(x)$  is returned:

```
ode::exponentialSolutions(diff(y(x),x$2)+y(x), y(x))
```

$\emptyset$

whereas  $\{e^{ix}, e^{-ix}\}$  is a basis of solutions of the above differential equation.

## Parameters

### **Ly**

A homogeneous linear ordinary differential equation with coefficients in the field  $\mathbb{Q}(x)$  of rational functions over the rationals.

### **y(x)**

The dependent function of Ly.

## Return Values

set, possibly empty, of functions or an expression.

## ode::exponents

Exponents of a linear ordinary differential equation

### Syntax

```
ode::exponents(Ly, y(x), p)
```

### Description

`ode::exponents` returns the set of exponents of a homogeneous linear differential equation at a given point.

`ode::exponents(Ly, y(x), p)` returns the set of (local) exponents of  $Ly$  at the place

$p$ . If the place is infinity then one uses `∞` instead. They are defined as roots (in an algebraic closure of  $\mathbb{Q}(x)$ ) of the indicial equation (c.f. `ode::indicialEquation`) of  $Ly$  so the set of exponents may be empty, see “Example 2” on page 21-15 (Symbolic Math Toolbox).

### Examples

#### Example 1

We compute the exponents of the following differential equation at the regular point  $0$  and at the singular points  $-1$  and *infinity*:

```
Ly := diff(y(x),x$2)+4/(x+1)*diff(y(x),x)+2/(x+1)^2*y(x)
```

$$\frac{4 \frac{\partial}{\partial x} y(x)}{x+1} + \frac{2 y(x)}{(x+1)^2} + \frac{\partial^2}{\partial x^2} y(x)$$

```
ode::exponents(Ly, y(x), x)
```

$\{0, 1\}$ `ode::exponents(Ly, y(x), x+1)` $\{-2, -1\}$ `ode::exponents(Ly, y(x), 1/x)` $\{1, 2\}$ 

## Example 2

It may happen that at a place the set of exponents is empty; this corresponds to an irregular singular point:

```
Ly := (2*x+4)*diff(y(x),x)/(2*x+x^2-2)-2*y(x)/(2*x+x^2-2)-
      (4*x+x^2)/(2*x+x^2-2)*diff(y(x),x$2)+diff(y(x),x$3)
```

$$\frac{(2x+4) \frac{\partial}{\partial x} y(x)}{x^2+2x-2} - \frac{(x^2+4x) \frac{\partial^2}{\partial x^2} y(x)}{x^2+2x-2} - \frac{2y(x)}{x^2+2x-2} + \frac{\partial^3}{\partial x^3} y(x)$$

`ode::exponents(Ly, y(x), 1/x)` $\emptyset$ `ode::exponents(Ly, y(x), x^2+2*x-2)` $\{0, 1, 3\}$

## Parameters

**L** $y$

A homogeneous linear differential equation over  $\mathbb{Q}(x)$ .

**y**(**x**)

The dependent function of  $L$  $y$ .

**p**

An irreducible polynomial in  $x$  or  $1/x$ .

## Return Values

set, possibly empty.

## See Also

### MuPAD Functions

`ode::indicialEquation` | `ode::isFuchsian`

# ode::getOrder

Order of an ordinary differential equation

## Syntax

```
ode::getOrder(Ly, y(x))
```

## Description

`ode::getOrder(Ly, y(x))` returns the order of `Ly` for the dependent function `y(x)`, i.e. the highest degree of derivative of `Ly`.

## Examples

### Example 1

We can compute orders for linear and nonlinear ordinary differential equations:

```
ode::getOrder(diff(y(x),x$2)-x*y(x)-airyAi(x), y(x))
```

2

```
ode::getOrder(y(x)*diff(y(x),x$3)^2-exp(y(x)), y(x))
```

3

```
ode::getOrder(y(x)*diff(y(x),x$3)^2-exp(y(x)), z(x))
```

-∞

## **Parameters**

**$L_y$**

An ordinary differential equation.

**$y(x)$**

The dependent function of  $L_y$ .

## **Return Values**

Either  $-\infty$  or a positive integer.

# ode::indicialEquation

Indicial equation of a linear ordinary differential equation

## Syntax

```
ode::indicialEquation(Ly, y(x), p, u)
```

## Description

ode::indicialEquation(Ly, y(x), p, u) returns the indicial equation in the variable u of Ly at the place p. If the place is infinity then one uses  $\frac{1}{x}$  instead. The result is FAIL if the place corresponds to an irregular singular point of Ly.<sup>x</sup>

## Examples

### Example 1

We compute the indicial equations of the following differential equation at the regular point 1 and at the singular points 0 and *infinity*:

```
Ly := 1/x^3*y(x)*(4*x-10)-1/x^2*(4*x^3-10)*diff(y(x),x)-
      9/2/x*diff(y(x),x$2)+diff(y(x),x$3)
```

$$\frac{y(x)(4x-10)}{x^3} - \frac{9 \frac{\partial^2}{\partial x^2} y(x)}{2x} - \frac{(4x^3-10) \frac{\partial}{\partial x} y(x)}{x^2} + \frac{\partial^3}{\partial x^3} y(x)$$

```
ode::indicialEquation(Ly, y(x), x-1, U)
```

$$U^3 - 3U^2 + 2U$$

```
ode::indicialEquation(Ly, y(x), 1/x, U)
```

FAIL

```
ode::indicialEquation(Ly, y(x), x, U)
```

$$2 U^3 - 15 U^2 + 33 U - 20$$

The roots of the indicial equation correspond to the (local) exponents:

```
solve(%, U), ode::exponents(Ly, y(x), x)
```

$$\left\{1, \frac{5}{2}, 4\right\}, \left\{1, \frac{5}{2}, 4\right\}$$

## Parameters

**Ly**

A homogeneous linear differential equation over  $\mathbb{Q}(x)$ .

**y(x)**

The dependent function of Ly.

**p**

An irreducible polynomial in  $x$  or  $1/x$ .

**u**

An element of type DOM\_IDENT.

## Return Values

FAIL or a polynomial expression in u.



## See Also

### MuPAD Functions

`ode::indicialEquation` | `ode::isFuchsian`

## ode::isFuchsian

Tests if a homogeneous linear ordinary differential equation is of Fuchsian type

### Syntax

```
ode::isFuchsian(Ly, y(x), <AllExponents>)
```

### Description

`ode::isFuchsian` returns TRUE if `Ly` is of Fuchsian type, i.e., all the singular points (including the point at infinity) of `Ly` are regular. It returns FALSE if at least one singular point is irregular. When the option `AllExponents` is given, either FALSE is returned or a list on page 7-41 where each element is a table on page 1-2103 containing, at each regular singular point of `Ly` the place, the indicial equation and the exponents.

### Examples

#### Example 1

We test if the following differential equation is Fuchsian:

```
Ly:=x*(1-x)*diff(y(x),x$2)+(1-x)*diff(y(x),x)+10*y(x)
```

$$-x(x-1) \frac{\partial^2}{\partial x^2} y(x) - (x-1) \frac{\partial}{\partial x} y(x) + 10 y(x)$$

```
ode::isFuchsian(Ly, y(x))
```

```
TRUE
```

We can have a look of the indicial equations, exponents at each regular singular point of `Ly`:

```
ode::isFuchsian(Ly, y(x), AllExponents)
```

exponents	{0}	exponents	{0, 1}	exponents	$\{\sqrt{10}, -\sqrt{10}\}$
indicialEq	$X25^{2^2}$	indicialEq	$X25 - X25^{2^2}$	indicialEq	$-X25^{2^2} + 10$
place	$x$	place	$x - 1$	place	$\frac{1}{x}$

## Example 2

In this example, the Airy equation, the only singular point is at infinity and is irregular:

```
ode::isFuchsian(diff(y(x),x$2)-x*y(x), y(x))
```

FALSE

## Parameters

**Ly**

A homogeneous linear ordinary differential equation with coefficients in the field  $\mathbb{Q}(x)$  of rational functions over the rationals.

**y(x)**

The dependent function of Ly.

## Options

**AllExponents**

Return a list of tables of indicial equations and exponents for regular singular points.

## **Return Values**

TRUE, FALSE or a list on page 7-41.

# ode::isLODE

Test for a linear ordinary differential equation

## Syntax

```
ode::isLODE(Ly, y(x), <Homogeneous | HlodeOverRF | Hlode | LodeOverRF | Lode>)
```

## Description

`ode::isLODE(Ly, y(x))` returns TRUE if  $Ly$  is a linear ordinary differential equation in  $y(x)$ , FALSE otherwise. If an optional argument is given then the result is discussed as follows:

- **Homogeneous**: returns TRUE if  $Ly$  is homogeneous, FALSE otherwise.
- **HlodeOverRF**: returns the sequence  $Ly, y, x, n$ , where  $n$  is the order of  $Ly$ , if  $Ly$  is homogeneous with rational functions coefficients, FALSE otherwise.
- **Hlode**: returns the sequence  $Ly, y, x, n$ , where  $n$  is the order of  $Ly$ , if  $Ly$  is homogeneous, FALSE otherwise.
- **LodeOverRF**: returns the sequence  $Ly, y, x, n$ , where  $n$  is the order of  $Ly$ , if  $Ly$  has rational functions coefficients, FALSE otherwise.
- **Lode**: returns the sequence  $Ly, y, x, n$ , where  $n$  is the order of  $Ly$ , if  $Ly$  is a linear ordinary differential equation, FALSE otherwise.

## Examples

### Example 1

We test the following differential equations:

```
ode::isLODE(y(x)^2+x^2*diff(y(x),x)+x, y(x))
```

FALSE

```
ode::isLODE(y(x)+x^2*diff(y(x),x)+x, y(x))
```

TRUE

```
ode::isLODE(y(x)+x^2*diff(y(x),x)+x, y(x), Hlode)
```

FALSE

```
ode::isLODE(  
  y(x)+x^2*diff(y(x),x)+x*diff(y(x),x$2), y(x), HlodeOverRF)
```

$$y(x) + x^2 \frac{\partial}{\partial x} y(x) + x \frac{\partial^2}{\partial x^2} y(x), y, x, 2$$

```
ode::isLODE(  
  x+x^2*diff(y(x),x)+exp(x)*diff(y(x),x$2), y(x), LodeOverRF)
```

FALSE

## Parameters

**Ly**

An expression.

**y(x)**

The dependent function of Ly.

## Return Values

Either TRUE, FALSE or a sequence of type `_exprseq`.

## ode::mkODE

Builds a linear homogeneous ordinary differential equation from a list of coefficient functions

### Syntax

```
ode::mkODE(l, y, x)
```

### Description

`ode::mkODE(l, y, x)` returns a linear homogeneous ordinary differential equation  $Ly$  in  $y(x)$  where the coefficients are the entries of the list  $l$ . The last element of the list  $l$  corresponds to the leading coefficients of  $Ly$ .

### Examples

#### Example 1

We generate the linear ODE for  $y(x)$  with the coefficients  $-1$ ,  $4x$  and  $4x^2$  of  $y(x)$ ,  $y'(x)$  and  $y''(x)$ , respectively:

```
ode::mkODE([-1, 4*x, 4*x^2], y, x)
```

$$4x^2 \frac{\partial^2}{\partial x^2} y(x) - y(x) + 4x \frac{\partial}{\partial x} y(x)$$

### Parameters

$l$

A list of coefficient functions.

**y**

The dependent variable of the resulting differential equation.

**x**

The independent variable of the resulting differential equation.

## **Return Values**

Expression.



# ode::normalize

Normalized form of a linear ordinary differential equation

## Syntax

```
ode::normalize(Ly, y, x, n)
```

## Description

`ode::normalize(Ly, y, x, n)` computes the normalized form of the  $n$ -th order linear ordinary differential equation  $Ly$ , i.e. whose leading coefficient (the coefficient of the highest derivative of  $y(x)$  in  $Ly$ ) is 1.

## Examples

### Example 1

We normalize the following differential equation:

```
Ly:=-diff(y(x),x,x)/x+y(x)/4/x^3-diff(y(x),x)/x^2
```

$$\frac{y(x)}{4x^3} - \frac{\frac{\partial}{\partial x} y(x)}{x^2} - \frac{\frac{\partial^2}{\partial x^2} y(x)}{x}$$

```
ode::normalize(Ly, y, x, 2)
```

$$\frac{\frac{\partial}{\partial x} y(x)}{x} - \frac{y(x)}{4x^2} + \frac{\partial^2}{\partial x^2} y(x)$$

## **Parameters**

**$Ly$**

A homogeneous linear ordinary differential equation.

**$y$**

The dependent variable of  $Ly$ .

**$x$**

The independent variable of  $Ly$ .

**$n$**

The order of  $Ly$ .

## **Return Values**

Expression representing a linear differential equation.

# ode::polynomialSolutions

Polynomial solutions of a homogeneous linear ordinary differential equation

## Syntax

```
ode::polynomialSolutions(Ly, y(x), <Generic>)
```

## Description

ode::polynomialSolutions computes a fundamental set of polynomial solutions of a homogeneous linear ordinary differential equation.

ode::polynomialSolutions returns a fundamental set of the polynomial solutions of Ly, i.e., solutions in the ring  $\mathbb{Q}[x]$ . When the option `Generic` is given, a generic form of them is returned.

## Examples

### Example 1

We compute the polynomial solutions of the following differential equation:

```
Ly:=3*x*diff(y(x),x,x)-x*diff(y(x),x)+9*y(x)
```

$$3x \frac{\partial^2}{\partial x^2} y(x) - x \frac{\partial}{\partial x} y(x) + 9y(x)$$

```
ode::polynomialSolutions(Ly, y(x))
```

$$\{x^9 - 216x^8 + 18144x^7 - 762048x^6 + 17146080x^5 - 205752960x^4 + 1234517760x^3 - 3174474240x^2 + 2380855680x\}$$

`ode::polynomialSolutions(Ly, y(x), Generic)`

$C1 (x^9 - 216 x^8 + 18144 x^7 - 762048 x^6 + 17146080 x^5 - 205752960 x^4 + 1234517760 x^3 - 3174474240 x^2 + 2380855680 x)$

## Parameters

**Ly**

A homogeneous linear ordinary differential equation with coefficients in the field  $\mathbb{Q}(x)$  of rational functions over the rationals.

**y(x)**

The dependent function of Ly.

## Return Values

set, possibly empty, of functions or an expression

## See Also

**MuPAD Functions**

`ode::rationalSolutions`

# ode::rationalSolutions

Rational solutions of a homogeneous linear ordinary differential equation

## Syntax

```
ode::rationalSolutions(Ly, y(x), <Generic>)
```

## Description

ode::rationalSolutions returns a fundamental set of the rational solutions of Ly, i.e., solutions in the field  $\mathbb{Q}(x)$ . When the option `Generic` is given, a generic form of them is returned.

## Examples

### Example 1

We compute the rational solutions of the following differential equation:

```
Ly:=(4*x^5+8*x^3+4*x)*diff(y(x),x,x)+
(36*x^4+32*x^2-4)*diff(y(x),x)+48*x^3*y(x)
```

$$48 x^3 y(x) + (4 x^5 + 8 x^3 + 4 x) \frac{\partial^2}{\partial x^2} y(x) + (36 x^4 + 32 x^2 - 4) \frac{\partial}{\partial x} y(x)$$

```
ode::rationalSolutions(Ly, y(x))
```

$$\left\{ \frac{1}{x^6 + 3 x^4 + 3 x^2 + 1}, \frac{x^4 + 2 x^2}{x^6 + 3 x^4 + 3 x^2 + 1} \right\}$$

```
ode::rationalSolutions(Ly, y(x), Generic)
```

$$\frac{C1}{x^6 + 3x^4 + 3x^2 + 1} + \frac{C2(x^4 + 2x^2)}{x^6 + 3x^4 + 3x^2 + 1}$$

## Parameters

**Ly**

A homogeneous linear ordinary differential equation with coefficients in the field  $\mathbb{Q}(x)$  of rational functions over the rationals.

**y(x)**

The dependent function of Ly.

## Return Values

set, possibly empty, of functions or an expression

## See Also

**MuPAD Functions**

`ode::polynomialSolutions`

# ode::ratSys

Rational solutions of a first order homogeneous linear differential system

## Syntax

```
ode::ratSys(M, x)
```

## Description

`ode::ratSys(M, x)` computes a fundamental set of rational solutions of the first order homogeneous linear differential system  $Y' = MY$ . This method uses a cyclic vector and therefore is not optimal.

## Examples

### Example 1

We compute the rational solutions of the following differential system:

```
A := matrix([ [2*(x+x^2-9)/x/(x-2), 2*(x^2-6)/x/(x-2)],
              [-3*(2*x+x^2-12)/x/(x-2), -(2*x+3*x^2-24)/x/(x-2)] ])
```

$$\begin{pmatrix} \frac{2x^2+2x-18}{x(x-2)} & \frac{2x^2-12}{x(x-2)} \\ -\frac{3x^2+6x-36}{x(x-2)} & -\frac{3x^2+2x-24}{x(x-2)} \end{pmatrix}$$

```
v := ode::ratSys(A, x)
```

$$\left\{ \left( \begin{array}{c} \frac{x+2}{x^3} \\ -\frac{x+4}{x^3} \end{array} \right) \right\}$$

And we can check the result:

```
diff(v[1], x) = normal(A*v[1])
```

$$\left( \begin{array}{c} -\frac{2(x+3)}{x^4} \\ \frac{2(x+6)}{x^4} \end{array} \right) = \left( \begin{array}{c} -\frac{2(x+3)}{x^4} \\ \frac{2(x+6)}{x^4} \end{array} \right)$$

## Parameters

**M**

A square matrix of type `Dom::Matrix` with coefficients in the field  $\mathbb{Q}(x)$  of rational functions over the rationals.

**x**

The independent function.

## Return Values

set, possibly empty, of objects of type `Dom::Matrix`.

## See Also

### MuPAD Functions

`ode::cyclicVector` | `ode::rationalSolutions` | `ode::scalarEquation`



# ode::scalarEquation

Transforms a linear differential system to an equivalent scalar linear differential equation

## Syntax

```
ode::scalarEquation(A, x, y, <Transform>)
```

## Description

`ode::scalarEquation` converts a first order homogeneous linear differential system to an equivalent homogeneous scalar linear differential equation using the method of cyclic vector.

`ode::scalarEquation(A, x, y)` returns a scalar homogeneous linear differential equation in  $y(x)$  equivalent to the first order homogeneous differential system  $Y' = AY$  using the method of the cyclic vector. If the option `Transform` is given then a list is returned whose first element is the corresponding differential equation  $Ly$  and second element is an invertible matrix  $P$  such that  $C = P' P^{-1} + P A P^{-1}$  is the companion matrix associated to  $Ly$ ; hence if  $Z$  is a solution of the differential system  $Y' = AY$  then  $PZ$  is a solution of the system  $Y' = CY$ .

## Examples

### Example 1

We compute a linear differential equation equivalent to the following differential system:

```
A := matrix( [ [x^2-1,1,0], [0,x^2+5*x+1/3,1], [0,0,2] ] )
```

$$\begin{pmatrix} x^2 - 1 & 1 & 0 \\ 0 & x^2 + 5x + \frac{1}{3} & 1 \\ 0 & 0 & 2 \end{pmatrix}$$

`l := ode::scalarEquation(A, x, y, Transform)`

$$\left[ \frac{\partial^3}{\partial x^3} y(x) - \left( 2x^2 + 5x + \frac{4}{3} \right) \frac{\partial^2}{\partial x^2} y(x) + \left( x^4 + 5x^3 + \frac{10x^2}{3} - x - \frac{20}{3} \right) \frac{\partial}{\partial x} y(x) - y(x) \left( 2x^4 + 6x^3 - \frac{49x^2}{3} - \frac{38x}{3} + \frac{19}{3} \right), \begin{pmatrix} 1 & 0 & 0 \\ x^2 - 1 & 1 & 0 \\ 2x - 2x^2 + x^4 + 1 & 5x + 2x^2 - \frac{2}{3} & 1 \end{pmatrix} \right]$$

And we can check that, for  $P=l[2]$ ,  $P'P^{-1} + PA P^{-1}$  is the companion matrix associated to  $l[1]$ :

```
P := l[2]:
bool( diff(P,x)*P^(-1)+P*A*P^(-1) =
ode::companionSystem(l[1], y(x)) )
```

TRUE

## Parameters

**A**

A square matrix of type `Dom::Matrix`.

**x**

The independent variable of the resulting scalar differential equation.

**y**

The dependent variable of the resulting scalar differential equation.

## **Return Values**

Expression or a list.

## **See Also**

### **MuPAD Functions**

ode::cyclicVector

## ode::series

Series solutions of an ordinary differential equation

### Syntax

```
ode::series(Ly, y(x), x | x = x0, <order>)
```

```
ode::series({Ly, <inits>}, y(x), x | x = x0, <order>)
```

### Description

`ode::series(Ly, y(x), x = x0)` computes the first terms of the series expansions of the solutions of  $Ly$  with respect to the variable  $x$  around the point  $x_0$ .

`ode::series` tries to compute either the Taylor series, the Laurent series or the Puiseux series of the solutions of the differential equation  $Ly$  around the point  $x=x_0$ .

Suppose that  $Ly$  is a nonlinear differential equation. If  $x_0$  is an ordinary point of  $Ly$  then a Taylor series is computed otherwise an expression of type "series" is returned. If initial conditions are given at the point  $x_0$  then the answer is expressed in terms of the function  $y(x)$  and its derivatives evaluated at the point  $x_0$ . See "Example 1" on page 21-40 (Symbolic Math Toolbox).

Suppose that  $Ly$  is a linear differential equation. If  $x_0$  is an ordinary point of  $Ly$  then a Taylor series is computed, if  $Ly$  is furthermore homogeneous and  $x_0$  is a regular point then a Puiseux series is computed (containing possible logarithmic terms), otherwise an expression of type "series" is returned. If initial conditions are given at the point  $x_0$  then the answer is either expressed in terms of the function  $y(x)$  and its derivatives evaluated at the point  $x_0$  or it may be expressed in terms of arbitrary constants.

## Examples

### Example 1

Consider the following nonlinear differential equation:

```
Ly := x^2*diff(y(x),x)+y(x)-x
```

$$y(x) - x + x^2 \frac{\partial}{\partial x} y(x)$$

We compute the series solutions at the point 0 which is a singular point:

```
ode::series(Ly, y(x), x=0)
```

$$\text{series}\left(y(x) - x + x^2 \frac{\partial}{\partial x} y(x), y(x), x = 0\right)$$

Then we compute the series solutions at the regular point 1:

```
ode::series(Ly, y(x), x=1)
```

$$\left\{ y(1) - (x-1)(y(1)-1) + \left(\frac{3y(1)}{2} - 1\right)(x-1)^2 - \left(\frac{13y(1)}{6} - \frac{4}{3}\right)(x-1)^3 \right. \\ \left. + \left(\frac{73y(1)}{24} - \frac{11}{6}\right)(x-1)^4 - \left(\frac{167y(1)}{40} - \frac{5}{2}\right)(x-1)^5 + O((x-1)^6) \right\}$$

And we can also put some initial conditions at the point 1:

```
ode::series({y(1)=1, Ly}, y(x), x=1)
```

$$\left\{ 1 + \frac{(x-1)^2}{2} - \frac{5(x-1)^3}{6} + \frac{29(x-1)^4}{24} - \frac{67(x-1)^5}{40} + O((x-1)^6) \right\}$$

## Example 2

Consider the following linear differential equation:

```
Ly := (2*x+x^3)*diff(y(x),x^2)-diff(y(x),x)-6*x*y(x)
```

$$(x^3 + 2x) \frac{\partial^2}{\partial x^2} y(x) - \frac{\partial}{\partial x} y(x) - 6xy(x)$$

We compute the series solutions at the regular point 1:

`ode::series(Ly, y(x), x=1)`

$$\left\{ y(1) + y'(1) (x-1) + (x-1)^2 \left( \frac{y'(1)}{6} + y(1) \right) - \left( \frac{y(1)}{9} - \frac{7 y'(1)}{27} \right) (x-1)^3 \right. \\ \left. + \left( \frac{y(1)}{12} - \frac{y'(1)}{36} \right) (x-1)^4 + \left( \frac{y(1)}{90} - \frac{2 y'(1)}{135} \right) (x-1)^5 + O((x-1)^6) \right\}$$

The series solutions at the regular singular point 0:

`ode::series(Ly, y(x), x=0)`

$$\left\{ 1 + 3 x^2 + \frac{3 x^4}{5} + O(x^6), x^{3/2} + \frac{3 x^{7/2}}{8} - \frac{3 x^{11/2}}{128} + O(x^{15/2}) \right\}$$

An also the series solutions at the regular singular point *infinity*:

`ode::series(Ly, y(x), x=infinity)`

$$\left\{ \frac{1}{x^2} - \frac{1}{x^4} + \frac{11}{9 x^6} + O\left(\frac{1}{x^8}\right), 2880 x^3 + 4320 x - \frac{1080}{x} + O\left(\frac{1}{x^3}\right) \right\}$$

### Example 3

Consider the following linear differential equation:

`Ly := x^2*diff(y(x),x$2)-x*diff(y(x),x)+(1-x)*y(x)`

$$x^2 \frac{\partial^2}{\partial x^2} y(x) - y(x) (x-1) - x \frac{\partial}{\partial x} y(x)$$

We compute the series solutions at the regular singular point 0:

`ode::series(Ly, y(x), x)`

$$\left\{ x \ln(x) + x^2 (\ln(x) - 2) + x^3 \left( \frac{\ln(x)}{4} - \frac{3}{4} \right) + x^4 \left( \frac{\ln(x)}{36} - \frac{11}{108} \right) + x^5 \left( \frac{\ln(x)}{576} - \frac{25}{3456} \right) + x^6 \left( \frac{\ln(x)}{14400} - \frac{137}{432000} \right) + O(x^7), x + x^2 + \frac{x^3}{4} + \frac{x^4}{36} + \frac{x^5}{576} + \frac{x^6}{14400} + O(x^7) \right\}$$

And at the same point we look for solutions satisfying the initial condition  $y(0) = 1$  and  $y'(0) = 0$ :

`ode::series({y(0)=1, Ly}, y(x), x)`

∅

`ode::series({y(0)=0, Ly}, y(x), x)`

$$\left\{ C4 x \ln(x) + C4 x^2 (\ln(x) - 2) + C4 x^3 \left( \frac{\ln(x)}{4} - \frac{3}{4} \right) + C4 x^4 \left( \frac{\ln(x)}{36} - \frac{11}{108} \right) + C4 x^5 \left( \frac{\ln(x)}{576} - \frac{25}{3456} \right) + C4 x^6 \left( \frac{\ln(x)}{14400} - \frac{137}{432000} \right) + O(x^7), C3 x + C3 x^2 + \frac{C3 x^3}{4} + \frac{C3 x^4}{36} + \frac{C3 x^5}{576} + \frac{C3 x^6}{14400} + O(x^7) \right\}$$

## Parameters

**Ly**

An ordinary differential equation.

**y(x)**

The dependent function of Ly.

**x**

The independent variable of Ly.

**x0**

The expansion point: an arithmetical expression (Symbolic Math Toolbox). If not specified, the default expansion point 0 is used .

**inits**

The initial or boundary conditions: a sequence of equations.

**order**

The number of terms to be computed: a nonnegative integer. The default order is given by the environment variable ORDER (default value 6).

## Return Values

Either a list, maybe empty, of objects of type `Series::Puisseux` or an expression of type "series".



# ode::solve

Solving ordinary differential equations

## Syntax

```
ode::solve(o, options)
```

```
solve(o, options)
```

## Description

`ode::solve` computes solutions for ordinary differential equations.

`ode::solve(o)` returns the set of solutions of the ordinary differential equation `o`. You can also call the generic function `solve(o)`.

The solver detects the type of the differential equation and chooses an algorithm according to the detected equation type. If you know the type of the equation, you can use the option `Type = OdeType` to pass the equation type to the solver. Passing the equation type to the solver increases performance.

The solver recognizes the following values of `OdeType`:

- `Abel` - Abel differential equation
- `Bernoulli` - Bernoulli differential equation
- `Chini` - Chini differential equation
- `Clairaut` - Clairaut differential equation
- `ExactFirstOrder` - exact first order ordinary differential equation
- `ExactSecondOrder` - exact second order ordinary differential equation
- `Homogeneous` - homogeneous first order ordinary differential equation
- `Lagrange` - Lagrange differential equation
- `Riccati` - Riccati differential equation

See the Background section for more details on the classes of ordinary differential equations.

If the solver cannot identify the equation with the type you indicated, it issues a warning and returns the special value `FAIL`.

To solve an ordinary differential equation disregarding possible conditions on the parameters of the equation, use `IgnoreSpecialCases` option. This option eliminates receiving a set of special cases as an answer.

To solve an ordinary differential equation in a simplified manner, use the `IgnoreAnalyticConstraints` option. This option can provide simple solutions for the equations for which the direct use of the solver gives complicated results. If you use the `IgnoreAnalyticConstraints` option, always check the answer. This option can lead to wrong or incomplete results. See “Example 3” on page 21-48 (Symbolic Math Toolbox).

The solutions of ordinary differential equations can contain arbitrary constants of integration. The solver generates the constants of integration using the format of an uppercase letter C followed by an automatically generated number, for example C13.

The solver does not always verify the uniqueness and completeness of the returned solution. For example:

- The solver does not validate the Lipschitz-conditions on the ordinary differential equation for the Picard-Lindelöf Theorem.
- For some complex nonlinear systems of differential equations the solver returns constant solutions and does not warn you that other solutions exist.

The solver might ignore assumptions that you set on symbolic parameters and variables or use them only partially. More precisely, `ode::solve` passes assumptions to the functions that it calls internally. While these functions can use the specified assumptions, `ode::solve` itself does not use them in most of its internal algorithms. The same happens if you define an ordinary differential equation using `ode` and solve it using `solve`.

## Examples

### Example 1

To define an ordinary differential equation, use the `ode` command:

```
o := ode(y'(x) = y(x)^2, y(x))
```

$$\text{ode}(y'(x) - y(x)^2, y(x))$$

To solve the equation, enter:

```
ode::solve(o)
```

$$\left\{0, -\frac{1}{C2 + x}\right\}$$

or more efficiently:

```
solve(o)
```

$$\left\{0, -\frac{1}{C6 + x}\right\}$$

Internally, the function `ode::solve` calls the function `solve`.

## Example 2

You can solve an ordinary differential equation with a symbolic parameter and an initial condition:

```
o := ode({y'(x) = a*y(x)^2, y(a) = ln(a)}, y(x)):
solve(o)
```

$$\left\{ \begin{array}{ll} \{0\} & \text{if } a = 1 \\ \left\{ \frac{1}{\ln(a) - a x + a^2} \right\} & \text{if } a \neq 1 \end{array} \right.$$

To reduce the number of returned solutions, use the option `IgnoreSpecialCases`. For example, you can drop the solution for the parameter  $a = 1$ :

```
solve(o, IgnoreSpecialCases)
```

$$\left\{ \frac{1}{\frac{1}{\ln(a)} - a x + a^2} \right\}$$

With the `IgnoreSpecialCases` option, a returned set of solutions can be incomplete.

### Example 3

The solver can return `piecewise` solutions:

```
o:= ode(y'(x) = a/y(x)^2 + b*y(x), y(x)):  
solve(o)
```

$$\left\{ \begin{array}{ll} \{\text{C14}\} & \text{if } a = 0 \wedge b = 0 \\ \left\{ \frac{\sigma_1}{b^{1/3}}, \sigma_3, \sigma_4, \frac{\sigma_1 \left(-\frac{1}{2} + \sigma_5\right)}{b^{1/3}}, \right. & \text{if } a \neq 0 \wedge b \neq 0 \\ \left. \sigma_2, -\frac{\sigma_1 \left(\frac{1}{2} + \sigma_5\right)}{b^{1/3}} \right\} & \\ \emptyset & \text{if } (a = 0 \vee b = 0) \wedge (a = 0 \vee b \neq 0) \wedge (a \neq 0 \vee b = 0) \\ & \wedge (a \neq 0 \vee b \neq 0) \\ \{\sigma_3, \sigma_4, \sigma_2\} & \text{if } ((a = 0 \wedge b \neq 0) \vee (a \neq 0 \wedge b = 0)) \wedge (a = 0 \vee b = 0) \\ & \wedge (a \neq 0 \vee b \neq 0) \end{array} \right.$$

where

$$\sigma_1 = (-a)^{1/3}$$

$$\sigma_2 = -\left(\frac{1}{2} + \sigma_5\right) \sigma_4$$

$$\sigma_3 = \left(-\frac{1}{2} + \sigma_5\right) \sigma_4$$

$$\sigma_4 = \left(-\frac{a - e^{3 b (\text{C15} + x)}}{b}\right)^{1/3}$$

$$\sigma_5 = \frac{\sqrt{3} i}{2}$$

This solution is complete and mathematically correct for all possible values of the parameter  $a$  and variable  $x$ . Also you can try the option `IgnoreAnalyticConstraints` to obtain a particular solution that is correct under a set of common assumptions:

`solve(o, IgnoreAnalyticConstraints)`

$$\left\{ \frac{\sigma_2}{b^{1/3}}, \left(-\frac{1}{2} + \frac{\sqrt{3}i}{2}\right) \sigma_1, \sigma_1, \frac{\sigma_2 \left(-\frac{1}{2} + \frac{\sqrt{3}i}{2}\right)}{b^{1/3}}, -\left(\frac{1}{2} + \frac{\sqrt{3}i}{2}\right) \sigma_1, -\frac{\sigma_2 \left(\frac{1}{2} + \frac{\sqrt{3}i}{2}\right)}{b^{1/3}} \right\}$$

where

$$\sigma_1 = \left( -\frac{a - e^{3 b (C19+x)}}{b} \right)^{1/3}$$

$$\sigma_2 = (-a)^{1/3}$$

The solver accepts several options:

`solve(o, Type = Bernoulli, IgnoreAnalyticConstraints)`

$$\left\{ \left(-\frac{1}{2} + \frac{\sqrt{3}i}{2}\right) \sigma_1, \sigma_1, -\left(\frac{1}{2} + \frac{\sqrt{3}i}{2}\right) \sigma_1 \right\}$$

where

$$\sigma_1 = \left( -\frac{a - C21 b e^{3 b x}}{b} \right)^{1/3}$$

### Example 4

Suppose, you want to solve an ordinary differential equation from the class of Bernoulli equations:

`o:= ode(y'(x) = (- 1/x + 2*I)*y(x) + 1/x*y(x)^2, y(x)):`  
`solve(o)`

$$\left\{ 0, \frac{e^{-\ln(x)+2 x i}}{C22 + 2 \operatorname{Ei}(1, -2 x i) i + \frac{e^{2 x i}}{x}} \right\}$$

The solver recognizes the type of the equation and uses the algorithm for solving Bernoulli equations. To improve performance, you can explicitly pass the type of the equation to the solver:

```
solve(o, Type = Bernoulli)
```

$$\left\{ 0, \frac{x e^{-\ln(x)+2 x i}}{e^{2 x i} + C23 x + 2 x \operatorname{Ei}(1, -2 x i) i} \right\}$$

To solve the Clairaut equation with the initial conditions, enter:

```
o:= ode({(x*y'(x)-y(x))^2 - y'(x)^2 - 1 = 0, y(1) = 1}, y(x)):
solve(o, Type = Clairaut)
```

```
{1}
```

If the solver cannot identify the equation with the type you indicated, it issues a warning and returns the special value FAIL:

```
o:= ode({(x*y'(x)-y(x))^2 - y'(x)^2 - 1 = 0, y(1) = 1}, y(x)):
solve(o, Type = Lagrange)
```

```
Warning: Unable to detect Lagrange ODE. [ode::lagrange]
```

```
FAIL
```

## Example 5

Some ordinary differential equations belong to several classes. For example, some Chini equations are also homogeneous and some Lagrange equations are also Clairaut equations. If an equation belongs to several classes simultaneously, the solver can present its solution in different forms. The form of a solution depends on the class with which an equation is identified. For example, suppose you want to solve the Chini differential equation. You can explicitly pass the type of the equation to the solver:

```
o:= ode(y'(x) = 1/x*y(x)^2 + 1/x*y(x) + x, y(x)):
L:= solve(o, Type = Chini)
```

$$\{x \tan(C25 + x), -x i, x i\}$$

You also can let the solver recognize the type of the equation:

`solve(o)`

$$\left\{ -x i, -x i + \frac{2 e^{2 x i} e^{\ln(x)-2 x i}}{2 C26 e^{2 x i} - i} \right\}$$

The solver does not return the type with which an ordinary differential equation is internally identified. If you want to verify that both solution sets are equivalent, use the `rewrite` function with target `exp` on the first set of solutions:

`rewrite(L, exp)`

$$\left\{ -x i, x i, -\frac{x \left( e^{2 C25 i+2 x i} i - i \right)}{e^{2 C25 i+2 x i} + 1} \right\}$$

### Example 6

MuPAD solves some classes of Riccati ordinary differential equations that involve arbitrary functions. For example, the following equation contains the arbitrary function  $f(x)$ :

$$\text{eq} := \text{diff}(y(x), x) - f(x)*y(x)^2 + a^2*x^(2*n)*f(x) - a*n*x^(n - 1)$$

$$\frac{\partial}{\partial x} y(x) - f(x) y(x)^2 + a^2 x^{2n} f(x) - a n x^{n-1}$$

For this equation the solver returns:

`solve(ode(eq,y(x)))`



$$\left\{ a x^n, a x^n + \frac{e^{\int 2 a x^n f(x) dx}}{C27 - \int e^{\int 2 a x^n f(x) dx} f(x) dx} \right\}$$

You also can solve an equation with more than one arbitrary function. For example, the following equations contain  $f(x)$  and  $g(x)$ :

```
eq:= diff(y(x), x) - g(x)*f(x)*y(x) - g(x) - diff(f(x), x)*y(x)^2
```

$$- y(x)^2 \frac{\partial}{\partial x} f(x) + \frac{\partial}{\partial x} y(x) - f(x) g(x) y(x) - g(x)$$

The returned solution is:

```
solve(ode(eq,y(x)))
```

$$\left\{ \frac{e^{\int f(x) g(x) dx - 2 \ln(f(x))}}{C28 - \int e^{\int f(x) g(x) dx - 2 \ln(f(x))} \frac{\partial}{\partial x} f(x) dx} - \frac{1}{f(x)}, -\frac{1}{f(x)} \right\}$$

## Example 7

Suppose, you want to solve the following second-order ordinary differential equation:

```
eq := x^2*(x^2 + 1)*diff(y(x),x,x) +
      x*(2*x^2 + 1)*diff(y(x),x) -
      (nu*(nu + 1)*x^2 + n^2)*y(x)
```

$$x (2 x^2 + 1) \frac{\partial}{\partial x} y(x) - y(x) (n^2 + nu (nu + 1) x^2) + x^2 (x^2 + 1) \frac{\partial^2}{\partial x^2} y(x)$$

The solver returns the result in terms of the hypergeometric function  ${}_1F_2$  (see hypergeom):

```
solve(ode(eq,y(x)))
```

$$\left\{ \frac{C29 {}_2F_1\left(\frac{nu}{2} - \frac{n}{2} + \frac{1}{2}, \frac{n}{2} + \frac{nu}{2} + \frac{1}{2}; nu + \frac{3}{2}; \sigma_1\right)}{x^{nu+1}} + C30 x^{nu} {}_2F_1\left(-\frac{n}{2} - \frac{nu}{2}, \frac{n}{2} - \frac{nu}{2}; \frac{1}{2} - nu; \sigma_1\right) \right\}$$

where

$$\sigma_1 = -\frac{1}{x}$$

### Example 8

The solver can handle some third- and higher-order ordinary differential equations. For example, solve the following third-order linear differential equations:

```
eq := ode(sin(x)*y'''(x) + cos(x)*y(x), y(x)):
solve(eq)
```

$$\{C31 \sin(x)\}$$

```
eq := ode(6*y(x) + x^3*y'''(x), y(x)):
solve(eq)
```

$$\left\{ C35 \sigma_1 - \frac{\sigma_1 \left( \frac{C34}{22} + \frac{3\sqrt{2} C34 i}{44} \right)}{x^{3+\sqrt{2}i}} + \frac{\sqrt{2} C36 \sigma_2 \sigma_1 i}{4} + \frac{\sqrt{2} \sigma_2 \sigma_1 \left( \frac{3 C34}{11} + \frac{\sqrt{2} C34 i}{11} \right) i}{4 x^{3-\sqrt{2}i}} \right\}$$

where

$$\sigma_1 = x^{2+\sqrt{2}i}$$

$$\sigma_2 = \frac{1}{x^{2-\sqrt{2}i}}$$

## Example 9

The solver also can handle some nonlinear first-order ordinary differential equations. For example, solve the following first-order linear differential equations:

```
eq := ode(y(x)*diff(y(x), x) - y(x) - x^3 - 4*x^4 - 4*x^7, y(x)):
solve(eq)
```

$$\left\{ x^4 + x + \frac{1}{4} \right\}$$

```
eq := ode(exp(x/2)/4 - 2*exp(x) - y(x) + x*exp(x/2) + y(x)*y'(x), y(x)):
solve(eq)
```

$$\left\{ x - 2 e^{\frac{x}{2}} + \frac{1}{4} \right\}$$

## Parameters

o

An ordinary differential equation, an object of the type ode.

## Options

### Type

Option, specified as Type = OdeType

Indicates the type of the ordinary differential equation and accepts the following arguments: Abel, Bernoulli, Chini, Clairaut, ExactFirstOrder, ExactSecondOrder, Homogeneous, Lagrange, Riccati.

### MaxDegree

Option, specified as MaxDegree = n

Pass the option to the generic solver, which is called internally for all intermediate equations. See the list of options for the `solve` function for further information.

### **IgnoreSpecialCases**

Pass the option to the generic solver, which is called internally for all intermediate equations, and to the integrator `int`, which is called for computing all intermediate integrals. See the list of options for the `solve` function for further information.

### **IgnoreAnalyticConstraints**

Pass the option to the generic solver, which is called internally for all intermediate equations, and to the integrator `int`, which is called for computing all intermediate integrals. See the list of options for the `solve` function for further information.

## **Return Values**

Set of solutions of the ordinary differential equation or the special value `FAIL`. For additional information on the return values, see the `solve` help page.

## **References**

For more information on the particular classes of ordinary differential equations see:

- E. Kamke: Differentialgleichungen: Lösungsmethoden und Lösungen. B.G. Teubner, Stuttgart, 1997
- G.M. Murphy: Ordinary differential equations and their solutions. Van Nostrand, Princeton, 1960
- Andrei D. Polyanin and Valentin F. Zaitsev: Handbook of exact solutions for ordinary differential equations, second ed., Chapman & Hall/CRC, Boca Raton, FL, 2003
- D. Zwillinger: Handbook of differential equations. San Diego: Academic Press, 1992

## See Also

### Topics

“Solve Ordinary Differential Equations and Systems” (Symbolic Math Toolbox)

## ode::symmetricPower

Symmetric power of a homogeneous linear ordinary differential equation

### Syntax

```
ode::symmetricPower(Ly, y(x), m)
```

### Description

`ode::symmetricPower(Ly, y(x), m)` computes the  $m$ -th symmetric power of  $Ly$ . This is the lowest order linear ordinary differential equation whose solution space consists exactly of all possible  $m$ -th powerproducts of solutions of  $Ly$ .

### Examples

#### Example 1

We compute the second symmetric power of the following differential equation:

```
Ly:=x^2*diff(y(x),x$2) - (36*x^6*exp(4*x^3)+9*x^6+2)*y(x)
```

$$x^2 \frac{\partial^2}{\partial x^2} y(x) - y(x) \left( 36 x^6 e^{4x^3} + 9 x^6 + 2 \right)$$

```
ode::symmetricPower(Ly, y(x), 2)
```

$$\begin{aligned} & \frac{\partial^3}{\partial x^3} y(x) - \left( 144 x^4 e^{4x^3} + \frac{8}{x^2} + 36 x^4 \right) \frac{\partial}{\partial x} y(x) \\ & - y(x) \left( 288 x^3 e^{4x^3} + 864 x^6 e^{4x^3} - \frac{8}{x^3} + 72 x^3 \right) \end{aligned}$$

## Parameters

**$L_y$**

A homogeneous linear ordinary differential equation.

**$y(x)$**

The dependent function of  $L_y$ .

**$m$**

A positive integer.

## Return Values

Linear differential equation

## ode::unimodular

Unimodular transformation of a linear ordinary differential equation

### Syntax

```
ode::unimodular(Ly, y(x), <Transform>)
```

### Description

`ode::unimodular(Ly, y(x))` tests if the linear homogeneous differential equation `Ly` has a unimodular Galois group (i.e. the wronskian lies in the base field  $\mathbb{Q}(x)$ ), if not transforms `Ly` into a unimodular one (by changing the second highest coefficient to zero) and returns a table with index `equation` and `factorOfTransformation` containing respectively the transformed differential equation and the factor of transformation `Wn` such that a solution of the transformed equation multiplied by `Wn` is a solution of `Ly`.

If the option `Transform` is given then `Ly` is transformed unconditionally even if `Ly` has yet a unimodular Galois group.

### Examples

#### Example 1

We test if the following differential equation has a unimodular Galois group:

```
Ly := y(x)*6+x*diff(y(x),x)*(-2)+diff(y(x),x$2)*(-x^2+1)
```

$$-(x^2 - 1) \frac{\partial^2}{\partial x^2} y(x) - 2x \frac{\partial}{\partial x} y(x) + 6 y(x)$$

```
ode::unimodular(Ly, y(x))
```



equation	$6 y(x) - 2 x \frac{\partial}{\partial x} y(x) - (x^2 - 1) \frac{\partial^2}{\partial x^2} y(x)$
factorOfTransformation	1

It is unimodular since the factor of transformation is 1. We can also check this by computing the wronskian of  $Ly$  which is a rational function:

`ode::wronskian(Ly, y(x))`

$$\frac{1}{x^2 - 1}$$

Now we transform  $Ly$  into a differential equation whose wronskian is 1:

`ode::unimodular(Ly, y(x), Transform)`

equation	$\frac{\partial^2}{\partial x^2} y(x) - \frac{y(x) (6 x^2 - 7)}{(x^2 - 1)^2}$
factorOfTransformation	$\sqrt{\frac{1}{x^2 - 1}}$

`ode::wronskian(%[equation], y(x))`

1

## Parameters

**Ly**

A homogeneous linear differential equation over  $\mathbb{Q}(x)$ .

**y(x)**

The dependent function of Ly.

## **Return Values**

table.

## **See Also**

**MuPAD Functions**

`ode::wronskian`

# ode::vectorize

Coefficients of a homogeneous linear ODE

## Syntax

```
ode::vectorize(Ly, y, x, n)
```

## Description

`ode::vectorize(Ly, y, x, n)` returns the list of coefficients of the  $n$ -th order homogeneous linear ordinary differential equation  $Ly$ .

## Examples

### Example 1

We compute the list of coefficients of the following differential equation:

```
Ly := 4*x^2*diff(y(x), x$3)+exp(x^2)*diff(y(x),x$2)+
      4*x*diff(y(x),x)-y(x)
```

$$4x \frac{\partial}{\partial x} y(x) - y(x) + e^{x^2} \frac{\partial^2}{\partial x^2} y(x) + 4x^2 \frac{\partial^3}{\partial x^3} y(x)$$

```
ode::vectorize(Ly, y, x, 3)
```

$$\left[ -1, 4x, e^{x^2}, 4x^2 \right]$$

## Parameters

**$Ly$**

A homogeneous linear ordinary differential equation.

**$y$**

The dependent variable of  $Ly$ .

**$x$**

The independent variable of  $Ly$ .

**$n$**

The order of  $Ly$ , a positive integer.

## Return Values

`list`

# ode::wronskian

Wronskian of functions or of a linear homogeneous ordinary differential equation

## Syntax

```
ode::wronskian(l, x, <R>)
```

```
ode::wronskian(Ly, y(x), <R>)
```

## Description

`ode::wronskian` computes the wronskian (determinant) of functions or of a linear homogeneous ordinary differential equation.

`ode::wronskian(l, x)` returns the wronskian, i.e. the determinant of the wronskian matrix, of the elements of `l` with respect to `x`.

`ode::wronskian(Ly, y(x))` returns the wronskian of `Ly` defined as the element `w`

such that  $w' = -a_{n-1} w$ , where  $a_{n-1}$  is the coefficient of `Ly` of degree  $n - 1$  and  $n$  the order of `Ly`.

If the optional argument `R` is given, then the specified differential ring will be chosen for representing the entries of the wronskian matrix.

## Examples

### Example 1

We compute the wronskian of  $[2x^2+1, x\sqrt{1+x^2}, y(x)]$  which is a linear differential equation in  $y(x)$ :

```
Ly:=ode::wronskian([2*x^2+1, x*sqrt(1+x^2), y(x)], x)
```

$$4 x \sigma_4 \frac{\partial}{\partial x} y(x) - 4 x^2 \sigma_4 \frac{\partial^2}{\partial x^2} y(x) - 4 y(x) \sigma_3 - \sigma_1 \sigma_2 \frac{\partial}{\partial x} y(x) + 4 x y(x) \sigma_2 + \sigma_1 \sigma_3 \frac{\partial^2}{\partial x^2} y(x)$$

where

$$\sigma_1 = 2 x^2 + 1$$

$$\sigma_2 = \frac{3 x}{\sigma_4} - \frac{x^3}{(x^2 + 1)^{3/2}}$$

$$\sigma_3 = \sigma_4 + \frac{x}{\sigma_4}$$

$$\sigma_4 = \sqrt{x^2 + 1}$$

`Ly := numer( normal(Ly) )`

$$x^2 \frac{\partial^2}{\partial x^2} y(x) - 4 y(x) + x \frac{\partial}{\partial x} y(x) + \frac{\partial^2}{\partial x^2} y(x)$$

And we can check that a basis of solutions of Ly is as expected:

`ode::solve(Ly, y(x))`

$$\left\{ C1 \left( x + \sqrt{x^2 + 1} \right)^2 + \frac{C2}{\left( x + \sqrt{x^2 + 1} \right)^2} \right\}$$

We can also compute the wronskian of Ly, which is, up to a constant, the wronskian of  $x^2+1$  and  $x*\sqrt{x^2+1}$ :

```
ode::wronskian(Ly, y(x)),
simplify(ode::wronskian([x^2+1/2, x*sqrt(1+x^2)], x))
```

$$\frac{1}{\sqrt{x^2+1}}, \frac{1}{2\sqrt{x^2+1}}$$

## Parameters

**$\mathcal{L}$**

A list of functions of the variable  $x$ .

**$\text{Ly}$**

A homogeneous linear ordinary differential equation.

**$y(x)$**

The dependent function of  $\text{Ly}$ .

**$\mathbf{R}$**

A differential ring, default is `Dom::ExpressionField(id, iszero@normal)`.

## Return Values

Expression in  $x$ .





# **orthpoly - Orthogonal Polynomials**

---

## orthpoly::chebyshev1

The Chebyshev polynomials of the first kind

### Syntax

```
orthpoly::chebyshev1(n, x)
```

### Description

`orthpoly::chebyshev1(n, x)` computes the value of the  $n$ -th degree Chebyshev polynomial of the first kind at the point  $x$ .

These polynomials have integer coefficients.

Evaluation is fast and numerically stable for real floating point values  $x$  from the interval  $[-1.0, 1.0]$ . See “Example 2” on page 22-3 (Symbolic Math Toolbox).

`orthpoly::chebyshev2` implements the Chebyshev polynomials of the second kind.

### Examples

#### Example 1

Polynomial expressions are returned if identifiers or indexed identifiers are specified:

```
orthpoly::chebyshev1(2, x)
```

$$2x^2 - 1$$

```
orthpoly::chebyshev1(3, x[1])
```

$$4x_1^3 - 3x_1$$

Using arithmetical expressions as input, the “values” of these polynomials are returned:

```
orthpoly::chebyshev1(2, 3 + 2*I)
```

```
9 + 24 i
```

```
orthpoly::chebyshev1(3, exp(x[1]+2))
```

```
4 e6 e3 x1 - 3 ex1 e2
```

“Arithmetical expressions” include numbers:

```
orthpoly::chebyshev1(2, sqrt(2)),
orthpoly::chebyshev1(3, 8 + I),
orthpoly::chebyshev1(1000, 0.3)
```

```
3, 1928 + 761 i, -0.9991251116
```

If the degree of the polynomial is a variable or expression, then `orthpoly::chebyshev1` returns itself symbolically:

```
orthpoly::chebyshev1(n, x)
```

```
orthpoly::chebyshev1(n, x)
```

## Example 2

If a floating-point value is desired, then a direct call such as

```
orthpoly::chebyshev1(200, 0.3)
```

```
-0.3169632681
```

is appropriate and yields a correct result. One should not evaluate the symbolic polynomial at a floating-point value, because this may be numerically unstable:

```
T200 := orthpoly::chebyshev1(200, x):
```

```
DIGITS := 10: evalp(T200, x = 0.3)
```

```
-3912167.235
```

This result is caused by numerical round-off. Also with increased DIGITS only a few leading digits are correct:

```
DIGITS := 20: evalp(T200, x = 0.3)
```

```
-0.31710101442512309682
```

```
delete DIGITS, T200:
```

## Parameters

**n**

A nonnegative integer or an arithmetical expression representing a nonnegative integer: the degree of the polynomial.

**x**

An indeterminate or an arithmetical expression. An indeterminate is either an identifier (of domain type DOM\_IDENT) or an indexed identifier (of type "\_index").

## Return Values

The value of the Chebyshev polynomial at point  $x$  is returned as an arithmetical expression. If  $n$  is an arithmetical expression, then `orthpoly::chebyshev1` returns itself symbolically.

## Algorithms

The Chebyshev polynomials are given by  $T(n, x) = \cos(n \arccos(x))$  for real  $x \in [-1, 1]$ . This representation is used by `orthpoly::chebyshev1` for floating-point values in this range.

These polynomials satisfy the recursion formula

$$T(n, x) = 2x T(n-1, x) - T(n-2, x)$$

with  $T(0, x) = 1$  and  $T(1, x) = x$ .

They are orthogonal on the interval  $[-1, 1]$  with respect to the weight function

$$w(x) = \frac{1}{\sqrt{1-x^2}}.$$

$T(n, x)$  is a special Jacobi polynomial on page 22-20:

$$T(n, x) = \frac{2^{2n} n!^2}{(2n)!} P\left(n, -\frac{1}{2}, -\frac{1}{2}, x\right).$$

## See Also

### MuPAD Functions

orthpoly::chebyshev2 | orthpoly::jacobi

## orthpoly::chebyshev2

The Chebyshev polynomials of the second kind

### Syntax

```
orthpoly::chebyshev2(n, x)
```

### Description

`orthpoly::chebyshev2(n, x)` computes the value of the  $n$ -th degree Chebyshev polynomial of the second kind at the point  $x$ .

These polynomials have integer coefficients.

Evaluation is fast and numerically stable for real floating point values  $x$  from the interval  $[-1.0, 1.0]$ . See “Example 2” on page 22-7 (Symbolic Math Toolbox).

`orthpoly::chebyshev1` implements the Chebyshev polynomials of the first kind.

### Examples

#### Example 1

Polynomial expressions are returned if identifiers or indexed identifiers are specified:

```
orthpoly::chebyshev2(2, x)
```

$$4x^2 - 1$$

```
orthpoly::chebyshev2(3, x[1])
```

$$8x_1^3 - 4x_1$$

Using arithmetical expressions as input, the “values” of these polynomials are returned:

```
orthpoly::chebyshev2(2, 3 + 2*I)
```

19 + 48 i

```
orthpoly::chebyshev2(3, exp(x[1] + 2))
```

$8 e^6 e^{3 x_1} - 4 e^{x_1} e^2$

“Arithmetical expressions” include numbers:

```
orthpoly::chebyshev2(2, sqrt(2)),
orthpoly::chebyshev2(3, 8 + I),
orthpoly::chebyshev2(1000, 0.3)
```

7, 3872 + 1524 i, -1.012277265

If the degree of the polynomial is a variable or expression, then `orthpoly::chebyshev2` returns itself symbolically:

```
orthpoly::chebyshev2(n, x)
```

`orthpoly::chebyshev2(n, x)`

## Example 2

If a floating-point value is desired, then a direct call such as

```
orthpoly::chebyshev2(200, 0.3)
```

-0.01869337443

is appropriate and yields a correct result. One should not evaluate the symbolic polynomial at a floating-point value, because this may be numerically unstable:

```
U200 := orthpoly::chebyshev2(200, x):
```

```
DIGITS := 10: evalp(U200, x = 0.3)
```

```
-3872355.739
```

This result is caused by numerical round-off. Also with increased DIGITS only a few leading digits are correct:

```
DIGITS := 20: evalp(U200, x = 0.3)
```

```
-0.018233184138451814741
```

```
delete DIGITS, U200:
```

## Parameters

**n**

A nonnegative integer or an arithmetical expression representing a nonnegative integer: the degree of the polynomial.

**x**

An indeterminate or an arithmetical expression. An indeterminate is either an identifier (of domain type `DOM_IDENT`) or an indexed identifier (of type `"_index"`).

## Return Values

The value of the Chebyshev polynomial at point  $x$  is returned as an arithmetical expression. If  $n$  is an arithmetical expression, then `orthpoly::chebyshev2` returns itself symbolically.

## Algorithms

The Chebyshev polynomials of the second kind are given by



$$U(n, x) = \frac{\sin((n+1) \arccos(x))}{\sin(\arccos(x))}$$

for real  $x \in [-1, 1]$ . This representation is used by `orthpoly::chebyshev2` for floating-point values in this range.

These polynomials satisfy the recursion formula

$$U(n, x) = 2x U(n-1, x) - U(n-2, x)$$

with  $U(0, x) = 1$  and  $U(1, x) = 2x$ .

They are orthogonal on the interval  $[-1, 1]$  with respect to the weight function

$$w(x) = \sqrt{1-x^2}.$$

$U(n, x)$  coincides with the Gegenbauer polynomial on page 22-13  $G(n, 1, x)$ .

$U(n, x)$  is a special Jacobi polynomial on page 22-20:

$$U(n, x) = \frac{2^{2n} n! (n+1)!}{(2n+1)!} P\left(n, \frac{1}{2}, \frac{1}{2}, x\right)$$

## See Also

### MuPAD Functions

`orthpoly::chebyshev1` | `orthpoly::gegenbauer` | `orthpoly::jacobi`

## orthpoly::curtz

The Curtz polynomials

### Syntax

```
orthpoly::curtz(n, x)
```

### Description

`orthpoly::curtz(n, x)` computes the value of the  $n$ -th degree Curtz polynomial at the point  $x$ .

These polynomials have rational coefficients.

Evaluation for real floating-point values  $x$  is numerically stable. See “Example 2” on page 22-11 (Symbolic Math Toolbox).

### Examples

#### Example 1

Polynomial expressions are returned if identifiers or indexed identifiers are specified:

```
orthpoly::curtz(2, x)
```

$$x^2 - x + \frac{1}{3}$$

```
orthpoly::curtz(3, x[1])
```

$$x_1^3 - \frac{3 x_1^2}{2} + \frac{11 x_1}{12} - \frac{1}{4}$$

Using arithmetical expressions as input, the “values” of these polynomials are returned:

```
orthpoly::curtz(2, 3+2*I)
```

$$\frac{7}{3} + 10i$$

```
orthpoly::curtz(3, exp(x[1] + 2))
```

$$\frac{11 e^{x_1} e^2}{12} - \frac{3 e^4 e^{2 x_1}}{2} + e^6 e^{3 x_1} - \frac{1}{4}$$

“Arithmetical expressions” include numbers:

```
orthpoly::curtz(2, sqrt(2)), orthpoly::curtz(3, 8 + I),  
orthpoly::curtz(100, 0.3)
```

$$\frac{7}{3} - \sqrt{2}, \frac{4807}{12} + \frac{2015i}{12}, 0.001395122936$$

If the degree of the polynomial is a variable or expression, then `orthpoly::curtz` returns itself symbolically:

```
orthpoly::curtz(n, x)
```

$$\text{orthpoly::curtz}(n, x)$$

## Example 2

If a floating-point value is desired, then a direct call such as

```
orthpoly::curtz(50, 1.2)
```

$$0.0003843630923$$

is appropriate and yields a correct result. One should not evaluate the symbolic polynomial at a floating-point value, because this may be numerically unstable:

```
orthpoly::curtz(50, x): evalp(%, x = 1.2)
```

```
0.0003849036173
```

Note that only 3 digits are correct due to numerical round-off.

## Parameters

**n**

A nonnegative integer or an arithmetical expression representing a nonnegative integer: the degree of the polynomial.

**x**

An indeterminate or an arithmetical expression. An indeterminate is either an identifier (of domain type `DOM_IDENT`) or an indexed identifier (of type `"_index"`).

## Return Values

The value of the Curtz polynomial at point  $x$  is returned as an arithmetical expression. If  $n$  is an arithmetical expression, then `orthpoly::curtz` returns itself symbolically.

## Algorithms

The Curtz polynomials are given by the recursion formula

$$C(n, x) = x^n + x \left( \sum_{i=1}^{n-1} \frac{(-1)^i}{i+1} C(n-i-1, x) \right) + \frac{(-1)^n}{n+1}$$

with  $C(0, x) = 1$ .

# orthpoly::gegenbauer

The Gegenbauer (ultraspherical) polynomials

## Syntax

```
orthpoly::gegenbauer(n, a, x)
```

## Description

`orthpoly::gegenbauer(n, a, x)` computes the value of the  $n$ -th degree Gegenbauer polynomial with parameter  $a$  at the point  $x$ .

Evaluation for real floating-point values  $x$  from the interval  $[-1.0, 1.0]$  is numerically stable. See “Example 2” on page 22-14 (Symbolic Math Toolbox).

## Examples

### Example 1

Polynomial expressions are returned, if identifiers or indexed identifiers are specified:

```
orthpoly::gegenbauer(2, a, x)
```

$$x^2 (2 a^2 + 2 a) - a$$

```
orthpoly::gegenbauer(3, 2, x[1])
```

$$32 x_1^3 - 12 x_1$$

Using arithmetical expressions as input, the “values” of these polynomials are returned:

```
orthpoly::gegenbauer(2, 1, 3+2*I)
```

19 + 48 i

```
orthpoly::gegenbauer(3, 2, exp(x[1] + 2))
```

$32 e^6 e^{3 x_1} - 12 e^{x_1} e^2$

“Arithmetical expressions” include numbers:

```
orthpoly::gegenbauer(2, a, sqrt(2)),  
orthpoly::gegenbauer(3, 0.4, 8 + I),  
orthpoly::gegenbauer(1000, -1/3, 0.3)
```

$4 a^2 + 3 a, 865.536 + 341.152 i, 0.00006046127974$

If the degree of the polynomial is a variable or expression, then `orthpoly::gegenbauer` returns itself symbolically:

```
orthpoly::gegenbauer(n, a, x)
```

`orthpoly::gegenbauer(n, a, x)`

## Example 2

If a floating-point value is desired, then a direct call such as

```
orthpoly::gegenbauer(200, 4, 0.3)
```

165549.7263

is appropriate and yields a correct result. One should not evaluate the symbolic polynomial at a floating-point value, because this may be numerically unstable:

```
G200 := orthpoly::gegenbauer(200, 4, x):
```

```
DIGITS := 10: evalp(G200, x = 0.3)
```

$-6.270612376 10^{11}$

This result is caused by numerical round-off. Also with increased DIGITS only a few leading digits are correct:

```
DIGITS := 20: evalp(G200, x = 0.3)
```

```
165454.59819021060509
```

```
delete DIGITS, G200:
```

## Parameters

**n**

A nonnegative integer or an arithmetical expression representing a nonnegative integer: the degree of the polynomial.

**a**

An arithmetical expression.

**x**

An indeterminate or an arithmetical expression. An indeterminate is either an identifier (of domain type DOM\_IDENT) or an indexed identifier (of type "\_index").

## Return Values

The value of the Gegenbauer polynomial at point  $x$  is returned as an arithmetical expression. If  $n$  is an arithmetical expression, then `orthpoly::gegenbauer` returns itself symbolically.

## Algorithms

The Gegenbauer polynomials are given by the recursion formula

$$G(n, a, x) = \frac{2(n-1+a)}{n} x G(n-1, a, x) - \frac{n-2+2a}{n} G(n-2, a, x)$$

with  $G(0, a, x) = 1$ ,  $G(1, a, x) = 2 a x$ .

For fixed real  $a > -\frac{1}{2}$  these polynomials are orthogonal on the interval  $[-1, 1]$  with respect to the weight function  $w(x) = (1 - x^2)^{a - \frac{1}{2}}$ .

$G\left(n, \frac{1}{2}, x\right)$  coincides with the Legendre polynomial  $P(n, x)$ .

$G(n, 1, x)$  coincides with the Chebyshev polynomial  $U(n, x)$  of the second kind.

The polynomials  $G(n, 0, x)$  are trivial.

## See Also

### MuPAD Functions

`orthpoly::chebyshev2` | `orthpoly::legendre`



# orthpoly::hermite

The Hermite polynomials

## Syntax

```
orthpoly::hermite(n, x)
```

## Description

`orthpoly::hermite(n, x)` computes the value of the  $n$ -th degree Hermite polynomial at the point  $x$ .

These polynomials have integer coefficients.

## Examples

### Example 1

Polynomial expressions are returned if identifiers or indexed identifiers are specified:

```
orthpoly::hermite(2, x)
```

$$4x^2 - 2$$

```
orthpoly::hermite(3, x[1])
```

$$8x_1^3 - 12x_1$$

Using arithmetical expressions as input, the “values” of these polynomials are returned:

```
orthpoly::hermite(2, 3+2*I)
```

$$18 + 48i$$

```
orthpoly::hermite(3, exp(x[1] + 2))
```

$$8 e^6 e^{3x_1} - 12 e^{x_1} e^2$$

“Arithmetical expressions” include numbers:

```
orthpoly::hermite(2, sqrt(2)), orthpoly::hermite(3, 8 + I),  
orthpoly::hermite(1000, 0.3);
```

$$6, 3808 + 1516i, 2.26821486 \cdot 10^{1433}$$

If the degree of the polynomial is a variable or expression, then `orthpoly::hermite` returns itself symbolically:

```
orthpoly::hermite(n, x)
```

$$\text{orthpoly::hermite}(n, x)$$

## Parameters

**n**

A nonnegative integer or an arithmetical expression representing a nonnegative integer: the degree of the polynomial.

**x**

An indeterminate or an arithmetical expression. An indeterminate is either an identifier (of domain type `DOM_IDENT`) or an indexed identifier (of type `"_index"`).

## Return Values

The value of the Hermite polynomial at point  $x$  is returned as an arithmetical expression. If  $n$  is an arithmetical expression, then `orthpoly::hermite` returns itself symbolically.

## Algorithms

The Hermite polynomials are given by the recursion formula

$$H(n, x) = 2x H(n-1, x) - 2(n-1) H(n-2, x)$$

with  $H(0, x) = 1$  and  $H(1, x) = 2x$ .

These polynomials are orthogonal on the real line with respect to the weight function

$$w(x) = e^{-x^2}.$$

## orthpoly::jacobi

The Jacobi polynomials

### Syntax

```
orthpoly::jacobi(n, a, b, x)
```

### Description

`orthpoly::jacobi(n, a, b, x)` computes the value of the  $n$ -th degree Jacobi polynomial with parameters  $a$  and  $b$  at the point  $x$ .

Evaluation for real floating-point values  $x$  from the interval  $[-1.0, 1.0]$  is numerically stable. See “Example 2” on page 22-21 (Symbolic Math Toolbox).

### Examples

#### Example 1

Polynomial expressions are returned if identifiers or indexed identifiers are specified:

```
orthpoly::jacobi(2, a, b, x)
```

$$x^2 \left( \frac{a^2}{8} + \frac{a b}{4} + \frac{7 a}{8} + \frac{b^2}{8} + \frac{7 b}{8} + \frac{3}{2} \right) - \frac{b}{8} - \frac{a b}{4} - \frac{a}{8} + \frac{a^2}{8} + \frac{b^2}{8} + x \left( \frac{a^2}{4} + \frac{3 a}{4} - \frac{b^2}{4} - \frac{3 b}{4} \right) - \frac{1}{2}$$

```
orthpoly::jacobi(3, 4, 5, x[1])
```

$$\frac{455 x_1^3}{8} - \frac{91 x_1^2}{8} - \frac{91 x_1}{8} + \frac{7}{8}$$

Using arithmetical expressions as input, the “values” of these polynomials are returned:

```
orthpoly::jacobi(2, 4, 1, 3+2*I)
```

$63 + 120 i$

```
orthpoly::jacobi(2, 0, I, exp(x[1] + 2))
```

$e^{x_1} e^2 \left( \frac{1}{4} - \frac{3i}{4} \right) + e^4 e^{2x_1} \left( \frac{11}{8} + \frac{7i}{8} \right) - \frac{5}{8} - \frac{i}{8}$

“Arithmetical expressions” include numbers:

```
orthpoly::jacobi(2, 1/2, -1/2, sqrt(2)),
orthpoly::jacobi(3, 2, 5, 8 + I),
orthpoly::jacobi(1000, 1, 2, 0.3);
```

$\frac{3\sqrt{2}}{4} + \frac{21}{8}, \frac{31733}{2} + \frac{12859i}{2}, -0.06546648097$

If the degree of the polynomial is a variable or expression, then `orthpoly::jacobi` returns itself symbolically:

```
orthpoly::jacobi(n, a, b, x)
```

`orthpoly::jacobi(n, a, b, x)`

## Example 2

If a floating-point value is desired, then a direct call such as

```
orthpoly::jacobi(100, 1/2, 3/2, 0.9)
```

$0.2560339406$

is appropriate and yields a correct result. One should not evaluate the symbolic polynomial at a floating-point value, because this may be numerically unstable:

```
P100 := orthpoly::jacobi(100, 1/2, 3/2, x):
```

```
evalp(P100, x = 0.9)
```

```
-8.6781052 1015
```

This result is caused by numerical round-off. Also with increased DIGITS only a few leading digits are correct:

```
DIGITS := 30: evalp(P100, x = 0.9)
```

```
0.256030968488207303016930946513
```

```
delete P100, DIGITS:
```

## Parameters

**n**

A nonnegative integer or an arithmetical expression representing a nonnegative integer: the degree of the polynomial.

**a, b**

Arithmetical expressions.

**x**

An indeterminate or an arithmetical expression. An indeterminate is either an identifier (of domain type `DOM_IDENT`) or an indexed identifier (of type `"_index"`).

## Return Values

The value of the Jacobi polynomial at point `x` is returned as an arithmetical expression. If `n` is an arithmetical expression, then `orthpoly::jacobi` returns itself symbolically.

## Algorithms

The Jacobi polynomials are given by the recursion formula

$$2n c_n c_{2n-2} P(n, a, b, x) = c_{2n-1} \left( c_{2n-2} c_{2n} x + a^2 - b^2 \right) P(n-1, a, b, x) - 2(n-1+a)(n-1+b) c_{2n} P(n-2, a, b, x)$$

with  $c_i = i + a + b$  and

$$P(0, a, b, x) = 1, P(1, a, b, x) = \frac{a-b}{2} + \left( 1 + \frac{a+b}{2} \right) x.$$

For fixed real  $a > -1$ ,  $b > -1$  the Jacobi polynomials are orthogonal on the interval  $[-1, 1]$  with respect to the weight function  $w(x) = (1-x)^a (1+x)^b$ .

For special values of the parameters  $a, b$  the Jacobi polynomials are related to the Legendre polynomials

$$P(n, x) = P(n, 0, 0, x),$$

to the Chebyshev polynomials of the first kind

$$T(n, x) = \frac{2^{2n} n!^2}{(2n)!} P\left(n, -\frac{1}{2}, -\frac{1}{2}, x\right),$$

to the Chebyshev polynomials of the second kind

$$U(n, x) = \frac{2^{2n} n! (n+1)!}{(2n+1)!} P\left(n, \frac{1}{2}, \frac{1}{2}, x\right),$$

and to the Gegenbauer polynomials, respectively:

$$G(n, a, x) = \frac{\Gamma\left(a + \frac{1}{2}\right) \Gamma(n + 2a)}{\Gamma(2a) \Gamma\left(n + a + \frac{1}{2}\right)} P\left(n, a - \frac{1}{2}, a - \frac{1}{2}, x\right)$$

## See Also

### MuPAD Functions

orthpoly::chebyshev1 | orthpoly::chebyshev2 | orthpoly::gegenbauer |  
orthpoly::legendre



# orthpoly::laguerre

The (generalized) Laguerre polynomials

## Syntax

```
orthpoly::laguerre(n, a, x)
```

## Description

`orthpoly::laguerre(n, a, x)` computes the value of the generalized  $n$ -th degree Laguerre polynomial with parameter  $a$  at the point  $x$ .

The standard Laguerre polynomials correspond to  $a = 0$ . They have rational coefficients.

## Examples

### Example 1

Polynomial expressions are returned if identifiers or indexed identifiers are specified:

```
orthpoly::laguerre(2, a, x)
```

$$\frac{3a}{2} - x(a+2) + \frac{a^2}{2} + \frac{x^2}{2} + 1$$

```
orthpoly::laguerre(3, a, x[1])
```

$$\frac{11a}{6} - \frac{x_1^3}{6} - x_1 \left( \frac{a^2}{2} + \frac{5a}{2} + 3 \right) + \left( \frac{a}{2} + \frac{3}{2} \right) x_1^2 + a^2 + \frac{a^3}{6} + 1$$

Using arithmetical expressions as input, the “values” of these polynomials are returned:

```
orthpoly::laguerre(2, 4, 3+2*I)
```

$$-\frac{1}{2} - 6i$$

```
orthpoly::laguerre(2, 2/3*I, exp(x[1] + 2))
```

$$\frac{e^4 e^{2x_1}}{2} + e^{x_1} e^2 \left(-2 - \frac{2i}{3}\right) + \frac{7}{9} + i$$

“Arithmetical expressions” include numbers:

```
orthpoly::laguerre(2, a, sqrt(2)),  
orthpoly::laguerre(3, 0.4, 8 + I),  
orthpoly::laguerre(1000, 3, 0.3);
```

$$\frac{3a}{2} - \sqrt{2}a - 2\sqrt{2} + \frac{a^2}{2} + 2, -4.969333333 - 8.713333333i, -15691.69498$$

If the degree of the polynomial is a variable or expression, then `orthpoly::laguerre` returns itself symbolically:

```
orthpoly::laguerre(n, a, x)
```

```
orthpoly::laguerre(n, a, x)
```

## Parameters

**n**

A nonnegative integer or an arithmetical expression representing a nonnegative integer: the degree of the polynomial.

**a**

An arithmetical expression.

**x**

An indeterminate or an arithmetical expression. An indeterminate is either an identifier (of domain type `DOM_IDENT`) or an indexed identifier (of type "`_index`").

## Return Values

The value of the Laguerre polynomial at point `x` is returned as an arithmetical expression. If `n` is an arithmetical expression, then `orthpoly::laguerre` returns itself symbolically.

## Algorithms

The Laguerre polynomials are given by the recursion formula

$$L(n, a, x) = \frac{2n + a - 1 - x}{n} L(n - 1, a, x) - \frac{n + a - 1}{n} L(n - 2, a, x)$$

with  $L(0, a, x) = 1$  and  $L(1, a, x) = 1 + a - x$ .

For fixed real  $a > -1$  these polynomials are orthogonal on the interval  $[0, \infty)$  with respect

to the weight function  $w(x) = \frac{1}{(x^a e^x)}$ .

## orthpoly::legendre

The Legendre polynomials

### Syntax

```
orthpoly::legendre(n, x)
```

### Description

`orthpoly::legendre(n, x)` computes the value of the  $n$ -th degree Legendre polynomial at the point  $x$ .

These polynomials have rational coefficients.

Evaluation for real floating-point values  $x$  from the interval  $[-1.0, 1.0]$  is numerically stable. See “Example 2” on page 22-29 (Symbolic Math Toolbox).

Use `numeric::gldata` to compute the roots of the Legendre polynomials. Cf. “Example 3” on page 22-30 (Symbolic Math Toolbox).

### Examples

#### Example 1

Polynomial expressions are returned if identifiers or indexed identifiers are specified:

```
orthpoly::legendre(2, x)
```

$$\frac{3x^2}{2} - \frac{1}{2}$$

```
orthpoly::legendre(3, x[1])
```

$$\frac{5 x_1^3}{2} - \frac{3 x_1}{2}$$

Using arithmetical expressions as input, the “values” of these polynomials are returned:

```
orthpoly::legendre(2, 3+2*I)
```

7 + 18 i

```
orthpoly::legendre(3, exp(x[1] + 2))
```

$$\frac{5 e^6 e^{3 x_1}}{2} - \frac{3 e^{x_1} e^2}{2}$$

“Arithmetical expressions” include numbers:

```
orthpoly::legendre(2, sqrt(2)), orthpoly::legendre(3, 8 + I),  
orthpoly::legendre(1000, 0.3)
```

$\frac{5}{2}$ , 1208 + 476 i, -0.02566916751

If the degree of the polynomial is a variable or expression, then `orthpoly::legendre` returns itself symbolically:

```
orthpoly::legendre(n, x)
```

`orthpoly::legendre(n, x)`

## Example 2

If a floating-point value is desired, then a direct call such as

```
orthpoly::legendre(100, 0.9)
```

0.1022658206

is appropriate and yields a correct result. One should not evaluate the symbolic polynomial at a floating-point value, because this may be numerically unstable:

```
P100 := orthpoly::legendre(100, x):  
evalp(P100, x = 0.9)
```

```
8.284745953 1014
```

This result is caused by numerical round-off. Also with increased DIGITS only a few leading digits are correct:

```
DIGITS := 30: evalp(P100, x = 0.9)
```

```
0.102276303910546875548266967112
```

```
delete P100, DIGITS:
```

### Example 3

We recommend to use `numeric::gldata` for computing roots of the Legendre polynomial  $P(n, x)$ . This routine provides all roots of the function  $Q(n, y) = P(n, 2y - 1)$ :

```
QRoots := numeric::gldata(5, DIGITS)[2]
```

```
[0.04691007703, 0.2307653449,  $\frac{1}{2}$ , 0.7692346551, 0.953089923]
```

These values are easily transformed to roots of  $P(n, x)$ :

```
PRoots := map(QRoots, y -> 2*y - 1)
```

```
[-0.9061798459, -0.5384693101, 0, 0.5384693101, 0.9061798459]
```

```
orthpoly::legendre(5, r) $ r in PRoots
```

```
-1.080385781 10-14, -1.387778781 10-18, 0, 1.387778781 10-18, 1.081218448 10-14
```

delete QRoots, PRoots:

## Parameters

**n**

A nonnegative integer or an arithmetical expression representing a nonnegative integer: the degree of the polynomial.

**x**

An indeterminate or an arithmetical expression. An indeterminate is either an identifier (of domain type DOM\_IDENT) or an indexed identifier (of type "\_index").

## Return Values

The value of the Legendre polynomial at point  $x$  is returned as an arithmetical expression. If  $n$  is an arithmetical expression, then `orthpoly::legendre` returns itself symbolically.

## Algorithms

The Legendre polynomials are given by  $P(n, x) = \frac{1}{2^n n!} \frac{d^n}{dx^n} (x^2 - 1)^n$ .

They satisfy the recursion formula

$$P(n, x) = \frac{2n-1}{n} x P(n-1, x) - \frac{n-1}{n} P(n-2, x)$$

with  $P(0, x) = 1$  and  $P(1, x) = x$ .

They are orthogonal on the interval  $[-1, 1]$  with respect to the weight function  $w(x) = 1$ .

$P(n, x)$  coincides with the Gegenbauer polynomial on page 22-13  $G\left(n, \frac{1}{2}, x\right)$ .

$P(n, x)$  coincides with the Jacobi polynomial on page 22-20  $P(n, 0, 0, x)$ .

## See Also

### MuPAD Functions

`numeric::gldata` | `orthpoly::gegenbauer` | `orthpoly::jacobi`



# output - Formatted Output

---

## output::asciiAbbreviate

Generates a procedure for creating an ASCII formatted output

### Syntax

```
output::asciiAbbreviate(<varname>)
```

### Description

`output::asciiAbbreviate` generates a procedure for creating ASCII formatted outputs of expressions

By default, MuPAD generates ASCII abbreviations using the # symbol followed by numbers. Using the argument `varname` you can customize the names of abbreviated subexpressions. See “Example 2” on page 23-3 (Symbolic Math Toolbox).

If you want to use abbreviations in all ASCII PrettyPrint output expressions, pass the procedure generated by `output::asciiAbbreviate` to `Pref::output`. See “Example 3” on page 23-4 (Symbolic Math Toolbox).

### Examples

#### Example 1

The generated procedure `ascii` produces ASCII code for MuPAD expressions:

```
ascii:=output::asciiAbbreviate():
y := solve(x^3 + x + 1 = 0, x, MaxDegree = 3):
ascii(y)
```

```
{
{
{          1          1          #1          sqrt(3) | 1 | \
{          1          1          #1          \ 3 #1 |  + #1 | I
{ #1 - -----, -----, -----, -----,
{          1          1          #1          \ 3 #1 |  + #1 | I
```

$$\left\{ \frac{1}{6 \sqrt{3}} - \frac{\sqrt{3}}{6 \sqrt{3}} + \frac{\sqrt{3} \left( \frac{1}{\sqrt{3}} + \sqrt{3} \right)^{1/3}}{2} \right\}$$

where

$$\sqrt{3} = \frac{\sqrt{31} \sqrt{108}}{108} - \frac{1}{2} \sqrt[3]{1/3}$$

## Example 2

You can customize the names of abbreviated subexpressions:

```
ascii:=output::asciiAbbreviate(t):
y := solve(x^3 + x + 1 = 0, x, MaxDegree = 3):
ascii(y)
```

$$\left\{ \frac{1}{3 \sqrt{3}} - \frac{1}{6 \sqrt{3}} + \frac{\sqrt{3} \left( \frac{1}{\sqrt{3}} + \sqrt{3} \right)^{1/3}}{2} \right\}$$

where

$$\sqrt{3} = \frac{\sqrt{31} \sqrt{108}}{108} - \frac{1}{2} \sqrt[3]{1/3}$$

### Example 3

The generated procedure can serve as an input for `Pref::output`:

```
Pref::output(output::asciiAbbreviate(u)):
y := solve(x^3 + x + 1 = 0, x, MaxDegree = 3)
```

$$\left\{ \begin{array}{l} \left\{ \begin{array}{l} \frac{1}{3u_1} - \frac{1}{6u_1} + \frac{1}{2} + \frac{\sqrt{3} \left( \frac{1}{3u_1} + u_1 \right)^{1/3}}{2} \end{array} \right\} \\ \frac{1}{6u_1} - \frac{u_1}{2} + \frac{\sqrt{3} \left( \frac{1}{3u_1} + u_1 \right)^{1/3}}{2} \end{array} \right\}$$

where

$$u_1 = \frac{\sqrt{31} \sqrt{108}}{108} - \frac{1}{2} \sqrt[3]{\phantom{x}}$$

### Parameters

**varname**

A base name for the abbreviation variables

### Return Values

Procedure for creating an ASCII formatted output

## See Also

### MuPAD Functions

Pref::abbreviateOutput | Pref::output | output::subexpr

## output::fence

Put delimiters around multiline strings

### Syntax

```
output::fence(left, right, string, <width, <base>>)
```

### Description

`output::fence(left, right, string)` encloses the multiline string in the delimiters indicated by `left` and `right`

You can use `output::fence` in combination with `strprint` to overload `print` (and thereby, standard screen output) for pretty-printing. Note that it does not affect typeset output.

### Examples

#### Example 1

Set `TEXTWIDTH` to 75:

```
TEXTWIDTH := 75:
```

First, define a domain that uses `output::fence` for output:

```
domain Fence
  print := x -> output::fence("(", ")", extop(x, 1));
  new   := x -> new(dom, x);
end_domain:
```

`Fence` expects a string in its constructor. The output uses `output::fence` to put parentheses around the input:

```
print(Plain, Fence("abc"))
```

```
(abc)
```

Strings of height two are only partly placed inside parentheses, for consistency with the pretty-printer:

```
print(Plain, Fence("abc\ndef"), sin(x^2))
```

```
abc      2
(def), sin(x )
```

Strings of height more than two are fully bracketed:

```
print(Plain, Fence("abc\ndef\nghi"))
```

```
/ abc \
| def |
\ ghi /
```

## Example 2

Set TEXTWIDTH to 75:

```
TEXTWIDTH := 75:
```

The next step in using `output::fence` is to enclose expressions in parentheses. For this, the information from `strprint` is useful:

```
domain FenceExpr
  print := proc(x)
    local str, h1, w1, h, w, b;
    begin
      [str, h1, w1, h, w, b] := strprint(All, extop(x));
      output::fence("{", "]", str, w, b);
    end_proc;
  new := x -> new(dom, x);
end_domain:
```

The sixth operand of the return value of `strprint(All, ...)` must be given to `output::fence` to align baselines properly:

```
print(Plain, FenceExpr(x), FenceExpr(x^2), FenceExpr(x^2/2*y))
```

```

      { 2 --
    2 { x y |
{x}, {x }, { ---- |
      { 2 --

```

`strprint` reacts to `TEXTWIDTH` and can return a string consisting of more than one logical line. In this case, fencing the returned string leads to strange results:

```
print(Plain, FenceExpr(_plus(x.i $ i = 0..30)))
```

```

{x0 + x1 + x2 + x3 + x4 + x5 + x6 + x7 + x8 + x9 + x10 + x11 + x12 + x13 \
  --
{
|
{ + x14 + x15 + x16 + x17 + x18 + x19 + x20 + x21 + x22 + x23 + x24 + x\
25 |
{
|
{ + x26 + x27 + x28 + x29 + x30
  --

```

Here, the string with added delimiter symbols is too wide for `TEXTWIDTH`. Also, `output::fence` does not let you control line breaks. Therefore, it is a good practice to avoid putting large delimiters to the left and right of long strings. For example, `abs` prints in functional notation for long arguments:

```
print(Plain, abs(_plus(x.i $ i = 0..30)))
```

```

abs(x0 + x1 + x2 + x3 + x4 + x5 + x6 + x7 + x8 + x9 + x10 + x11 + x12
    + x13 + x14 + x15 + x16 + x17 + x18 + x19 + x20 + x21 + x22 + x23 + x24
    + x25 + x26 + x27 + x28 + x29 + x30)

```

## Parameters

### left, right

Strings indicating the type of delimiter: "(", ")", "[", "]", "[+", "+]", "{", "}", "|", "| ", or " |".



**string**

The string to enclose

**width**

The width of the string to enclose. Defaults to the width of the widest line in `string`.

**base**

The baseline of the string, counted from the first line. Defaults to the bottom line of the string. If set to `-1`, the baseline is vertically centered.

## Return Values

String

## See Also

**MuPAD Functions**

`strprint`

## output::mathText

Pretty output of text combined with formulas

### Syntax

```
output::mathText(str1, expr1, <str2, <expr2>, ...>)
```

### Description

`output::mathText( str1, expr1, str2, ... )` creates an object of combined strings and expressions. This object prints itself nicely in various output formats.

### Examples

#### Example 1

`output::mathText` creates an object representing combined text and formulas:

```
messageWithMath := output::mathText("The integral ",  
                                     hold(int(sin(x)*cos(x), x)),  
                                     " is equal to ", int(sin(x)*cos(x), x))
```

The integral  $\int \cos(x) \sin(x) dx$  is equal to  $\frac{\sin(x)^2}{2}$

They can be printed with the ASCII pretty-printer as well:

```
print(Plain, messageWithMath)
```

The integral  $\int \sin(x) \cos(x) dx$  is equal to  $\frac{\sin(x)^2}{2}$

Same for the ASCII lineprint output:

```
PRETTYPRINT := FALSE:  
print(Plain, messageWithMath):  
delete PRETTYPRINT:
```

The integral  $\int(\sin(x)\cos(x), x)$  is equal to  $\sin(x)^2/2$

## Parameters

**str<sub>1</sub>, str<sub>2</sub>**

Strings

**expr<sub>1</sub>, expr<sub>2</sub>**

Expressions

## Return Values

Object of type `output::mathText`

## See Also

**MuPAD Functions**

`strprint`

# output::ordinal

Ordinal numbers

## Syntax

```
output::ordinal(i)
```

## Description

`output::ordinal` converts an integer to the corresponding english ordinal number. The return value is a string and can be used in messages.

## Examples

### Example 1

Convert some numbers to the corresponding english ordinal string:

```
map([0, 1, 2, 3, 4, 22, 134, 2001], output::ordinal)
```

```
["0th", "1st", "2nd", "3rd", "4th", "22nd", "134th", "2001st"]
```

## Parameters

**i**

An integer number

## Return Values

String with the English ordinal number

## See Also

**MuPAD Functions**

info | print

## output::roman

Roman numerals

### Syntax

```
output::roman(n)
```

### Description

`output::roman` converts an integer to the corresponding roman numeral. The return value is a string and can be used in messages.

### Examples

#### Example 1

Convert some numbers to the corresponding roman numerals:

```
map([1, 2, 3, 4, 22, 134, 2001], output::roman)
```

```
["I", "II", "III", "IV", "XXII", "CXXXIV", "MMI"]
```

Now, thanks to alias backsubstitution, we can trick MuPAD into computing with roman numerals:

```
alias(`I`=1): // I is a reserved word in MuPAD, so we use `I` instead
for i from 2 to 1000 do
    eval(text2expr("alias(".output::roman(i)."]=".expr2text(i).");"));
end_for:
II+II;
XIII*XXIV
```

```
IV
```

CCCXII

```
unalias(`I`):  
for i from 2 to 1000 do  
  eval(text2expr("unalias(".output::roman(i).");"));  
end_for:
```

## Parameters

**n**

Positive integer

## Return Values

String containing the roman numeral

## See Also

**MuPAD Functions**

[info](#) | [print](#)

## output::subexpr

Abbreviates a expression

### Syntax

```
output::subexpr(e, <varname>)
```

### Description

`output::subexpr` rewrites symbolic expression in terms of common subexpressions.

If an expression `e` contains common subexpressions, `output::subexpr(e)` returns a list that contains the abbreviated expression and the abbreviations in a form of equations. With `output::subexpr` you get the same abbreviations as you see in the outputs. See “Example 1” on page 23-16 (Symbolic Math Toolbox).

An output of this command does not depend on the current setting of `Pref::abbreviateOutput`.

By default, MuPAD generates abbreviations using the `#` symbol followed by numbers. Using the argument `varname`, you can customize the names of abbreviated subexpressions. See “Example 2” on page 23-17 (Symbolic Math Toolbox).

### Examples

#### Example 1

You can abbreviate an expression:

```
y := solve(x^3 + x + 1 = 0, x, MaxDegree = 3):  
output::subexpr(y)
```



$$\left[ \left\{ \#_1 - \frac{1}{3 \#_1}, \frac{1}{6 \#_1} - \frac{\#_1}{2} + \frac{\sqrt{3} \left( \frac{1}{3 \#_1} + \#_1 \right) i}{2}, \frac{1}{6 \#_1} - \frac{\#_1}{2} - \frac{\sqrt{3} \left( \frac{1}{3 \#_1} + \#_1 \right) i}{2} \right\}, \right. \\ \left. \#_1 = \left( \frac{\sqrt{31} \sqrt{108}}{108} - \frac{1}{2} \right)^{1/3} \right]$$

## Example 2

You can customize the names of abbreviated subexpressions:

```
y := solve(x^3 + x + 1 = 0, x, MaxDegree = 3):
output::subexpr(y, t)
```

$$\left[ \left\{ t1 - \frac{1}{3 t1}, \frac{1}{6 t1} - \frac{t1}{2} - \frac{\sqrt{3} \left( \frac{1}{3 t1} + t1 \right) i}{2}, \frac{1}{6 t1} - \frac{t1}{2} + \frac{\sqrt{3} \left( \frac{1}{3 t1} + t1 \right) i}{2} \right\}, \right. \\ \left. t1 = \left( \frac{\sqrt{31} \sqrt{108}}{108} - \frac{1}{2} \right)^{1/3} \right]$$

## Parameters

**e**

A MuPAD expression

**varname**

A base name for the abbreviation variables

## Return Values

List that contains the abbreviated expression and the abbreviations as equations

## See Also

### **MuPAD Functions**

`Pref::abbreviateOutput` | `output::asciiAbbreviate`

# output::tableForm

Printing objects in table form

## Syntax

```
output::tableForm(obj, <separator>, options)
```

## Description

`output::tableForm(obj)` prints the elements of the given object `obj` in table form.

The width of the table and the number of columns depends on the size of `TEXTWIDTH` (see options `Width` and `Columns`). The width of a column depends on the widest entry in this column.

`output::tableForm` determines the number of columns, that the total width of the table fits into `TEXTWIDTH`.

The columns are separated by one space by default.

If `separator` is given, then it is printed between each column (instead of one space). Appending spaces to the separator results additionally space between columns. By default the separator is one space.

If the first argument `obj` is a table on page 1-2103 or a domain on page 7-8, `output::tableForm` uses the option `Columns = 2` (two columns) and the separator `"= "` as default.

Without the option `Sort` the objects are converted to strings and then sorted alphabetically. To avoid any sorting the option `Sort = FALSE` must be given.

## Examples

### Example 1

For all examples on this page we assume the TEXTWIDTH 75:

```
TEXTWIDTH := 75:
```

Print some random numbers in table form:

```
SEED := -1:
output::tableForm([random(100000)() $ k = 1..30])

11647 12826 26280 26292 28315 30908 36523 42073 4682 47334 52640 56426

5829 615 62580 65904 66223 6719 69451 69903 77904 78221 80528 81013

86068 89016 90516 91008 92791 9532
```

Some random strings are created. The columns should have all the same width (Unique) and be printed centered. The strings should not be sorted:

```
output::tableForm([_concat("*" $ random(10)()) $ k = 1..20],
                  Unique, Center, Sort = FALSE)

***** "*****" ***** "*****" "*" *****
*****" "*****" "*****" "*****" "*****" "*****"
*****" "*****" "*****" "*****" "*****" "*****"
```

The option Unquoted prevents printing of quotes (see fprintf):

```
output::tableForm([_concat("*" $ random(10)()) $ k = 1..20],
                  Unique, Center, Sort = FALSE, Unquoted)

***** * ***** ***** ***** ***** ** **
***** * ***** ***** ** ***** ***** **
* *****
```

## Example 2

The next object is a MuPAD table and should be printed as a table with two columns. The table contains some random numbers and their sum of the digits:

```
SEED := -1:
T := table(op(map([random(100000000)() $ k = 1..10],
    proc(X)
      local Xs, k;
    begin
      Xs := expr2text(X);
      X = _plus(text2expr(substring(Xs, k))
        $ k = 1..length(Xs))
    end_proc))):
```

```
output::tableForm(T)
```

```
19962580 = 40
```

```
25878221 = 35
```

```
37777904 = 44
```

```
41281013 = 20
```

```
43856426 = 38
```

```
46169451 = 36
```

```
66926292 = 42
```

```
80330908 = 31
```

```
89306719 = 43
```

```
94386068 = 44
```

Domains are also printed in this form by default:

```
output::tableForm(newDomain("Test",
    table("type" = "Test",
      "info" = "only a testdomain")))
```

```
"info" = "only a testdomain"
```

```
"key" = "Test"
```

```
"type" = "Test"
```

### Example 3

The next table should consist of four columns:

```
SEED := -1:
output::tableForm([random(100000)() $ k = 1..30], Columns = 4)

11647 12826 26280 26292
28315 30908 36523 42073
4682 47334 52640 56426
5829 615 62580 65904
66223 6719 69451 69903
77904 78221 80528 81013
86068 89016 90516 91008
92791 9532
```

The next table should have a maximal width of 50 characters:

```
SEED := -1:
output::tableForm([random(100000)() $ k = 1..30], Width = 50)

11647 12826 26280 26292 28315 30908 36523 42073
4682 47334 52640 56426 5829 615 62580 65904
66223 6719 69451 69903 77904 78221 80528 81013
86068 89016 90516 91008 92791 9532

delete T:
```

### Example 4

The next examples show different usage of separators. First one single separator:

```
SEED := -1:
output::tableForm([random(100000)() $ k = 1..30], "|")

11647|12826|26280|26292|28315|30908|36523|42073|4682 |47334|52640|56426
```

```
5829|615 |62580|65904|66223|6719 |69451|69903|77904|78221|80528|81013
86068|89016|90516|91008|92791|9532
```

Now a list with a separator character between each column. If the list is too short, the characters are used from beginning of the list again etc.:

```
SEED := -1:
output::tableForm([random(100000)() $ k = 1..30], ["|", " ", " "])

11647|12826 26280 26292|28315 30908 36523|42073 4682 47334|52640 56426
5829|615 62580 65904|66223 6719 69451|69903 77904 78221|80528 81013
86068|89016 90516 91008|92791 9532
```

Only the first both columns should be separated by a vertical line:

```
SEED := -1:
output::tableForm([random(100000)() $ k = 1..30], ["|", " " $ 10])

11647|12826 26280 26292 28315 30908 36523 42073 4682 47334 52640 56426
5829|615 62580 65904 66223 6719 69451 69903 77904 78221 80528 81013
86068|89016 90516 91008 92791 9532
```

Additionally a character can be appended to each entry:

```
SEED := -1:
output::tableForm([random(100000)() $ k = 1..30],
  ["|", " " $ 10], Append = ",")

11647,|12826, 26280, 26292, 28315, 30908, 36523, 42073, 4682, 47334, 52640,
56426,|5829, 615, 62580, 65904, 66223, 6719, 69451, 69903, 77904, 78221,
80528,|81013, 86068, 89016, 90516, 91008, 92791, 9532,
```

## Example 5

The next examples show different usage of sorting. Without the option `Sort` the numbers are sorted as strings in lexicographical order:

```
SEED := -1:
output::tableForm([random(100000)() $ k = 1..30])
```

```
11647 12826 26280 26292 28315 30908 36523 42073 4682 47334 52640 56426
5829 615 62580 65904 66223 6719 69451 69903 77904 78221 80528 81013
86068 89016 90516 91008 92791 9532
```

Sort = FALSE avoids any sorting:

```
SEED := -1:
output::tableForm([random(100000)() $ k = 1..30], Sort = FALSE)

30908 6719 26292 56426 81013 69451 77904 78221 86068 62580 47334 12826
9532 5829 28315 65904 42073 80528 4682 52640 69903 92791 36523 26280
89016 91008 615 66223 90516 11647
```

Any sorting can be done with a special defined procedure, e.g., sort the numbers in reverse order:

```
SEED := -1:
output::tableForm([random(100000)() $ k = 1..30],
                  Sort = ((X,Y) -> Y < X))

92791 91008 90516 89016 86068 81013 80528 78221 77904 69903 69451 66223
65904 62580 56426 52640 47334 42073 36523 30908 28315 26292 26280 12826
11647 9532 6719 5829 4682 615
```

At last a user defined procedure is given that sorts the numbers by the sum of their digits ascending:

```
SEED := -1:
output::tableForm([random(100000)() $ k = 1..30],
                  Sort = proc(X,Y)
                    local crossfoot;
                    begin
                      crossfoot :=
                        proc(X)
                          local Xs, k;
                          begin
                            Xs := expr2text(X);
                            _plus(text2expr(substring(Xs, k))
                                $ k = 1..length(Xs))
                          end_proc;
                    end_proc;
```



```
crossfoot(X) < crossfoot(Y)
end_proc)
```

```
615  81013 42073 52640 91008 26280 36523 11647 12826 66223 9532 28315
30908 4682  78221 26292 90516 47334 62580 56426 80528 6719  5829 65904
89016 69451 77904 69903 92791 86068
```

## Parameters

### **obj**

A list, set or table of any MuPAD objects or a domain

### **separator**

A string between columns

## Options

### **Unquoted**

Strings are printed without quotes

The output function `fprint` is called with the option `Unquoted`.

### **Unique**

All columns are of the same width

All columns are printed with the same width, the widest column determines the width of each column.

### **Width**

Option, specified as `Width = w`

The maximal width of the table is set to `w` (instead of `TEXTWIDTH`). `w` must be a positive integer.

**Columns**

Option, specified as `Columns = c`

The number of columns is set to `c`. The width of the table depends on the width of any column.

---

**Note** `output::tableForm` called with this option takes not care about the value of `TEXTWIDTH`.

---

`c` must be a positive integer.

**Center, Left, Right**

The entries of each column are aligned left-justified, centered or justified.

**Sort**

Option, specified as `Sort = procedure`

The entries are sorted with the given procedure. Entries can be printed unsorted, when `procedure` is the object `FALSE`.

**Output**

Option, specified as `Output = file`

Output into a file. If `file` is a string, a file named `file` is opened and overwritten and closed after writing. If `file` is a file descriptor (the return value of `fopen`), the table is appended to `file` without closing `file`.

**String**

Return as a string that can be printed

The string contains line breaks, and can be printed with `print` or `fprint` and option `Unquoted`.

**Append**

Option, specified as `Append = string`

Character string is appended to each entry of the list

## **Return Values**

Void object null()

## **See Also**

### **MuPAD Functions**

fclose | fopen | fprintf | output::tree | print | sort

## output::tree

Display of trees

### Syntax

```
output::tree(Tree, <indentdepth, <charlist>, <Small>>)
```

### Description

`output::tree` displays trees given as specially MuPAD lists.

The first object of the list is the root of the tree. All further objects are nodes or subtrees of the tree. A subtree is again a special list (as described), and any other MuPAD object will be interpreted as node of the tree.

The elements of the tree will be printed by MuPAD, when the tree will be displayed, so it's recommended to use strings as objects or objects with a well defined display.

The return value is a string that contains all chars to display the tree. With functions `print` and `fprintand` the option `Unquoted` the tree can be displayed.

The parameter `charlist` is a list with five characters. The default value is `["|", "+", "- ", " ", " "]`. The characters have the following meaning (described in the order of the list).

The vertical lines of the tree, the connection between vertical and horizontal line (i.e., an arm, but not the last arm), an arm (vertical line), the last connection to an arm in a subtree, a char between an arm and the description of the arm.

### Examples

#### Example 1

`output::tree` displays special nested lists as trees:

```
TREE := ["a1", "a2", ["b1", "b2", ["c1", "c2"], "b3"],
         ["d1", "d2", "d3"]]:
print(Unquoted, output::tree(TREE))
```

```
a1
|
+-- a2
|
+-- b1
|   +-- b2
|   +-- c1
|       \-- c2
|   \-- b3
\-- d1
    +-- d2
    \-- d3
```

```
print(Unquoted, output::tree(TREE, 3, Small)):
```

```
a1
+- a2
+- b1
| +- b2
| +- c1
| | \- c2
| \- b3
\-- d1
    +- d2
    \- d3
```

The chars can be defined by the user:

```
print(Unquoted, output::tree(TREE, 6, ["|", "|", ".", "\\", " "])):
```

```
a1
```

```
| ..... a2
| ..... b1
|         | ..... b2
|         | ..... c1
|         |         | ..... c2
|         |         \ .....
|         | ..... b3
|         \ .....
| ..... d1
|         | ..... d2
|         | ..... d3
```

## Parameters

### Tree

The tree, given as a special list

### indentdepth

Indent depth for each subtree

### charlist

The chars that illustrate the tree structure

## Options

### Small

Suppresses the display of a space line between every tree entry to reduce the height of the tree

## Return Values

String object to display

## See Also

### MuPAD Functions

`adt::Tree` | `prog::exprlist` | `prog::expmtree`





# Graphics and Animations

---

## RGB::ColorNames

Find predefined colors by name

### Syntax

```
RGB::ColorNames()
```

```
RGB::ColorNames(str)
```

### Description

`RGB::ColorNames(str)` goes through the list of predefined color names in the RGB name space and returns those whose names contain the string or identifier `str` given as input.

`RGB::ColorNames()` returns all color names available in the RGB name space.

### Examples

#### Example 1

The following call returns all predefined color names containing “Olive”:

```
RGB::ColorNames("Olive")
```

```
[Olive, OliveDrab, OliveGreen, OliveGreenDark]
```

The RGB values of these colors are:

```
RGB::Olive, RGB::OliveDrab, RGB::OliveGreen,  
RGB::OliveGreenDark
```

```
[0.230003, 0.370006, 0.170003], [0.419599, 0.556902, 0.137303], [0.2, 0.2, 0.0],  
[0.333293, 0.419599, 0.184301]
```

## Parameters

**str**

A part of a color name: a string or an identifier

## Return Values

RGB::ColorNames returns a list of predefined color names.

## See Also

### **MuPAD Functions**

RGB::plotColorPalette

## RGB::plotColorPalette

Display predefined colors

### Syntax

```
RGB::plotColorPalette(str)
```

### Description

`RGB::plotColorPalette(str)` displays the colors in the RGB name space whose names contain `str`.

`RGB::plotColorPalette` uses `RGB::ColorNames` and plots samples of the colors found by this routine, in tabular fashion.

### Environment Interactions

`RGB::plotColorPalette` plots a list of color samples with names.

### Examples

#### Example 1

The following call plots all predefined colors containing "Olive":

```
RGB::plotColorPalette("Olive")
```

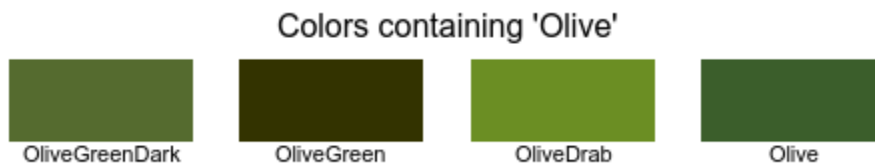

When the list of colors found gets larger, they are distributed over more lines:

```
RGB::plotColorPalette("Blue")
```

### Colors containing 'Blue'



## Parameters

### **subname**

A part of a color name: a string or an identifier

## Return Values

RGB::plotColorPalette returns the empty object, `null()`.

## See Also

### **MuPAD Functions**

RGB::ColorNames

## RGB::colorName

Find names of predefined colors

### Syntax

```
RGB::colorName(rgb, <Exact>)
```

### Description

`RGB::colorName([r, g, b])` looks for the predefined color with values closest to `[r, g, b]` and returns its name.

`RGB::colorName([r, g, b], Exact)` looks for a predefined color with values exactly `[r, g, b]` and returns its name.

The RGB namespace contains predefined color names, accessible as `RGB::Blue` etc. `RGB::colorName` performs a reverse lookup, finding the name of a color given as RGB values.

Since rather often, colors will stem from calculations with floating-point numbers, no exact matches can be expected in this reverse lookup. Therefore, by default, `RGB::colorName` will perform a “fuzzy” search, returning the predefined color which is closest (in Euclidean distance in RGB space) to the input. Cf. “Example 2” on page 24-9 (Symbolic Math Toolbox).

### Examples

#### Example 1

`RGB::colorName` returns the symbolic name of predefined colors:

```
RGB::colorName([0, 1, 0])
```

`RGB::Green`



```
RGB::colorName([0, 1, 0, 0.5])
```

```
RGB::Green.[0.5]
```

## Example 2

When performing calculations on color values, the results will rarely be exact, even if the unavoidable round-off errors are too small to be displayed on the screen:

```
a := RGB::Olive;  
b := RGB::fromHSV(RGB::toHSV(RGB::Olive))
```

```
[0.230003, 0.370006, 0.170003]
```

```
[0.230003, 0.370006, 0.170003]
```

```
bool(a = b)
```

```
FALSE
```

Therefore, `RGB::colorName` by default searches in a “fuzzy” fashion:

```
RGB::colorName(a);  
RGB::colorName(b)
```

```
RGB::Olive
```

```
RGB::Olive
```

In cases where this is undesirable, the option `Exact` can be used to switch to exact searching:

```
RGB::colorName(a, Exact);  
RGB::colorName(b, Exact)
```

```
RGB::Olive
```

## FAIL

The predefined color names do not fill RGB space uniformly, therefore, the color found by `RGB::colorName` may be quite different from the one entered. The following plot shows the predefined colors in RGB space:

```
plot(plot::Scene3d(  
  plot::PointList3d([c.[c] $ c in RGB::ColorList]),  
  ZXRatio = 1, BackgroundStyle = TopBottom,  
  BackgroundColor = RGB::Grey,  
  BackgroundColor2 = RGB::White,  
  Margin=0))
```

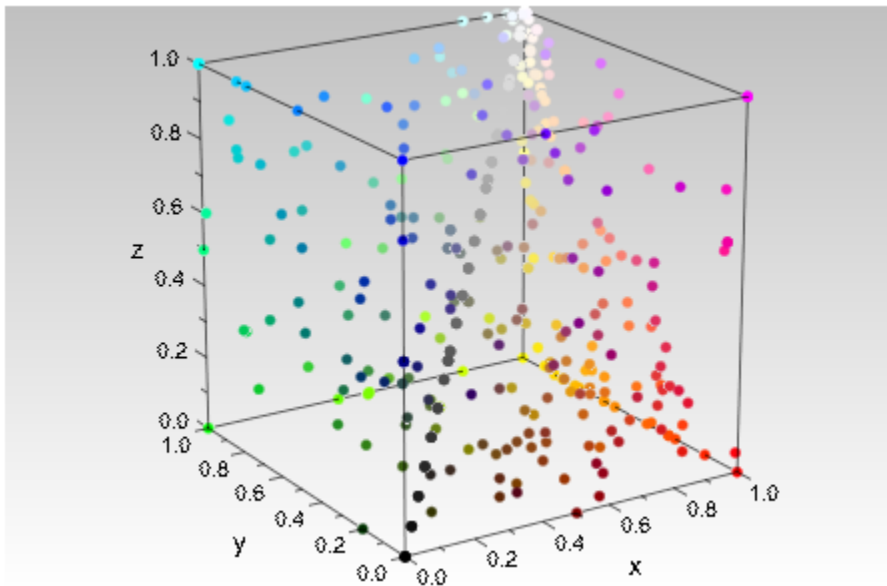

## Parameters

### rgb

An RGB or RGBA color specification: A list of three or four real numbers in the interval  $[0, 1]$ .

## Options

### Exact

Only return an exact match, FAIL if none exists.

## Return Values

If a color was found, RGB::colorName returns an expression of the form RGB::Name or RGB::Name.[a]. If given Exact and no match was found, FAIL is returned. If given symbolic input parameters, an unevaluated call is returned.

## See Also

### MuPAD Functions

RGB

## RGB::fromWaveLength

Get the RGB color of monochromatic light

### Syntax

```
RGB::fromWaveLength( $\lambda$ , < $\gamma$ >)
```

### Description

`RGB::fromWaveLength(  $\lambda$  )` returns an approximative RGB specification for light of wavelength  $\lambda$  *nm*.

Light consists of photons, each of which has a distinct wavelength. These different wavelengths cause color perception. `RGB::fromWaveLength` calculates an RGB triple corresponding to a given wave length.

Different displays show the same RGB color in slightly different ways. For this reason, the so-called “gamma correction” has been invented. `RGB::fromWaveLength` accepts a second argument, for fine-tuning the assumed gamma correction that enters the calculation.

Color perception depends on a number of factors, including individual differences. Therefore, such a calculation can only return an approximation. `RGB::fromWaveLength` uses the model published by Dan Bruton for the conversion.

For wavelengths outside the visible spectrum (which ranges from 380 *nm* to 780 *nm*), `RGB::fromWaveLength` returns black.

## Examples

### Example 1

White light, when sent through a prism, is split into the commonly known spectrum, because the prism refracts different wavelengths differently. This spectrum can easily be reproduced by `RGB::fromWaveLength`:

```
plot(plot::Raster([[RGB::fromWaveLength(i) $ i=380..780]]),
      Scaling = Unconstrained, Height = 20)
```



### Example 2

Bruton's conversion model looks like this:

```
plotfunc2d(
  plot::Raster([[RGB::fromWaveLength(i) $ i = 380..780]],
    x = 380..780, y = -0.2..0),
  (x -> RGB::fromWaveLength(x)[i]) $ i = 1..3,
  x = 380..780,
  Colors = [RGB::Red, RGB::Green, RGB::Blue],
  LegendVisible = FALSE,
  XTicksNumber = Low,
  Scaling = Unconstrained,
  Axes = Automatic)
```

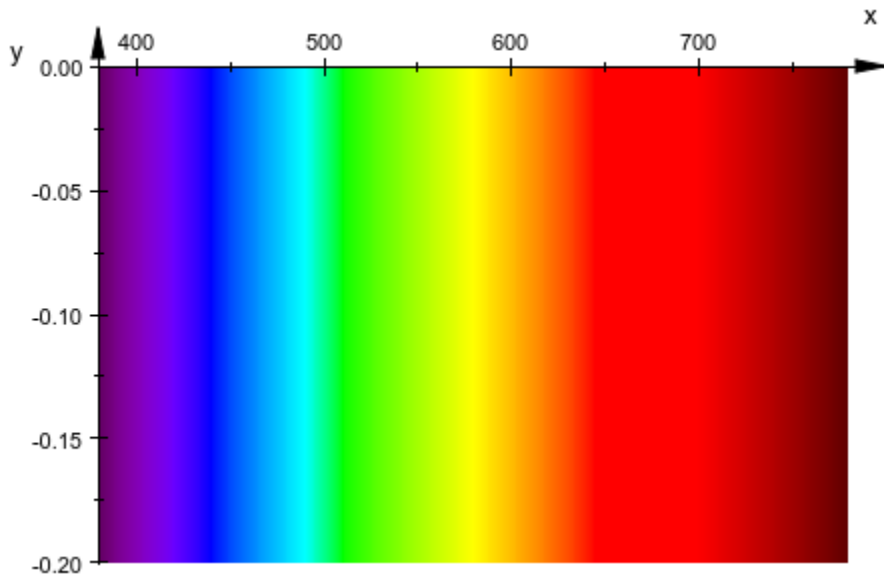

## Parameters

$\lambda$

The wavelength: a real-valued constant (interpreted as nanometers) or a length unit on page 1-2196

$\gamma$

The “gamma correcture” for the display, defaults to 0.8

## Return Values

RGB color: a list of three floating-point values

## See Also

### MuPAD Functions

RGB | RGB::fromHSV

## RGB::random

Pick a color uniformly at random in RGB color space

### Syntax

```
RGB::random()
```

### Description

`RGB::random()` returns a random color. The colors returned are distributed independently and uniformly in the RGB color space.

### Examples

#### Example 1

`RGB::random` can be used to produce high-frequency noise:

```
plot(plot::Raster([[RGB::random() $ x = 0..42] $ y = 0..42]))
```



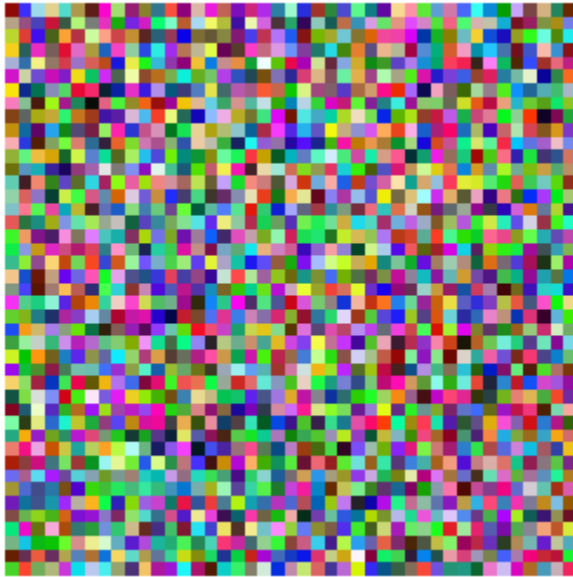

## Example 2

It is possible to use `RGB::random` directly as a color function, but the result may be unexpected:

```
plot(plot::Waterman(5, FillColorFunction = RGB::random))
```

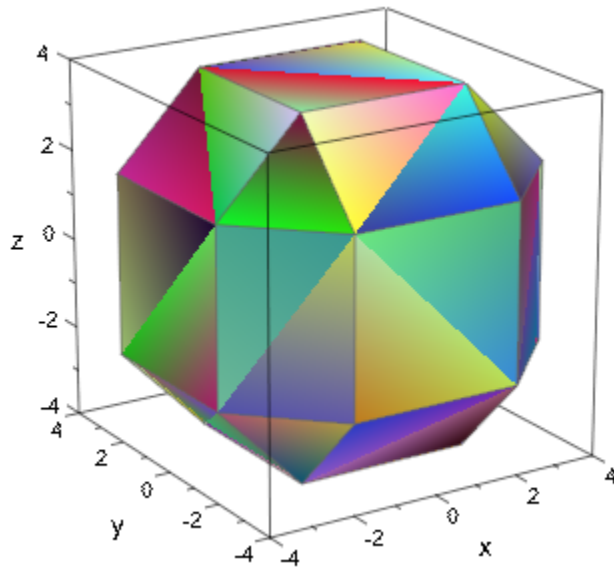

The reason is that the color function will be called repeatedly if the same point is met again. It is a better idea to create a bunch of random colors and then use the parameters passed into the color functions to get some consistency into the choice of colors:

```
colors := [RGB::random() $ i = 1..42]:  
plot(plot::Waterman(5, FillColorFunction=((x,y,z,i) -> colors[i])))
```

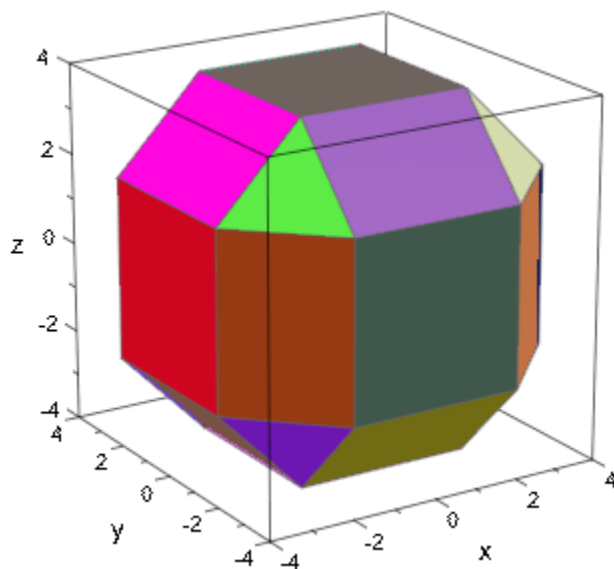

## Return Values

RGB color: A list of three floating-point values.

## See Also

### MuPAD Functions

RGB | frandom

## RGB::toHSV

Convert RGB colors to HSV

### Syntax

```
RGB::toHSV([r, g, b, <a>])
```

### Description

`RGB::toHSV( RGBcolor )` returns `RGBcolor` expressed in HSV values, with hue in the range `0..360` (in degrees) and saturation and value in the range `0..1`.

### Examples

#### Example 1

Apart from the RGB model, there are various other popular color formats used in computer graphics. One is the HSV model (Hue, Saturation, Value). The RGB library provides the routines `RGB::fromHSV` and `RGB::toHSV` to convert HSV colors to RGB colors and vice versa:

```
hsv := RGB::toHSV( RGB::Orange )
```

```
[24.0, 1.0, 1.0]
```

```
RGB::fromHSV( hsv ) = RGB::Orange
```

```
[1.0, 0.4, 0.0] = [1.0, 0.4, 0.0]
```

## Parameters

**r, g, b**

The red, green, and blue contributions of an RGB color: numerical values between 0 and 1.

**a**

The translucency (alpha) value: a numerical value between 0 and 1.

## Return Values

A list with three or four floating-point values, depending on whether **a** is given in the input.

## See Also

### **MuPAD Functions**

RGB::fromHSV

## RGB::fromHSV

Convert HSV colors to RGB

### Syntax

```
RGB::fromHSV([h, s, v, <a>])
```

### Description

`RGB::fromHSV(HSVcolor)` converts color coordinates in HSV to the corresponding RGB color.

`RGB::fromHSV(HSVcolor)` is the inverse of `RGB::toHSV`.

### Examples

#### Example 1

With the `RGB::fromHSV` utility, all colors in a MuPAD graphics can be specified easily as HSV colors. For example, the color “violet” is given by the HSV values `[290, 0.4, 0.6]`, whereas “dark green” is given by the HSV specification `[120, 1, 0.4]`. Hence, a semi-transparent violet sphere intersected by an opaque dark green plain may be specified as follows:

```
plot(plot::Sphere(1, [0, 0, 0],
                  Color = RGB::fromHSV([290, 0.4, 0.6]).[0.5]),
      plot::Surface([x, y, 0.5], x = -1 .. 1, y = -1 .. 1,
                    Mesh = [2, 2],
                    Color = RGB::fromHSV([120, 1, 0.4]))
):
```

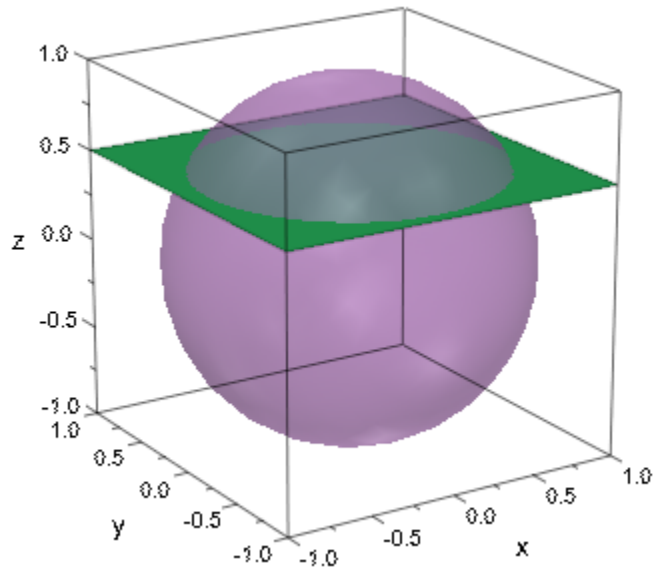

## Example 2

There are numerous ways of displaying complex-valued functions of a complex argument. For example, see `plot::Conformal`. One of these is to use a color scheme that interprets the complex plane as a section through HSV color space at a fixed value, for example, 1. To plot this scheme in MuPAD, use `plot::Density` providing the following color function:

```
f_color := (x, y, fz, a) ->
    RGB::fromHSV([180/float(PI)*arg(fz), abs(fz), 1]):
```

The identity function is thus shown as follows:

```
plot(plot::Density((x, y) -> x + I*y, x = -1..1, y = -1..1,
    XMesh = 50, YMesh = 50,
    FillColorFunction = f_color))
```

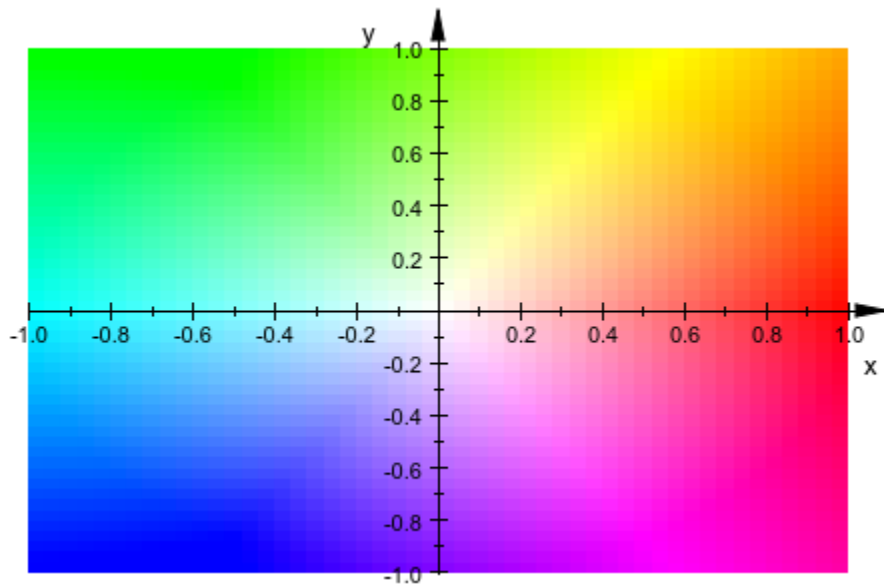

$z \rightarrow z^2$  doubles the argument of a complex function, resulting in the following picture:

```
plot(plot::Density((x, y) -> (x + I*y)^2, x = -1..1, y = -1..1,  
  XMesh = 50, YMesh = 50,  
  FillColorFunction = f_color))
```



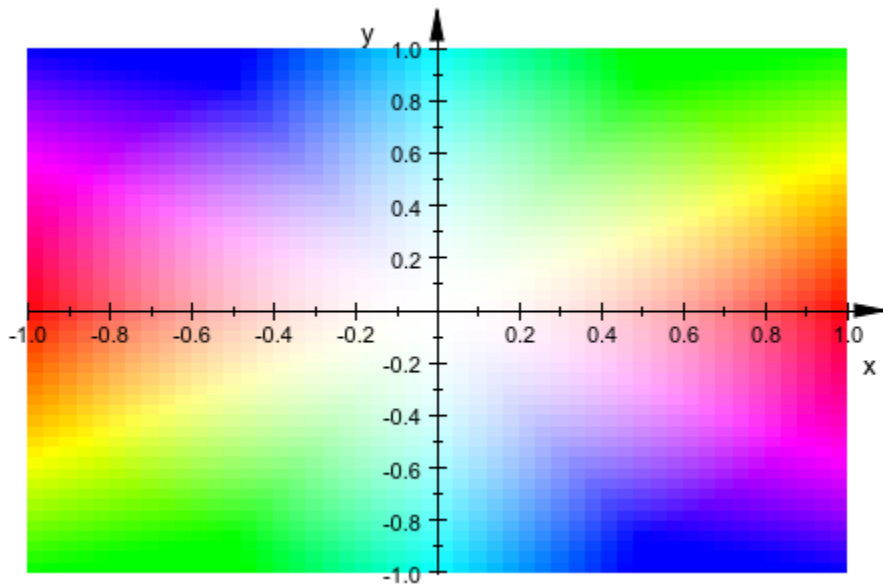

To plot the complex sine function, choose a larger rectangle because the sine is too similar to the identity in small neighborhoods of the origin to be of interest:

```
plot(plot::Density((x, y) -> sin(x + I*y), x = -2..2, y = -2..2,  
  XMesh = 50, YMesh = 50,  
  FillColorFunction = f_color))
```

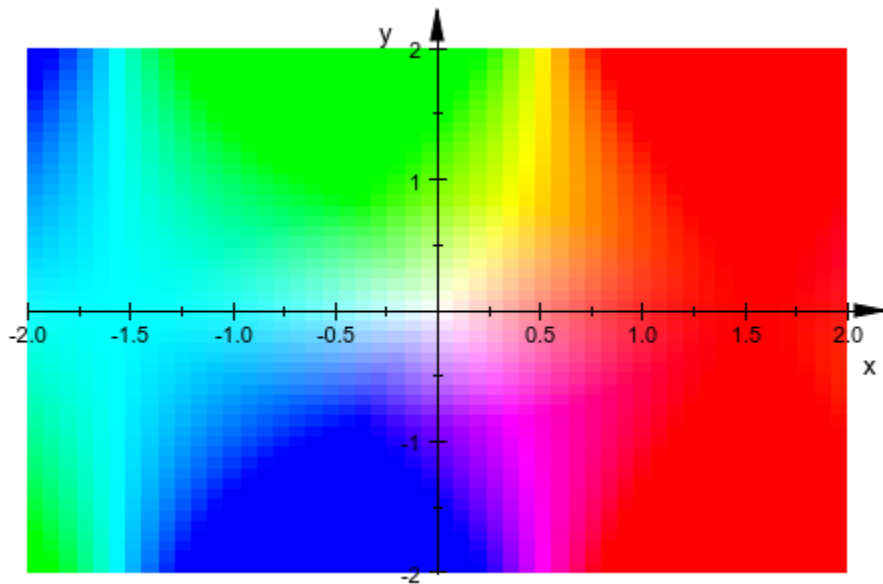

$z \rightarrow z^{4/3}$  is clearly discontinuous along the negative real axis:

```
plot(plot::Density((x, y) -> (x + I*y)^(4/3),  
  x = -1..1, y = -1..1,  
  XMesh = 50, YMesh = 50,  
  FillColorFunction = f_color))
```

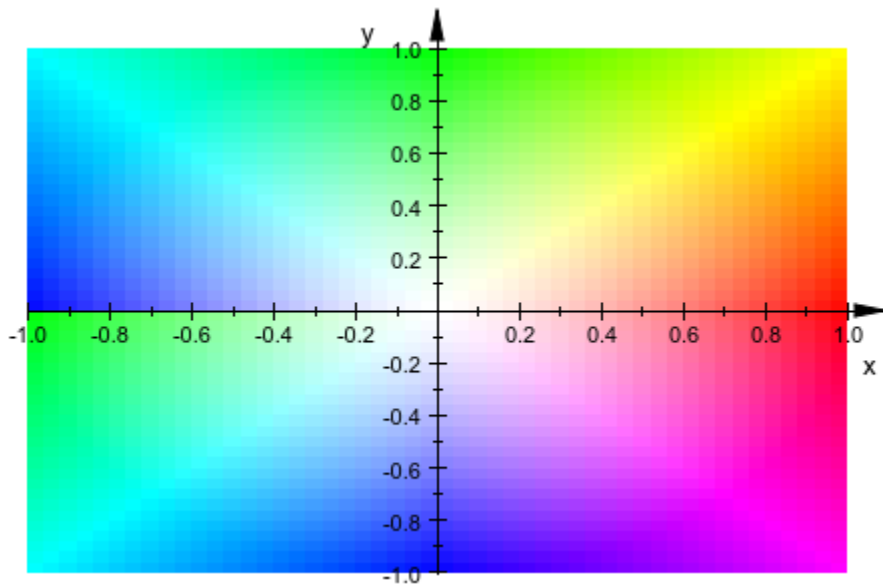

## Parameters

**a**

The translucency (alpha) value: a numerical value between 0 and 1.

**h**

The “hue” in an HSV specification: a numerical value between 0 and 360

**s**

The “saturation” in an HSV specification: a numerical value between 0 and 1

**v**

The “value” in an HSV specification: a numerical value between 0 and 1

## **Return Values**

A list with three or four floating-point values, depending on whether `a` is given in the input.

## **See Also**

### **MuPAD Functions**

`RGB::toHSV`

# plot::easy

Easy plotting

## Syntax

```
plot::easy(<arg, ...>, options)
```

## Description

`plot::easy( arg , <options>, ...)` transforms data and expressions into graphical objects.

`plot::easy` accepts graphical objects and graphical attributes as input and returns them unchanged.

`plot::easy` supports the options listed above. Additionally, it accepts arbitrary data and expressions and tries to transform them into valid graphical objects.

`plot::easy` supports the option `Colors=[c1,...c2]` for automatically coloring newly generated graphical objects. The given list is used instead of the internally defined default color list.

`plot::easy` accepts the options `Mesh` and `Submesh` and uses them for each newly generated graphical object.

The function `plot` calls `plot::easy` for preprocessing its input before plotting.

`plot::easy` tries to handle standard situations intuitively in order to make plotting as easy as possible. However, it supports only a small subset of the graphical objects, attributes and expressions available in MuPAD and thus does not claim to be complete.

Users that want to plot other objects or control specific details of their graphics explicitly, still have to create their graphical objects manually, e.g. using `plot::Function2d` and `plot::Point2d`, and to use graphical attributes like `LineStyle =Dashed` directly.

`plot::easy` sets a new color for each object that it creates, if no color is predefined in the given context.

`plot::easy` accepts sets `{...}` as group definition and transforms them into graphical objects of type `plot::Group2d(...)` or `plot::Group3d(...)`, respectively. All elements of a group share the same color, if colors were not specified explicitly for single objects. Note that, regular graphical objects usually have a predefined color.

`plot::easy` accepts a nested set `{{...}}` as scene definition and transforms it into the graphical object `plot::Scene2d(...)` or `plot::Scene3d(...)`, respectively.

Creating a graphical object may require the specification of value ranges for variables. If they are not specified explicitly then `plot::easy` tries use ranges specified for other variables and/or uses the default value range `-5..5`.

## Examples

### Example 1

`plot::easy` tries to transform all given data and expressions into valid graphical objects and attributes:

```
plot::easy(sin(x), [PI/2,1])
```

```
plot::Function2d(sin(x), x = -5..5),
```

```
plot::Point2d( $\frac{\pi}{2}$ , 1, PointColor = RGB::Red, LegendText = "[PI/2, 1]")
```

Since the function `plot` calls the function `plot::easy` for preprocessing its input data, scenes like above can directly be plotted using `plot`:

```
plot(sin(x), [PI/2,1], #x = PI/2, #y = 1)
```

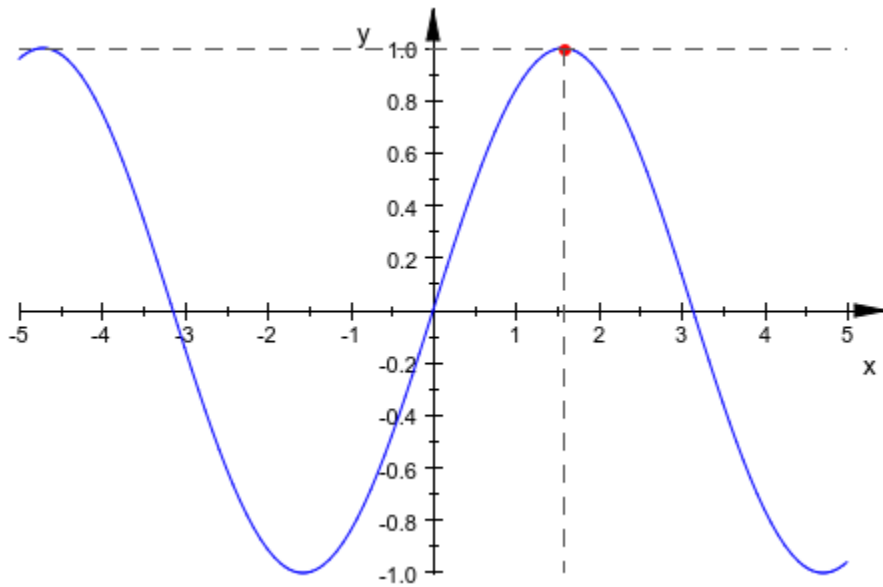

Now, it is only a small step to animate this scene:

```
plot(sin(x), {[x,sin(x)], #Points}, #x = x, #y = sin(x))
```

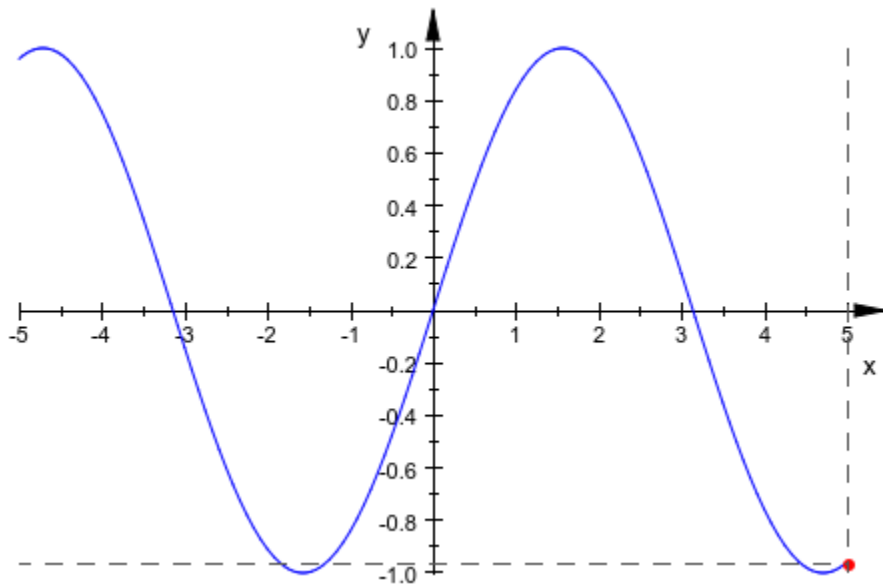

Note: Graphical objects and attributes, as well as data that `plot::easy` cannot transform, are returned unchanged:

```
plot::easy(x, plot::Point2d(1,1), LineStyle=Dashed, "UnknownObject")
```

```
plot::Function2d(x, x = -5..5), plot::Point2d(1, 1), LineStyle = Dashed, "UnknownObject"
```

This is why `plot` returns the following error message when it is executed with the above arguments:

```
plot(x, plot::Point2d(1,1), LineStyle=Dashed, "UnknownObject");
```

```
Error: Invalid arguments '"UnknownObject"'. [plot::Canvas::new]
```

## Example 2

Points can be entered as lists with two or three values. Alternatively, a corresponding column vector in combination with the option `#Points` (alias `#P`, see “Example 18” on page 24-62 (Symbolic Math Toolbox)) can be used.



Note that for plotting animated points the option `#Points` is required. Otherwise a curve (when entered a list) or an arrow (when entered a vector) is plotted:

```
plot([0,1], [s,s^2], {[s,s^2], #Points}, s = -2..2,
      matrix([t,t^2]), {matrix([t,t^2]), #Points}, t = 2..-2
)
```

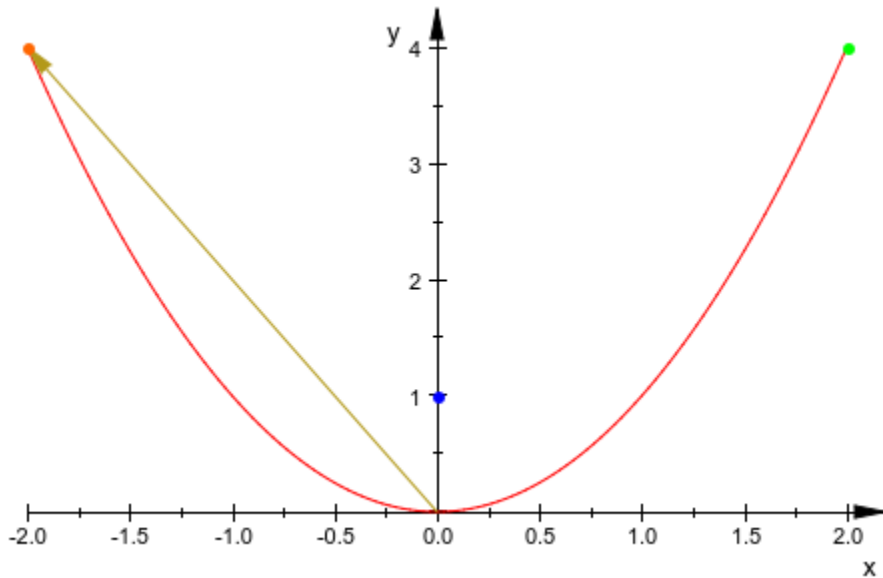

See also: `plot::Point2d`, `plot::Point3d`.

### Example 3

Arrows can be specified as column vectors with two or three elements. Alternatively, a list in combination with the option `#Arrows` (alias `#A`, see “Example 13” on page 24-57 (Symbolic Math Toolbox)) can be used:

```
plot(matrix([0,1]), matrix([s,s^2]), s = 2..-2,
      [t,t^2], {[t,t^2], #Arrows}, t = -2..2
)
```

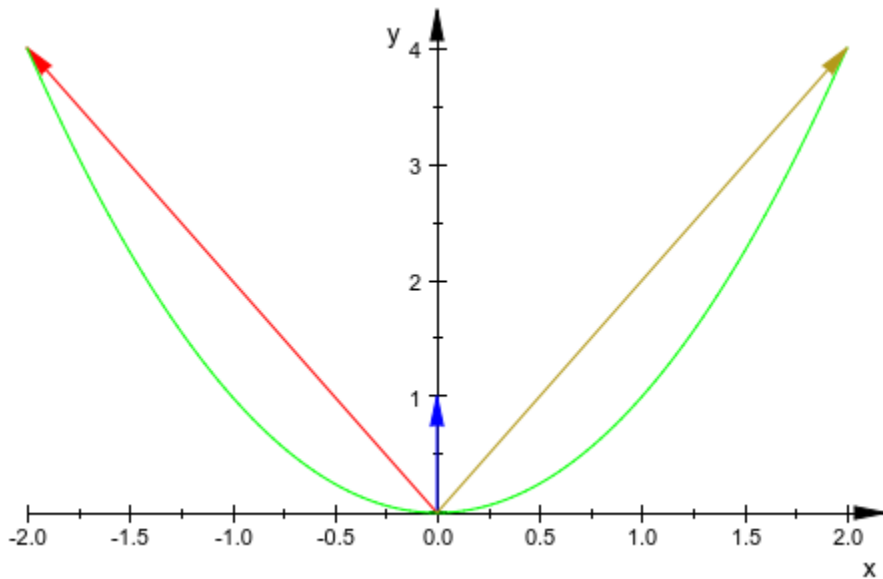

If an arrow should start at coordinates other than (0,0) or (0,0,0), respectively, then a list of two column vectors or a corresponding list of lists in combination with the option `#Arrows` (alias `#A`, see “Example 13” on page 24-57 (Symbolic Math Toolbox)) can be used:

```
u := matrix([3,2]):
v := matrix([1,4]):
w := (1-a)*u + a*v:
u, v, w;
```

$$\begin{pmatrix} 3 \\ 2 \end{pmatrix}, \begin{pmatrix} 1 \\ 4 \end{pmatrix}, \begin{pmatrix} 3-2a \\ 2a+2 \end{pmatrix}$$

```
plot(u, v, [u,w], a = 0.1..1, #Arrows)
```

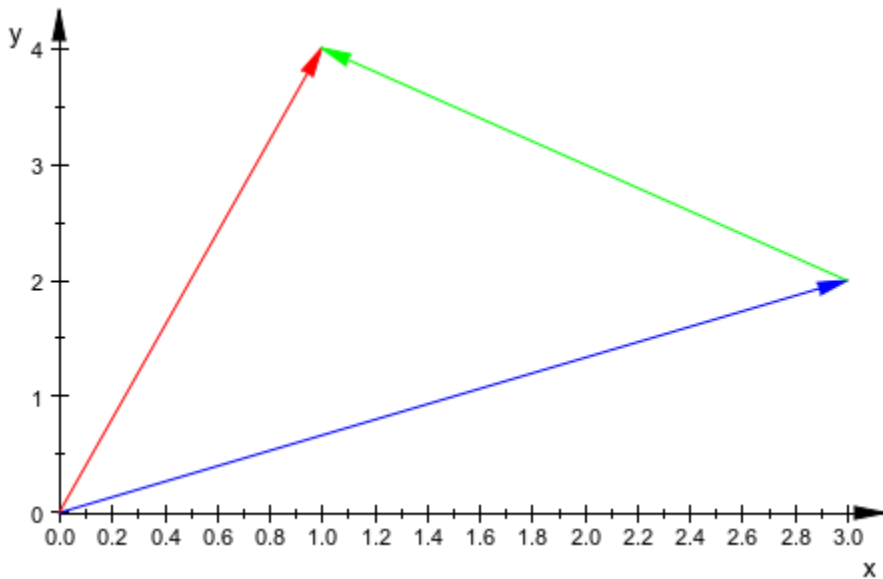

`delete u, v, w:`

See also: `plot::Arrow2d`, `plot::Arrow3d`.

## Example 4

Polygons can be specified as lists, tables or matrices. In the following example, polygons are plotted using different input styles. The option `#Origin` (alias `#0`, see “Example 17” on page 24-61 (Symbolic Math Toolbox)) ensures that the origin of the coordinate system is visible in the scene as well:

```
plot([[1,3],[2,5],[3,3],[4,8]],
      table(1=4,2=6,3=4,4=9),
      [matrix([1,5]),matrix([2,7]),matrix([3,5]),matrix([4,10])],
      matrix([[1,6],[2,8],[3,6],[4,11]]),
      #Origin)
```

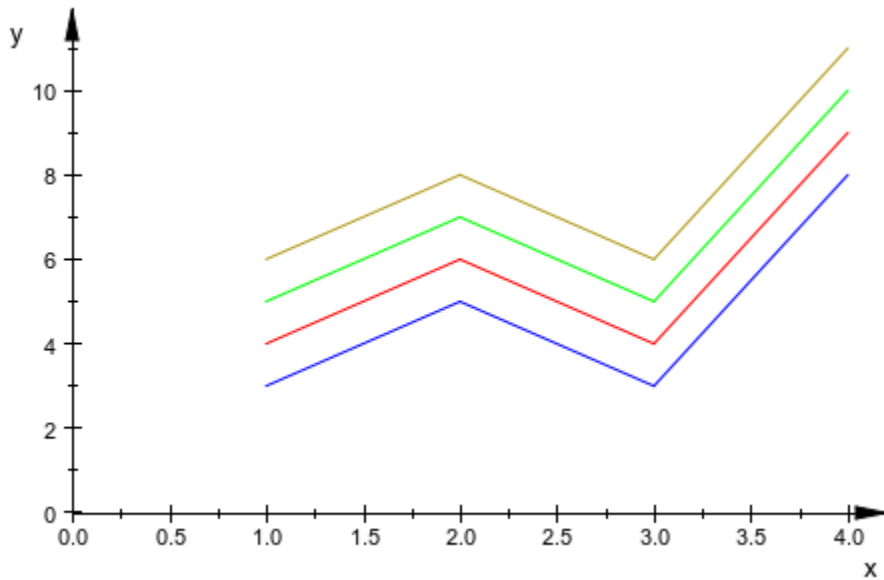

Note that polygons are displayed as points when option `#Points` (alias `#P`, see “Example 18” on page 24-62 (Symbolic Math Toolbox)) is used:

```
plot([[1,3],[2,5],[3,3],[4,8]],  
     table(1 = 4,2 = 6,3 = 4,4 = 9),  
     [matrix([1,5]),matrix([2,7]),matrix([3,5]),matrix([4,10])],  
     matrix([[1,6],[2,8],[3,6],[4,11]]),  
     #Points, #Origin)
```

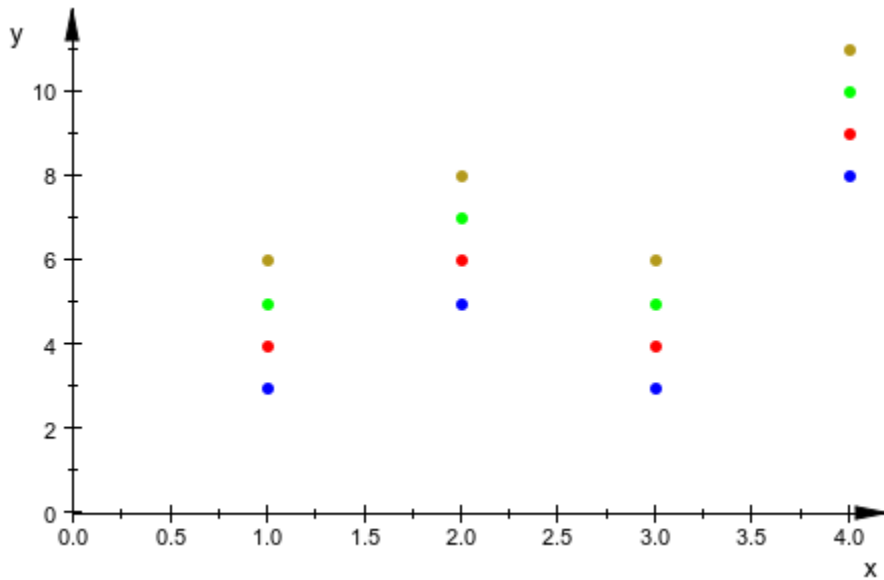

Note that the following polygons with two elements are displayed as arrows when option `#Arrows` (alias `#A`, see “Example 13” on page 24-57 (Symbolic Math Toolbox)) is used:

```
plot([[1,4],[2,6]],  
      [matrix([1,5]),matrix([2,7])],  
      matrix([[1,6],[2,8]]),  
      #Arrows, #Origin)
```

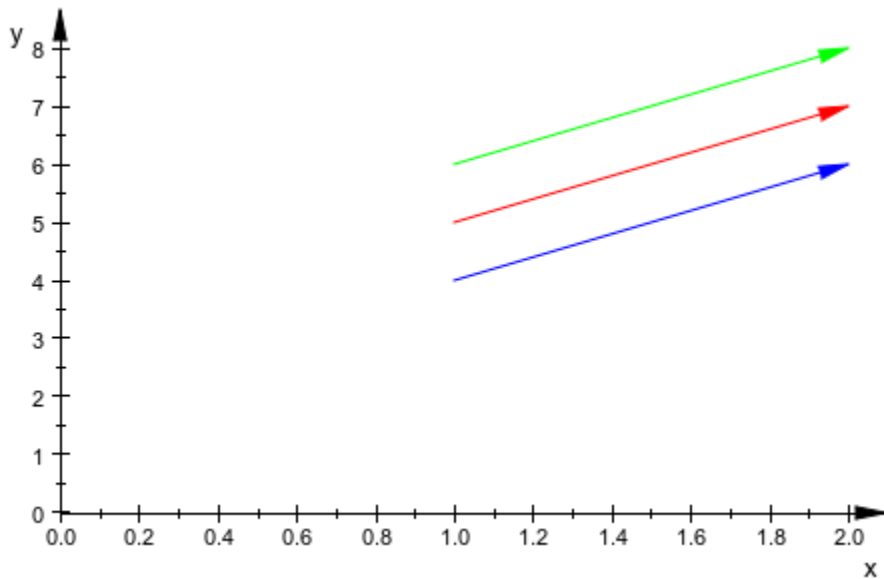

See also: `plot::Polygon2d`, `plot::Polygon3d`.

### Example 5

Point lists can be specified as lists, tables or matrices. For each point an RGBa color has to be specified. In the following example, point lists are plotted using different input styles. The option `#Origin` (alias `#0`, see “Example 17” on page 24-61 (Symbolic Math Toolbox)) ensures that the origin of the coordinate system is visible in the scene as well:

```
plot([[1,2,RGB::Red], [2,4,[0,1,0]], [3,3,[0,0,1,0.5]]],
      [matrix([1,3,RGB::Red]), matrix([2,5,[0,1,0]]),
       matrix([3,4,[0,0,1,0.5]])],
      matrix([[1,4,RGB::Red], [2,6,[0,1,0]],[3,5,[0,0,1,0.5]]]),
      table(1=[5,RGB::Red], 2=[7,[0,1,0]], 3=[6,[0,0,1,0.5]]),
      #Origin)
```

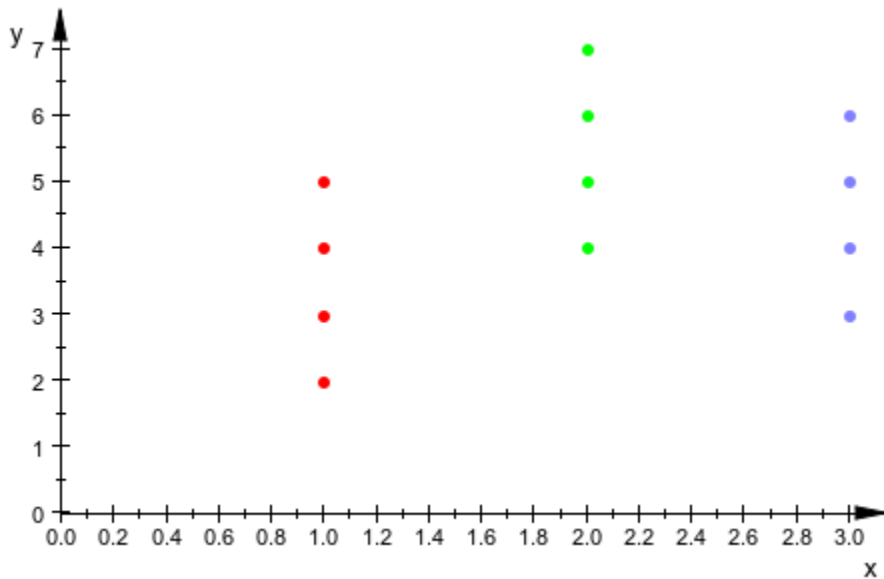

Note that the following point lists are displayed as arrows when option `#Arrows` (alias `#A`, see “Example 13” on page 24-57 (Symbolic Math Toolbox)) is used:

```
plot([[1,2,RGB::Red], [2,4,[0,1,0]] ,[3,3,[0,0,1,0.5]]],
      [matrix([1,3,RGB::Red]), matrix([2,5,[0,1,0]]),
       matrix([3,4,[0,0,1,0.5]])],
      matrix([[1,4,RGB::Red], [2,6,[0,1,0]], [3,5,[0,0,1,0.5]]]),
      table(1=[5,RGB::Red], 2=[7,[0,1,0]] ,3=[6,[0,0,1,0.5]]),
      #Arrows, #Origin)
```

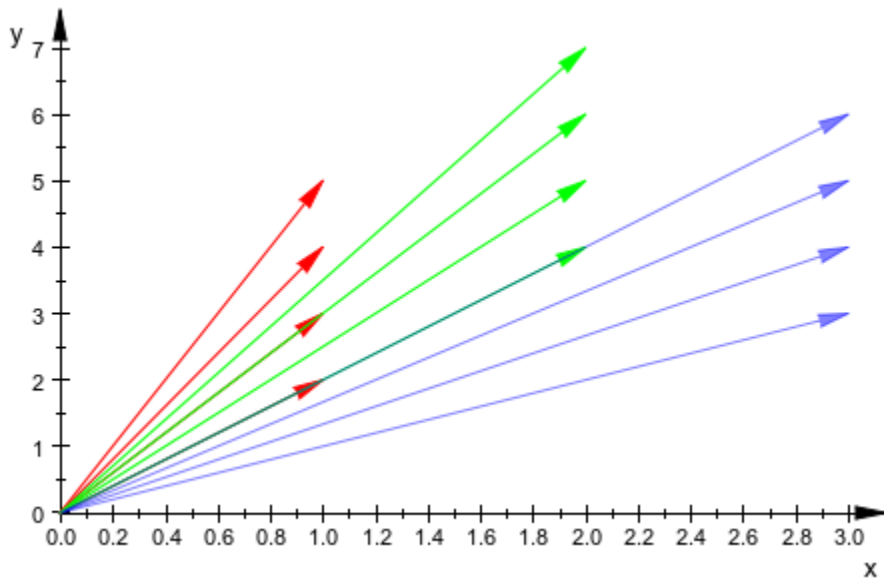

See also: `plot::PointList2d`, `plot::PointList2d`.

### Example 6

For drawing horizontal and vertical infinite lines, the short syntax `#x = e` and `#y = e` with `e` is a real expression, can be used:

```
plot(sin(x), [PI/2,1], #x=PI/2, #y=1, #Legend)
```



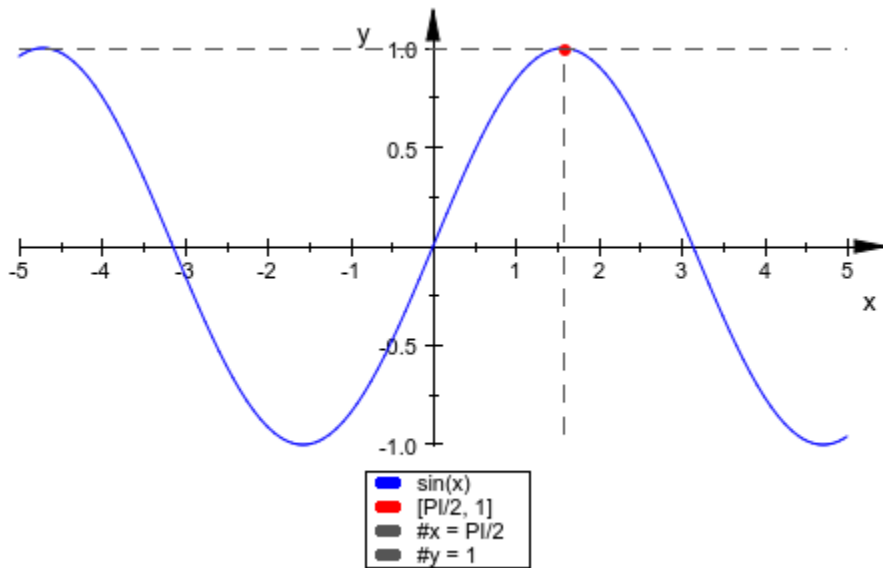

For drawing horizontal and vertical infinite planes, the short syntax  $\#x = e$ ,  $\#y = e$  and  $\#z = e$ , with  $e$  is a real expression, can be used.

Both, lines and planes can also be animated:

```
plot([t,0,t^2], {[t,0,t^2], #Points}, #x=t, #z=t^2, #Legend)
```

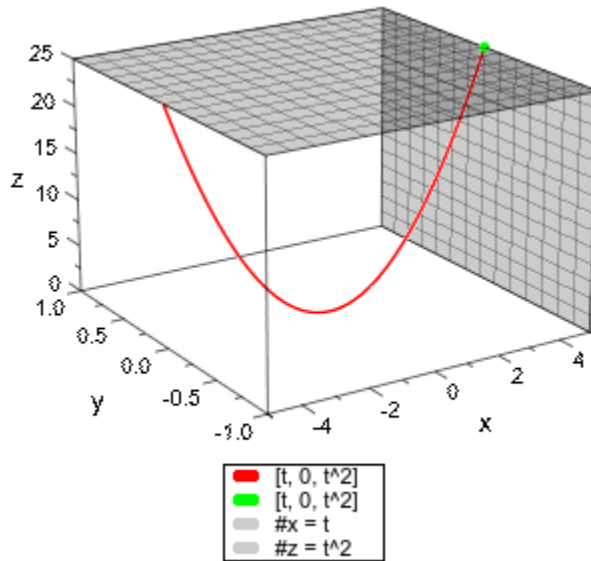

See also: `plot::Line2d`, `plot::Plane`.

## Example 7

A curve can be specified as list with two or three elements, where at least one element depends on a free variable. If option `#Points` (alias `#P`, see “Example 18” on page 24-62 (Symbolic Math Toolbox)) is set, then instead of a curve, an animated point is plotted that moves along the curve.

```
plot([t,sin(t)], {[t,sin(t)], #Points}, t=0..2*PI)
```

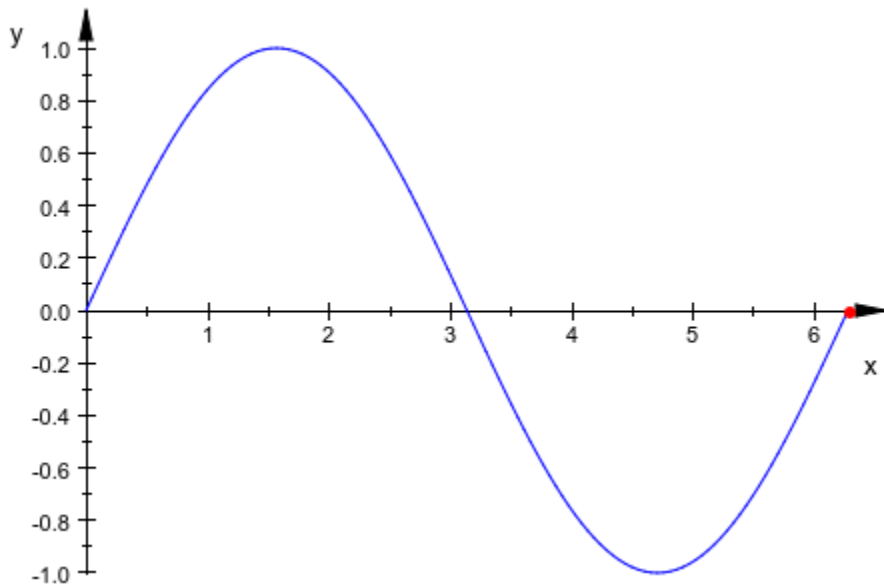

See also: `plot::Curve2d`, `plot::Curve3d`.

## Example 8

`plot::easy` tries to transform expressions that are no lists, sets, matrices, equations or inequalities into graphs of 2D or 3D functions. We plot some graphs of 2D functions:

```
plot(sin(x), tan(x), x)
```

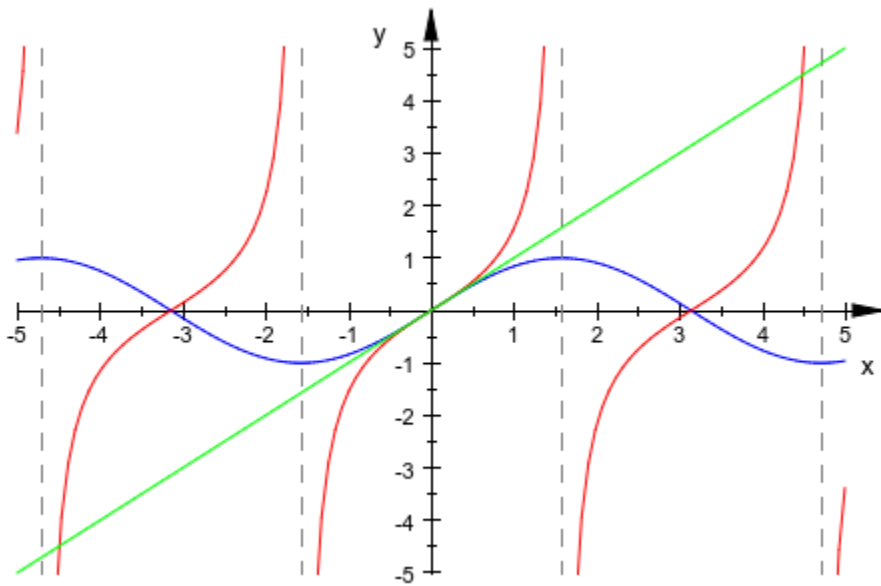

We plot a simple 3D function. Note that the option `#3D` (alias `#3`, see “Example 12” on page 24-54 (Symbolic Math Toolbox)) is required in the following example for plotting a 3D function. Otherwise, an animated 2D function is created.

```
plot(m*x, #3D)
```

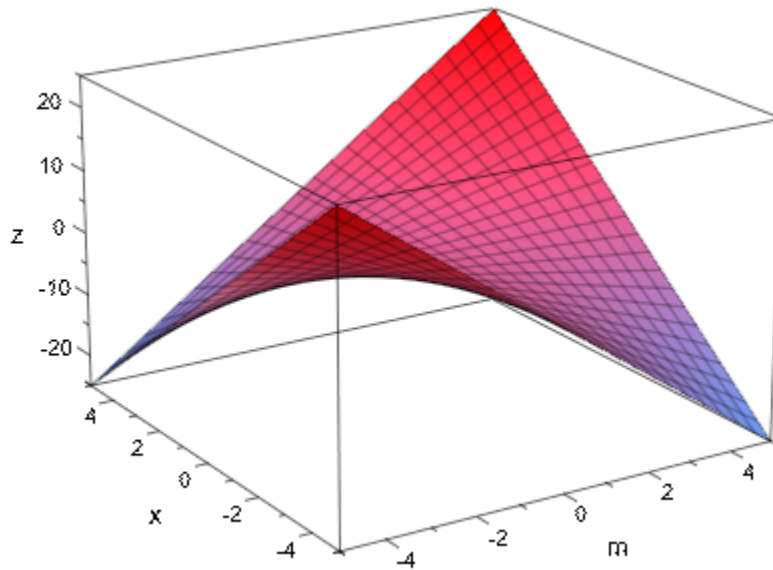

We plot a simple 2D animation: a point and the corresponding tangent of the sine function move along the sine function graph:

```
f:= x -> sin(x):  
plot(f(x), x = -PI..PI,  
      {[a, f(a)], #Points}, f'(a)*(x-a) + f(a), a = -PI/2..PI/2)
```

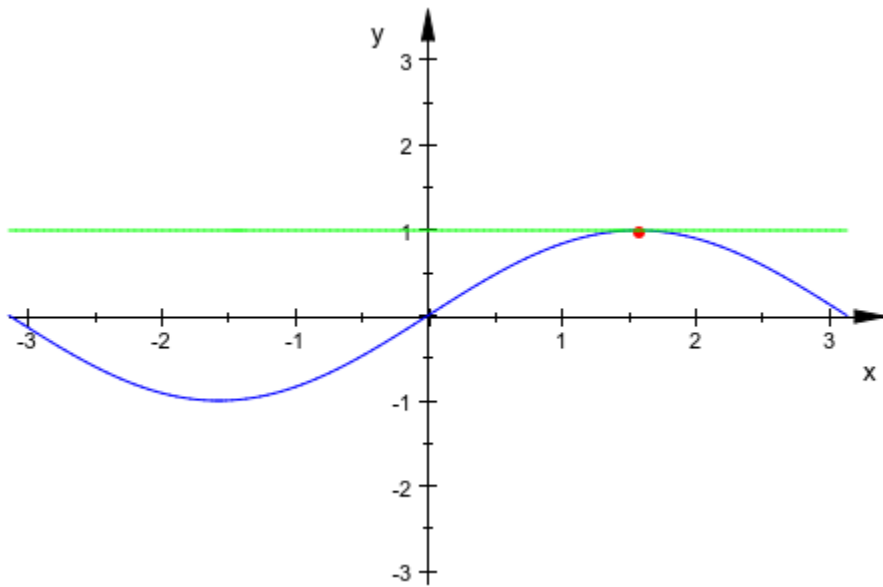

We plot a piecewise defined function:

```
plot(piecewise([x < 1, -x^2 + 1], [x >= 1, x + 5]), #x=1, #Legend)
```

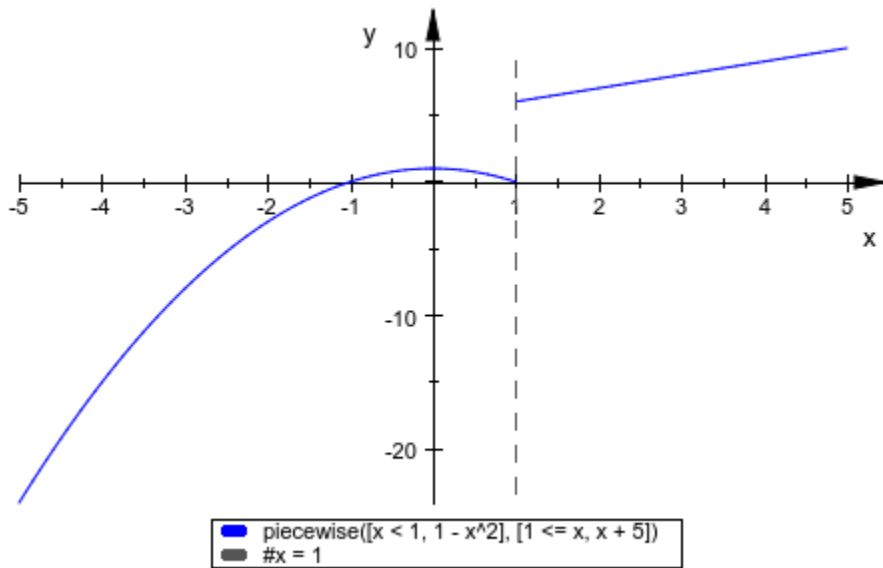

The same piecewise defined function is now written in a shorter syntax. Note the difference between defining one function with two branches (left) and defining two functions (right):

```
plot({{[x < 1, -x^2 + 1], [x >= 1, x + 5]}, #x=1}},
     {{ [x < 1, -x^2 + 1], [x >= 1, x + 5] , #x=1}},
     #Legend)
```

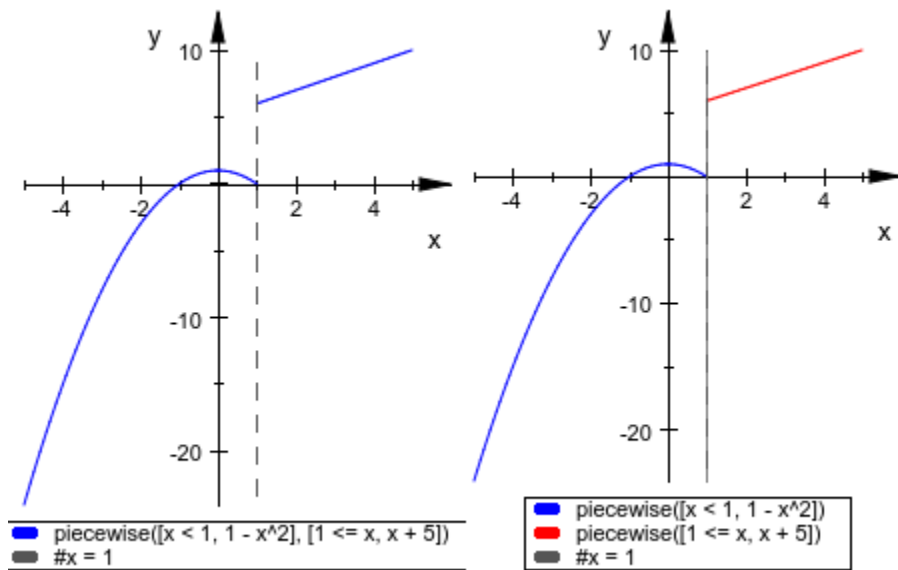

See also: `plot::Function2d`, `plot::Function3d`.

### Example 9

An implicit function can be specified as an equation:

```
plot(u^5 + x^2 = 1 - u^3)
```



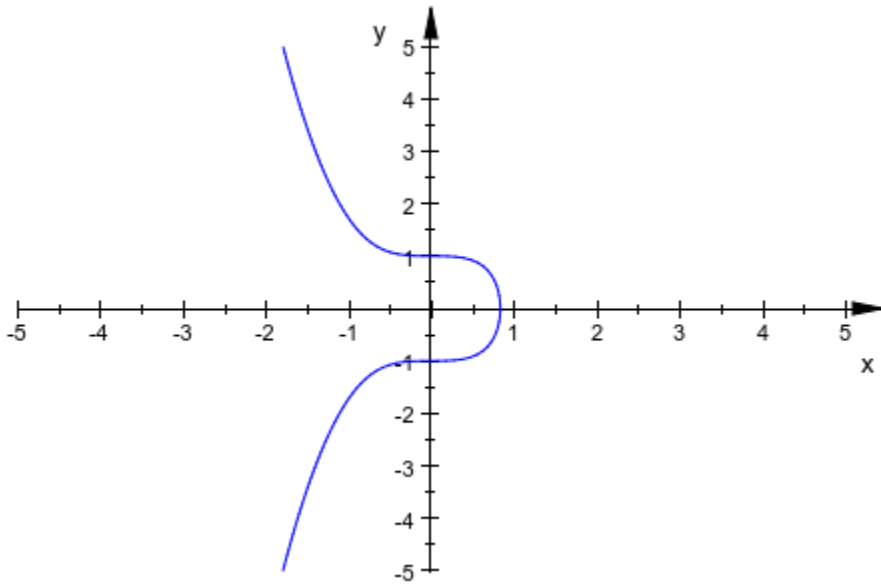

Note that the option #3D (alias #3, see “Example 12” on page 24-54 (Symbolic Math Toolbox)) may be required to plot planes given as cartesian equations. Otherwise, an animated 2D graph might be created. This depends on the number of variable of the equation.

```
E1:= 2*x + 30*y - 2*z = 5:  
E2:= -x + 7*y - z = 12:  
E3:= -4*x + 2*y + z = 0:  
plot(E1, E2, E3, #3D, #Legend)
```

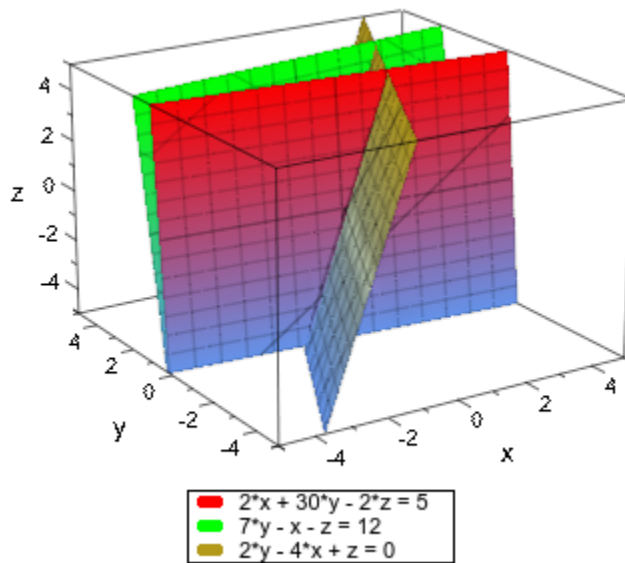

`delete E1, E2, E3:`

See also: `plot::Implicit2d`, `plot::Implicit3d`.

### Example 10

An inequality can be displayed directly:

`plot(u^5+x^2 < 1-u^3)`

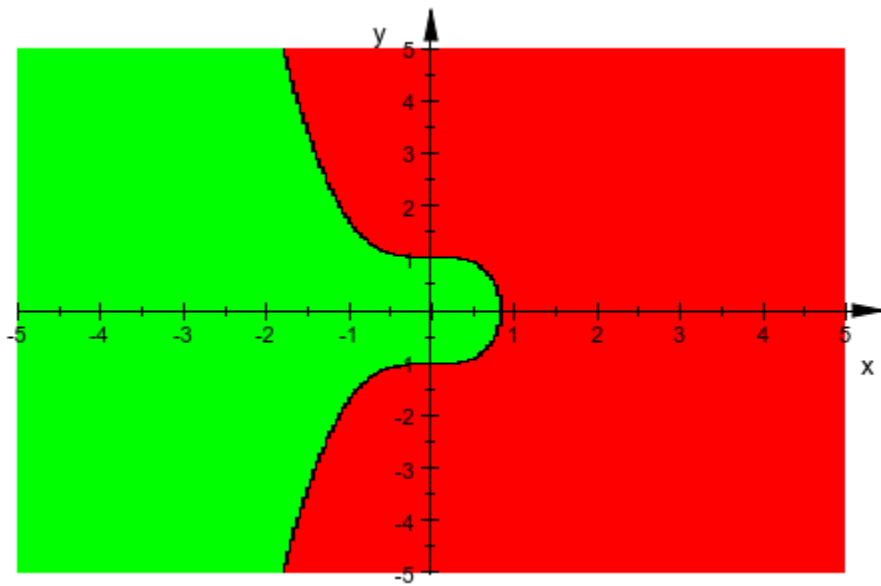

The same is true for a list of inequalities and equations:

```
plot([x < 3, x > 1, y < 4, y > -4])
```

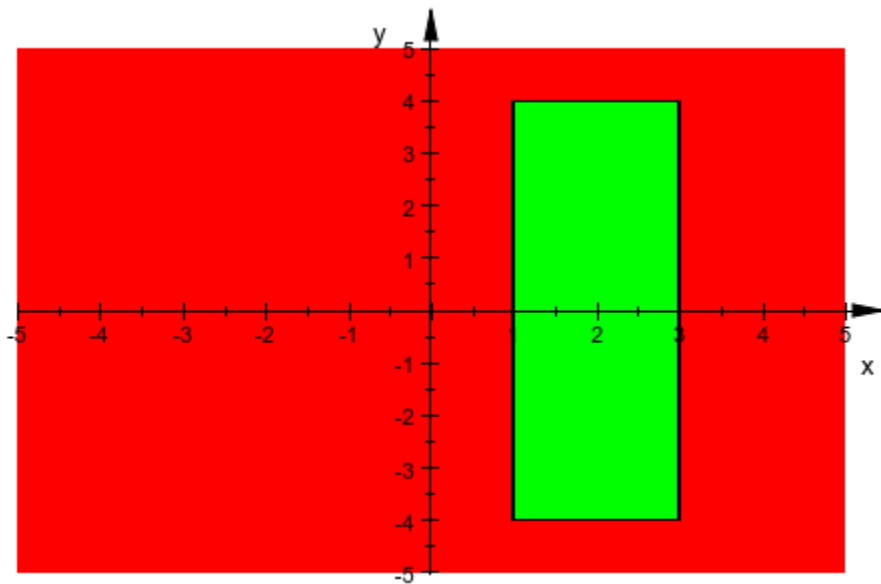

See also: `plot::Inequality`.

### Example 11

To display a 2D text at a certain position, an equation of a coordinate tuple and a character string or a procedure can be entered:

```
plot([t, t^2],  
     {[t, t^2], #Points},  
     [t, t^2] = "moving text")
```

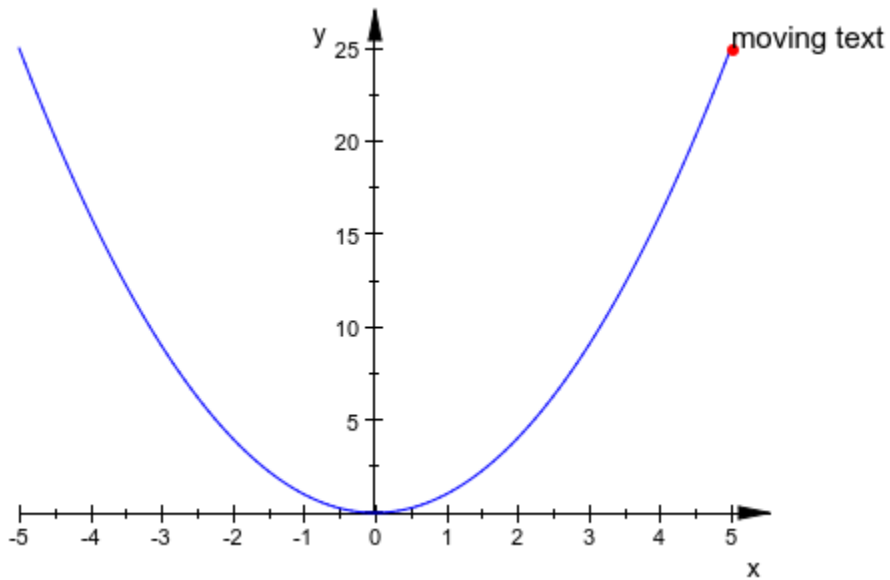

We display a 3D text. As in any other context of `plot::easy`, we can use regular graphical attributes like `TextFont =Center` as well:

```
DIGITS := 2:
plot([t, t^2, 1],
     {[t, t^2, 1], #Points},
     [t, t^2, 1] = (t->" x = ").[t, t^2, 1.0]),
     TextFont=[Bold]):
delete DIGITS:
```

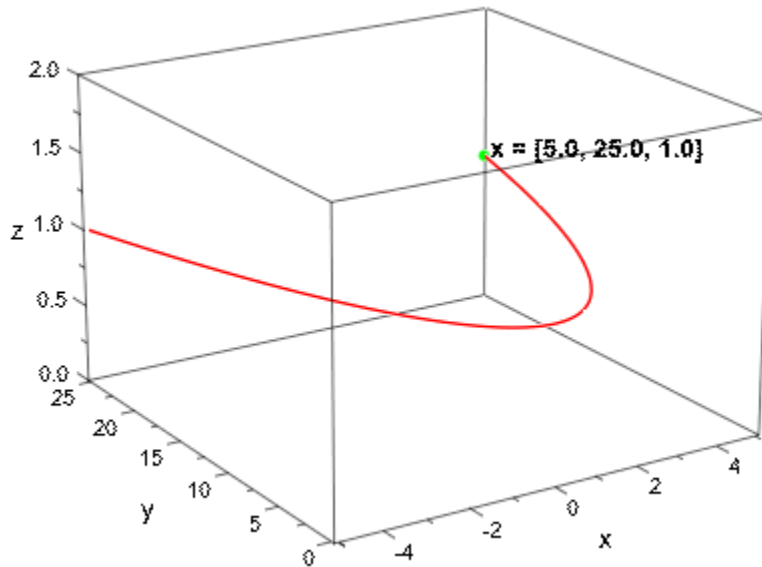

See also: `plot::Text2d`, `plot::Text3d`.

### Example 12

Usually `plot::easy` creates a 2D scene, unless one of the arguments is a 3D object or can only be transformed to a 3D object or the option `#3D` is used.

```
plot(sin(x), #3)
```

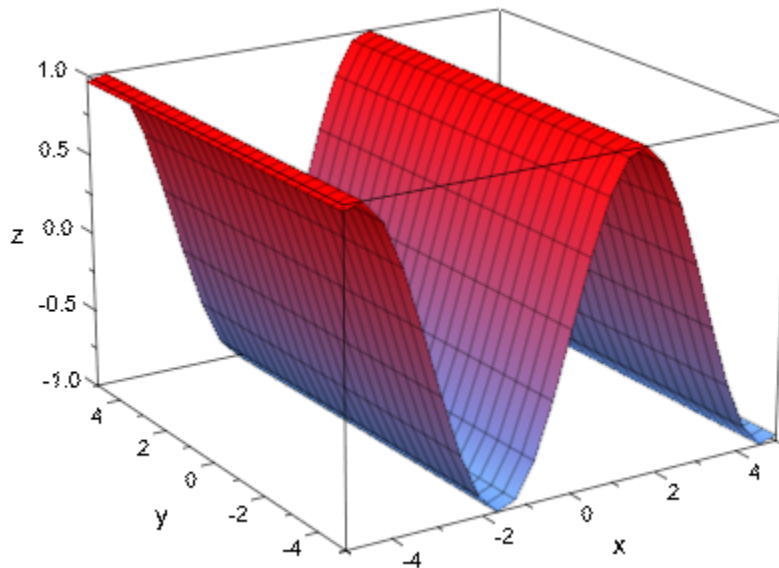

However, the option `#3D` is only a hint. It is ignored if the current scene can only be a 2D scene. In the following example, the 2D point determines the dimension of the scene:

```
plot([PI/2,1], sin(x), #3)
```

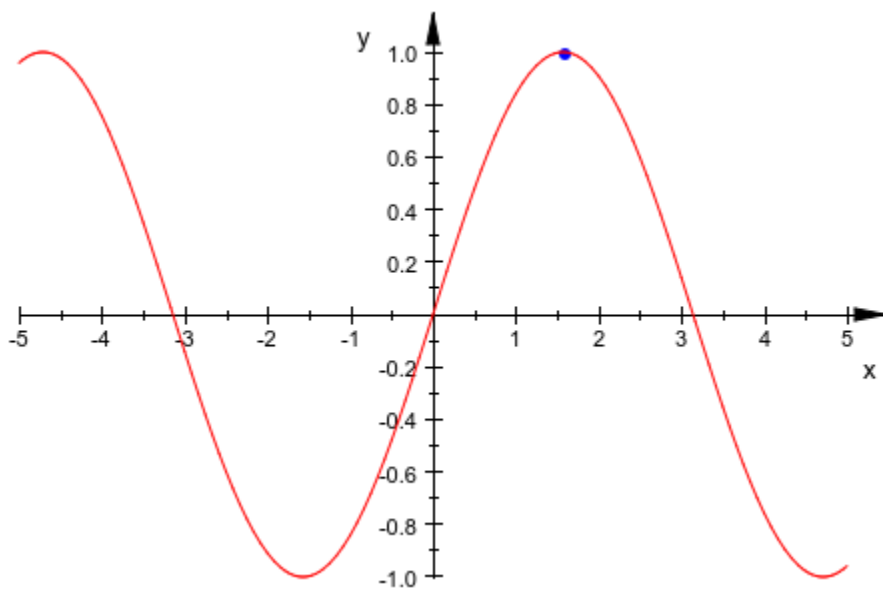

In the following example, the 3D point determines the dimension of the scene. There is no need to use option #3D in order to create a 3d scene:

```
plot([PI/2,1,0], sin(x))
```



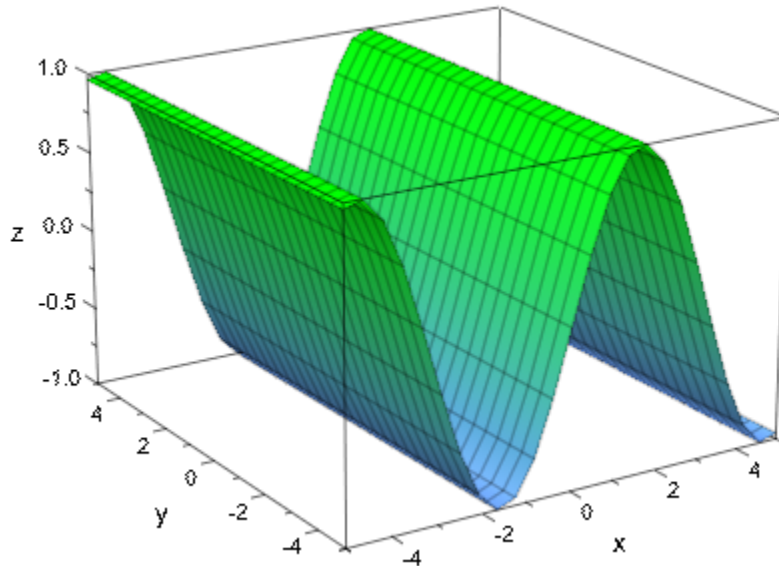

### Example 13

With option `#Arrows`, arrows instead of points or curves are created. When used within a `{...}`-group, it affects the elements of this group or scene only.

```
plot({{ [-5,25], [5,25], [x,x^2]    }},  
     {{ [-5,25], [5,25], [x,x^2], #A }})
```

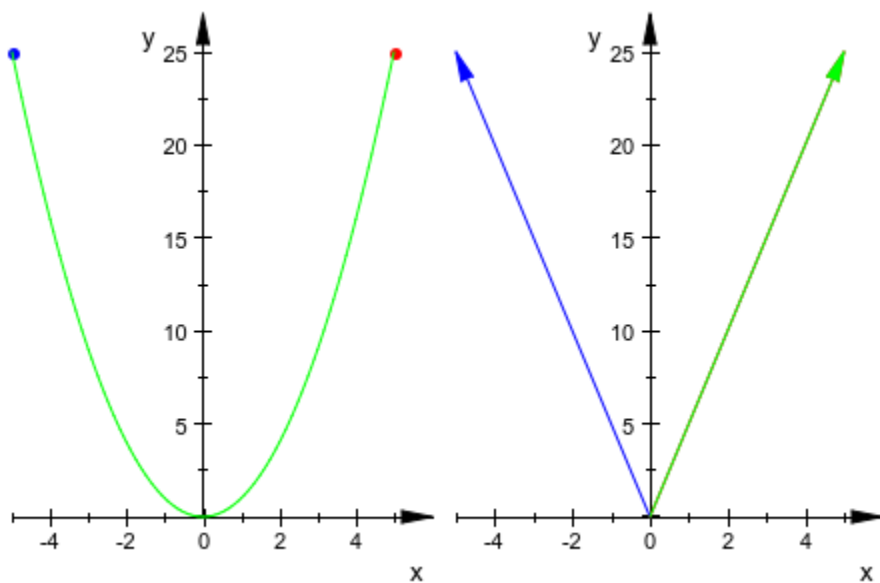

### Example 14

Option `#Constrained` creates a coordinate system with constrained scaled axes. This is a shortcut for `Scaling = Constrained`.

```
plot({{ x^2 }}, {{ x^2, #C }})
```

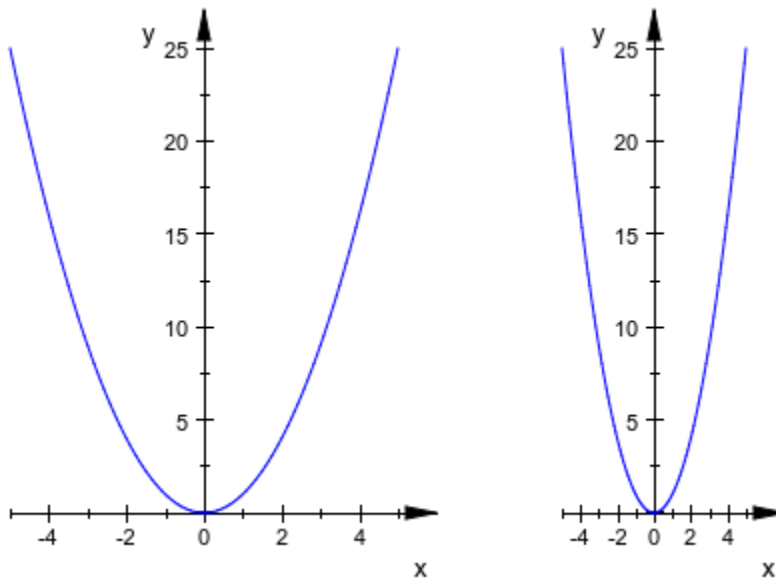

### Example 15

Option `#Grid` creates a coordinate system with grid lines. This is a shortcut for `GridVisible = TRUE`.

```
plot({{ x^2 }}, {{ x^2, #G }})
```

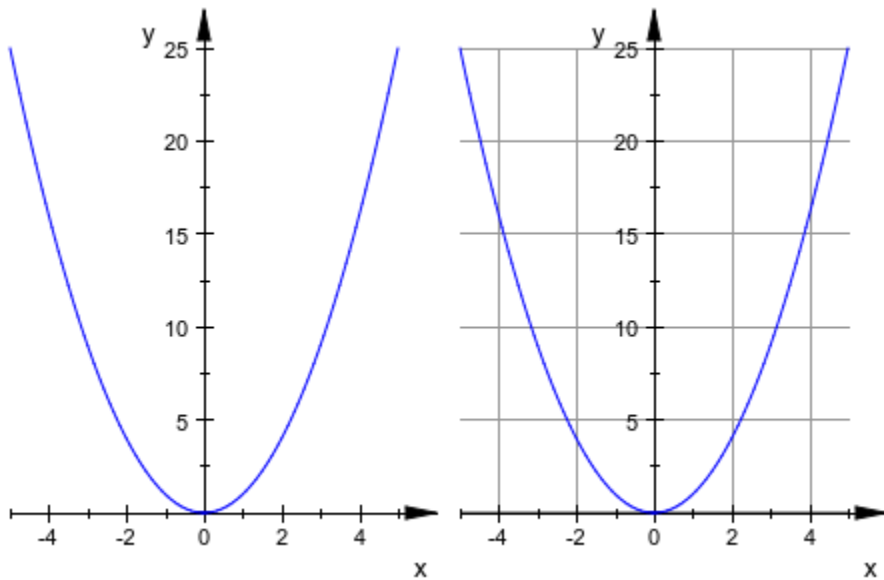

### Example 16

Option `#Legend` creates a legend. This is a shortcut for `LegendVisible = TRUE` in combination with `LegendEntry = TRUE`. Note that `plot::easy` explicitly sets a legend text for each graphical object it creates.

```
plot([0,-6], x^2-5, [t,t^2], #L)
```

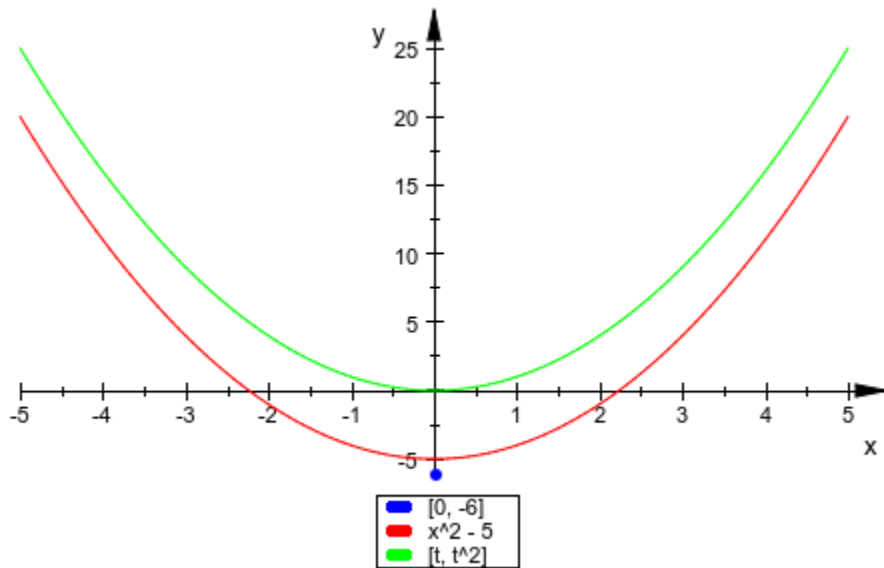

### Example 17

Option `#Origin` includes the coordinates  $(0,0)$  or  $(0,0,0)$ , respectively, into the viewing box of the current scene.

```
plot({{[2,2], [3,3]}}, {{[2,2], [3,3], #0}})
```

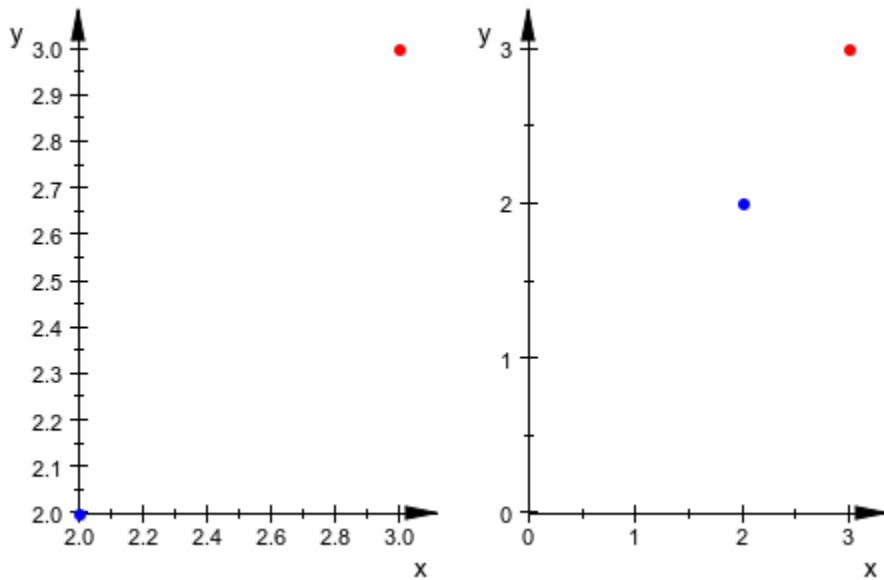

### Example 18

Using option `#Points`, points instead of arrows or curves are created. Furthermore, this option sets the attributes `PointsVisible = TRUE` and `LinesVisible = FALSE`. When used within a `{...}`-group, it affects the elements of this group or scene only.

```
plot([-5,25], [x,x^2], #Gray, {matrix([5,25]), [x,x^2], #P})
```

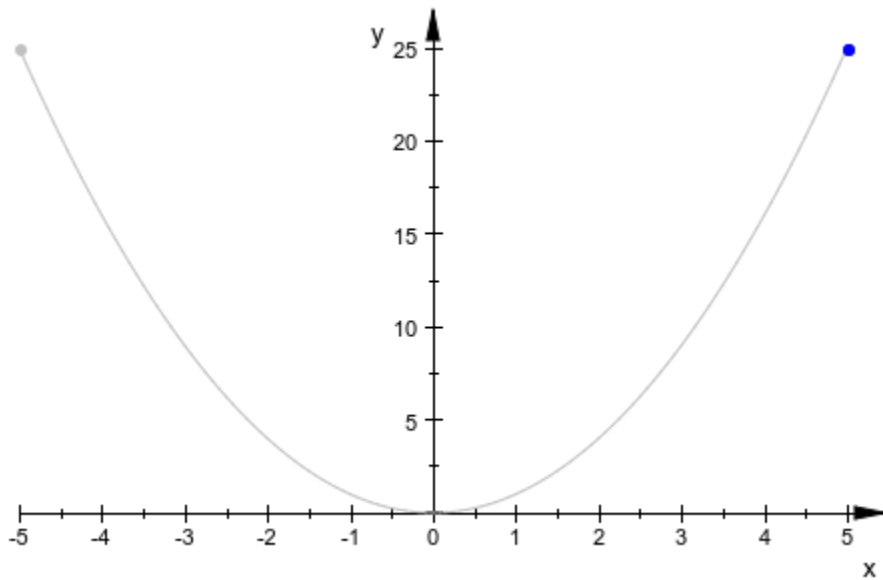

### Example 19

`#X / #Y / #Z = a..b` sets the x- / y- / z-range of the viewing box of the scene to a..b. This is a shortcut for `ViewingBoxXRange / ViewingBoxYRange / ViewingBoxZRange = a..b`.

```
plot({{x^2, sin(x)}}, {{x^2, sin(x), #Y=0..4}})
```

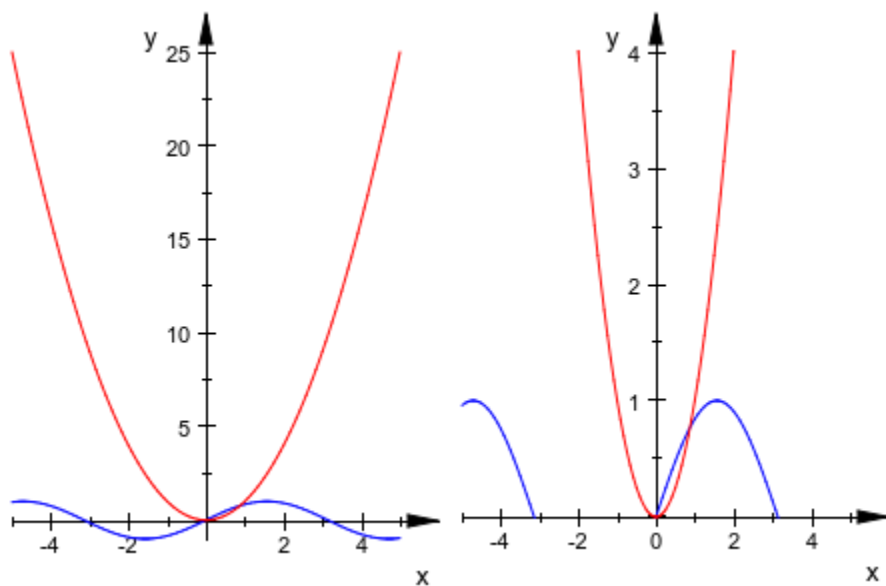

We draw a 3D scene with a restricted viewing box. Therefore, only a quarter of the sphere is visible:

```
plot({plot::Sphere(1)}},  
     {plot::Sphere(1), #X=0..1, #Y=0..1, #Z=0..1})
```



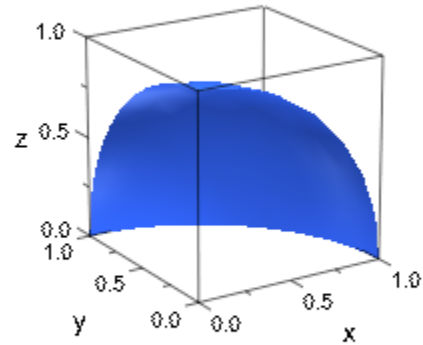
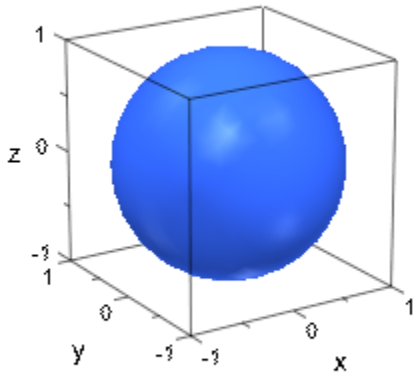

## Parameters

### arg

Any object

## Options

### #3D

Alias #3. Creates a 3D instead of a 2D scene, if possible. Usually, a 2D scene is created unless one of the arguments is a 3D object or can only be transformed into one.

### #Arrows

Alias #A. Creates arrows instead of points. When used within a {...}-group, it affects the elements of this group or scene only.

**#Constrained**

Alias **#C**. Creates a coordinate system with axes having the same scaling. This is a shortcut for `Scaling =Constrained`.

**#Grid**

Alias **#G**. Creates a coordinate system with grid lines. This is a shortcut for `GridVisible =TRUE`.

**#Legend**

Alias **#L**. Creates a legend. This is a shortcut for `LegendEntry =TRUE` and `LegendVisible =TRUE`. When used within a {...}-group, it affects the elements of this group or scene only. Note that `plot::easy` explicitly sets a legend text for each graphical object it creates.

**#Origin**

Alias **#O**. Includes the coordinates (0,0) or (0,0,0), respectively, into the viewing box of the current scene.

**#Points**

Alias **#P**. Creates points instead arrows or curves. Furthermore, it sets the attributes `PointsVisible =TRUE` and `LinesVisible =FALSE`. When used within a {...}-group, it affects the elements of this group or scene only.

**#XRange**

Option, specified as `#XRange = a .. b`

Alias **#X** = `a .. b`. Sets the x-range of the viewing box of the scene to `a .. b`. This is a shortcut for `ViewingBoxXRange =a..b`.

**#YRange**

Option, specified as `#YRange = a .. b`

Alias **#Y** = `a .. b`. Sets the y-range of the viewing box of the scene to `a .. b`. This is a shortcut for `ViewingBoxYRange =a..b`.

## #ZRange

Option, specified as `#ZRange = a .. b`

Alias `#Z = a .. b`. Sets the z-range of the viewing box of the scene to `a .. b`. This is a shortcut for `ViewingBoxZRange =a..b`.

## #<Colorname>

If `RGB ::<Colorname>` is a valid color name in MuPAD, `#<Colorname>` is transformed to: `Color = RGB ::<Colorname>, LineColorType =Flat` and for 3D objects additionally `FillColorType =Flat`. Transparent RGB colors can be specified as `#<Colorname>.[t]`, with `t` is in `0..1`. If `#<Colorname>` is a valid color following the html conventions then instead of `RGB ::<Colorname>`, the corresponding RGB or RGBA color value is inserted. When used within a `{...}`-group, it affects the elements of this group or scene only.

## #<Colorname1> .. #<Colorname2>

If `RGB ::<Colorname1>` and `RGB ::<Colorname2>` are valid color names in MuPAD, this option is transformed to:

`Color = RGB ::<Colorname1>, LineColorType =Dichromatic, LineColor2 = RGB ::<Colorname2>` in 2D scenes and to:

`Color = RGB ::<Colorname1>, FillColorType =Dichromatic, FillColor2 = RGB ::<Colorname2>` in 3D scenes.

Transparent RGB colors can be specified as `#<Colorname>.[t]`, with `t` is in `0..1`. If `#<Colorname1>` and/or `#<Colorname2>` are valid colors following the html conventions then instead of `RGB ::<Colorname1>` and/or, `RGB ::<Colorname2>` the corresponding RGB or RGBA color values are inserted. When used within a `{...}`-group, it affects the elements of this group or scene only.

## Return Values

A sequence of graphical objects and graphical attributes as well as objects that could not be transformed by `plot::easy`.

## Overloaded By

arg

## Algorithms

Let  $c_i$  be real constants and  $f$  and  $f_i$  be real functions. `plot::easy` automatically carries out the following transformations:

Graphical object	Data or mathematical expression
<code>plot::Point2d:</code>	$[c_1, c_2], \{[f_1(x), f_2(x)], \#Points\}, \{\text{matrix}([f_1(x), f_2(x)]), \#Points\}.$
<code>plot::Point3d:</code>	$[c_1, c_2, c_3], \{[f_1(x), f_2(x), f_3(x)], \#Points\}, \{\text{matrix}([f_1(x), f_2(x), f_3(x)]), \#Points\}.$
<code>plot::Arrow2d:</code>	$\text{matrix}([c_1, c_2]), \{[c_1, c_2], \#Arrows\}, \{[\text{matrix}([f_1(x), f_2(x)]), \text{matrix}([f_3(x), f_4(x)])], \#Arrows\}, \{\text{matrix}([f_1(x), f_2(x)], [f_3(x), f_4(x)]), \#Arrows\}, \{[[f_1(x), f_2(x)], [f_3(x), f_4(x)]], \#Arrows\}.$
<code>plot::Arrow3d:</code>	$\text{matrix}([c_1, c_2, c_3]), \{[c_1, c_2, c_3], \#Arrows\}, \{[\text{matrix}([f_1(x), f_2(x), f_3(x)]), \text{matrix}([f_4(x), f_5(x), f_6(x)])], \#Arrows\}, \{\text{matrix}([f_1(x), f_2(x), f_3(x)], [f_4(x), f_5(x), f_6(x)]), \#Arrows\}, \{[[f_1(x), f_2(x), f_3(x)], [f_4(x), f_5(x), f_6(x)]], \#Arrows\}.$
<code>plot::Polygon2d:</code>	$[[f_1(x), f_2(x)], \dots], [\text{matrix}([f_1(x), f_2(x)]), \dots], \text{matrix}([f_1(x), f_2(x)], \dots), \text{table}(f_1(x)=f_2(x), \dots).$
<code>plot::Polygon3d:</code>	$[[f_1(x), f_2(x), f_3(x)], \dots], [\text{matrix}([f_1(x), f_2(x), f_3(x)]), \dots], \text{matrix}([f_1(x), f_2(x), f_3(x)], \dots), \text{table}(f_1(x)=[f_2(x), f_3(x)], \dots).$

Graphical object	Data or mathematical expression
plot::PointList2d:	$[[f_1(x), f_2(x), \text{RGBa}], \dots], [\text{matrix}([f_1(x), f_2(x), \text{RGBa}], \dots), \text{matrix}([f_1(x), f_2(x), \text{RGBa}], \dots)], \text{table}(f_1(x)=[f_2(x), \text{RGBa}], \dots)].$
plot::PointList3d:	$[[f_1(x), f_2(x), f_3(x), \text{RGBa}], \dots], [\text{matrix}([f_1(x), f_2(x), f_3(x), \text{RGBa}], \dots), \text{matrix}([f_1(x), f_2(x), f_3(x), \text{RGBa}], \dots)], \text{table}(f_1(x)=[f_2(x), f_3(x), \text{RGBa}], \dots)].$
plot::Line2d:	$\#x= f(x), \#y= f(x).$
plot::Plane:	$\#z= f(x), \{\#x= f(x) , \#3D\}, \{\#y= f(x) , \#3D\}, \{\#z= f(x) , \#3D\}.$
plot::Curve2d:	$[f_1(x), f_2(x)].$
plot::Curve3d:	$[f_1(x), f_2(x), f_3(x)].$
plot::Function2d:	$f(x), f(x, a), [\text{cond}_1, f(x)], [[\text{cond}_1, f(x)], \dots].$
plot::Function3d:	$f(x, y, a), [\text{cond}_1, f(x, y, a)], [[\text{cond}_1, f(x, y, a)], \dots], \{f(x), \#3D\}, \{f(x, a), \#3D\}.$
plot::Implicit2d:	$f_1(x, y, a)=f_2(x, y, a).$
plot::Implicit3d:	$f_1(x, y, z, a)=f_2(x, y, z, a), \{f_1(x, y, a)=f_2(x, y, a), \#3D\}.$
plot::Inequality:	$f_1(x, a) < f_2(x, a), f_1(x, a) \leq f_2(x, a), f_1(x, a) > f_2(x, a), f_1(x, a) \geq f_2(x, a), [f_1(x, a) < f_2(x, a), f_3(x, a) > f_4(x, a), f_5(x, a) = f_6(x, a), \dots].$
plot::Text2d:	$[f_1(x), f_2(x)]=\text{text}, \text{matrix}([f_1(x), f_2(x)])=\text{text}, [f_1(x), f_2(x)]=\text{procedure}, \text{matrix}([f_1(x), f_2(x)])=\text{procedure}.$

Graphical object	Data or mathematical expression
plot::Text3d:	[f <sub>1</sub> (x), f <sub>2</sub> (x), f <sub>3</sub> (x)]=text, matrix([f <sub>1</sub> (x), f <sub>2</sub> (x), f <sub>3</sub> (x)])=text, [f <sub>1</sub> (x), f <sub>2</sub> (x), f <sub>3</sub> (x)]=procedure, matrix([f <sub>1</sub> (x), f <sub>2</sub> (x), f <sub>3</sub> (x)])=procedure.

## See Also

### MuPAD Functions

plot

# plot::getDefault

Get current default setting of attributes

## Syntax

```
plot::getDefault(type::attr)
```

## Description

`plot::getDefault(plot::Object::Attribute)` enquires the current default.

Defaults are set and retrieved per object; with the exception of `OutputFile` and `OutputOptions`, the attribute must be prefixed with the name of the object type the setting will be valid for. There is, for example, no function to turn of all lines on all 3D objects. `OutputFile` and `OutputOptions` are not associated with an object and must be set directly.

## Examples

### Example 1

By default, function plots use relatively thin lines:

```
plotfunc2d(sin(x))
```

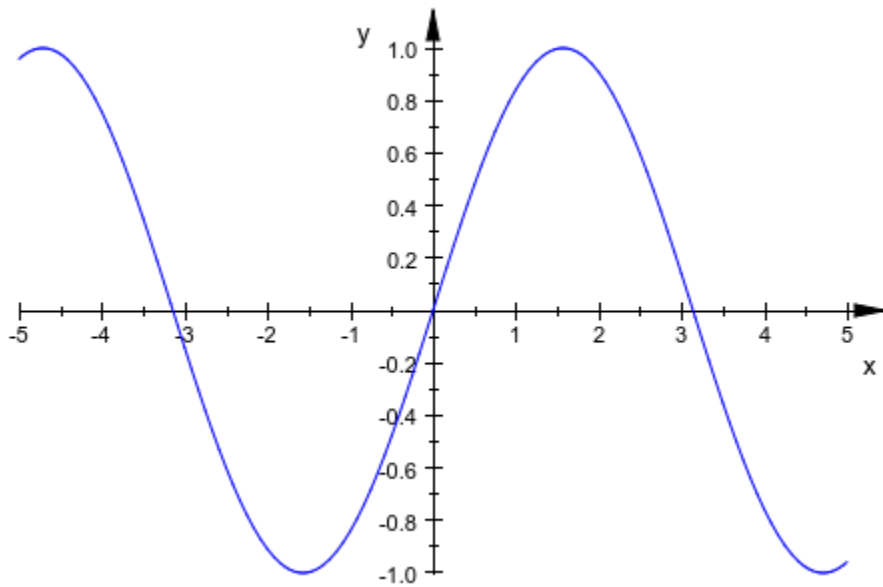

To get the current line width setting, use the following command:

```
plot::getDefault(plot::Function2d::LineWidth)
```

0.35

Using `plot::setDefault`, you can change the default setting once and for the whole session:

```
plot::setDefault(plot::Function2d::LineWidth = 1*unit::mm):  
plotfunc2d(sin(x))
```



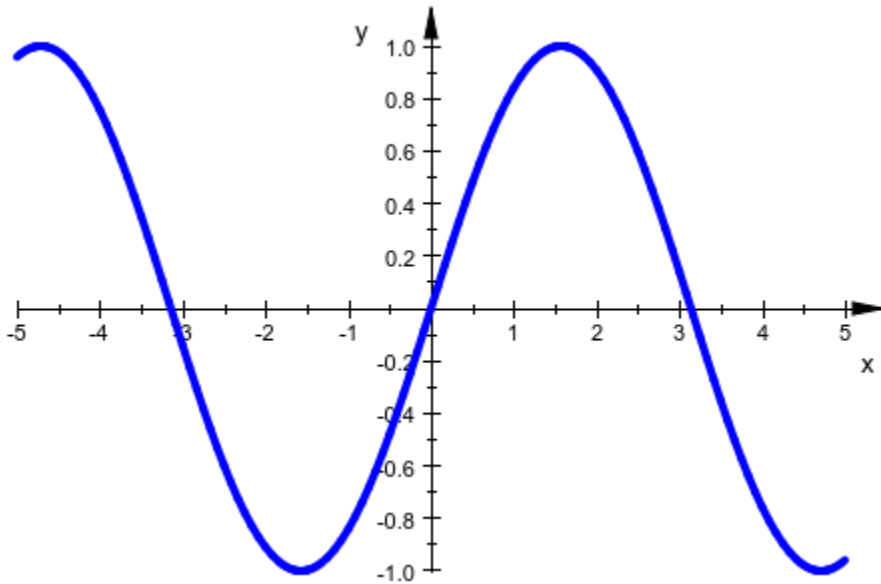

Again, check the current line width setting using the following command:

```
plot::getDefault(plot::Function2d::LineWidth)
```

1

Note that `plotfunc2d` and `plotfunc3d` use `plot::Function2d` and `plot::Function3d` for the actual plotting. Changing color and legend settings of the latter two does not influence the former because `plotfunc2d` and `plotfunc3d` set color and legend settings explicitly.

## Parameters

### type

A domain of the plot library, i.e., an object type such as `plot::Function2d`

**attr**

Attributes admissible for the object type `type`

## Return Values

`plot::getDefault` returns the current default value.

## Algorithms

“Admissible attributes” includes all the attributes the object itself reacts to. Hints (Symbolic Math Toolbox) cannot be set or changed with `plot::setDefault`.

For attributes marked as “mandatory,” default values are read and used the moment an object is created. Default values of attributes marked as “optional” or “inherited” are read when the object is plotted and can therefore be changed after creating an object.

## See Also

**MuPAD Functions**

`plot::setDefault`

# plot::setDefault

Set default setting of attributes

## Syntax

```
plot::setDefault(type::attr = value, ...)
```

## Description

`plot::setDefault(plot::Object::Attribute = Value)` sets the default of the attribute `Attribute` for objects of type `plot::Object` to `Value`.

While not all attributes have defaults, it is in general possible to set defaults for them, although some examples like setting a default function to plot for `plot::Function2d` are probably more exotic than others, to say the least.

Defaults are set and retrieved per object; with the exception of `OutputFile` and `OutputOptions`, the attribute must be prefixed with the name of the object type the setting will be valid for. There is, for example, no function to turn of all lines on all 3D objects. `OutputFile` and `OutputOptions` are not associated with an object and must be set directly.

To delete a default (which is not recommended for attributes having a default in the standard installation), set `value` to `FAIL`.

## Examples

### Example 1

By default, function plots use relatively thin lines:

```
plotfunc2d(sin(x))
```

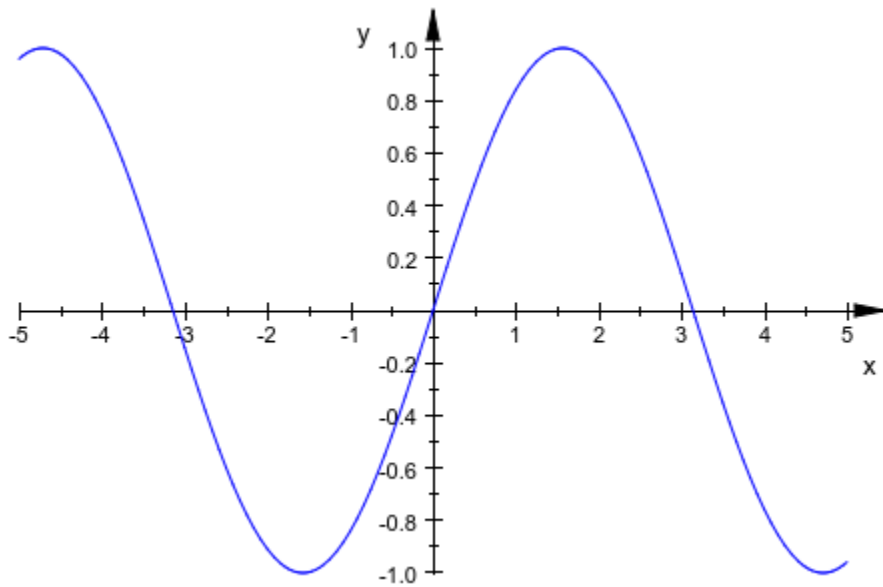

You can use thicker lines as follows:

```
plotfunc2d(sin(x), LineWidth = 1*unit::mm)
```

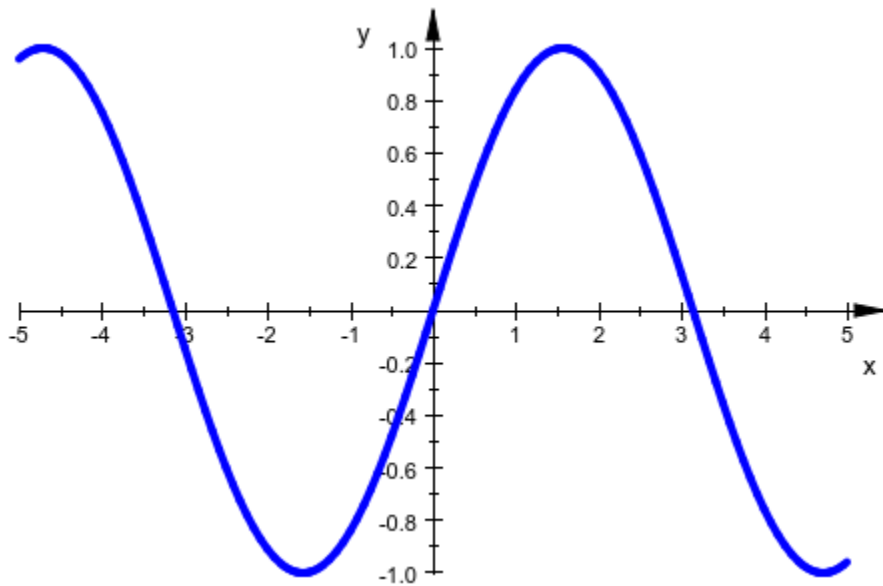

However, this is distracting and cumbersome. Using `plot::setDefault` lets you change the default setting once and for the whole session:

```
plot::setDefault(plot::Function2d::LineWidth = 1*unit::mm):  
plotfunc2d(sin(x))
```

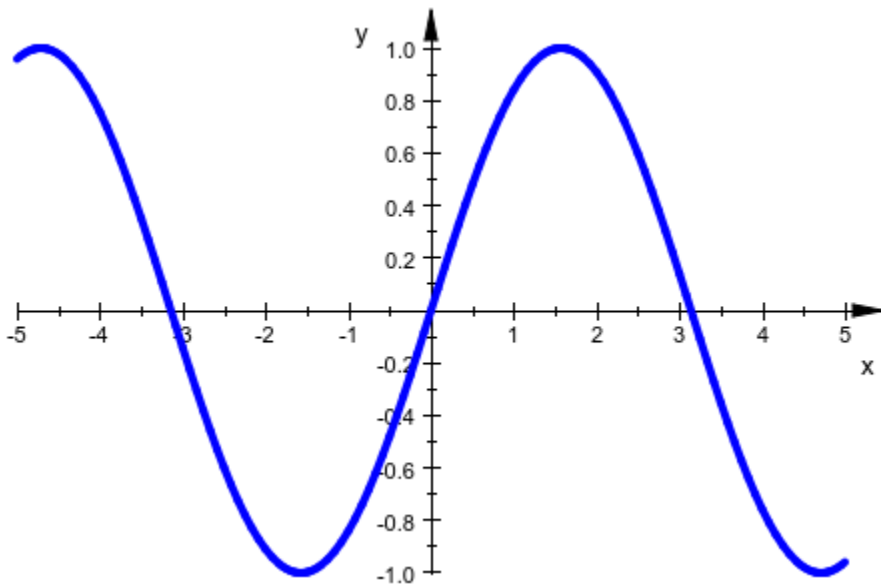

Note that `plotfunc2d` and `plotfunc3d` use `plot::Function2d` and `plot::Function3d` for the actual plotting. Changing color and legend settings of the latter two does not influence the former because `plotfunc2d` and `plotfunc3d` set color and legend settings explicitly.

## Parameters

### **type**

A domain of the plot library, that is, an object type such as `plot::Function2d`

### **attr**

Attributes admissible for the object type `type`

### **value**

The new default value: a value admissible for `attr` in objects of type `type`

## Return Values

`plot::setDefault` returns the previous default value(s).

## Algorithms

“Admissible attributes” include all the attributes the object itself reacts to. Hints (Symbolic Math Toolbox) cannot be set or changed with `plot::setDefault`.

For attributes marked as “mandatory,” default values are read and used the moment an object is created. Default values of attributes marked as “optional” or “inherited” are read when the object is plotted and can therefore be changed after creating an object.

## See Also

### **MuPAD Functions**

`plot::getDefault`

## plot::copy

Make a physical copy of a plot object

### Syntax

```
plot::copy(obj)
```

### Description

Objects created from inside the `plot` library have a *reference effect*: If you make another reference to some object, say by calling `o2 := o1`; and then change an attribute of `o2`, for example, setting `o2::Visible := FALSE`, this change will also effect the object referred to by `o1`, because they actually refer to the same object. To create an actual copy of an object instead, use `o2 := plot::copy(o1)`;

### Examples

#### Example 1

The following call does not create two points, but rather one which we can access by two names:

```
A := plot::Point2d(0, 0):  
B := A:
```

This becomes obvious when you try to modify one of the points:

```
B::Position := [1, 1]:  
A
```

```
plot::Point2d(1, 1)
```

To copy a point, use `plot::copy` :



```
B := plot::copy(A):  
B::Position := [2, 2]:  
A, B
```

```
plot::Point2d(1, 1), plot::Point2d(2, 2)
```

## Parameters

**obj**

Plot objects

## Return Values

Object of the same type as obj

## See Also

**MuPAD Functions**

plot::modify

## plot::modify

Make a physical copy of a plot object setting new values of attributes in the same call

### Syntax

```
plot::modify(obj, <attr, ...>)
```

### Description

Objects created from inside the `plot` library have a *reference effect*: If you make another reference to some object, say by calling `o2 := o1`; and then change an attribute of `o2`, e.g., setting `o2::Visible := FALSE`, this change will also effect the object referred to by `o1`, since they actually refer to the same object. To create an actual copy of an object instead, use `o2 := plot::copy(o1);`.

`plot::modify` copies a plot object the same way as `plot::copy` does, but it also lets you set new values of attributes in the same call. For example, you can use `o2 := plot::modify(o1, Visible = FALSE)`.

Note that `plot::modify` does not modify its argument, but returns a **modified copy** instead.

### Examples

#### Example 1

The following call does not create two points, but rather one which we can access by two names:

```
A := plot::Point2d(0, 0):  
B := A:
```

This becomes obvious when you try to modify one of the points:

```
B::Position := [1, 1]:  
A
```

```
plot::Point2d(1, 1)
```

To copy and modify a point in one call, use `plot::modify`:

```
B := plot::modify(A, Position = [2, 2]):  
A, B
```

```
plot::Point2d(1, 1), plot::Point2d(2, 2)
```

## Parameters

### **obj**

Plot objects

### **attr**

Attributes acceptable by the object `obj`, in the form `Attribute = Value`

## Return Values

Object of the same type as `obj`

## See Also

### **MuPAD Functions**

`plot::copy`

## plot::deLaunay

Compute the Delaunay triangulation of a set of points

### Syntax

```
plot::deLaunay(L)
```

### Description

`plot::deLaunay` computes the Delaunay triangulation of a list of points in arbitrary dimension.

The Delaunay triangulation of a list of points is a triangulation of their convex hull such that for each edge of the triangulation, there is a circle containing the two endpoints of this edge but no other point of the list.

### Environment Interactions

Although `plot::deLaunay` accepts and returns floating-point values, the actual computations take place in hardware floating-points and are therefore *not* affected by the value of `DIGITS`.

### Examples

#### Example 1

Delaunay triangulation does not introduce new points:

```
n0 := 10:  
l := [[Re, Im](exp(float(2*I*PI*n)/n0)) $ n = 1.. n0]:  
d := plot::deLaunay(l):  
plot(plot::PointList2d(l, PointSize=3),  
      plot::Polygon2d(t, Closed) $ t in d)
```

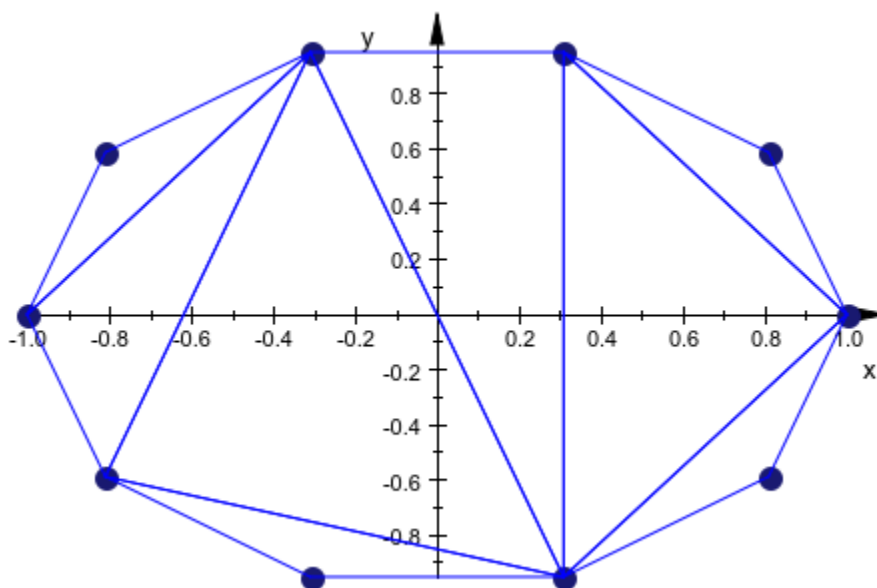

## Parameters

**L**

A list of points, which are given as lists of real values

## Return Values

List of simplices in the dimension of the points in L, given as lists of lists of floating-point values.

## Algorithms

`plot::deLaunay` uses `qhull` from the Geometry Center of the University of Minnesota, see [www.qhull.org](http://www.qhull.org).

## plot::hull

Compute the convex hull of a set of points

### Syntax

```
plot::hull(L)
```

### Description

`plot::hull` computes the convex hull of a list of points in any dimension, i.e., the smallest convex region containing all the points. Such a region is bounded by simplices (straight lines in the plane, triangles in 3D) and it is these simplices which `plot::hull` returns.

### Environment Interactions

Although `plot::hull` accepts and returns floating point values, the actual computations take place in hardware floating points and are therefore *not* affected by the value of `DIGITS`.

### Examples

#### Example 1

We generate a list of random points and compute their convex hull:

```
X := stats::uniformRandom(0, 20):  
l := [[X(), X()] $ i = 1..10]:  
h := plot::hull(l):
```

The convex hull is returned as lists of lists, as accepted by `plot::Polygon2d`:

```
h[1]
```

```
[[17.58320254, 18.38769696], [3.063130321, 19.89625562]]
```

```
plot(plot::PointList2d(l),
      plot::Polygon2d(t) $ t in h,
      Closed, PointSize=2)
```

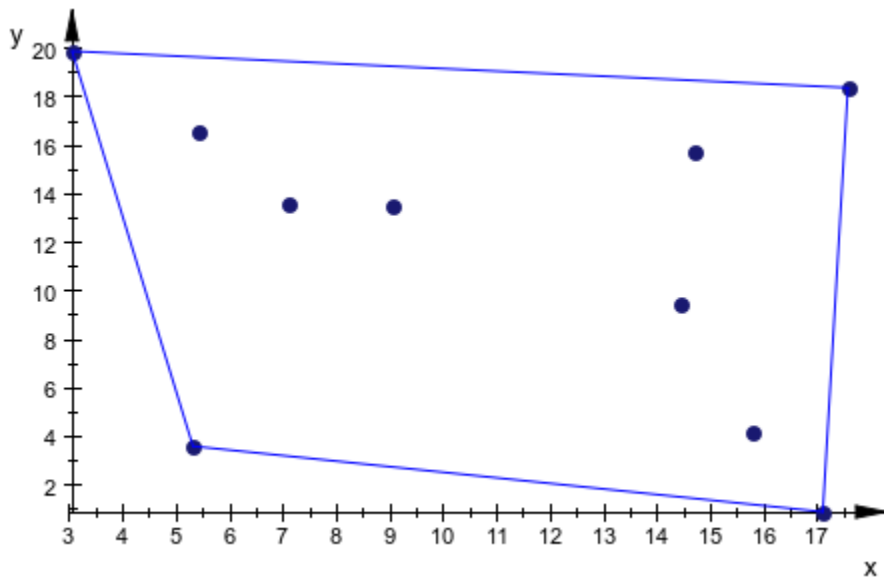

## Example 2

The convex hull of a list of points in 3D is also easy to visualize:

```
l := [[x, y, z] $ y = z..x $ z = -x..x $ x = 0..10]:
h := plot::hull(l):
plot(plot::PointList3d(l, PointSize=1),
      plot::Polygon3d(t) $ t in h,
      Closed, Filled, FillColor=RGB::LightOrange.[0.6])
```

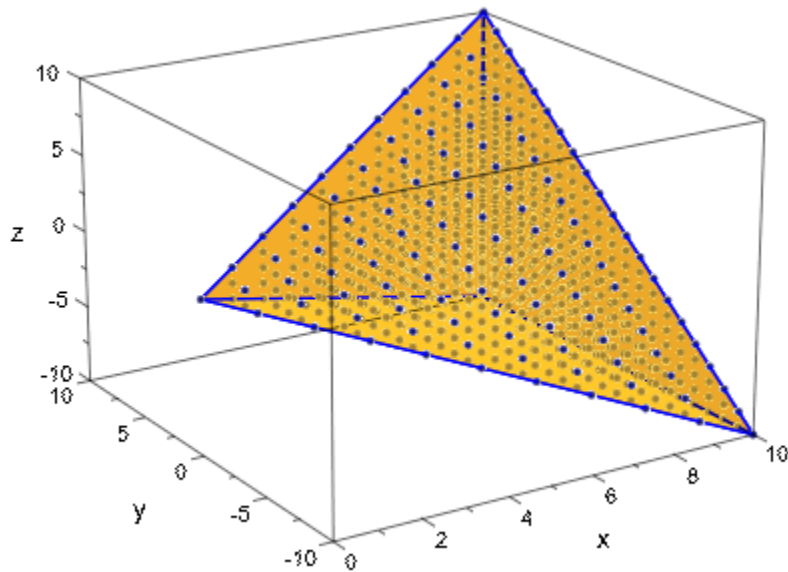

## Parameters

**L**

A list of points, which are given as lists of real values

## Return Values

List of simplices of dimension one less than that of the points in L, given as lists of lists of floating-point values.

## Algorithms

`plot::hull` uses `qhull` from the Geometry Center of the University of Minnesota, see [www.qhull.org](http://www.qhull.org).



# plot::Arc2d

Circular and elliptical arcs in 2D

## Syntax

```
plot::Arc2d(r, <[cx, cy>, <α .. β>, <a = amin .. amax>, options)
```

```
plot::Arc2d([r1, r2], <[cx, cy>, <α .. β>, <a = amin .. amax>, options)
```

## Description

`plot::Arc2d(r, [x, y], α .. β )` creates a circular arc with radius  $r$  and center  $(x, y)$  with a polar angle between  $\alpha$  and  $\beta$ .

`plot::Arc2d([r1, r2], [x, y], α .. β )` creates a corresponding elliptical arc with semi-axes  $r_1, r_2$ .

The angle of a point on the arc is the usual polar angle to the positive x-axis known from polar coordinates. It is measured in radians.

If you do not specify the range for the polar angle, `plot::Arc3d` creates a full circle/ellipse.

If you do not specify the center point, `plot::Arc3d` creates an arc with center  $[0, 0]$ .

## Attributes

Attribute	Purpose	Default Value
AffectViewingBox	influence of objects on the ViewingBox of a scene	TRUE
Angle	rotation angle	0
AngleEnd	end of angle range	PI/2
AngleBegin	begin of angle range	0

<b>Attribute</b>	<b>Purpose</b>	<b>Default Value</b>
AngleRange	angle range	0 .. PI/2
AntiAliased	antialiased lines and points?	TRUE
Center	center of objects, rotation center	[0, 0]
CenterX	center of objects, rotation center, x-component	0
CenterY	center of objects, rotation center, y-component	0
Closed	open or closed polygons	FALSE
Filled	filled or transparent areas and surfaces	FALSE
FillColor	color of areas and surfaces	RGB::Red
FillPattern	type of area filling	DiagonalLines
Frames	the number of frames in an animation	50
Legend	makes a legend entry	
LegendText	short explanatory text for legend	
LegendEntry	add this object to the legend?	FALSE
LineColor	color of lines	RGB::Blue
LineWidth	width of lines	0.35
LineStyle	solid, dashed or dotted lines?	Solid
LinesVisible	visibility of lines	TRUE
Name	the name of a plot object (for browser and legend)	
ParameterEnd	end value of the animation parameter	
ParameterName	name of the animation parameter	

<b>Attribute</b>	<b>Purpose</b>	<b>Default Value</b>
ParameterBegin	initial value of the animation parameter	
ParameterRange	range of the animation parameter	
SemiAxes	semi axes of ellipses and ellipsoids	[1, 1]
SemiAxisX	first semi axis of ellipses and ellipsoids	1
SemiAxisY	second semi axis of ellipses and ellipsoids	1
TimeEnd	end time of the animation	10.0
TimeBegin	start time of the animation	0.0
TimeRange	the real time span of an animation	0.0 .. 10.0
Title	object title	
TitleFont	font of object titles	[" sans-serif ", 11]
TitlePosition	position of object titles	
TitleAlignment	horizontal alignment of titles w.r.t. their coordinates	Center
TitlePositionX	position of object titles, x component	
TitlePositionY	position of object titles, y component	
Visible	visibility	TRUE
VisibleAfter	object visible after this time value	
VisibleBefore	object visible until this time value	
VisibleFromTo	object visible during this time range	

Attribute	Purpose	Default Value
VisibleAfterEnd	object visible after its animation time ended?	TRUE
VisibleBeforeBegin	object visible before its animation time starts?	TRUE

## Examples

### Example 1

An arc is a segment of a circle:

```
circle := plot::Circle2d(3, [0, 0]):  
arc := plot::Arc2d(3, [0, 0], 0 .. PI/4, LineColor = RGB::Red,  
    LineWidth = 1.5*unit::mm):  
plot(circle, arc)
```

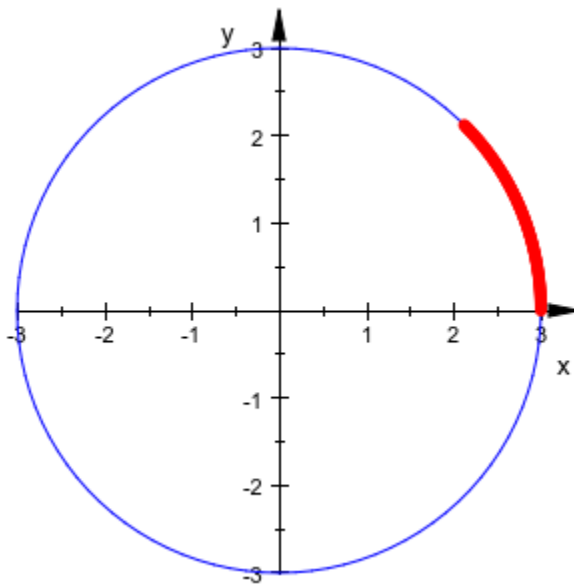

```
delete circle, arc:
```

## Example 2

The center of an arc can be given as the second argument to `plot::Arc2d`:

```
arc1 := plot::Arc2d(3, [1, 3], 0..PI/2, Closed = TRUE):  
arc2 := plot::Arc2d(3, [3, 1], -PI ..0, Closed = TRUE):  
plot(arc1, arc2)
```

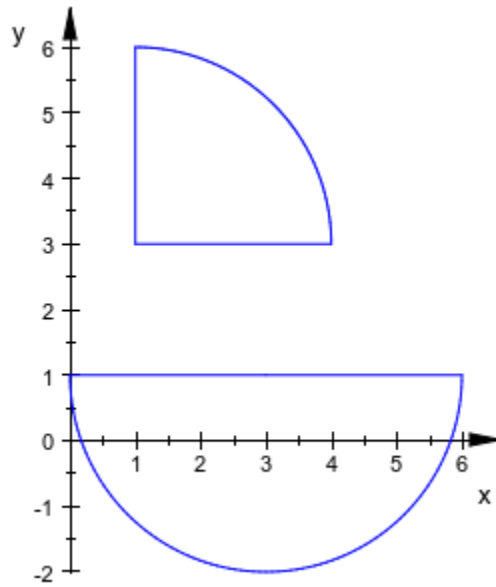

The center is accessible as the attribute `Center` of the arc object. Change the center of the second arc:

```
arc2::Center := [1, 3]:  
plot(arc1, arc2)
```

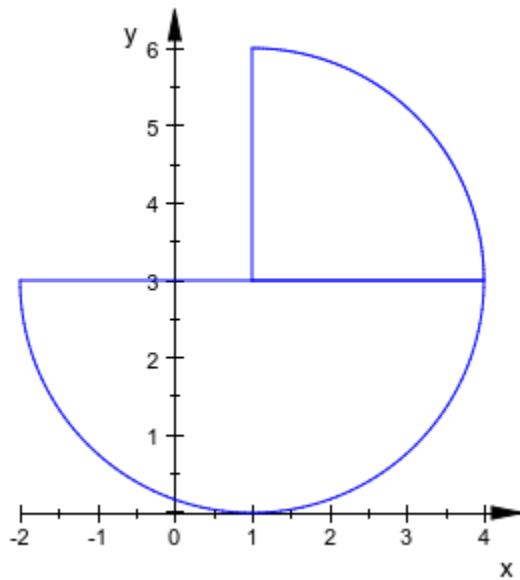

```
delete arc1, arc2:
```

### Example 3

A filled arc is a segment of a circle, like a piece of pie:

```
plot(plot::Arc2d(1, -PI/4..PI/4, Filled = TRUE))
```

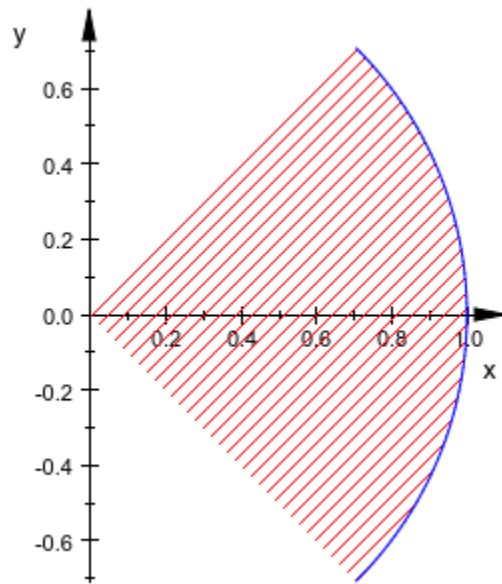

```
plot(plot::Arc2d(1, -PI/4..PI/4, Filled = TRUE, Closed = TRUE))
```

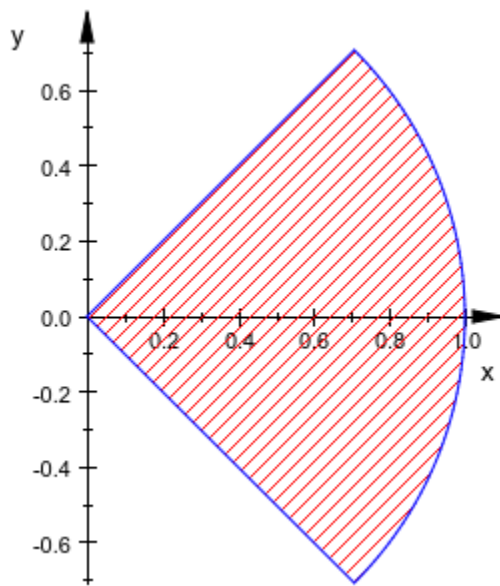

```
plot(plot::Arc2d(1, -PI/4..PI/4, Filled = TRUE,  
          FillPattern = Solid, LinesVisible = FALSE),  
      AxesInFront = TRUE)
```



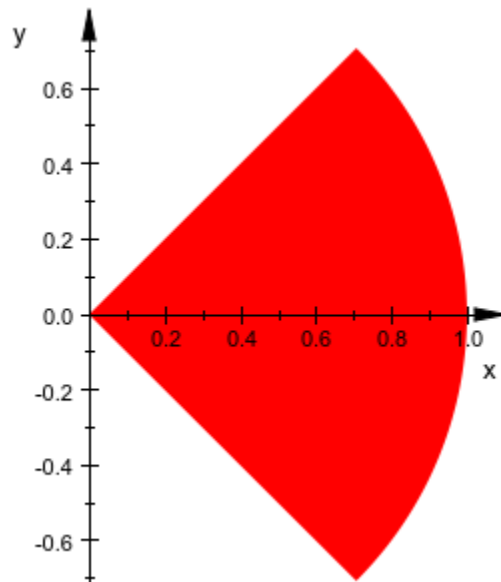

### Example 4

When given a list of two radii, `plot::Arc2d` draws a segment of an ellipse with the corresponding semi-axes:

```
arc1 := plot::Arc2d([2, 1], 0 .. PI, Color = RGB::Blue):  
arc2 := plot::Arc2d([2, 1], -PI .. 0, Color = RGB::Red):  
plot(arc1, arc2)
```

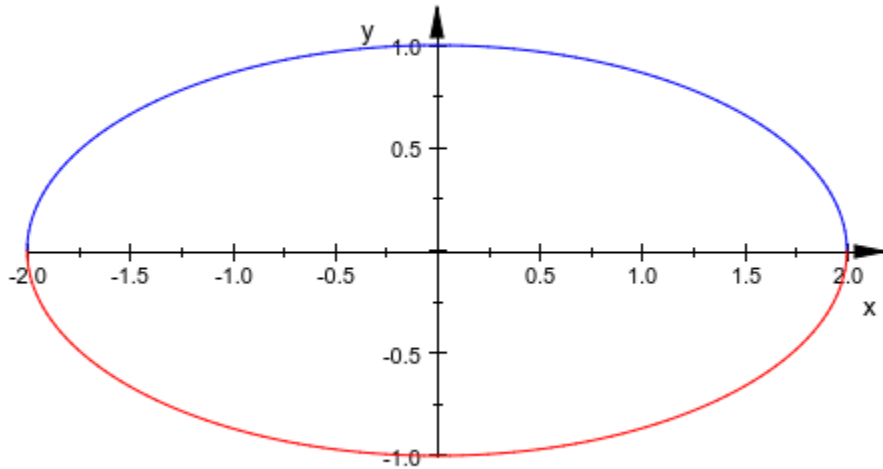

```
delete arc1, arc2:
```

### Example 5

To plot or animate segments of a tilted ellipse, use the attribute `Angle`:

```
arc:= [1, 1], [0, 0], PI/4..PI/2, Filled, Closed, FillPattern=Solid:  
plot(plot::Arc2d(arc, Angle=a+0, a=0..2*PI, FillColor=RGB::Red),  
      plot::Arc2d(arc, Angle=a+1/2*PI, a=0..2*PI, FillColor=RGB::Green),  
      plot::Arc2d(arc, Angle=a+PI, a=0..2*PI, FillColor=RGB::Yellow),  
      plot::Arc2d(arc, Angle=a+3/2*PI, a=0..2*PI, FillColor=RGB::Blue))
```

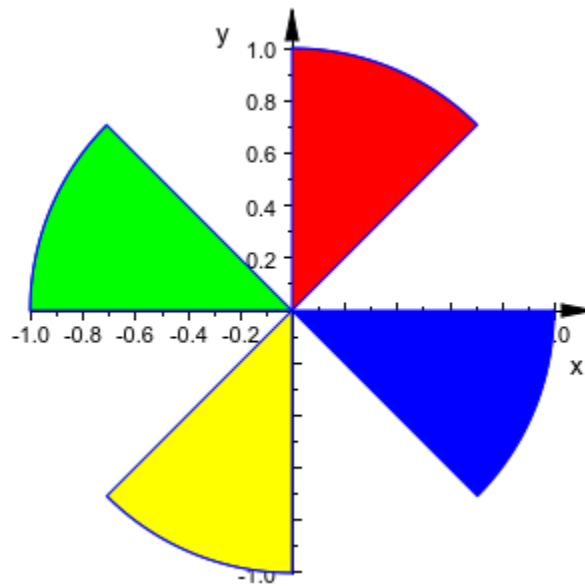

`delete arc:`

## Example 6

Create the following animated 2D arcs:

```
plot(plot::Arc2d(1, a .. PI, a = 0..PI))
```

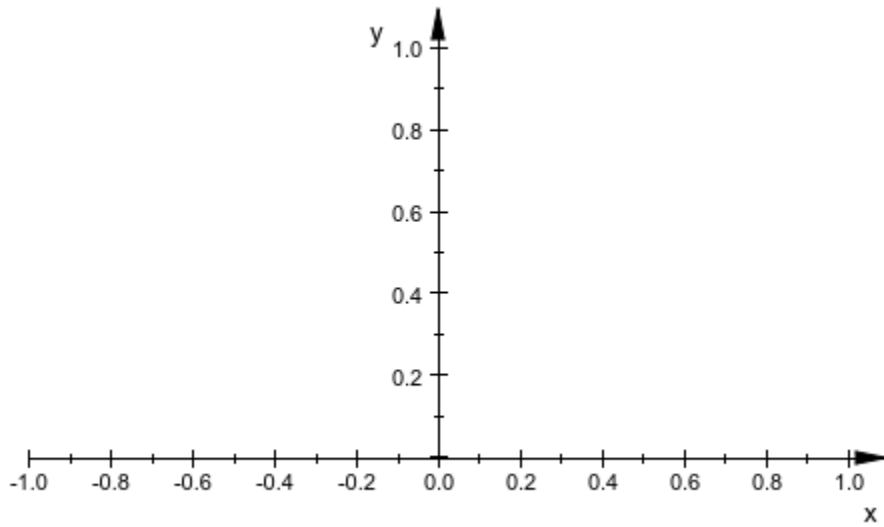

```
plot(plot::Arc2d([1 + a^2/2, 1 + a], -PI/2 .. PI/2, a = 0..4))
```

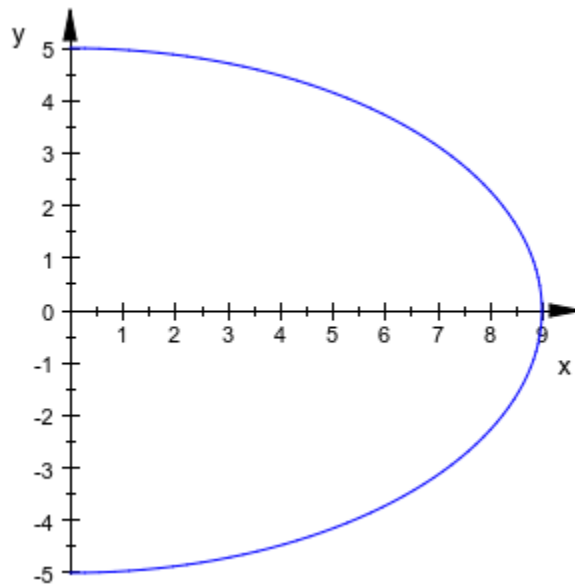

## Parameters

**r**

The radius of the circle. This must be a real numerical value or an arithmetical expression (Symbolic Math Toolbox) of the animation parameter **a**.

**r** is equivalent to the attributes `SemiAxisX`, `SemiAxisY`.

**r<sub>1</sub>, r<sub>2</sub>**

The semi-axes of an elliptical arc. They must be real numerical values or arithmetical expressions (Symbolic Math Toolbox) of the animation parameter **a**.

**r<sub>1</sub>, r<sub>2</sub>** are equivalent to the attributes `SemiAxisX`, `SemiAxisY`.

**$c_x, c_y$** 

The center point. The coordinates  $c_x, c_y$  must be real numerical values or arithmetical expressions (Symbolic Math Toolbox) of the animation parameter  $a$ . If no center is specified, an arc centered at the origin is created.

$c_x, c_y$  are equivalent to the attribute `Center`.

 **$\alpha \dots \beta$** 

The angle range in radians:  $\alpha$  and  $\beta$  must be real numerical values or arithmetical expressions (Symbolic Math Toolbox) of the animation parameter  $a$ . The default range is  $0 \dots 2\pi$ .

$\alpha \dots \beta$  is equivalent to the attribute `AngleRange`.

 **$a$** 

Animation parameter, specified as  $a = a_{\min} \dots a_{\max}$ , where  $a_{\min}$  is the initial parameter value, and  $a_{\max}$  is the final parameter value.

## See Also

**MuPAD Functions**

`plot` | `plot::copy`

**MuPAD Graphical Primitives**

`plot::Arc3d` | `plot::Circle2d` | `plot::Ellipse2d` | `plot::Ellipse3d`

# plot::Arc3d

Circular and elliptical arcs in 3D

## Syntax

```
plot::Arc3d(r, <[cx, cy, cz], <[nx, ny, nz]>>, <α .. β>, <a = amin .. amax>, options)
```

```
plot::Arc3d([r1, r2], <[cx, cy, cz], <[nx, ny, nz]>>, <α .. β>, <a = amin .. amax>, options)
```

## Description

`plot::Arc3d(r, [x, y, z], [nx, ny, nz], α .. β )` creates a circular arc with radius  $r$  and center  $(x, y, z)$  with a polar angle between  $\alpha$  and  $\beta$  in the plane with the normal vector  $(nx, ny, nz)$ .

`plot::Arc3d([r1, r2], [x, y, z], [nx, ny, nz], α .. β )` creates a corresponding elliptical arc with semi-axes  $r_1, r_2$ .

The angle of a point on the arc is the usual polar angle to the positive  $x$ -axis known from polar coordinates. It is measured in radians.

If you do not specify the range for the polar angle, `plot::Arc3d` creates a quarter circle/ellipse.

If you do not specify the center point, `plot::Arc3d` creates an arc with center  $[0, 0, 0]$ .

## Attributes

Attribute	Purpose	Default Value
AffectViewingBox	influence of objects on the ViewingBox of a scene	TRUE
Angle	rotation angle	0
AngleEnd	end of angle range	PI/2

<b>Attribute</b>	<b>Purpose</b>	<b>Default Value</b>
AngleBegin	begin of angle range	0
AngleRange	angle range	0 .. PI/2
Center	center of objects, rotation center	[0, 0, 0]
CenterX	center of objects, rotation center, x-component	0
CenterY	center of objects, rotation center, y-component	0
CenterZ	center of objects, rotation center, z-component	0
Closed	open or closed polygons	FALSE
Filled	filled or transparent areas and surfaces	FALSE
FillColor	color of areas and surfaces	RGB::LightBlue
FillColor2	second color of areas and surfaces for color blends	RGB::CornflowerBlue
FillColorType	surface filling types	Flat
FillColorDirection	the direction of color transitions on surfaces	[0, 0, 1]
FillColorDirectionX	x-component of the direction of color transitions on surfaces	0
FillColorDirectionY	y-component of the direction of color transitions on surfaces	0
FillColorDirectionZ	z-component of the direction of color transitions on surfaces	1
Frames	the number of frames in an animation	50
Legend	makes a legend entry	



Attribute	Purpose	Default Value
LegendText	short explanatory text for legend	
LegendEntry	add this object to the legend?	FALSE
LineColor	color of lines	RGB::Blue
LineWidth	width of lines	0.35
LineColor2	color of lines	RGB::DeepPink
LineStyle	solid, dashed or dotted lines?	Solid
LinesVisible	visibility of lines	TRUE
LineColorType	line coloring types	Flat
LineColorDirection	the direction of color transitions on lines	[0, 0, 1]
LineColorDirectionX	x-component of the direction of color transitions on lines	0
LineColorDirectionY	y-component of the direction of color transitions on lines	0
LineColorDirectionZ	z-component of the direction of color transitions on lines	1
Name	the name of a plot object (for browser and legend)	
Normal	normal vector of circles and discs, etc. in 3D	[0, 0, 1]
NormalX	normal vector of circles and discs, etc. in 3D, x-component	0
NormalY	normal vector of circles and discs, etc. in 3D, y-component	0
NormalZ	normal vector of circles and discs, etc. in 3D, z-component	1

<b>Attribute</b>	<b>Purpose</b>	<b>Default Value</b>
ParameterEnd	end value of the animation parameter	
ParameterName	name of the animation parameter	
ParameterBegin	initial value of the animation parameter	
ParameterRange	range of the animation parameter	
SemiAxes	semi axes of ellipses and ellipsoids	
SemiAxisX	first semi axis of ellipses and ellipsoids	1
SemiAxisY	second semi axis of ellipses and ellipsoids	1
TimeEnd	end time of the animation	10.0
TimeBegin	start time of the animation	0.0
TimeRange	the real time span of an animation	0.0 .. 10.0
Title	object title	
TitleFont	font of object titles	[" sans-serif ", 11]
TitlePosition	position of object titles	
TitleAlignment	horizontal alignment of titles w.r.t. their coordinates	Center
TitlePositionX	position of object titles, x component	
TitlePositionY	position of object titles, y component	
TitlePositionZ	position of object titles, z component	
Visible	visibility	TRUE

Attribute	Purpose	Default Value
VisibleAfter	object visible after this time value	
VisibleBefore	object visible until this time value	
VisibleFromTo	object visible during this time range	
VisibleAfterEnd	object visible after its animation time ended?	TRUE
VisibleBeforeBegin	object visible before its animation time starts?	TRUE

## Examples

### Example 1

Plot an animated 3D arc:

```
plot(plot::Arc3d(1, [0,0,0], [0,a,1-a], 0..3/2*PI, a = 0..1))
```

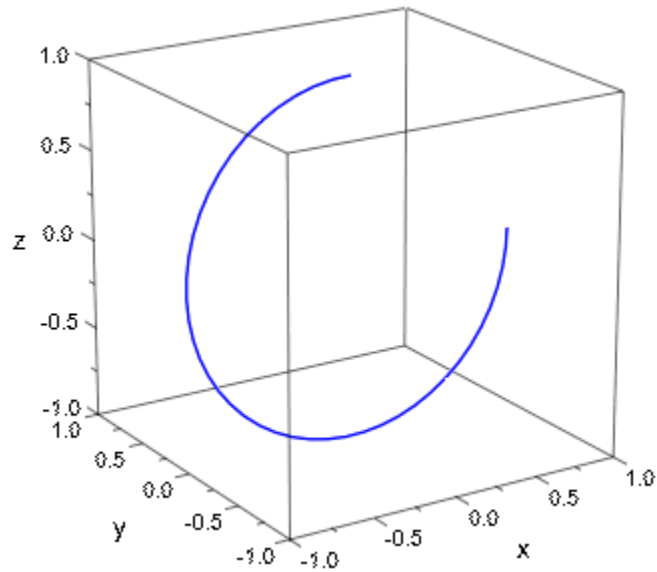

## Example 2

Plot a colored 3D arcs:

```
plot(plot::Arc3d(1, [0,0,0], 0.1..2*PI-0.1, Filled,  
      LineColor=RGB::Yellow, LineColor2=RGB::Red,  
      LineColorType = Dichromatic, LineColorDirection=[+1,0,0],  
      FillColor=RGB::Yellow, FillColor2=RGB::Red,  
      FillColorType = Dichromatic, FillColorDirection=[-1,0,0]  
))
```

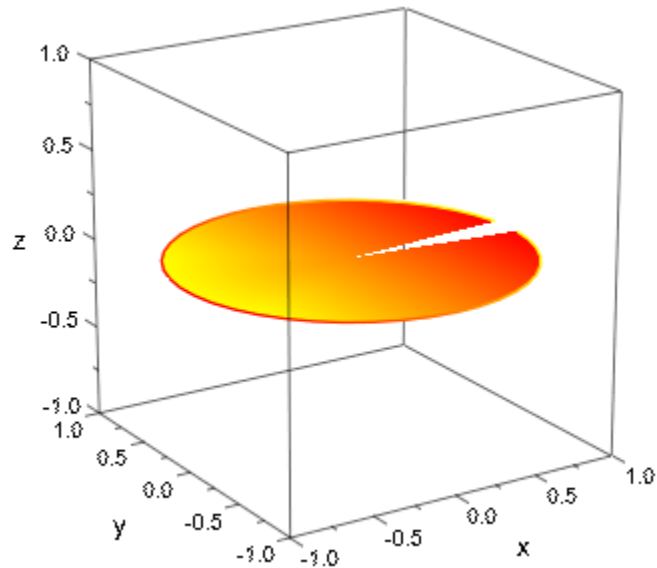

## Parameters

**r**

The radius of the circle. This must be a real numerical value or an arithmetical expression (Symbolic Math Toolbox) of the animation parameter **a**.

**r** is equivalent to the attributes `SemiAxisX`, `SemiAxisY`.

**r<sub>1</sub>, r<sub>2</sub>**

The semi-axes of an elliptical arc. They must be real numerical values or arithmetical expressions (Symbolic Math Toolbox) of the animation parameter **a**.

**r<sub>1</sub>, r<sub>2</sub>** are equivalent to the attributes `SemiAxisX`, `SemiAxisY`.

**$c_x, c_y, c_z$** 

The center point. The coordinates  $c_x, c_y, c_z$  must be real numerical values or arithmetical expressions (Symbolic Math Toolbox) of the animation parameter  $a$ . If no center is specified, an arc centered at the origin is created.

$c_x, c_y, c_z$  are equivalent to the attribute `Center`.

 **$n_x, n_y, n_z$** 

The normal vector. The coordinates  $n_x, n_y, n_z$  must be real numerical values or arithmetical expressions (Symbolic Math Toolbox) of the animation parameter  $a$ . If no normal vector is specified, the arc is created in the  $xy$ -plane.

$n_x, n_y, n_z$  are equivalent to the attribute `Normal`.

 **$\alpha \dots \beta$** 

The angle range in radians:  $\alpha$  and  $\beta$  must be real numerical values or arithmetical expressions (Symbolic Math Toolbox) of the animation parameter  $a$ . The default range is  $0 \dots 2*PI$ .

$\alpha \dots \beta$  is equivalent to the attribute `AngleRange`.

 **$a$** 

Animation parameter, specified as  $a = a_{min} \dots a_{max}$ , where  $a_{min}$  is the initial parameter value, and  $a_{max}$  is the final parameter value.

## See Also

**MuPAD Functions**

`plot` | `plot::copy`

**MuPAD Graphical Primitives**

`plot::Arc2d` | `plot::Circle2d` | `plot::Ellipse2d` | `plot::Ellipse3d`

# plot::Arrow2d

2D arrows

## Syntax

```
plot::Arrow2d(<[x1, y1>, [x2, y2], <a = amin .. amax>, options)
```

## Description

`plot::Arrow2d([x1, y1], [x2, y2])` creates a 2D arrow from the point (x<sub>1</sub>, y<sub>1</sub>) to the point (x<sub>2</sub>, y<sub>2</sub>).

`plot::Arrow2d([x2, y2])` creates a 2D arrow from the point (0, 0) to the point (x<sub>2</sub>, y<sub>2</sub>).

The points defining an arrow can also be passed as vectors.

The appearance of arrows can be controlled by various attributes:

- `Color` sets the color.
- `LineWidth` and `LineStyle` set the width and the style (solid, dashed, dotted).
- `TipLength`, `TipAngle`, and `TipStyle` control the arrow tip.

## Attributes

Attribute	Purpose	Default Value
<code>AffectViewingBox</code>	influence of objects on the <code>ViewingBox</code> of a scene	TRUE
<code>AntiAliased</code>	antialiased lines and points?	TRUE
<code>Color</code>	the main color	RGB::Blue
<code>Frames</code>	the number of frames in an animation	50

<b>Attribute</b>	<b>Purpose</b>	<b>Default Value</b>
From	starting point of arrows and lines	[0, 0]
FromX	starting point of arrows and lines, x-coordinate	0
FromY	starting point of arrows and lines, y-coordinate	0
Legend	makes a legend entry	
LegendText	short explanatory text for legend	
LegendEntry	add this object to the legend?	FALSE
LineColor	color of lines	RGB::Blue
LineWidth	width of lines	0.35
LineStyle	solid, dashed or dotted lines?	Solid
LineColorDirection	the direction of color transitions on lines	[0, 1]
LineColorDirectionX	x-component of the direction of color transitions on lines	0
LineColorDirectionY	y-component of the direction of color transitions on lines	1
Name	the name of a plot object (for browser and legend)	
ParameterEnd	end value of the animation parameter	
ParameterName	name of the animation parameter	
ParameterBegin	initial value of the animation parameter	
ParameterRange	range of the animation parameter	
TimeEnd	end time of the animation	10.0



Attribute	Purpose	Default Value
TimeBegin	start time of the animation	0.0
TimeRange	the real time span of an animation	0.0 .. 10.0
TipAngle	opening angle of arrow heads	$(2 \cdot \text{PI}) / 15$
TipStyle	presentation style of arrow heads	Filled
TipLength	length of arrow heads	4
Title	object title	
TitleFont	font of object titles	[" sans-serif ", 11]
TitlePosition	position of object titles	
TitleAlignment	horizontal alignment of titles w.r.t. their coordinates	Center
TitlePositionX	position of object titles, x component	
TitlePositionY	position of object titles, y component	
To	end point of arrows and lines	[1, 0]
ToX	end point of arrows and lines, x-coordinate	1
ToY	end point of arrows and lines, y-coordinate	0
Visible	visibility	TRUE
VisibleAfter	object visible after this time value	
VisibleBefore	object visible until this time value	
VisibleFromTo	object visible during this time range	

Attribute	Purpose	Default Value
VisibleAfterEnd	object visible after its animation time ended?	TRUE
VisibleBeforeBegin	object visible before its animation time starts?	TRUE

## Examples

### Example 1

Create and plot the following arrows:

```
plot(plot::Arrow2d([1, 1]), plot::Arrow2d([1, 3]),
      plot::Arrow2d([1, 1], [1, 3]))
```

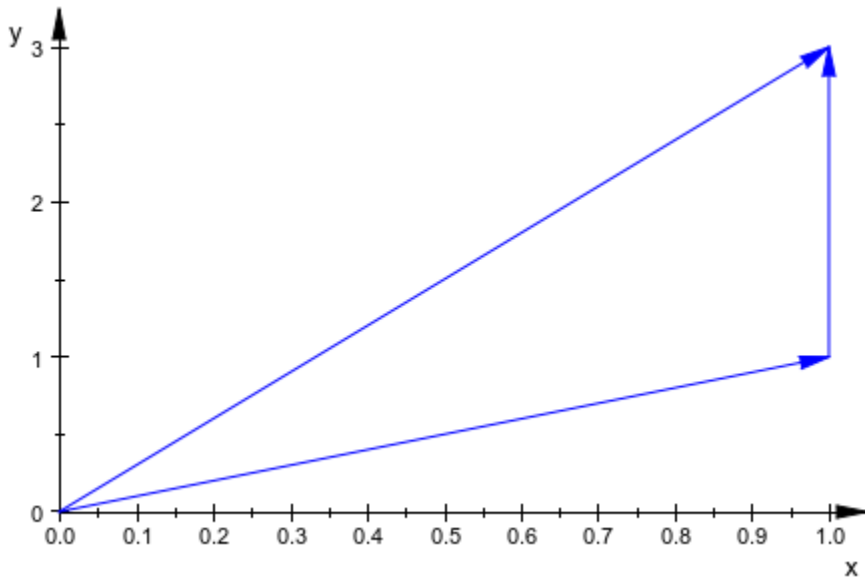

Various attributes are available to control the presentation style of an arrow:

```
plot(plot::Arrow2d([1, 1], Color = RGB::Red,
                  TipStyle = Open, TipLength = 10*unit::mm),
```

```
plot::Arrow2d([-1, 1], Color = RGB::Green,  
              LineWidth = 0.8*unit::mm,  
              TipStyle = Closed, TipAngle = PI/2),  
plot::Arrow2d([0, -sqrt(2)], Color = RGB::Blue,  
              LineStyle = Dashed),  
Axes = None)
```

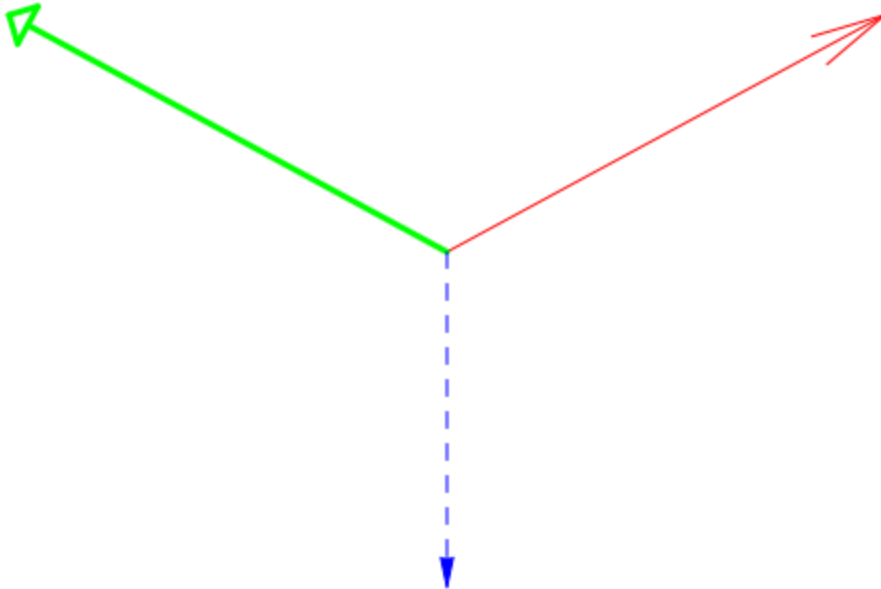

## Example 2

Plot an arrow with fixed starting point and animated end point:

```
plot(plot::Circle2d(2, [1, 2]),  
      plot::Arrow2d([1, 2], [1 + 2*cos(a), 2 + 2*sin(a)],  
                    a = 0..2*PI))
```

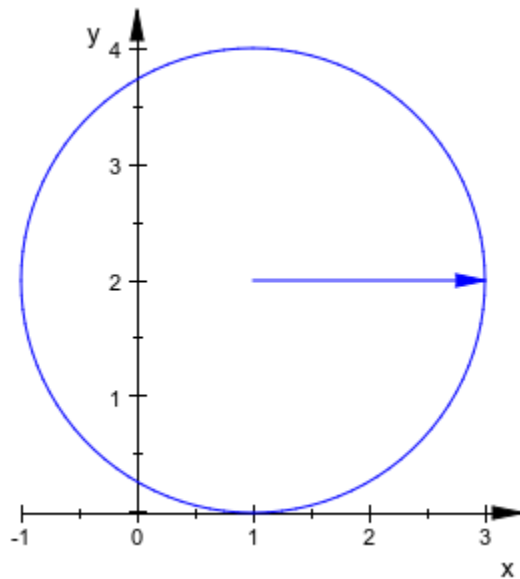

## Parameters

### $x_1, y_1$

The coordinates of the starting point: real numerical values or arithmetical expressions (Symbolic Math Toolbox) of the animation parameter  $a$ . If no starting point is specified, an arrow starting at the origin is created.

$x_1, y_1$  are equivalent to the attributes FromX, FromY.

### $x_2, y_2$

The coordinates of the end point: real numerical values or arithmetical expressions (Symbolic Math Toolbox) of the animation parameter  $a$ .

$x_2, y_2$  are equivalent to the attributes ToX, ToY.

**a**

Animation parameter, specified as  $a = a_{\min} .. a_{\max}$ , where  $a_{\min}$  is the initial parameter value, and  $a_{\max}$  is the final parameter value.

## See Also

**MuPAD Functions**

plot | plot::copy

**MuPAD Graphical Primitives**

plot::Arrow3d | plot::Line2d | plot::Line3d | plot::VectorField2d

## plot::Arrow3d

3D arrows

### Syntax

```
plot::Arrow3d(<[x1, y1, z1]>, [x2, y2, z2], <a = amin .. amax>, options)
```

### Description

`plot::Arrow3d([x1, y1, z1], [x2, y2, z2])` creates a 3D arrow from the point (x<sub>1</sub>, y<sub>1</sub>, z<sub>1</sub>) to the point (x<sub>2</sub>, y<sub>2</sub>, z<sub>2</sub>).

`plot::Arrow3d([x2, y2, z2])` creates a 3D arrow from the point (0, 0, 0) to the point (x<sub>2</sub>, y<sub>2</sub>, z<sub>2</sub>).

The points defining an arrow can also be passed as vectors.

The appearance of arrows can be controlled by various attributes:

- `Color` sets the color.
- `LineWidth` and `LineStyle` set the width and the style (solid, dashed, dotted).
- `TipLength`, `TipAngle`, and `TipStyle` control the arrow tip.
- With `Tubular = TRUE`, 3D arrows are rendered as 3D tubes with a diameter set by `TubeDiameter`. The arrow head is rendered as a cone.

### Attributes

Attribute	Purpose	Default Value
<code>AffectViewingBox</code>	influence of objects on the <code>ViewingBox</code> of a scene	TRUE
<code>Color</code>	the main color	RGB::Blue

Attribute	Purpose	Default Value
Frames	the number of frames in an animation	50
From	starting point of arrows and lines	[0, 0, 0]
FromX	starting point of arrows and lines, x-coordinate	0
FromY	starting point of arrows and lines, y-coordinate	0
FromZ	starting point of arrows and lines, z-coordinate	0
Legend	makes a legend entry	
LegendText	short explanatory text for legend	
LegendEntry	add this object to the legend?	FALSE
LineColor	color of lines	RGB::Blue
LineWidth	width of lines	0.35
LineStyle	solid, dashed or dotted lines?	Solid
LineColorDirection	the direction of color transitions on lines	[0, 0, 1]
LineColorDirectionX	x-component of the direction of color transitions on lines	0
LineColorDirectionY	y-component of the direction of color transitions on lines	0
Name	the name of a plot object (for browser and legend)	
ParameterEnd	end value of the animation parameter	
ParameterName	name of the animation parameter	

<b>Attribute</b>	<b>Purpose</b>	<b>Default Value</b>
ParameterBegin	initial value of the animation parameter	
ParameterRange	range of the animation parameter	
TimeEnd	end time of the animation	10.0
TimeBegin	start time of the animation	0.0
TimeRange	the real time span of an animation	0.0 .. 10.0
TipAngle	opening angle of arrow heads	$(2*PI)/15$
TipStyle	presentation style of arrow heads	Filled
TipLength	length of arrow heads	4
Title	object title	
TitleFont	font of object titles	[" sans-serif ", 11]
TitlePosition	position of object titles	
TitleAlignment	horizontal alignment of titles w.r.t. their coordinates	Center
TitlePositionX	position of object titles, x component	
TitlePositionY	position of object titles, y component	
TitlePositionZ	position of object titles, z component	
To	end point of arrows and lines	[1, 0, 0]
ToX	end point of arrows and lines, x-coordinate	1
ToY	end point of arrows and lines, y-coordinate	0



Attribute	Purpose	Default Value
ToZ	end point of arrows and lines, z-coordinate	0
Tubular	display 3D arrows and lines as tubes?	FALSE
TubeDiameter	diameter of tubular arrows and lines.	1.0
Visible	visibility	TRUE
VisibleAfter	object visible after this time value	
VisibleBefore	object visible until this time value	
VisibleFromTo	object visible during this time range	
VisibleAfterEnd	object visible after its animation time ended?	TRUE
VisibleBeforeBegin	object visible before its animation time starts?	TRUE

## Examples

### Example 1

We create and plot some arrows:

```
plot(plot::Arrow3d([1, 1, 1]), plot::Arrow3d([1, 3, 2]),
      plot::Arrow3d([1, 1, 1], [1, 3, 2]))
```

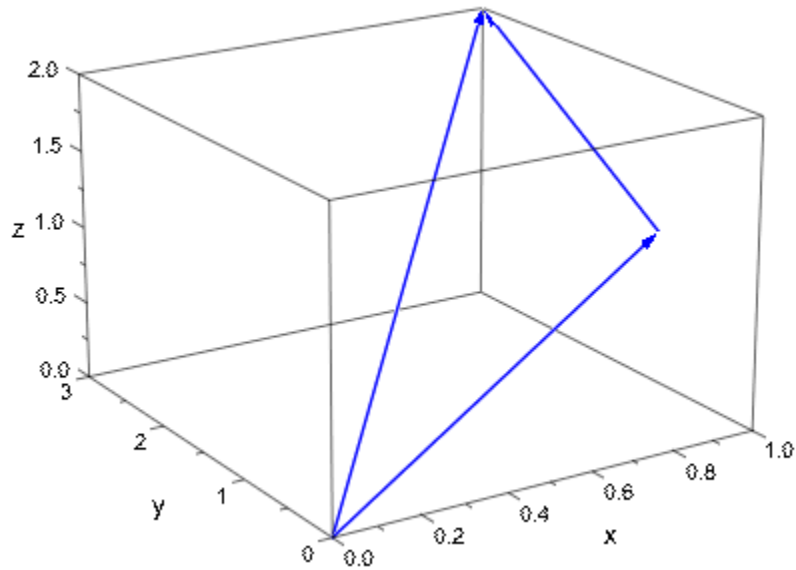

Various attributes are available to control the presentation style of an arrow:

```
plot(plot::Arrow3d([1, 1, 0], Color = RGB::Red,  
                 TipStyle = Open, TipLength = 10*unit::mm),  
      plot::Arrow3d([-1, 1, 0], Color = RGB::Green,  
                 LineWidth = 0.8*unit::mm,  
                 TipStyle = Closed, TipAngle = PI/2),  
      plot::Arrow3d([0, -sqrt(2), 0], Color = RGB::Blue,  
                 LineStyle = Dashed),  
      CameraDirection = [0, -1, 1000])
```

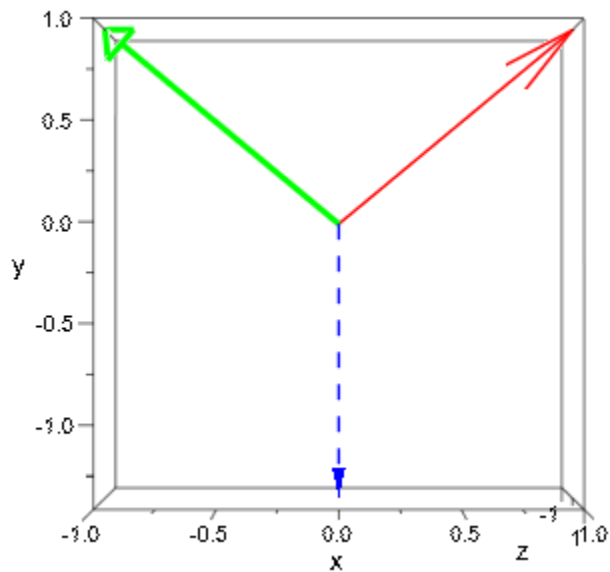

Use Tubular = TRUE:

```
plot(plot::Arrow3d([1, 1, 0], Color = RGB::Red,
  TipLength = 10*unit::mm),
  plot::Arrow3d([-1, 1, 0], Color = RGB::Green,
  TubeDiameter = 1.5*unit::mm,
  TipAngle = PI/2),
  plot::Arrow3d([0, -sqrt(2), 0], Color = RGB::Blue),
  Tubular = TRUE, CameraDirection = [0, -1, 1000])
```

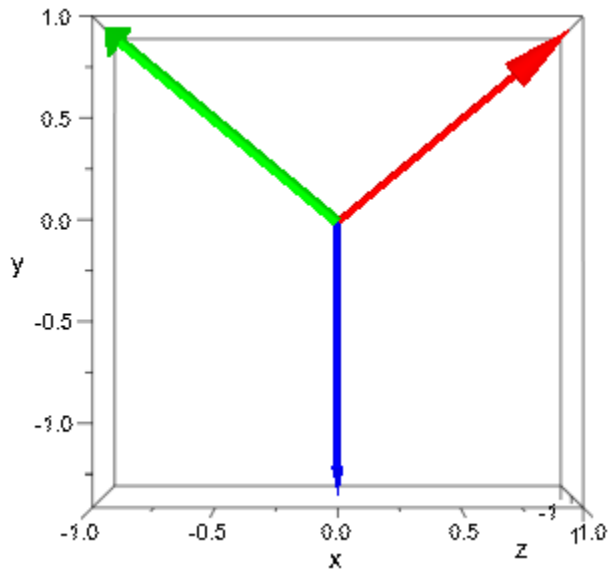

## Parameters

### $x_1, y_1, z_1$

The coordinates of the starting point: real numerical values or arithmetical expressions (Symbolic Math Toolbox) of the animation parameter  $a$ . If no starting point is specified, an arrow starting at the origin is created.

$x_1, y_1, z_1$  are equivalent to the attributes FromX, FromY, FromZ.

### $x_2, y_2, z_2$

The coordinates of the end point: real numerical values or arithmetical expressions (Symbolic Math Toolbox) of the animation parameter  $a$ .

$x_2, y_2, z_2$  are equivalent to the attributes ToX, ToY, ToZ.

**a**

Animation parameter, specified as  $\mathbf{a} = \mathbf{a}_{\min} \dots \mathbf{a}_{\max}$ , where  $\mathbf{a}_{\min}$  is the initial parameter value, and  $\mathbf{a}_{\max}$  is the final parameter value.

## See Also

**MuPAD Functions**

plot | plot::copy

**MuPAD Graphical Primitives**

plot::Arrow2d | plot::Line2d | plot::Line3d | plot::VectorField2d

## plot::Bars2d

2D bar chart

### Syntax

```
plot::Bars2d([[a1, a2, ...], [b1, b2, ...], ...], <a = amin .. amax>, options)
```

```
plot::Bars2d([a1, a2, ...], <a = amin .. amax>, options)
```

### Description

`plot::Bars2d([[ a1, a2, ...], [ b1, b2, ...], ...])` generates a bar chart with bar heights `a1, b1, ..., a2, b2, ...`.

`plot::Bars2d([ a1, a2, ...])` creates a bar chart with bars of height `a1, a2, ...`.

With `plot::Bars2d([[ a1, a2, ...], [ b1, b2, ...], ...])`, bars are plotted in the order `a1, b1, ..., a gap, a2, b2, ...`. Cf. “Example 2” on page 24-130 (Symbolic Math Toolbox).

The horizontal positions and the widths of the bars may be controlled by the attributes `BarCenters` and `BarWidths`, respectively.

The attribute `GroupStyle` provides grouping options.

### Attributes

Attribute	Purpose	Default Value
<code>AffectViewingBox</code>	influence of objects on the <code>ViewingBox</code> of a scene	TRUE
<code>AntiAliased</code>	antialiased lines and points?	FALSE
<code>BarStyle</code>	display style of bar plots	Boxes
<code>BarWidths</code>	widths of bars	[[1.0]]

<b>Attribute</b>	<b>Purpose</b>	<b>Default Value</b>
BarCenters	position of bars	
Color	the main color	
Colors	list of colors to use	[RGB::Blue, RGB::Red, RGB::Green, RGB::MuPADGold, RGB::Orange, RGB::Cyan, RGB::Magenta, RGB::LimeGreen, RGB::CadmiumYellowLight, RGB::AlizarinCrimson, RGB::Aqua, RGB::Lavender, RGB::SeaGreen, RGB::AureolineYellow, RGB::Banana, RGB::Beige, RGB::YellowGreen, RGB::Wheat, RGB::IndianRed, RGB::Black]
Data	the (statistical) data to plot	
DrawMode	orientation of boxes and bars	Vertical
Filled	filled or transparent areas and surfaces	TRUE
FillPatterns	list of area fill types	[Solid]
Frames	the number of frames in an animation	50
GroupStyle	grouping options in 2D bar plots	MultipleBars
Legend	makes a legend entry	
LegendText	short explanatory text for legend	

Attribute	Purpose	Default Value
LegendEntry	add this object to the legend?	FALSE
LineColor	color of lines	RGB::Black
LineWidth	width of lines	0.35
LineStyle	solid, dashed or dotted lines?	Solid
LinesVisible	visibility of lines	TRUE
Name	the name of a plot object (for browser and legend)	
ParameterEnd	end value of the animation parameter	
ParameterName	name of the animation parameter	
ParameterBegin	initial value of the animation parameter	
ParameterRange	range of the animation parameter	
PointSize	the size of points	1.5
PointStyle	the presentation style of points	FilledCircles
Shadows	display "shadows" for bar plots?	FALSE
TimeEnd	end time of the animation	10.0
TimeBegin	start time of the animation	0.0
TimeRange	the real time span of an animation	0.0 .. 10.0
Title	object title	
TitleFont	font of object titles	[" sans-serif ", 11]
TitlePosition	position of object titles	
TitleAlignment	horizontal alignment of titles w.r.t. their coordinates	Center



Attribute	Purpose	Default Value
TitlePositionX	position of object titles, x component	
TitlePositionY	position of object titles, y component	
Visible	visibility	TRUE
VisibleAfter	object visible after this time value	
VisibleBefore	object visible until this time value	
VisibleFromTo	object visible during this time range	
VisibleAfterEnd	object visible after its animation time ended?	TRUE
VisibleBeforeBegin	object visible before its animation time starts?	TRUE

## Examples

### Example 1

Given a single list of values, `plot::Bars2d` plots bars of the corresponding height, filled solidly in one color:

```
plot(plot::Bars2d([1, 2, 3, 4, 5]))
```

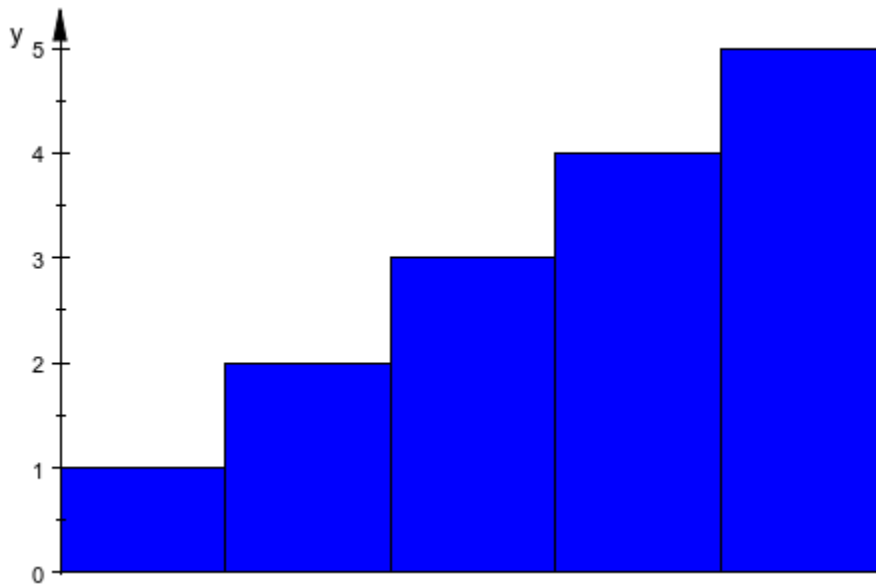

## Example 2

When asked to plot a list of lists of values, `plot::Bars2d` will group the first entries of all lists, the second entries and so on, with a small gap between the groups:

```
plot(plot::Bars2d([[ 5, 10, 24, -3],  
                  [ 6,  5,  2, 18],  
                  [19, 45, 12, -10]]))
```

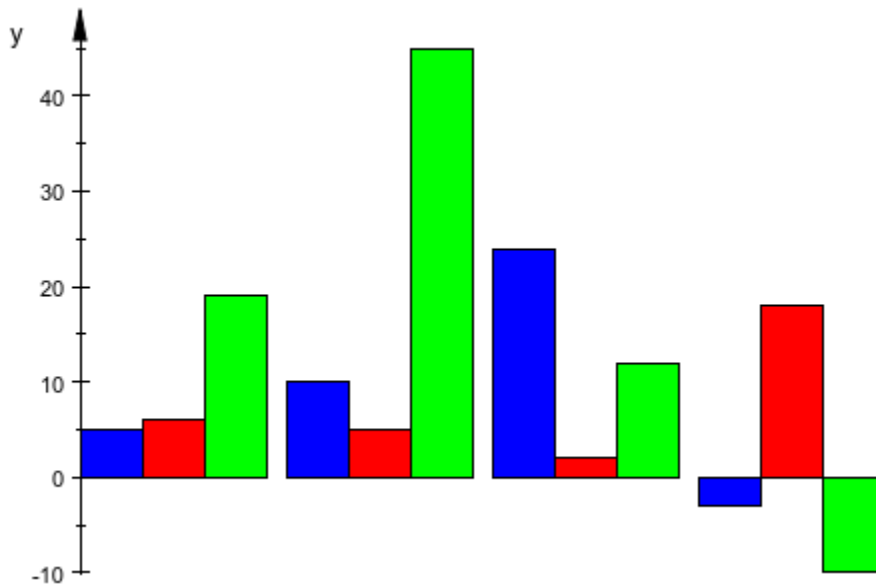

### Example 3

The appearance of the plots can be controlled with a number of attributes. For example, `Colors` accepts a list of colors for the bars and `Shadows` switches on “shadows,” giving a slight impression of depth:

```
plot(plot::Bars2d([[ 5, 10, 24, -3],  
                  [ 6,  5,  2, 18],  
                  [19, 45, 12, -10]],  
      Colors = [RGB::Red, RGB::Green, RGB::Blue],  
      Shadows = TRUE))
```

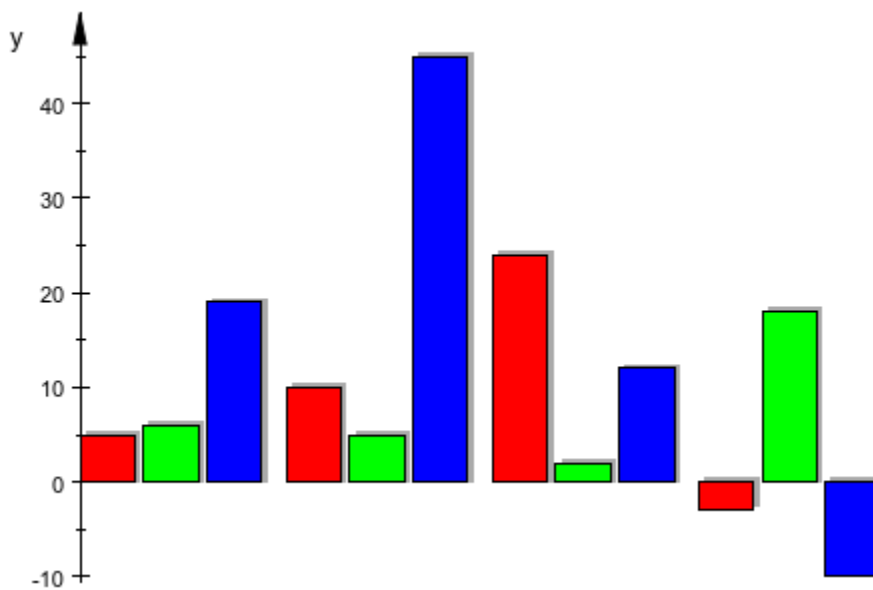

Using `DrawMode`, `plot::Bars2d` can be made to draw horizontal bars instead of vertical ones:

```
plot(plot::Bars2d([[ .5, 1.0, 2.4, -.3],  
                  [.6, .5, .2, 1.8],  
                  [1.9, 4.5, 1.2, -1.0]],  
      Colors = [RGB::Red,RGB::Green,RGB::Blue],  
      Shadows = TRUE, DrawMode = Horizontal))
```

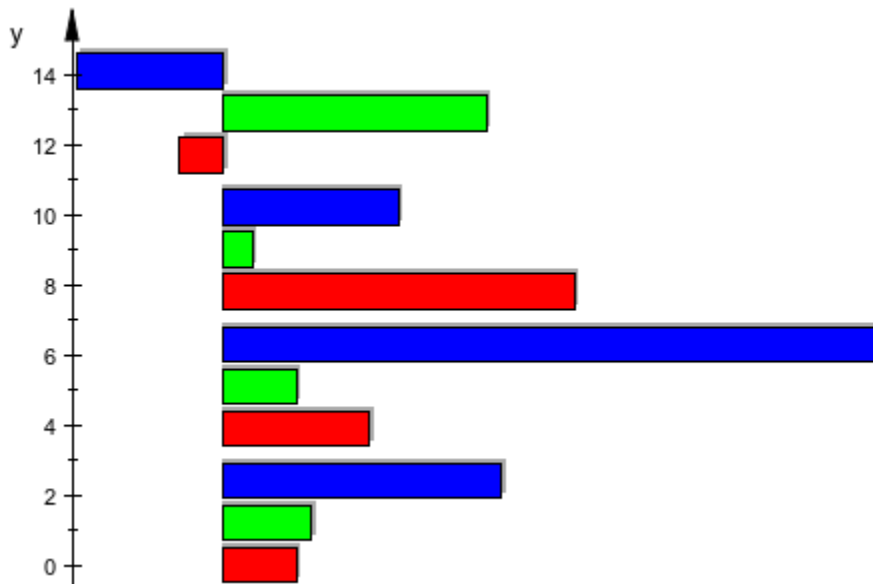

BarStyle is used to plot points or lines instead of rectangles:

```
plot(plot::Bars2d([[ 5, 10, 24, -3],  
                  [ 6,  5,  2, 18],  
                  [19, 45, 12, -10]], BarStyle = Lines))
```

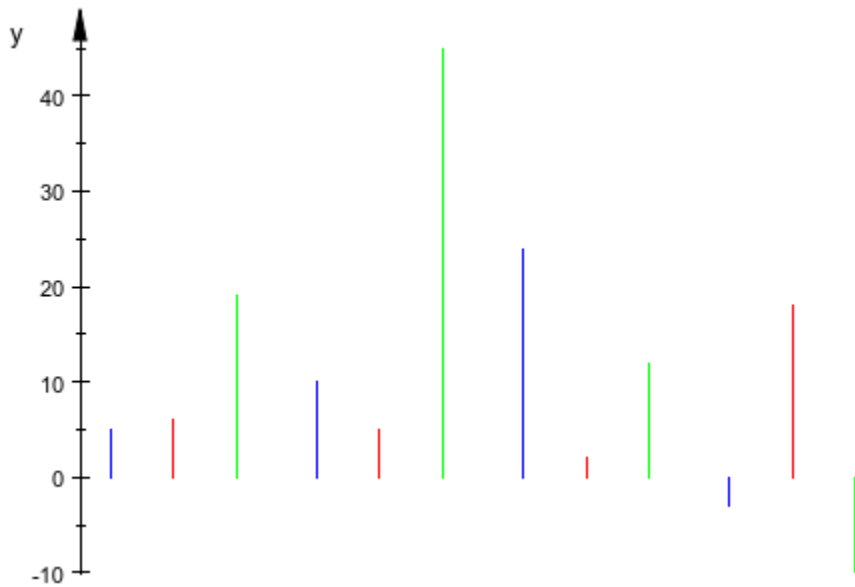

### Example 4

We demonstrate alternative grouping styles:

```
plot(plot::Bars2d([[ 5, 10, 15, 20],  
                  [ 6,  5,  4,  3],  
                  [10,  5,  3,  1]], GroupStyle = MultipleBars))
```

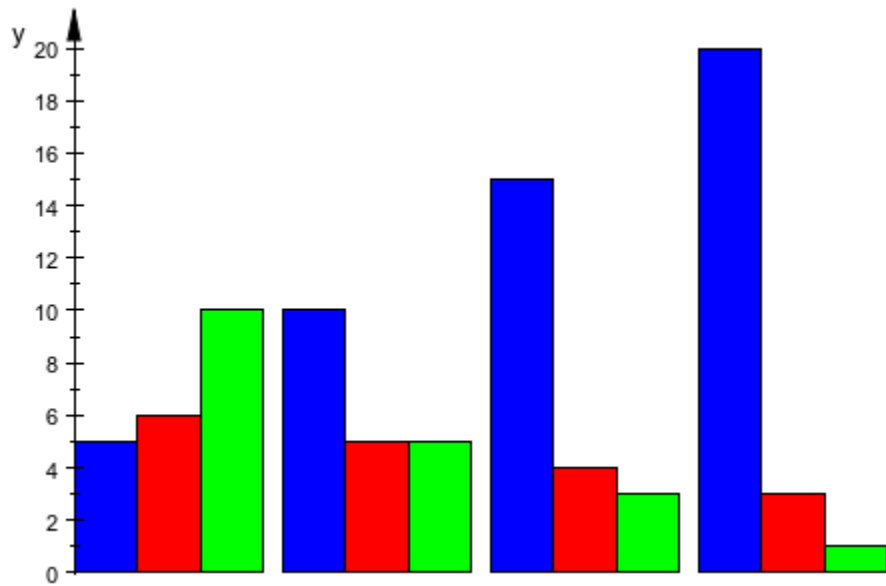

```
plot(plot::Bars2d([[ 5, 10, 15, 20],  
                  [ 6,  5,  4,  3],  
                  [10,  5,  3,  1]], GroupStyle = SingleBars))
```

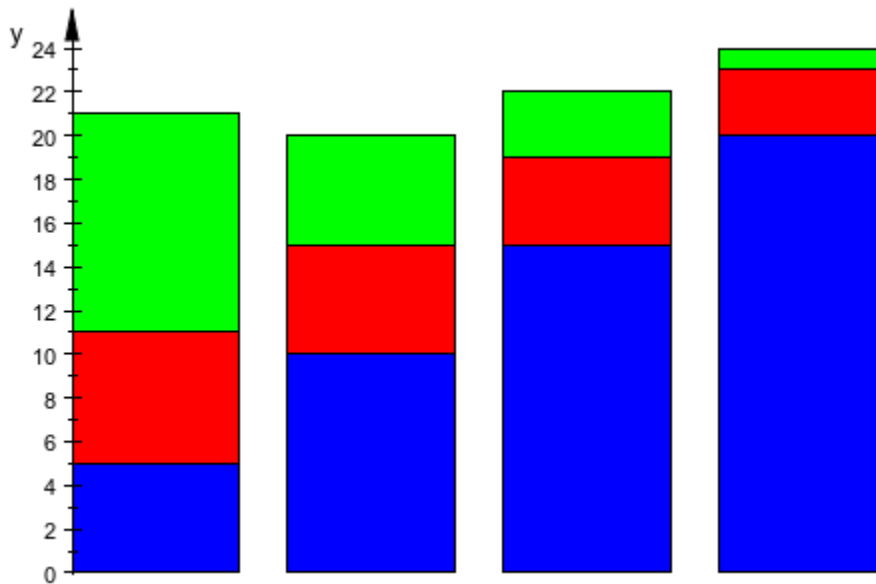

### Example 5

To plot a single group of data with different colors, they must be placed in individual lists:

```
plot(plot::Bars2d([[binomial(15,i)] $ i = 0..15],  
                Colors = [[1-j/15, j/15, 0.9] $ j = 0..15]),  
      XAxisVisible)
```



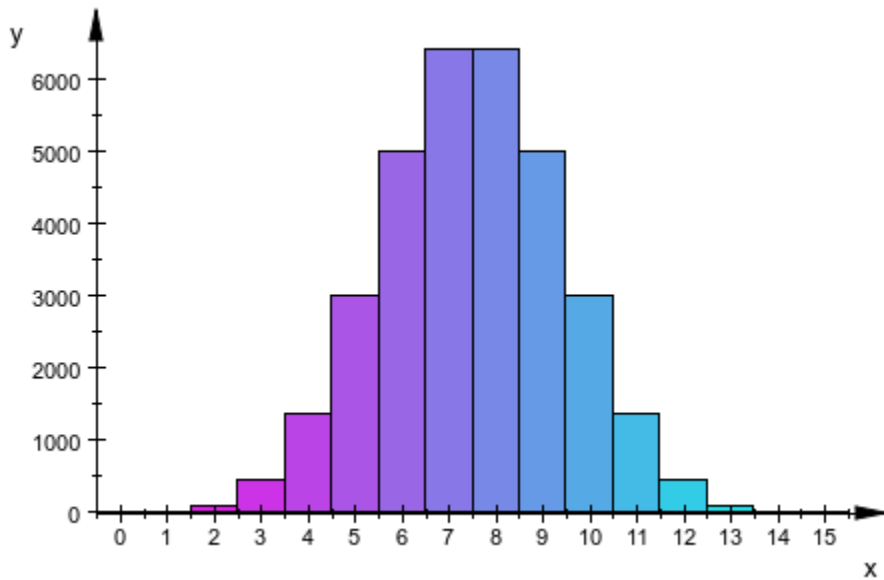

## Example 6

`plot::Bars2d` accepts input in form of lists (as above), as a matrix, or as a one- or two-dimensional array:

```
L := [ [2, 1, 2, 4, 5],
        [1, 2, 3, 2, 1],
        [2, -1, -3, 1, 2],
        [5, 4, 3, 2, 1],
        [2, 1, 2, 1, 2] ]:
M := matrix(L):
A := array(1..5, 1..5,
          (1,1) = 2, (1,2) = 1, (1,3) = 2, (1,4) = 4, (1,5) = 5,
          (2,1) = 1, (2,2) = 2, (2,3) = 3, (2,4) = 2, (2,5) = 1,
          (3,1) = 2, (3,2) = 1, (3,3) = -3, (3,4) = 1, (3,5) = 2,
          (4,1) = 5, (4,2) = 4, (4,3) = 3, (4,4) = 2, (4,5) = 1,
          (5,1) = 2, (5,2) = 1, (5,3) = 2, (5,4) = 1, (5,5) = 2):
plot(plot::Bars2d(L))
```

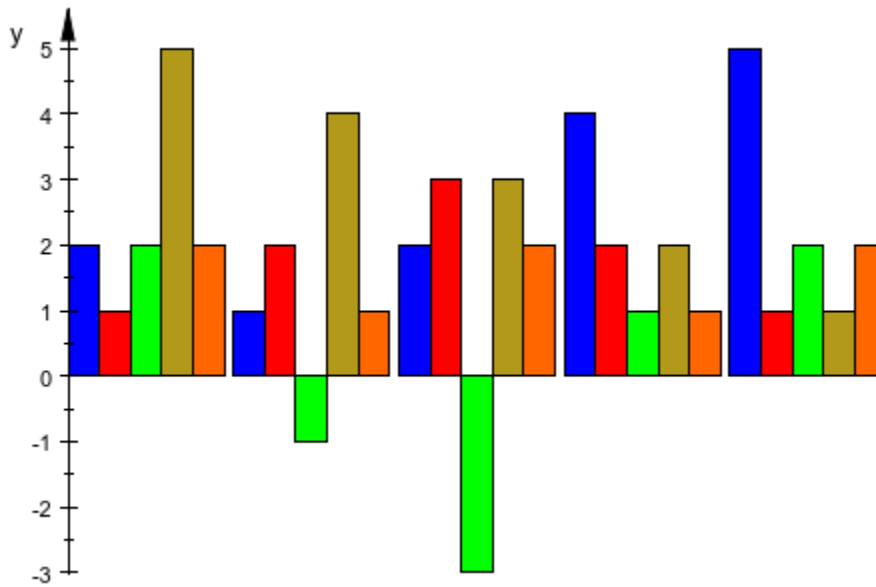

```
plot(plot::Bars2d(M))
```

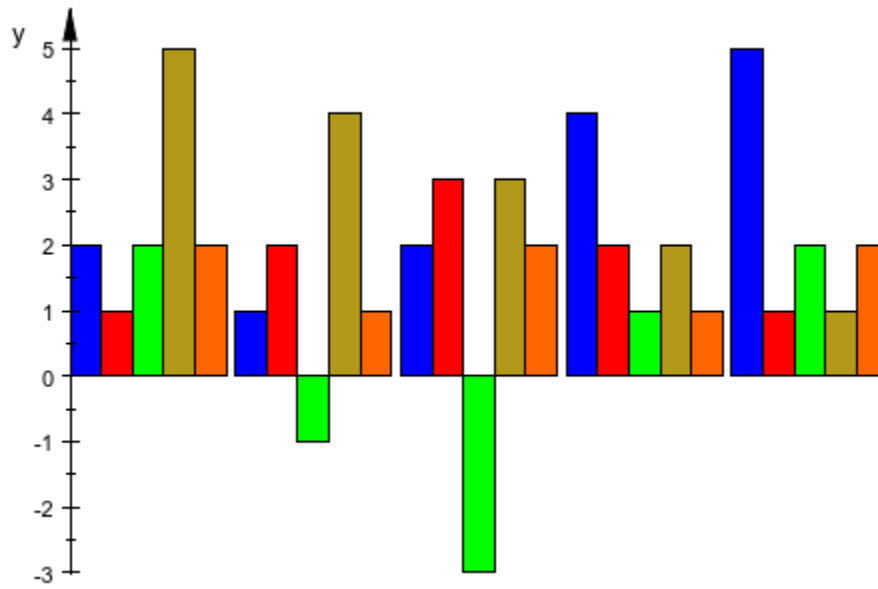

```
plot(plot::Bars2d(A))
```

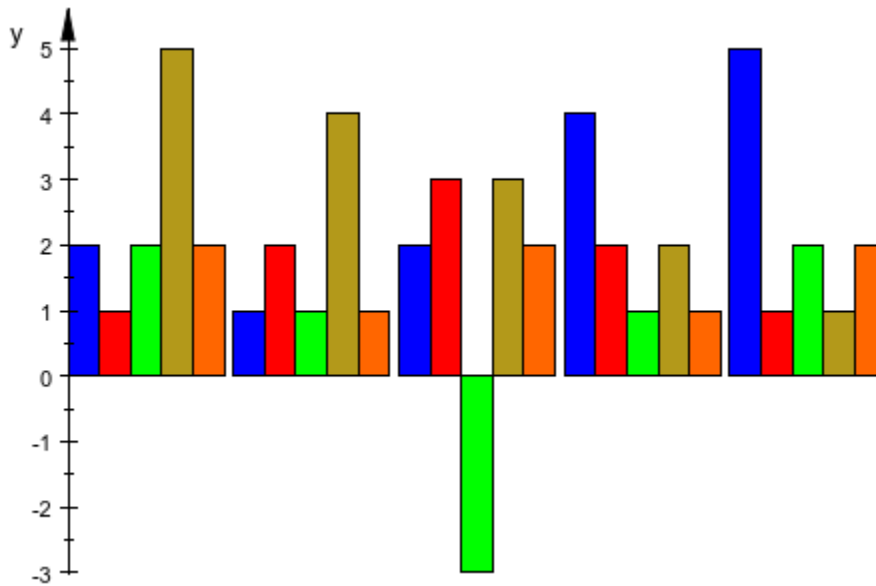

### Example 7

Here is a real life example of a bar plot taken from a German magazine. It visualizes data related to waste management. We reproduce the plot via MuPAD. The main ingredient is a bar plot generated via `plot::Bars2d` with the option `GroupStyle = SingleBars`. Generating the annotations is somewhat tricky:

```
data := [[25 , 24.6, 30.8 ],
         [ 2 ,  2.8, 11  ],
         [ 7.1,  3.3,  4.05]]:

sw := 1.5:
bw := 2.0:
n := nops(data):
w := sw + bw:
myticks := [(i-1)* w + sw + bw/2 $ i = 1..n]:

m := nops(data[1]):

datalabels := ["Prognos", "LAGA", "BDE"]:
```

```

// cumulative data for the groups
datasums := _concat(datalabels[i].": ".
                    expr2text(_plus(data[j][i]$j=1..m)).
                    " megatons " $i=1..n):

// generate a list of text objects containing the data values
// and place them in the centers of the bars:
datatext := []:
for i from 1 to n do
  h := 0;
  for j from 1 to m do
    d := data[j][i];
    datatext := datatext, plot::Text2d(expr2text(d),
                                        [myticks[i], h + d/2],
                                        TextFont = [8, RGB::White],
                                        VerticalAlignment = Center,
                                        HorizontalAlignment = Center);

    h := h + d
  end
end:
end:

```

Here is the bar plot with the annotations. Many scene options are used to fine tune the graphics:

```

S1:=plot::Scene2d(
  plot::Bars2d(data,
    Colors=[RGB::LimeGreen, RGB::Blue, RGB::Red],
    GroupStyle = SingleBars,
    BarCenters = [myticks[i] $ i=1..n],
    BarWidths = [[bw]],
    DrawMode = Vertical),

  // scene options:

  ViewingBox = [0 .. w*n + sw, 0 .. 50],

  // options for the grid
  XGridVisible = FALSE,
  YGridVisible = TRUE,
  XSubgridVisible = FALSE,
  YSubgridVisible = TRUE,
  GridLineColor = RGB::DarkGrey,
  SubgridLineColor = RGB::DarkGrey,

  // options for the axes

```

```
    Axes = Boxed,  
    AxesTips = FALSE,  
    AxesInFront = TRUE,  
    AxesTitleFont = ["Arial", 12, Bold],  
    XAxisVisible = TRUE,  
    YAxisTitleOrientation = Vertical,  
    YAxisTitleAlignment = Center,  
    YAxisTitle = "megatons",  
    XAxisTitle = "",  
  
    // options for the ticks along the axes  
    TicksLabelFont = ["Arial", 10],  
    XTicksVisible = FALSE,  
    XTicksNumber = None,  
    XTicksAt = [myticks[i] = datalabels[i] $ i=1..n],  
  
    // layout  
    RightMargin = 50,  
  
    // annotation  
    datatext,  
  
    // header and footer  
    Header = "Capacities in megatons",  
    HeaderFont = ["Arial", 12, Bold],  
    Footer = "\n\nAmount of waste taken into account:\n".datasums,  
    FooterFont = ["Arial", 8],  
    FooterAlignment = Left,  
  
    // use a yellowish background  
    BackgroundColor = [0.886275, 0.870588, 0.294118]  
):  
  
plot(S1)
```

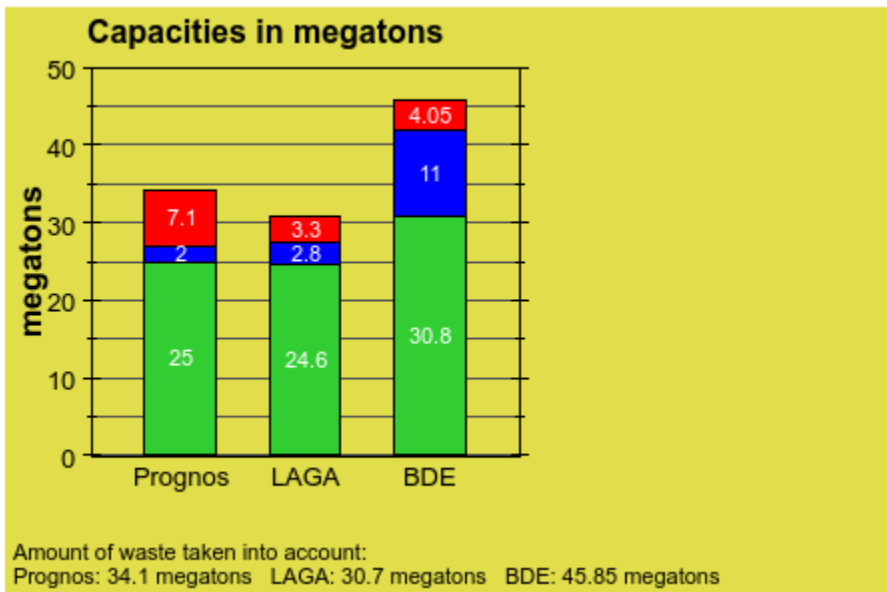

Next, we build a legend made of colored rectangles and text objects:

```
S2 := plot::Scene2d(
  ViewingBox = [0..20, 0..50],
  Axes = None,
  plot::Rectangle(13..13.5, 35..36,
    Filled = TRUE,
    FillPattern = Solid,
    FillColor = RGB::Red,
    LineColor = RGB::Black),
  plot::Text2d("missing capacities", [14, 35],
    HorizontalAlignment = Left,
    TextFont = ["Arial", 8]),
  plot::Rectangle(13..13.5, 29..30,
    Filled = TRUE,
    FillPattern = Solid,
    FillColor = RGB::Blue,
    LineColor = RGB::Black),
  plot::Text2d("planned and potential capacities", [14, 29],
    HorizontalAlignment = Left, TextFont = ["Arial", 8]),
  plot::Rectangle(13..13.5, 23..24,
    Filled = TRUE,
```

```
        FillPattern = Solid,  
        FillColor = RGB::Green,  
        LineColor = RGB::Black),  
    plot::Text2d("known capacities", [14, 23],  
        HorizontalAlignment = Left,  
        TextFont = ["Arial", 8])  
):  
  
plot(S2, BorderWidth = 0.2)
```

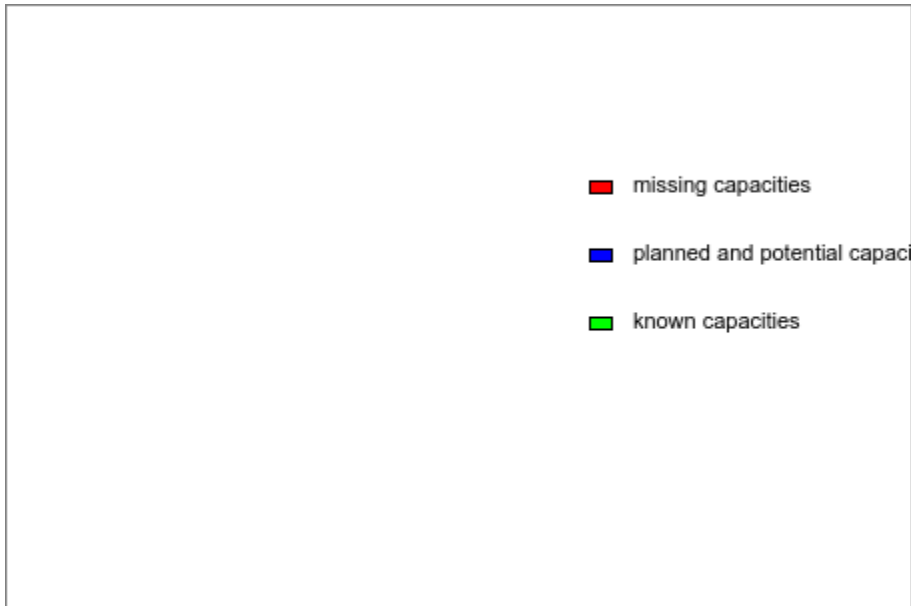

The final picture consists of the bar plot S1 and the legend S2. We just put S2 on top of S1, making the background of S2 transparent:

```
S1::Width := 1: S1::Height := 1:  
S2::Width := 1: S2::Height := 1:  
S1::Bottom := 0: S1::Left := 0:  
S2::Bottom := 0: S2::Left := 0:  
S1::BackgroundTransparent := FALSE:  
S2::BackgroundTransparent := TRUE:  
  
plot(S1, S2, Layout = Relative)
```



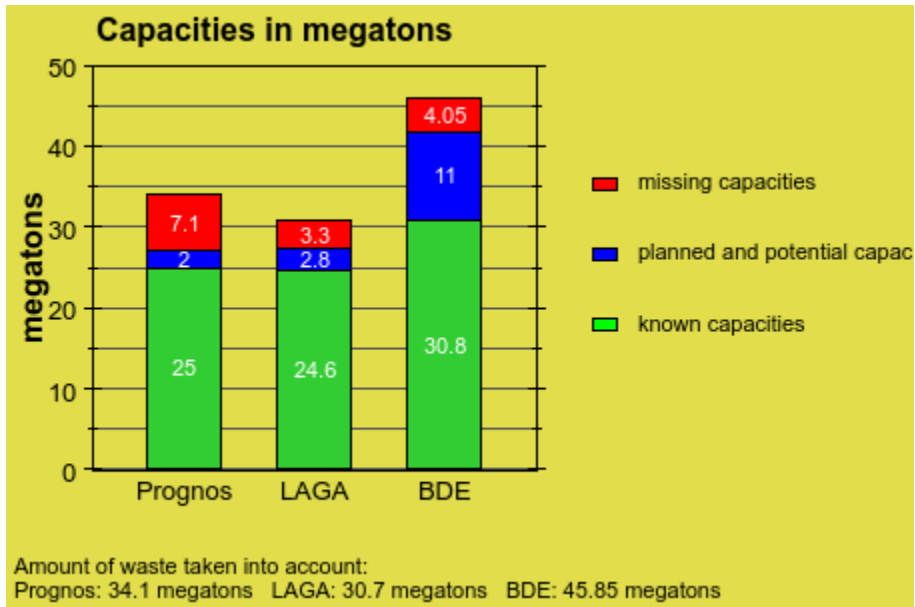

`delete data, datalabels, datasums, datatext, myticks, sw, bw, n, m, w, i, h, j, d, S1, S2:`

## Parameters

$a_1, a_2, \dots, b_1, b_2, \dots, \dots$

Real-valued expressions, possibly in the animation parameter.

$a_1, a_2, \dots, b_1, b_2, \dots, \dots$  is equivalent to the attribute `Data`.

**a**

Animation parameter, specified as  $a = a_{\min} \cdot a_{\max}$ , where  $a_{\min}$  is the initial parameter value, and  $a_{\max}$  is the final parameter value.

## See Also

### **MuPAD Functions**

`plot` | `plot::copy`

### **MuPAD Graphical Primitives**

`plot::Bars3d` | `plot::Histogram2d` | `plot::Scatterplot`

# plot::Bars3d

3D bar chart of matrix data

## Syntax

```
plot::Bars3d(A, <x = x_min .. x_max, y = y_min .. y_max>, <a = a_min .. a_max>, options)
```

```
plot::Bars3d(L, <x = x_min .. x_max, y = y_min .. y_max>, <a = a_min .. a_max>, options)
```

## Description

`plot::Bars3d(A)` generates a 3D bar chart with bar heights given by the entries of the matrix `A`.

The rows of the matrix are plotted along the `x` coordinate, the columns along the `y` coordinate.

Different rows may be regarded as different classes of data. Each row has a different color determined by the the attribute `Colors = [ c1, c2, ... ]` with RGB (Symbolic Math Toolbox) or RGBA (Symbolic Math Toolbox) colors `c1`, `c2` etc.

The simplest way to obtain a uniform coloring of all rows with the color `c` is to specify the attribute `Color = c`.

Arrays/matrices do not need to be indexed from 1. E.g.,

```
A = array( `i_{min}` .. `i_{max}` , `j_{min}` .. `j_{max}` ,
[.data..])
```

yields a bar chart with  $i_{\max} - i_{\min} + 1$  rows and  $j_{\max} - j_{\min} + 1$  columns, stretching from  $x_{\min}$  to  $x_{\max}$  in `x` direction and from  $y_{\min}$  to  $y_{\max}$  in `y` direction.

If no plot range ``x_{min}` .. `x_{max}``, ``y_{min}` .. `y_{max}`` is specified,  $x_{\min} = j_{\min} - 1$ ,  $x_{\max} = j_{\max}$ ,  $y_{\min} = i_{\min} - 1$ ,  $y_{\max} = i_{\max}$  is used.

When the values are specified by a list of lists `L` and no plot range ``x_{min}` .. `x_{max}``, ``y_{min}` .. `y_{max}`` is specified,  $x_{\min} = 0$ ,  $x_{\max} = m$ ,  $y_{\min} = 0$ ,  $y_{\max}$

=  $n$  is used, where  $n$  is the length of  $L$  and  $m$  is the (common) length of the sublists in  $L$ . All sublists (“rows”) must have the same length.

The attribute `BarStyle` allows to switch the style of the bars between `Boxes` (bars), `Lines` (vertical lines), `LinesPoints` (vertical lines and points), and `Points`(points only). See “Example 1” on page 24-151 (Symbolic Math Toolbox).

The attribute `Gap = [gx, gy]` or, equivalently, `XGap = gx`, `YGap = gy` allows to introduce gaps between adjacent bars. The values  $g_x$ ,  $g_y$  may be real numerical values between 0 and 1 or expressions of the animation parameter  $a$ . These values set the fraction of the space reserved for a bar that is not filled by the bar.

With  $g_x = 0$ ,  $g_y = 0$ , there are no gaps. With  $g_x = 0.5$ ,  $g_y = 0.5$ , the gaps between adjacent bars are of the same size as the bars. With  $g_x = 1$ ,  $g_y = 1$ , there bars become lines.

Values of  $g_x$ ,  $g_y$  larger than 1 are treated like 1, negative values like 0.

The `Gap` attribute has an effect only for `BarStyle = Boxes`.

The attribute `Ground = z0` determines the  $z$  value of the lower or upper face of the bars. Matrix values  $m > z_0$  are displayed as bars stretching in  $z$  direction from the lower face  $z_0$  to the upper face  $m$ . Matrix values  $m < z_0$  are displayed as bars stretching in  $z$  direction from the upper face  $z_0$  down to the lower face  $m$ .

The parameter  $z_0$  has to be a numerical real value or an expression of the animation parameter  $a$ .

If the attribute `Ground = z0` is not specified, the default value  $z_0 = 0$  is used.

## Attributes

Attribute	Purpose	Default Value
<code>AffectViewingBox</code>	influence of objects on the <code>ViewingBox</code> of a scene	TRUE
<code>BarStyle</code>	display style of bar plots	<code>Boxes</code>
<code>Color</code>	the main color	

Attribute	Purpose	Default Value
Colors	list of colors to use	[RGB::Blue, RGB::Red, RGB::Green, RGB::MuPADGold, RGB::Orange, RGB::Cyan, RGB::Magenta, RGB::LimeGreen, RGB::CadmiumYellowLight, RGB::AlizarinCrimson, RGB::Aqua, RGB::Lavender, RGB::SeaGreen, RGB::AureolineYellow, RGB::Banana, RGB::Beige, RGB::YellowGreen, RGB::Wheat, RGB::IndianRed, RGB::Black]
Data	the (statistical) data to plot	
Filled	filled or transparent areas and surfaces	TRUE
Frames	the number of frames in an animation	50
Gap	gaps between the bars of a bar chart	[0, 0]
Ground	base value	0
Legend	makes a legend entry	
LegendText	short explanatory text for legend	
LegendEntry	add this object to the legend?	FALSE
LineColor	color of lines	RGB::Black.[0.25]
LineWidth	width of lines	0.35

<b>Attribute</b>	<b>Purpose</b>	<b>Default Value</b>
LineStyle	solid, dashed or dotted lines?	Solid
LinesVisible	visibility of lines	TRUE
Name	the name of a plot object (for browser and legend)	
ParameterEnd	end value of the animation parameter	
ParameterName	name of the animation parameter	
ParameterBegin	initial value of the animation parameter	
ParameterRange	range of the animation parameter	
PointSize	the size of points	1.5
PointStyle	the presentation style of points	FilledCircles
TimeEnd	end time of the animation	10.0
TimeBegin	start time of the animation	0.0
TimeRange	the real time span of an animation	0.0 .. 10.0
Title	object title	
TitleFont	font of object titles	[" sans-serif ", 11]
TitlePosition	position of object titles	
TitleAlignment	horizontal alignment of titles w.r.t. their coordinates	Center
TitlePositionX	position of object titles, x component	
TitlePositionY	position of object titles, y component	
TitlePositionZ	position of object titles, z component	

Attribute	Purpose	Default Value
Visible	visibility	TRUE
VisibleAfter	object visible after this time value	
VisibleBefore	object visible until this time value	
VisibleFromTo	object visible during this time range	
VisibleAfterEnd	object visible after its animation time ended?	TRUE
VisibleBeforeBegin	object visible before its animation time starts?	TRUE
XGap	gaps in x direction between the bars of a bar chart	0
XMax	final value of parameter "x"	
XMin	initial value of parameter "x"	
XName	name of parameter "x"	
XRange	range of parameter "x"	
YGap	gaps in y direction between the bars of a bar chart	0
YMax	final value of parameter "y"	
YMin	initial value of parameter "y"	
YName	name of parameter "y"	
YRange	range of parameter "y"	

## Examples

### Example 1

We create some random matrix data and plot them as a bar chart:

```
A := matrix::random(5, 10, frandom) :  
plot(plot::Bars3d(A, Gap = [0.4, 0.7]))
```

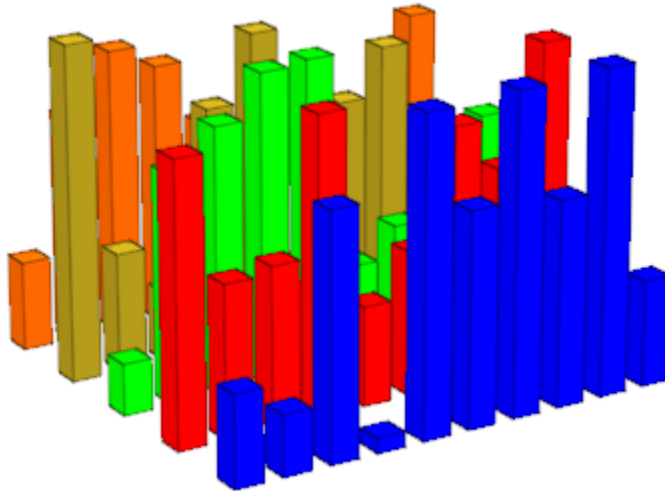

We create bar charts of the data with different `BarStyle` options:

```
plot(plot::Scene3d(plot::Bars3d(A, BarStyle = Boxes)),  
      plot::Scene3d(plot::Bars3d(A, BarStyle = Lines)),  
      plot::Scene3d(plot::Bars3d(A, BarStyle = Points)),  
      plot::Scene3d(plot::Bars3d(A, BarStyle = LinesPoints)),  
      PointSize = 2.0*unit::mm, LineWidth = 0.5*unit::mm  
):
```



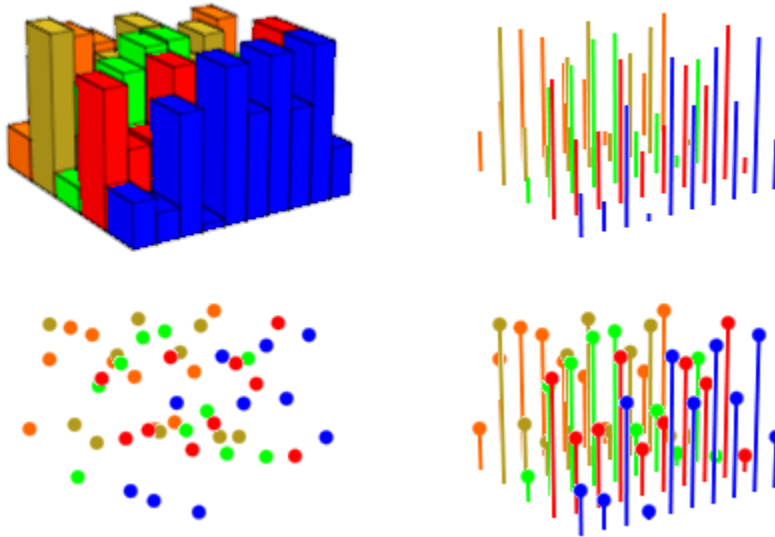

delete A:

## Example 2

We demonstrate the positioning of bar charts by specifying ranges for the  $x$  and the  $y$  coordinate. The following two bar charts are plotted in one scene. They are placed side by side via suitable  $x$  ranges:

```
A := matrix::random(5, 5, frandom):
plot(plot::Bars3d(A, x = 0 .. 0.9, y = 0 .. 1,
  BarStyle = LinesPoints),
  plot::Bars3d(A, x = 1.1 .. 2, y = 0 .. 1,
    Gap = [0.3, 0.7])):
```

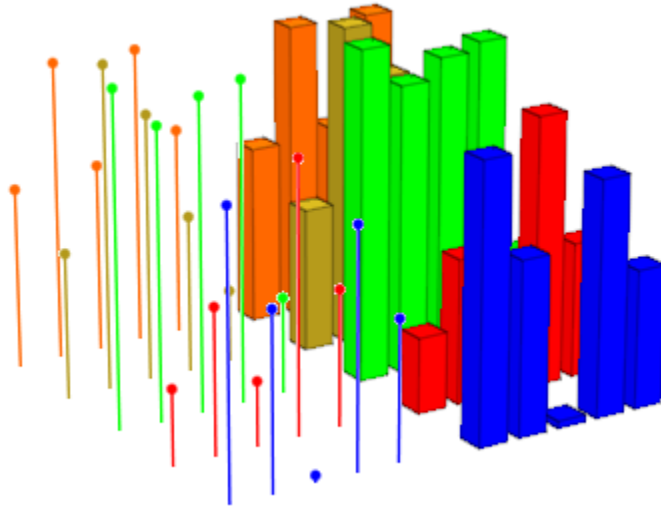

delete A:

### Example 3

We demonstrate the attributes `Ground` and `Color`:

```
A := matrix::random(5, 10, frandom):  
plot(plot::Scene3d(plot::Bars3d(A, Ground = 0,  
                                Color = RGB::Grey)),  
      plot::Scene3d(plot::Bars3d(A, Ground = 0.5,  
                                Color = RGB::Grey)),  
      Layout = Horizontal):
```

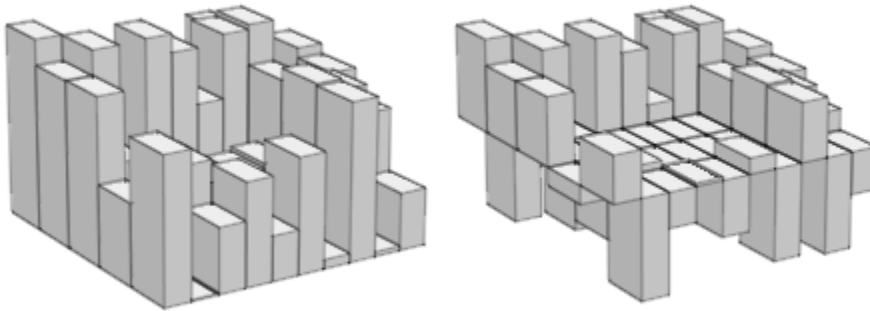

In the next call, the ground level is animated. Note that in animations one must specify ranges for the  $x$  and  $y$  coordinates. We include a transparent plane visualizing the ground level:

```
plot(plot::Bars3d(A, x = 0 .. 1, y = 0 .. 1, a = 0 .. PI,  
  Color = RGB::Grey, Gap = [0.5, 0.5],  
  Ground = sin(a)),  
  plot::Surface([x, y, sin(a) + 0.001],  
    x = 0 .. 1, y = 0 .. 1, a = 0 .. PI,  
    Mesh = [2, 2], Color = RGB::Blue.[0.5])):
```

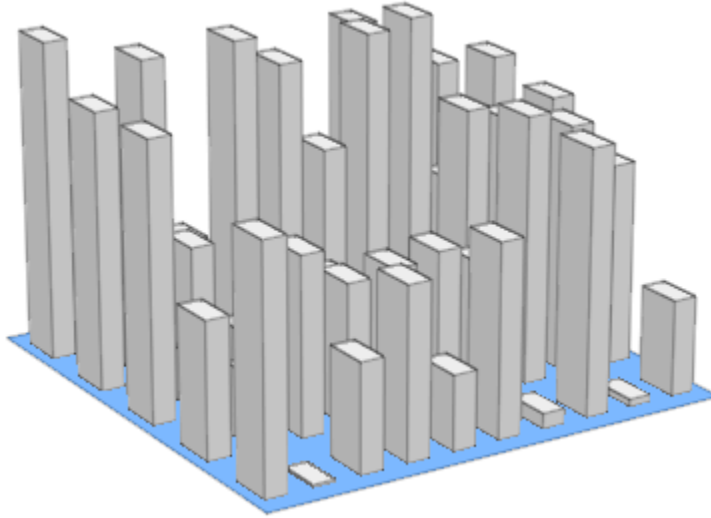

delete A:

## Parameters

### A

An array of domain type `DOM_ARRAY` or a matrix of category `Cat::Matrix` (e.g., of type `matrix` or `densematrix`) containing real numerical values or expressions of the animation parameter  $a$ . Rows/columns of the array, respectively matrix, correspond to rows/columns of the bar chart.

A is equivalent to the attribute `Data`.

### L

A list of lists of real numerical values or expressions of the animation parameter  $a$ . Each sublist of  $L$  represents a row of the bar chart.

L is equivalent to the attribute `Data`.

**x**

Name of the horizontal variable: an identifier on page 7-29 or an indexed identifier on page 1-1017. It is used as the title of the coordinate axis in x direction.

x is equivalent to the attribute XName.

**$x_{\min}$  ..  $x_{\max}$**

The range of the horizontal variable:  $x_{\min}$ ,  $x_{\max}$  must be numerical real value or expressions of the animation parameter  $a$ .

$x_{\min}$  ..  $x_{\max}$  is equivalent to the attribute XRange.

**y**

Name of the vertical variable: an identifier on page 7-29 or an indexed identifier on page 1-1017. It is used as the title of the coordinate axis in y direction.

y is equivalent to the attribute YName.

**$y_{\min}$  ..  $y_{\max}$**

The range of the vertical variable:  $y_{\min}$ ,  $y_{\max}$  must be numerical real value or expressions of the animation parameter  $a$ .

$y_{\min}$  ..  $y_{\max}$  is equivalent to the attribute YRange.

**a**

Animation parameter, specified as  $a = a_{\min} .. a_{\max}$ , where  $a_{\min}$  is the initial parameter value, and  $a_{\max}$  is the final parameter value.

## See Also

**MuPAD Functions**

plot | plot::copy

**MuPAD Graphical Primitives**

plot::Bars2d | plot::Histogram2d | plot::Matrixplot

## plot::Box

Boxes in 3D

### Syntax

```
plot::Box(xmin .. xmax, ymin .. ymax, zmin .. zmax, <a = amin .. amax>, options)
```

```
plot::Box([xmin, ymin, zmin], [xmax, ymax, zmax], <a = amin .. amax>, options)
```

### Description

`plot::Box(`x_{min}` .. `x_{max}` , `y_{min}` .. `y_{max}` ,  
`z_{min}` .. `z_{max}` )` creates the 3D box

$$\{(x \ y \ z) \mid x_{\min} \leq x \leq x_{\max}, y_{\min} \leq y \leq y_{\max}, z_{\min} \leq z \leq z_{\max}\}$$

`plot::Box([xmin, ymin, zmin], [xmax, ymax, zmax])` produces the same box.

`plot::Box` creates 3D boxes with edges parallel to the coordinate axes. Using `plot::Rotate3d` or `plot::Transform3d` one can create boxes and parallelepipeds with arbitrary orientation. Cf. examples “Example 3” on page 24-162 (Symbolic Math Toolbox) and “Example 4” on page 24-165 (Symbolic Math Toolbox).

### Attributes

Attribute	Purpose	Default Value
AffectViewingBox	influence of objects on the ViewingBox of a scene	TRUE
Color	the main color	RGB::LightBlue
Filled	filled or transparent areas and surfaces	TRUE

Attribute	Purpose	Default Value
FillColor	color of areas and surfaces	RGB::LightBlue
Frames	the number of frames in an animation	50
Legend	makes a legend entry	
LegendText	short explanatory text for legend	
LegendEntry	add this object to the legend?	FALSE
LineColor	color of lines	RGB::Black.[0.25]
LineWidth	width of lines	0.35
LineStyle	solid, dashed or dotted lines?	Solid
LinesVisible	visibility of lines	TRUE
LineColorDirection	the direction of color transitions on lines	[0, 0, 1]
LineColorDirectionX	x-component of the direction of color transitions on lines	0
LineColorDirectionY	y-component of the direction of color transitions on lines	0
Name	the name of a plot object (for browser and legend)	
ParameterEnd	end value of the animation parameter	
ParameterName	name of the animation parameter	
ParameterBegin	initial value of the animation parameter	
ParameterRange	range of the animation parameter	
TimeEnd	end time of the animation	10.0
TimeBegin	start time of the animation	0.0

Attribute	Purpose	Default Value
TimeRange	the real time span of an animation	0.0 .. 10.0
Title	object title	
TitleFont	font of object titles	[" sans-serif ", 11]
TitlePosition	position of object titles	
TitleAlignment	horizontal alignment of titles w.r.t. their coordinates	Center
TitlePositionX	position of object titles, x component	
TitlePositionY	position of object titles, y component	
TitlePositionZ	position of object titles, z component	
Visible	visibility	TRUE
VisibleAfter	object visible after this time value	
VisibleBefore	object visible until this time value	
VisibleFromTo	object visible during this time range	
VisibleAfterEnd	object visible after its animation time ended?	TRUE
VisibleBeforeBegin	object visible before its animation time starts?	TRUE
XMax	final value of parameter "x"	1
XMin	initial value of parameter "x"	- 1
XRange	range of parameter "x"	- 1 .. 1
YMax	final value of parameter "y"	1
YMin	initial value of parameter "y"	- 1



Attribute	Purpose	Default Value
YRange	range of parameter "y"	- 1 .. 1
ZMax	final value of parameter "z"	1
ZMin	initial value of parameter "z"	- 1
ZRange	range of parameter "z"	- 1 .. 1

## Examples

### Example 1

We draw a box consisting of its edges and a filled box:

```
plot(plot::Box(-3..-1, 0..2, 0..1, Filled = FALSE,  
             LineColor = RGB::Black),  
     plot::Box(1..3, 0..2, 0..1, Filled = TRUE,  
             FillColor = RGB::Red),  
     Axes = None, Scaling = Constrained)
```

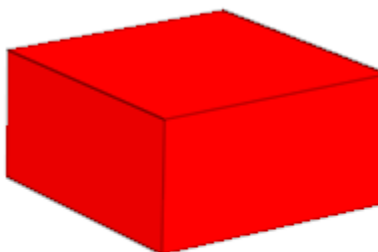
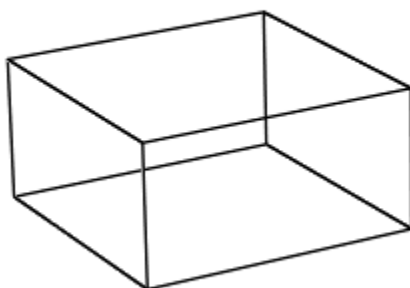

## Example 2

The borders of a box can be animated:

```
plot(plot::Box([1, 1, 1], [2, 2, 2 + sin(r)], r = 0..2*PI):
```

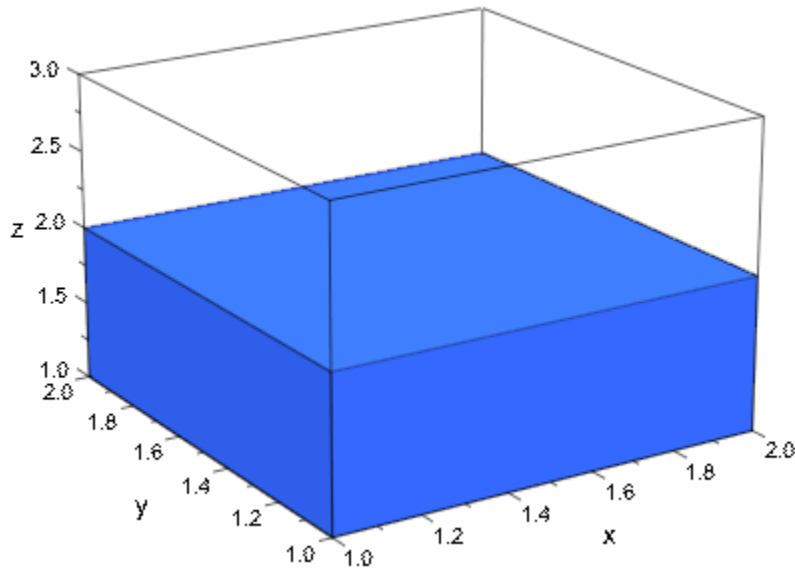

## Example 3

We want to display a cube “standing” on one of its corners. First, we define the cube:

```
b0 := plot::Box(0..1, 0..1, 0..1)
```

```
plot::Box(0..1, 0..1, 0..1)
```

Now, rotating the cube to stand on a corner is equivalent to first rotating around the x-axis by 45 degrees, then rotating around the y-axis:

```
b1 := plot::Rotate3d(b0, Axis = [1, 0, 0], Angle = -PI/4):  
plot(b1, Scaling = Constrained)
```

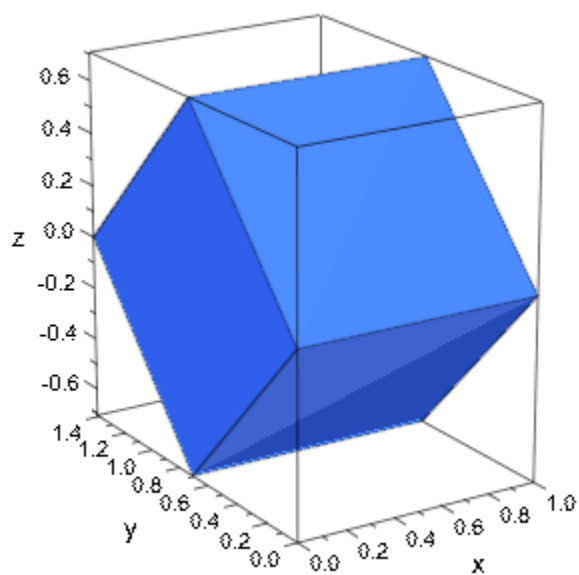

```
b2 := plot::Rotate3d(b1, Axis = [0, 1, 0], Angle = 7*PI/36):  
plot(b2, Scaling = Constrained)
```

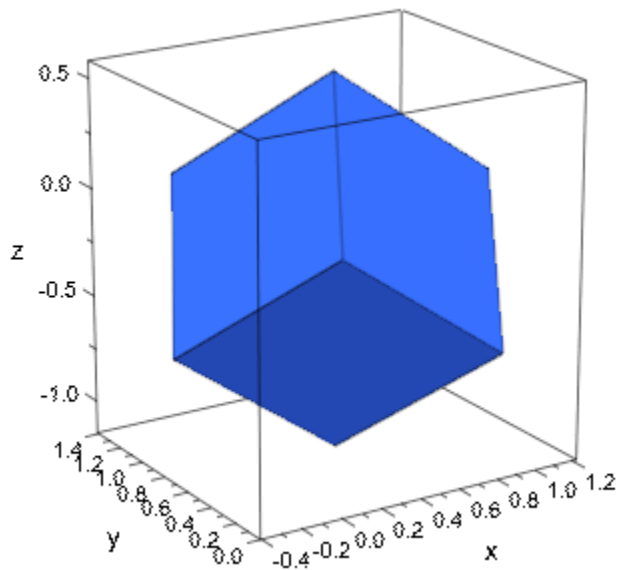

Finally, we let it rotate around the z-axis:

```
plot(plot::Rotate3d(b2, Axis = [0, 0, 1], Angle = a,  
                  a = 0..2*PI/3),  
      Scaling = Constrained)
```

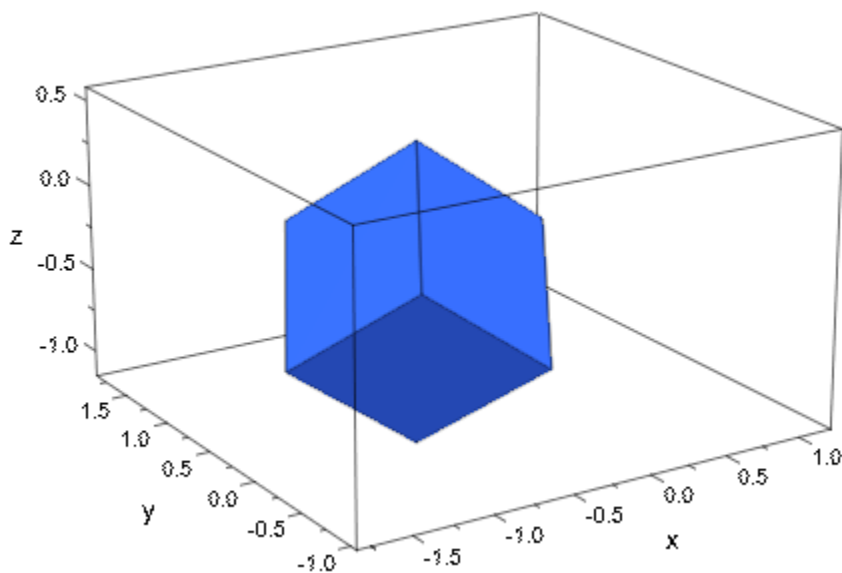

```
delete b0, b1, b2:
```

#### Example 4

A parallelepiped can be obtained from a `plot::Box` by a linear transformation:

```
plot(plot::Transform3d([0, 0, 0], [1, 1, 0,
                                1, 1, 3,
                                0, 3, 1],
                    plot::Box(0..1, 0..1, 0..1)),
    Scaling = Constrained,
    CameraDirection = [-27, -12, 22])
```

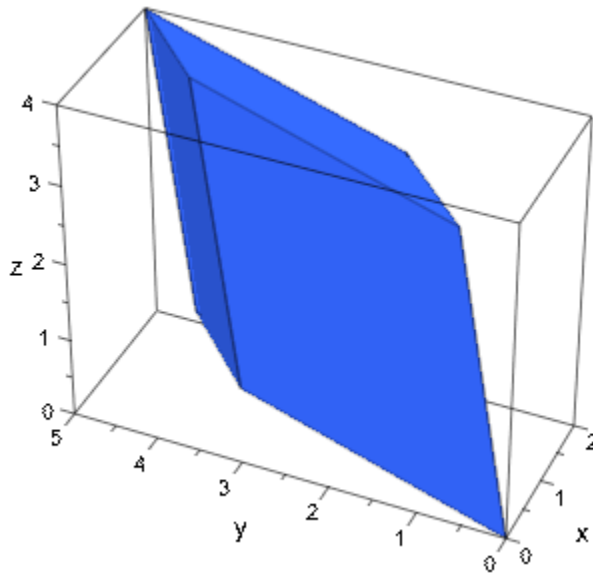

## Parameters

$x_{\min}$ ,  $y_{\min}$ ,  $z_{\min}$

The lower borders: numerical real values or arithmetical expressions (Symbolic Math Toolbox) of the animation parameter  $a$ .

$x_{\min}$ ,  $y_{\min}$ ,  $z_{\min}$  are equivalent to the attributes XMin, YMin, ZMin.

$x_{\max}$ ,  $y_{\max}$ ,  $z_{\max}$

The upper borders: numerical real values or arithmetical expressions (Symbolic Math Toolbox) of the animation parameter  $a$ .

$x_{\max}$ ,  $y_{\max}$ ,  $z_{\max}$  are equivalent to the attributes XMax, YMax, ZMax.

**a**

Animation parameter, specified as  $a = a_{\min} \dots a_{\max}$ , where  $a_{\min}$  is the initial parameter value, and  $a_{\max}$  is the final parameter value.

## See Also

### **MuPAD Functions**

plot | plot::copy

### **MuPAD Graphical Primitives**

plot::Polygon3d | plot::Rotate3d | plot::Scale3d | plot::Surface |  
plot::Transform3d

## plot::Boxplot

Statistical box plots

### Syntax

```
plot::Boxplot(L1, ..., <a = amin .. amax>, options)
```

```
plot::Boxplot([L1, ...], <a = amin .. amax>, options)
```

```
plot::Boxplot(A, <a = amin .. amax>, options)
```

```
plot::Boxplot(s, <c1, ...>, <a = amin .. amax>, options)
```

```
plot::Boxplot(s, <[c1, ...]>, <a = amin .. amax>, options)
```

### Description

`plot::Boxplot(data)` creates a box plot of the given data.

`plot::Boxplot` creates a box plot of discrete data samples. Box plots reduce data samples to a number of descriptive parameters and are a useful means of comparing statistical data.

In particular, each data sample is represented as one box. A typical box consists of the following subparts:



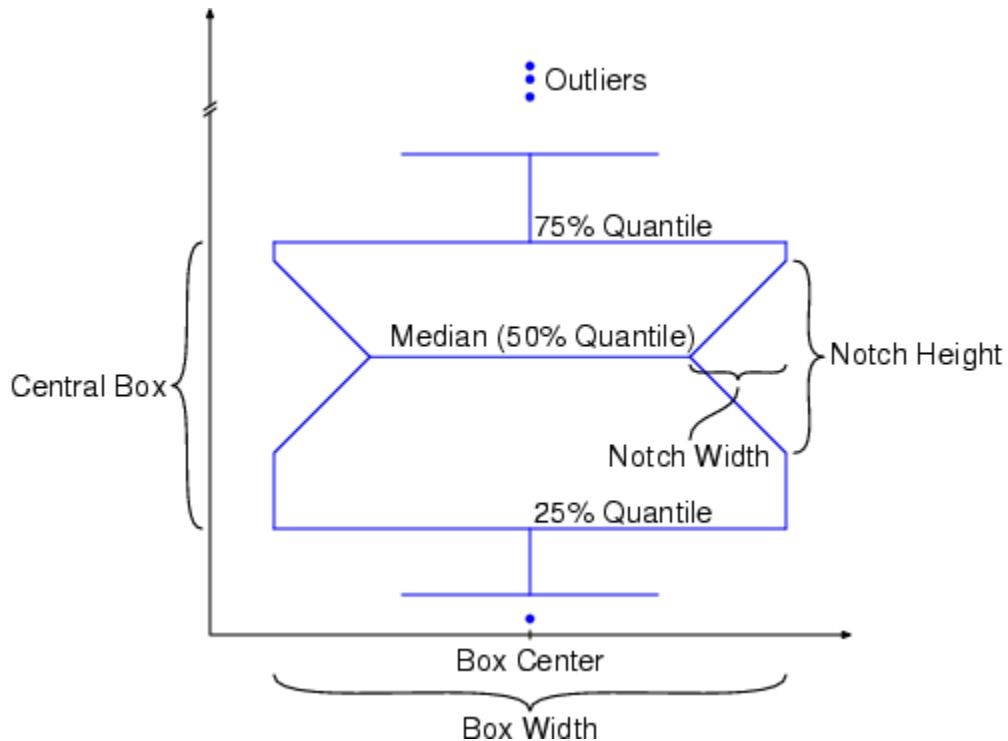

- A “central box” representing the central 50% of the data. Its lower and upper boundary lines are at the 25%/75% quantile on page 30-122 of the data. A central line indicates the median on page 30-353 of the data.
- Two vertical lines extending from the central box indicating the remaining data outside the central box that are not regarded as outliers. These lines extend maximally to  $\frac{3}{2}$  times the height of the central box but not past the range of the data.
- Outliers: these are points indicating the remaining data.

With the special attribute `Notched = TRUE`, the sides of the boxes can be notched, thus providing additional information on the data sample. The horizontal width of the notches may be set by the attribute `NotchWidth`.

The special attributes `BoxCenters` and `BoxWidths` allow to center the boxes at arbitrary positions along the horizontal axis and to set the horizontal width of the boxes, respectively.

The special attribute `Averaged` determines whether the quantile values are computed with or without the option `Averaged` (cf. `stats::empiricalQuantile`).

Specifying `DrawMode = Horizontal`, the boxes are rotated by 90 degrees.

The attribute `Colors` allows to specify the color of each box in a box plot. A common color for all boxes may be specified via `Color`.

## Attributes

Attribute	Purpose	Default Value
<code>AffectViewingBox</code>	influence of objects on the <code>ViewingBox</code> of a scene	<code>TRUE</code>
<code>AntiAliased</code>	antialiased lines and points?	<code>FALSE</code>
<code>Averaged</code>	mode for computing quantile lines in box plots	<code>TRUE</code>
<code>BoxWidths</code>	widths of boxes in a box plot	<code>[0.8]</code>
<code>BoxCenters</code>	position of boxes in a box plot	<code>[1]</code>
<code>Color</code>	the main color	
<code>Colors</code>	list of colors to use	<code>[RGB::Blue, RGB::Red, RGB::Green, RGB::MuPADGold, RGB::Orange, RGB::Cyan, RGB::Magenta, RGB::LimeGreen, RGB::CadmiumYellowLight, RGB::AlizarinCrimson]</code>
<code>Data</code>	the (statistical) data to plot	
<code>DrawMode</code>	orientation of boxes and bars	<code>Vertical</code>
<code>Filled</code>	filled or transparent areas and surfaces	<code>TRUE</code>

<b>Attribute</b>	<b>Purpose</b>	<b>Default Value</b>
FillPattern	type of area filling	DiagonalLines
Frames	the number of frames in an animation	50
Legend	makes a legend entry	
LegendText	short explanatory text for legend	
LegendEntry	add this object to the legend?	FALSE
LineWidth	width of lines	0.35
LineStyle	solid, dashed or dotted lines?	Solid
LinesVisible	visibility of lines	TRUE
Name	the name of a plot object (for browser and legend)	
Notched	notched boxes in box plots	FALSE
NotchWidth	width of notches in box plots	0.2
ParameterEnd	end value of the animation parameter	
ParameterName	name of the animation parameter	
ParameterBegin	initial value of the animation parameter	
ParameterRange	range of the animation parameter	
TimeEnd	end time of the animation	10.0
TimeBegin	start time of the animation	0.0
TimeRange	the real time span of an animation	0.0 .. 10.0
Title	object title	
TitleFont	font of object titles	[" sans-serif ", 11]

Attribute	Purpose	Default Value
TitlePosition	position of object titles	
TitleAlignment	horizontal alignment of titles w.r.t. their coordinates	Center
TitlePositionX	position of object titles, x component	
TitlePositionY	position of object titles, y component	
Visible	visibility	TRUE
VisibleAfter	object visible after this time value	
VisibleBefore	object visible until this time value	
VisibleFromTo	object visible during this time range	
VisibleAfterEnd	object visible after its animation time ended?	TRUE
VisibleBeforeBegin	object visible before its animation time starts?	TRUE

## Examples

### Example 1

Just to show basic usage of `plot::Boxplot`, we plot some data samples chosen arbitrarily:

```
data1 := [5, 10, 24, -4, 13]:  
data2 := [7, 9, -1, 4, 10, 8, 12, 10, 15]:  
b := plot::Boxplot(data1, data2):  
plot(b)
```

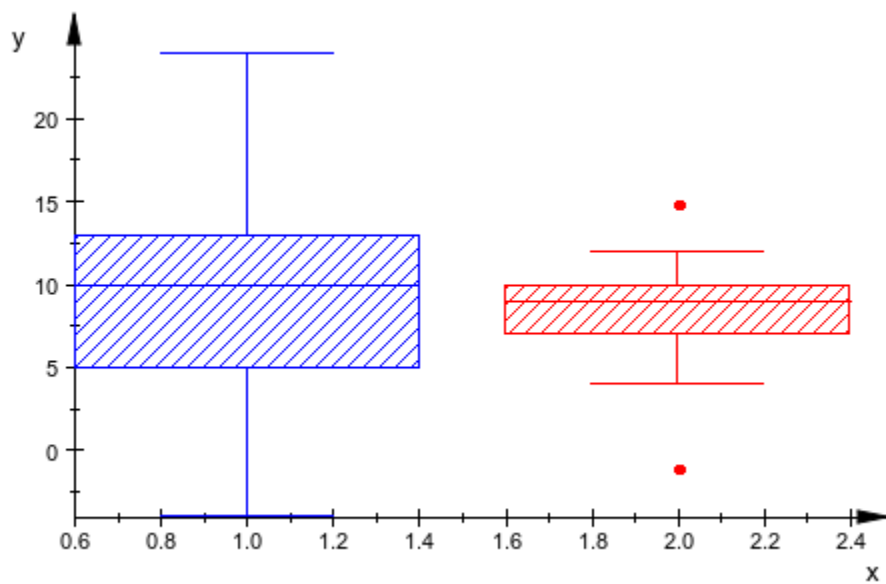

We can modify the appearance of the box plot in various ways:

```
b::Notched := TRUE:  
b::Colors := [RGB::Green, RGB::Black]:  
b::BoxCenters := [2, 3]:  
b::FillPattern := XCrossedLines:  
  
plot(b)
```

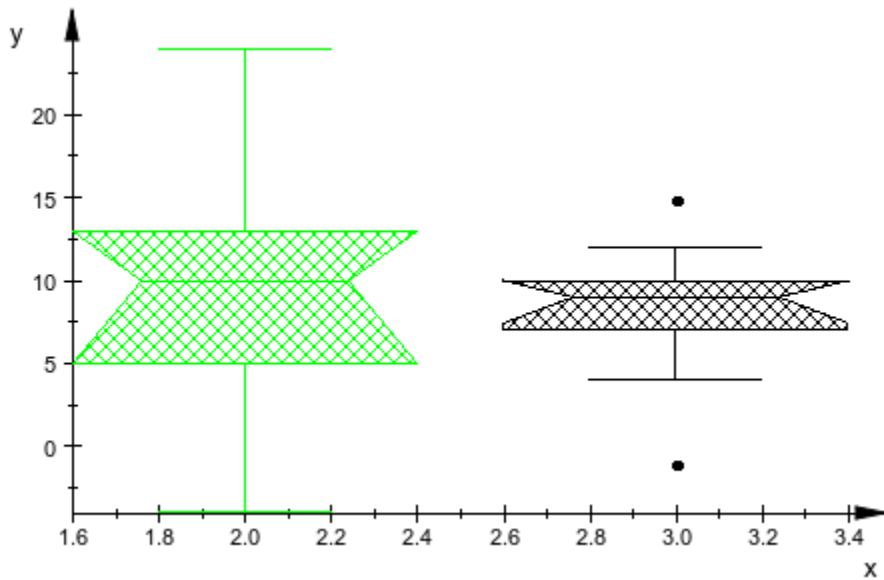

delete b:

## Example 2

It is possible to shift the whole plot in x-direction by providing a center for the first box via `BoxCenters`:

```
A := matrix([[ 5,  6, 19],
             [10,  5, 45],
             [24,  2, 12],
             [-3, 18, -10],
             [-4,  0, - 4]]):

plot(plot::Boxplot(A, BoxCenters = [2], Notched = TRUE,
                  FillPattern = Solid))
```

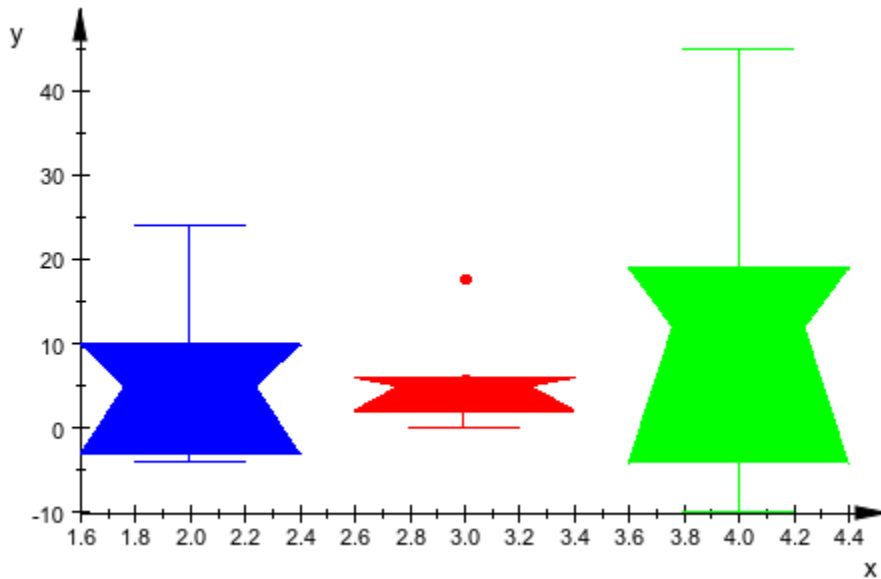

delete A:

### Example 3

The primary use of `plot::Boxplot` is comparing data sets. We shall do this for data produced by the following random number generators:

```
f := stats::normalRandom(1, 0.2):
g := stats::uniformRandom(0, 2):
```

Now, we create small samples and compare their boxes:

```
data1 := [f() $ k = 1..100]: // Red
data2 := [f() $ k = 1..100]: // Green
data3 := [g() $ k = 1..100]: // Blue
plot(plot::Boxplot(data1, data2, data1, data3, data2, data3,
  Colors = [RGB::Red, RGB::Green, RGB::Red, RGB::Blue,
    RGB::Green, RGB::Blue],
  BoxCenters = [1, 2, 4, 5, 7, 8], Notched = TRUE))
```

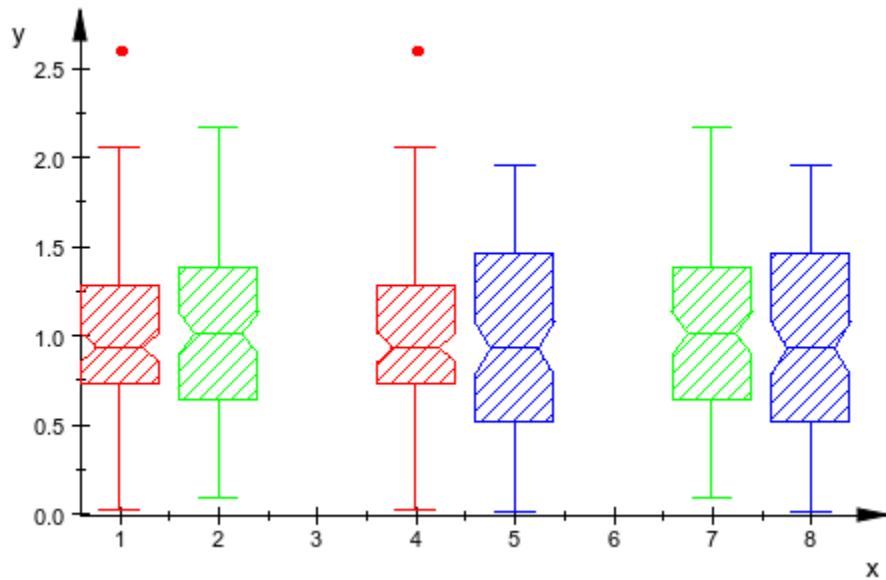

Comparing the central boxes, the blue data differ significantly from the red and the green data. The red and green boxes, however, are quite similar - as they should, given that the red and green data were produced by the same random generator `f`.

```
delete f, g, data1, data2, data3:
```

#### Example 4

For symmetric input data, the images generated by `plot::Boxplot` are symmetric, too:

```
plot(plot::Boxplot([$0..10], [5+5*sin(PI*n/20) $ n=-10..10], Notched))
```



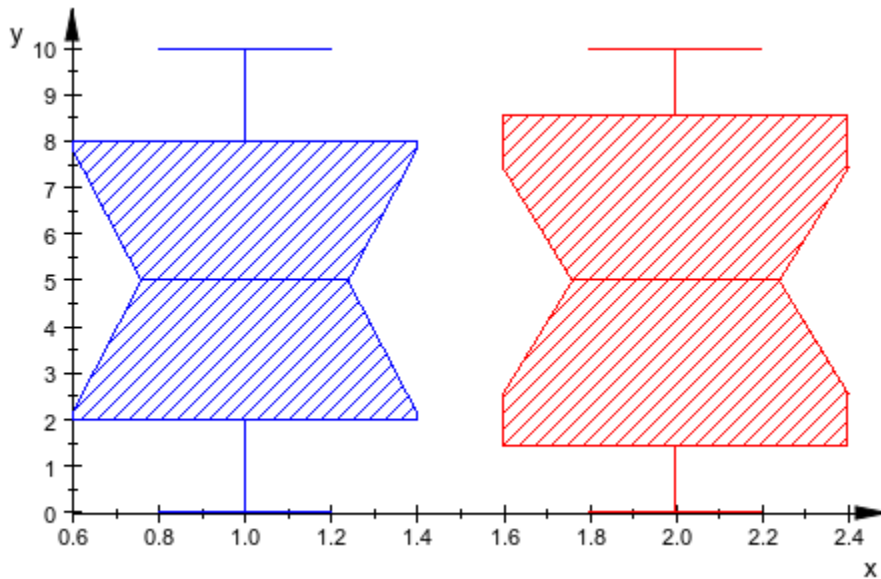

## Example 5

By default, the quantile lines of the boxes are computed with the option `Averaged` (see `stats::empiricalQuantile` for details). When using `Averaged = FALSE`, the quantiles are computed without this option:

```
r := random(0..10):
SEED := 123:
data := [r() $ k = 1..250]:
plot(plot::Boxplot(data, Averaged = TRUE, BoxCenters = 0.5,
                  Color = RGB::Blue, Notched),
      plot::Boxplot(data, Averaged = FALSE, BoxCenters = 1.5,
                  Color = RGB::Red, Notched)
):
```

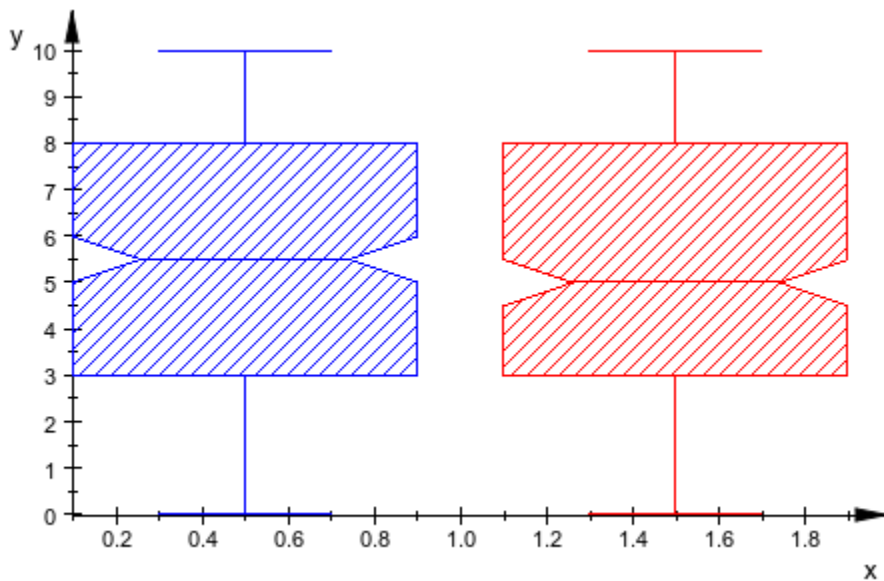

```
delete r, SEED, data:
```

## Example 6

Box plots can be animated. We create two data samples and fuse them to a symbolic superposition:

```
f1 := stats::normalRandom(0, 1):
f2 := stats::normalRandom(4, 8):
data0 := sort([f1() $ k = 1..100]):
data1 := sort([f2() $ k = 1..100]):
data01 := [(1 - a)*data0[i] + a*data1[i] $ i = 1..100]:
```

The box associated with the data sample `data01` changes from the box associated with `data0` to the box associated with `data1` as the animation parameter increases from  $a = 0$  to  $a = 1$ :

```
plot(plot::Boxplot(data0, data01, data1, a = 0..1))
```

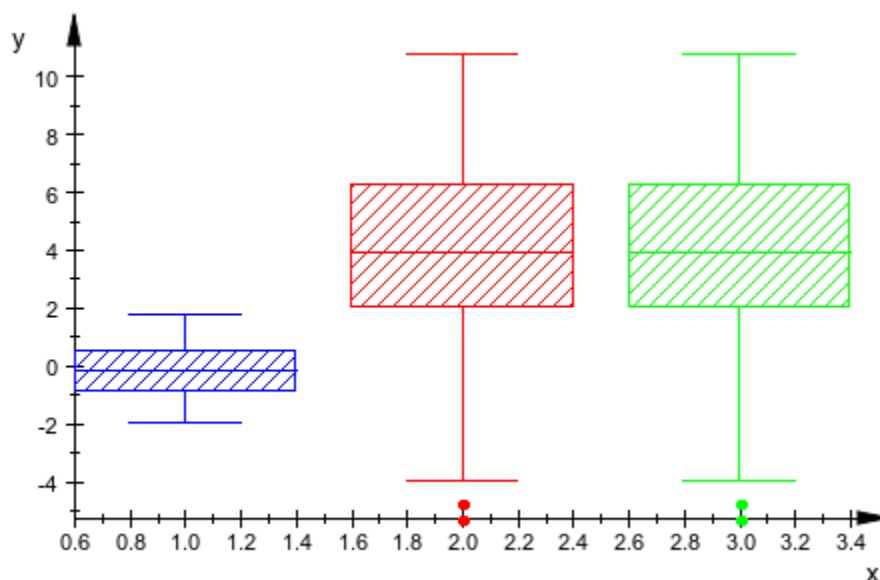

```
delete f1, f2, data0, data1, data01:
```

## Parameters

$L_1, \dots$

Data samples: lists on page 7-41 of numerical real values or arithmetical expressions (Symbolic Math Toolbox) of the animation parameter  $a$ .

$L_1, \dots$  is equivalent to the attribute `Data`.

**A**

An array of domain type `DOM_ARRAY` or a matrix of category `Cat::Matrix` (e.g., of type `matrix` or `densematrix`) providing numerical real values or arithmetical expressions (Symbolic Math Toolbox) of the animation parameter  $a$ . The columns are regarded as separate data samples. Also a 1-dimensional array, regarded as a single data sample, is accepted.

**A** is equivalent to the attribute `Data`.

**s**

A data collection of domain type `stats::sample`. The columns in `s` are regarded as separate data samples.

`s` is equivalent to the attribute `Data`.

**c<sub>1</sub>, ...**

Column indices into `s`: positive integers. These indices, if given, indicate that only the specified columns in `s` should be used as data samples. If no column indices are specified, *all* columns in `s` are used as data samples.

**a**

Animation parameter, specified as `a = amin..amax`, where `amin` is the initial parameter value, and `amax` is the final parameter value.

## See Also

**MuPAD Functions**

`plot` | `plot::copy`

**MuPAD Graphical Primitives**

`plot::Bars2d` | `plot::Bars3d` | `plot::Histogram2d` | `plot::Scatterplot`

# plot::Circle2d

2D circles

## Syntax

```
plot::Circle2d(r, <[x, y]>, <a = amin .. amax>, options)
```

## Description

`plot::Circle2d(r, [x, y])` creates a 2D circle with radius  $r$  and center  $(x, y)$ .

The attribute `LineColor` or, equivalently, `Color` serves for setting the line color.

Use the attribute `Filled = TRUE` to create filled circles. You can choose between hatched and solidly filled circles via the attribute `FillPattern`. The fill color is determined by `FillColor`.

The circumferential line can be “switched off” via `LinesVisible = FALSE`.

## Attributes

Attribute	Purpose	Default Value
<code>AffectViewingBox</code>	influence of objects on the <code>ViewingBox</code> of a scene	TRUE
<code>AntiAliased</code>	antialiased lines and points?	TRUE
<code>Center</code>	center of objects, rotation center	$[0, 0]$
<code>CenterX</code>	center of objects, rotation center, x-component	0
<code>CenterY</code>	center of objects, rotation center, y-component	0

<b>Attribute</b>	<b>Purpose</b>	<b>Default Value</b>
Color	the main color	RGB::Blue
Filled	filled or transparent areas and surfaces	FALSE
FillColor	color of areas and surfaces	RGB::Red
FillPattern	type of area filling	DiagonalLines
Frames	the number of frames in an animation	50
Legend	makes a legend entry	
LegendText	short explanatory text for legend	
LegendEntry	add this object to the legend?	FALSE
LineColor	color of lines	RGB::Blue
LineWidth	width of lines	0.35
LineStyle	solid, dashed or dotted lines?	Solid
LinesVisible	visibility of lines	TRUE
LineColorDirection	the direction of color transitions on lines	[0, 1]
LineColorDirectionX	x-component of the direction of color transitions on lines	0
LineColorDirectionY	y-component of the direction of color transitions on lines	1
Name	the name of a plot object (for browser and legend)	
ParameterEnd	end value of the animation parameter	
ParameterName	name of the animation parameter	
ParameterBegin	initial value of the animation parameter	

<b>Attribute</b>	<b>Purpose</b>	<b>Default Value</b>
ParameterRange	range of the animation parameter	
Radius	radius of circles, spheres etc.	1
TimeEnd	end time of the animation	10.0
TimeBegin	start time of the animation	0.0
TimeRange	the real time span of an animation	0.0 .. 10.0
Title	object title	
TitleFont	font of object titles	[" sans-serif ", 11]
TitlePosition	position of object titles	
TitleAlignment	horizontal alignment of titles w.r.t. their coordinates	Center
TitlePositionX	position of object titles, x component	
TitlePositionY	position of object titles, y component	
Visible	visibility	TRUE
VisibleAfter	object visible after this time value	
VisibleBefore	object visible until this time value	
VisibleFromTo	object visible during this time range	
VisibleAfterEnd	object visible after its animation time ended?	TRUE
VisibleBeforeBegin	object visible before its animation time starts?	TRUE

## Examples

### Example 1

Create a circle by specifying only its radius. In this case, the circle is centered at the origin

```
plot(plot::Circle2d(3)):
```

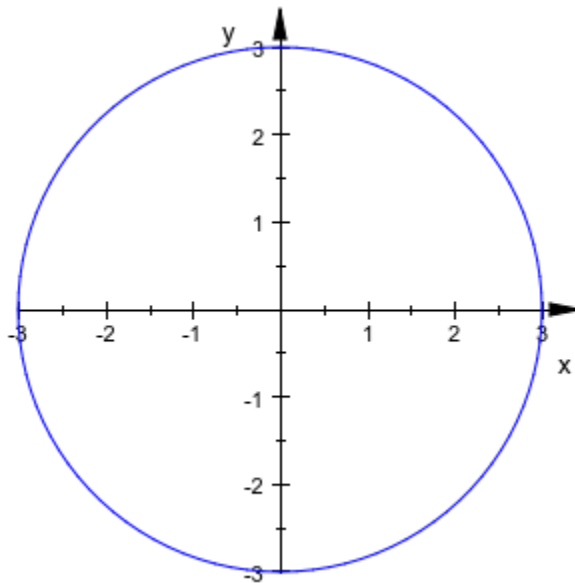

You can specify the center of a circle by a list of its coordinates:

```
plot(plot::Circle2d(1, [1, 1]),  
      plot::Circle2d(2, [1, 2]),  
      plot::Circle2d(3, [1, 3])):
```



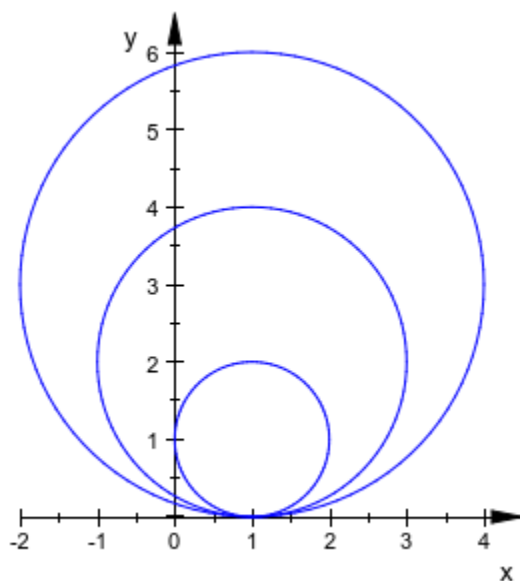

## Example 2

You can animate the radius and center of a circle. Plot an animated circle with a changing radius and a center moving on a spiral:

```
plot(plot::Curve2d([a*cos(2*a), a*sin(2*a)], a = 0..PI),
      plot::Point2d([a*cos(2*a), a*sin(2*a)], a = 0..PI,
                    PointSize = 2*unit::mm),
      plot::Circle2d(0.2 + sin(a), [a*cos(2*a), a*sin(2*a)],
                    a = 0..PI))
```

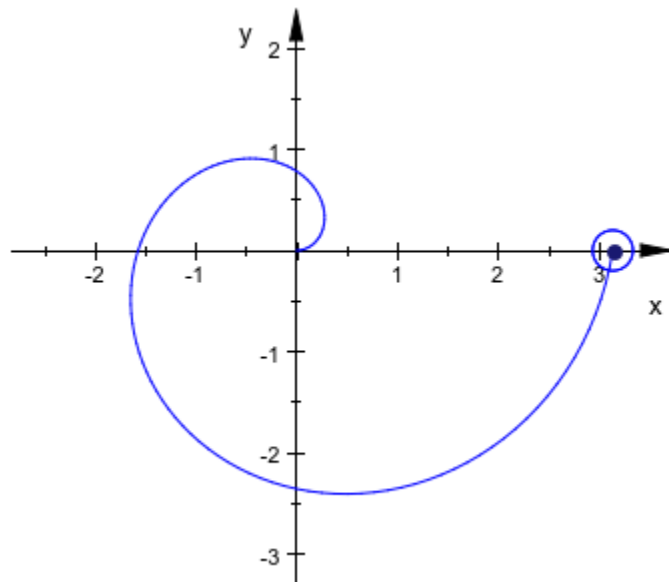

## Parameters

**r**

The radius: a real numerical value or an arithmetical expression (Symbolic Math Toolbox) in the animation parameter **a**.

**r** is equivalent to the attribute **Radius**.

**x, y**

The center of a circle. The coordinates **x, y** must be real numerical values or arithmetical expressions (Symbolic Math Toolbox) in the animation parameter **a**. If no center is specified, a circle centered at the origin is created.

**x, y** are equivalent to the attributes **CenterX, CenterY**.

**a**

Animation parameter, specified as  $a = a_{\min} .. a_{\max}$ , where  $a_{\min}$  is the initial parameter value, and  $a_{\max}$  is the final parameter value.

## See Also

**MuPAD Functions**

plot | plot::copy

**MuPAD Graphical Primitives**

plot::Circle3d | plot::Cone | plot::Sphere

## plot::Circle3d

3D circles

### Syntax

```
plot::Circle3d(r, [x, y, z], <[nx, ny, nz]>, <a = amin .. amax>, options)
```

### Description

`plot::Circle3d(r, [x, y, z], [nx, ny, nz])` creates a circle in 3D with the radius  $r$ , center  $(x, y, z)$ , and normal vector  $(n_x, n_y, n_z)$ .

The attribute `LineColor` or, equivalently, `Color` serves for setting the line color.

Use the attribute `Filled = TRUE` to create circular discs.

### Attributes

Attribute	Purpose	Default Value
<code>AffectViewingBox</code>	influence of objects on the <code>ViewingBox</code> of a scene	TRUE
<code>Center</code>	center of objects, rotation center	[0, 0, 0]
<code>CenterX</code>	center of objects, rotation center, x-component	0
<code>CenterY</code>	center of objects, rotation center, y-component	0
<code>CenterZ</code>	center of objects, rotation center, z-component	0
<code>Color</code>	the main color	RGB::Blue

Attribute	Purpose	Default Value
Filled	filled or transparent areas and surfaces	FALSE
FillColor	color of areas and surfaces	RGB::LightBlue
Frames	the number of frames in an animation	50
Legend	makes a legend entry	
LegendText	short explanatory text for legend	
LegendEntry	add this object to the legend?	FALSE
LineColor	color of lines	RGB::Blue
LineWidth	width of lines	0.35
LineStyle	solid, dashed or dotted lines?	Solid
LinesVisible	visibility of lines	TRUE
LineColorDirection	the direction of color transitions on lines	[0, 0, 1]
LineColorDirectionX	x-component of the direction of color transitions on lines	0
LineColorDirectionY	y-component of the direction of color transitions on lines	0
LineColorDirectionZ	z-component of the direction of color transitions on lines	1
Name	the name of a plot object (for browser and legend)	
Normal	normal vector of circles and discs, etc. in 3D	[0, 0, 1]
NormalX	normal vector of circles and discs, etc. in 3D, x-component	0

<b>Attribute</b>	<b>Purpose</b>	<b>Default Value</b>
NormalY	normal vector of circles and discs, etc. in 3D, y-component	0
NormalZ	normal vector of circles and discs, etc. in 3D, z-component	1
ParameterEnd	end value of the animation parameter	
ParameterName	name of the animation parameter	
ParameterBegin	initial value of the animation parameter	
ParameterRange	range of the animation parameter	
Radius	radius of circles, spheres etc.	1
TimeEnd	end time of the animation	10.0
TimeBegin	start time of the animation	0.0
TimeRange	the real time span of an animation	0.0 .. 10.0
Title	object title	
TitleFont	font of object titles	[" sans-serif ", 11]
TitlePosition	position of object titles	
TitleAlignment	horizontal alignment of titles w.r.t. their coordinates	Center
TitlePositionX	position of object titles, x component	
TitlePositionY	position of object titles, y component	
TitlePositionZ	position of object titles, z component	
Visible	visibility	TRUE

Attribute	Purpose	Default Value
VisibleAfter	object visible after this time value	
VisibleBefore	object visible until this time value	
VisibleFromTo	object visible during this time range	
VisibleAfterEnd	object visible after its animation time ended?	TRUE
VisibleBeforeBegin	object visible before its animation time starts?	TRUE

## Examples

### Example 1

Create the following circle in 3D and animate its normal vector:

```
normal_ := plot::Arrow3d(
    [0, 0, 0],
    [sin(2*a), sin(a)*cos(2*a), cos(a)*cos(2*a)],
    a = 0..2*PI):
circle := plot::Circle3d(1, [0, 0, 0], normal_::To,
    a = 0..2*PI, Filled):
plot(normal_, circle)
```

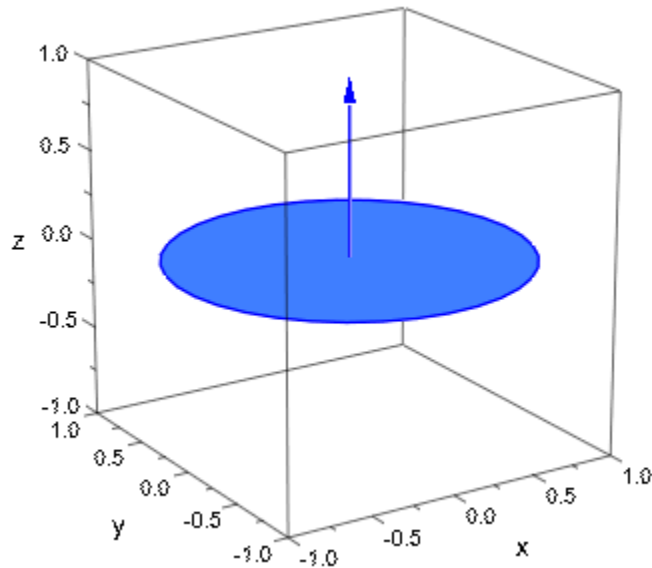

## Parameters

**r**

The radius: a real numerical value or an arithmetical expression (Symbolic Math Toolbox) in the animation parameter **a**.

**r** is equivalent to the attribute **Radius**.

**x, y, z**

The center. The coordinates **x**, **y**, **z** must be real numerical values or arithmetical expressions (Symbolic Math Toolbox) in the animation parameter **a**. If no center is specified, a circle centered at the origin is created.

**x**, **y**, **z** are equivalent to the attributes **CenterX**, **CenterY**, **CenterZ**.



**$n_x$ ,  $n_y$ ,  $n_z$** 

The normal vector. The components  $n_x$ ,  $n_y$ ,  $n_z$  must be real numerical values or arithmetical expressions (Symbolic Math Toolbox) in the animation parameter **a**. If no normal is specified, the normal (0, 0, 1) is used.

$n_x$ ,  $n_y$ ,  $n_z$  are equivalent to the attributes `NormalX`, `NormalY`, `NormalZ`.

**a**

Animation parameter, specified as  $a = a_{\min} \dots a_{\max}$ , where  $a_{\min}$  is the initial parameter value, and  $a_{\max}$  is the final parameter value.

## See Also

**MuPAD Functions**

plot | plot::copy

**MuPAD Graphical Primitives**

plot::Circle2d | plot::Cone | plot::Sphere

## plot::Cone

Cones and frustums

### Syntax

```
plot::Cone(br, [bx, by, bz], <tr>, [tx, ty, tz], <a = amin .. amax>, options)
```

### Description

`plot::Cone(br, [bx, by, bz], [tx, ty, tz])` creates a cone stretching from the base with radius `br` and center `[bx, by, bz]` to the top `[tx, ty, tz]`.

`plot::Cone(br, [bx, by, bz], tr, [tx, ty, tz])` creates a conical frustum from the base center `[bx, by, bz]` to the top center `[tx, ty, tz]`. The base radius is `br`, the top radius is `tr`.

The lower center and upper center of the cone can also be passed as vectors.

The optional “top radius” `tr` for creating a frustum may also be specified as the attribute `TopRadius = tr`.

The upper and lower faces of a cone/frustum are not filled. They can be added as filled `plot::Circle3ds`.

Note that only circular cones can be created with `plot::Cone`. For elliptical bases, use a `plot::Surface` primitive or apply a `plot::Scale3d` transformation.

### Attributes

Attribute	Purpose	Default Value
<code>AffectViewingBox</code>	influence of objects on the <code>ViewingBox</code> of a scene	TRUE

Attribute	Purpose	Default Value
Base	base center of cones, cylinders, pyramids and prisms	[0, 0, 0]
BaseX	x-coordinate of top center of cones, cylinders, pyramids and prisms	0
BaseY	y-coordinate of top center of cones, cylinders, pyramids and prisms	0
BaseZ	z-coordinate of top center of cones, cylinders, pyramids and prisms	0
BaseRadius	base radius of cones/conical frustums and pyramids/frustums of pyramids	1
Color	the main color	RGB::LightBlue
Filled	filled or transparent areas and surfaces	TRUE
FillColor	color of areas and surfaces	RGB::LightBlue
Frames	the number of frames in an animation	50
Legend	makes a legend entry	
LegendText	short explanatory text for legend	
LegendEntry	add this object to the legend?	FALSE
LineColor	color of lines	RGB::Black.[0.25]
LineWidth	width of lines	0.35
LineStyle	solid, dashed or dotted lines?	Solid
LinesVisible	visibility of lines	TRUE

<b>Attribute</b>	<b>Purpose</b>	<b>Default Value</b>
LineColorDirection	the direction of color transitions on lines	[0, 0, 1]
LineColorDirectionX	x-component of the direction of color transitions on lines	0
LineColorDirectionY	y-component of the direction of color transitions on lines	0
Name	the name of a plot object (for browser and legend)	
ParameterEnd	end value of the animation parameter	
ParameterName	name of the animation parameter	
ParameterBegin	initial value of the animation parameter	
ParameterRange	range of the animation parameter	
Shading	smooth color blend of surfaces	Smooth
TimeEnd	end time of the animation	10.0
TimeBegin	start time of the animation	0.0
TimeRange	the real time span of an animation	0.0 .. 10.0
Title	object title	
TitleFont	font of object titles	[" sans-serif ", 11]
TitlePosition	position of object titles	
TitleAlignment	horizontal alignment of titles w.r.t. their coordinates	Center
TitlePositionX	position of object titles, x component	
TitlePositionY	position of object titles, y component	

Attribute	Purpose	Default Value
TitlePositionZ	position of object titles, z component	
Top	top center of cones, cylinders, pyramids and prisms	[0, 0, 1]
TopX	base and top center of cones, cylinders, pyramids and prisms	0
TopY	base and top center of cones, cylinders, pyramids and prisms	0
TopZ	base and top center of cones, cylinders, pyramids and prisms	1
TopRadius	top radius of cones/conical frustums and pyramids/frustums of pyramids	0
Visible	visibility	TRUE
VisibleAfter	object visible after this time value	
VisibleBefore	object visible until this time value	
VisibleFromTo	object visible during this time range	
VisibleAfterEnd	object visible after its animation time ended?	TRUE
VisibleBeforeBegin	object visible before its animation time starts?	TRUE

## Examples

### Example 1

We draw a cone with base radius 6:

```
plot(plot::Cone(6, [0, 0, 0], [0, 0, 10])):
```

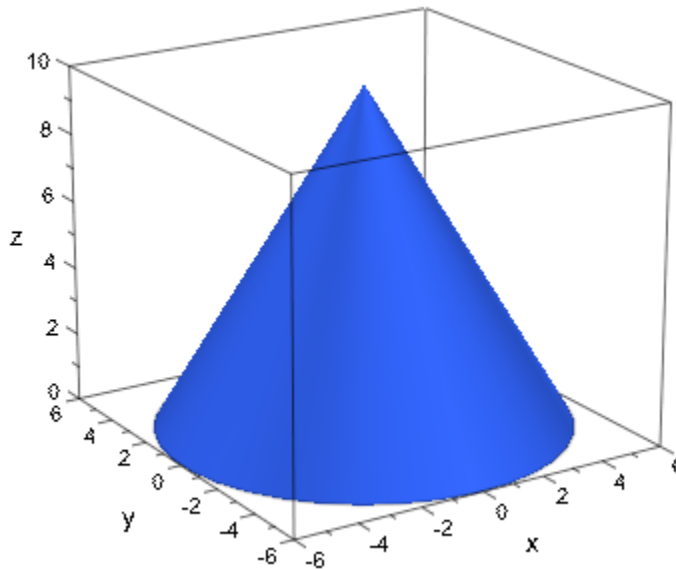

### Example 2

We create a conical frustum by specifying a non-zero top radius. Note that no discs are attached to the base and the top. You can look through the frustum:

```
br := 16: base := [3, 4, 5]:  
tr := 7: top := [11, 12, 13]:  
plot(plot::Cone(br, base, tr, top, FillColor = RGB::Red)):
```

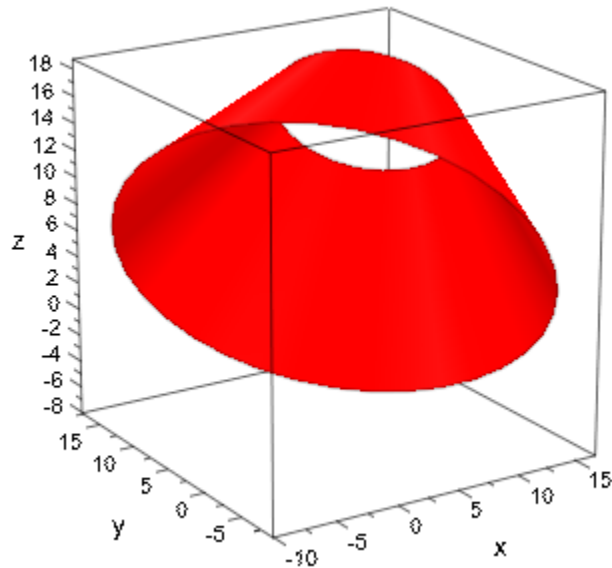

We add the discs at the base and the top. Their normals  $n$  are given as the vector from the base to the top:

```
n := zip(top, base, _subtract):  
plot(plot::Circle3d(br, base, n, Filled = TRUE),  
      plot::Circle3d(tr, top, n, Filled = TRUE),  
      plot::Cone(br, base, tr, top),  
      LinesVisible = FALSE, FillColor = RGB::Red):
```

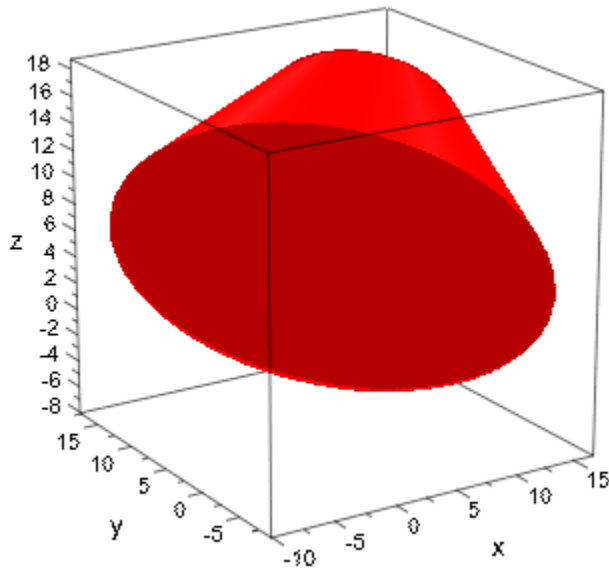

```
delete br, base, tr, top, n:
```

### Example 3

A tube or cylinder (in the mathematical sense, i.e., the lateral sides of a physical cylinder) is a special case of a conical frustum with the same top and bottom radius:

```
plot(plot::Cone(6, [0, 0, 0], 6, [11, 12, 13],  
             FillColor = RGB::Yellow,  
             LinesVisible = TRUE)):
```



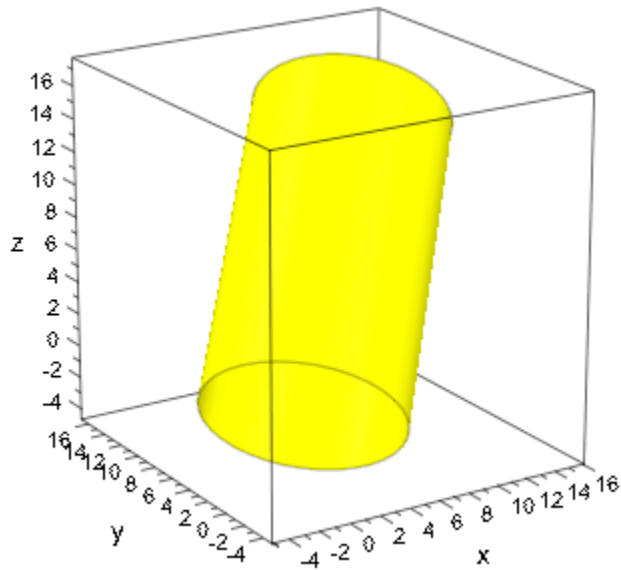

## Example 4

Bottom and top radii and centers can be animated:

```
plot(plot::Cone(sin(a)^2, [sin(2*a), cos(2*a), 0],  
               cos(a)^2, [cos(2*a), sin(2*a), 1],  
               a = 0..PI, FillColor = RGB::Green)):
```

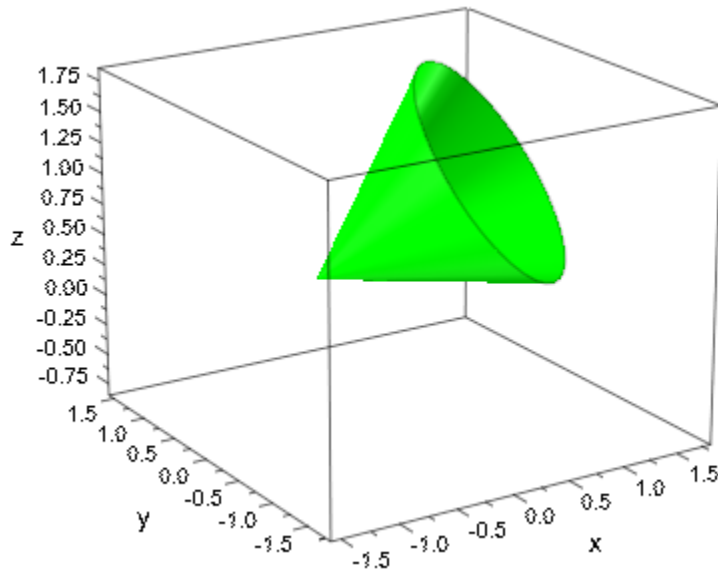

## Parameters

### **br**

The base radius of the cone. This must be a real numerical value or an arithmetical expression (Symbolic Math Toolbox) of the animation parameter  $a$ .

$br$  is equivalent to the attribute `BaseRadius`.

### **$b_x$ , $b_y$ , $b_z$**

The lower center point. The coordinates  $b_x$ ,  $b_y$ ,  $b_z$  must be real numerical values or arithmetical expressions (Symbolic Math Toolbox) of the animation parameter  $a$ .

$b_x$ ,  $b_y$ ,  $b_z$  are equivalent to the attributes `BaseX`, `BaseY`, `BaseZ`.

**tr**

The top radius of the cone/conical frustum. This must be a real numerical value or an arithmetical expression (Symbolic Math Toolbox) of the animation parameter **a**. If no top radius is specified, a cone with top radius  $tr = 0$  is created.

**tr** is equivalent to the attribute `TopRadius`.

**t<sub>x</sub>, t<sub>y</sub>, t<sub>z</sub>**

The upper center point. The coordinates **t<sub>x</sub>**, **t<sub>y</sub>**, **t<sub>z</sub>** must be real numerical values or arithmetical expressions (Symbolic Math Toolbox) of the animation parameter **a**.

**t<sub>x</sub>**, **t<sub>y</sub>**, **t<sub>z</sub>** are equivalent to the attributes `TopX`, `TopY`, `TopZ`.

**a**

Animation parameter, specified as  $a = a_{\min} \dots a_{\max}$ , where  $a_{\min}$  is the initial parameter value, and  $a_{\max}$  is the final parameter value.

## See Also

**MuPAD Functions**

`plot` | `plot::copy`

**MuPAD Graphical Primitives**

`plot::Cylinder` | `plot::Prism` | `plot::Pyramid`

## plot::Conformal

(complex-valued) conformal function plot

### Syntax

```
plot::Conformal(f, z = z1 .. z2, <a = amin .. amax>, options)
```

### Description

`plot::Conformal(f(z), z = z1..z2 )` is a plot of the conformal function  $f$  over the complex interval  $z_1..z_2$ .

`plot::Conformal` creates plots of (conformal) complex-valued functions of one complex variable. They are displayed by showing the image of a rectangular grid over an interval.

By default, the attribute `LineColorType = Flat` is set. All curves are displayed with the color given by the attribute `LineColor` (or `Color` for short).

When specifying the attribute `LineColorType = Dichromatic`, a color blend from `LineColor` to `LineColor2` is used (“height coloring”).

When specifying the attribute `LineColorType = Functional` without specifying a `LineColorFunction`, all curves parametrized by the real part of the pre-image points are displayed with the flat color `LineColor`, whereas all curves parametrized by the imaginary part of the pre-image points are displayed with the flat color `LineColor2`.

A user defined `LineColorFunction` is a procedure  $(z, x, y, \text{flag}) \rightarrow \text{RGB-color}$  that will be called with complex floating-point arguments  $z$  from the range of pre-images of the conformal function  $f$ , the real floating point values  $x = \text{Re}(f(z))$ ,  $y = \text{Im}(f(z))$ , and the integer value `flag` which has the values 1 or 2. The flag value 1 determines the color of the curves parametrized by the real part of  $z$ , the flag value 2 determines the color of the curves parametrized by the imaginary part of  $z$ . The color function must return an RGB color, i.e., a list of 3 real floating point values between 0.0 and 1.0. For example,

```
LineColorFunction = proc(z, x, y, flag)
  begin
```

```

if flag = 1 then
  return(RGB::Blue)
else
  return(RGB::Red)
end_if;
end_proc

```

displays all curves parametrized by  $\operatorname{Re}(z)$  in blue, while the orthogonal curves, parametrized by  $\operatorname{Im}(z)$ , are displayed in red.

See the examples in the documentation of RGB for another way of displaying complex functions.

## Attributes

Attribute	Purpose	Default Value
AdaptiveMesh	adaptive sampling	0
AffectViewingBox	influence of objects on the ViewingBox of a scene	TRUE
AntiAliased	antialiased lines and points?	TRUE
Color	the main color	RGB::Blue
Frames	the number of frames in an animation	50
Function	function expression or procedure	
Legend	makes a legend entry	
LegendText	short explanatory text for legend	
LegendEntry	add this object to the legend?	TRUE
LineColor	color of lines	RGB::Blue
LineWidth	width of lines	0.35
LineColor2	color of lines	RGB::DeepPink

<b>Attribute</b>	<b>Purpose</b>	<b>Default Value</b>
LineStyle	solid, dashed or dotted lines?	Solid
LinesVisible	visibility of lines	TRUE
LineColorType	line coloring types	Flat
LineColorFunction	functional line coloring	
LineColorDirection	the direction of color transitions on lines	[0, 1]
LineColorDirectionX	x-component of the direction of color transitions on lines	0
LineColorDirectionY	y-component of the direction of color transitions on lines	1
Mesh	number of sample points	[11, 11]
Name	the name of a plot object (for browser and legend)	
ParameterEnd	end value of the animation parameter	
ParameterName	name of the animation parameter	
ParameterBegin	initial value of the animation parameter	
ParameterRange	range of the animation parameter	
PointSize	the size of points	1.5
PointsVisible	visibility of mesh points	FALSE
Submesh	density of submesh (additional sample points)	[0, 0]
TimeEnd	end time of the animation	10.0
TimeBegin	start time of the animation	0.0
TimeRange	the real time span of an animation	0.0 .. 10.0
Title	object title	

Attribute	Purpose	Default Value
TitleFont	font of object titles	[" sans-serif ", 11]
TitlePosition	position of object titles	
TitleAlignment	horizontal alignment of titles w.r.t. their coordinates	Center
TitlePositionX	position of object titles, x component	
TitlePositionY	position of object titles, y component	
Visible	visibility	TRUE
VisibleAfter	object visible after this time value	
VisibleBefore	object visible until this time value	
VisibleFromTo	object visible during this time range	
VisibleAfterEnd	object visible after its animation time ended?	TRUE
VisibleBeforeBegin	object visible before its animation time starts?	TRUE
XMesh	number of sample points for parameter "x"	11
XSubmesh	density of additional sample points for parameter "x"	0
YMesh	number of sample points for parameter "y"	11
YSubmesh	density of additional sample points for parameter "y"	0
ZMax	final value of parameter "z"	
ZMin	initial value of parameter "z"	
ZName	name of parameter "z"	

Attribute	Purpose	Default Value
ZRange	range of parameter "z"	

## Examples

### Example 1

By plotting the identity function, we are presented the pre-image used by `plot::Conformal`:

```
plot(plot::Conformal(z, z = 0..1+I))
```

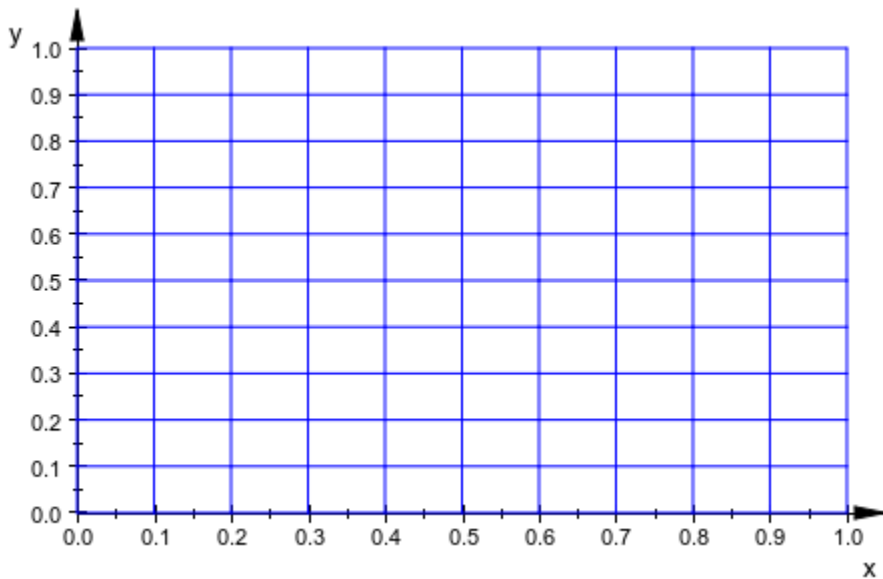

The important property of conformal functions, as far as plots are concerned, is that orthogonal lines are mapped onto curves meeting orthogonally:

```
plot(plot::Conformal(z^2, z = 0..1+I))
```



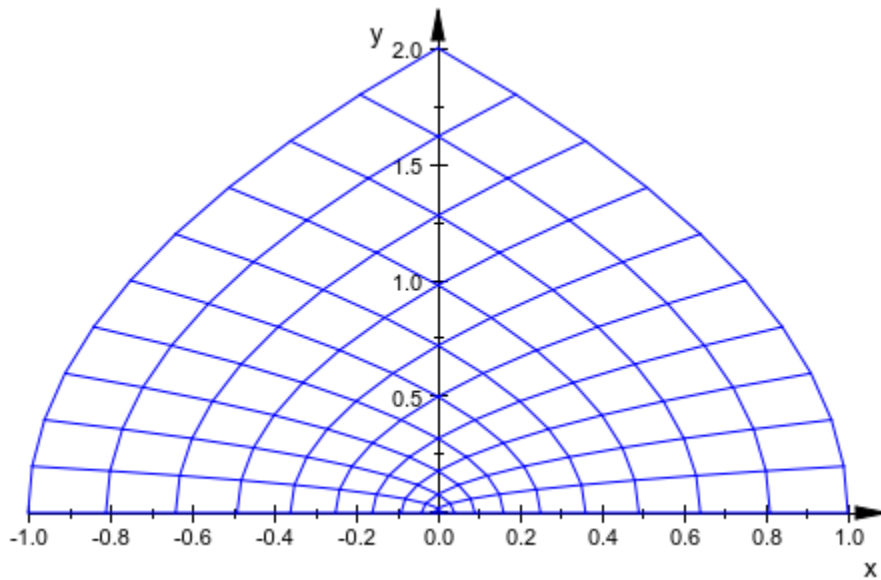

This property allows to visually detect overlapping regions (in some cases); in the following example this is the case in the left semi-plane:

```
plot(plot::Conformal(z^(3/2), z = -1-I..1+I))
```

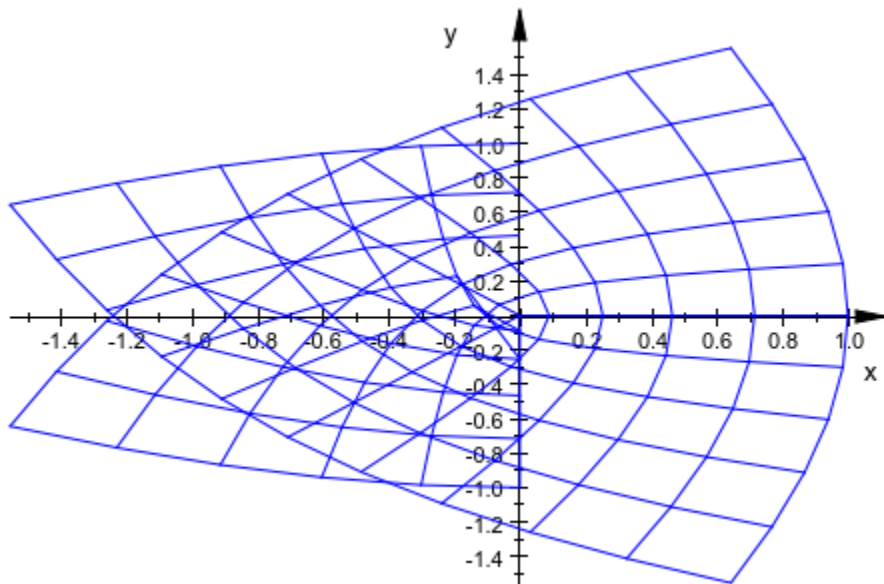

## Example 2

The default mesh may in some cases be too coarse:

```
plot(plot::Conformal(sin(z^2), z = 0..1+I))
```

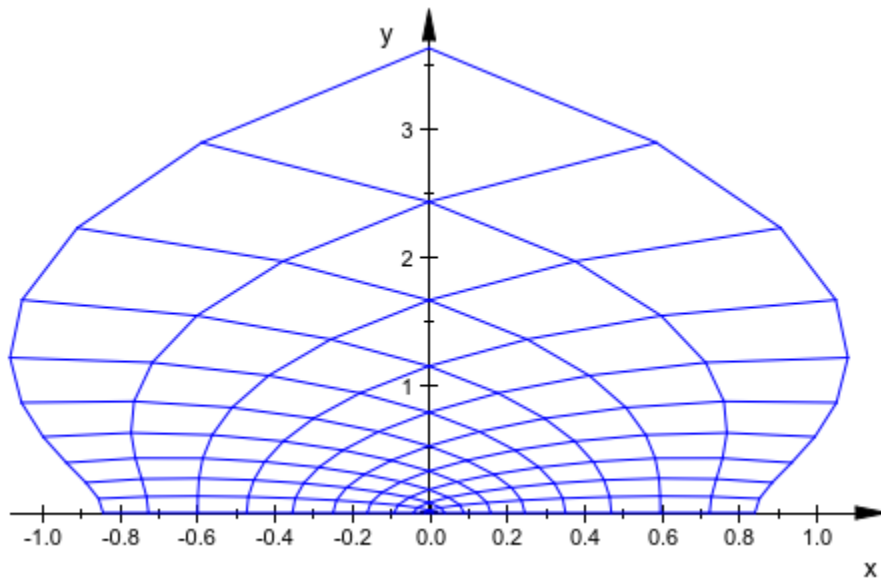

There are at least three ways of improving this plot. Firstly, we can set Mesh to a higher value:

```
plot(plot::Conformal(sin(z^2), z = 0..1+I, Mesh = [50, 50]))
```

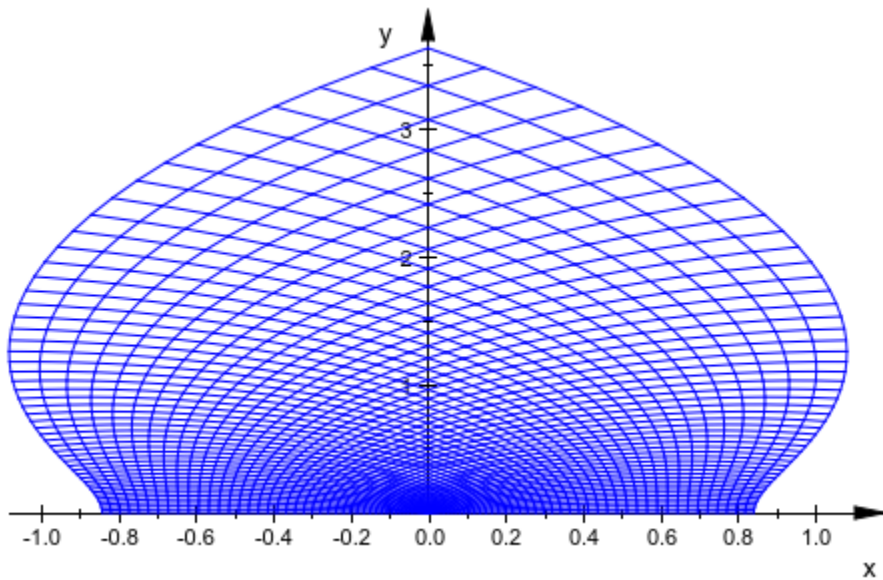

Another option would be to increase Submesh to get smoother, not more, lines:

```
plot(plot::Conformal(sin(z^2), z = 0..1+I, Submesh = [2, 2]))
```

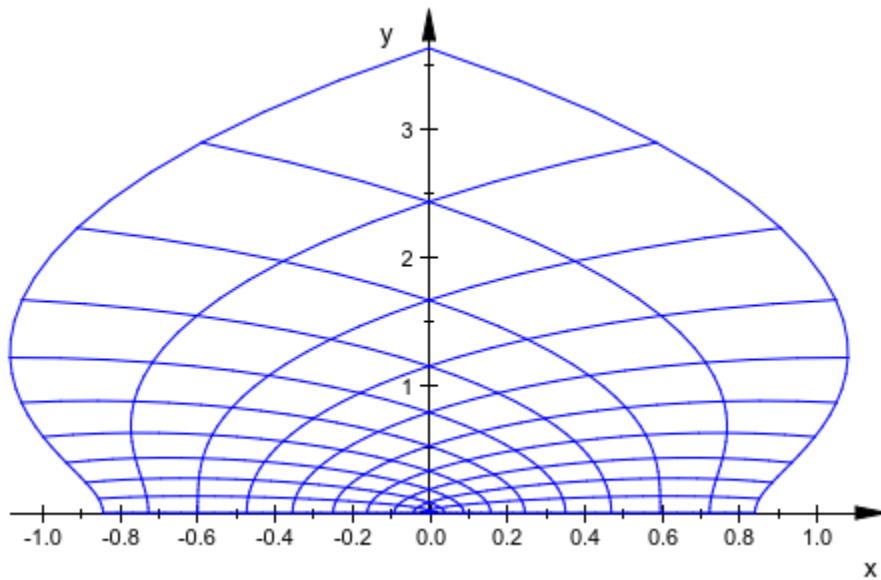

Finally, we can also ask for an adaptive refinement of the submesh by setting `AdaptiveMesh` to some positive value:

```
plot(plot::Conformal(sin(z^2), z = 0..1+I, AdaptiveMesh = 2))
```

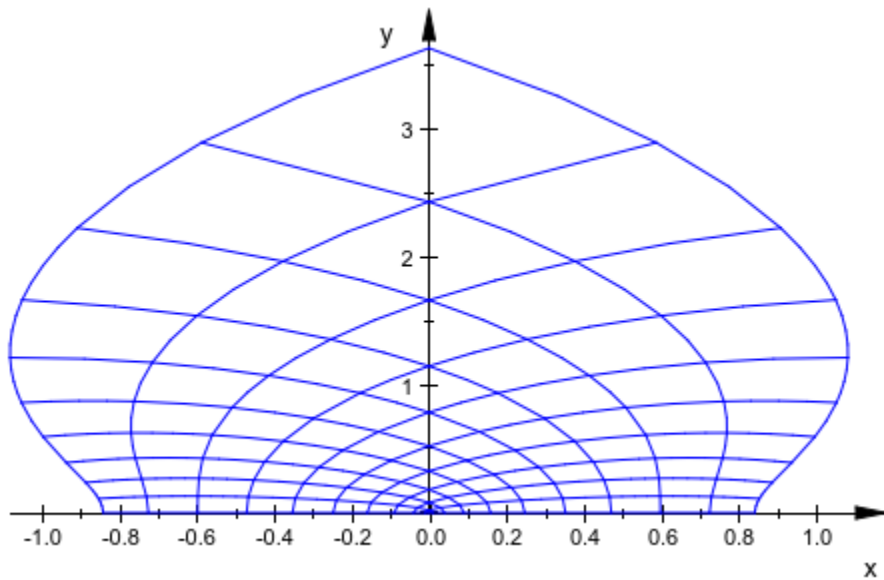

### Example 3

Here is the image of the complex rectangle  $0 \leq \operatorname{Re}(z) \leq x$ ,  $0 \leq \operatorname{Im}(z) \leq 1$  under the map  $z \rightarrow \operatorname{besselJ}(0, z)$ . We choose  $x$  as the second positive root of  $\operatorname{Im}(\operatorname{besselJ}(0, x + I))$ :

```
numeric::solve(Im(besselJ(0, x + I)), x = i .. i+1) $ i = 0..7
```

```
{0.0}, ∅, ∅, {3.791394324}, ∅, ∅, {6.993364687}, ∅
```

```
plot(plot::Conformal(besselJ(0, z), z = 0 .. 6.9934 + I,
  Mesh = [31, 10]))
```

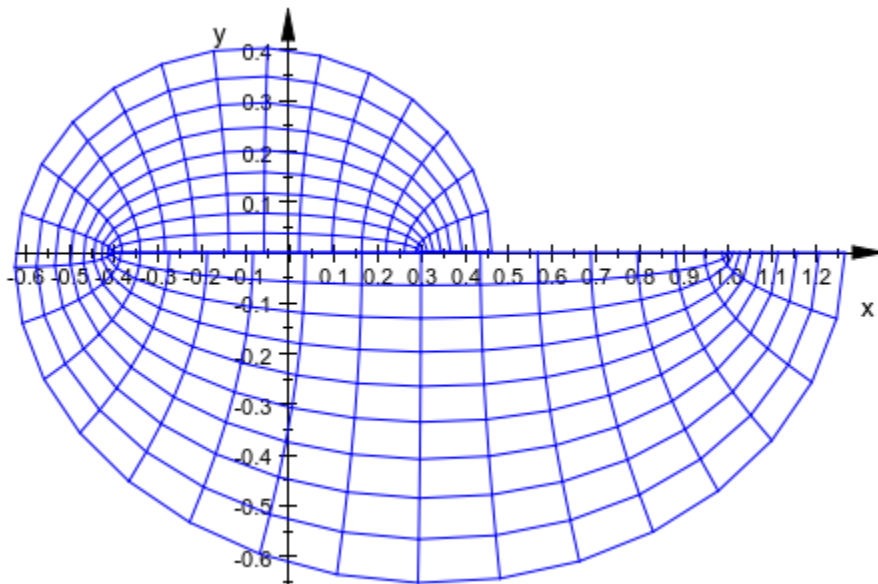

## Parameters

**f**

An expression in  $z$  and the animation parameter, if present. Expected to be conformal in  $z$ .

$f$  is equivalent to the attribute `Function`.

**z**

The independent variable: An identifier or indexed identifier.

$z$  is equivalent to the attribute `ZName`.

**$z_1 \dots z_2$**

The (complex) range over which  $f$  should be plotted:  $z_1$  and  $z_2$  should be complex-valued expressions, possibly in the animation parameter.

$z_1 .. z_2$  is equivalent to the attribute `ZRange`.

**a**

Animation parameter, specified as `a = amin .. amax`, where `amin` is the initial parameter value, and `amax` is the final parameter value.

## See Also

### **MuPAD Functions**

`plot` | `plot::copy`

### **MuPAD Graphical Primitives**

`plot::Curve2d` | `plot::Function2d`



# plot::Curve2d

Parameterized 2D curves

## Syntax

```
plot::Curve2d([x, y], t = t_min .. t_max, <a = a_min .. a_max>, options)
```

```
plot::Curve2d(A2d, t = t_min .. t_max, <a = a_min .. a_max>, options)
```

```
plot::Curve2d(piecewiseF(t), t = t_min .. t_max, <a = a_min .. a_max>, options)
```

## Description

`plot::Curve2d([x(t), y(t)], t = t_min .. t_max)` creates the planar curve

$$\{(x(t), y(t)) \mid t_{\min} \leq t \leq t_{\max}\}.$$

`plot::Curve2d` plots curves in one parameter. See “Example 1” on page 24-220 (Symbolic Math Toolbox),

You can use it to plot animated curves. See “Example 2” on page 24-221 (Symbolic Math Toolbox).

The curves can contain poles, in which case automatic clipping is used by default. See “Example 4” on page 24-224 (Symbolic Math Toolbox).

By default, curves are sampled at equidistant values of the parameter  $t$ . To change this behavior so that a denser sampling rate is used in areas of higher curvature, use the attribute `AdaptiveMesh`. See “Example 5” on page 24-226 (Symbolic Math Toolbox).

Curves are graphical objects that can be manipulated. See the examples and the documentation for the attributes for details.

## Attributes

Attribute	Purpose	Default Value
AdaptiveMesh	adaptive sampling	0
AffectViewingBox	influence of objects on the ViewingBox of a scene	TRUE
AntiAliased	antialiased lines and points?	TRUE
Color	the main color	RGB::Blue
DiscontinuitySearch	semi-symbolic search for discontinuities	TRUE
Frames	the number of frames in an animation	50
Legend	makes a legend entry	
LegendText	short explanatory text for legend	
LegendEntry	add this object to the legend?	TRUE
LineColor	color of lines	RGB::Blue
LineWidth	width of lines	0.35
LineColor2	color of lines	RGB::DeepPink
LineStyle	solid, dashed or dotted lines?	Solid
LinesVisible	visibility of lines	TRUE
LineColorType	line coloring types	Flat
LineColorFunction	functional line coloring	
LineColorDirection	the direction of color transitions on lines	[0, 1]
LineColorDirectionX	x-component of the direction of color transitions on lines	0
LineColorDirectionY	y-component of the direction of color transitions on lines	1

Attribute	Purpose	Default Value
Mesh	number of sample points	121
Name	the name of a plot object (for browser and legend)	
ParameterEnd	end value of the animation parameter	
ParameterName	name of the animation parameter	
ParameterBegin	initial value of the animation parameter	
ParameterRange	range of the animation parameter	
PointSize	the size of points	1.5
PointStyle	the presentation style of points	FilledCircles
PointsVisible	visibility of mesh points	FALSE
Submesh	density of submesh (additional sample points)	0
TimeEnd	end time of the animation	10.0
TimeBegin	start time of the animation	0.0
TimeRange	the real time span of an animation	0.0 .. 10.0
Title	object title	
TitleFont	font of object titles	[" sans-serif ", 11]
TitlePosition	position of object titles	
TitleAlignment	horizontal alignment of titles w.r.t. their coordinates	Center
TitlePositionX	position of object titles, x component	
TitlePositionY	position of object titles, y component	
UMax	final value of parameter "u"	5

Attribute	Purpose	Default Value
UMesh	number of sample points for parameter "u"	121
UMin	initial value of parameter "u"	-5
UName	name of parameter "u"	
URange	range of parameter "u"	-5 .. 5
USubmesh	density of additional sample points for parameter "u"	0
Visible	visibility	TRUE
VisibleAfter	object visible after this time value	
VisibleBefore	object visible until this time value	
VisibleFromTo	object visible during this time range	
VisibleAfterEnd	object visible after its animation time ended?	TRUE
VisibleBeforeBegin	object visible before its animation time starts?	TRUE
XFunction	function for x values	
YFunction	function for y values	

## Examples

### Example 1

Archimedes' Spiral is defined by  $f(r) = (r \sin(r), r \cos(r))$ . The corresponding call to `plot::Curve2d` reads:

```
curve := plot::Curve2d([r*sin(r), r*cos(r)], r = 0..35)
```

```
plot::Curve2d([r sin(r), r cos(r)], r = 0..35)
```

```
plot(curve)
```

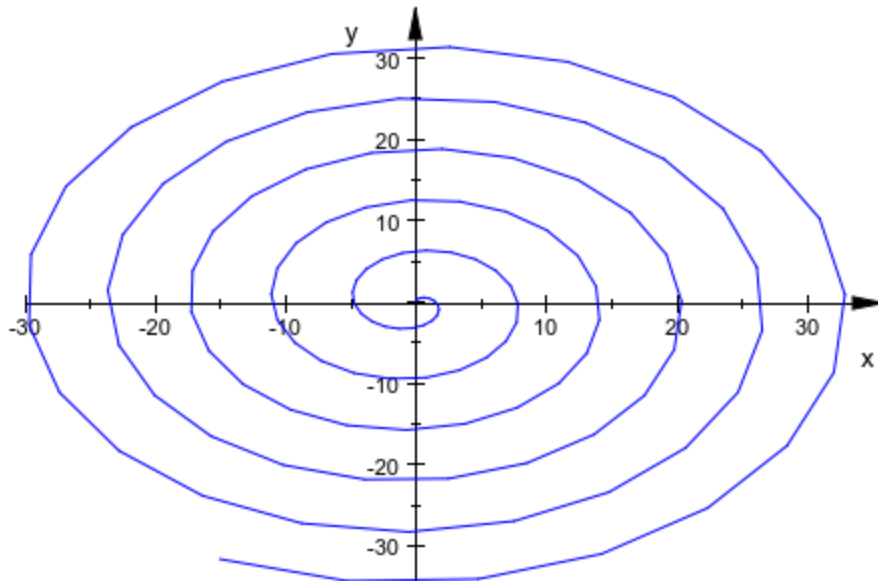

Note that this particular example is even more straightforward to plot using `plot::Polar`.

## Example 2

Continuing the example from above, define an easy animation by making the angular part time-dependent:

```
curve := plot::Curve2d([r*sin(r-t), r*cos(r-t)],
                       r = 0..35, t = 0..2*PI,
                       TimeEnd = 5,
                       ViewingBox = [-25..25, -25..25]):
plot(curve)
```

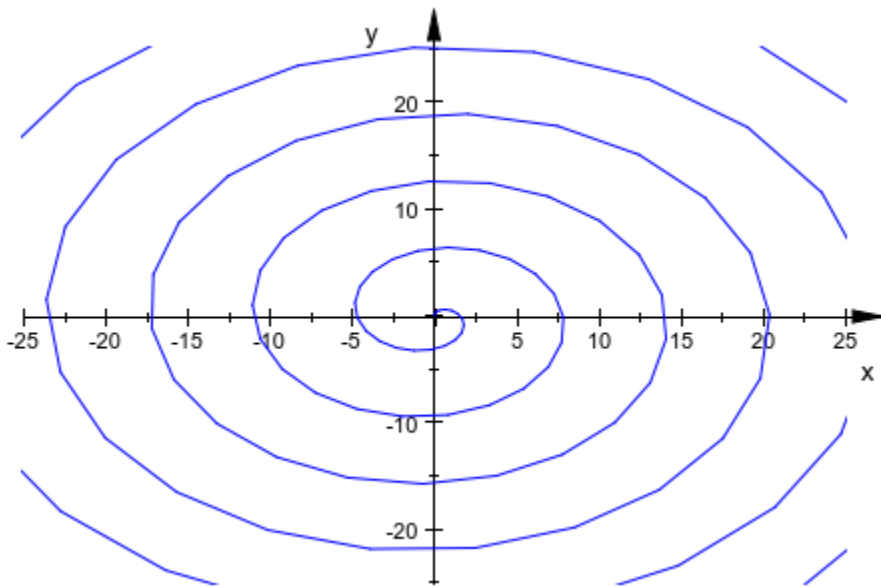

Note that to start the animation, you have to double-click the image in the notebook and choose “Start” from the “Animation” menu.

### Example 3

Another useful and easy type of animation is achieved by animating the parameter range. This creates the illusion of the curve being drawn in real time:

```
curve := plot::Curve2d([sin(thet), cos(thet)],  
                        thet = 0..a,  
                        a = 0..2*PI):  
plot(curve)
```

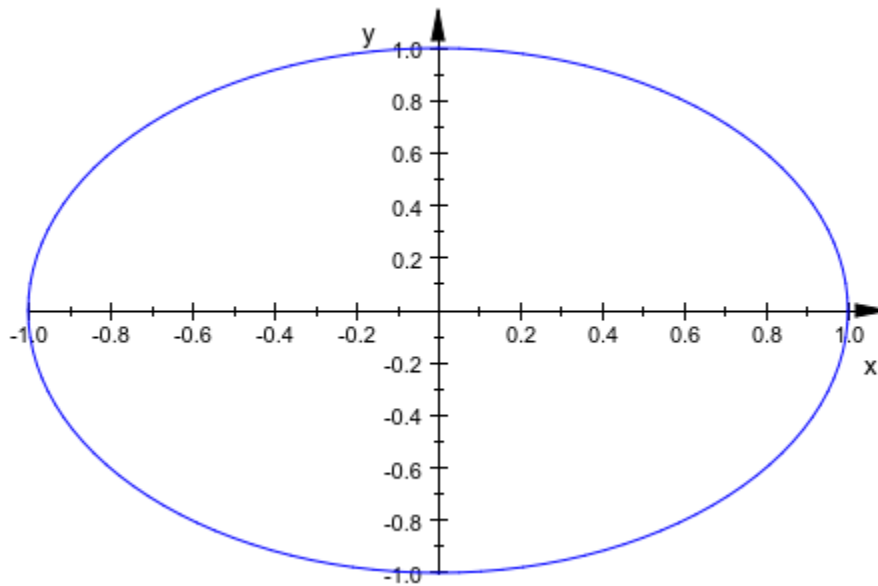

Combining this with an animated LineColorFunction, you can even simulate motion:

```
colorfunc := (thet, x, y, a) -> [a-thet, a-thet, 1.0]:  
curve := plot::Curve2d([sin(3*thet), sin(4*thet)],  
    thet = a-1..a,  
    LineColorFunction = colorfunc,  
    LineWidth = 1,  
    a = 0..2*PI):  
plot(curve)
```

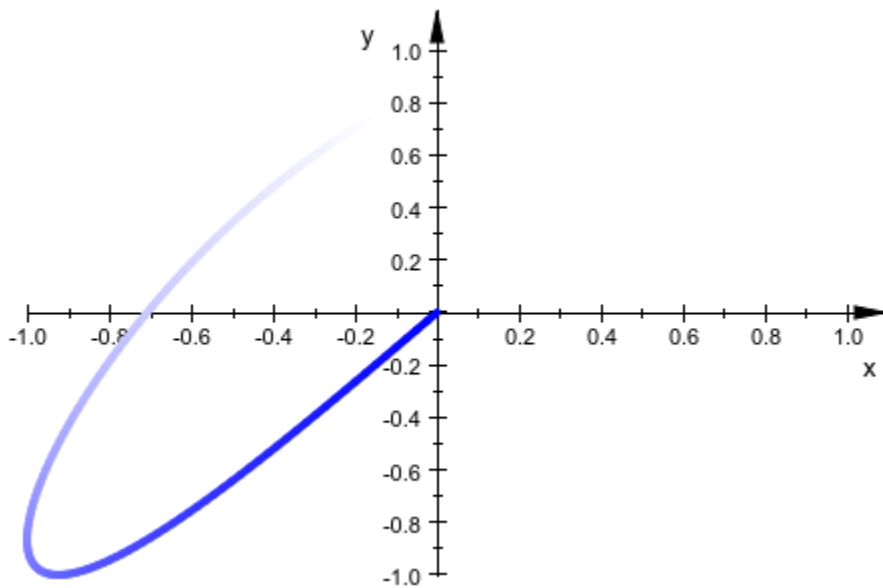

### Example 4

Curves with poles are automatically clipped:

```
curve := plot::Curve2d([(1+tan(3*t)^2)*sin(t),  
                        (1+tan(3*t)^2)*cos(t)],  
                        t = 0..2*PI):  
plot(curve);
```



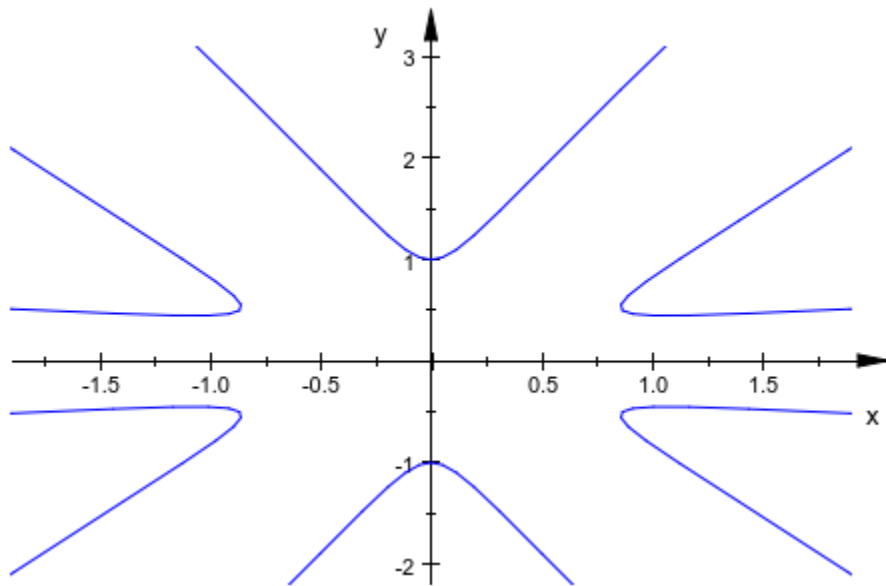

You can explicitly set other values for viewing box:

```
curve::ViewingBox := [-2..2, -2..2]:  
plot(curve)
```

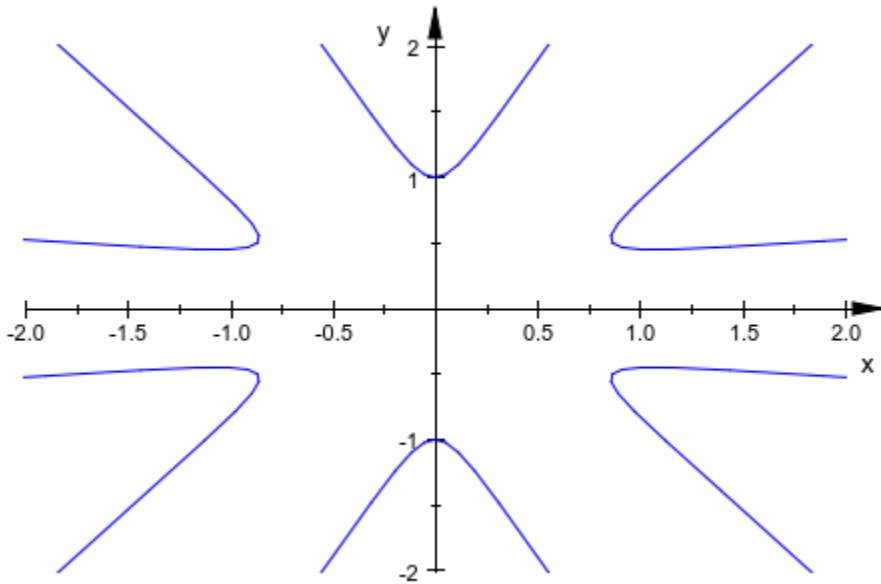

### Example 5

By default, curves are drawn by evaluating at equidistant values of the curve parameter. For curves that have few regions of high curvature, this may be inappropriate:

```
plot(plot::Curve2d([arctan(t), t^2-10*exp(-50*t^2)],  
t = -PI..PI))
```

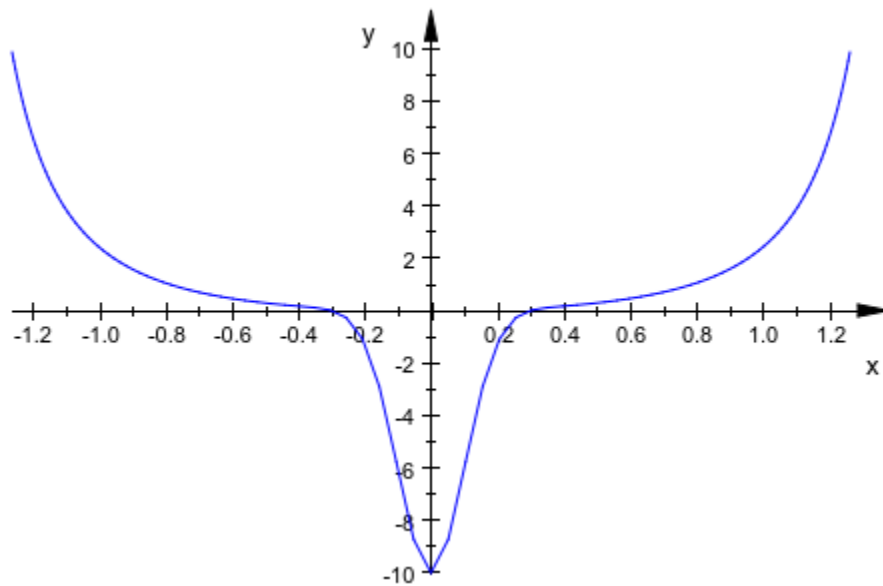

Note the hard “kink” at the bottom of the picture. On the other hand, the remainder of the curve is sufficiently smooth, so globally increasing the number of evaluation points is not desirable. `AdaptiveMesh` makes `plot::Curve2d` look for these kinks and adaptively increase the mesh density in problematic areas:

```
plot(plot::Curve2d([arctan(t), t^2-10*exp(-50*t^2)],  
t = -PI..PI, AdaptiveMesh = 2))
```

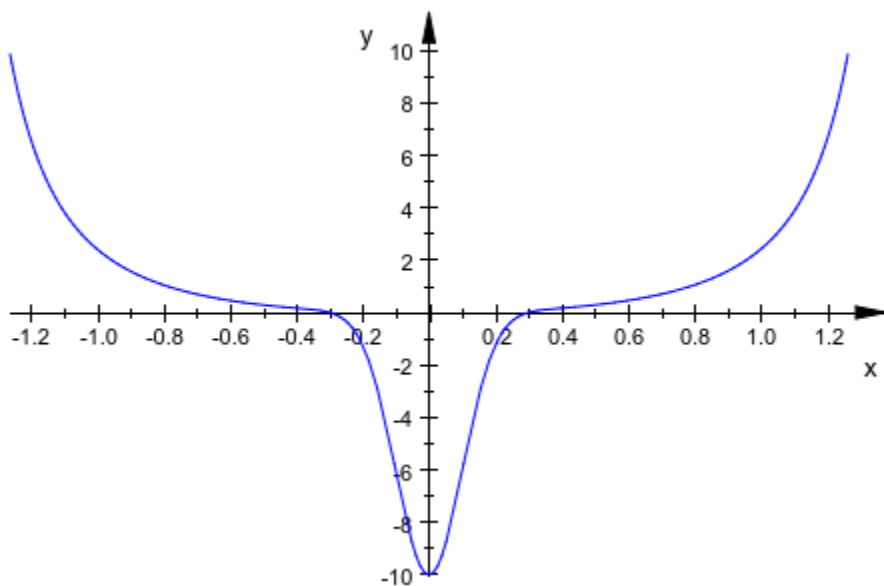

### Example 6

To display a curve in the complex plane, map the list-valued function  $[\text{Re}, \text{Im}]$  to the curve:

```
plot(plot::Curve2d([Re, Im](zeta(I*y+1/2)), y=0..42,  
    AdaptiveMesh=3),  
    XAxisTitle = "Re(z)", YAxisTitle = "Im(z)")
```

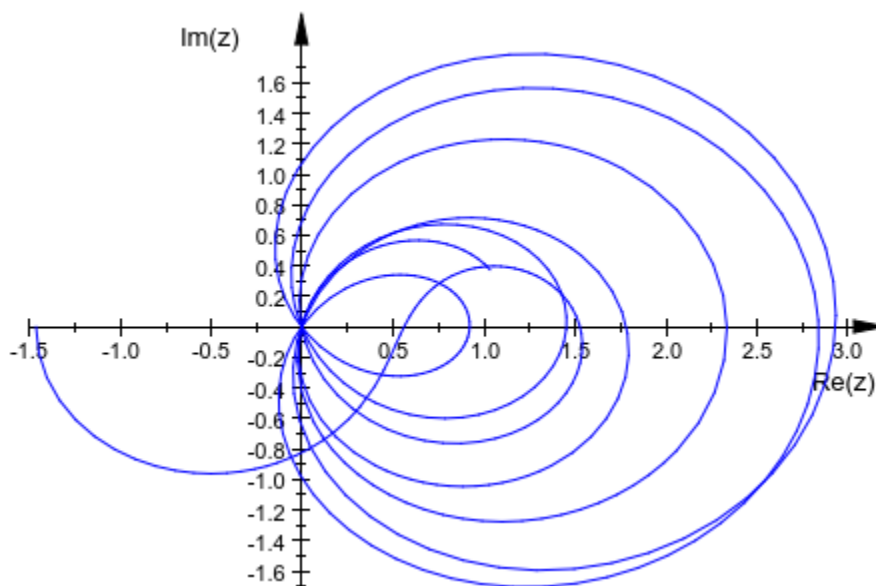

## Parameters

**x, y**

Real-valued expressions in  $t$  (and possibly the animation parameter)

**A<sub>2d</sub>**

A matrix on page 1-1340 of category `Cat::Matrix` with two entries that provide the parametrization  $x, y$  of a 2D curve

**piecewiseF( $t$ )**

A `piecewise` object

**t**

An identifier on page 7-29 or an indexed identifier on page 1-1017

**$t_{\min}$ ,  $t_{\max}$** 

Real-valued expressions (possibly in the animation parameter)

**a**Animation parameter, specified as  $a = a_{\min}..a_{\max}$ , where  $a_{\min}$  is the initial parameter value, and  $a_{\max}$  is the final parameter value.

## See Also

### MuPAD Functions

plot | plot::copy

### MuPAD Graphical Primitives

plot::Curve3d | plot::Function2d | plot::Function3d | plot::Polygon2d |  
plot::Polygon3d | plot::Surface

# plot::Curve3d

Parameterized 3D curves

## Syntax

```
plot::Curve3d([x, y, z], t = t_min .. t_max, <a = a_min .. a_max>, options)
```

```
plot::Curve3d(A_3d, t = t_min .. t_max, <a = a_min .. a_max>, options)
```

```
plot::Curve3d(piecewiseF(t), t = t_min .. t_max, <a = a_min .. a_max>, options)
```

## Description

`plot::Curve3d([x(t), y(t), z(t)], t = t_min .. t_max)` creates the space curve

$$\{(x(t), y(t), z(t)) \mid t_{\min} \leq t \leq t_{\max}\}.$$

`plot::Curve3d` constructs curves in one parameter

You can use it to plot animated curves. See “Example 1” on page 24-235 (Symbolic Math Toolbox).

The curves can contain poles, in which case automatic clipping is used by default. See “Example 2” on page 24-235 (Symbolic Math Toolbox).

By default, curves are sampled at equidistant values of the parameter  $t$ . To change this behavior so that a denser sampling rate is used in areas of higher curvature, use the attribute `AdaptiveMesh`.

Curves are graphical objects that can be manipulated. See the examples and the documentation for the attributes for details.

## Attributes

Attribute	Purpose	Default Value
AdaptiveMesh	adaptive sampling	0
AffectViewingBox	influence of objects on the ViewingBox of a scene	TRUE
Color	the main color	RGB::Blue
DiscontinuitySearch	semi-symbolic search for discontinuities	TRUE
Frames	the number of frames in an animation	50
Legend	makes a legend entry	
LegendText	short explanatory text for legend	
LegendEntry	add this object to the legend?	TRUE
LineColor	color of lines	RGB::Blue
LineWidth	width of lines	0.35
LineColor2	color of lines	RGB::DeepPink
LineStyle	solid, dashed or dotted lines?	Solid
LinesVisible	visibility of lines	TRUE
LineColorType	line coloring types	Flat
LineColorFunction	functional line coloring	
LineColorDirection	the direction of color transitions on lines	[0, 0, 1]
LineColorDirectionX	x-component of the direction of color transitions on lines	0
LineColorDirectionY	y-component of the direction of color transitions on lines	0
LineColorDirectionZ	z-component of the direction of color transitions on lines	1



<b>Attribute</b>	<b>Purpose</b>	<b>Default Value</b>
Mesh	number of sample points	121
Name	the name of a plot object (for browser and legend)	
ParameterEnd	end value of the animation parameter	
ParameterName	name of the animation parameter	
ParameterBegin	initial value of the animation parameter	
ParameterRange	range of the animation parameter	
PointSize	the size of points	1.5
PointStyle	the presentation style of points	FilledCircles
PointsVisible	visibility of mesh points	FALSE
Submesh	density of submesh (additional sample points)	0
TimeEnd	end time of the animation	10.0
TimeBegin	start time of the animation	0.0
TimeRange	the real time span of an animation	0.0 .. 10.0
Title	object title	
TitleFont	font of object titles	[" sans-serif ", 11]
TitlePosition	position of object titles	
TitleAlignment	horizontal alignment of titles w.r.t. their coordinates	Center
TitlePositionX	position of object titles, x component	
TitlePositionY	position of object titles, y component	

<b>Attribute</b>	<b>Purpose</b>	<b>Default Value</b>
TitlePositionZ	position of object titles, z component	
UMax	final value of parameter "u"	5
UMesh	number of sample points for parameter "u"	121
UMin	initial value of parameter "u"	-5
UName	name of parameter "u"	
URange	range of parameter "u"	-5 .. 5
USubmesh	density of additional sample points for parameter "u"	0
Visible	visibility	TRUE
VisibleAfter	object visible after this time value	
VisibleBefore	object visible until this time value	
VisibleFromTo	object visible during this time range	
VisibleAfterEnd	object visible after its animation time ended?	TRUE
VisibleBeforeBegin	object visible before its animation time starts?	TRUE
XFunction	function for x values	
YFunction	function for y values	
ZFunction	function for z values	

## Examples

### Example 1

A useful and easy type of animation is achieved by animating the parameter range. This creates the illusion of the curve being drawn in real time:

```
curve := plot::Curve3d([sin(thet)*cos(20*thet),
                       sin(thet)*sin(20*thet),
                       cos(thet)],
                       thet = 0..a,
                       a = 0..PI):
plot(curve)
```

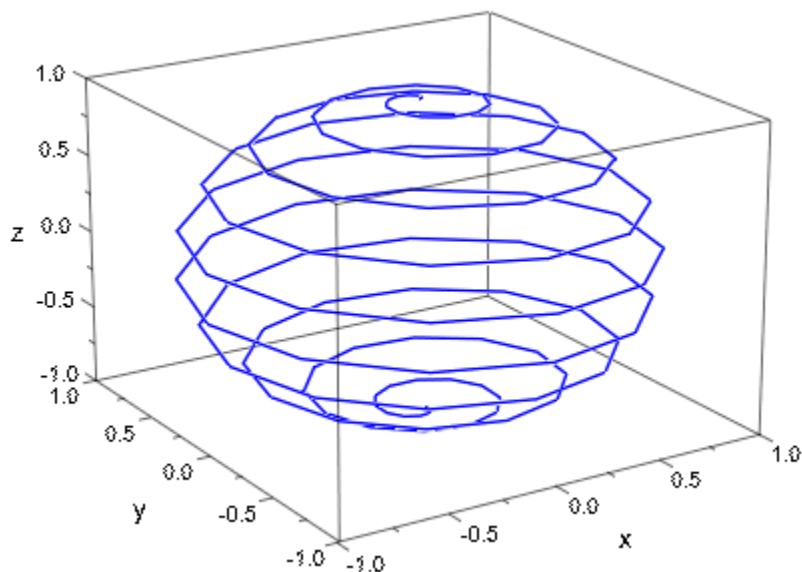

### Example 2

Curves with poles are automatically clipped:

```
curve := plot::Curve3d([(1 + tan(3*t)^2)*sin(t),
                       (1 + tan(3*t)^2)*cos(t),
```

```
plot(curve);  
cos(t)],  
t = 0..2*PI):
```

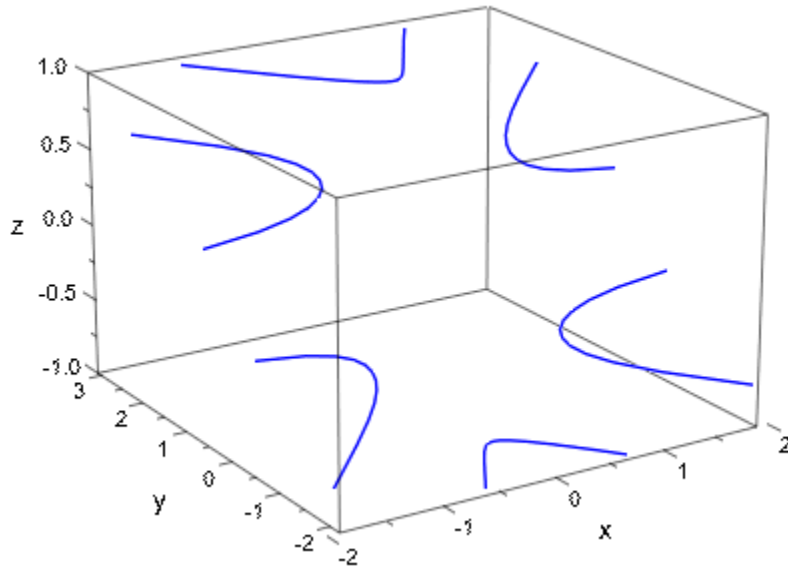

If the automatically chosen viewing box is not to your liking, you can explicitly set other values:

```
curve::ViewingBox := [-3..3, -3..3, -3..3]:  
plot(curve)
```

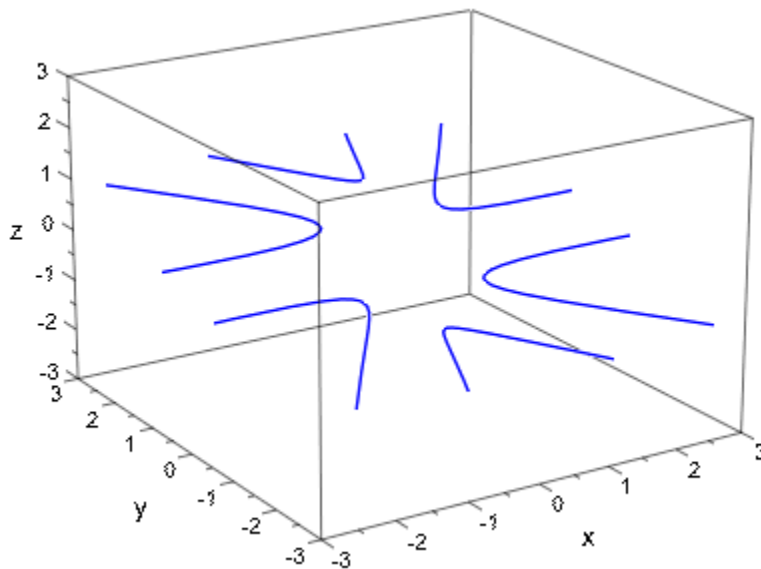

### Example 3

Create the following piecewise function:

```
f := piecewise([t < 0, [t, sin(10*t)^2, t^3]],
               [t >= 0, [t, 5*t/exp(t), -t^2]])
```

$$\begin{cases} [t, \sin(10t)^2, t^3] & \text{if } t < 0 \\ [t, 5te^{-t}, -t^2] & \text{if } 0 \leq t \end{cases}$$

Now, plot this function:

```
plot(plot::Curve3d(f, t = -10..10))
```

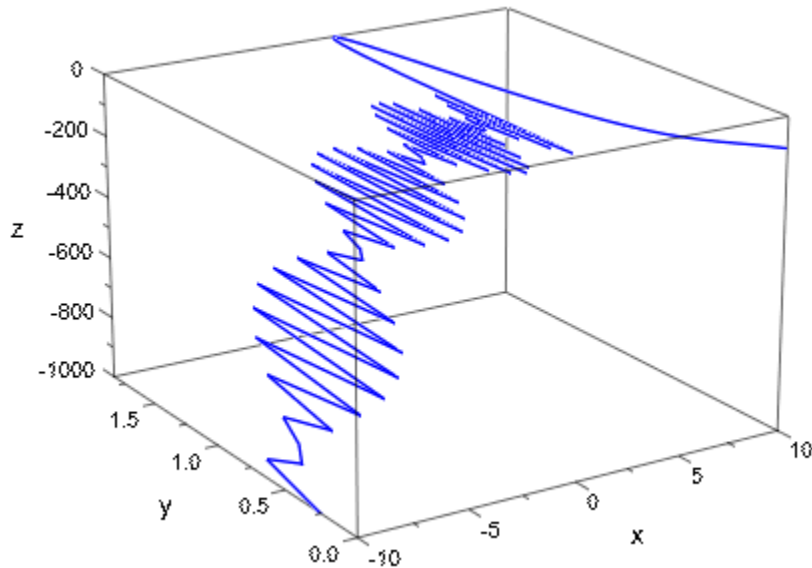

## Parameters

**x, y, z**

Real-valued expressions in  $t$  (and possibly the animation parameter)

**$A_{3d}$**

A matrix on page 1-1340 of category `Cat::Matrix` with three entries that provide the parametrization  $x, y, z$  of a 3D curve

**`piecewiseF(t)`**

A `piecewise` object

**$t$**

An identifier on page 7-29 or an indexed identifier on page 1-1017

**$t_{\min}$ ,  $t_{\max}$** 

Real-valued expressions (possibly in the animation parameter)

**a**

Animation parameter, specified as  $a = a_{\min}..a_{\max}$ , where  $a_{\min}$  is the initial parameter value, and  $a_{\max}$  is the final parameter value.

## See Also

### MuPAD Functions

plot | plot::copy

### MuPAD Graphical Primitives

plot::Curve2d | plot::Function2d | plot::Function3d | plot::Polygon2d |  
plot::Polygon3d | plot::Surface

## plot::Cylinder

Cylinders

### Syntax

```
plot::Cylinder(r, [x1, y1, z1], [x2, y2, z2], <a = amin .. amax>, options)
```

### Description

`plot::Cylinder(r, [x1, y1, z1], [x2, y2, z2])` creates a cylinder of radius  $r$  with an axis from the point  $[x_1, y_1, z_1]$  to the point  $[x_2, y_2, z_2]$ .

The base center and top center of the cylinder can also be passed as vectors.

A cylinder created by `plot::Cylinder` consists of the lateral surface and the “lids” (discs with centers  $[x_1, y_1, z_1]$  and  $[x_2, y_2, z_2]$ , respectively.)

### Attributes

Attribute	Purpose	Default Value
AffectViewingBox	influence of objects on the ViewingBox of a scene	TRUE
Base	base center of cones, cylinders, pyramids and prisms	[0, 0, 0]
BaseX	x-coordinate of top center of cones, cylinders, pyramids and prisms	0
BaseY	y-coordinate of top center of cones, cylinders, pyramids and prisms	0



Attribute	Purpose	Default Value
BaseZ	z-coordinate of top center of cones, cylinders, pyramids and prisms	0
Filled	filled or transparent areas and surfaces	TRUE
FillColor	color of areas and surfaces	RGB::LightBlue
Frames	the number of frames in an animation	50
Legend	makes a legend entry	
LegendText	short explanatory text for legend	
LegendEntry	add this object to the legend?	FALSE
LineColor	color of lines	RGB::Black.[0.25]
LineWidth	width of lines	0.35
LineStyle	solid, dashed or dotted lines?	Solid
LinesVisible	visibility of lines	TRUE
Name	the name of a plot object (for browser and legend)	
ParameterEnd	end value of the animation parameter	
ParameterName	name of the animation parameter	
ParameterBegin	initial value of the animation parameter	
ParameterRange	range of the animation parameter	
Radius	radius of circles, spheres etc.	1
TimeEnd	end time of the animation	10.0

<b>Attribute</b>	<b>Purpose</b>	<b>Default Value</b>
TimeBegin	start time of the animation	0.0
TimeRange	the real time span of an animation	0.0 .. 10.0
Title	object title	
TitleFont	font of object titles	[" sans-serif ", 11]
TitlePosition	position of object titles	
TitleAlignment	horizontal alignment of titles w.r.t. their coordinates	Center
TitlePositionX	position of object titles, x component	
TitlePositionY	position of object titles, y component	
TitlePositionZ	position of object titles, z component	
Top	top center of cones, cylinders, pyramids and prisms	[0, 0, 1]
TopX	base and top center of cones, cylinders, pyramids and prisms	0
TopY	base and top center of cones, cylinders, pyramids and prisms	0
TopZ	base and top center of cones, cylinders, pyramids and prisms	1
Visible	visibility	TRUE
VisibleAfter	object visible after this time value	
VisibleBefore	object visible until this time value	

Attribute	Purpose	Default Value
VisibleFromTo	object visible during this time range	
VisibleAfterEnd	object visible after its animation time ended?	TRUE
VisibleBeforeBegin	object visible before its animation time starts?	TRUE

## Examples

### Example 1

We plot three cylinders with symmetry axes given by the coordinate axes:

```
plot(plot::Cylinder(1, [-3, 0, 0], [3, 0, 0],  
                  Color = RGB::Red),  
      plot::Cylinder(1, [0, -4, 0], [0, 4, 0],  
                  Color = RGB::Green),  
      plot::Cylinder(1, [0, 0, -5], [0, 0, 5],  
                  Color = RGB::Blue)):
```

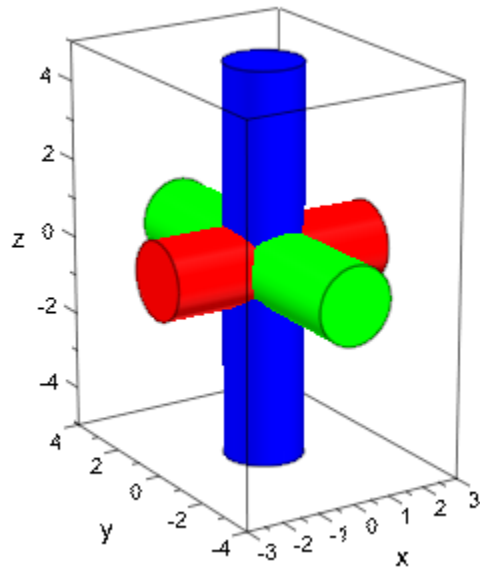

## Example 2

All parameters of a cylinder can be animated:

```
plot(plot::Cylinder(a, [0, 0, a], [0, 0, 3 - a],  
a = 1 .. 2))
```

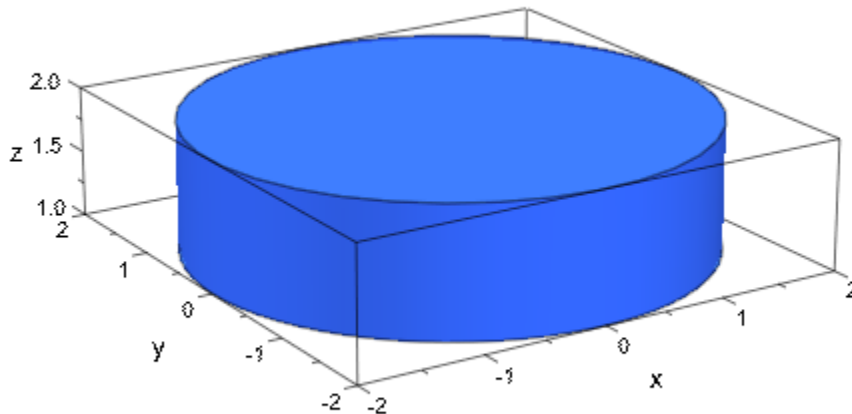

## Parameters

**r**

The radius of the cylinder: a real numerical value or an arithmetical expression (Symbolic Math Toolbox) of the animation parameter  $a$ .

$r$  is equivalent to the attribute `Radius`.

**$x_1, y_1, z_1$**

Components of the base center: real numerical values or expressions of the animation parameter  $a$ .

$x_1, y_1, z_1$  are equivalent to the attributes `BaseX`, `BaseY`, `BaseZ`.

**$x_2, y_2, z_2$**

Components of the top center: real numerical values or expressions of the animation parameter  $a$ .

$x_2, y_2, z_2$  are equivalent to the attributes TopX, TopY, TopZ.

**a**

Animation parameter, specified as  $a = a_{\min} \dots a_{\max}$ , where  $a_{\min}$  is the initial parameter value, and  $a_{\max}$  is the final parameter value.

## See Also

### **MuPAD Functions**

`plot` | `plot::copy`

### **MuPAD Graphical Primitives**

`plot::Cone` | `plot::Prism` | `plot::Pyramid`

# plot::Cylindrical

Surfaces in 3D parameterized in cylindrical coordinates

## Syntax

```
plot::Cylindrical([r,  $\phi$ , z], u = umin .. umax, v = vmin .. vmax, <a = amin .. amax>, options)
```

## Description

plot::Cylindrical creates surfaces parametrized in cylindrical coordinates.

The surface given by a mapping (“parametrization”)  $(u, v) \rightarrow (r(u, v), \phi(u, v), z(u, v))$  is the set of all image points

$$\left\{ \begin{pmatrix} r(u, v) \\ \phi(u, v) \\ z(u, v) \end{pmatrix} \mid u \in [u_{\min}, u_{\max}], v \in [v_{\min}, v_{\max}] \right\}$$

in cylindrical coordinates, which translate to the usual “Cartesian” coordinates as

$$\begin{aligned} x &= r \cos(\phi) \\ y &= r \sin(\phi) \\ z &= z \end{aligned}$$

$r$  is referred to as “radius,”  $\phi$  as “polar angle,” and  $z$  as the “height” of a point.

The functions  $r$ ,  $\phi$ ,  $z$  are evaluated on a regular equidistant mesh of sample points in the  $u$ - $v$  plane. This mesh is determined by the attributes `UMesh`, `VMesh`. By default, the attribute `AdaptiveMesh = 0` is set, i.e., no adaptive refinement of the equidistant mesh is used.

If the standard mesh does not suffice to produce a sufficiently detailed plot, one may either increase the value of `UMesh`, `VMesh` or `USubmesh`, `VSubmesh`, or set

`AdaptiveMesh = n` with some (small) positive integer  $n$ . If necessary, up to  $2^n - 1$  additional points are placed in each direction of the  $u$ - $v$  plane between adjacent points of the initial equidistant mesh. Cf. “Example 2” on page 24-255 (Symbolic Math Toolbox).

“Coordinate lines” (“parameter lines”) are curves on the surface.

The phrase “`ULines`” refers to the curves  $(r(u, v_0), \phi(u, v_0), z(u, v_0))$  with the parameter  $u$  running from  $u_{\min}$  to  $u_{\max}$ , while  $v_0$  is some fixed value from the interval  $[v_{\min}, v_{\max}]$ .

The phrase “`VLines`” refers to the curves  $(r(u_0, v), \phi(u_0, v), z(u_0, v))$  with the parameter  $v$  running from  $v_{\min}$  to  $v_{\max}$ , while  $u_0$  is some fixed value from the interval  $[u_{\min}, u_{\max}]$ .

By default, the parameter curves are visible. They may be switched off by specifying `ULinesVisible = FALSE` and `VLinesVisible = FALSE`, respectively.

The coordinate lines controlled by `ULinesVisible = TRUE/FALSE` and `VLinesVisible = TRUE/FALSE` indicate the equidistant mesh in the  $u$ - $v$  plane set via the `UMesh`, `VMesh` attributes. If the mesh is refined by the `USubmesh`, `VSubmesh` attributes, or by the adaptive mechanism controlled by `AdaptiveMesh = n`, no additional parameter lines are drawn.

As far as the numerical approximation of the surface is concerned, the settings

`UMesh =  $n_u$` , `VMesh =  $n_v$` , `USubmesh =  $m_u$` , `VSubmesh =  $m_v$`

and

`UMesh =  $(n_u - 1) (m_u + 1) + 1$` , `VMesh =  $(n_v - 1) (m_v + 1) + 1$` ,

`USubmesh = 0`, `VSubmesh = 0`

are equivalent. However, in the first setting,  $n_u$  parameter lines are visible in the  $u$  direction, while in the latter setting  $(n_u - 1) (m_u + 1) + 1$  parameter lines are visible. Cf. “Example 2” on page 24-255 (Symbolic Math Toolbox).

Use `Filled = FALSE` to obtain a wireframe representation of the surface.

If the expressions/functions  $r$  and/or  $z$  contain singularities, it is recommended (but not strictly necessary) to use the attribute `ViewingBox` to set a suitable viewing box. No such precautions are necessary for  $\phi$ , although singularities in this function may result in poorly rendered surfaces - in many cases setting the attributes `Mesh` and/or `AdaptiveMesh` to higher values will help. Cf. “Example 3” on page 24-259 (Symbolic Math Toolbox).



## Attributes

Attribute	Purpose	Default Value
AdaptiveMesh	adaptive sampling	0
AffectViewingBox	influence of objects on the ViewingBox of a scene	TRUE
Color	the main color	RGB::Red
Filled	filled or transparent areas and surfaces	TRUE
FillColor	color of areas and surfaces	RGB::Red
FillColor2	second color of areas and surfaces for color blends	RGB::CornflowerBlue
FillColorType	surface filling types	Dichromatic
FillColorFunction	functional area/surface coloring	
FillColorDirection	the direction of color transitions on surfaces	[0, 0, 1]
FillColorDirectionX	x-component of the direction of color transitions on surfaces	0
FillColorDirectionY	y-component of the direction of color transitions on surfaces	0
FillColorDirectionZ	z-component of the direction of color transitions on surfaces	1
Frames	the number of frames in an animation	50
Legend	makes a legend entry	
LegendText	short explanatory text for legend	
LegendEntry	add this object to the legend?	TRUE

<b>Attribute</b>	<b>Purpose</b>	<b>Default Value</b>
LineColor	color of lines	RGB::Black.[0.25]
LineWidth	width of lines	0.35
LineColor2	color of lines	RGB::DeepPink
LineStyle	solid, dashed or dotted lines?	Solid
LineColorType	line coloring types	Flat
LineColorFunction	functional line coloring	
LineColorDirection	the direction of color transitions on lines	[0, 0, 1]
LineColorDirectionX	x-component of the direction of color transitions on lines	0
LineColorDirectionY	y-component of the direction of color transitions on lines	0
LineColorDirectionZ	z-component of the direction of color transitions on lines	1
Mesh	number of sample points	[25, 25]
MeshVisible	visibility of irregular mesh lines in 3D	FALSE
Name	the name of a plot object (for browser and legend)	
ParameterEnd	end value of the animation parameter	
ParameterName	name of the animation parameter	
ParameterBegin	initial value of the animation parameter	
ParameterRange	range of the animation parameter	
PointSize	the size of points	1.5
PointStyle	the presentation style of points	FilledCircles

Attribute	Purpose	Default Value
PointsVisible	visibility of mesh points	FALSE
Submesh	density of submesh (additional sample points)	[0, 0]
TimeEnd	end time of the animation	10.0
TimeBegin	start time of the animation	0.0
TimeRange	the real time span of an animation	0.0 .. 10.0
Title	object title	
TitleFont	font of object titles	[" sans-serif ", 11]
TitlePosition	position of object titles	
TitleAlignment	horizontal alignment of titles w.r.t. their coordinates	Center
TitlePositionX	position of object titles, x component	
TitlePositionY	position of object titles, y component	
TitlePositionZ	position of object titles, z component	
ULinesVisible	visibility of parameter lines (u lines)	TRUE
UMax	final value of parameter "u"	
UMesh	number of sample points for parameter "u"	25
UMin	initial value of parameter "u"	
UName	name of parameter "u"	
URange	range of parameter "u"	
USubmesh	density of additional sample points for parameter "u"	0
VLinesVisible	visibility of parameter lines (v lines)	TRUE

<b>Attribute</b>	<b>Purpose</b>	<b>Default Value</b>
VMax	final value of parameter "v"	
VMesh	number of sample points for parameter "v"	25
VMin	initial value of parameter "v"	
VName	name of parameter "v"	
VRange	range of parameter "v"	
VSubmesh	density of additional sample points for parameter "v"	0
Visible	visibility	TRUE
VisibleAfter	object visible after this time value	
VisibleBefore	object visible until this time value	
VisibleFromTo	object visible during this time range	
VisibleAfterEnd	object visible after its animation time ended?	TRUE
VisibleBeforeBegin	object visible before its animation time starts?	TRUE
XContours	contour lines at constant x values	[]
XFunction	function for x values	
YContours	contour lines at constant y values	[]
YFunction	function for y values	
ZContours	contour lines at constant z values	[]
ZFunction	function for z values	

## Examples

### Example 1

Using a constant radius for `plot::Cylindrical`, with the other two functions straight from the surface parameters, results in a right cylinder. This explains the name "cylindrical coordinates":

```
plot(plot::Cylindrical([1, phi, z], phi = 0..2*PI, z = -1..1))
```

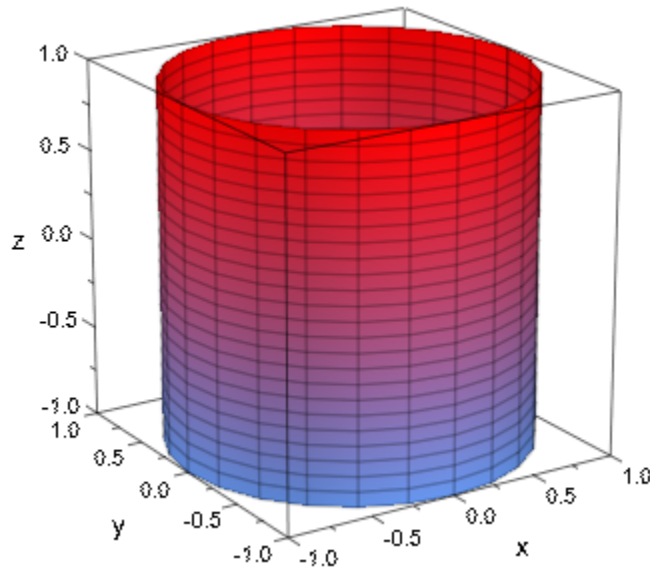

Other straightforward examples include cones and paraboloids of revolution:

```
plot(plot::Cylindrical([r, phi, 2*r], r = 0..1, phi = 0..2*PI))
```

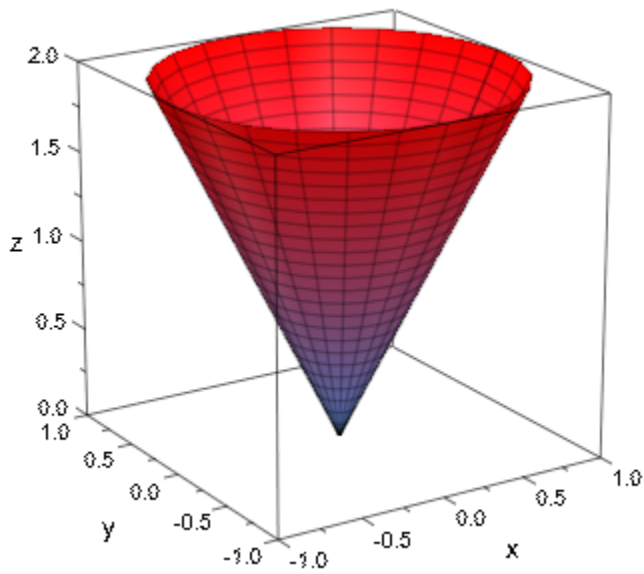

```
plot(plot::Cylindrical([r, phi, r^2], r = 0..1, phi = 0..2*PI))
```

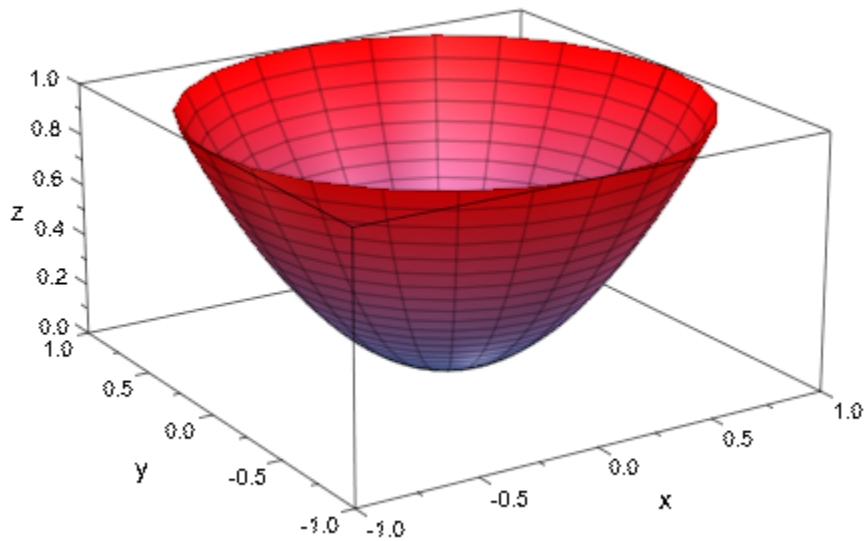

## Example 2

Cylindrical surfaces are drawn from evaluations on an equidistant mesh of points. In some cases, the default mesh density is insufficient or otherwise inappropriate:

```
plot(plot::Cylindrical([cos(phi^2), phi, z],  
                      phi=-2.8..2.8, z=0..1/2))
```

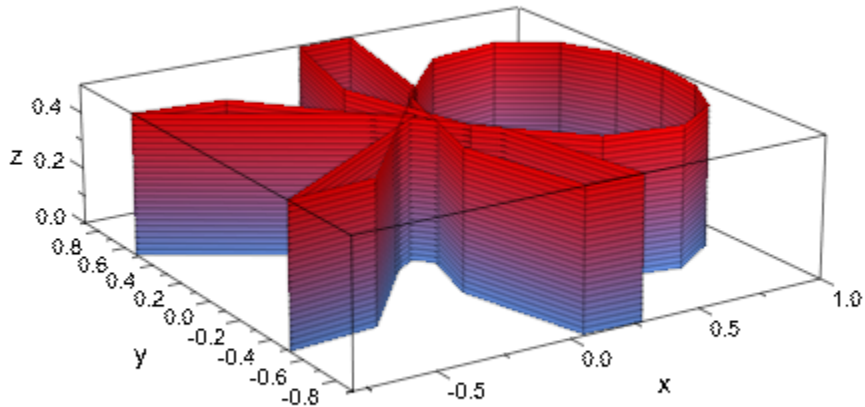

One possible change to this plot command is to explicitly set the mesh with the attribute `Mesh`. Note that this setting influences the density of parameter lines:

```
plot(plot::Cylindrical([cos(phi^2), phi, z],  
                      phi=-2.8..2.8, z=0..1/2,  
                      Mesh = [100, 5]))
```



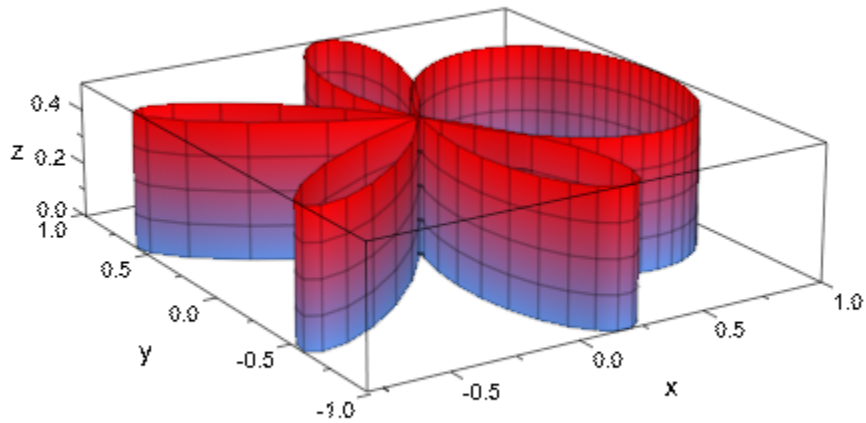

To increase the mesh density without introducing additional parameter lines, you can use submesh on page 24-1704 settings:

```
plot(plot::Cylindrical([cos(phi^2), phi, z],  
    phi=-2.8..2.8, z=0..1/2,  
    VMesh = 5, USubmesh = 3))
```

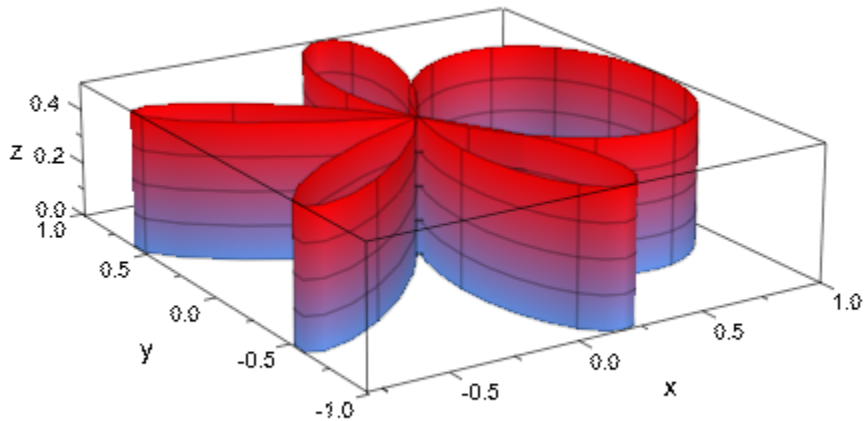

Finally, we can also ask `plot::Cylindrical` to refine the mesh only in areas of higher curvature. In the following example, we allow for  $2^3 = 8$  additional points between each two neighboring points of the initial mesh:

```
plot(plot::Cylindrical([cos(phi^2), phi, z],  
                      phi=-2.8..2.8, z=0..1/2,  
                      VMesh = 5, AdaptiveMesh = 3))
```

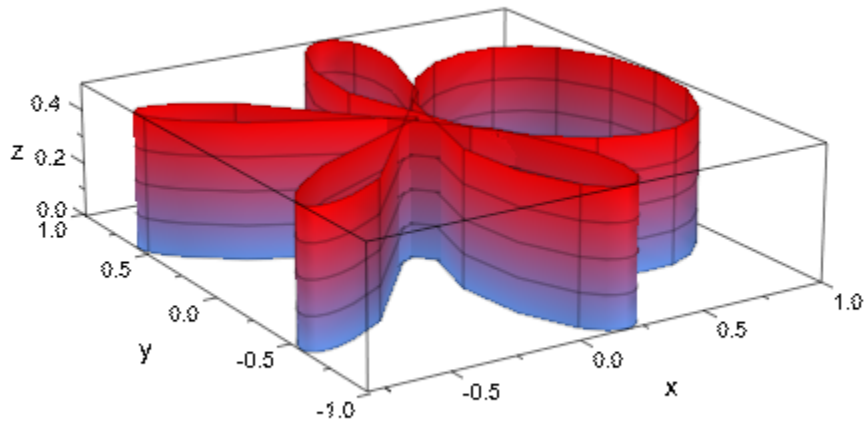

### Example 3

If the radius- or the z-function/expression contains singularities, `plot::Cylindrical` employs heuristic clipping to select a range to display:

```
plot(plot::Cylindrical([1/sqrt((phi - PI)^2 + z^2), phi, z],  
phi = 0..2*PI, z = -1..1))
```

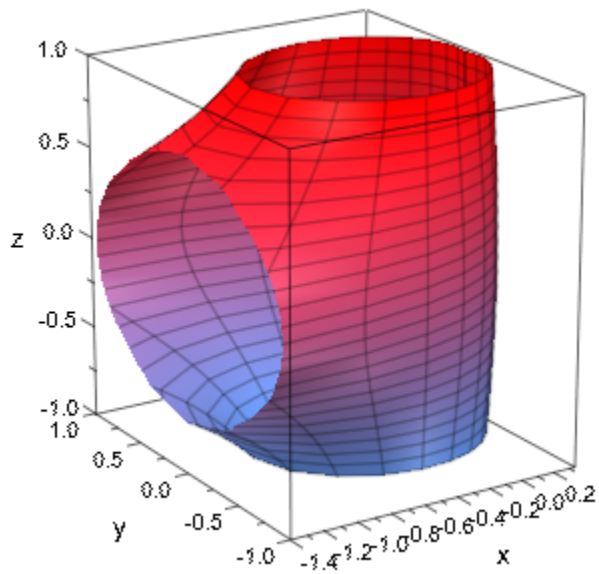

While these heuristics work well in many cases, there are also examples where they do not select a useful box:

```
plot(plot::Cylindrical([1/((phi - PI)^2 + z^2), phi, z],  
  phi = 0.. 2*PI, z = -1..1))
```

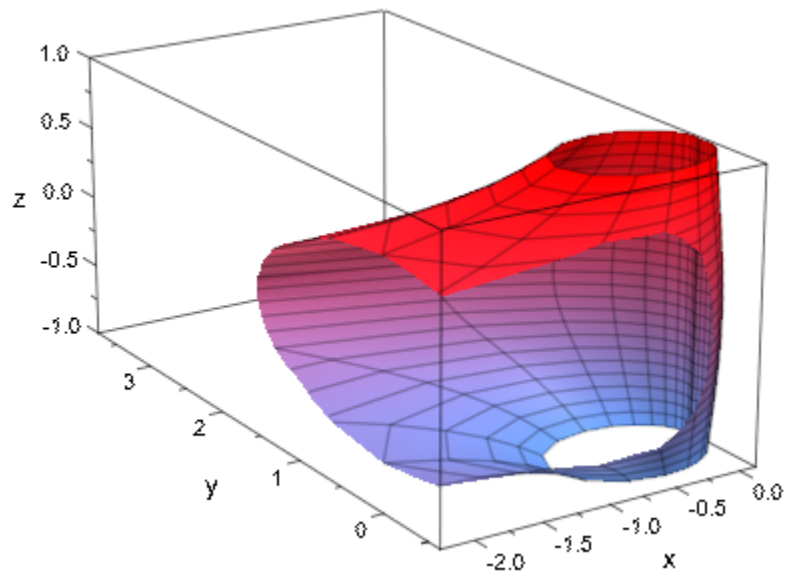

In these cases, the user should set the range to display explicitly:

```
plot(plot::Cylindrical([1/((phi - PI)^2+z^2), phi, z],  
                      phi = 0..2*PI, z = -1..1),  
      ViewingBox = [-2..0.3, -1.5..1.5, -1..1])
```

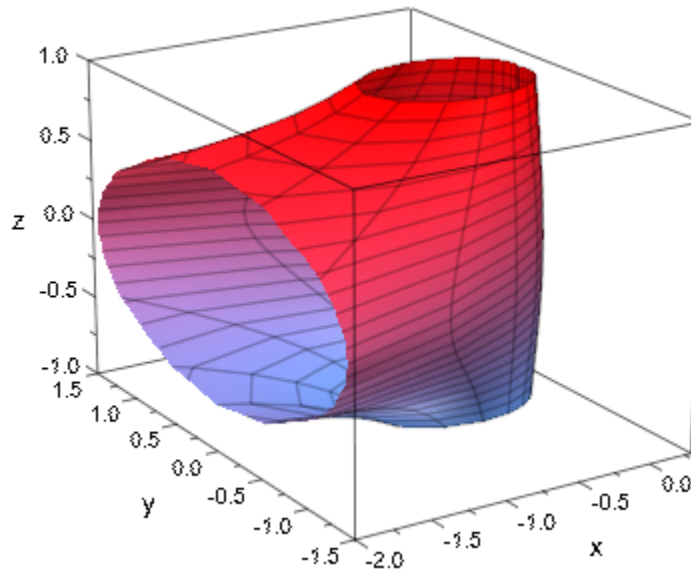

### Example 4

Since the transformation from cylindrical to orthogonal coordinates is reversible (up to reducing the angle to the range  $[0, 2\pi]$ , it is possible to plot any surface with `plot::Cylindrical` (although this is probably more a curiosity than really useful):

```
trans := linalg::ogCoordTab[Cylindrical, InverseTransformation]:
cyl   := trans(x, y, sin(x^2+y^2))
```

$$\left[ \sqrt{x^2 + y^2}, \arccos\left(\frac{x}{\sqrt{x^2 + y^2}}\right) + \text{sign}(y) (\text{sign}(y) - 1) \left(\pi - \arccos\left(\frac{x}{\sqrt{x^2 + y^2}}\right)\right), \sin(x^2 + y^2) \right]$$

```
plot(plot::Cylindrical(cyl, x = -2..2, y = -2..2))
```

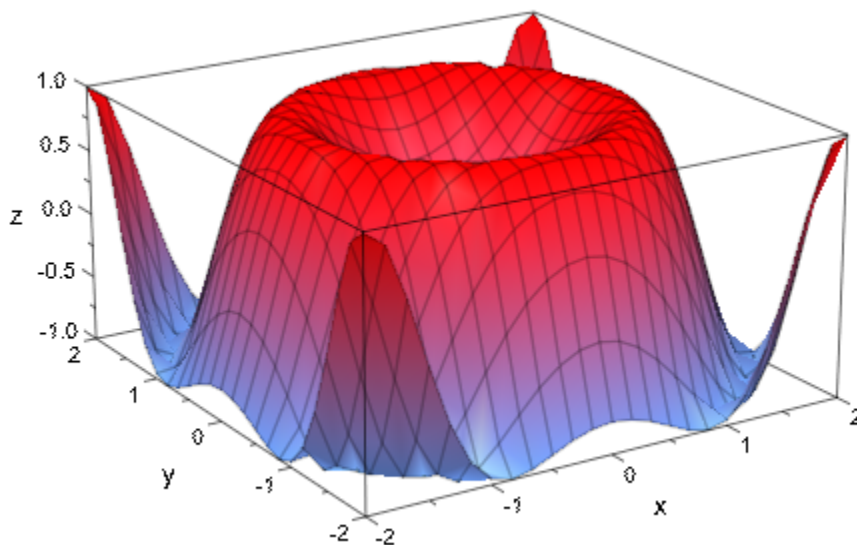

## Parameters

**$r, \phi, z$**

The coordinate functions: arithmetical expressions (Symbolic Math Toolbox) or piecewise objects depending on the surface parameters  $u, v$  and the animation parameter  $a$ . Alternatively, procedures on page 1-1654 that accept 2 input parameters  $u, v$  or 3 input parameters  $u, v, a$  and return a real numerical value when the input parameters are numerical.

$r, \phi, z$  are equivalent to the attributes XFunction, YFunction, ZFunction.

**$u$**

The first surface parameter: an identifier on page 7-29 or an indexed identifier on page 1-1017.

$u$  is equivalent to the attributes UName, UMin, UMax.

**$u_{\min} \dots u_{\max}$**

The plot range for the parameter  $u$ :  $u_{\min}$ ,  $u_{\max}$  must be numerical real values or expressions of the animation parameter  $a$ .

$u_{\min} \dots u_{\max}$  is equivalent to the attributes `URange`, `UMin`, `UMax`.

**$v$**

The second surface parameter: an identifier on page 7-29 or an indexed identifier on page 1-1017.

$v$  is equivalent to the attribute `VName`.

**$v_{\min} \dots v_{\max}$**

The plot range for the parameter  $v$ :  $v_{\min}$ ,  $v_{\max}$  must be numerical real values or expressions of the animation parameter  $a$ .

$v_{\min} \dots v_{\max}$  is equivalent to the attributes `VRange`, `VMin`, `VMax`.

**$a$**

Animation parameter, specified as  $a = a_{\min} \dots a_{\max}$ , where  $a_{\min}$  is the initial parameter value, and  $a_{\max}$  is the final parameter value.

## See Also

### MuPAD Functions

`linalg::ogCoordTab` | `plot` | `plot::copy`

### MuPAD Graphical Primitives

`plot::Polar` | `plot::Spherical` | `plot::Tube`



# plot::Density

Density plot

## Syntax

```
plot::Density(f, x = x_min .. x_max, y = y_min .. y_max, <a = a_min .. a_max>, options)
```

```
plot::Density(A, <x = x_min .. x_max, y = y_min .. y_max>, <a = a_min .. a_max>, options)
```

```
plot::Density(L, <x = x_min .. x_max, y = y_min .. y_max>, <a = a_min .. a_max>, options)
```

## Description

`plot::Density(f(x, y), x = `x_{min}` .. `x_{max}` , y = `y_{min}` .. `y_{max}` )` generates a regular 2D mesh of rectangles extending from the lower left corner ( $x_{\min}, y_{\min}$ ) to the upper right corner ( $x_{\max}, y_{\max}$ ). The rectangle with midpoint  $(x, y)$  is colored according to a color scheme based on the “density” value  $f(x, y)$ .

`plot::Density` serves for the visualization of 3D data  $(x, y, f(x, y))$  by a 2D plot. Roughly speaking, it corresponds to a colored 3D function graph of the density function  $f(x, y)$  viewed from above. However, in contrast to the 3D function graph, `plot::Density` does not use smooth interpolation (“shading”) of the color between adjacent rectangles.

If the density data are provided by an array or matrix `A` or by a list `L`, the number of rectangles in the density plot is given automatically by the format of `A` or `L`, respectively.

If the density data are given by an expression or function `f`, the attribute `Mesh = [m, n]` serves for advising `plot::Density` to create a grid of  $m \times n$  rectangles. Alternatively, one may set `XMesh = m, YMesh = n`.

With the default `FillColorType = Dichromatic`, the rectangle with density value  $f(x, y)$  at the midpoint  $(x, y)$  is colored with the color

$$\frac{f(x, y) - f_{\min}}{f_{\max} - f_{\min}} \times \text{fillcolor} + \frac{f_{\max} - f(x, y)}{f_{\max} - f_{\min}} \times \text{fillcolor2}$$

where  $f_{\min}$  and  $f_{\max}$  are the minimal/maximal density values in the graphics and `fillcolor`, `fillcolor2` are the RGB values of the attributes `FillColor` and `FillColor2`, respectively. Thus, `fillcolor` indicates high density values whereas `fillcolor2` indicates low density values.

If  $f_{\min} = f_{\max}$ , a flat coloring with `fillcolor` is used.

With `FillColorType = Monochrome`, the rectangle with density value  $f(x, y)$  at the midpoint  $(x, y)$  is colored with the color

$$\frac{f(x, y) - f_{\min}}{f_{\max} - f_{\min}} \times \text{fillcolor}$$

The user may specify a fill color function via `FillColorFunction = mycolorfunction` to override the density coloring described above. The procedure `mycolorfunction` will be called with the arguments

`mycolorfunction(x, y, f(x, y, a) a)`,

where  $(x, y)$  are the midpoints of the rectangles and  $a$  is the animation parameter. The color function must return an RGB or RGBA color value.

When density values are specified by an array or a matrix  $A$ , the low indices correspond to the lower left corner of the graphics. The high indices correspond to the upper right corner.

Arrays/matrices do not need to be indexed from 1. E.g.,

```
A = array( `i_{min}` .. `i_{max}` , `j_{min}` .. `j_{max}` ,
[.density values..])
```

yields a graphical array with

```
XMesh = j_max - j_min + 1, YMesh = i_max - i_min + 1.
```

If no plot range ``x_{min}` .. `x_{max}``, ``y_{min}` .. `y_{max}`` is specified,

```
x_min = j_min - 1, x_max = j_max, y_min = i_min - 1, y_max = i_max
```

is used.

When density values are specified by a list of lists  $L$ , the first entries in the list correspond to the lower left corner of the graphics. The last entries correspond to the upper right corner.

If no plot range ``x_{min}` .. `x_{max}``, ``y_{min}` .. `y_{max}`` is specified,

$$x_{\min} = 0, x_{\max} = m, y_{\min} = 0, y_{\max} = n$$

is used, where  $n$  is the length of  $L$  and  $m$  is the (common) length of the sublists in  $L$ . All sublists (“rows”) must have the same length.

Animations are triggered by specifying a range `a = `a_{min}` .. `a_{max}`` for a parameter  $a$  that is different from the variables  $x, y$ . Thus, in animations, both the ranges `x = `x_{min}` .. `x_{max}``, `y = `y_{min}` .. `y_{max}`` as well as the animation range `a = `a_{min}` .. `a_{max}`` must be specified.

The related plot routine `plot::Raster` provides a similar functionality. However, `plot::Raster` does not use an automatic color scheme based on density values. The user must provide RGB or RGBA values instead.

## Attributes

Attribute	Purpose	Default Value
AffectViewingBox	influence of objects on the ViewingBox of a scene	TRUE
AntiAliased	antialiased lines and points?	FALSE
Color	the main color	RGB::Red
DensityData	density values for a density plot	
DensityFunction	density function for a density plot	
FillColor	color of areas and surfaces	RGB::Red
FillColor2	second color of areas and surfaces for color blends	RGB::CornflowerBlue
FillColorType	surface filling types	Dichromatic

<b>Attribute</b>	<b>Purpose</b>	<b>Default Value</b>
FillColorFunction	functional area/surface coloring	
Frames	the number of frames in an animation	50
Legend	makes a legend entry	
LegendText	short explanatory text for legend	
LegendEntry	add this object to the legend?	FALSE
LineColor	color of lines	RGB::Blue
LineWidth	width of lines	0.35
LineStyle	solid, dashed or dotted lines?	Solid
LinesVisible	visibility of lines	FALSE
Mesh	number of sample points	[25, 25]
Name	the name of a plot object (for browser and legend)	
ParameterEnd	end value of the animation parameter	
ParameterName	name of the animation parameter	
ParameterBegin	initial value of the animation parameter	
ParameterRange	range of the animation parameter	
TimeEnd	end time of the animation	10.0
TimeBegin	start time of the animation	0.0
TimeRange	the real time span of an animation	0.0 .. 10.0
Title	object title	
TitleFont	font of object titles	[" sans-serif ", 11]

Attribute	Purpose	Default Value
TitlePosition	position of object titles	
TitleAlignment	horizontal alignment of titles w.r.t. their coordinates	Center
TitlePositionX	position of object titles, x component	
TitlePositionY	position of object titles, y component	
Visible	visibility	TRUE
VisibleAfter	object visible after this time value	
VisibleBefore	object visible until this time value	
VisibleFromTo	object visible during this time range	
VisibleAfterEnd	object visible after its animation time ended?	TRUE
VisibleBeforeBegin	object visible before its animation time starts?	TRUE
XMax	final value of parameter "x"	
XMesh	number of sample points for parameter "x"	25
XMin	initial value of parameter "x"	
XName	name of parameter "x"	
XRange	range of parameter "x"	
YMax	final value of parameter "y"	
YMesh	number of sample points for parameter "y"	25
YMin	initial value of parameter "y"	
YName	name of parameter "y"	

Attribute	Purpose	Default Value
YRange	range of parameter "y"	

## Examples

### Example 1

We generate a density plot:

```
p := plot::Density(cos(x^2 + y^2), x = -3..3, y = -2..2,  
                  Mesh = [60, 40]):
```

The plot object is rendered:

```
plot(p, Axes = Frame):
```

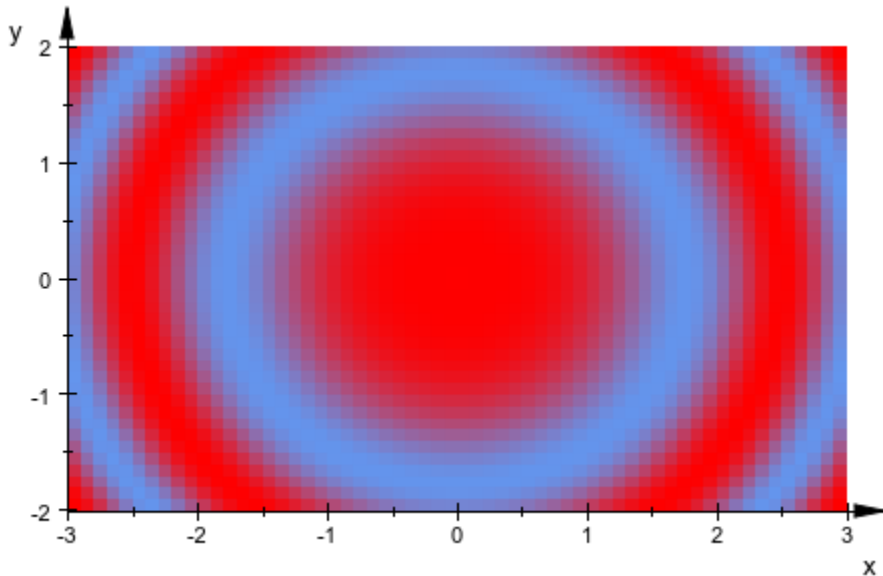

This turns into a black and white graphics when suitable colors are specified:

```
plot(plot::Scene2d(p, FillColor = RGB::White,  
                  FillColor2 = RGB::Black),
```

```

plot::Scene2d(p, FillColor = RGB::Black,
              FillColor2 = RGB::White),
Width = 120*unit::mm, Height = 45*unit::mm,
Layout = Horizontal, Axes = Frame):

```

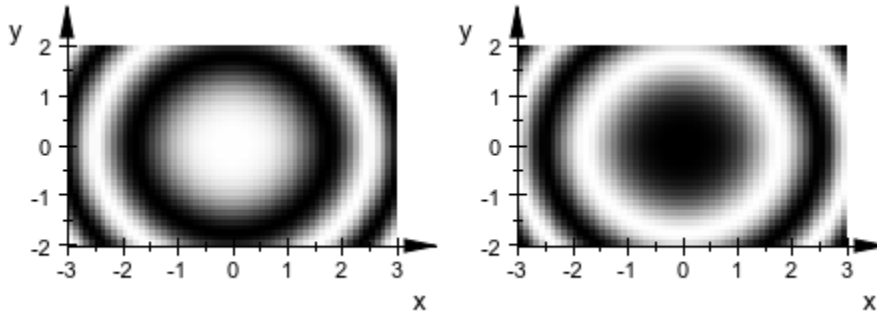

```
delete p:
```

## Example 2

We demonstrate the use of a user-defined color function:

```

mycolor := proc(x, y, f)
begin
  if f >= 2/3 then RGB::Red;
  elif f >= 1/3 then RGB::Orange;
  elif f >= 0 then RGB::Yellow;
  elif f >= -1/3 then RGB::BlueLight;
  elif f >= -2/3 then RGB::Blue;
  else RGB::SlateBlueDark;
  end_if;
end_proc;
plot(plot::Density(cos(x^2 + y^2), x = -3..3, y = -2..2,
                  Mesh = [60, 40],
                  FillColorFunction = mycolor),
      Axes = Frame):

```

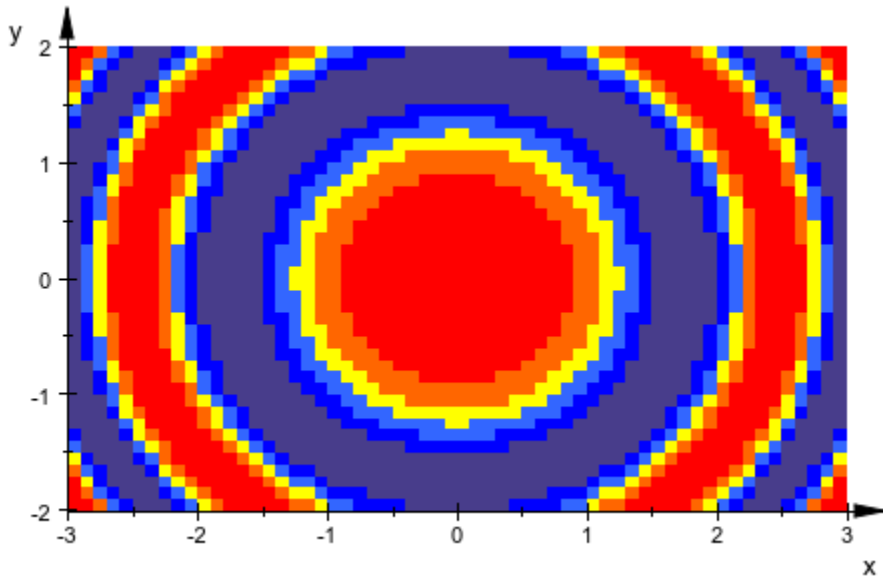

`delete mycolor:`

### Example 3

In this example, we demonstrate how `plot::Density` can be used to plot gray data from an external source. Assume, there is an external PortableGrayMap text file `Norton.pgm` containing data such as

```
P2
240 180
255
249 237 228 231 245 218 229 195 ...
```

The first line contains the “magic value” P2 indicating that this is a PGM text file. The second line contains the pixel width and pixel height of the picture. The number 255 in the third line is the scale of the following gray values.

The remaining data consist of integers between 0 (black) and 255 (white), each representing the gray value of a pixel (row by row).



We import the text data via `import::readdata`:

```
graydata := import::readdata("Norton.pgm", NonNested):
```

This is a long list of all data items in the file. We extract the 4 items in the first three lines:

```
[magicvalue, xmesh, ymesh, maxgray] := graydata[1..4]
```

[P2, 240, 180, 255]

We delete the header from the pixel data. (If there are comments in the PGM file, they must be deleted, too).

```
for i from 1 to 4 do
  delete graydata[1];
end_for:
```

We transform the plain data list to a nested list containing the gray data of the rows as sublists. (The call to `level` is not really necessary, but it speeds up the conversion considerably on the interactive level.)

```
L := level([graydata[(i - 1)*xmesh + 1 .. i*xmesh] $ i=1..ymesh], 1):
```

This list can be passed to `plot::Density`:

```
plot(plot::Density(L, FillColor = RGB::White,
  FillColor2 = RGB::Black),
  Width = 80*unit::mm, Height = 60*unit::mm):
```

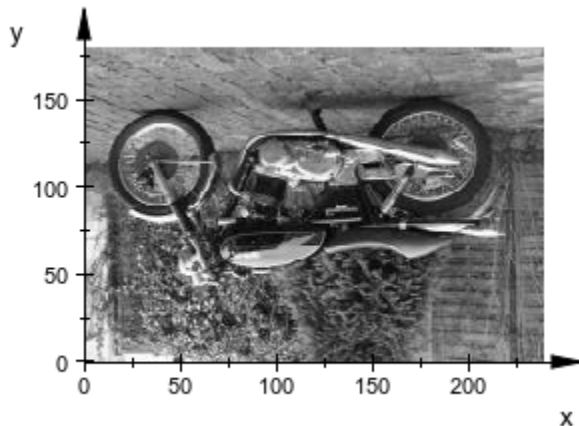

The image is upside down, because the PGM files stores the pixel data row by row in the usual reading order starting with the upper left corner of the image. The MuPAD routine `plot::Density`, however, follows the mathematical orientation of the coordinate axes, i.e., the first pixel value is interpreted as the lower left corner of the image. We have to re-order the rows in the `graydata` list via `revert`:

```
plot(plot::Density(revert(L), FillColor = RGB::White,
                  FillColor2= RGB::Black),
      Width = 80*unit::mm, Height = 60*unit::mm):
```

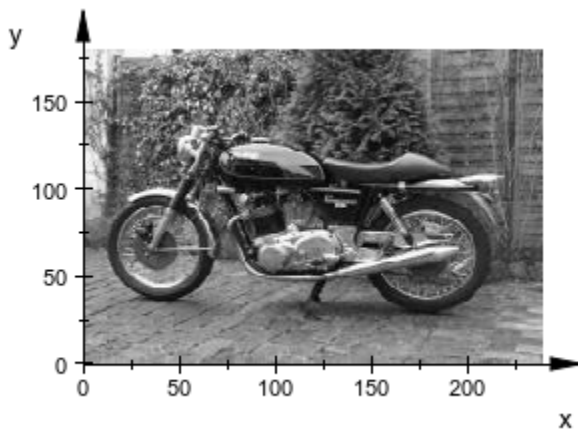

The routines `import::readbitmap` and `plot::Raster` provide an alternative way to import and display the bitmap image. See the help page of `plot::Raster` on page 24-679 for examples. This, however, takes more memory, because the bitmap data are imported as RGB color values, whereas only density values (gray data) are needed for `plot::Density`.

```
delete graydata, magicvalue, xmesh, ymesh, maxgray, i, L:
```

## Example 4

The Mandelbrot set is one of the best-known fractals. It arises when considering the iteration  $z_{n+1} = z_n^2 + c$ ,  $z_0 = 0$  in the complex plane. For sufficiently large values  $|c|$  of the complex parameter  $c$ , the sequence  $z_n$  diverges to infinity; it converges for sufficiently small values of  $|c|$ . The boundary of the region of those  $c$  values that lead to divergence of  $z_n$  is of particular interest: this border is highly complicated and of a fractal nature.

In particular, it is known that the series  $z_n$  diverges to infinity, whenever one of the iterates satisfies  $|z_n| > 2$ . This fact is used by the following procedure `f` as stopping criterion. The return value provides information, how many iterates  $z_0, \dots, z_n$  it takes to escape from the region  $|z| \leq 2$  of (potential) convergence. These data are to be used to color the complex  $c$  plane (i.e., the  $(x,y)$  plane) by a density plot:

```
f := proc(x, y)
local c, z, n;
begin
  c := x + I*y;
  z := 0.0;
  for n from 0 to 100 do
    z := z^2 + c;
    if abs(z) > 2 then
      break;
    end_if;
  end_for;
  if n < 70 then
    n mod 5;
  else n - 70;
  end_if;
end_proc;
```

Depending on your computer, the following computations may take some time. On a very fast machine, you can increase the following values of `xmesh`, `ymesh`. This will use up more computing time but will lead to better graphical results:

```
xmesh := 100: ymesh := 100:
```

The following region in the  $x$ - $y$  plane is to be considered:

```
xmin[1] := -2.0: xmax[1] := 0.5:
ymin[1] := -1.2: ymax[1] := 1.2:
```

The region  $xmin_1 \leq x \leq xmax_1$ ,  $ymin_1 \leq y \leq ymax_1$  is divided into `xmesh``ymesh` rectangles. Each rectangle is colored by a density plot according to the “escape times” computed by the procedure `f`. This procedure can be passed directly to `plot::Density`:

```
p1 := plot::Density(f, x = xmin[1].. xmax[1],
  y = ymin[1] .. ymax[1],
  Mesh = [xmesh, ymesh],
  FillColor = RGB::Black,
  FillColor2 = RGB::Red):
```

In addition, a rectangle is produced that indicates a region that is to be magnified in the following:

```
xmin[2] := -0.24: xmax[2] := -0.01:
ymin[2] := 0.63: ymax[2] := 0.92:
r1 := plot::Rectangle(xmin[2] .. xmax[2], ymin[2] .. ymax[2],
    LineColor = RGB::White):

plot(p1, r1):
```

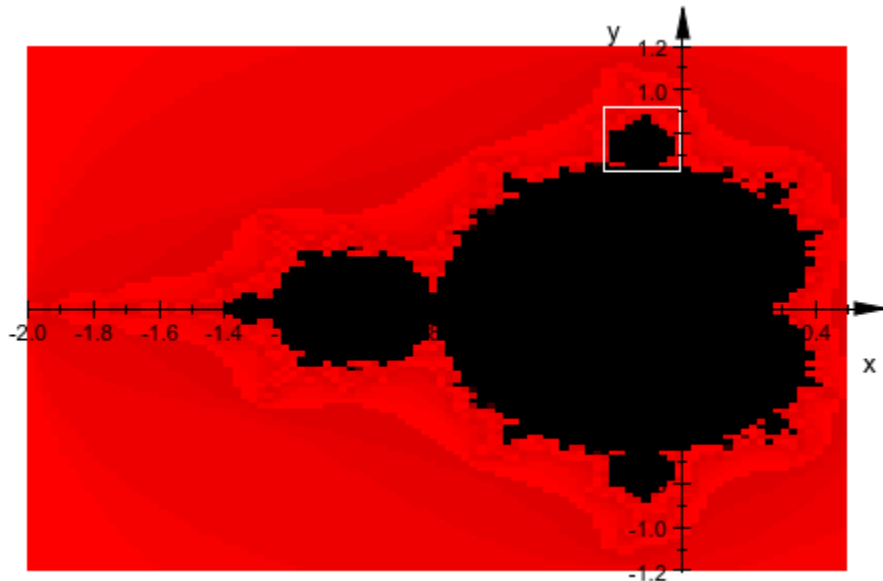

The density values of the blow-up are not computed directly by `plot::Density`. They are computed separately and stored in an array `A`:

```
dx := (xmax[2] - xmin[2])/xmesh:
dy := (ymax[2] - ymin[2])/ymesh:
A := array(1..ymesh, 1..xmesh,
    [[f(xmin[2]+ (j - 1/2)*dx, ymin[2] + (i - 1/2)*dy)
    $ j = 1..xmesh] $ i = 1..ymesh]):
p2 := plot::Density(A, x = xmin[2] .. xmax[2], y = ymin[2] .. ymax[2],
    FillColor = RGB::Black, FillColor2 = RGB::Red):
```

In addition, a further rectangle is produced to indicate a region of interest to be blown up later on:

```

xmin[3] := -0.045: xmax[3] := -0.015:
ymin[3] := 0.773: ymax[3] := 0.815:
r2 := plot::Rectangle(xmin[3] .. xmax[3], ymin[3] .. ymax[3],
    LineColor = RGB::White):

plot(p2, r2):

```

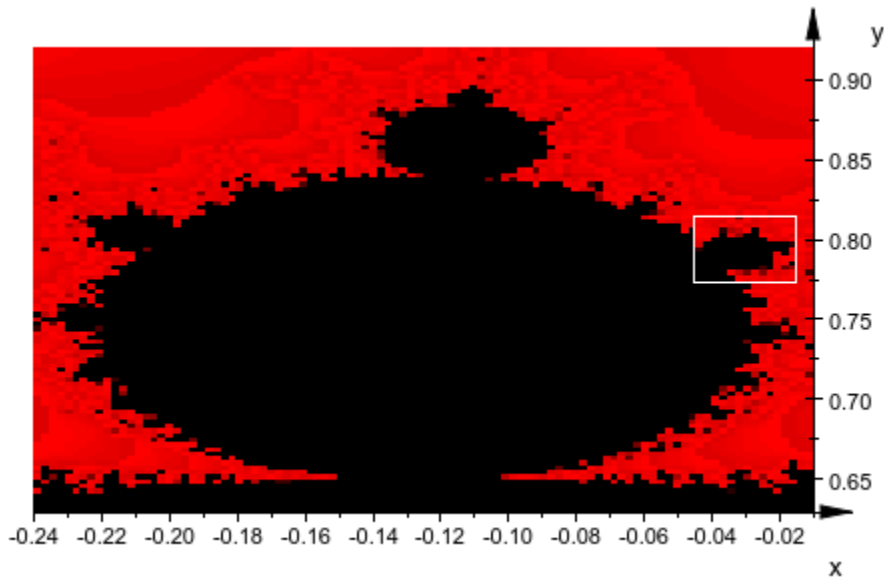

The density values of the next blow-up are again computed separately and stored in a nested list  $L$ :

```

dx := (xmax[3] - xmin[3])/xmesh:
dy := (ymax[3] - ymin[3])/ymesh:
L := [[f(xmin[3] + (j - 1/2)*dx, ymin[3] + (i - 1/2)*dy)
    $ j = 1..xmesh] $ i = 1..ymesh]:
p3 := plot::Density(L, x = xmin[3] .. xmax[3], y = ymin[3] .. ymax[3],
    FillColor = RGB::Black, FillColor2 = RGB::Red):

plot(p3):

```

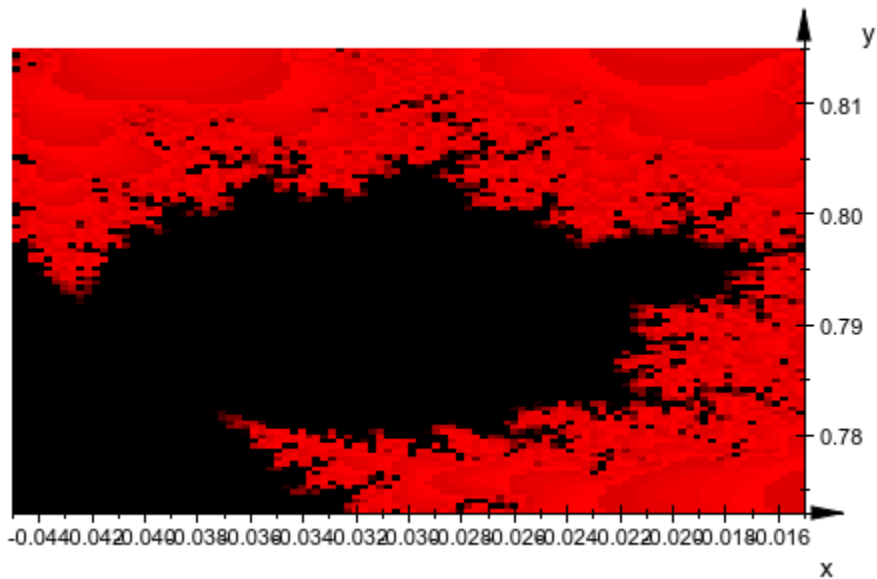

The density objects are to be placed in a single graphics. It consists of the Mandelbrot set `p1` as computed above and of modifications of the density plots `p2` and `p3`. Redefining the attributes `XRange`, `YRange`, we move `p2`, `p3` to places in the  $x$ - $y$  plane where they are not overlapped by `p1`. Note that this does not change the graphical content of `p2`, `p3`, because it is given by the data `A` and `L`, respectively, which remain unchanged. (If the ranges were changed in `p1`, another `plot` call of `p1` would call the procedure `f` at different points of the plane resulting in a different graphics.)

```
p2::XRange := 0.60 .. 1.60: p2::YRange := 0.05 .. 1.15:
p3::XRange := 0.60 .. 1.60: p3::YRange := -1.15 .. -0.05:
```

The Mandelbrot set and the two blow-ups are placed in one scene. In addition, some arrows are added to indicate the origin of the blow-ups. Note that it is quite important here that the arrows are passed to the `plot` command after the density plots. Otherwise, they would be hidden by the density plots: graphical objects are painted in the ordering in which they are passed to `plot`:

```
plot(p1, p2, p3,
      plot::Arrow2d([(xmin[2] + xmax[2])/2,
                    (ymin[2] + ymax[2])/2],
                    [(p2::XMin + p2::XMax)/2,
```

```

        (p2::YMin + p2::YMax)/2],
        LineColor = RGB::Blue),
    plot::Arrow2d([1.50, 0.65],
        [(p3::XMin + p3::XMax)/2,
         (p3::YMin + p3::YMax)/2],
        LineColor = RGB::Blue)
):

```

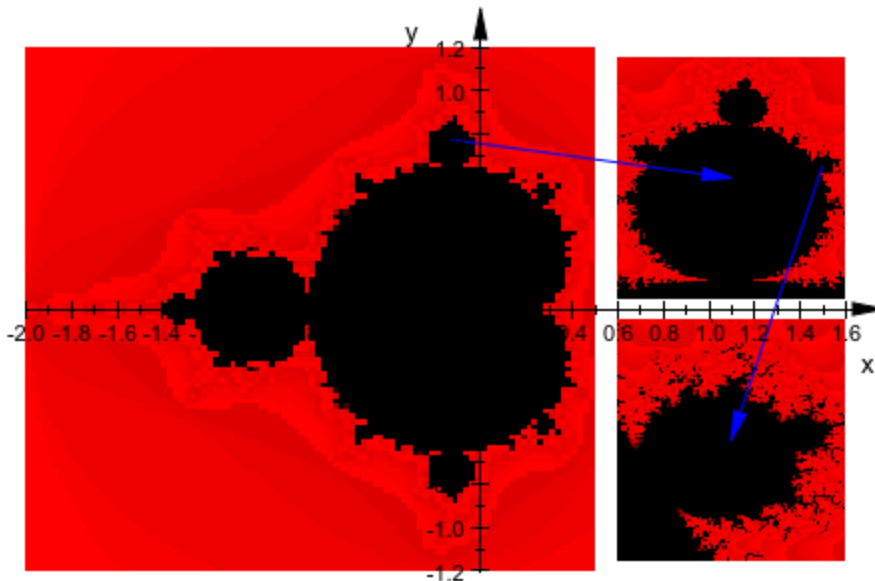

```

delete f, xmesh, ymesh, xmin, xmax, ymin, ymax,
       dx, dy, p1, p2, p3, r1, r2, A, L:

```

## Parameters

**f**

The density values: an arithmetical expression (Symbolic Math Toolbox) in 2 variables  $x$ ,  $y$  and the animation parameter  $a$ . Alternatively, a procedure on page 1-1654 that accepts 2 input parameters  $x$ ,  $y$  or 3 input parameters  $x$ ,  $y$ ,  $a$  and returns a real density value.

$f$  is equivalent to the attribute `DensityFunction`.

**x**

Name of the horizontal variable: an identifier on page 7-29 or an indexed identifier on page 1-1017.

$x$  is equivalent to the attribute `XName`.

 **$x_{\min} \dots x_{\max}$** 

The range of the horizontal variable:  $x_{\min}$ ,  $x_{\max}$  must be numerical real value or expressions of the animation parameter  $a$ .

$x_{\min} \dots x_{\max}$  is equivalent to the attributes `XRange`, `XMin`, `XMax`.

**y**

Name of the vertical variable: an identifier on page 7-29 or an indexed identifier on page 1-1017.

$y$  is equivalent to the attribute `YName`.

 **$y_{\min} \dots y_{\max}$** 

The range of the vertical variable:  $y_{\min}$ ,  $y_{\max}$  must be numerical real value or expressions of the animation parameter  $a$ .

$y_{\min} \dots y_{\max}$  is equivalent to the attributes `YRange`, `YMin`, `YMax`.

**A**

An array of domain type `DOM_ARRAY` or a matrix of category `Cat::Matrix` (e.g., of type `matrix` or `densematrix`) providing numerical density values or expressions of the animation parameter  $a$ . Rows/columns of the array, respectively matrix, correspond to rows/columns of the graphical array.

$A$  is equivalent to the attribute `DensityData`.

**L**

A list of lists of numerical density values or expressions of the animation parameter  $a$ . Each sublist of  $L$  represents a row of the graphical array. The number of sublists in  $L$  yields the value of the attribute `XMesh`. The (common) length of the sublists yields the value of the attribute `YMesh`.



L is equivalent to the attribute `DensityData`.

**a**

Animation parameter, specified as  $a = a_{\min}..a_{\max}$ , where  $a_{\min}$  is the initial parameter value, and  $a_{\max}$  is the final parameter value.

## See Also

### MuPAD Functions

`import::readbitmap` | `plot` | `plot::copy`

### MuPAD Graphical Primitives

`plot::Inequality` | `plot::Raster`

## plot::Ellipse2d

Ellipses in 2D

### Syntax

```
plot::Ellipse2d(r1, r2, <[cx, cy]>, <a = amin .. amax>, options)
```

### Description

`plot::Ellipse2d( r1, r2, [cx, cy] )` creates a 2D ellipse with center point [c<sub>x</sub>, c<sub>y</sub>] and semi-axes of lengths r<sub>1</sub> and r<sub>2</sub> for the horizontal and the vertical axis, respectively.

The symmetry axes of the ellipse are parallel to the coordinate axes. Use `plot::Rotate2d` to create ellipses of different orientation.

If the center point is not specified, an ellipse with center (0, 0) is created.

### Attributes

Attribute	Purpose	Default Value
AffectViewingBox	influence of objects on the ViewingBox of a scene	TRUE
AntiAliased	antialiased lines and points?	TRUE
Center	center of objects, rotation center	[0, 0]
CenterX	center of objects, rotation center, x-component	0
CenterY	center of objects, rotation center, y-component	0
Color	the main color	RGB::Blue

<b>Attribute</b>	<b>Purpose</b>	<b>Default Value</b>
Filled	filled or transparent areas and surfaces	FALSE
FillColor	color of areas and surfaces	RGB::Red
FillPattern	type of area filling	DiagonalLines
Frames	the number of frames in an animation	50
Legend	makes a legend entry	
LegendText	short explanatory text for legend	
LegendEntry	add this object to the legend?	FALSE
LineColor	color of lines	RGB::Blue
LineWidth	width of lines	0.35
LineStyle	solid, dashed or dotted lines?	Solid
LinesVisible	visibility of lines	TRUE
LineColorDirection	the direction of color transitions on lines	[0, 1]
LineColorDirectionX	x-component of the direction of color transitions on lines	0
LineColorDirectionY	y-component of the direction of color transitions on lines	1
Name	the name of a plot object (for browser and legend)	
ParameterEnd	end value of the animation parameter	
ParameterName	name of the animation parameter	
ParameterBegin	initial value of the animation parameter	

<b>Attribute</b>	<b>Purpose</b>	<b>Default Value</b>
ParameterRange	range of the animation parameter	
SemiAxes	semi axes of ellipses and ellipsoids	[2, 1]
SemiAxisX	first semi axis of ellipses and ellipsoids	2
SemiAxisY	second semi axis of ellipses and ellipsoids	1
TimeEnd	end time of the animation	10.0
TimeBegin	start time of the animation	0.0
TimeRange	the real time span of an animation	0.0 .. 10.0
Title	object title	
TitleFont	font of object titles	[" sans-serif ", 11]
TitlePosition	position of object titles	
TitleAlignment	horizontal alignment of titles w.r.t. their coordinates	Center
TitlePositionX	position of object titles, x component	
TitlePositionY	position of object titles, y component	
Visible	visibility	TRUE
VisibleAfter	object visible after this time value	
VisibleBefore	object visible until this time value	
VisibleFromTo	object visible during this time range	
VisibleAfterEnd	object visible after its animation time ended?	TRUE

Attribute	Purpose	Default Value
VisibleBeforeBegin	object visible before its animation time starts?	TRUE

## Examples

### Example 1

Create a plot of an ellipse with center point (1,1) and semi-axes of lengths 3 and 1:

```
ellipse := plot::Ellipse2d(3, 1, [1, 1]):  
plot(ellipse)
```

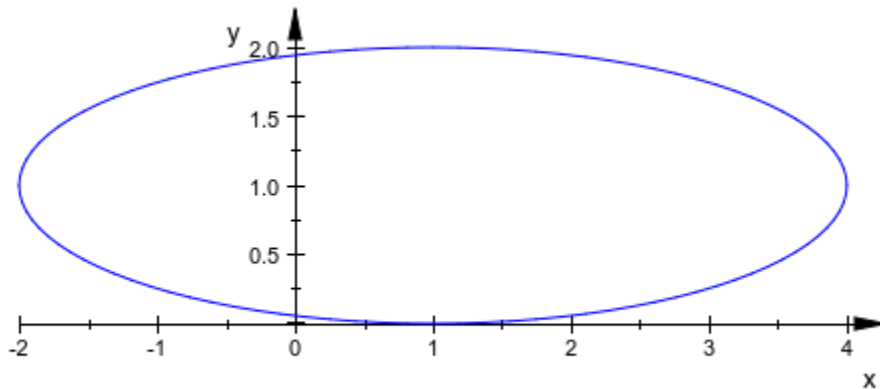

Apply a rotation on page 24-1113:

```
plot(ellipse, plot::Rotate2d(PI/4, [1, 1], ellipse))
```

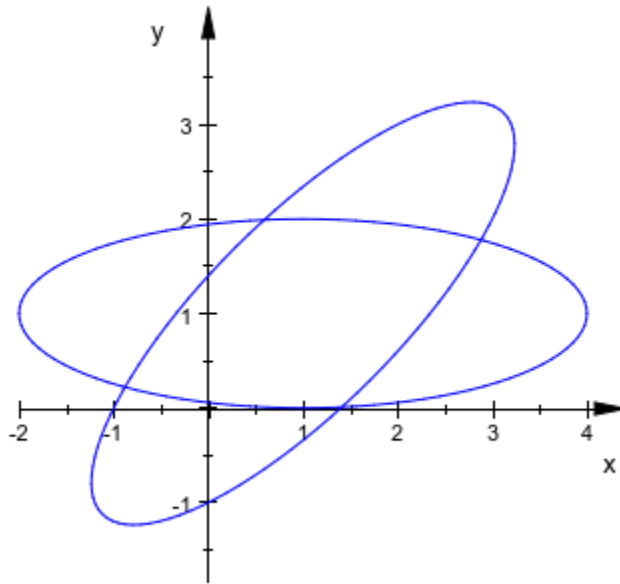

delete ellipse:

## Parameters

$r_1, r_2$

The semi-axes of an ellipse. They must be real numerical values or arithmetical expressions (Symbolic Math Toolbox) of the animation parameter  $a$ .

$r_1, r_2$  are equivalent to the attributes `SemiAxisX`, `SemiAxisY`.

$c_x, c_y$

The center. The coordinates  $c_x, c_y$  must be real numerical values or arithmetical expressions (Symbolic Math Toolbox) of the animation parameter  $a$ . If no center is specified, the ellipse is centered at the origin.

$c_x, c_y$  are equivalent to the attribute `Center`.

**a**

Animation parameter, specified as  $a = a_{\min}..a_{\max}$ , where  $a_{\min}$  is the initial parameter value, and  $a_{\max}$  is the final parameter value.

## See Also

**MuPAD Functions**

plot | plot::copy

**MuPAD Graphical Primitives**

plot::Arc2d | plot::Arc3d | plot::Circle2d | plot::Ellipse3d

## plot::Ellipse3d

Ellipses in 3D

### Syntax

```
plot::Ellipse3d(r1, r2, <[cx, cy, cz], <[nx, cy, nz]>>, <a = amin .. amax>, options)
```

### Description

`plot::Ellipse3d( r1, r2, [cx, cy, cz] , [nx, ny, nz] )` creates a 3D ellipse with center point [c<sub>x</sub>, c<sub>y</sub>, c<sub>z</sub>] and semi-axes of lengths r<sub>1</sub> and r<sub>2</sub> in the plane with the normal vector [n<sub>x</sub>, n<sub>y</sub>, n<sub>z</sub>].

The symmetry axes of the ellipse are parallel to the coordinate axes. Use `plot::Rotate3d` to create ellipses of different orientation.

If the center point is not specified, an ellipse with center [0, 0, 0] is created.

### Attributes

Attribute	Purpose	Default Value
AffectViewingBox	influence of objects on the ViewingBox of a scene	TRUE
Center	center of objects, rotation center	[0, 0, 0]
CenterX	center of objects, rotation center, x-component	0
CenterY	center of objects, rotation center, y-component	0
CenterZ	center of objects, rotation center, z-component	0



Attribute	Purpose	Default Value
Filled	filled or transparent areas and surfaces	FALSE
FillColor	color of areas and surfaces	RGB::LightBlue
FillColor2	second color of areas and surfaces for color blends	RGB::CornflowerBlue
FillColorType	surface filling types	Flat
FillColorDirection	the direction of color transitions on surfaces	[0, 0, 1]
FillColorDirectionX	x-component of the direction of color transitions on surfaces	0
FillColorDirectionY	y-component of the direction of color transitions on surfaces	0
FillColorDirectionZ	z-component of the direction of color transitions on surfaces	1
Frames	the number of frames in an animation	50
Legend	makes a legend entry	
LegendText	short explanatory text for legend	
LegendEntry	add this object to the legend?	FALSE
LineColor	color of lines	RGB::Blue
LineWidth	width of lines	0.35
LineColor2	color of lines	RGB::DeepPink
LineStyle	solid, dashed or dotted lines?	Solid
LinesVisible	visibility of lines	TRUE
LineColorType	line coloring types	Flat

<b>Attribute</b>	<b>Purpose</b>	<b>Default Value</b>
LineColorDirection	the direction of color transitions on lines	[0, 0, 1]
LineColorDirectionX	x-component of the direction of color transitions on lines	0
LineColorDirectionY	y-component of the direction of color transitions on lines	0
LineColorDirectionZ	z-component of the direction of color transitions on lines	1
Name	the name of a plot object (for browser and legend)	
Normal	normal vector of circles and discs, etc. in 3D	[0, 0, 1]
NormalX	normal vector of circles and discs, etc. in 3D, x-component	0
NormalY	normal vector of circles and discs, etc. in 3D, y-component	0
NormalZ	normal vector of circles and discs, etc. in 3D, z-component	1
ParameterEnd	end value of the animation parameter	
ParameterName	name of the animation parameter	
ParameterBegin	initial value of the animation parameter	
ParameterRange	range of the animation parameter	
SemiAxes	semi axes of ellipses and ellipsoids	
SemiAxisX	first semi axis of ellipses and ellipsoids	2

<b>Attribute</b>	<b>Purpose</b>	<b>Default Value</b>
SemiAxisY	second semi axis of ellipses and ellipsoids	1
TimeEnd	end time of the animation	10.0
TimeBegin	start time of the animation	0.0
TimeRange	the real time span of an animation	0.0 .. 10.0
Title	object title	
TitleFont	font of object titles	[" sans-serif ", 11]
TitlePosition	position of object titles	
TitleAlignment	horizontal alignment of titles w.r.t. their coordinates	Center
TitlePositionX	position of object titles, x component	
TitlePositionY	position of object titles, y component	
TitlePositionZ	position of object titles, z component	
Visible	visibility	TRUE
VisibleAfter	object visible after this time value	
VisibleBefore	object visible until this time value	
VisibleFromTo	object visible during this time range	
VisibleAfterEnd	object visible after its animation time ended?	TRUE
VisibleBeforeBegin	object visible before its animation time starts?	TRUE

## Examples

### Example 1

Plot an animated 3D ellipse:

```
plot(plot::Ellipse3d(1, 1, [0,0,0], [0,a,1-a], a = 0..1))
```

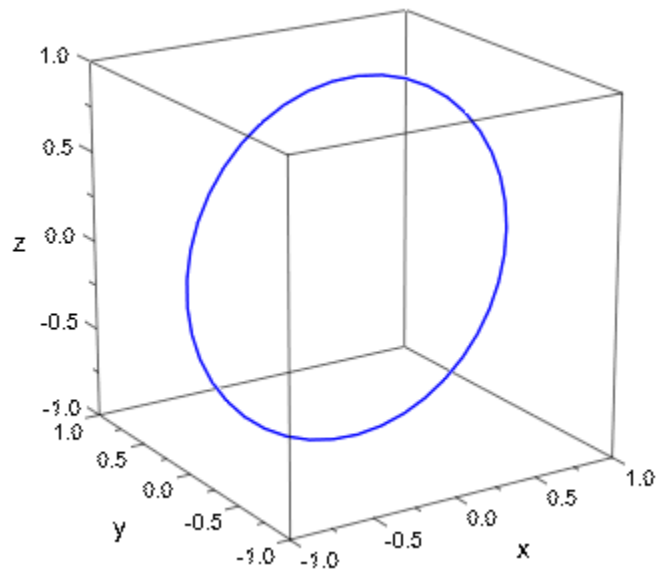

### Example 2

Plot a colored 3D ellipse:

```
plot(plot::Ellipse3d(2, 1, [0,0,0], Filled,  
  LineColor=RGB::Yellow, LineColor2=RGB::Red,  
  LineColorType = Dichromatic, FillColorDirection=[+1,0,0],  
  FillColor=RGB::Yellow, FillColor2=RGB::Red,  
  FillColorType = Dichromatic, FillColorDirection=[-1,0,0]  
))
```

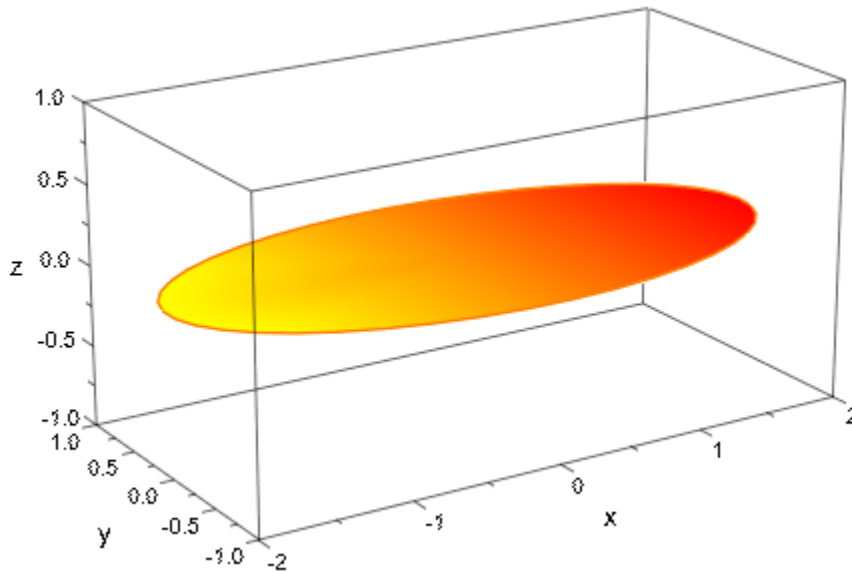

## Parameters

$r_1, r_2$

The semi-axes of an ellipse. They must be real numerical values or arithmetical expressions (Symbolic Math Toolbox) of the animation parameter  $a$ .

$r_1, r_2$  are equivalent to the attributes `SemiAxisX`, `SemiAxisY`.

$c_x, c_y, c_z$

The center. The coordinates  $c_x, c_y, c_z$  must be real numerical values or arithmetical expressions (Symbolic Math Toolbox) of the animation parameter  $a$ . If no center is specified, the ellipse is centered at the origin.

$c_x, c_y, c_z$  are equivalent to the attribute `Center`.

**$n_x, n_y, n_z$** 

The normal vector. The coordinates  $n_x, n_y, n_z$  must be real numerical values or arithmetical expressions (Symbolic Math Toolbox) of the animation parameter  $a$ . If no normal vector is specified, the ellipse is created in the  $xy$ -plane.

$n_x, n_y, n_z$  are equivalent to the attribute `Normal`.

 **$a$** 

Animation parameter, specified as  $a = a_{\min} \dots a_{\max}$ , where  $a_{\min}$  is the initial parameter value, and  $a_{\max}$  is the final parameter value.

## See Also

**MuPAD Functions**

`plot` | `plot::copy`

**MuPAD Graphical Primitives**

`plot::Arc2d` | `plot::Arc3d` | `plot::Circle2d` | `plot::Ellipse2d`

# plot::Function2d

2D function graphs

## Syntax

```
plot::Function2d(f, options)
```

```
plot::Function2d(f, x = xmin .. xmax, <a = amin .. amax>, options)
```

## Description

`plot::Function2d` creates the 2D graph of a univariate function.

The graphics ignores all points, where the expression/function `f` does not produce a numerical real value. See “Example 2” on page 24-302 (Symbolic Math Toolbox).

The expression/function `f` may have singularities in the plot range. Although a heuristics is used to find a reasonable `y` range when singularities are present, it is highly recommended to specify a `y` range via `ViewingBoxYRange = `y_{min}` .. `y_{max}`` with suitable numerical real values `ymin`, `ymax`. See “Example 3” on page 24-303 (Symbolic Math Toolbox).

Animations are triggered by specifying a range `a = `a_{min}` .. `a_{max}`` for a parameter `a` that is different from the independent variable `x`. Thus, in animations, both the `x`-range `x = `x_{min}` .. `x_{max}`` as well as the animation range `a = `a_{min}` .. `a_{max}`` must be specified. See “Example 4” on page 24-305 (Symbolic Math Toolbox).

The function `f` is evaluated on an equidistant mesh of sample points determined by the attribute `XMesh` (or the shorthand notation `Mesh`). By default, the attribute `AdaptiveMesh = 0` is set, i.e., no adaptive refinement of the equidistant mesh is used.

If the standard mesh does not suffice to produce a sufficiently detailed plot, one may either increase the value of `XMesh` or set `AdaptiveMesh = n` with some (small) positive integer `n`. If necessary, up to  $2^n$  additional points are placed between adjacent points of the initial equidistant mesh. See “Example 5” on page 24-306 (Symbolic Math Toolbox).

By default, the attribute `DiscontinuitySearch = TRUE` is set. This triggers a semi-symbolic preprocessing of the expression `f` to search for discontinuities and singularities. At each singular point, the function graph is split into disjoint branches to the left and to the right of the singularity. This avoids graphical artifacts such as lines connecting points to the left and to the right of a singularity.

If the function is known to be regular in the plot range, the semi-symbolic search may be disabled by specifying `DiscontinuitySearch = FALSE`. This will improve the efficiency of the plot commands.

Singular points are highlighted by a vertical line unless `VerticalAsymptotesVisible = FALSE` is specified. Its style may be set by the attributes `VerticalAsymptotesStyle`, `VerticalAsymptotesWidth`, and `VerticalAsymptotesColor`.

---

**Note** This functionality is only available if the function is specified by a an arithmetical expression or a procedure that accepts symbolic arguments. It is not available if the function is specified by a `piecewise` object or by a procedure that accepts only numerical arguments.

---

See “Example 6” on page 24-310 (Symbolic Math Toolbox).

`plot::Hatch` allows to hatch areas between function graphs. See “Example 7” on page 24-312 (Symbolic Math Toolbox).

## Attributes

Attribute	Purpose	Default Value
<code>AdaptiveMesh</code>	adaptive sampling	2
<code>AffectViewingBox</code>	influence of objects on the <code>ViewingBox</code> of a scene	TRUE
<code>AntiAliased</code>	antialiased lines and points?	TRUE
<code>Color</code>	the main color	<code>RGB::Blue</code>
<code>DiscontinuitySearch</code>	semi-symbolic search for discontinuities	TRUE



Attribute	Purpose	Default Value
Frames	the number of frames in an animation	50
Function	function expression or procedure	
Legend	makes a legend entry	
LegendText	short explanatory text for legend	
LegendEntry	add this object to the legend?	TRUE
LineColor	color of lines	RGB::Blue
LineWidth	width of lines	0.35
LineColor2	color of lines	RGB::DeepPink
LineStyle	solid, dashed or dotted lines?	Solid
LinesVisible	visibility of lines	TRUE
LineColorType	line coloring types	Flat
LineColorFunction	functional line coloring	
LineColorDirection	the direction of color transitions on lines	[0, 1]
LineColorDirectionX	x-component of the direction of color transitions on lines	0
LineColorDirectionY	y-component of the direction of color transitions on lines	1
Mesh	number of sample points	121
Name	the name of a plot object (for browser and legend)	
ParameterEnd	end value of the animation parameter	
ParameterName	name of the animation parameter	

<b>Attribute</b>	<b>Purpose</b>	<b>Default Value</b>
ParameterBegin	initial value of the animation parameter	
ParameterRange	range of the animation parameter	
PointSize	the size of points	1.5
PointStyle	the presentation style of points	FilledCircles
PointsVisible	visibility of mesh points	FALSE
Submesh	density of submesh (additional sample points)	0
TimeEnd	end time of the animation	10.0
TimeBegin	start time of the animation	0.0
TimeRange	the real time span of an animation	0.0 .. 10.0
Title	object title	
TitleFont	font of object titles	[" sans-serif ", 11]
TitlePosition	position of object titles	
TitleAlignment	horizontal alignment of titles w.r.t. their coordinates	Center
TitlePositionX	position of object titles, x component	
TitlePositionY	position of object titles, y component	
VerticalAsymptotesColor	color of vertical asymptotes indicating poles	RGB: :Grey50
VerticalAsymptotesWidth	line width of vertical asymptotes indicating poles	0.2
VerticalAsymptotesStyle	line style of vertical asymptotes indicating poles	Dashed
VerticalAsymptotesVisible	vertical asymptotes indicating poles	TRUE

Attribute	Purpose	Default Value
Visible	visibility	TRUE
VisibleAfter	object visible after this time value	
VisibleBefore	object visible until this time value	
VisibleFromTo	object visible during this time range	
VisibleAfterEnd	object visible after its animation time ended?	TRUE
VisibleBeforeBegin	object visible before its animation time starts?	TRUE
XMax	final value of parameter "x"	5
XMesh	number of sample points for parameter "x"	121
XMin	initial value of parameter "x"	-5
XName	name of parameter "x"	
XRange	range of parameter "x"	-5 .. 5
XSubmesh	density of additional sample points for parameter "x"	0

## Examples

### Example 1

The following call returns an object representing the graph of the sine function over the interval  $[0, 2\pi]$ :

```
f := plot::Function2d(sin(x), x = 0 .. 2*PI)
```

```
plot::Function2d(sin(x), x = 0..2 π)
```

Call `plot` to plot the graph:

```
plot(f):
```

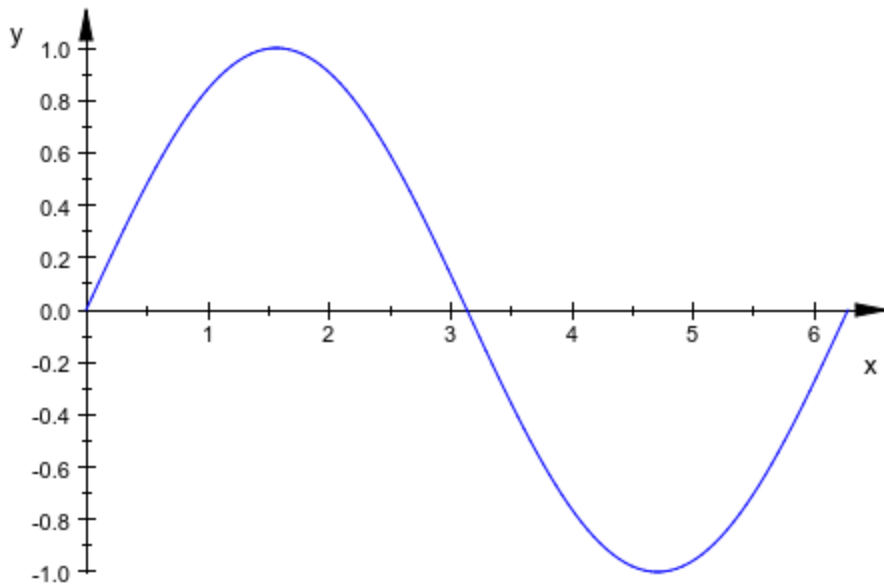

Functions can also be specified by `piecewise` objects or procedures:

```
f := piecewise([x < 1, 1 - x], [x >= 1, x^2]):  
plot(plot::Function2d(f, x = -2 .. 4)):
```

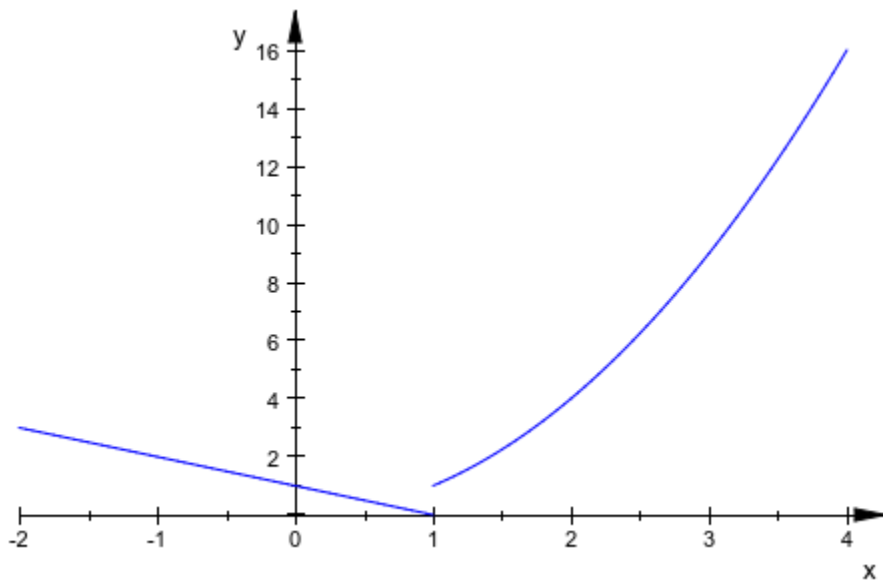

```
f := proc(x)
begin
  if x^2 - 2*x < 0 then
    0
  else
    x^2 - 2*x
  end_if:
end_proc:
plot(plot::Function2d(f, x = -2 .. 4)):
```

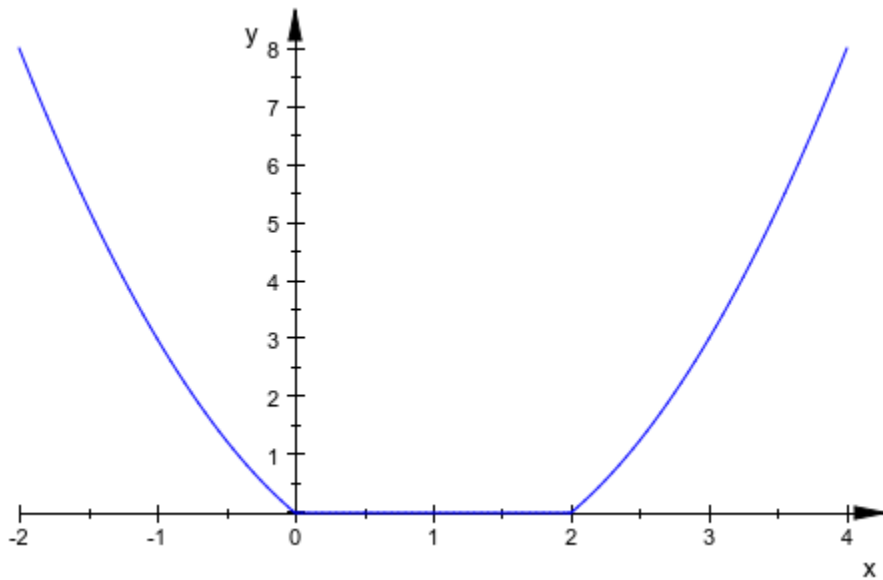

delete f:

## Example 2

Non-real values are ignored in a plot:

```
plot(plot::Function2d(sqrt(1 - x^2), x = -2 .. 2),  
      Scaling = Constrained):
```

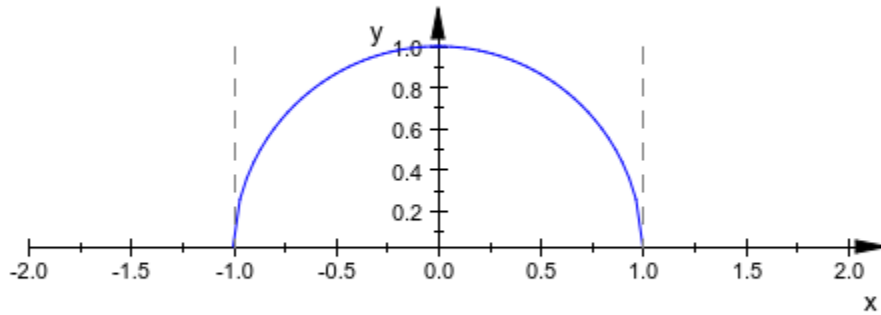

### Example 3

We plot a function with singularities:

```
f := plot::Function2d(sin(x)/(1 - x) - 1/cos(x), x = 0 .. PI):  
plot(f):
```

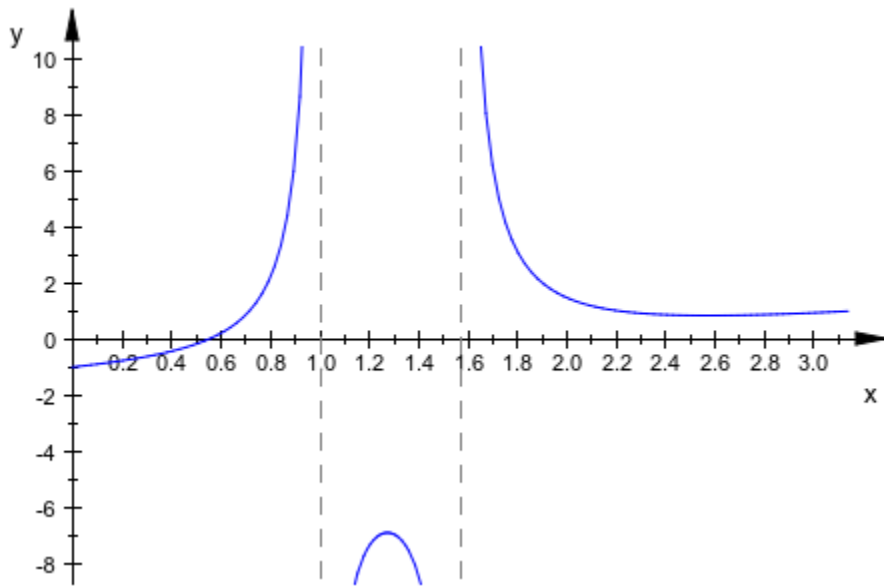

We specify an explicit viewing range for the y direction:

```
plot(f, ViewingBoxYRange = -20 .. 10):
```



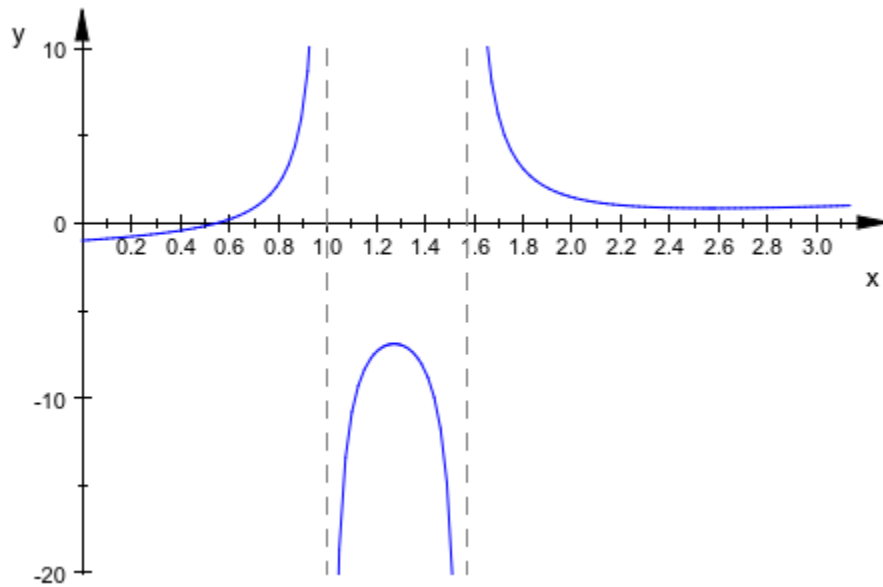

delete f:

#### Example 4

We generate an animation of a parametrized function:

```
plot(plot::Function2d(a*sin(x) + (1 - a)*cos(x),  
x = -PI .. PI, a = 0 .. 1)):
```

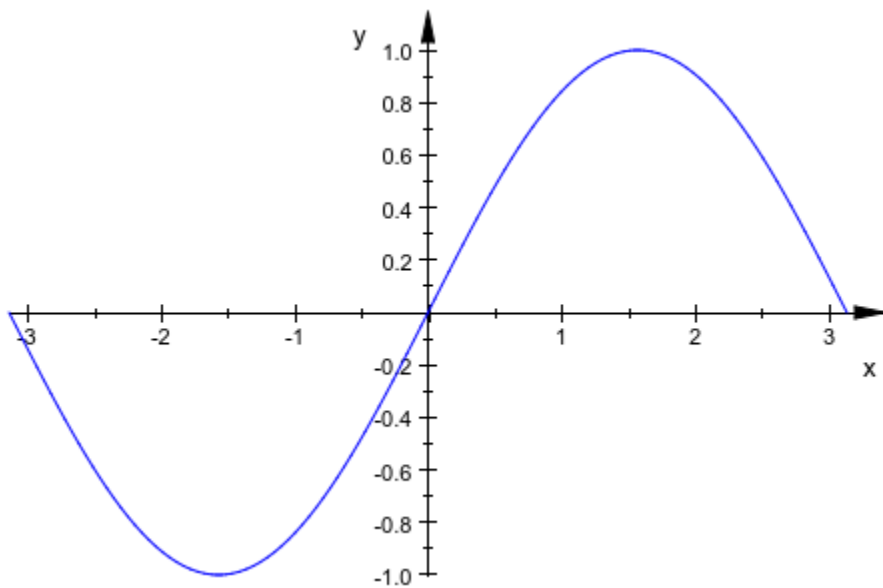

### Example 5

The standard mesh for the numerical evaluation of a function graph does not suffice to generate a satisfying graphics in the following case:

```
plot(plot::Function2d(sin(PI/x), x = -1 .. 1)):
```

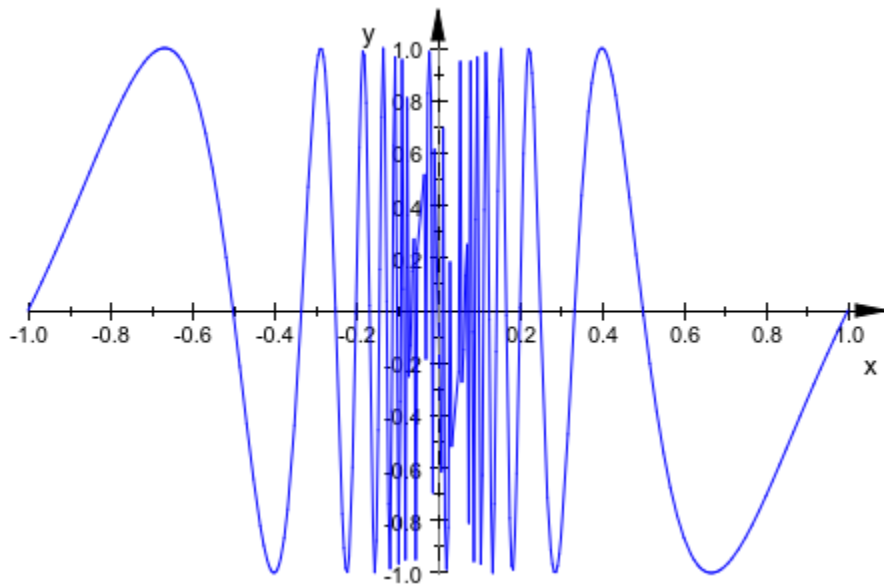

We increase the number of mesh points:

```
plot(plot::Function2d(sin(PI/x), x = -1 .. 1, XMesh = 1000)):
```

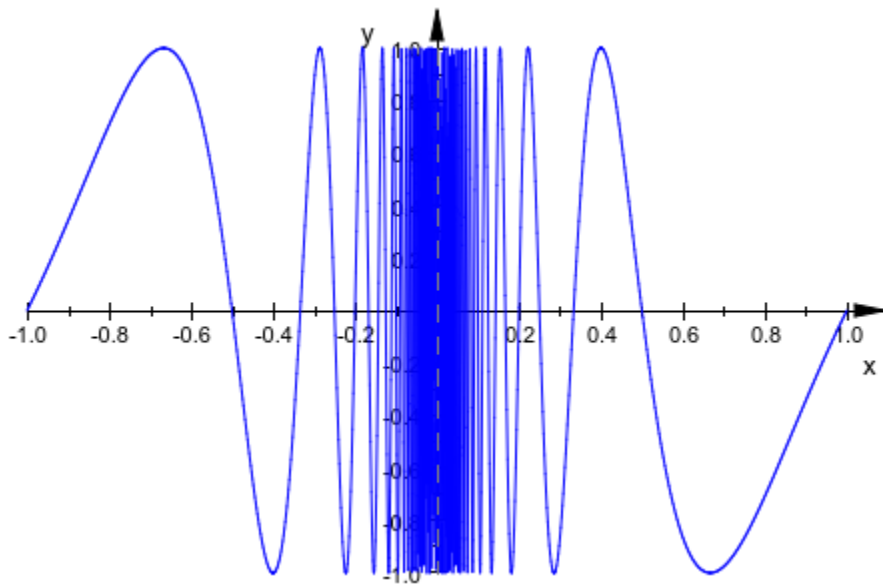

Alternatively, we enable adaptive sampling by setting `AdaptiveMesh` to some positive value:

```
plot(plot::Function2d(sin(PI/x), x = -1 .. 1, AdaptiveMesh = 3)):
```

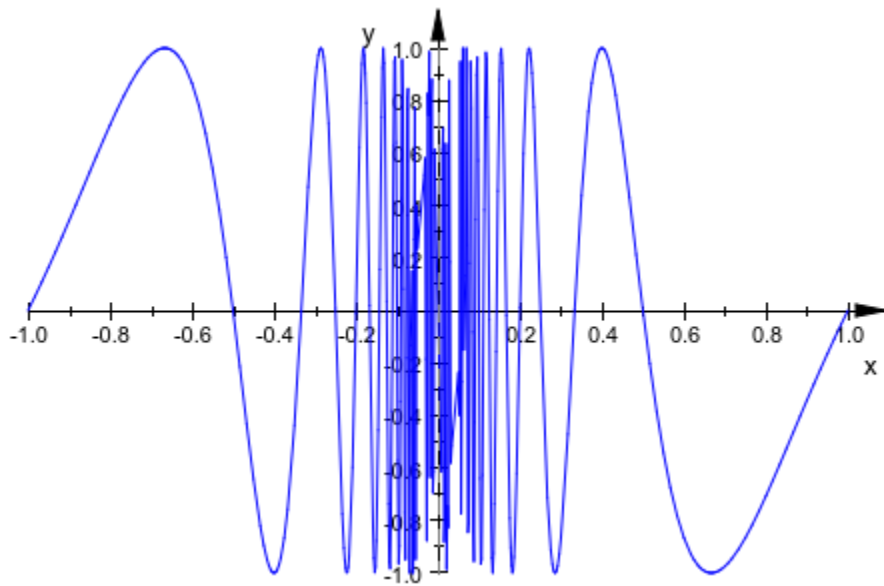

Finally, we increase the XMesh value and use adaptive sampling:

```
plot(plot::Function2d(sin(PI/x), x = -1 .. 1, XMesh = 1000,  
    AdaptiveMesh = 3)):
```

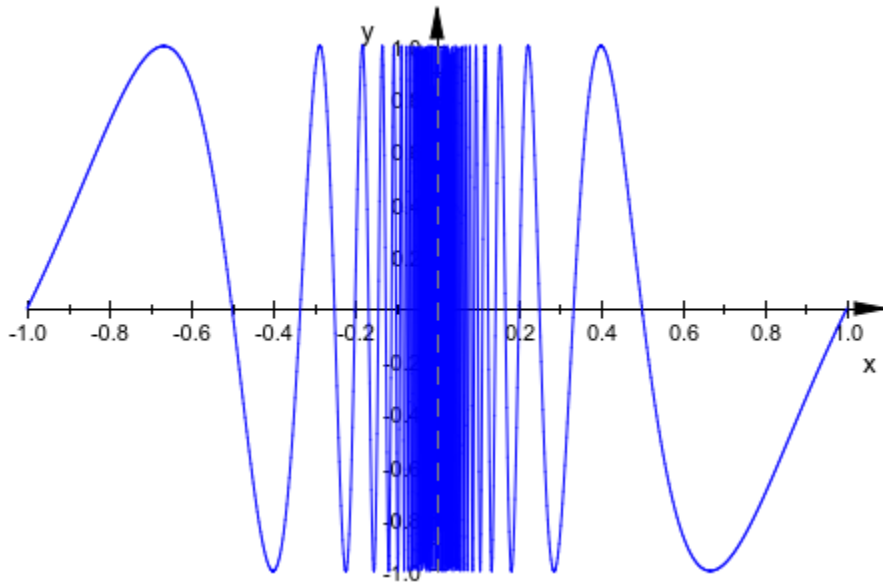

### Example 6

With `VerticalAsymptotesVisible = TRUE/FALSE`, singular points are highlighted by a vertical asymptote, or this highlighting is switched off, respectively:

```
plot(plot::Function2d(ln(x + PI) + 1/(x - 1) - 1/(x + 1)^2,  
x = -4 .. 4,  
VerticalAsymptotesVisible = TRUE,  
ViewingBoxYRange = -10 .. 10)):
```

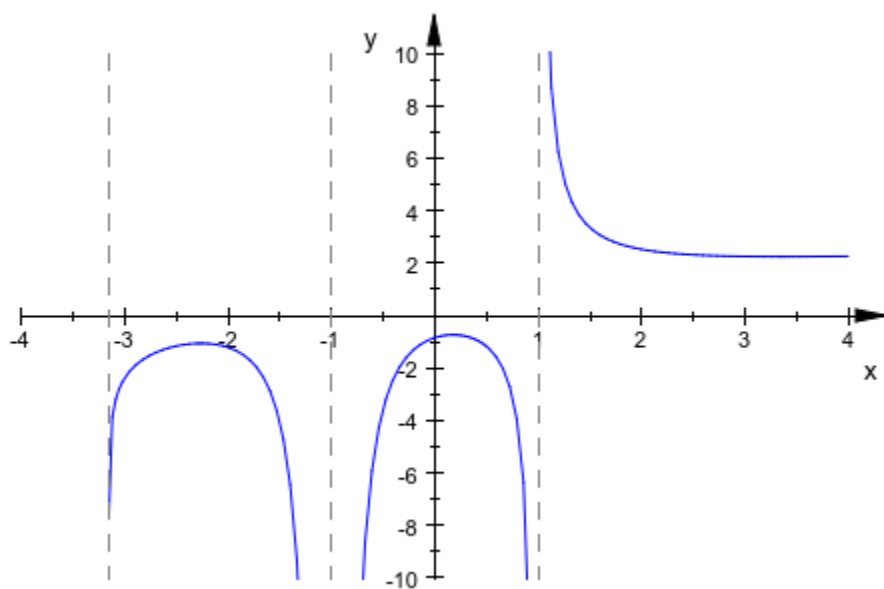

```
plot(plot::Function2d(ln(x + PI) + 1/(x - 1) - 1/(x + 1)^2,  
x = -4 .. 4,  
VerticalAsymptotesVisible = FALSE,  
ViewingBoxYRange = -10 .. 10)):
```

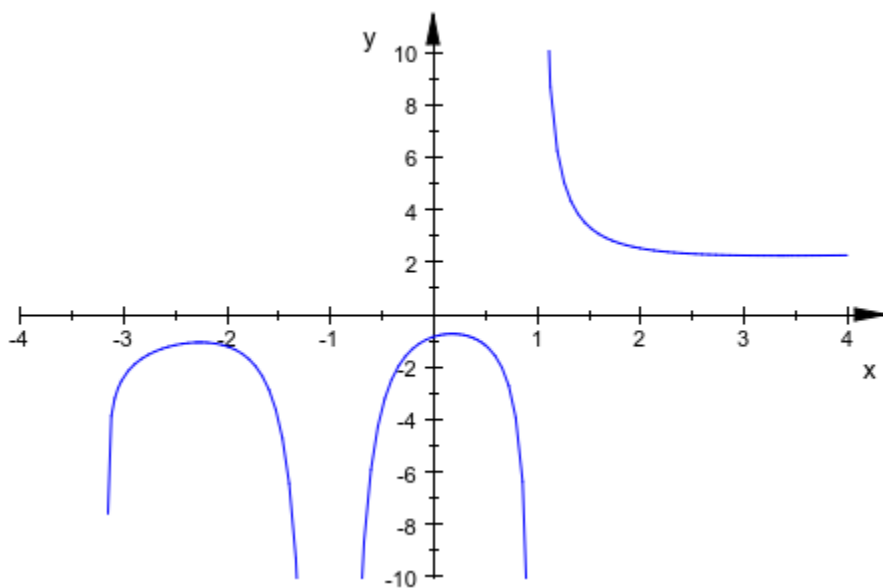

### Example 7

The `plot::Hatch` object allows to hatch regions between functions. It expects graphical objects of type `plot::Function2d` or `plot::Curve2d` as boundaries:

```
f1:= plot::Function2d(sin(x), x = -PI .. 2*PI):  
f2:= plot::Function2d(cos(x), x = -PI .. 2*PI):  
plot(f1, f2, plot::Hatch(f1, f2, -1 .. 5)):
```



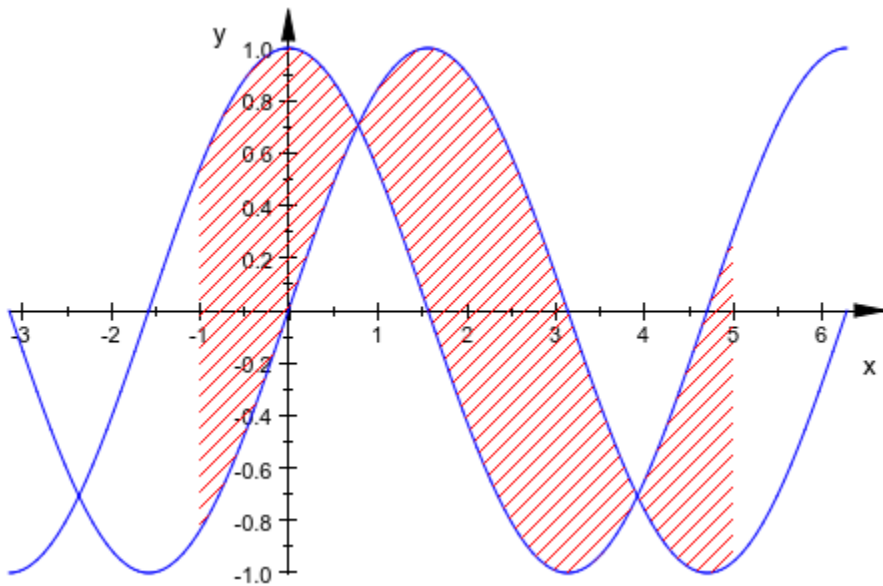

delete f1, f2:

## Parameters

### f

The function: an arithmetical expression (Symbolic Math Toolbox) or a `piecewise` object in the independent variable  $x$  and the animation parameter  $a$ . Alternatively, a procedure on page 1-1654 that accepts 1 input parameter  $x$  or 2 input parameters  $x, a$  and returns a real numerical value when the input parameters are numerical.

$f$  is equivalent to the attribute `Function`.

### x

The independent variable: an identifier on page 7-29 or an indexed identifier on page 1-1017.

$x$  is equivalent to the attribute `XName`.

$x_{\min} \dots x_{\max}$

The plot range:  $x_{\min}, x_{\max}$  must be numerical real values or expressions of the animation parameter  $a$ . If not specified, the default range  $x = -5 \dots 5$  is used.

$x_{\min} \dots x_{\max}$  is equivalent to the attributes `XRange`, `XMin`, `XMax`.

**a**

Animation parameter, specified as  $a = a_{\min} \dots a_{\max}$ , where  $a_{\min}$  is the initial parameter value, and  $a_{\max}$  is the final parameter value.

## See Also

### MuPAD Functions

`plot` | `plot::copy` | `plotfunc2d` | `plotfunc3d`

### MuPAD Graphical Primitives

`plot::Function3d`

# plot::Function3d

3D function graphs

---

**Note** For a 3-D function plot in MATLAB®, see surf.

---

## Syntax

```
plot::Function3d(f, options)
```

```
plot::Function3d(f, x = x_min .. x_max, y = y_min .. y_max, <a = a_min .. a_max>, options)
```

## Description

plot::Function3d creates the 3D graph of a function in 2 variables.

The expression  $f(x, y)$  is evaluated at finitely many points  $x, y$  in the plot range. There may be singularities. Although a heuristics is used to find a reasonable  $z$  range when singularities are present, it is highly recommended to specify a  $z$  range via `ViewingBoxZRange = `z_{min}` .. `z_{max}`` with suitable numerical real values  $z_{\min}, z_{\max}$ . See “Example 2” on page 24-323 (Symbolic Math Toolbox).

Animations are triggered by specifying a range `a = `a_{min}` .. `a_{max}`` for a parameter  $a$  that is different from the independent variables  $x, y$ . Thus, in animations, the  $x$ -range `x = `x_{min}` .. `x_{max}``, the  $y$ -range `y = `y_{min}` .. `y_{max}`` as well as the animation range `a = `a_{min}` .. `a_{max}`` must be specified. See “Example 3” on page 24-325 (Symbolic Math Toolbox).

The function  $f$  is evaluated on a regular equidistant mesh of sample points determined by the attributes `XMesh` and `YMesh` (or the shorthand-notation for both, `Mesh`). By default, the attribute `AdaptiveMesh = 0` is set, i.e., no adaptive refinement of the equidistant mesh is used.

If the standard mesh does not suffice to produce a sufficiently detailed plot, one may either increase the value of `XMesh` and `YMesh` or set `AdaptiveMesh = n` with some (small) positive integer  $n$ . This may result in up to  $4^n$  times as many triangles as used with

`AdaptiveMesh = 0`, potentially more when `f` has non-isolated singularities. See “Example 4” on page 24-326 (Symbolic Math Toolbox).

The “coordinate lines” (“parameter lines”) are curves on the function graph.

The phrase “XLines” refers to the curves  $(x, y_0, f(x, y_0))$  with the parameter `x` running from  $x_{\min}$  to  $x_{\max}$ , while  $y_0$  is some fixed value from the interval  $[y_{\min}, y_{\max}]$ .

The phrase “YLines” refers to the curves  $(x_0, y, f(x_0, y))$  with the parameter `y` running from  $y_{\min}$  to  $y_{\max}$ , while  $x_0$  is some fixed value from the interval  $[x_{\min}, x_{\max}]$ .

By default, the parameter lines are visible. They may be “switched off” by specifying `XLinesVisible = FALSE` and `YLinesVisible = FALSE`, respectively.

The coordinate lines controlled by `XLinesVisible = TRUE/FALSE` and `YLinesVisible = TRUE/FALSE` indicate the equidistant regular mesh set via the `Mesh` attributes. If the mesh is refined by the `Submesh` attributes or by the adaptive mechanism controlled by `AdaptiveMesh = n`, no additional parameter lines are drawn.

As far as the numerical approximation of the function graph is concerned, the settings

`Mesh = [nx, ny], Submesh = [mx, my]`

and

`Mesh = [(nx - 1) (mx + 1) + 1, (ny - 1) (my + 1) + 1], Submesh = [0, 0]`

are equivalent. However, in the first setting, `nx` parameter lines are visible in the `x` direction, while in the latter setting `(nx - 1) (mx + 1) + 1` parameter lines are visible. See “Example 5” on page 24-329 (Symbolic Math Toolbox).

## Attributes

Attribute	Purpose	Default Value
<code>AdaptiveMesh</code>	adaptive sampling	0
<code>AffectViewingBox</code>	influence of objects on the <code>ViewingBox</code> of a scene	TRUE
<code>Color</code>	the main color	RGB: :Red

Attribute	Purpose	Default Value
Filled	filled or transparent areas and surfaces	TRUE
FillColor	color of areas and surfaces	RGB::Red
FillColor2	second color of areas and surfaces for color blends	RGB::CornflowerBlue
FillColorType	surface filling types	Dichromatic
FillColorFunction	functional area/surface coloring	
FillColorDirection	the direction of color transitions on surfaces	[0, 0, 1]
FillColorDirectionX	x-component of the direction of color transitions on surfaces	0
FillColorDirectionY	y-component of the direction of color transitions on surfaces	0
FillColorDirectionZ	z-component of the direction of color transitions on surfaces	1
Frames	the number of frames in an animation	50
Function	function expression or procedure	
Legend	makes a legend entry	
LegendText	short explanatory text for legend	
LegendEntry	add this object to the legend?	TRUE
LineColor	color of lines	RGB::Black.[0.25]
LineWidth	width of lines	0.35
LineColor2	color of lines	RGB::DeepPink

<b>Attribute</b>	<b>Purpose</b>	<b>Default Value</b>
LineStyle	solid, dashed or dotted lines?	Solid
LinesVisible	visibility of lines	TRUE
LineColorType	line coloring types	Flat
LineColorFunction	functional line coloring	
LineColorDirection	the direction of color transitions on lines	[0, 0, 1]
LineColorDirectionX	x-component of the direction of color transitions on lines	0
LineColorDirectionY	y-component of the direction of color transitions on lines	0
LineColorDirectionZ	z-component of the direction of color transitions on lines	1
Mesh	number of sample points	[25, 25]
MeshVisible	visibility of irregular mesh lines in 3D	FALSE
Name	the name of a plot object (for browser and legend)	
ParameterEnd	end value of the animation parameter	
ParameterName	name of the animation parameter	
ParameterBegin	initial value of the animation parameter	
ParameterRange	range of the animation parameter	
PointSize	the size of points	1.5
PointStyle	the presentation style of points	FilledCircles
PointsVisible	visibility of mesh points	FALSE

Attribute	Purpose	Default Value
Shading	smooth color blend of surfaces	Smooth
Submesh	density of submesh (additional sample points)	[0, 0]
TimeEnd	end time of the animation	10.0
TimeBegin	start time of the animation	0.0
TimeRange	the real time span of an animation	0.0 .. 10.0
Title	object title	
TitleFont	font of object titles	[" sans-serif ", 11]
TitlePosition	position of object titles	
TitleAlignment	horizontal alignment of titles w.r.t. their coordinates	Center
TitlePositionX	position of object titles, x component	
TitlePositionY	position of object titles, y component	
TitlePositionZ	position of object titles, z component	
Visible	visibility	TRUE
VisibleAfter	object visible after this time value	
VisibleBefore	object visible until this time value	
VisibleFromTo	object visible during this time range	
VisibleAfterEnd	object visible after its animation time ended?	TRUE
VisibleBeforeBegin	object visible before its animation time starts?	TRUE

Attribute	Purpose	Default Value
XLinesVisible	visibility of parameter lines (x lines)	TRUE
XMax	final value of parameter "x"	5
XMesh	number of sample points for parameter "x"	25
XMin	initial value of parameter "x"	-5
XName	name of parameter "x"	
XRange	range of parameter "x"	-5 .. 5
XSubmesh	density of additional sample points for parameter "x"	0
YLinesVisible	visibility of parameter lines (y lines)	TRUE
YMax	final value of parameter "y"	5
YMesh	number of sample points for parameter "y"	25
YMin	initial value of parameter "y"	-5
YName	name of parameter "y"	
YRange	range of parameter "y"	-5 .. 5
YSubmesh	density of additional sample points for parameter "y"	0
ZContours	contour lines at constant z values	[]

## Examples

### Example 1

The following call returns an object representing the graph of the function  $\sin(x^2 + y^2)$  over the region  $-2 \leq x \leq 2$ ,  $-2 \leq y \leq 2$ :



```
g := plot::Function3d(sin(x^2 + y^2), x = -2..2, y = -2..2)
```

```
plot::Function3d(sin(x^2 + y^2), x = -2..2, y = -2..2)
```

Call `plot` to plot the graph:

```
plot(g)
```

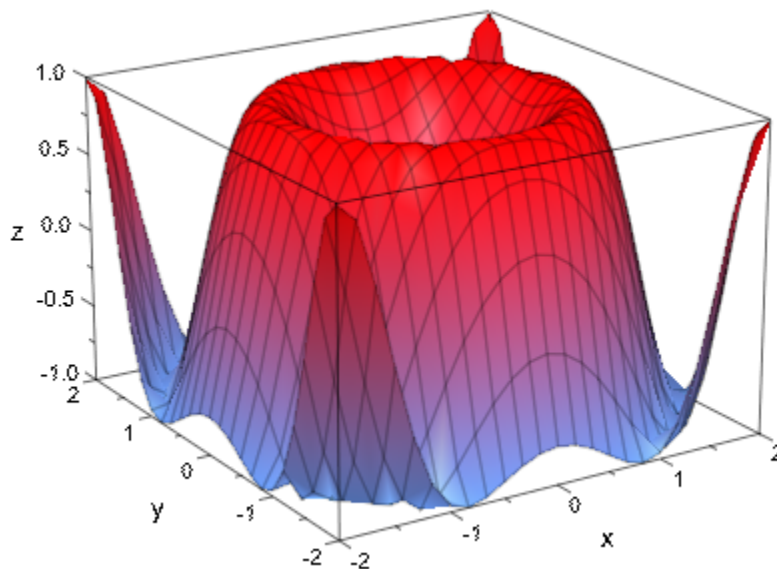

Functions can also be specified by `piecewise` objects or procedures:

```
f := piecewise([x < y, 0], [x >= y, (x - y)^2]):  
plot(plot::Function3d(f, x = -2 .. 4, y = -1 .. 3))
```

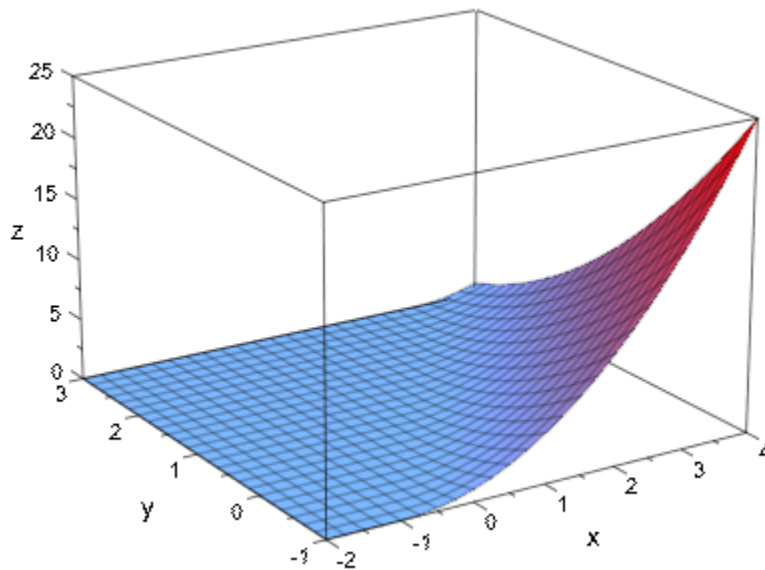

```
f := proc(x, y)
begin
  if x + y^2 + 2*y < 0 then
    0
  else
    x + y^2 + 2*y
  end_if:
end_proc:
plot(plot::Function3d(f, x = -3 .. 2, y = -2 .. 2))
```

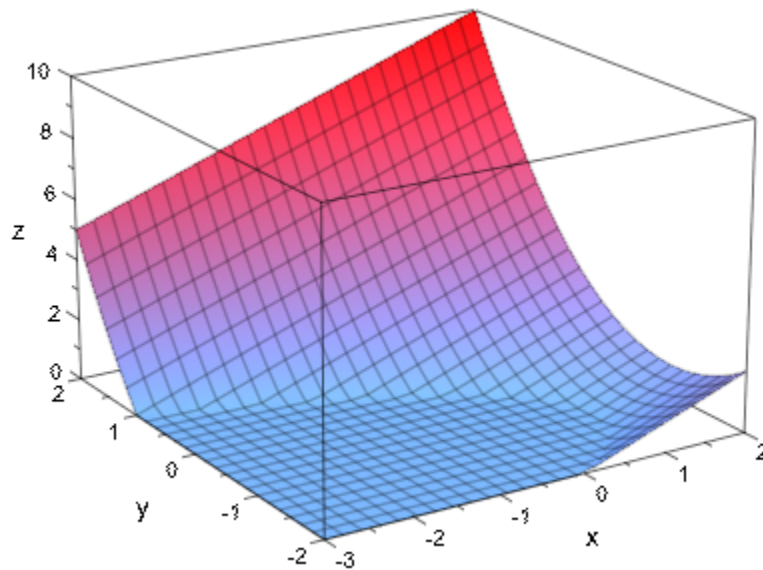

```
delete g, f
```

## Example 2

We plot a function with singularities:

```
f := plot::Function3d(x/y + y/x, x = -1 .. 1, y = -1 .. 1):  
plot(f)
```

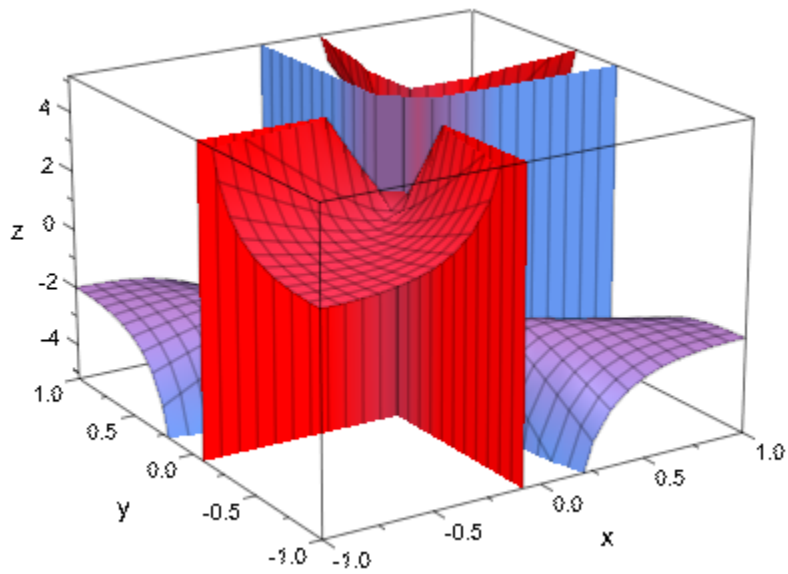

We specify an explicit viewing range for the  $z$  direction:

```
plot(f, ViewingBoxZRange = -20 .. 20)
```

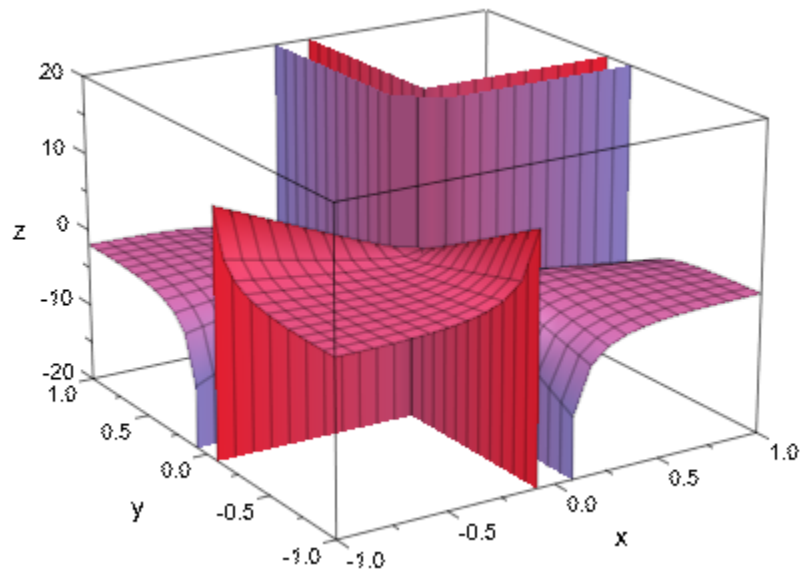

delete f

### Example 3

We generate an animation of a parametrized function:

```
plot(plot::Function3d(sin((x - a)^2 + y^2),  
x = -2 .. 2, y = -2 .. 2, a = 0 .. 5))
```

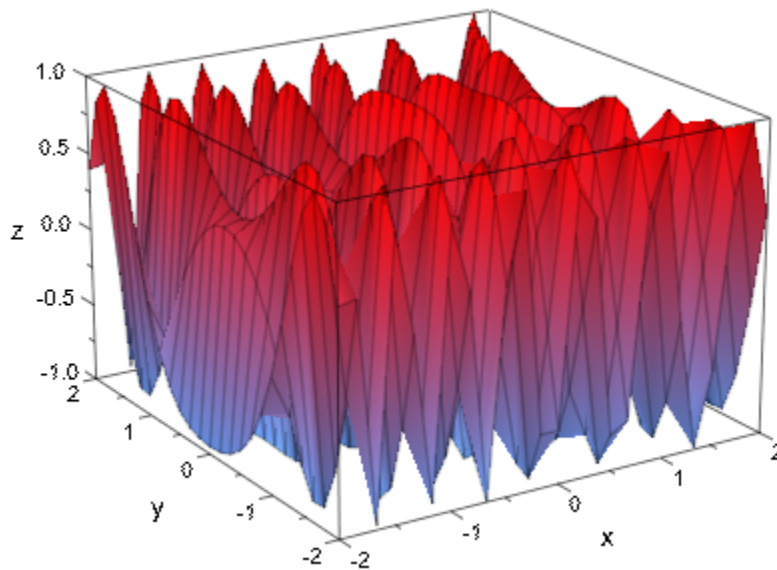

### Example 4

The standard mesh for the numerical evaluation of a function graph does not suffice to generate a satisfying graphics in the following case:

```
plot(plot::Function3d(besselJ(0, sqrt(x^2 + y^2)),  
x = -20 .. 20, y = -20 .. 20))
```

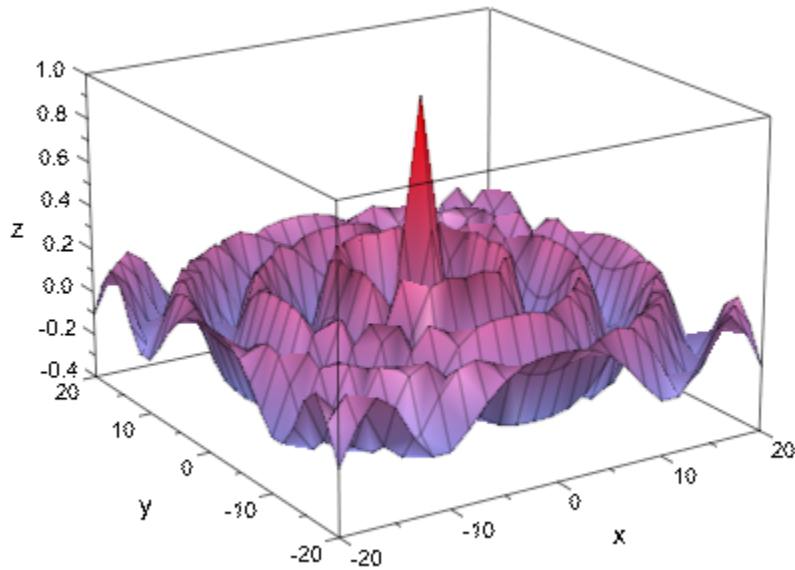

We increase the number of mesh points. Here, we use XSubmesh and YSubmesh to place 2 additional points in each direction between each pair of neighboring points of the default mesh. This increases the runtime by a factor of 9:

```
plot(plot::Function3d(besselJ(0, sqrt(x^2 + y^2)),  
    x = -20 .. 20, y = -20 .. 20,  
    Submesh = [2, 2]))
```

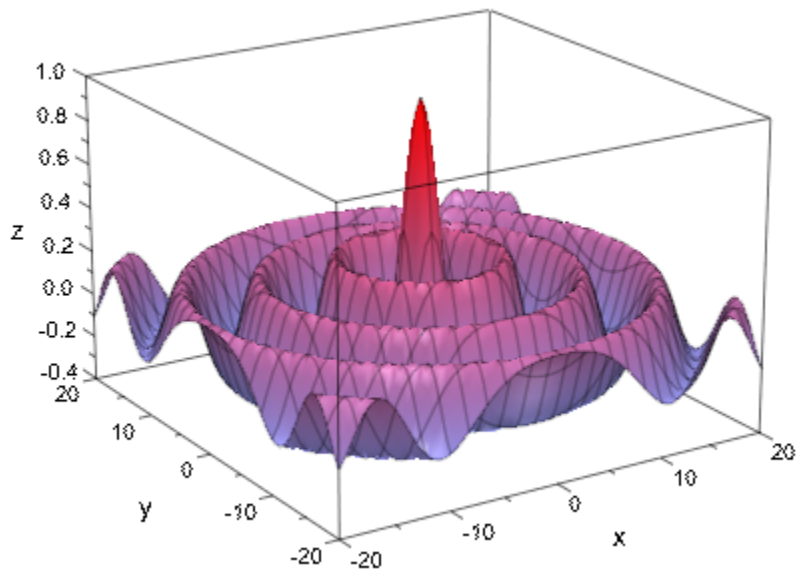

Alternatively, we enable adaptive sampling by setting the value of `AdaptiveMesh` to some positive value:

```
plot(plot::Function3d(besselJ(0, sqrt(x^2 + y^2)),  
  x = -20 .. 20, y = -20 .. 20,  
  AdaptiveMesh = 2))
```



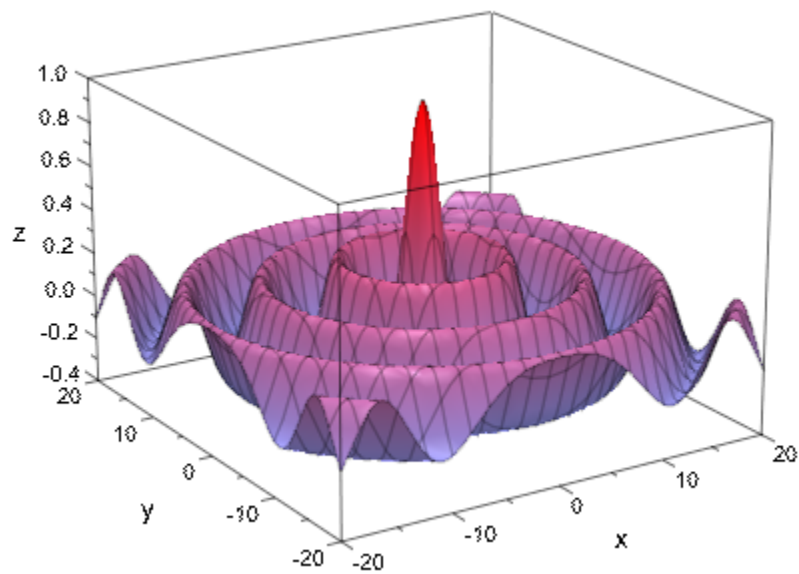

### Example 5

By default, the parameter lines of a function graph are “switched on”:

```
plot(plot::Function3d(x^2 + y^2, x = 0 .. 1, y = 0 .. 1))
```

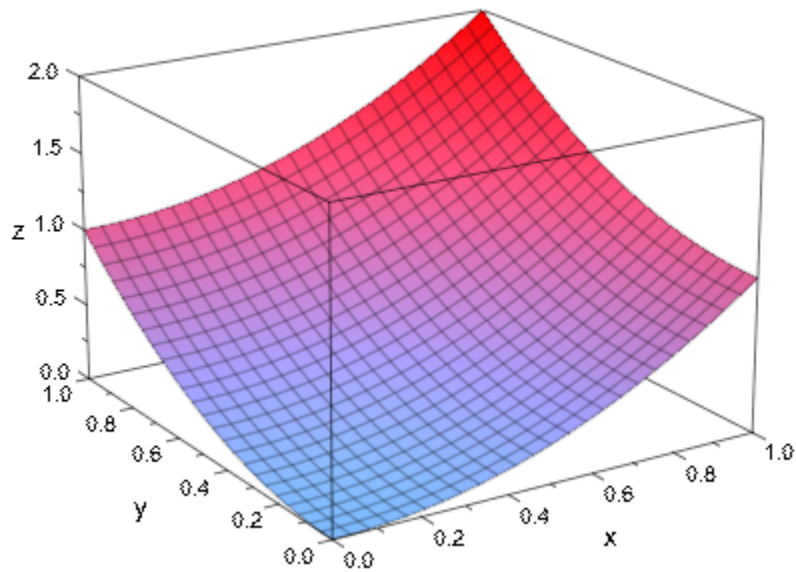

The parameter lines are “switched off” by setting `XLinesVisible`, `YLinesVisible`:

```
plot(plot::Function3d(x^2 + y^2, x = 0 .. 1, y = 0 .. 1,  
  XLinesVisible = FALSE,  
  YLinesVisible = FALSE))
```

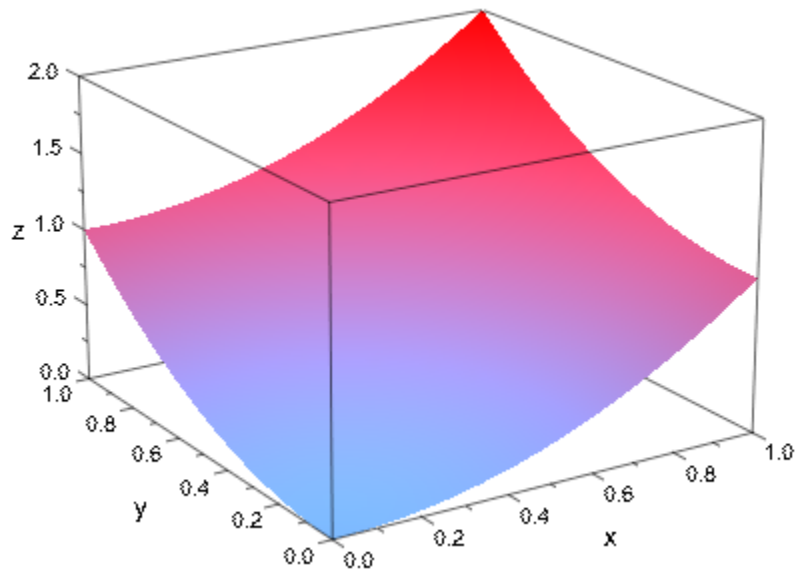

The number of parameter lines are determined by the Mesh attributes:

```
plot(plot::Function3d(x^2 + y^2, x = 0 .. 1, y = 0 .. 1,  
    Mesh = [5, 12]))
```

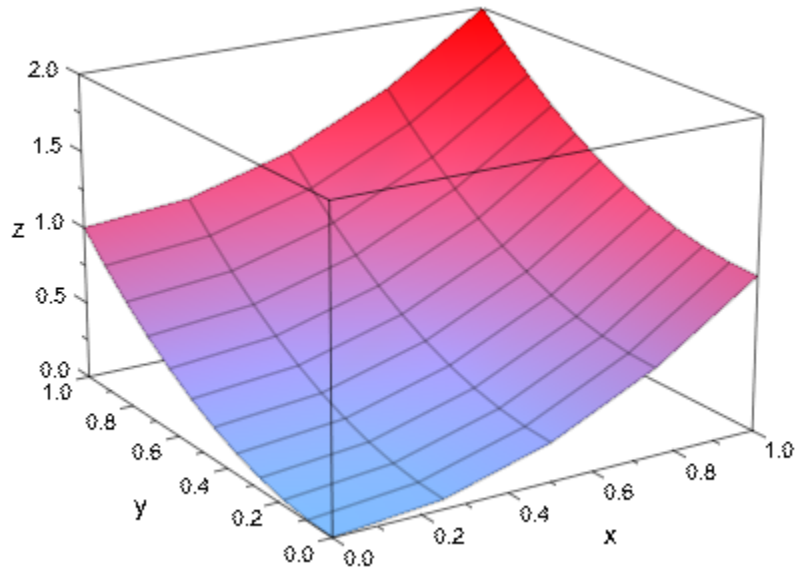

When the mesh is refined via the Submesh attributes, the numerical approximation of the surface becomes smoother. However, the number of parameter lines is not increased:

```
plot(plot::Function3d(x^2 + y^2, x = 0 .. 1, y = 0 .. 1,  
  Mesh = [5, 12],  
  XSubmesh = 1, YSubmesh = 2))
```

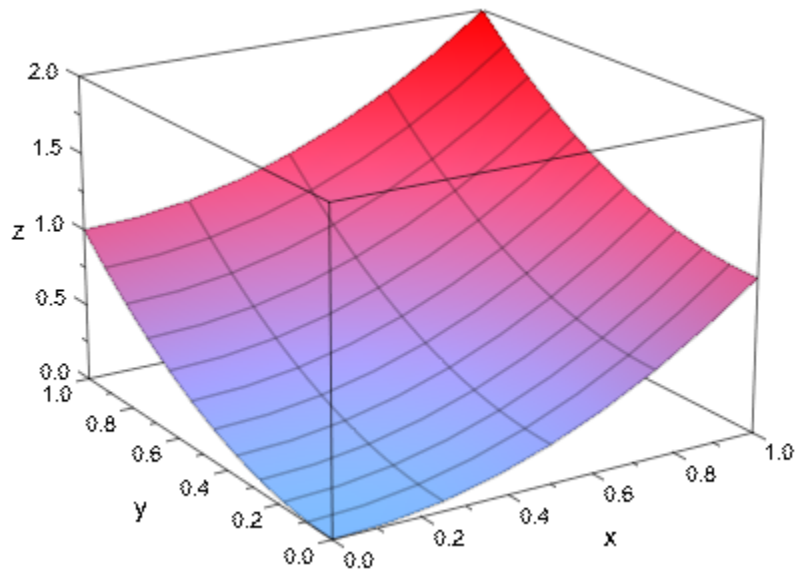

## Example 6

Functions need not be defined over the whole parameter range:

```
plot(plot::Function3d(sqrt(1-x^2-y^2), x=-1..1, y=-1..1))
```

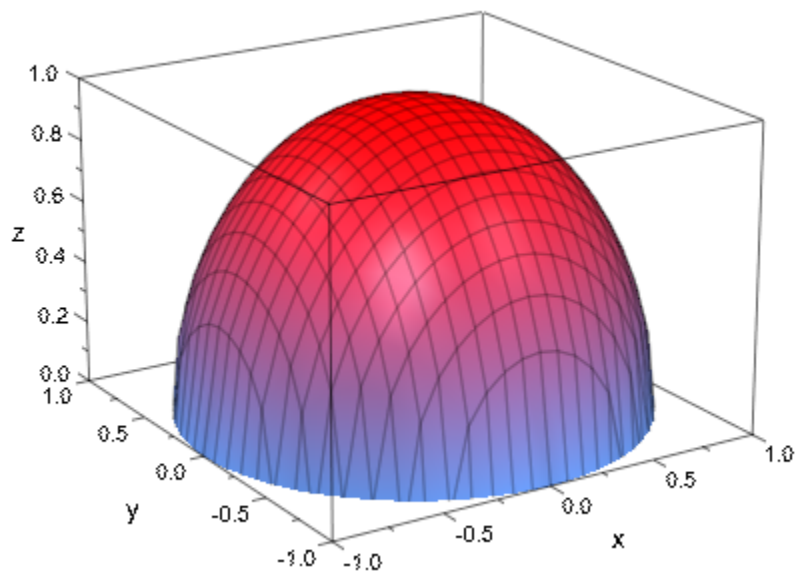

```
plot(plot::Function3d(sqrt(sin(x)+cos(y))))
```

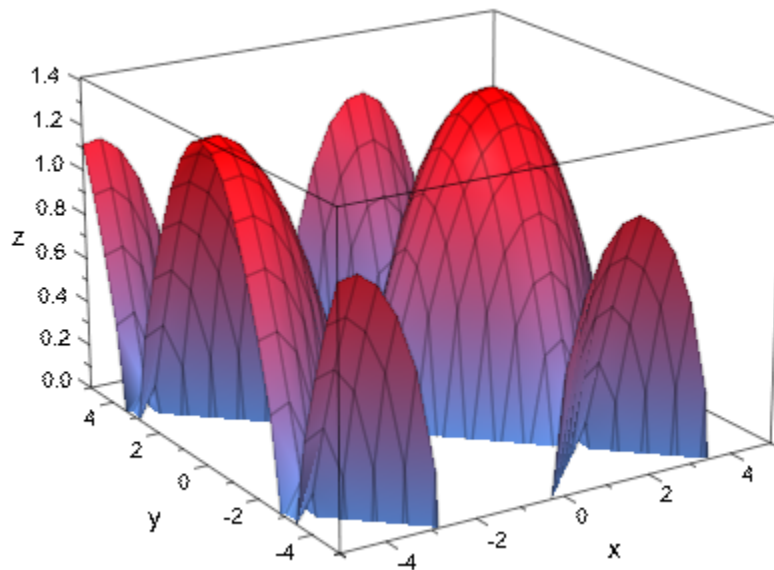

This makes for an easy way of plotting a function over a non-rectangular area:

```
chi := piecewise([x^2 < abs(y), 1])
```

```
{ 1 if  $x^2 < |y|$ 
```

```
plot(plot::Function3d(chi*sin(x+cos(y))),  
      CameraDirection=[-1,0,0.5])
```

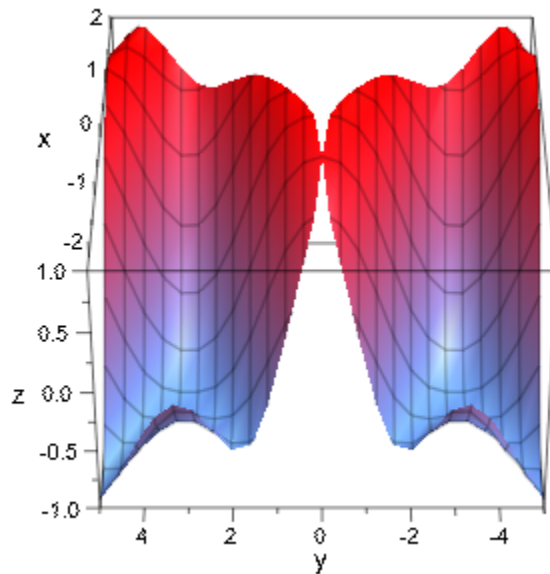

## Parameters

**f**

The function: an arithmetical expression (Symbolic Math Toolbox) or a `piecewise` object in the independent variables  $x$ ,  $y$  and the animation parameter  $a$ . Alternatively, a procedure on page 1-1654 that accepts 2 input parameter  $x$ ,  $y$  or 3 input parameters  $x$ ,  $y$ ,  $a$  and returns a numerical value when the input parameters are numerical.

$f$  is equivalent to the attribute `Function`.

**x**

The first independent variable: an identifier on page 7-29 or an indexed identifier on page 1-1017.

$x$  is equivalent to the attribute `XName`.



**$x_{\min}$  ..  $x_{\max}$**

The plot range in  $x$  direction:  $x_{\min}$ ,  $x_{\max}$  must be numerical real values or expressions of the animation parameter  $a$ . If not specified, the default range  $x = -5 \dots 5$  is used.

$x_{\min} \dots x_{\max}$  is equivalent to the attributes XRange, XMin, XMax.

**y**

The second independent variable: an identifier on page 7-29 or an indexed identifier on page 1-1017.

y is equivalent to the attribute YName.

**$y_{\min}$  ..  $y_{\max}$**

The plot range in  $y$  direction:  $y_{\min}$ ,  $y_{\max}$  must be numerical real values or expressions of the animation parameter  $a$ . If not specified, the default range  $y = -5 \dots 5$  is used.

$y_{\min} \dots y_{\max}$  is equivalent to the attributes YRange, YMin, YMax.

**a**

Animation parameter, specified as  $a = a_{\min} \dots a_{\max}$ , where  $a_{\min}$  is the initial parameter value, and  $a_{\max}$  is the final parameter value.

## See Also

### MuPAD Functions

plot | plot::copy | plotfunc2d | plotfunc3d

### MuPAD Graphical Primitives

plot::Function2d | plot::Surface

## plot::Hatch

Hatched area

### Syntax

```
plot::Hatch(f1, f2, <x1 .. x2>, <a = amin .. amax>, options)
```

```
plot::Hatch(f1, <base>, <x1 .. x2>, <a = amin .. amax>, options)
```

```
plot::Hatch(c, <a = amin .. amax>, options)
```

### Description

`plot::Hatch(f)` hatches the area between the function `f` and the x-axis.

`plot::Hatch(f, base)` hatches the area between the function `f` and the horizontal line  $y = base$ .

`plot::Hatch(f, g)` hatches the area between the two functions `f` and `g`.

`plot::Hatch(c)` hatches the area enclosed by the curve `c`.

`plot::Hatch(f, base)` is the hatched area between a function `f` of type `plot::Function2d` and a line parallel to the x-axis with  $y = base$ . If `base` is omitted, the area between the function and the x-axis will be hatched (the baseline is assumed to be the x-axis). See “Example 1” on page 24-341 (Symbolic Math Toolbox).

`plot::Hatch(f1, f2)` is the hatched area between two functions on page 24-295 `f1` and `f2`. See “Example 2” on page 24-343 (Symbolic Math Toolbox).

`plot::Hatch(c)` is the hatched area enclosed by a `plot::Curve2d`. A curve is closed automatically by connecting the starting point and the end point. See “Example 3” on page 24-344 (Symbolic Math Toolbox).

The hatch may be restricted to the left and to the right by a range `x_ . . x_`. See “Example 4” on page 24-346 (Symbolic Math Toolbox).

The attributes FillColor on page 24-1953 and FillPattern on page 24-1981 can be used to change the color and pattern of the hatched area. See “Example 5” on page 24-351 (Symbolic Math Toolbox).

---

**Note** A plot::Hatch is only the hatched area *without* outlining functions or curves! To see the border lines, you need to plot them separately as demonstrated in the examples.

---

## Attributes

Attribute	Purpose	Default Value
AffectViewingBox	influence of objects on the ViewingBox of a scene	TRUE
AntiAliased	antialiased lines and points?	TRUE
Baseline	constant second function delimiting hatch	
Color	the main color	RGB::Red
FillColor	color of areas and surfaces	RGB::Red
FillPattern	type of area filling	DiagonalLines
Frames	the number of frames in an animation	50
Function1	first function/curve delimiting hatch	
Function2	second function delimiting hatch	
Legend	makes a legend entry	
LegendText	short explanatory text for legend	
LegendEntry	add this object to the legend?	FALSE
Name	the name of a plot object (for browser and legend)	

<b>Attribute</b>	<b>Purpose</b>	<b>Default Value</b>
ParameterEnd	end value of the animation parameter	
ParameterName	name of the animation parameter	
ParameterBegin	initial value of the animation parameter	
ParameterRange	range of the animation parameter	
TimeEnd	end time of the animation	10.0
TimeBegin	start time of the animation	0.0
TimeRange	the real time span of an animation	0.0 .. 10.0
Title	object title	
TitleFont	font of object titles	[" sans-serif ", 11]
TitlePosition	position of object titles	
TitleAlignment	horizontal alignment of titles w.r.t. their coordinates	Center
TitlePositionX	position of object titles, x component	
TitlePositionY	position of object titles, y component	
Visible	visibility	TRUE
VisibleAfter	object visible after this time value	
VisibleBefore	object visible until this time value	
VisibleFromTo	object visible during this time range	
VisibleAfterEnd	object visible after its animation time ended?	TRUE

Attribute	Purpose	Default Value
VisibleBeforeBegin	object visible before its animation time starts?	TRUE
XMax	final value of parameter "x"	infinity
XMin	initial value of parameter "x"	-infinity
XRange	range of parameter "x"	-infinity .. infinity

## Examples

### Example 1

If given a single `plot::Function2d` object, `plot::Hatch` hatches the area between the curve and the x-axis:

```
f := plot::Function2d(sin(x), x = -PI..PI):
plot(plot::Hatch(f), f)
```

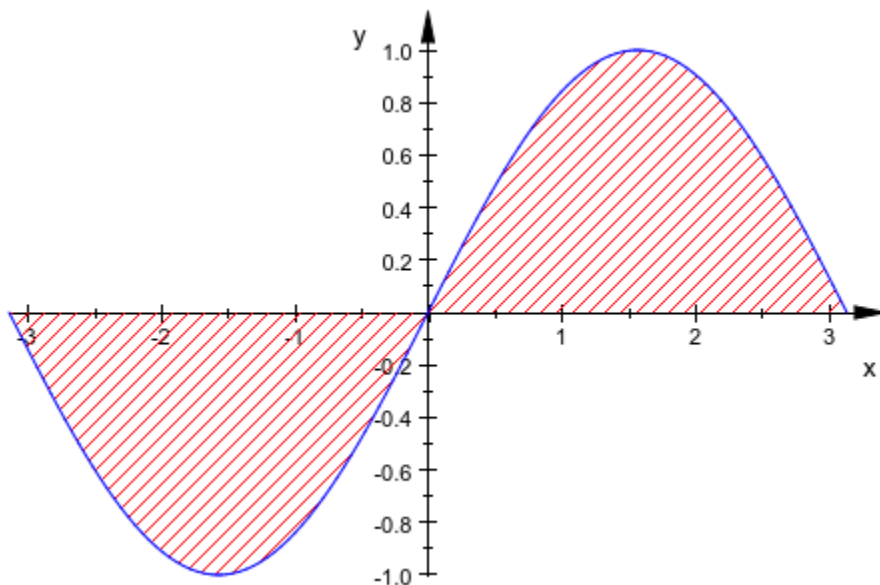

Note that `plot::Hatch` requires an *object* of type `plot::Function2d`, not just a function expression:

```
plot::Hatch(sin(x))
```

Error: Missing argument of type 'plot::Function2d' or 'plot::Curve2d'. [plot::Hatch::m

`plot::Hatch` can be asked to hatch the area between a function graph and some constant value (i.e., some line parallel to the x-axis):

```
plot(plot::Hatch(f, 1), f)
```

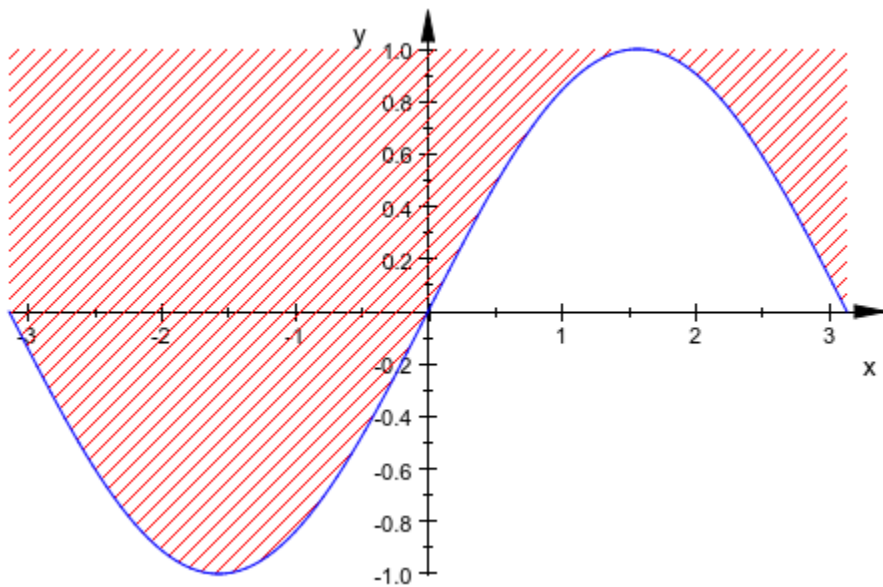

For functions with poles, keeping `VerticalAsymptotesVisible` set to `TRUE` is highly recommended:

```
f := plot::Function2d(1/(x - 1)):
h := plot::Hatch(f):
plot(f, h)
```

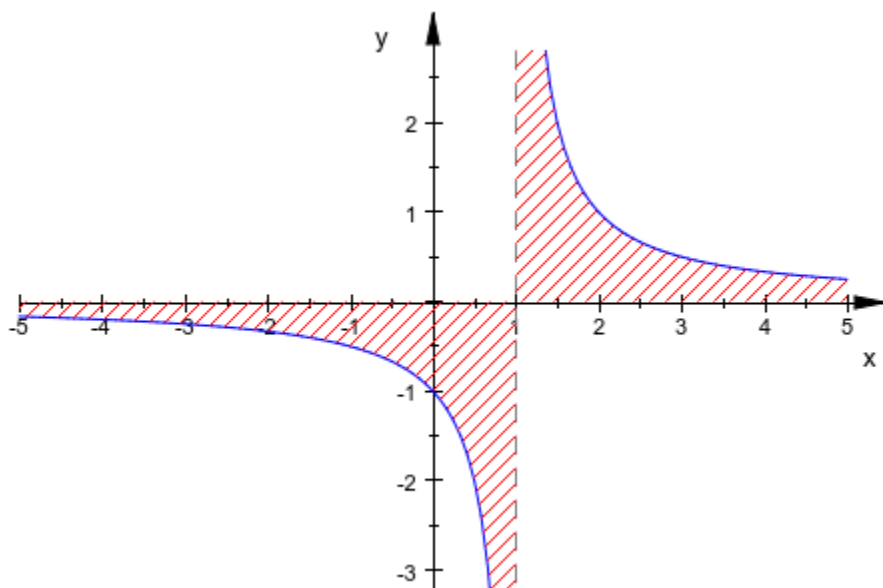

```
delete f, h:
```

## Example 2

By passing two functions to `plot::Hatch`, we ask for a hatch of the area between the two:

```
f := plot::Function2d(sin(x), x = -4 .. 4, Color = RGB::Blue):  
g := plot::Function2d(cos(2*x), x = -4 .. 4, Color=RGB::Black):  
h := plot::Hatch(f, g):  
plot(f, g, h)
```

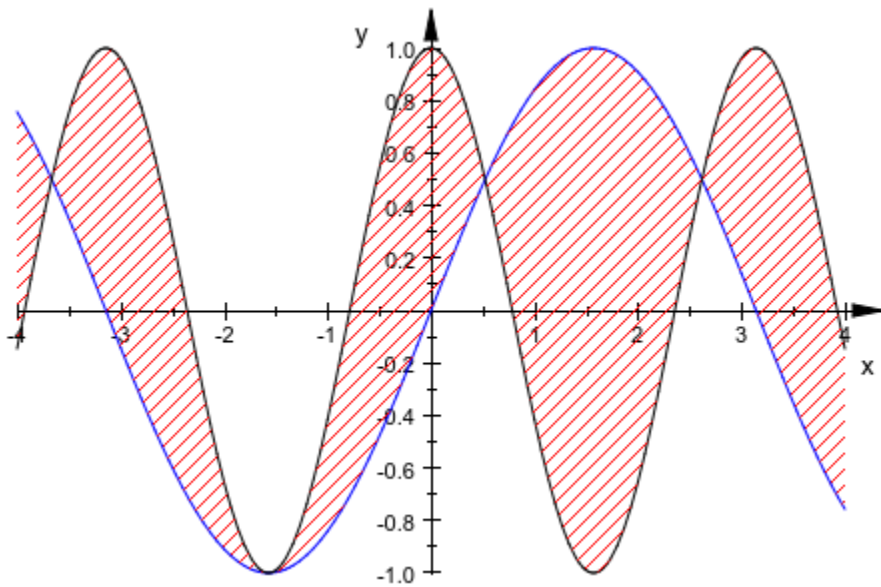

```
delete f, g, h:
```

### Example 3

`plot::Hatch` can also hatch the inner part of a `plot::Curve2d` object:

```
circle := plot::Curve2d([sin(t), cos(t)], t=0..2*PI):  
plot(circle, plot::Hatch(circle))
```



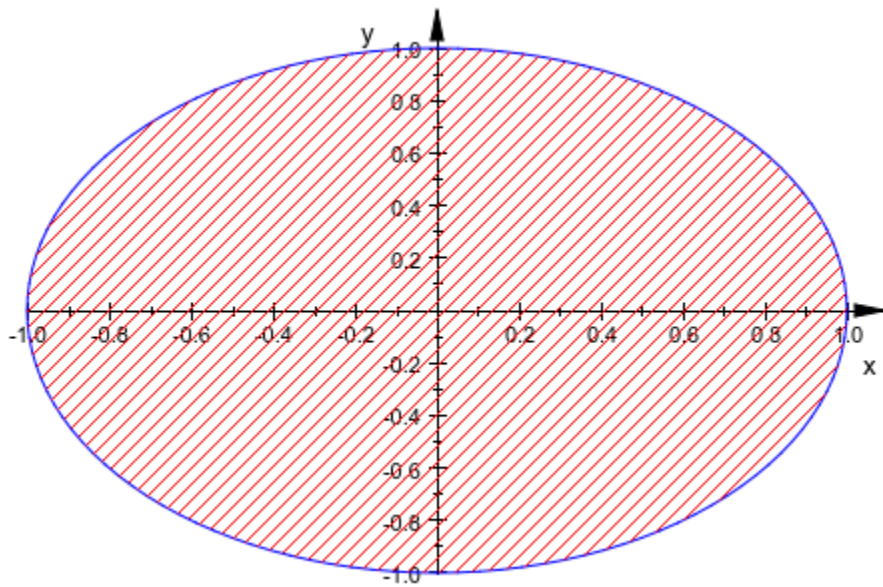

If the curve is not closed, `plot::Hatch` regards the first and last point to be connected:

```
circle::UMax := 3*PI/2:  
plot(circle, plot::Hatch(circle))
```

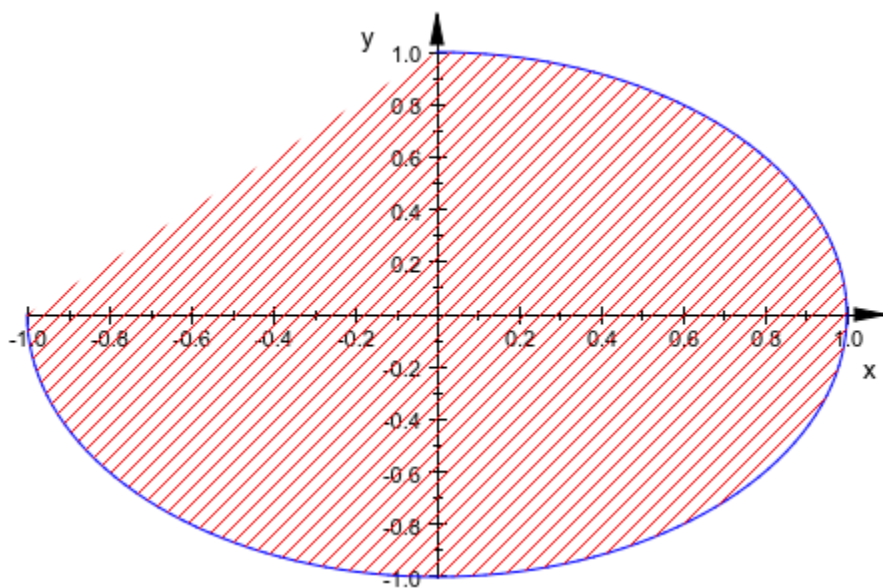

`delete circle:`

#### Example 4

By default, `plot::Hatch` extends as far to the left and right as possible without leaving the common definition area of all given functions:

```
f := plot::Function2d(sin(x), x = 0 .. 5):  
g := plot::Function2d(-cos(x), x = -1 .. 4):  
h := plot::Hatch(f, g):  
plot(f, g, h)
```

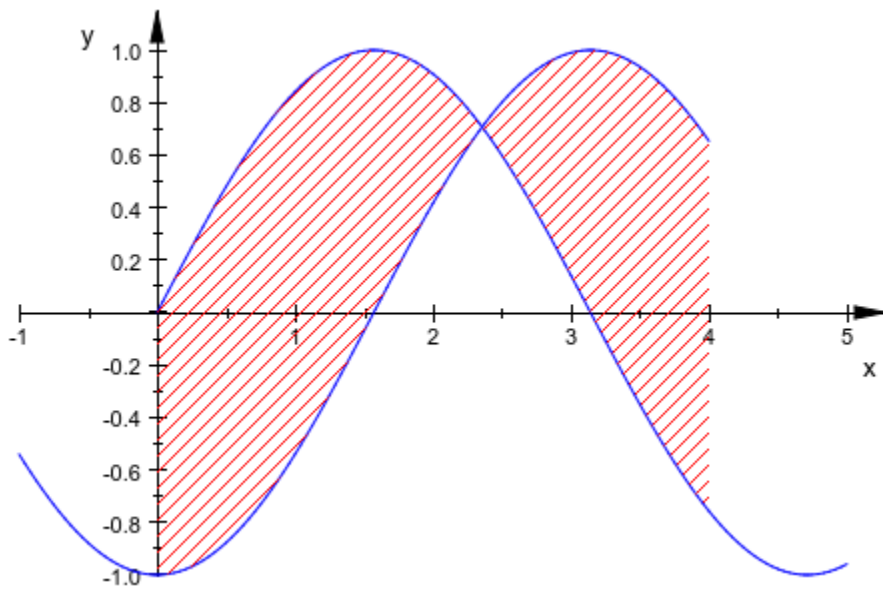

You can restrict this range by giving an explicit range of x values:

```
h := plot::Hatch(f, g, 1 .. 3):  
plot(f, g, h)
```

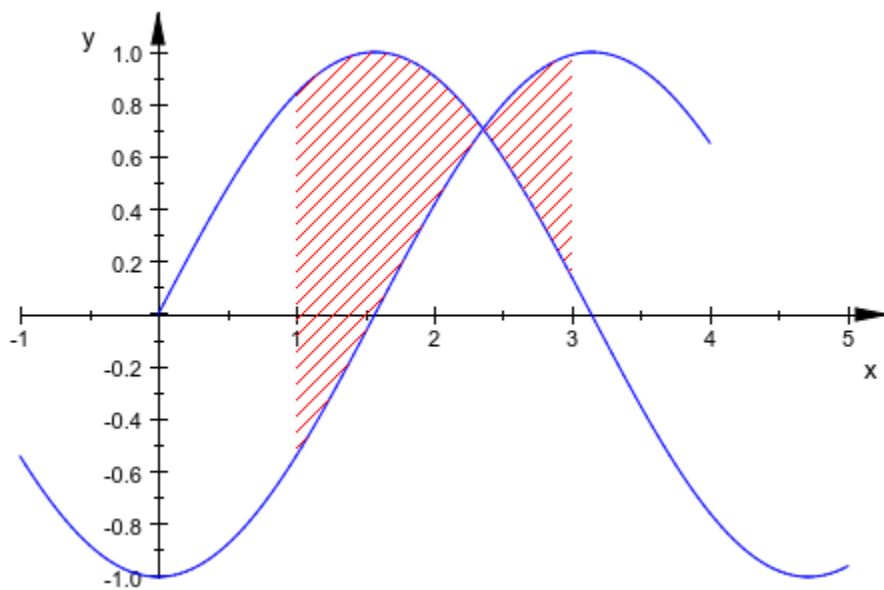

However, it is *not* possible to extend the range beyond the common definition range of both functions:

```
h := plot::Hatch(f, g, -1 .. 3):  
plot(f, g, h)
```

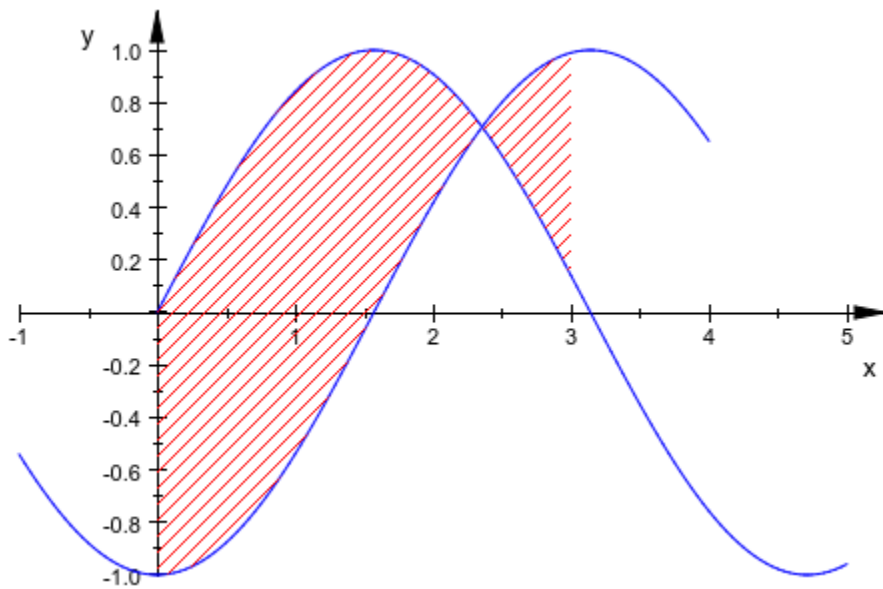

The restriction of the x range also works for hatching curve objects:

```
c := plot::Curve2d([sin(5*x), cos(7*x)], x = 0 .. 2*PI):  
h := plot::Hatch(c, 0 .. 1):  
plot(c, h)
```

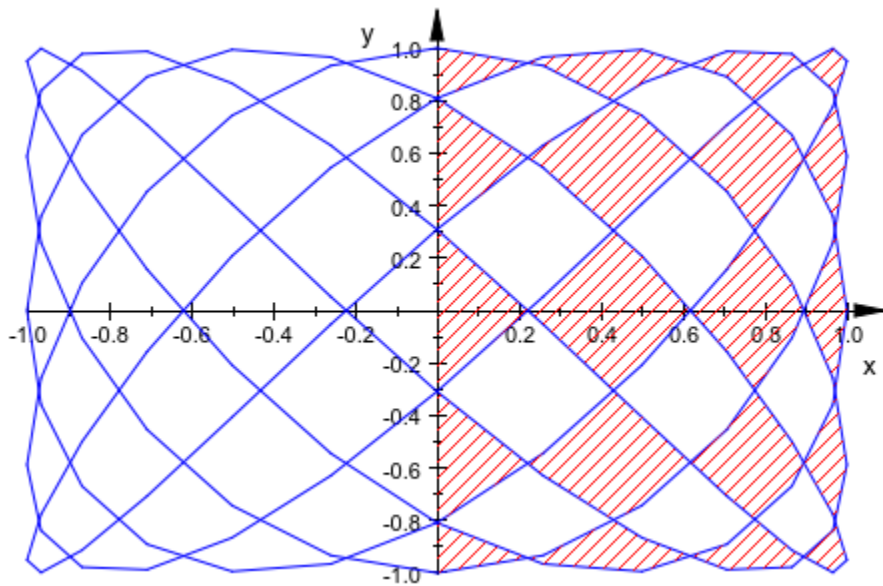

Note that `plot::Hatch` reacts to the smoothness of the curve. This is one of the reasons why you have to provide a *objects* instead of expressions for the functions or curves:

```
c::AdaptiveMesh := 2:  
plot(c, h)
```

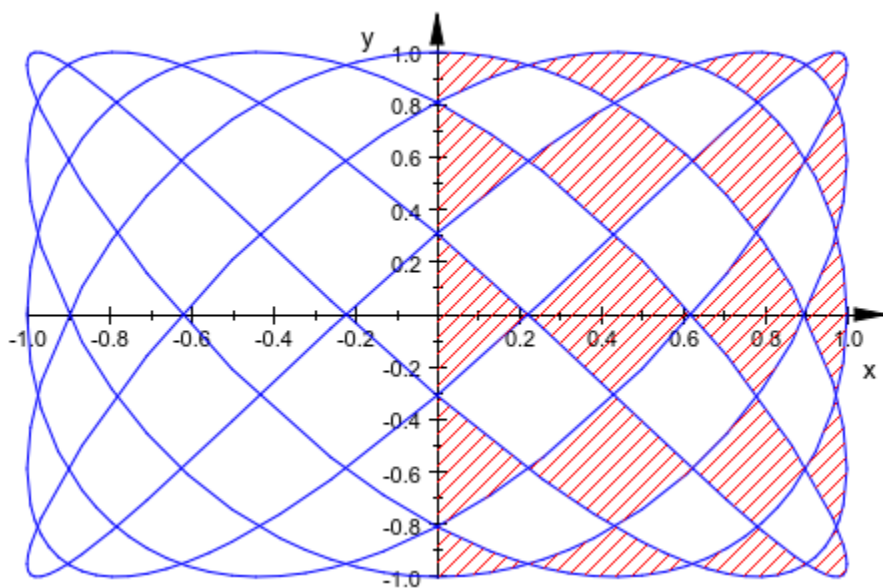

```
delete f, g, h, c:
```

## Example 5

One of the most useful attributes of `plot::Hatch` is `FillPattern`, which can take one of the values `DiagonalLines` (the default), `FDiagonalLines`, `HorizontalLines`, `VerticalLines`, `CrossedLines`, `XCrossedLines`, or `Solid`:

```
f := plot::Function2d(sin(x)):
h := plot::Hatch(f, FillPattern = VerticalLines):
plot(f, h)
```

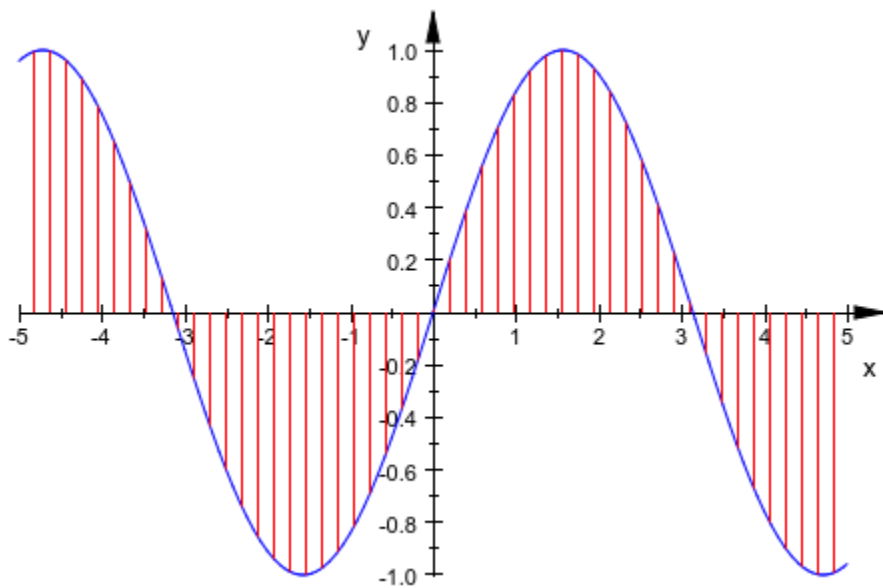

Another attribute that will often be useful is `FillColor`, to change the color of the hatch. We set the value right in our existing hatch object:

```
h::FillPattern := CrossedLines:  
h::FillColor := RGB::Blue:  
plot(f, h)
```



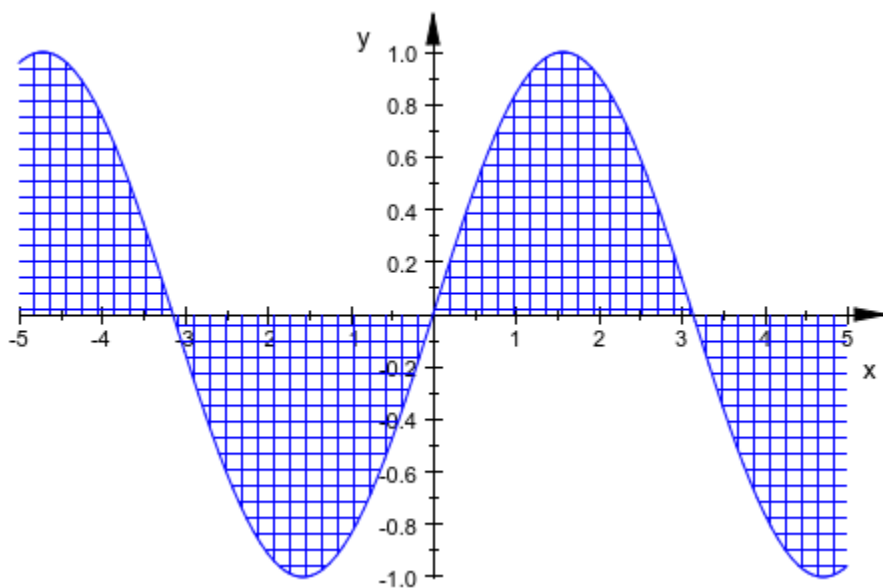

delete f, h:

## Example 6

The function(s) or curve, the baseline, and the restriction of the x range can be animated:

```
f := plot::Function2d(sin(x + a), x = -PI..PI, a = 0..2*PI):
g := plot::Function2d(cos(x - a), x = -PI..PI, a = 0..4*PI):
plot(f, g, plot::Hatch(f, g, x0 .. x0+1, x0 = -PI..3))
```

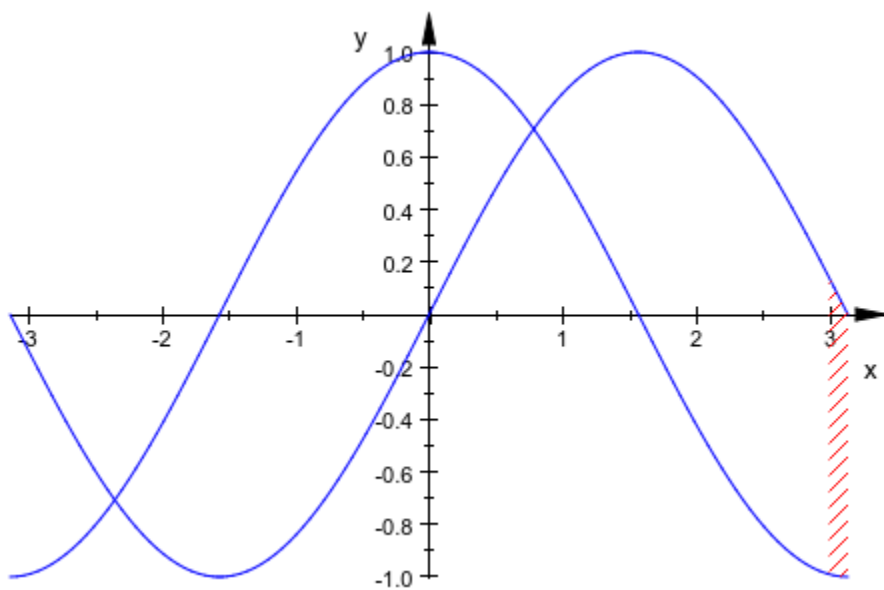

```
f := plot::Function2d(sin(a*x), x=-PI..PI, a=0.2..3):  
plot(f, plot::Hatch(f))
```

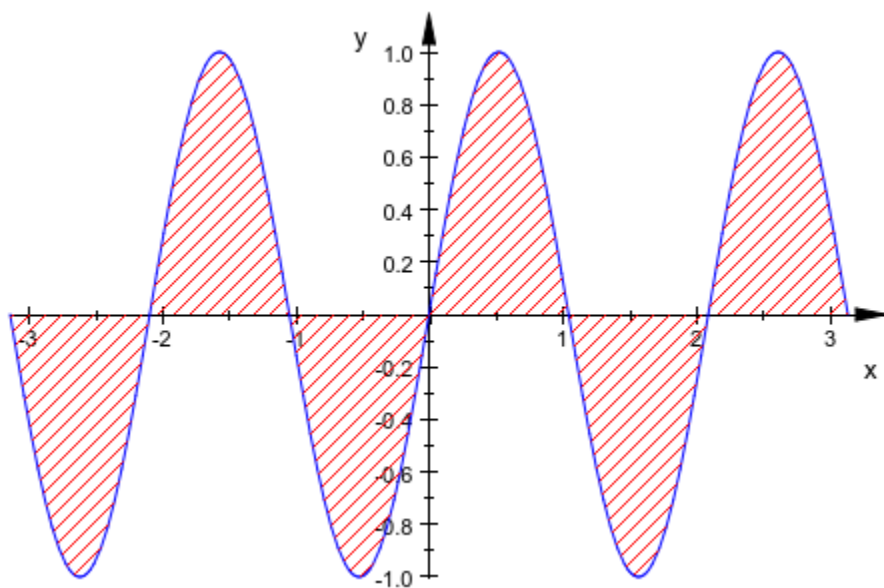

delete f, g:

## Example 7

A “hatch” may also be a solid area fill:

```
plot(plot::Hatch(  
  plot::Curve2d([abs(r)*sin(r), abs(r)*cos(r)], r = -PI..PI),  
  FillPattern = Solid, FillColor = RGB::Red, Axes = None))
```



## Parameters

**$f_1, f_2$**

The outlining function(s) of the hatch: objects of type `plot::Function2d`.

$f_1, f_2$  are equivalent to the attributes `Function1`, `Function2`.

**$c$**

The outlining curve of the hatch: a parametrized curve of type `plot::Curve2d`.

$c$  is equivalent to the attribute `Function1`.

**base**

The base line of the hatch: a numerical real value or an arithmetical expression (Symbolic Math Toolbox) of the animation parameter  $a$ .

base is equivalent to the attribute `Baseline`.

$x_1 \dots x_2$

A range on the x-axis limiting the hatch to the left and the right hand side: numerical real values or arithmetical expressions (Symbolic Math Toolbox) of the animation parameter  $a$ .

$x_1 \dots x_2$  is equivalent to the attributes XMin, XMax, XRange.

**a**

Animation parameter, specified as  $a = a_{\min} \dots a_{\max}$ , where  $a_{\min}$  is the initial parameter value, and  $a_{\max}$  is the final parameter value.

## See Also

### MuPAD Functions

plot | plot::copy

### MuPAD Graphical Primitives

plot::Curve2d | plot::Function2d | plot::Sweep

## plot::Histogram2d

Histogram plots of data

### Syntax

```
plot::Histogram2d(data, <a = amin .. amax>, options)
```

### Description

`plot::Histogram2d` creates a histogram plot of the given data, showing the frequency distribution in a user-definable cell array.

By default, data is grouped into 7 classes of equal width. To increase the number of cells, but still have them be of equal width, set `Cells = [n]`, as in “Example 1” on page 24-361 (Symbolic Math Toolbox). For full control over the classes, set `Cells` to a list specifying the cells, as in “Example 2” on page 24-364 (Symbolic Math Toolbox).

As long as the attribute `Area` is not changed from its default value of 0, `plot::Histogram2d` displays the absolute number of data in a class as the height of the corresponding bar. With `Area = a`,  $a > 0$ , the whole plot will take area  $a$ , with each rectangle area proportional to the number of data points in its cell. “Example 3” on page 24-366 (Symbolic Math Toolbox) shows the difference in detail.

By default, cells (“classes”) given by the attribute `Cells = [a1 .. b1, a2 ..`

`b2, dots]` are interpreted as a collection of semi-open intervals  $(a_i, b_i]$  that are closed at the right boundary. A data item  $x$  is tallied into the  $i$ -th cell if it satisfies  $a_i < x \leq b_i$ . Use the option `CellsClosed = Left` or the equivalent `ClassesClosed = Left` to

interpret the classes as the semi-open intervals  $[a_i, b_i)$  that are closed at the left boundary.

## Attributes

Attribute	Purpose	Default Value
AffectViewingBox	influence of objects on the ViewingBox of a scene	TRUE
AntiAliased	antialiased lines and points?	TRUE
Area	the area of a histogram plot	0
Cells	classes of histogram plots	[7]
CellsClosed	interpretation of the classes in histogram plots	Right
ClassesClosed	interpretation of the classes in histogram plots	[Right]
Color	the main color	RGB::GeraniumLake
Data	the (statistical) data to plot	
DrawMode	orientation of boxes and bars	Vertical
Filled	filled or transparent areas and surfaces	TRUE
FillColor	color of areas and surfaces	RGB::GeraniumLake
FillPattern	type of area filling	Solid
Frames	the number of frames in an animation	50
Legend	makes a legend entry	
LegendText	short explanatory text for legend	
LegendEntry	add this object to the legend?	FALSE
LineColor	color of lines	RGB::Black
LineWidth	width of lines	0.35
LineStyle	solid, dashed or dotted lines?	Solid

<b>Attribute</b>	<b>Purpose</b>	<b>Default Value</b>
LinesVisible	visibility of lines	TRUE
Name	the name of a plot object (for browser and legend)	
ParameterEnd	end value of the animation parameter	
ParameterName	name of the animation parameter	
ParameterBegin	initial value of the animation parameter	
ParameterRange	range of the animation parameter	
PointSize	the size of points	1.5
PointStyle	the presentation style of points	FilledCircles
TimeEnd	end time of the animation	10.0
TimeBegin	start time of the animation	0.0
TimeRange	the real time span of an animation	0.0 .. 10.0
Title	object title	
TitleFont	font of object titles	[" sans-serif ", 11]
TitlePosition	position of object titles	
TitleAlignment	horizontal alignment of titles w.r.t. their coordinates	Center
TitlePositionX	position of object titles, x component	
TitlePositionY	position of object titles, y component	
Visible	visibility	TRUE
VisibleAfter	object visible after this time value	



Attribute	Purpose	Default Value
VisibleBefore	object visible until this time value	
VisibleFromTo	object visible during this time range	
VisibleAfterEnd	object visible after its animation time ended?	TRUE
VisibleBeforeBegin	object visible before its animation time starts?	TRUE

## Examples

### Example 1

To plot a histogram of a normally distributed process, we first create a generator of random numbers with this distribution:

```
X := stats::normalRandom(0, 1)
```

```
proc X() ... end
```

Next, we create a small number of “measurements”:

```
data := [X() $ i = 1..20]
```

```
[-0.5297400457, -0.5694234147, -0.5161446272, -1.090814471, 1.782520584,
 0.6370330472, 0.6902341601, 0.3399758858,
 1.177699186, -0.5970692982, -1.386247581, -0.9783222199, -0.7891413081,
 0.2090732178, 0.2186783746, -0.7392138209, 0.6496128588, 0.6258699055,
 3.606896706, -0.3319378999]
```

This data is ready to be put into plot::Histogram2d:

```
plot(plot::Histogram2d(data))
```

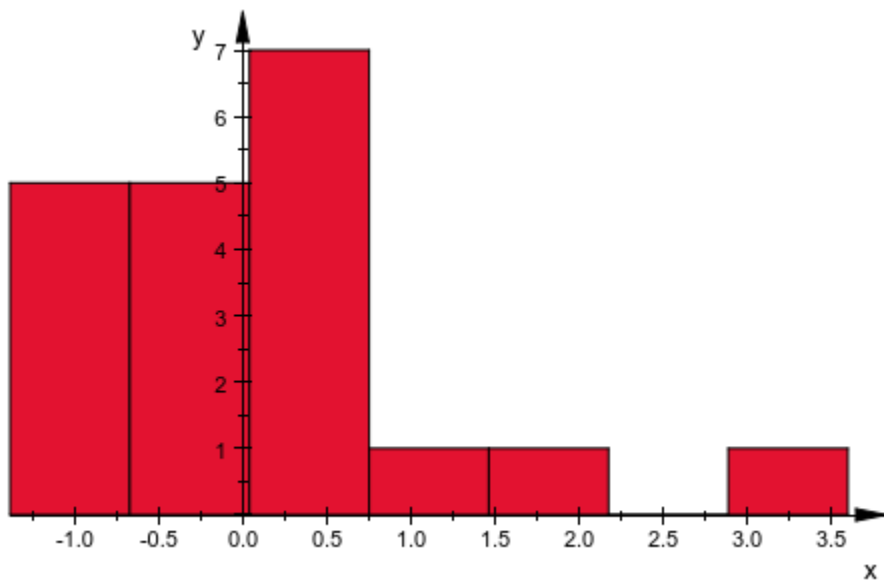

This plot, if nothing else, shows that 20 samples are very few. Let us repeat the process with more data:

```
data := [X() $ i = 1..300]:  
plot(plot::Histogram2d(data))
```

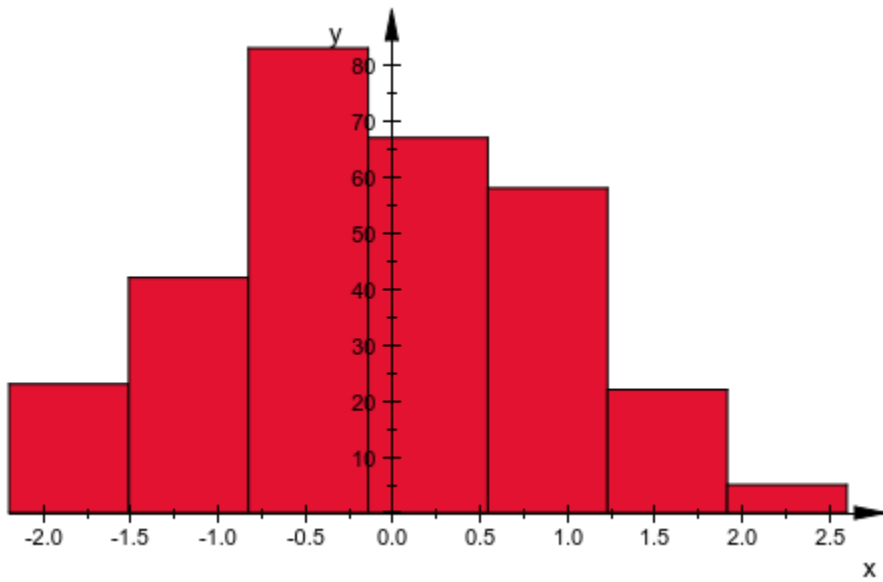

On the other hand, this amount of data certainly justifies a finer classification:

```
plot(plot::Histogram2d(data, Cells = [15]))
```

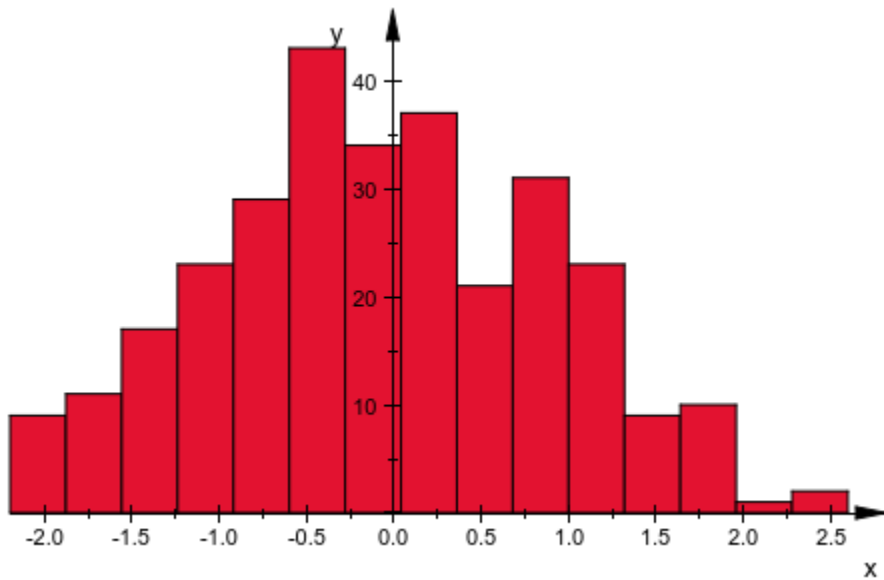

## Example 2

It is also possible to give the cells (classes) directly. To do so, you should give them as ranges on page 1-16 or lists with two elements, as in the following example:

```
X := stats::normalRandom(0, 1):  
data := [X() $ i = 1 .. 100]:  
min(data), max(data)
```

```
-3.266420216, 2.409775834
```

```
h := plot::Histogram2d(data,  
    Cells = [-2.5..-1.5, -1.5..-1, -1..0,  
            0..1, 1..1.5, 1.5..2.5])
```

```
plot::Histogram2d(...)
```

```
plot(h)
```

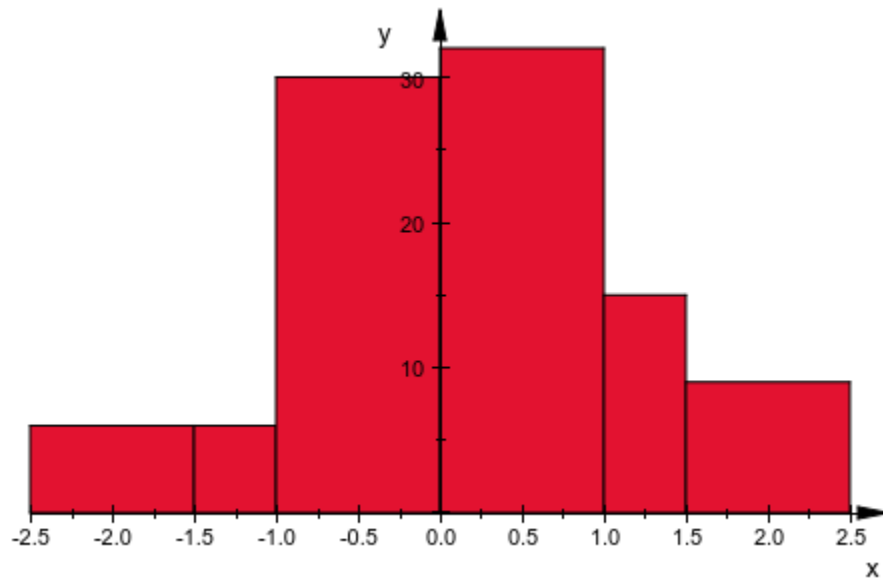

It is even possible to use `-infinity` and `infinity` as border values in the cells:

```
h::Cells := [-infinity..-2, -2..-1, -1..0,  
             0..1, 1..2, 2..infinity]:  
plot(h)
```

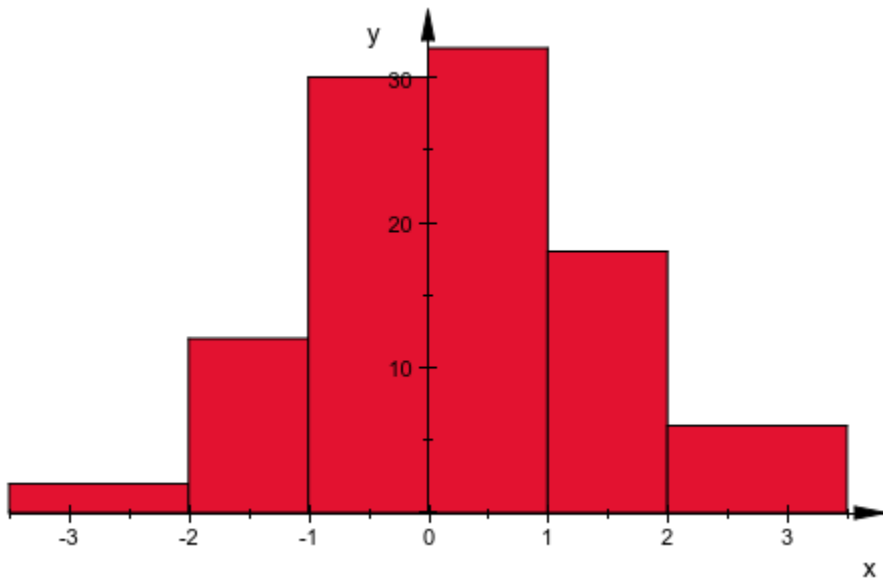

### Example 3

One potential problem with classes of non-equal width is that still the *height* of the bars corresponds to the *number* of data points in a class. To see why this may be a problem, consider data perfectly uniformly distributed:

```
data := [i/1000 $ i = 1..1000]:
```

Plotting a histogram of this data, we see only very small deviations from a rectangle, caused by the fact that 1000 and 7 are coprime:

```
plot(plot::Histogram2d(data))
```

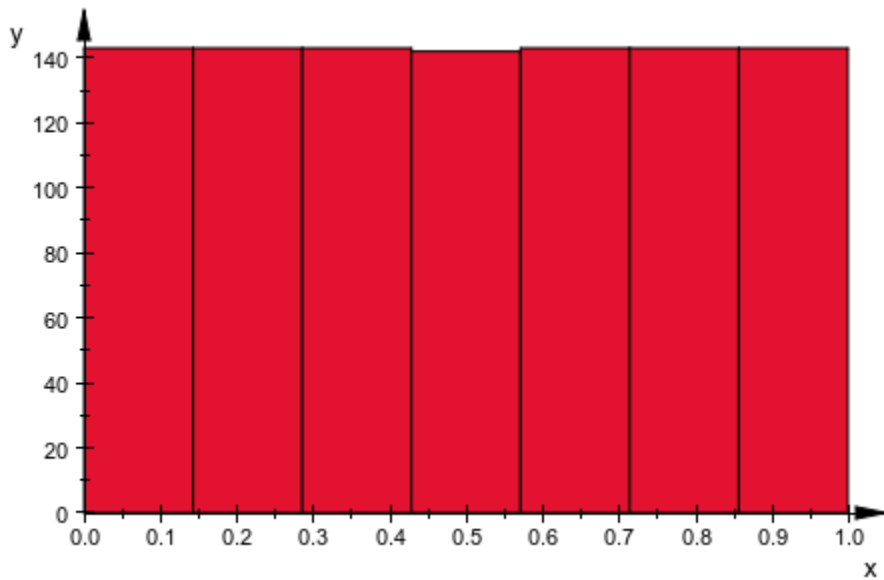

However, plotting a histogram with uneven classes, the image looks very much different:

```
plot(plot::Histogram2d(data,  
  Cells = [0..1/2, 1/2..2/3, 2/3..3/4, 3/4..4/5, 4/5..1]))
```

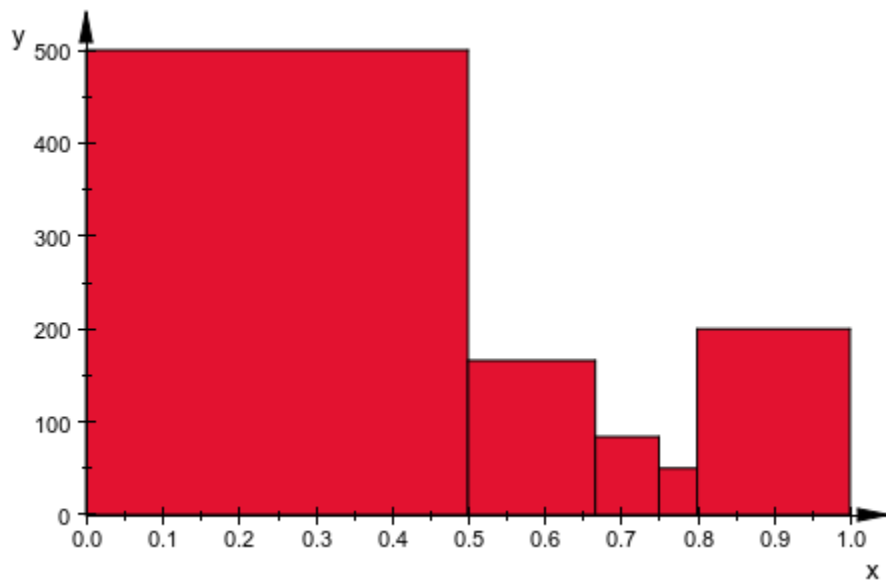

To make not the *height*, but rather the *area* of a bar depend on the number of samples in a class, set `Area` to a positive value:

```
plot(plot::Histogram2d(data,  
  Cells = [0..1/2, 1/2..2/3, 2/3..3/4, 3/4..4/5, 4/5..1],  
  Area = 1))
```



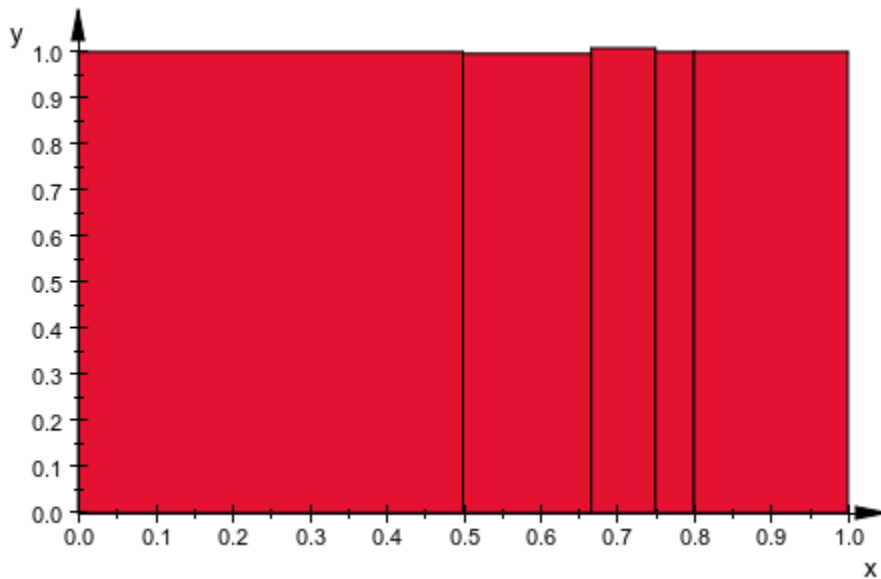

Note that with `Area = 1`, a histogram plot is scaled accordingly to the probability density function of the variable displayed:

```
X := stats::normalRandom(0, 1):
data := [X() $ i = 1..1000]:
h := plot::Histogram2d(data, Cells = [15],
                      Area = 1, Color = RGB::Blue):
f := plot::Function2d(stats::normalPDF(0, 1),
                    x = -3..3, LineWidth = 1*unit::mm,
                    Color = RGB::Black):
plot(h, f)
```

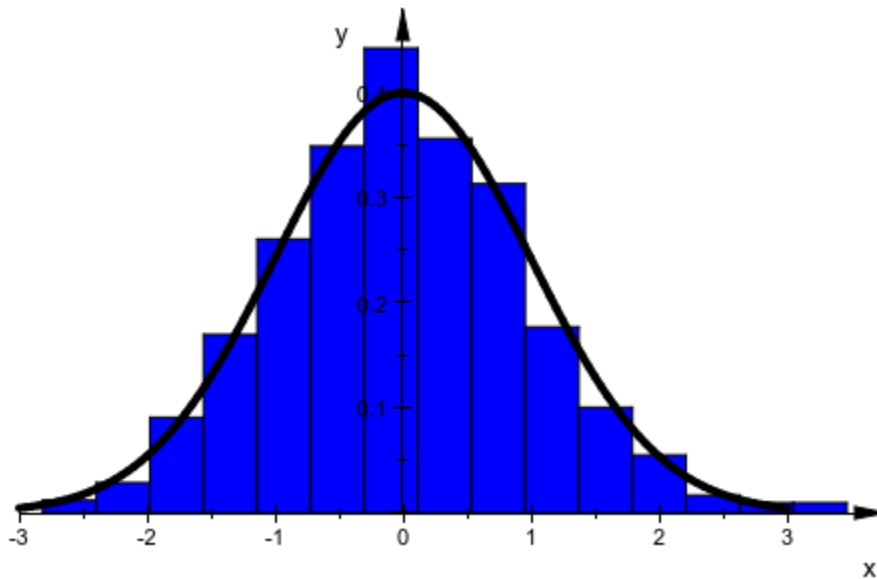

`delete X, data, h, f:`

## Parameters

### **data**

The data to plot: A list of real values or expressions in the animation parameter  $a$ .

`data` is equivalent to the attribute `Data`.

### **a**

Animation parameter, specified as  $a = a_{\min} \dots a_{\max}$ , where  $a_{\min}$  is the initial parameter value, and  $a_{\max}$  is the final parameter value.

## See Also

### **MuPAD Functions**

`plot` | `plot::copy` | `stats::frequency`

**MuPAD Graphical Primitives**

plot::Bars2d | plot::Boxplot | plot::Scatterplot

## plot::Implicit2d

Contour lines of a function from  $R^2$  to  $R$

### Syntax

```
plot::Implicit2d(f, x = x_min .. x_max, y = y_min .. y_max, <a = a_min .. a_max>, options)
```

### Description

`plot::Implicit2d(f(x, y), x = x_min..x_max , y = y_min..y_max )` plots the curves where the smooth function  $f$  is zero.

`plot::Implicit2d(f, x = x_min..x_max , y = y_min..y_max )` plots the zeroes of  $f$  in the given range, i.e., the set  $\{(x, y) \mid x_{\min} \leq x \leq x_{\max}, y_{\min} \leq y \leq y_{\max}, f(x, y) = 0\}$ .

`plot::Implicit2d` assumes that  $f$  is *regular almost everywhere* on this curve, which means that  $f$  must be differentiable and at least one of its partial derivatives must be nonzero.

To plot other contours than zeroes, use the option `Contours`.

### Attributes

Attribute	Purpose	Default Value
<code>AffectViewingBox</code>	influence of objects on the <code>ViewingBox</code> of a scene	TRUE
<code>AntiAliased</code>	antialiased lines and points?	TRUE
<code>Color</code>	the main color	RGB::Blue
<code>Contours</code>	the contours of an implicit function	[0]

Attribute	Purpose	Default Value
Frames	the number of frames in an animation	50
Function	function expression or procedure	
Legend	makes a legend entry	
LegendText	short explanatory text for legend	
LegendEntry	add this object to the legend?	TRUE
LineColor	color of lines	RGB::Blue
LineWidth	width of lines	0.35
LineColor2	color of lines	RGB::DeepPink
LineStyle	solid, dashed or dotted lines?	Solid
LinesVisible	visibility of lines	TRUE
LineColorType	line coloring types	Flat
LineColorFunction	functional line coloring	
LineColorDirection	the direction of color transitions on lines	[0, 1]
LineColorDirectionX	x-component of the direction of color transitions on lines	0
LineColorDirectionY	y-component of the direction of color transitions on lines	1
Mesh	number of sample points	[11, 11]
Name	the name of a plot object (for browser and legend)	
ParameterEnd	end value of the animation parameter	
ParameterName	name of the animation parameter	

Attribute	Purpose	Default Value
ParameterBegin	initial value of the animation parameter	
ParameterRange	range of the animation parameter	
TimeEnd	end time of the animation	10.0
TimeBegin	start time of the animation	0.0
TimeRange	the real time span of an animation	0.0 .. 10.0
Title	object title	
TitleFont	font of object titles	[" sans-serif ", 11]
TitlePosition	position of object titles	
TitleAlignment	horizontal alignment of titles w.r.t. their coordinates	Center
TitlePositionX	position of object titles, x component	
TitlePositionY	position of object titles, y component	
Visible	visibility	TRUE
VisibleAfter	object visible after this time value	
VisibleBefore	object visible until this time value	
VisibleFromTo	object visible during this time range	
VisibleAfterEnd	object visible after its animation time ended?	TRUE
VisibleBeforeBegin	object visible before its animation time starts?	TRUE
XMax	final value of parameter "x"	
XMesh	number of sample points for parameter "x"	11

Attribute	Purpose	Default Value
XMin	initial value of parameter "x"	
XName	name of parameter "x"	
XRange	range of parameter "x"	
YMax	final value of parameter "y"	
YMesh	number of sample points for parameter "y"	11
YMin	initial value of parameter "y"	
YName	name of parameter "y"	
YRange	range of parameter "y"	

## Examples

### Example 1

It is well-known that a circle can be described as  $\{(x, y) \mid x^2 + y^2 = r^2\}$ :

```
plot(plot::Implicit2d(x^2+y^2-1, x = -1..1, y = -1..1))
```

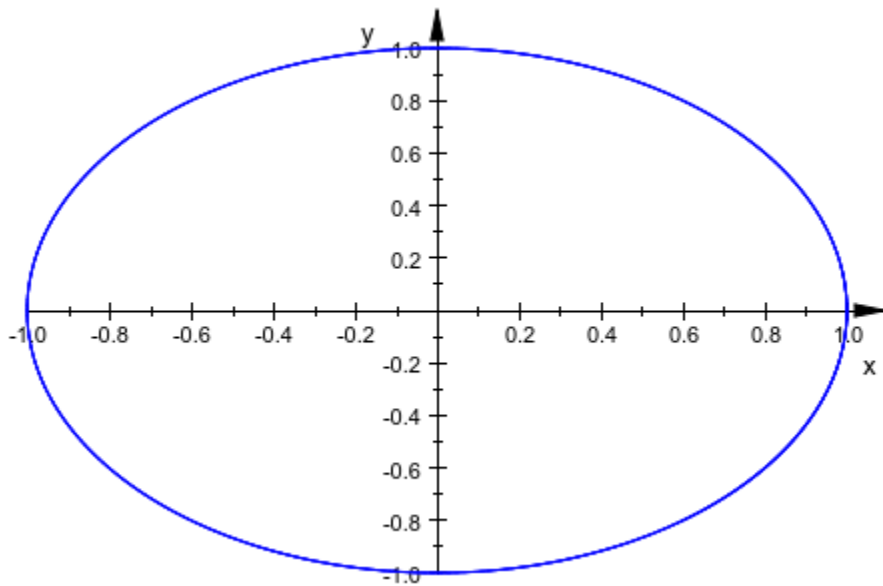

Note that `plot::Implicit2d` uses the given range completely, even if there is nothing to plot at a border:

```
plot(plot::Implicit2d(x^2+y^2-1, x = -2..2, y = -2..2))
```



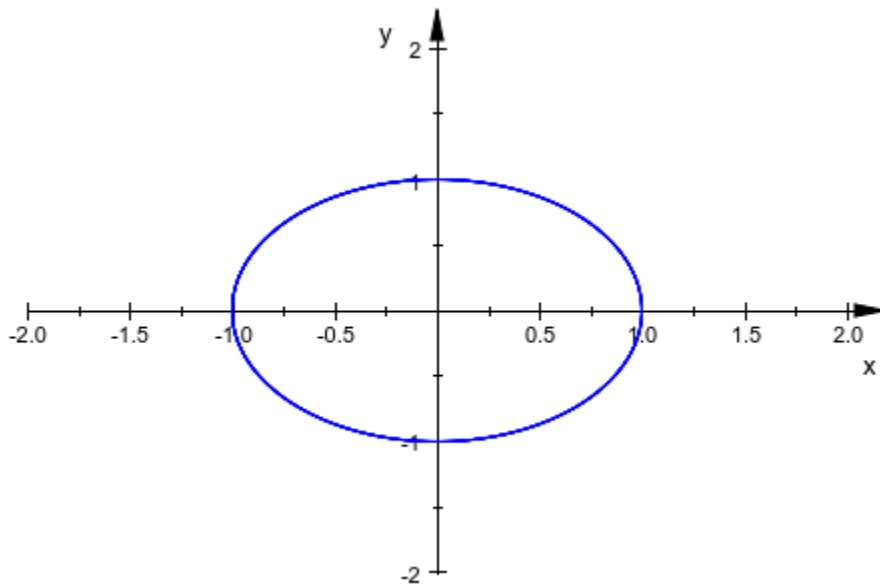

## Example 2

`plot::Implicit2d` handles functions which are not regular at isolated points on the contours:

```
plot(plot::Implicit2d((x-y)*(x+y), x = -1..1, y = -1..1))
```

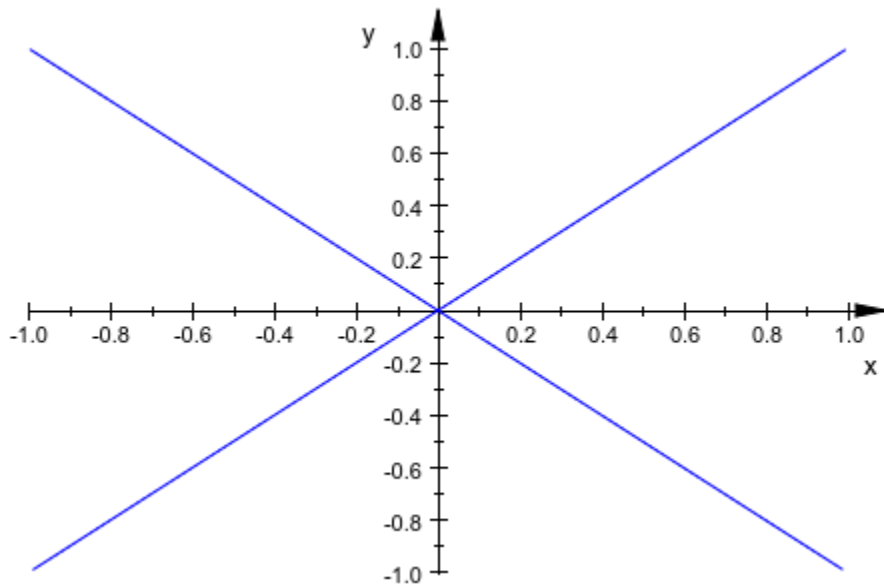

However, it fails if the function is singular on more than isolated points:

```
plot(plot::Implicit2d(0, x = -1..1, y = -1..1))
```

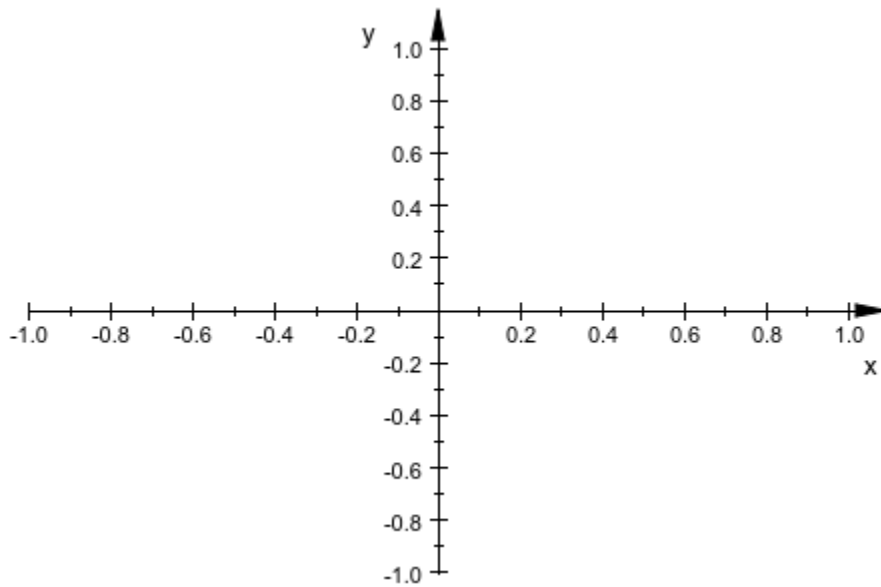

### Example 3

We plot some of the elliptic curves  $y^2 = x^3 + 4x + c$ :

```
plot(plot::Implicit2d(y^2 - x^3 + 4*x, x = -3..3, y = -4..4,  
  Contours = [c $ c = -3..6]))
```

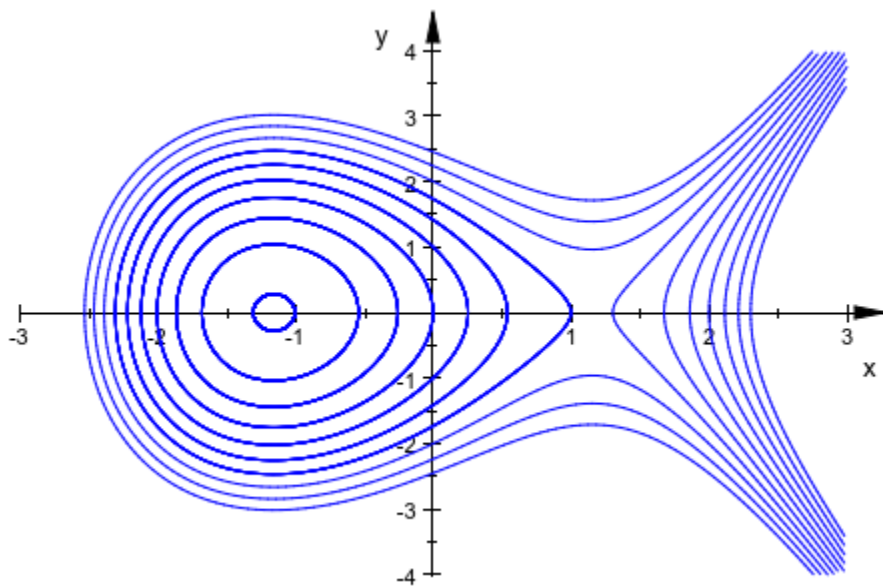

### Example 4

Like most graphical objects, `plot::Implicit2d` can be animated easily:

```
plot(plot::Implicit2d(x^2 - y^2 = (x - a*y)*(x^2 + y^2),  
                    x = -2..2, y = -2..2, a = -2..2))
```

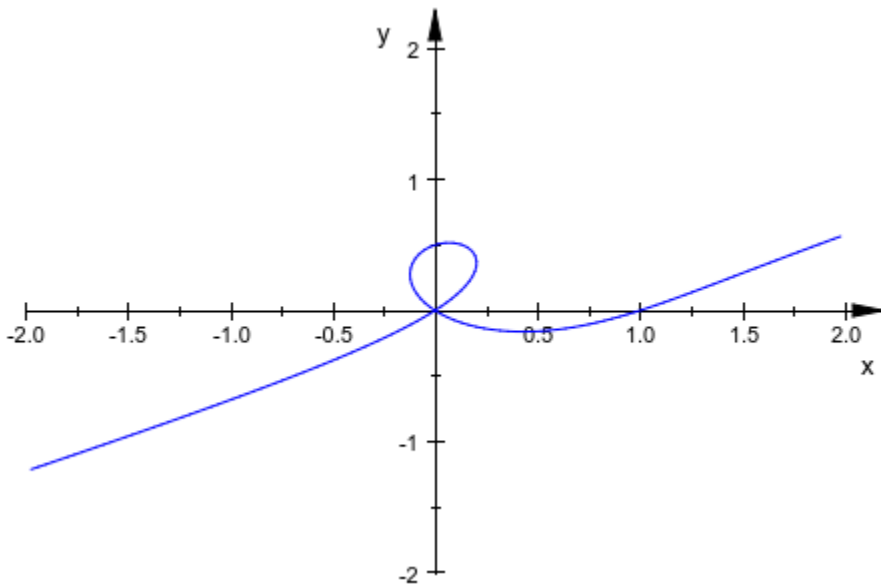

## Parameters

**f**

A real-valued expression or an equation in  $x$ ,  $y$ , and possibly the animation parameter.

$f$  is equivalent to the attribute `Function`.

**x, y**

identifiers on page 7-29.

$x$ ,  $y$  are equivalent to the attributes `XName`, `YName`.

**$x_{min}$  ..  $x_{max}$ ,  $y_{min}$  ..  $y_{max}$**

Real-valued expressions, possibly in the animation parameter. The image is plotted with  $x$  in the range  $x_{min} \leq x \leq x_{max}$  and  $y_{min} \leq y \leq y_{max}$ .

$x_{\min} .. x_{\max}, y_{\min} .. y_{\max}$  are equivalent to the attributes XRange, XMin, XMax, YRange, YMin, YMax.

**a**

Animation parameter, specified as  $a = a_{\min} .. a_{\max}$ , where  $a_{\min}$  is the initial parameter value, and  $a_{\max}$  is the final parameter value.

## Algorithms

`plot::Implicit2d` uses a curve tracking method: It first generates starting points on the curve and then uses a predictor-corrector method to follow the curve thus found in both directions, using the implicit function theorem.

## See Also

**MuPAD Functions**

`plot` | `plot::copy`

**MuPAD Graphical Primitives**

`plot::Curve2d` | `plot::Implicit3d`

# plot::Implicit3d

Contour surfaces of a function from  $\mathbb{R}^3$  to  $\mathbb{R}$

## Syntax

```
plot::Implicit3d(f, x = x_min .. x_max, y = y_min .. y_max, z = z_min .. z_max, <a = a_min .. a_max>, C
```

## Description

`plot::Implicit3d(f(x, y, z), x = x_min..x_max, y = y_min..y_max, z = z_min..z_max)` plots the surfaces where the smooth function  $f$  is zero.

`plot::Implicit3d(f, x = x_min..x_max, y = y_min..y_max, z = z_min..z_max)` plots the (two-dimensional part of the) zeroes of  $f$  in the given range, i.e., the set

$$\{(x, y, z) \mid x_{\min} \leq x \leq x_{\max}, y_{\min} \leq y \leq y_{\max}, z_{\min} \leq z \leq z_{\max}, f(x, y, z) = 0\}.$$

`plot::Implicit3d` assumes that  $f$  is *regular almost everywhere* on this surface, which means that  $f$  must be differentiable and at least two of its partial derivatives must be nonzero.

`plot::Implicit3d` evaluates the given function on an equidistant, three-dimensional mesh, the coarsity of which can be set with the attributes `XMesh`, `YMesh`, and `ZMesh` for each of the three directions, or with the combining attribute `Mesh` that sets all three of these simultaneously.

After finding an initial triangulation of the surface from the numerical data on the initial grid, `plot::Implicit3d` optionally performs adaptive subdivision of the triangles. To make a long story short: If the initial calculation misses details altogether, adaptive refinement will not find them either. On the other hand, if the initial calculation shows spurious spikes, adaptive refinement will result in a much more realistic image, at the expense of time; the higher the value of `AdaptiveMesh`, the more. Increasing `AdaptiveMesh` by one may in extreme cases increase calculation time by a factor of eight or more!

The details of the algorithm are as follows: On top level, the “effective adaptive level” is set to the value of the attribute `AdaptiveMesh`. If, for a given edge, the effective adaptive

level is positive and the edge is not very short already, compared with the size of the complete image, and inserting a new point on the implicit surface near the middle of this edge would cause the two new edges to have an angle of less than 170 degrees, then the edge is split, the adjoining triangles are split accordingly (taking into account all their edges) and all the new edges caused by this operation are examined with an effective adaptive level reduced by one.

To plot other contours than zeroes, use the option `Contours`.

## Attributes

Attribute	Purpose	Default Value
<code>AdaptiveMesh</code>	adaptive sampling	0
<code>AffectViewingBox</code>	influence of objects on the <code>ViewingBox</code> of a scene	TRUE
<code>Color</code>	the main color	RGB::Red
<code>Contours</code>	the contours of an implicit function	[0]
<code>Filled</code>	filled or transparent areas and surfaces	TRUE
<code>FillColor</code>	color of areas and surfaces	RGB::Red
<code>FillColor2</code>	second color of areas and surfaces for color blends	RGB::CornflowerBlue
<code>FillColorType</code>	surface filling types	Dichromatic
<code>FillColorFunction</code>	functional area/surface coloring	
<code>FillColorDirection</code>	the direction of color transitions on surfaces	[0, 0, 1]
<code>FillColorDirectionX</code>	x-component of the direction of color transitions on surfaces	0
<code>FillColorDirectionY</code>	y-component of the direction of color transitions on surfaces	0



Attribute	Purpose	Default Value
FillColorDirectionZ	z-component of the direction of color transitions on surfaces	1
Frames	the number of frames in an animation	50
Function	function expression or procedure	
Legend	makes a legend entry	
LegendText	short explanatory text for legend	
LegendEntry	add this object to the legend?	TRUE
LineColor	color of lines	RGB::Black.[0.15]
LineWidth	width of lines	0.35
LineColor2	color of lines	RGB::DeepPink
LineStyle	solid, dashed or dotted lines?	Solid
LineColorType	line coloring types	Flat
LineColorFunction	functional line coloring	
LineColorDirection	the direction of color transitions on lines	[0, 0, 1]
LineColorDirectionX	x-component of the direction of color transitions on lines	0
LineColorDirectionY	y-component of the direction of color transitions on lines	0
LineColorDirectionZ	z-component of the direction of color transitions on lines	1
Mesh	number of sample points	[11, 11, 11]
MeshVisible	visibility of irregular mesh lines in 3D	FALSE

<b>Attribute</b>	<b>Purpose</b>	<b>Default Value</b>
Name	the name of a plot object (for browser and legend)	
ParameterEnd	end value of the animation parameter	
ParameterName	name of the animation parameter	
ParameterBegin	initial value of the animation parameter	
ParameterRange	range of the animation parameter	
PointStyle	the presentation style of points	FilledCircles
PointsVisible	visibility of mesh points	FALSE
Shading	smooth color blend of surfaces	Smooth
TimeEnd	end time of the animation	10.0
TimeBegin	start time of the animation	0.0
TimeRange	the real time span of an animation	0.0 .. 10.0
Title	object title	
TitleFont	font of object titles	[" sans-serif ", 11]
TitlePosition	position of object titles	
TitleAlignment	horizontal alignment of titles w.r.t. their coordinates	Center
TitlePositionX	position of object titles, x component	
TitlePositionY	position of object titles, y component	
TitlePositionZ	position of object titles, z component	
Visible	visibility	TRUE

Attribute	Purpose	Default Value
VisibleAfter	object visible after this time value	
VisibleBefore	object visible until this time value	
VisibleFromTo	object visible during this time range	
VisibleAfterEnd	object visible after its animation time ended?	TRUE
VisibleBeforeBegin	object visible before its animation time starts?	TRUE
XContours	contour lines at constant x values	[Automatic, 15]
XMax	final value of parameter "x"	
XMesh	number of sample points for parameter "x"	11
XMin	initial value of parameter "x"	
XName	name of parameter "x"	
XRange	range of parameter "x"	
YContours	contour lines at constant y values	[Automatic, 15]
YMax	final value of parameter "y"	
YMesh	number of sample points for parameter "y"	11
YMin	initial value of parameter "y"	
YName	name of parameter "y"	
YRange	range of parameter "y"	
ZContours	contour lines at constant z values	[Automatic, 15]
ZMax	final value of parameter "z"	

Attribute	Purpose	Default Value
ZMesh	number of sample points for parameter "z"	11
ZMin	initial value of parameter "z"	
ZName	name of parameter "z"	
ZRange	range of parameter "z"	

## Examples

### Example 1

The set of  $x, y, z$  where  $x^2 + y^2 + z^2 = 1$  form a sphere:

```
plot(plot::Implicit3d(x^2 + y^2 + z^2 - 1,  
                    x = -1.5..1.5,  
                    y = -1.5..1.5,  
                    z = -1.5..1.5),  
      Scaling = Constrained)
```

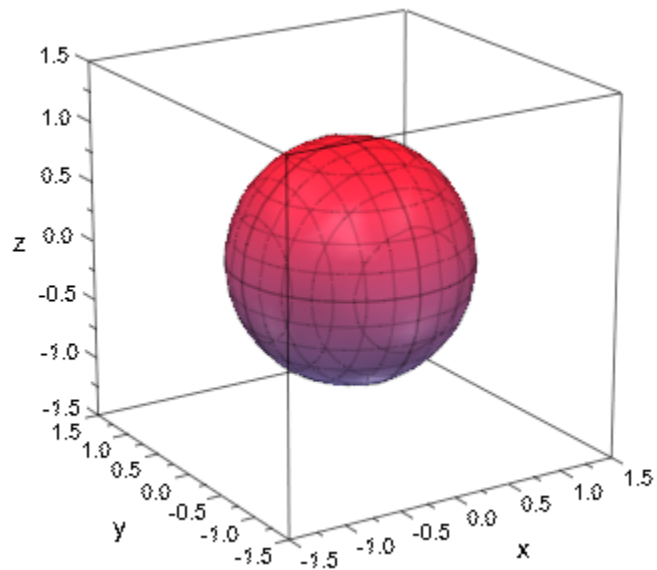

## Example 2

The set of zeroes of a product is the union of the zeroes of the individual functions:

```
plot(plot::Implicit3d((x^2 + y^2 + z^2 - 1) * x,  
                    x = -1.5..1.5,  
                    y = -1.5..1.5,  
                    z = -1.5..1.5),  
      Scaling = Constrained)
```

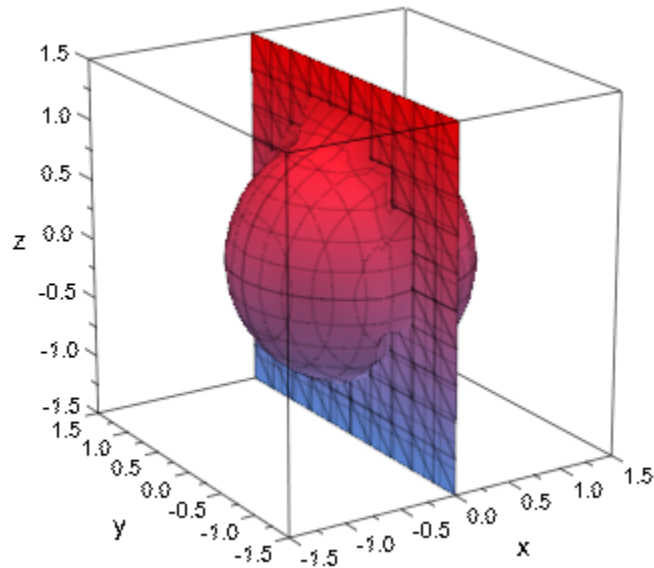

Note that this image is largely dominated by artifacts caused by the coarse evaluation mesh. Increasing this mesh improves the graphics, but increases computation time:

```
plot(plot::Implicit3d((x^2 + y^2 + z^2 - 1) * x,  
    x = -1.5..1.5,  
    y = -1.5..1.5,  
    z = -1.5..1.5,  
    Mesh = [21, 9, 9], AdaptiveMesh = 2),  
    Scaling = Constrained)
```

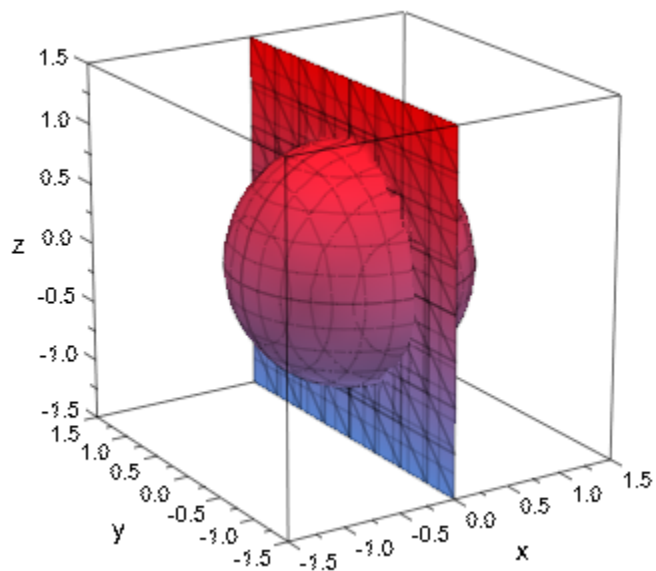

### Example 3

With `MeshVisible = TRUE`, the internal triangulation becomes visible:

```
plot(plot::Implicit3d(z^2 - sin(z - x^2*y^2) = 0,  
  x = -1 .. 1, y = -1 .. 1, z = 0 .. 1,  
  AdaptiveMesh = 2, MeshVisible = TRUE,  
  LineColor = RGB::Black.[0.25])):
```

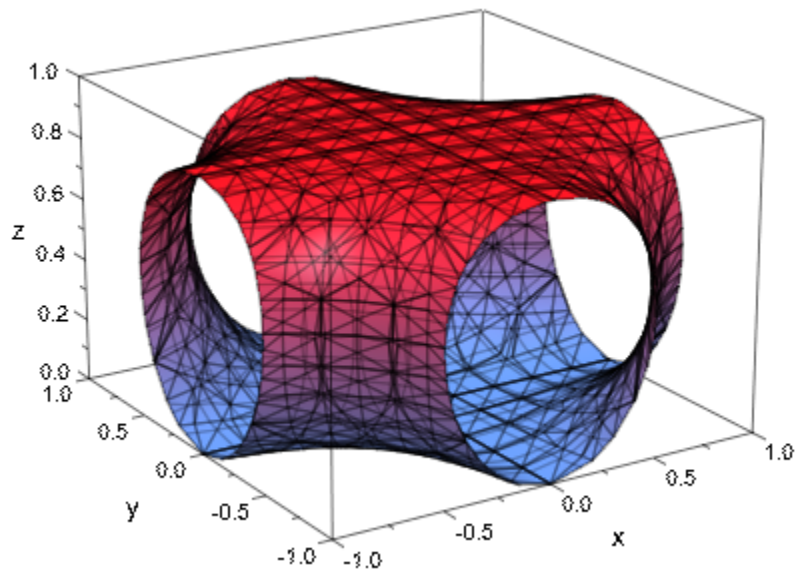

### Example 4

Using functions that are not continuously differentiable, it is possible to generate sharp edges in the images:

```
plot(plot::Implicit3d(min(x^2 + y^2 + z^2 - 2, -z),  
                    x = -2..2, y = -2..2, z = -1.5..0.5),  
     Axes = None, Scaling = Constrained)
```



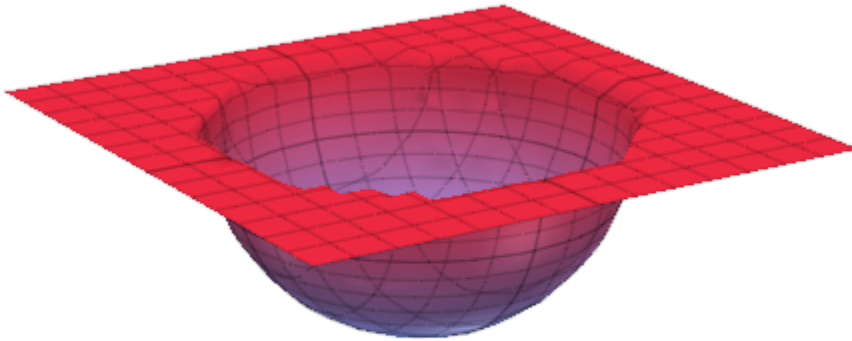

Just like in the preceding example, these sharp corners are prime sources of artifacts, which may require a finer initial mesh and/or adaptive mesh refinement:

```
im := plot::Implicit3d(min(x^2 + y, y^2 - z),  
                      x = -2..2, y = -2..2, z = 0..1):  
plot(im)
```

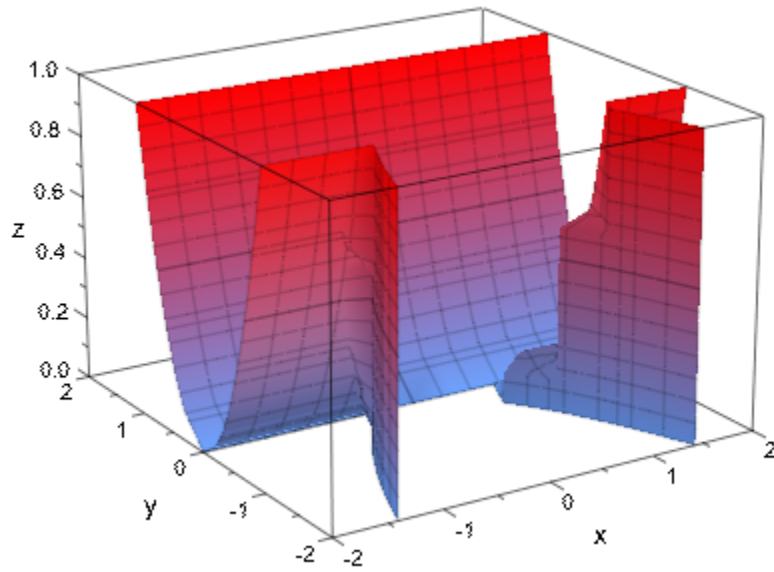

```
plot(im, AdaptiveMesh = 3)
```

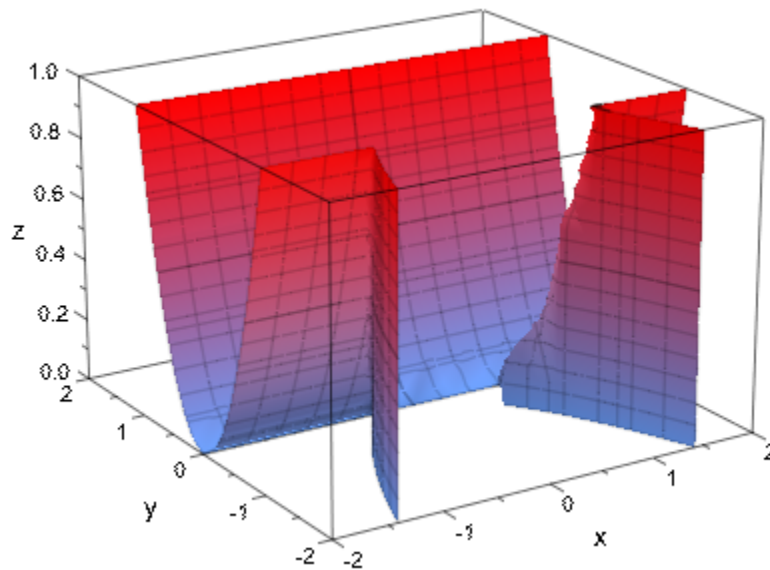

## Example 5

Animating `plot::Implicit3d` objects takes a lot of time. It is easy and fast, though, to add an animated camera object on page 24-1158:

```
plot(plot::Implicit3d(sin(x)+sin(y)+sin(z), x=-5..5, y=-5..5, z=-5..5),  
      plot::Camera([42*sin(t),42*cos(t),42*cos(t-sin(t))], [0,0,0],  
                  PI/12, t=0..2*PI),  
      AnimationStyle=Loop)
```

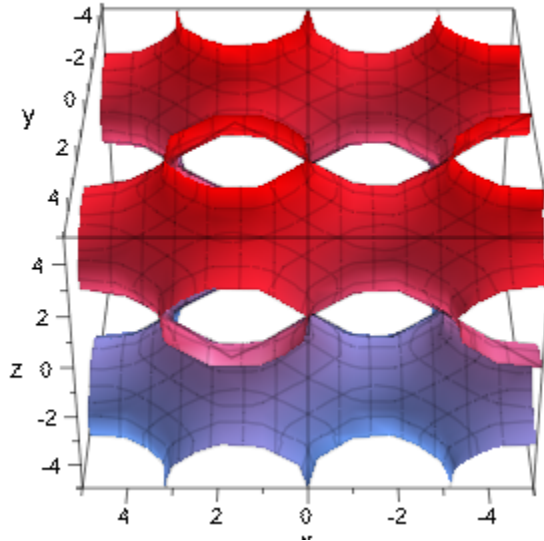

## Parameters

**f**

A real-valued expression or an equation in  $x$ ,  $y$ ,  $z$ , and possibly the animation parameter.

$f$  is equivalent to the attribute `Function`.

**$x$ ,  $y$ ,  $z$**

identifiers on page 7-29.

$x$ ,  $y$ ,  $z$  are equivalent to the attributes `XName`, `YName`, `ZName`.

**$x_{\min}$  ..  $x_{\max}$ ,  $y_{\min}$  ..  $y_{\max}$ ,  $z_{\min}$  ..  $z_{\max}$**

Real-valued expressions, possibly in the animation parameter. The image is plotted with  $x$  in the range  $x_{\min} \leq x \leq x_{\max}$ ,  $y_{\min} \leq y \leq y_{\max}$  and  $z_{\min} \leq z \leq z_{\max}$ .

$X_{\min} \dots X_{\max}$ ,  $Y_{\min} \dots Y_{\max}$ ,  $Z_{\min} \dots Z_{\max}$  are equivalent to the attributes XRange, XMin, XMax, YRange, YMin, YMax, ZRange, ZMin, ZMax.

**a**

Animation parameter, specified as  $a = a_{\min} \dots a_{\max}$ , where  $a_{\min}$  is the initial parameter value, and  $a_{\max}$  is the final parameter value.

## See Also

**MuPAD Functions**

plot | plot::copy

**MuPAD Graphical Primitives**

plot::Implicit2d | plot::Surface

## plot::Inequality

Display areas where inequalities are fulfilled

### Syntax

```
plot::Inequality(ineq, x = x_min .. x_max, y = y_min .. y_max, <a = a_min .. a_max>, options)
```

```
plot::Inequality([ineq1, ...], x = x_min .. x_max, y = y_min .. y_max, <a = a_min .. a_max>, options)
```

### Description

`plot::Inequality(f(x, y) < g(x, y), x = `x_{min}` .. `x_{max}` , y = `y_{min}` .. `y_{max}` )` fills the rectangle  $x_{\min} \leq x \leq x_{\max}$ ,  $y_{\min} \leq y \leq y_{\max}$  with several colors, indicating which points satisfy the inequality.

`plot::Inequality` computes a (more or less coarse) rasterization of the area specified by ``x_{min}` .. `x_{max}`` and ``y_{min}` .. `y_{max}`` and colors subareas according to whether all of the given inequalities are fulfilled (these are colored in `FillColorTrue`), at least one inequality is nowhere fulfilled in the subarea (`FillColorFalse`) or the granularity is insufficient to decide for either of these cases (`FillColorUnknown`).

You can control the density of the rasterization with the attribute `Mesh`. Cf. “Example 2” on page 24-403 (Symbolic Math Toolbox).

`plot::Inequality` uses interval numerics on page 7-33 for evaluation, so the results are reliable, but certain special functions (such as `hypergeom`) cannot be used because they are not supported for intervals.

### Attributes

Attribute	Purpose	Default Value
<code>AffectViewingBox</code>	influence of objects on the <code>ViewingBox</code> of a scene	TRUE

Attribute	Purpose	Default Value
AntiAliased	antialiased lines and points?	FALSE
FillPattern	type of area filling	Solid
FillColorTrue	the color for “true” areas (inequality plot)	RGB::Green
FillColorFalse	the color for “false” areas (inequality plot)	RGB::Red
FillColorUnknown	the color for “unknown” areas (inequality plot)	RGB::Black
Frames	the number of frames in an animation	50
Inequalities	inequalities displayed in inequality plots	
Legend	makes a legend entry	
LegendText	short explanatory text for legend	
LegendEntry	add this object to the legend?	FALSE
LineColor	color of lines	RGB::Blue
LineWidth	width of lines	0.35
LineStyle	solid, dashed or dotted lines?	Solid
LinesVisible	visibility of lines	FALSE
Mesh	number of sample points	[256, 256]
Name	the name of a plot object (for browser and legend)	
ParameterEnd	end value of the animation parameter	
ParameterName	name of the animation parameter	
ParameterBegin	initial value of the animation parameter	

<b>Attribute</b>	<b>Purpose</b>	<b>Default Value</b>
ParameterRange	range of the animation parameter	
TimeEnd	end time of the animation	10.0
TimeBegin	start time of the animation	0.0
TimeRange	the real time span of an animation	0.0 .. 10.0
Title	object title	
TitleFont	font of object titles	[" sans-serif ", 11]
TitlePosition	position of object titles	
TitleAlignment	horizontal alignment of titles w.r.t. their coordinates	Center
TitlePositionX	position of object titles, x component	
TitlePositionY	position of object titles, y component	
Visible	visibility	TRUE
VisibleAfter	object visible after this time value	
VisibleBefore	object visible until this time value	
VisibleFromTo	object visible during this time range	
VisibleAfterEnd	object visible after its animation time ended?	TRUE
VisibleBeforeBegin	object visible before its animation time starts?	TRUE
XMax	final value of parameter "x"	
XMesh	number of sample points for parameter "x"	256
XMin	initial value of parameter "x"	



Attribute	Purpose	Default Value
XName	name of parameter "x"	
XRange	range of parameter "x"	
YMax	final value of parameter "y"	
YMesh	number of sample points for parameter "y"	256
YMin	initial value of parameter "y"	
YName	name of parameter "y"	
YRange	range of parameter "y"	

## Examples

### Example 1

With a single inequality, `plot::Inequality` colors the area where it is fulfilled or violated, with areas at the border line, where the inequality is fulfilled in some parts of the rectangle and violated in other parts:

```
plot(plot::Inequality(x^2 + y^2 < 1,  
                     x = -1.5..1.5, y = -1.5..1.5))
```

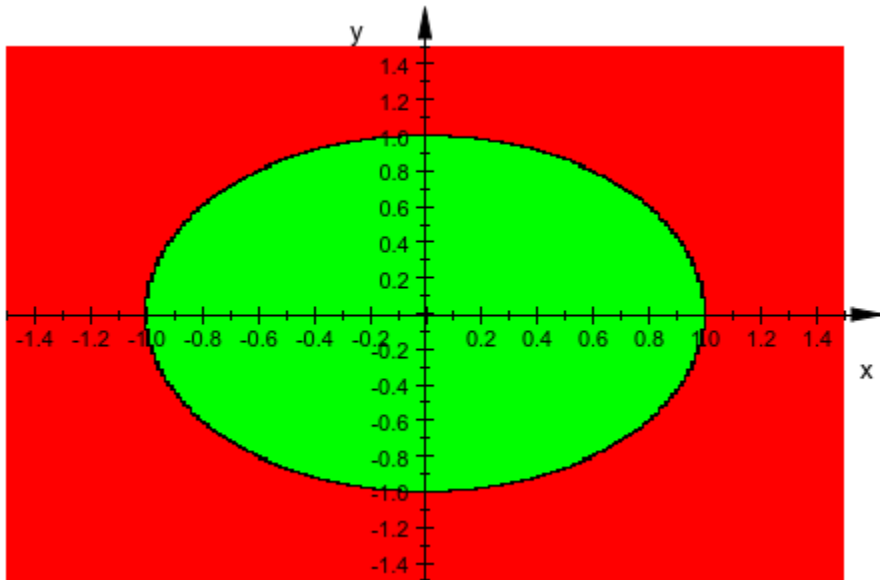

When giving more than one inequality, only those areas where *all* inequalities are fulfilled are painted in blue (or whatever you set `FillColor` to), while all rectangles where *any* inequality is violated (over the whole rectangle) are colored red:

```
plot(plot::Inequality([x^2 + y^2 < 1, abs(x) > 1/3],  
x = -1.5..1.5, y = -1.5..1.5))
```

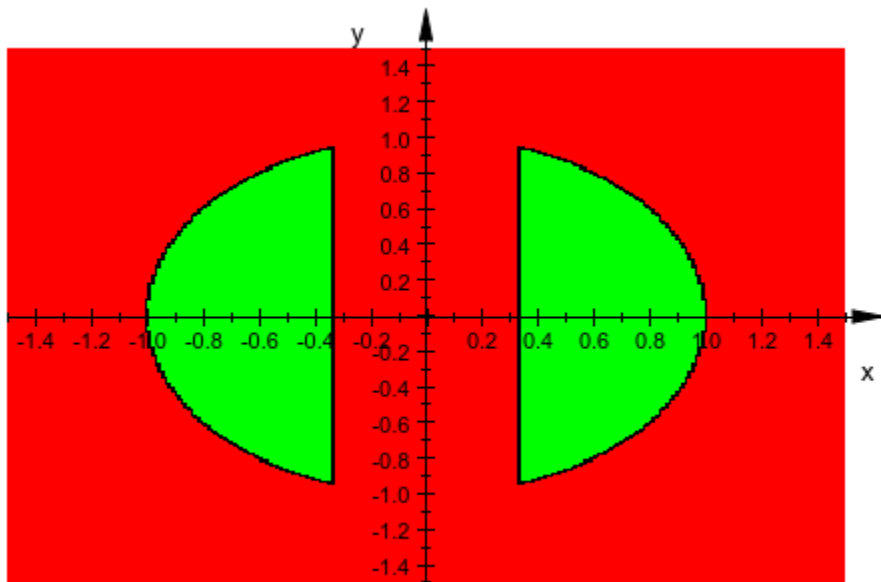

## Example 2

To get a more detailed image from `plot::Inequality`, increase the mesh density:

```
plot(plot::Inequality([x^2 + y^2 < 1, abs(x) > 1/3],  
    x = -1.5..1.5, y = -1.5..1.5,  
    Mesh = [120, 80]))
```

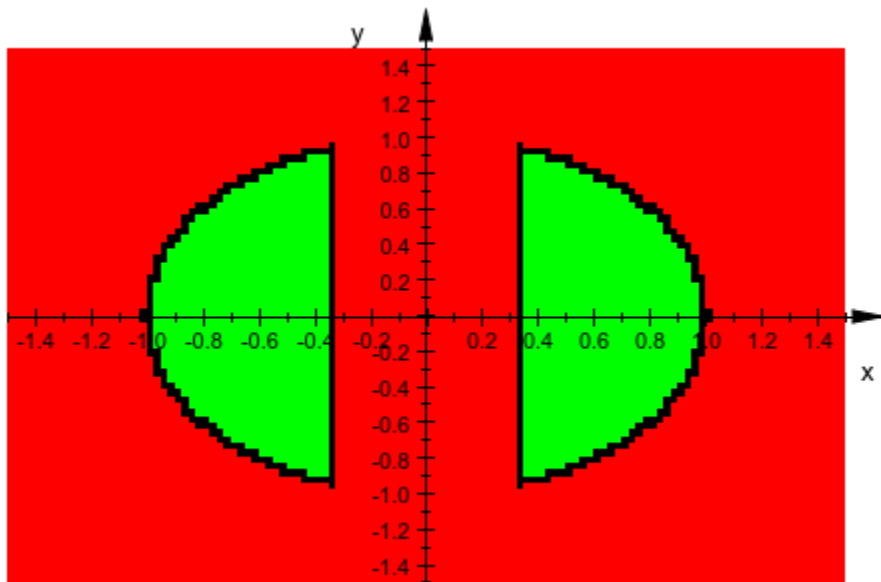

### Example 3

Almost all parameters of `plot::Inequality` can be animated (the mesh is one exception though):

```
plot(plot::Inequality([abs(x)^a + abs(y)^a < 1],  
    x = -1.5+sin(a)..1.5+sin(a),  
    y = -1.5+cos(a)..1.5+cos(a),  
    Mesh = [64, 64],  
    a = 1..2*PI+1))
```

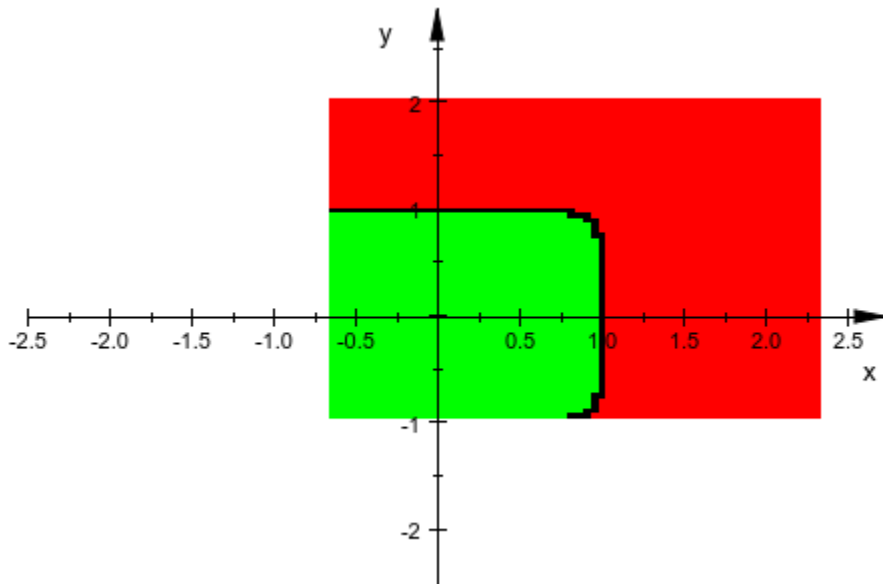

## Parameters

**ineq, ineq<sub>1</sub>, ...**

Inequalities to plot: Expressions of the form  $f(x, y) < g(x, y)$ ,  $f(x, y) \leq g(x, y)$ ,  $f(x, y) = g(x, y)$ ,  $f(x, y) \geq g(x, y)$ , or  $f(x, y) > g(x, y)$ .

ineq, ineq<sub>1</sub>, ... is equivalent to the attribute Inequalities.

**x, y**

Identifiers or indexed identifiers. These denote the free variables spanning the plane.

x, y are equivalent to the attributes XName, YName.

**x<sub>min</sub> .. x<sub>max</sub>, y<sub>min</sub> .. y<sub>max</sub>**

The ranges for x and y. x<sub>min</sub>, x<sub>max</sub>, y<sub>min</sub>, and y<sub>max</sub> must be real numerical values, or expressions of the animation parameter a.

$x_{\min} .. x_{\max}$ ,  $y_{\min} .. y_{\max}$  are equivalent to the attributes XRange, YRange.

**a**

Animation parameter, specified as  $a = a_{\min} .. a_{\max}$ , where  $a_{\min}$  is the initial parameter value, and  $a_{\max}$  is the final parameter value.

## See Also

### **MuPAD Functions**

`plot` | `plot::copy`

### **MuPAD Graphical Primitives**

`plot::Density` | `plot::Implicit2d` | `plot::Raster`

# plot::Integral

Numerical approximation of an integral

## Syntax

```
plot::Integral(f, <n>, <IntMethod = m>, <a = amin .. amax>, options)
```

## Description

`plot::Integral(f, IntMethod = m)` visualizes the approximation of the integral of the function on page 24-295 `f` using the numerical quadrature method on page 24-1295 `m`. Riemann sums, the trapezoidal rule, and the Simpson rule are available.

`plot::Integral(f, n, IntMethod = m)` uses `n` subintervals on page 24-1343 to approximate the integral.

The attribute `IntMethod` determines the numerical method. Riemann sums, the trapezoidal rule, or the Simpson rule are available. See the help page of `IntMethod` for further details. Cf. “Example 1” on page 24-410 (Symbolic Math Toolbox).

`plot::Integral` does not plot the function graph of the integrand. If the integrand is to be plotted, too, `f` has to be passed to the `plot` command together with the approximation object of type `plot::Integral`.

If no quadrature method is specified by `IntMethod = m`, `plot::Integral` just hatches the area on page 24-338 between the function `f` and the x-axis.

Several `plot::Integral` objects can be plotted together to illustrate the difference between various quadrature methods. The order of the objects in the `plot` command determines the object in front.

The plot contains a text object providing information about the quadrature method, the value of the approximation, the exact value of the integral, the quadrature error, and the number of nodes. See the help page of the attribute `ShowInfo` for further details.

## Attributes

Attribute	Purpose	Default Value
AffectViewingBox	influence of objects on the ViewingBox of a scene	TRUE
AntiAliased	antialiased lines and points?	TRUE
Color	the main color	RGB::PaleBlue
Filled	filled or transparent areas and surfaces	TRUE
FillColor	color of areas and surfaces	RGB::PaleBlue
FillPattern	type of area filling	Solid
Frames	the number of frames in an animation	50
Function1	first function/curve delimiting hatch	
HorizontalAlignment	horizontal alignment of text objects w.r.t. their coordinates	Left
IntMethod	method for integral approximation	Exact
Legend	makes a legend entry	
LegendText	short explanatory text for legend	
LegendEntry	add this object to the legend?	FALSE
LineColor	color of lines	RGB::Black
LineWidth	width of lines	0.35
LineColor2	color of lines	RGB::Grey
LineStyle	solid, dashed or dotted lines?	Solid
LinesVisible	visibility of lines	TRUE
LineColorType	line coloring types	Flat



Attribute	Purpose	Default Value
LineColorFunction	functional line coloring	
Name	the name of a plot object (for browser and legend)	
Nodes	number of subintervals or list of x-values for subintervals	[10]
ParameterEnd	end value of the animation parameter	
ParameterName	name of the animation parameter	
ParameterBegin	initial value of the animation parameter	
ParameterRange	range of the animation parameter	
PointSize	the size of points	1.5
PointStyle	the presentation style of points	FilledCircles
PointsVisible	visibility of mesh points	FALSE
ShowInfo	Information about integral approximation	[2, IntMethod, Integral]
TextFont	font of text objects	[" sans-serif ", 11]
TextRotation	rotation of a 2D text	0
TimeEnd	end time of the animation	10.0
TimeBegin	start time of the animation	0.0
TimeRange	the real time span of an animation	0.0 .. 10.0
Title	object title	
TitleFont	font of object titles	[" sans-serif ", 11]
TitlePosition	position of object titles	
TitleAlignment	horizontal alignment of titles w.r.t. their coordinates	Center

Attribute	Purpose	Default Value
TitlePositionX	position of object titles, x component	
TitlePositionY	position of object titles, y component	
VerticalAlignment	vertical alignment of text objects w.r.t. their coordinates	Bottom
Visible	visibility	TRUE
VisibleAfter	object visible after this time value	
VisibleBefore	object visible until this time value	
VisibleFromTo	object visible during this time range	
VisibleAfterEnd	object visible after its animation time ended?	TRUE
VisibleBeforeBegin	object visible before its animation time starts?	TRUE

## Examples

### Example 1

If a single `plot::Function2d` object is given without specifying an approximation method, `plot::Integral` just hatches the area between the function graph and the x-axis:

```
f := plot::Function2d(cos(x), x = -PI..PI):  
plot(plot::Integral(f), f)
```

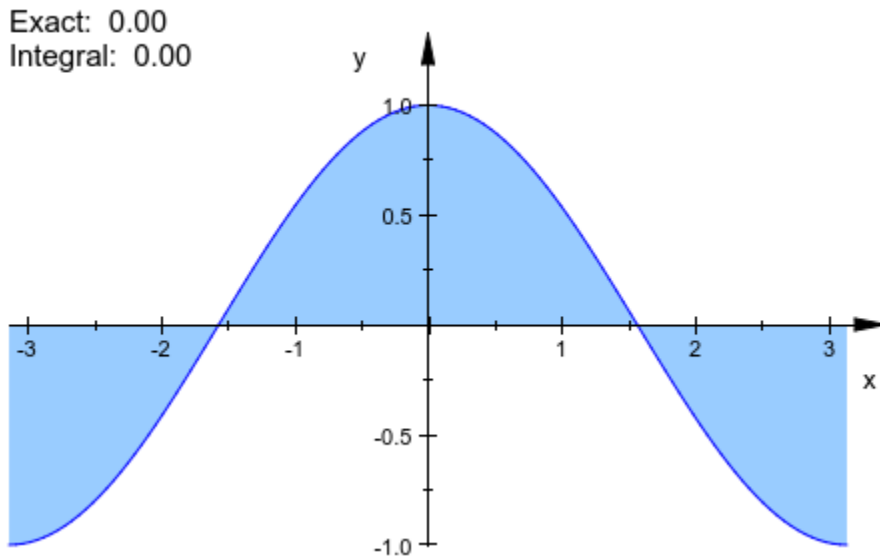

Note that `plot::Integral` requires an *object* of type `plot::Function2d`, not just a function expression:

```
plot::Integral(sin(x))
```

Error: First argument must be a 'plot::Function2d' object. [plot::Integral::new]

If an approximation method is specified, the numerical quadrature value computed by this method is displayed:

```
plot(plot::Integral(f, IntMethod = RiemannLower))
```

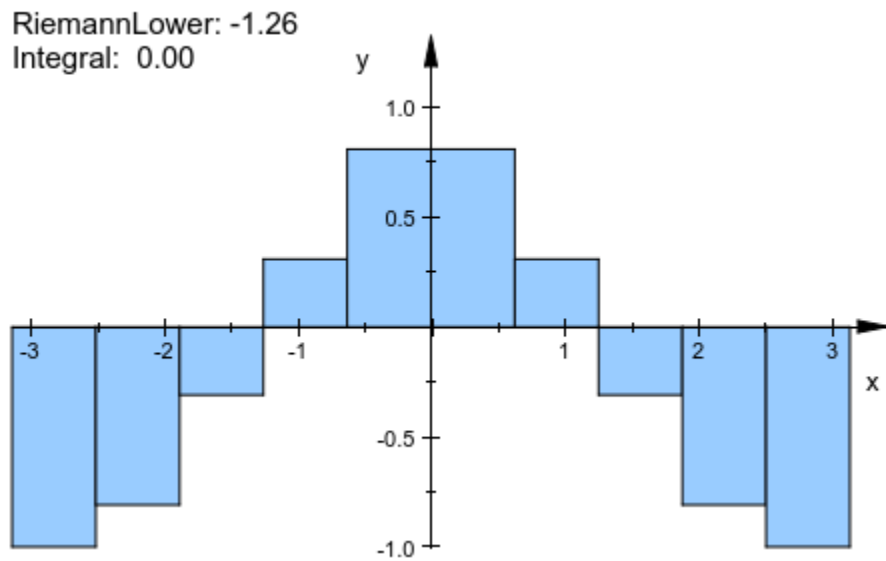

The number of quadrature intervals can be set by passing a second argument  $n$  or by specifying `Nodes = n`:

```
plot(plot::Integral(f, 20, IntMethod = RiemannLower))
```

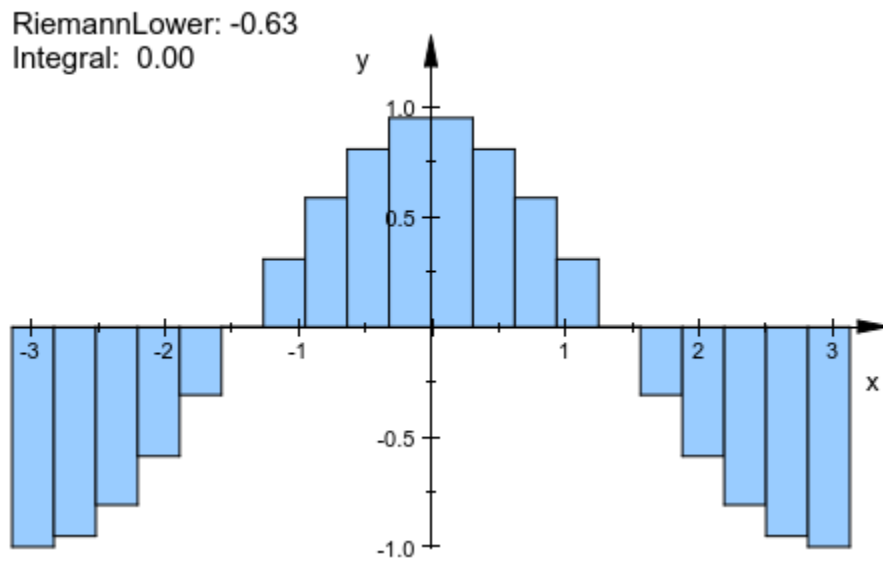

To see the integrand in the plot, the function object must be passed together with the approximation object. The order determines which object is in front:

```
plot(plot::Integral(f, IntMethod = RiemannLower), f)
```

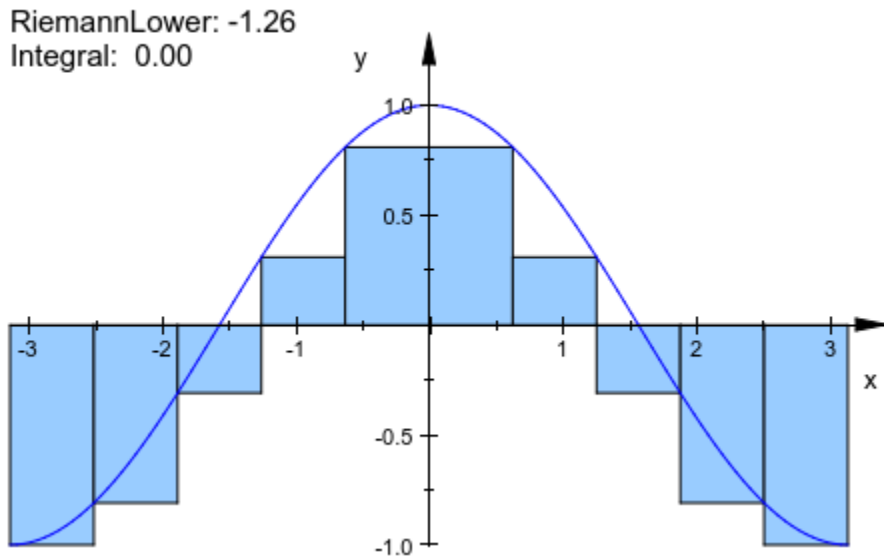

delete f:

## Example 2

The displayed information on page 24-1617 can be configured by the user:

```
f := plot::Function2d(x^2, x = -5..5, Color = RGB::DarkGrey):
plot(plot::Integral(f, IntMethod = RiemannLower,
  ShowInfo = [1, IntMethod = "Riemann lower sum",
    Integral = "Exact value",
    2, Error = "Difference"]), f)
```

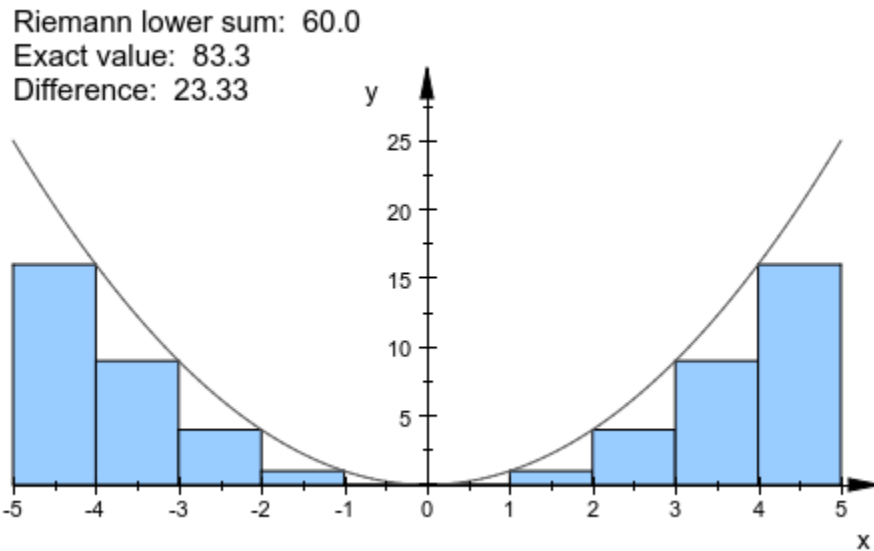

delete f:

### Example 3

One may combine several approximation objects, e.g., lower and upper sum:

```
f := plot::Function2d(x^2, x = -5..5):
plot(plot::Integral(f, IntMethod = RiemannUpper,
  Color = RGB::Blue),
  plot::Integral(f, IntMethod = RiemannLower,
  Color = RGB::LightYellow),
  f)
```

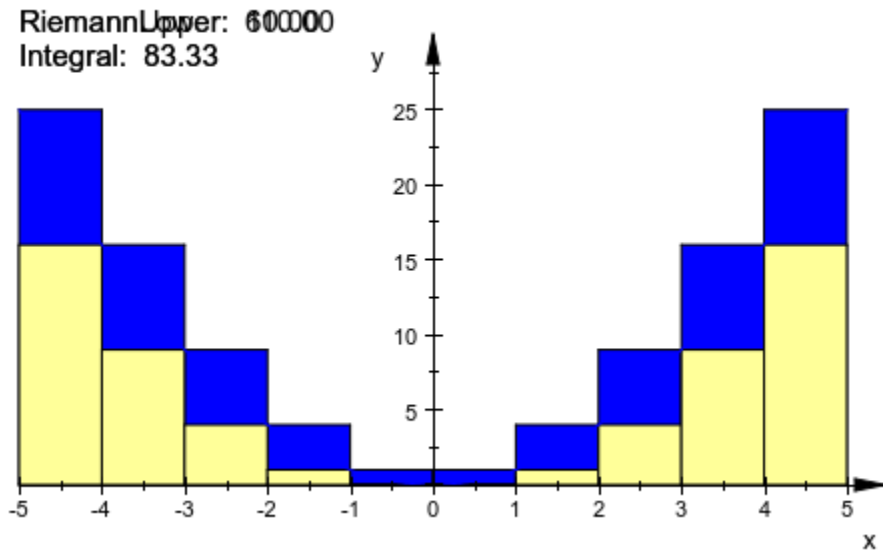

The automatically placed information texts overlap. To correct this, the option `ShowInfo` must be used. In the text of the upper sum, one additional empty line is inserted. Apart from this, both objects use the default value, therefore there is not need to specify `ShowInfo` in the second object:

```
plot(plot::Integral(f, IntMethod = RiemannUpper,
  ShowInfo = [IntMethod, "", Integral]),
  plot::Integral(f, IntMethod = RiemannLower,
  Color = RGB::LightYellow),
  f)
```



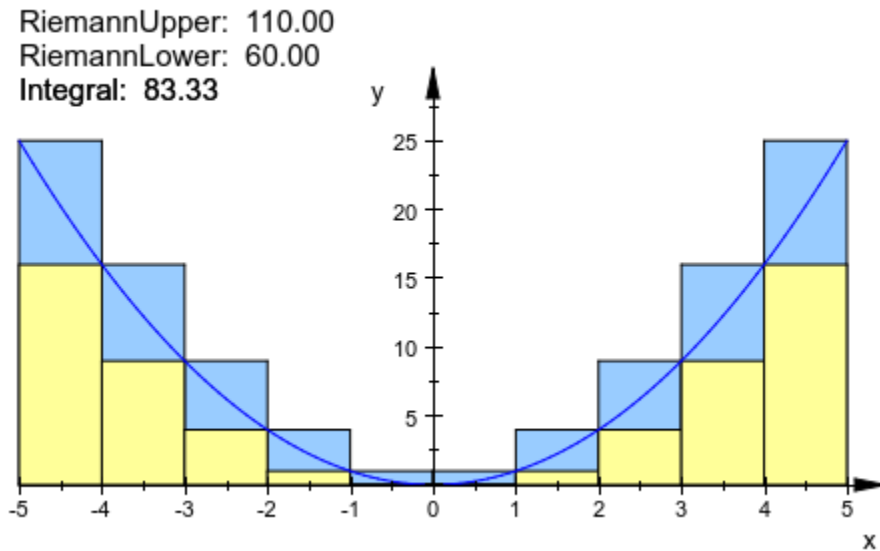

The info text can be positioned explicitly:

```
plot(plot::Integral(f, IntMethod = RiemannUpper,
  ShowInfo = [IntMethod, Integral,
    Position = [-5, -1]],
  VerticalAlignment = Top),
  plot::Integral(f, IntMethod = RiemannLower, Color = RGB::Yellow,
  ShowInfo = [IntMethod,
    Position = [0, -1]],
  VerticalAlignment = Top),
  f)
```

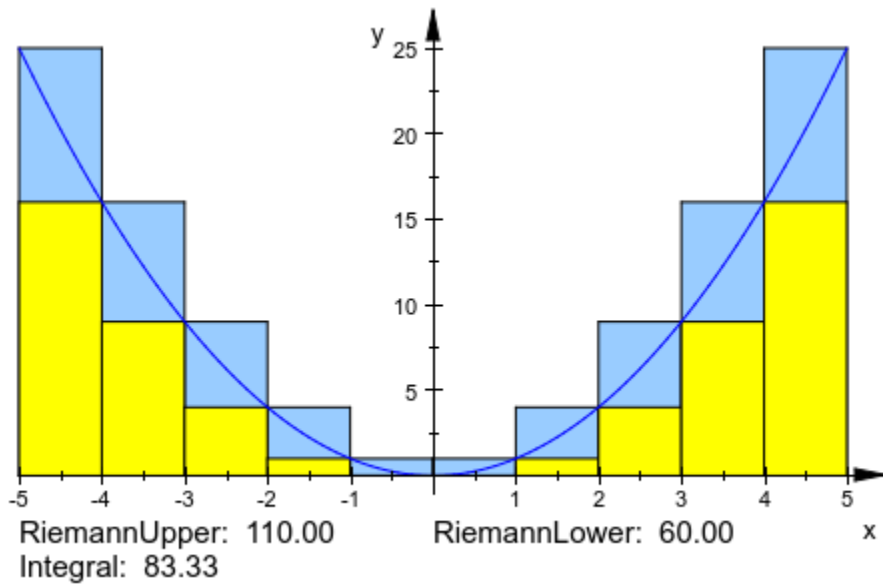

delete f:

#### Example 4

plot::Integral can be animated:

```
f := plot::Function2d(sin(a*x), x = 0..PI, a = 1..5):
plot(plot::Integral(f, 50, IntMethod = RiemannMiddle), f)
```

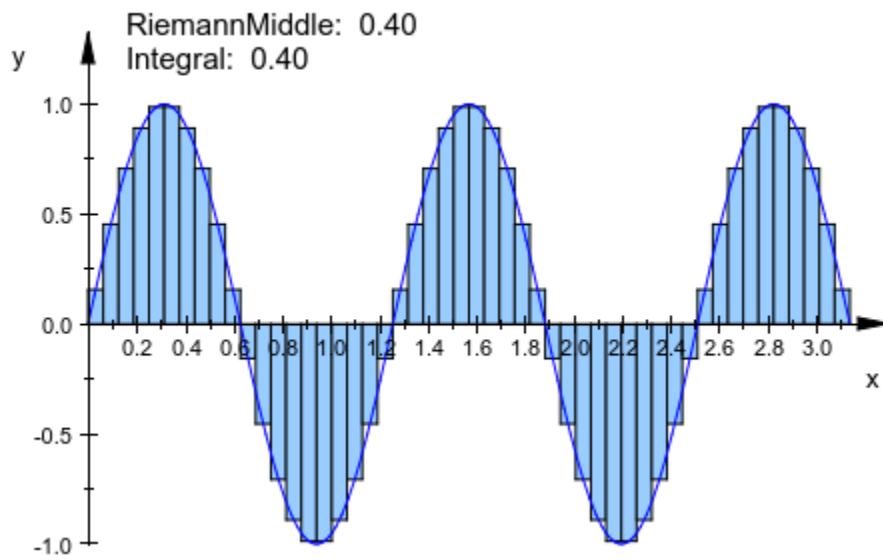

Increasing the number of nodes decreases the quadrature error:

```
f := plot::Function2d(sin(x), x = 0..PI):  
plot(plot::Integral(f, N, N = 10..50, IntMethod = RiemannLower), f)
```

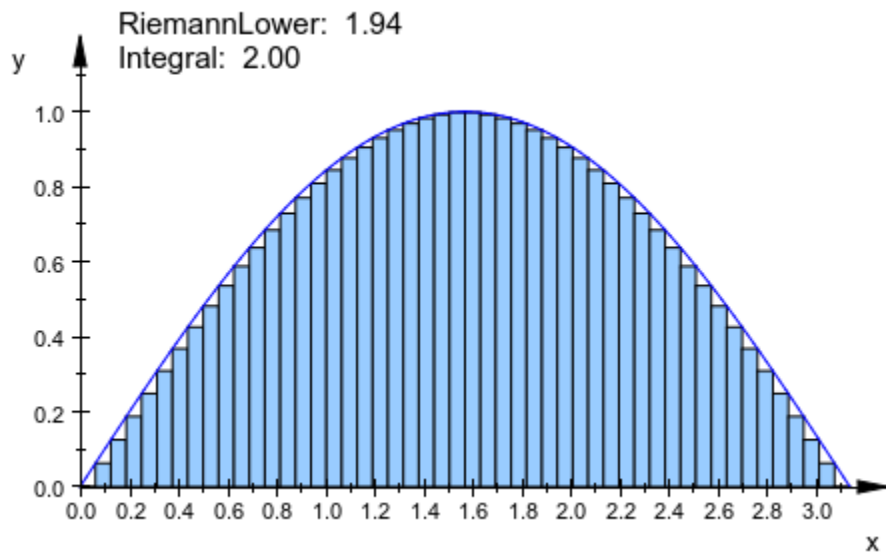

The function and the number of nodes can be animated simultaneously:

```
f := plot::Function2d(sin(a*x), x = 0..PI, a = 1.5):  
plot(plot::Integral(f, N, N = 10..50, IntMethod = RiemannLower), f)
```

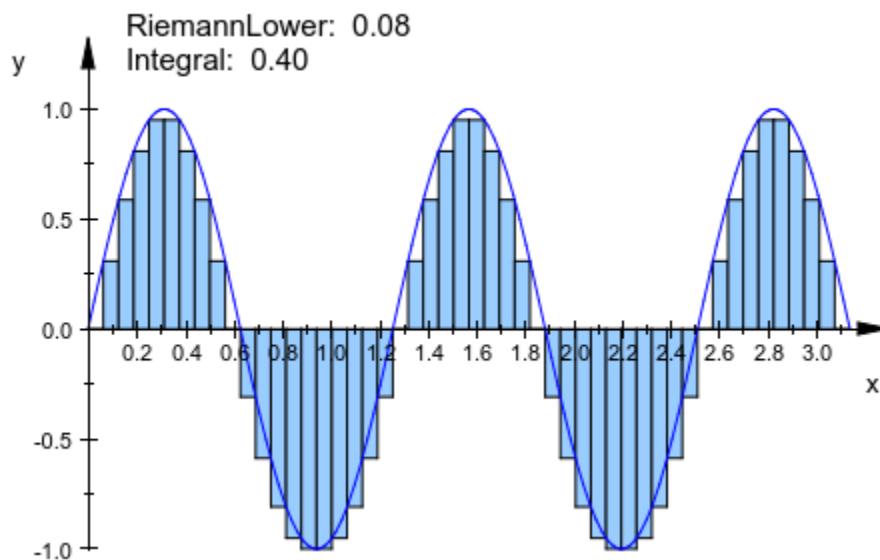

delete f:

## Parameters

### f

The integrand: an object of type `plot::Function2d`.

f is equivalent to the attribute `Function1`.

### n

The number of subintervals (a positive integer) or a list of real numbers representing nodes of the integration variable.

n is equivalent to the attribute `Nodes`.

### a

Animation parameter, specified as  $a = a_{min} \dots a_{max}$ , where  $a_{min}$  is the initial parameter value, and  $a_{max}$  is the final parameter value.

## Options

### **IntMethod**

Option, specified as `IntMethod = m`

The quadrature method; see `IntMethod`

## See Also

### **MuPAD Functions**

`plot` | `plot::copy`

### **MuPAD Graphical Primitives**

`plot::Function2d` | `plot::Hatch` | `plot::Text2d`

# plot::Iteration

Plotting iterated functions

## Syntax

```
plot::Iteration(f, x0, <n>, x = x_min .. x_max, <a = a_min .. a_max>, options)
```

## Description

`plot::Iteration(f, x0, n, x = `x_{min}` .. `x_{max}`)` is a graphical object visualizing the iteration  $x_i = f(x_{i-1})$  ( $i = 1, \dots, n$ ) of the given starting point  $x_0$ .

The iteration is visualized by connecting the points  $(x_0, 0)$  and  $(x_0, x_1)$  by a vertical line. For any step of the iteration, a horizontal line is drawn from the point  $(x_{i-1}, x_i)$  (on the graph of  $f$ ) to the point  $(x_i, x_i)$  on the main diagonal. From there, a vertical line is drawn to the next pair  $(x_i, x_{i+1})$  of the iteration.

The iteration object neither includes the graph of the function  $y = f(x)$  nor the main diagonal  $y = x$ . You need to plot them separately if you wish the function and/or the diagonal to be in your picture! See the examples.

The iteration is stopped prematurely when the iterated point leaves the plot range ``x_{min}` .. `x_{max}``. Cf. “Example 3” on page 24-430 (Symbolic Math Toolbox).

Despite the fact that the number of iterations  $n$  represents an integer, it can be animated! Cf. “Example 4” on page 24-432 (Symbolic Math Toolbox)

The default color used for the iteration plot is `RGB::Grey50`. It can be modified by setting the attribute `Color` or `LineColor`. Cf. “Example 1” on page 24-426 (Symbolic Math Toolbox).

The default line style is solid. It can be modified by setting the attribute `LineStyle`.

## Attributes

Attribute	Purpose	Default Value
AffectViewingBox	influence of objects on the ViewingBox of a scene	TRUE
AntiAliased	antialiased lines and points?	FALSE
Color	the main color	RGB::Grey50
Frames	the number of frames in an animation	50
Function	function expression or procedure	
Iterations	number of iterations in plot::Iteration	10
Legend	makes a legend entry	
LegendText	short explanatory text for legend	
LegendEntry	add this object to the legend?	FALSE
LineColor	color of lines	RGB::Grey50
LineWidth	width of lines	0.35
LineStyle	solid, dashed or dotted lines?	Solid
Name	the name of a plot object (for browser and legend)	
ParameterEnd	end value of the animation parameter	
ParameterName	name of the animation parameter	
ParameterBegin	initial value of the animation parameter	
ParameterRange	range of the animation parameter	



Attribute	Purpose	Default Value
StartingPoint	starting point of the iteration	
TimeEnd	end time of the animation	10.0
TimeBegin	start time of the animation	0.0
TimeRange	the real time span of an animation	0.0 .. 10.0
Title	object title	
TitleFont	font of object titles	[" sans-serif ", 11]
TitlePosition	position of object titles	
TitleAlignment	horizontal alignment of titles w.r.t. their coordinates	Center
TitlePositionX	position of object titles, x component	
TitlePositionY	position of object titles, y component	
Visible	visibility	TRUE
VisibleAfter	object visible after this time value	
VisibleBefore	object visible until this time value	
VisibleFromTo	object visible during this time range	
VisibleAfterEnd	object visible after its animation time ended?	TRUE
VisibleBeforeBegin	object visible before its animation time starts?	TRUE
XMax	final value of parameter "x"	
XMin	initial value of parameter "x"	
XName	name of parameter "x"	
XRange	range of parameter "x"	

## Examples

### Example 1

We consider the logistic map for the parameter value 3, i.e., the parabola  $f(x) = 3x(1 - x)$  for  $x \in [0, 1]$ . We iterate the starting point  $x_0 = 0.5$ :

```
f := plot::Function2d(3*x*(1 - x), x = 0..1,
                      Color = RGB::Blue):
x0 := 0.5:
```

We plot the iteration (without specifying the number of iterations), the parabola  $f$  and the diagonal line  $g(x) = x$ :

```
g := plot::Function2d(x, x = 0..1, Color = RGB::Red):
it := plot::Iteration(3*x*(1 - x), x0, x = 0..1):
plot(f, g, it)
```

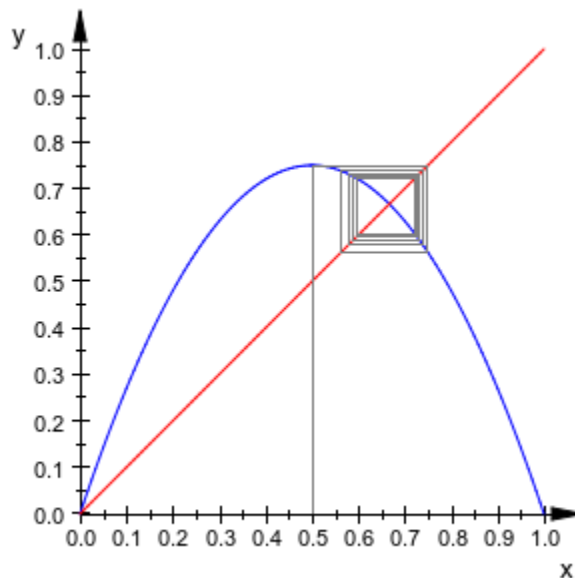

We increase the number of iterations to 50 and change the color of the lines to `RGB::Black`:

```
it::Iterations := 50:  
it::Color := RGB::Black:  
plot(f, g, it)
```

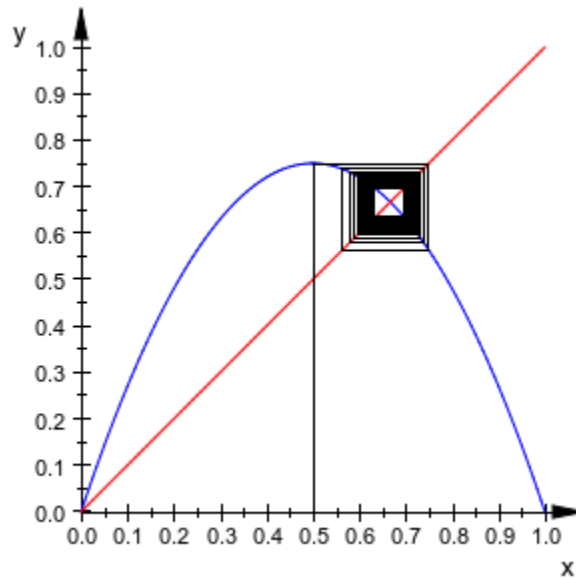

Finally, we animate the number of steps, allowing to follow the course of the iteration:

```
it := plot::Iteration(3*x*(1 - x), x0, n, x = 0..1,  
                     n = 1..50, Color = RGB::Black):  
plot(f, g, it)
```

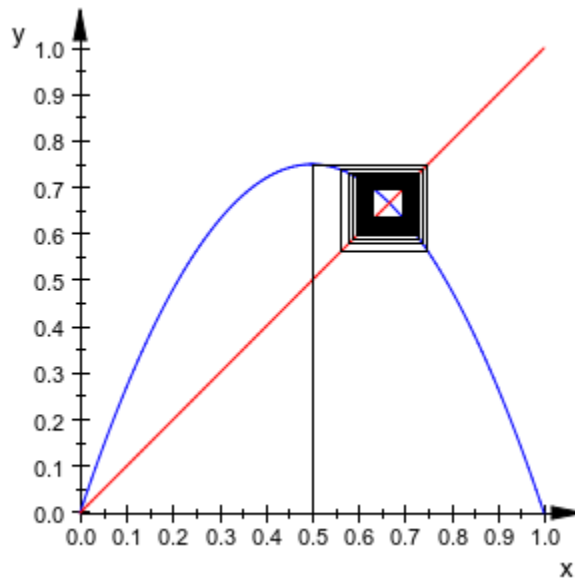

```
delete f, g, it:
```

## Example 2

We consider the logistic map  $f(x) = a x (1 - x)$  for  $x \in [0, 1]$  and the animation parameter  $a$  running from  $a = 2$  to  $a = 4$ :

```
f := plot::Function2d(a*x*(1 - x), x = 0..1, a = 2..4,
    Color = RGB::Black):
```

We define the iteration of the starting point  $x_0 = 0.2$  by  $f$  and plot it together with the function graph of  $f(x)$  and the diagonal line  $g(x) = x$ :

```
g := plot::Function2d(x, x = 0..1, Color = RGB::Black):
it1 := plot::Iteration(a*x*(1 - x), 0.2, 30, x = 0..1,
    a = 2..4, Color = RGB::Red):
plot(f, g, it1)
```

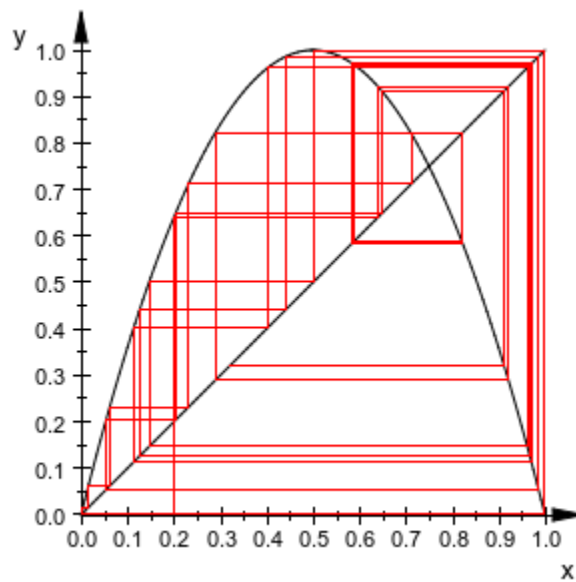

We define an additional iteration starting at  $x_0 = 0.21$  and add it to the plot:

```
it2 := plot::Iteration(a*x*(1 - x), 0.21, 30, x = 0..1,  
                      a = 2..4, Color = RGB::Blue):  
plot(f, g, it1, it2)
```

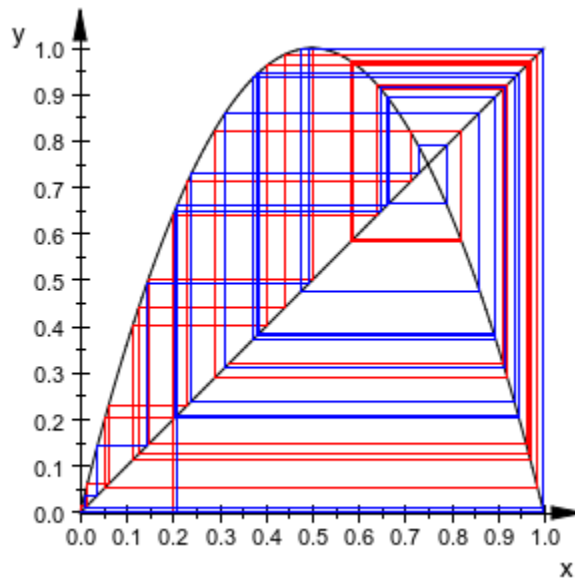

For small values of  $a$ , the two iterations converge to the same fixed point. When  $a$  approaches the value 4, the iterations drift into chaos.

```
delete f, g, it1, it2:
```

### Example 3

Consider the iteration of the starting point  $x_0 = 0.2$  by the logistic map  $f(x) = x(x - 1)$  with the plot range  $x \in [0, 1]$ :

```
f := plot::Function2d(x*(x - 1), x = 0..1):
it := plot::Iteration(x*(x - 1), 0.2, x = 0..1):
plot(f, it)
```

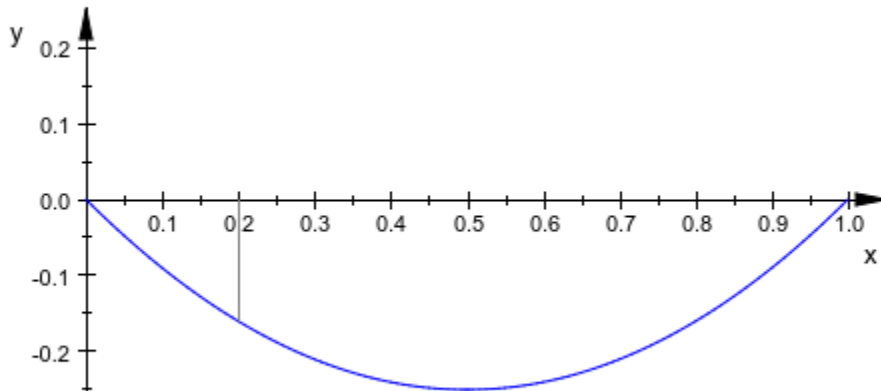

We see that only one step of the iteration is plotted. The reason is that the point  $x_1 = f(x_0)$  is negative and, hence, not contained in the requested plot range  $x = 0 \dots 1$ . We modify the plot range:

```
f::XRange:= -0.5..1:  
it::XRange:= -0.5..1:  
plot(f, it)
```

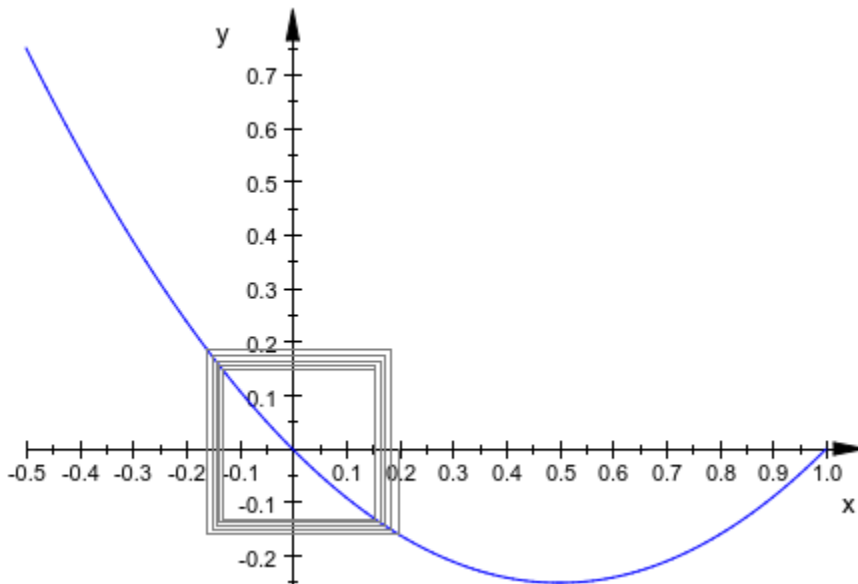

```
delete f, it:
```

### Example 4

We animate the parameter  $n$  that sets the number of iterations. We set the time range for the animation to 40 (seconds). Using `Frames`, the total number of frames is chosen such that approximately 10 frames are used to visualize the step from  $n$  to  $n + 1$ :

```
f := plot::Function2d(4*x*(1 - x), x = 0..1):
g := plot::Function2d(x, x = 0..1):
it := plot::Iteration(4*x*(1 - x), 0.4, n, x = 0..1,
    LineStyle = Dashed,
    n = 0..40, Frames = 411,
    TimeRange = 0..40):
plot(f, g, it)
```



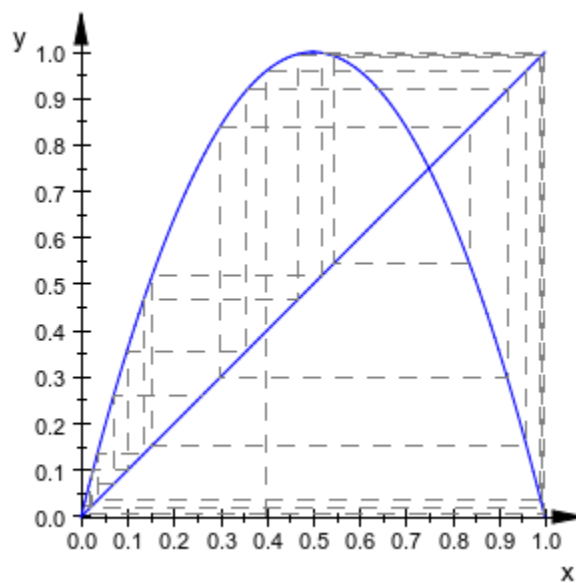

delete f, g, it:

## Parameters

**f**

The iteration function: an arithmetical expression (Symbolic Math Toolbox) in the independent variable  $x$  and the animation parameter  $a$ . Alternatively, a procedure on page 1-1654 that accepts 1 input parameter  $x$  or 2 input parameters  $x$ ,  $a$  and returns a real numerical value when the input parameters are numerical.

$f$  is equivalent to the attribute `Function`.

**$x_0$**

The starting point for the iteration:  $x_0$  must be a numerical real value or an expression in the animation parameter  $a$ .

$x_0$  is equivalent to the attribute `StartingPoint`.

**n**

The number of iterations:  $n$  must be a positive integer or an expression in the animation parameter  $a$ .

$n$  is equivalent to the attribute `Iterations`.

**x**

The independent variable: an identifier on page 7-29 or an indexed identifier on page 1-1017.

$x$  is equivalent to the attribute `XName`.

 **$x_{\min} \dots x_{\max}$** 

The plot range:  $x_{\min}$ ,  $x_{\max}$  must be numerical real values or expressions in the animation parameter  $a$ .

$x_{\min} \dots x_{\max}$  is equivalent to the attributes `XRange`, `XMin`, `XMax`.

**a**

Animation parameter, specified as  $a = a_{\min} \dots a_{\max}$ , where  $a_{\min}$  is the initial parameter value, and  $a_{\max}$  is the final parameter value.

## See Also

**MuPAD Functions**

`plot` | `plot::copy`

**MuPAD Graphical Primitives**

`plot::Lsys`

# plot::Line2d

2D line segments

## Syntax

```
plot::Line2d([x1, y1], [x2, y2], <a = amin .. amax>, options)
```

## Description

`plot::Line2d([x1, y1], [x2, y2])` creates a 2D line segment between the points  $(x_1, y_1)$  and  $(x_2, y_2)$ .

The end points can be passed as lists or vectors.

## Attributes

Attribute	Purpose	Default Value
AffectViewingBox	influence of objects on the ViewingBox of a scene	TRUE
AntiAliased	antialiased lines and points?	TRUE
Color	the main color	RGB::Blue
Extension	line extensions	Finite
Frames	the number of frames in an animation	50
From	starting point of arrows and lines	[0, 0]
FromX	starting point of arrows and lines, x-coordinate	0
FromY	starting point of arrows and lines, y-coordinate	0

<b>Attribute</b>	<b>Purpose</b>	<b>Default Value</b>
Legend	makes a legend entry	
LegendText	short explanatory text for legend	
LegendEntry	add this object to the legend?	FALSE
LineColor	color of lines	RGB::Blue
LineWidth	width of lines	0.35
LineStyle	solid, dashed or dotted lines?	Solid
Name	the name of a plot object (for browser and legend)	
ParameterEnd	end value of the animation parameter	
ParameterName	name of the animation parameter	
ParameterBegin	initial value of the animation parameter	
ParameterRange	range of the animation parameter	
TimeEnd	end time of the animation	10.0
TimeBegin	start time of the animation	0.0
TimeRange	the real time span of an animation	0.0 .. 10.0
Title	object title	
TitleFont	font of object titles	[" sans-serif ", 11]
TitlePosition	position of object titles	
TitleAlignment	horizontal alignment of titles w.r.t. their coordinates	Center
TitlePositionX	position of object titles, x component	

Attribute	Purpose	Default Value
TitlePositionY	position of object titles, y component	
To	end point of arrows and lines	[1, 0]
ToX	end point of arrows and lines, x-coordinate	1
ToY	end point of arrows and lines, y-coordinate	0
Visible	visibility	TRUE
VisibleAfter	object visible after this time value	
VisibleBefore	object visible until this time value	
VisibleFromTo	object visible during this time range	
VisibleAfterEnd	object visible after its animation time ended?	TRUE
VisibleBeforeBegin	object visible before its animation time starts?	TRUE

## Examples

### Example 1

Create a 2D line segment:

```
plot(plot::Line2d([1, 2], [3,-1]))
```

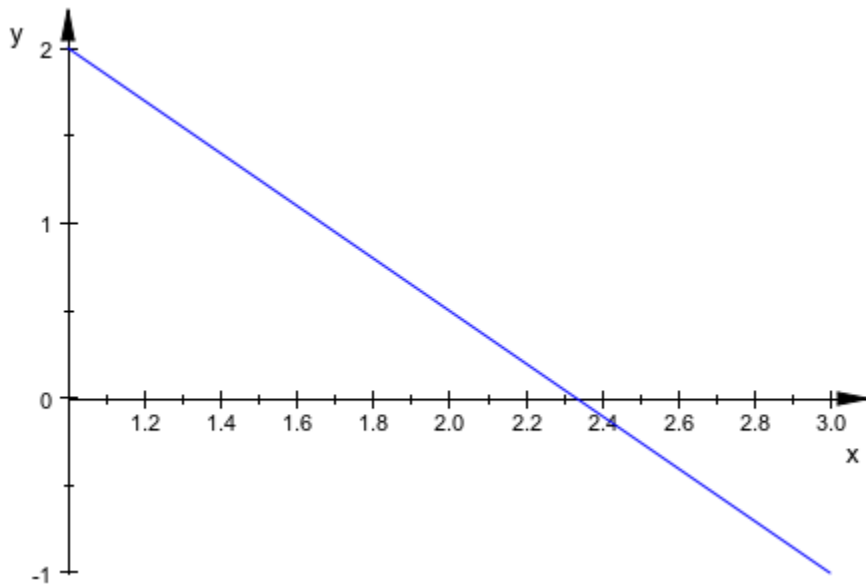

Change the `LineStyle` from the default `Solid` value to `Dashed` or `Dotted`. Also, set `LineColor` and `LineWidth` explicitly:

```
plot(plot::Line2d([1, 2], [3, -1],  
                 LineStyle = Dashed,  
                 LineWidth = 2.5*unit::mm,  
                 LineColor = RGB::Green))
```

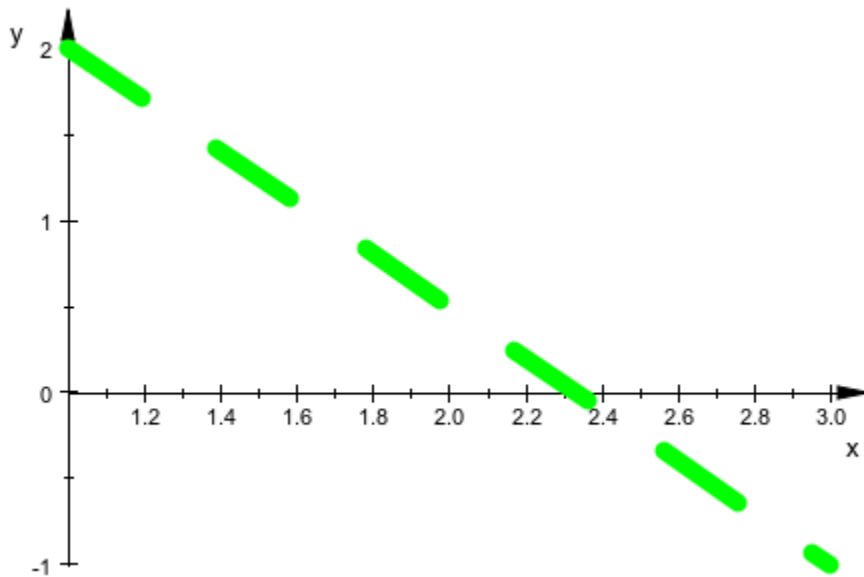

## Parameters

### $x_1, y_1$

Coordinates of one end point: real numerical values or arithmetical expressions (Symbolic Math Toolbox) of the animation parameter  $a$ .

$x_1, y_1$  are equivalent to the attributes FromX, FromY.

### $x_2, y_2$

Coordinates of the other end point: real numerical values or arithmetical expressions (Symbolic Math Toolbox) of the animation parameter  $a$ .

$x_2, y_2, z_2$  are equivalent to the attributes ToX, ToY, ToZ.

### $a$

Animation parameter, specified as  $a = a_{\min} \dots a_{\max}$ , where  $a_{\min}$  is the initial parameter value, and  $a_{\max}$  is the final parameter value.

## See Also

### **MuPAD Functions**

`plot` | `plot::copy`

### **MuPAD Graphical Primitives**

`plot::Line3d` | `plot::Polygon2d` | `plot::Polygon3d` | `plot::Rectangle`



# plot::Line3d

3D line segments

## Syntax

```
plot::Line3d([x1, y1, z1], [x2, y2, z2], <a = amin .. amax>, options)
```

## Description

`plot::Line3d([x1, y1, z1], [x2, y2, z2])` creates a 3D line segment from (x<sub>1</sub>, y<sub>1</sub>, z<sub>1</sub>) to (x<sub>2</sub>, y<sub>2</sub>, z<sub>2</sub>).

The end points can be passed as lists or vectors.

## Attributes

Attribute	Purpose	Default Value
AffectViewingBox	influence of objects on the ViewingBox of a scene	TRUE
Color	the main color	RGB::Blue
Extension	line extensions	Finite
Frames	the number of frames in an animation	50
From	starting point of arrows and lines	[0, 0, 0]
FromX	starting point of arrows and lines, x-coordinate	0
FromY	starting point of arrows and lines, y-coordinate	0

<b>Attribute</b>	<b>Purpose</b>	<b>Default Value</b>
FromZ	starting point of arrows and lines, z-coordinate	0
Legend	makes a legend entry	
LegendText	short explanatory text for legend	
LegendEntry	add this object to the legend?	FALSE
LineColor	color of lines	RGB: :Blue
LineWidth	width of lines	0.35
LineStyle	solid, dashed or dotted lines?	Solid
Name	the name of a plot object (for browser and legend)	
ParameterEnd	end value of the animation parameter	
ParameterName	name of the animation parameter	
ParameterBegin	initial value of the animation parameter	
ParameterRange	range of the animation parameter	
TimeEnd	end time of the animation	10.0
TimeBegin	start time of the animation	0.0
TimeRange	the real time span of an animation	0.0 .. 10.0
Title	object title	
TitleFont	font of object titles	[" sans-serif ", 11]
TitlePosition	position of object titles	
TitleAlignment	horizontal alignment of titles w.r.t. their coordinates	Center

Attribute	Purpose	Default Value
TitlePositionX	position of object titles, x component	
TitlePositionY	position of object titles, y component	
TitlePositionZ	position of object titles, z component	
To	end point of arrows and lines	[1, 0, 0]
ToX	end point of arrows and lines, x-coordinate	1
ToY	end point of arrows and lines, y-coordinate	0
ToZ	end point of arrows and lines, z-coordinate	0
Tubular	display 3D arrows and lines as tubes?	FALSE
TubeDiameter	diameter of tubular arrows and lines.	1.0
Visible	visibility	TRUE
VisibleAfter	object visible after this time value	
VisibleBefore	object visible until this time value	
VisibleFromTo	object visible during this time range	
VisibleAfterEnd	object visible after its animation time ended?	TRUE
VisibleBeforeBegin	object visible before its animation time starts?	TRUE

## Examples

### Example 1

Plot two animated 3D line segments starting off parallel and ending up skew:

```
plot(plot::Line3d([0, 0, 0], [a, a, 1], a = 0..1),
      plot::Line3d([1, 0, 0], [a, 0, 1], a = 1..0))
```

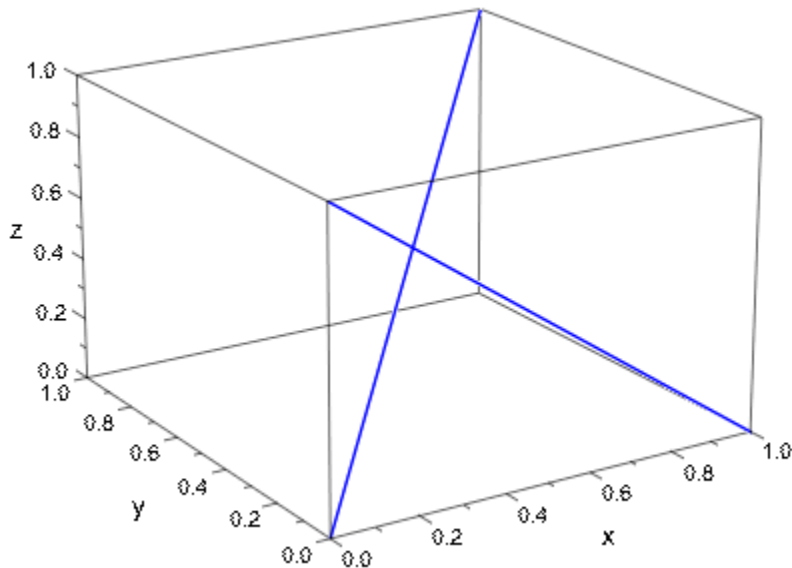

In addition to `LineStyle`, `LineColor` and `LineWidth`, 3D line segments support the style option `Tubular`. If this is set to `TRUE`, the `TubeDiameter` can be set explicitly:

```
plot(plot::Line3d([0.1, 0, 0], [1, 0, 0]),
      plot::Line3d([0, 0.1, 0], [0, 1, 0]),
      plot::Line3d([0, 0, -0.1], [0, 0, -1]),
      ViewingBox = [-0.2..1.2, -0.2..1.2, -1..0.2],
      Tubular = TRUE, TubeDiameter = 5.0*unit::mm)
```

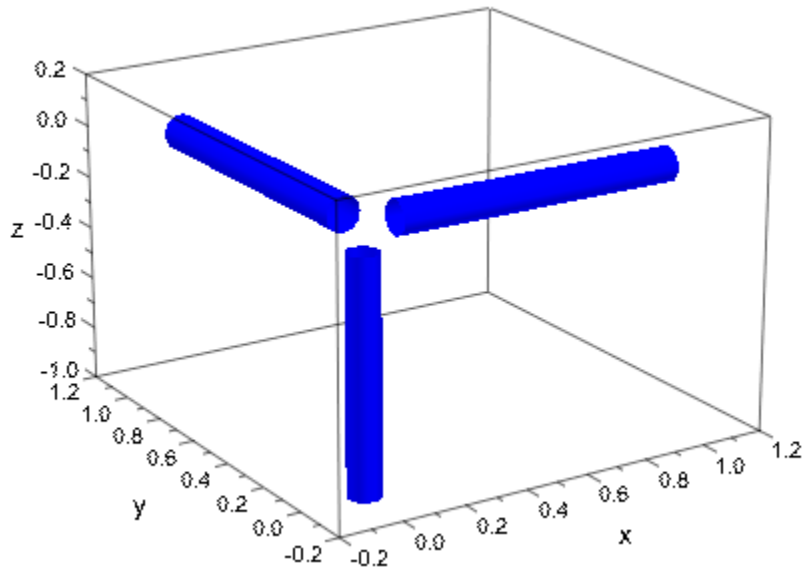

## Parameters

**$x_1, y_1, z_1$**

Coordinates of one end point: real numerical values or arithmetical expressions (Symbolic Math Toolbox) of the animation parameter  $a$ .

$x_1, y_1, z_1$  are equivalent to the attributes FromX, FromY, FromZ.

**$x_2, y_2, z_2$**

Coordinates of the other end point: real numerical values or arithmetical expressions (Symbolic Math Toolbox) of the animation parameter  $a$ .

$x_2, y_2, z_2$  are equivalent to the attributes ToX, ToY, ToZ.

**$a$**

Animation parameter, specified as  $a = a_{\min} \dots a_{\max}$ , where  $a_{\min}$  is the initial parameter value, and  $a_{\max}$  is the final parameter value.

## See Also

### **MuPAD Functions**

`plot` | `plot::copy`

### **MuPAD Graphical Primitives**

`plot::Line2d` | `plot::Polygon2d` | `plot::Polygon3d` | `plot::Rectangle`

# plot::Listplot

Finite lists of 2D points

## Syntax

```
plot::Listplot([y1, y2, ...], <x = xmin .. xmax>, <a = amin .. amax>, options)
```

```
plot::Listplot(A1, <x = xmin .. xmax>, <a = amin .. amax>, options)
```

```
plot::Listplot([[x1, y1], [x2, y2], ...], <a = amin .. amax>, options)
```

```
plot::Listplot(A2, <a = amin .. amax>, options)
```

## Description

`plot::Listplot` serves for visualizing discrete data values  $[y_1, y_2, \dots]$ . If no range  $x = x_{\min} \dots x_{\max}$  is specified, the data are plotted as the points  $[x_1, y_1], [x_2, y_2]$  etc. with equidistant  $x$ -values  $x_1 = 1, x_2 = 2$  etc. If a range  $x = x_{\min} \dots x_{\max}$  is specified, equidistant  $x$ -values between  $x_{\min}$  and  $x_{\max}$  are used.

If the data are specified as a list of coordinate pairs  $[[x_1, y_1], [x_2, y_2], \dots]$ , `plot::Listplot` generates plot points with these coordinates.

With the attribute `LinesVisible = TRUE`, each pair of consecutive data points is connected by a curve.

With `InterpolationStyle = Linear` (default), the points are connected by straight line segments.

With `InterpolationStyle = Cubic`, a cubic spline curve is used to connect the points. The spline curve between two data points is rendered as a collection of  $m + 1$  straight line segments, where  $m$  is specified by the attribute `Submesh = m`.

Use `LinesVisible = FALSE`, if only the data points without connecting lines are to be rendered.

## Attributes

Attribute	Purpose	Default Value
AffectViewingBox	influence of objects on the ViewingBox of a scene	TRUE
AntiAliased	antialiased lines and points?	TRUE
Data	the (statistical) data to plot	
FillColorDirection	the direction of color transitions on surfaces	[0, 0]
Frames	the number of frames in an animation	50
InterpolationStyle	interpolation via linear or cubic splines	Linear
Legend	makes a legend entry	
LegendText	short explanatory text for legend	
LegendEntry	add this object to the legend?	FALSE
LineColor	color of lines	RGB::Blue
LineWidth	width of lines	0.35
LineColor2	color of lines	RGB::DeepPink
LineStyle	solid, dashed or dotted lines?	Solid
LinesVisible	visibility of lines	TRUE
LineColorType	line coloring types	Flat
LineColorFunction	functional line coloring	
LineColorDirection	the direction of color transitions on lines	[0, 1]
LineColorDirectionX	x-component of the direction of color transitions on lines	0
LineColorDirectionY	y-component of the direction of color transitions on lines	1



Attribute	Purpose	Default Value
LineColorDirectionZ	z-component of the direction of color transitions on lines	1
Name	the name of a plot object (for browser and legend)	
ParameterEnd	end value of the animation parameter	
ParameterName	name of the animation parameter	
ParameterBegin	initial value of the animation parameter	
ParameterRange	range of the animation parameter	
PointSize	the size of points	1.5
PointColor	the color of points	RGB::Black
PointStyle	the presentation style of points	FilledCircles
PointsVisible	visibility of mesh points	TRUE
Submesh	density of submesh (additional sample points)	6
TimeEnd	end time of the animation	10.0
TimeBegin	start time of the animation	0.0
TimeRange	the real time span of an animation	0.0 .. 10.0
Title	object title	
TitleFont	font of object titles	[" sans-serif ", 11]
TitlePosition	position of object titles	
TitleAlignment	horizontal alignment of titles w.r.t. their coordinates	Center
TitlePositionX	position of object titles, x component	

Attribute	Purpose	Default Value
TitlePositionY	position of object titles, y component	
Visible	visibility	TRUE
VisibleAfter	object visible after this time value	
VisibleBefore	object visible until this time value	
VisibleFromTo	object visible during this time range	
VisibleAfterEnd	object visible after its animation time ended?	TRUE
VisibleBeforeBegin	object visible before its animation time starts?	TRUE
XMax	final value of parameter "x"	
XMin	initial value of parameter "x"	
XName	name of parameter "x"	
XRange	range of parameter "x"	
XSubmesh	density of additional sample points for parameter "x"	6

## Examples

### Example 1

We plot 5 discrete data values as points with equidistant x-values 1, 2, 3, 4, 5:

```
plot(plot::Listplot([1, 0, 1, 0, 1]))
```

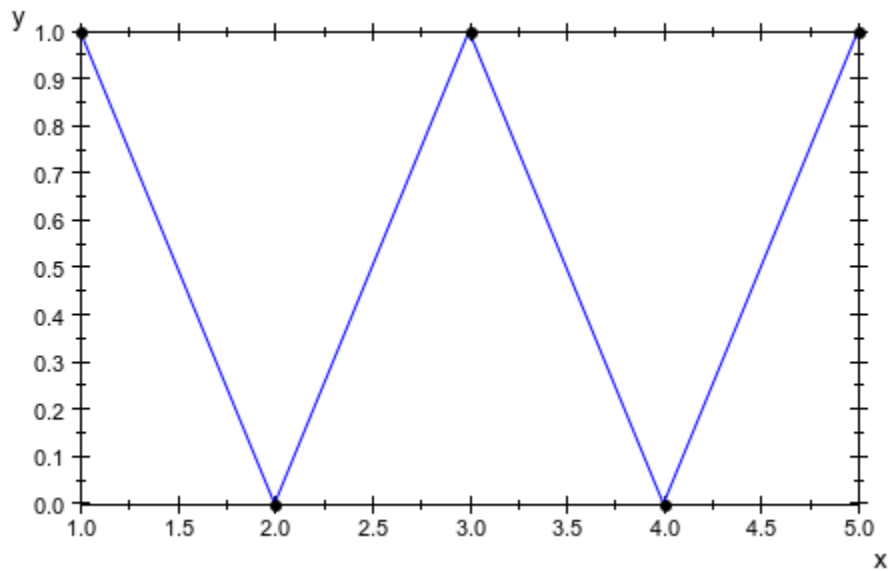

We plot two data samples and place them side by side by specifying suitable ranges for the horizontal variable:

```
plot(plot::Listplot([1, 0, 2, 1], x = 0..1, Color = RGB::Red),  
      plot::Listplot([0, 1, 0, 2], x = 1..2, Color = RGB::Blue))
```

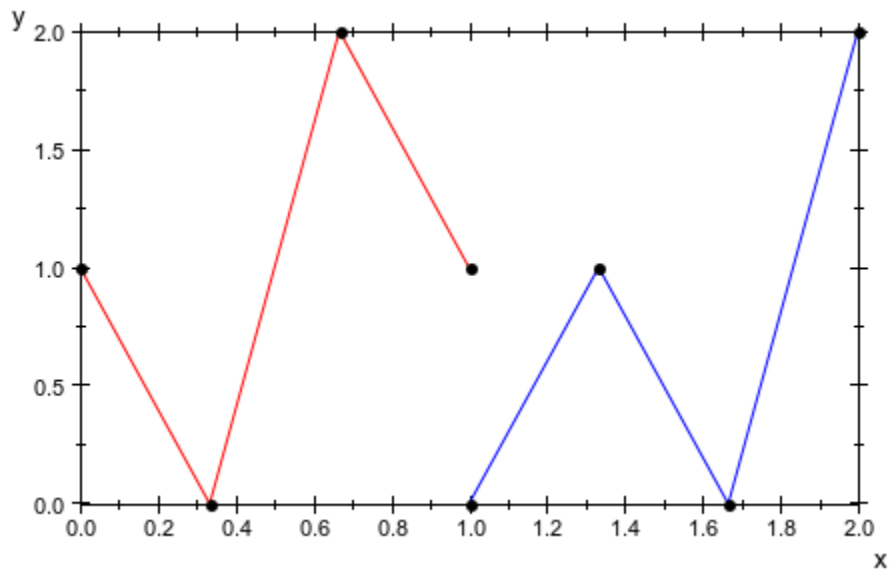

We specify x-coordinates for the data points:

```
plot(plot::Listplot([[0.1, 1], [0.15, 0], [0.2, 1],  
                    [0.3, 0], [0.5, 1]]))
```

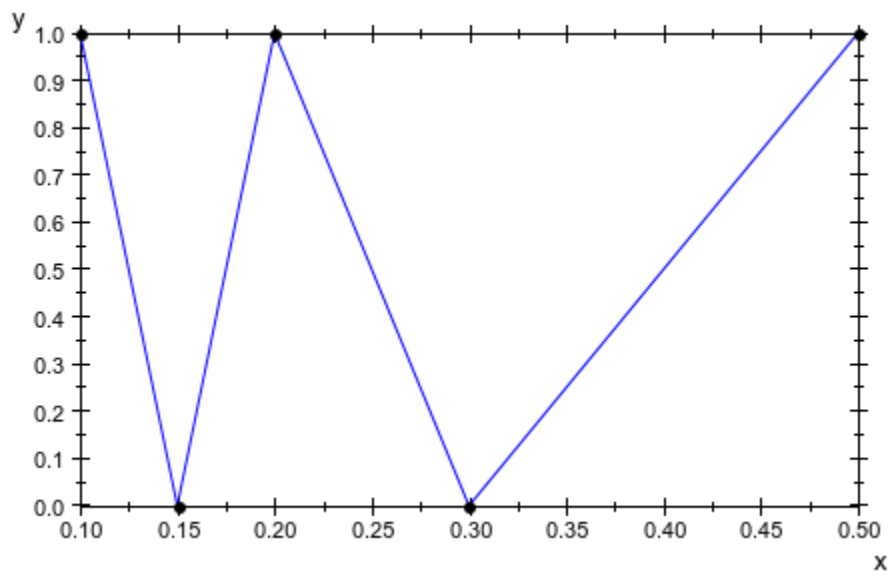

## Example 2

We demonstrate the difference between linear and cubic spline interpolation:

```
plot(plot::Listplot([10, 0, 20, 0, 30], Color = RGB::Red,  
                    InterpolationStyle = Linear),  
      plot::Listplot([10, 0, 20, 0, 30], Color = RGB::Blue,  
                    InterpolationStyle = Cubic))
```

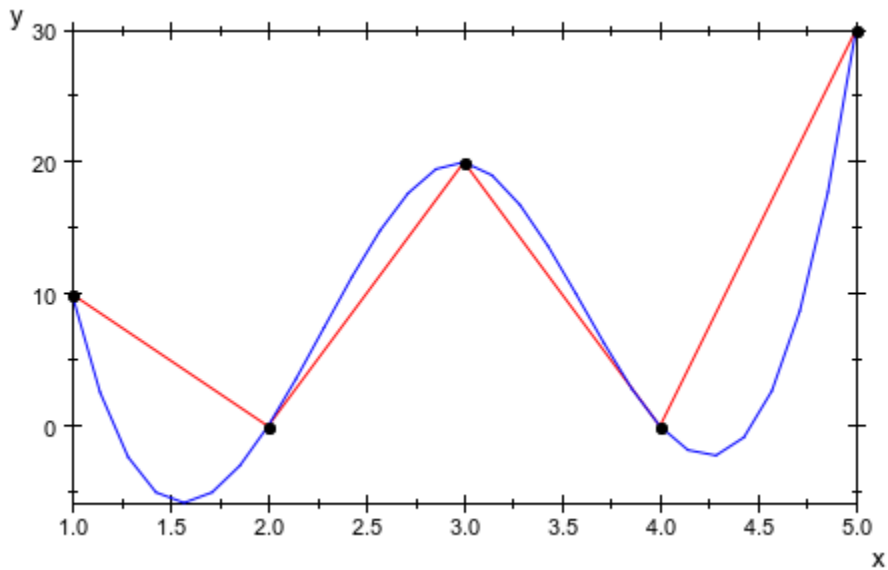

We smoothen the cubic spline curve by increasing the Submesh value:

```
plot(plot::Listplot([10, 0, 20, 0, 30], Color = RGB::Red,  
                  InterpolationStyle = Linear),  
      plot::Listplot([10, 0, 20, 0, 30], Color = RGB::Blue,  
                  InterpolationStyle = Cubic, Submesh = 12))
```

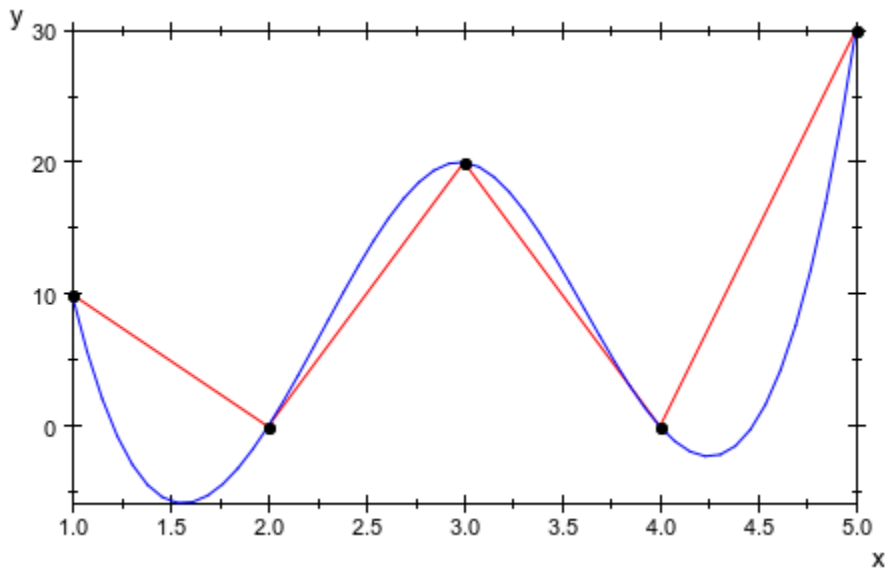

### Example 3

A random variable describing the number of successes in  $n$  Bernoulli trials with success probability  $p$  is binomially distributed with expectation value  $np$  and variance  $np(1-p)$ . For large values of  $n$ , the binomial distribution on page 30-19 is approximated by a corresponding normal distribution on page 30-367.

We use `plot::Listplot` to visualize the discrete probability values of the binomial distribution. The normal distribution is visualized via `plot::Function2d`:

```
n := 10: p:= 0.4:
plot(plot::Listplot([stats::binomialPF(n, p)(i) $ i = 0..n],
  x = 0..n, Color = RGB::Red),
  plot::Function2d(stats::normalPDF(n*p, n*p*(1 - p))(x),
  x = 0..n, Color = RGB::Blue)):
```

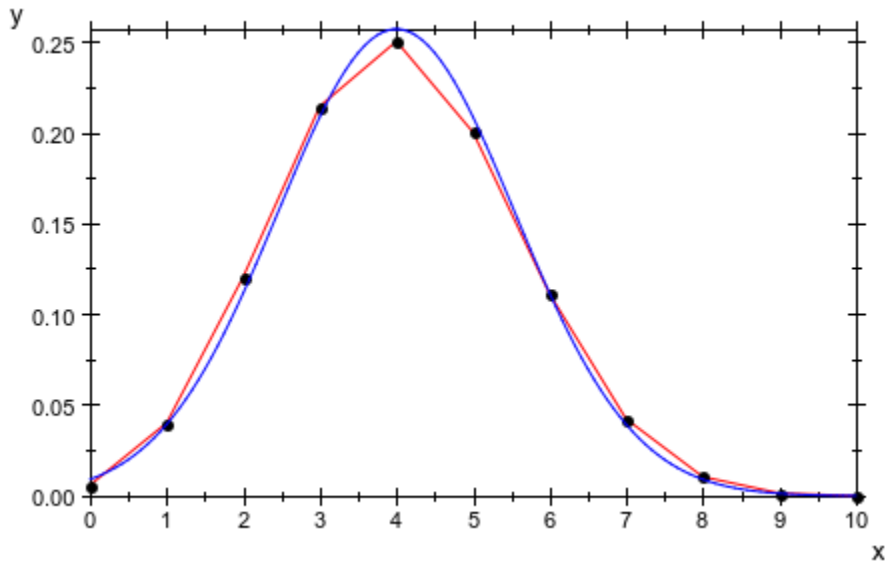

delete n, p:

## Parameters

$y_1, y_2, \dots$

Vertical coordinates: numerical values or expressions of the animation parameter  $a$ .

$y_1, y_2, \dots$  is equivalent to the attribute `Data`.

$x$

Name of the horizontal coordinate: an identifier on page 7-29 or an indexed identifier on page 1-1017. It is used as the title of the coordinate axis in  $x$  direction.

$x$  is equivalent to the attribute `XName`.

$x_{\min} \dots x_{\max}$

The range of the horizontal coordinate:  $x_{\min}, x_{\max}$  must be numerical real value or expressions of the animation parameter  $a$ .



$x_{\min} .. x_{\max}$  is equivalent to the attributes XRange, XMin, XMax.

### **A<sub>1</sub>**

A 1-dimensional array of domain type DOM\_ARRAY or a matrix of category Cat::Matrix (e.g., of type matrix or densmatrix) with 1 row or 1 column. The entries must be numerical real values or arithmetical expressions (Symbolic Math Toolbox) of the animation parameter a. The entries in A<sub>1</sub> are regarded as data values [y<sub>1</sub>, y<sub>2</sub>] etc..

A<sub>1</sub> is equivalent to the attribute Data.

### **x<sub>1</sub>, x<sub>2</sub>, ...**

Horizontal coordinates: numerical values or expressions of the animation parameter a.

### **A<sub>2</sub>**

A 2-dimensional array of domain type DOM\_ARRAY or a matrix of category Cat::Matrix (e.g., of type matrix or densmatrix) with at least two rows and two columns. The entries must be numerical real values or arithmetical expressions (Symbolic Math Toolbox) of the animation parameter a. The *i*-th row is regarded as the data point (x<sub>*i*</sub>, y<sub>*i*</sub>). If more than 2 columns are provided, only the data in the first two columns are considered; all additional columns are ignored.

A<sub>2</sub> is equivalent to the attribute Data.

### **a**

Animation parameter, specified as  $a = a_{\min} .. a_{\max}$ , where  $a_{\min}$  is the initial parameter value, and  $a_{\max}$  is the final parameter value.

## **See Also**

### **MuPAD Functions**

plot | plot::copy

### **MuPAD Graphical Primitives**

plot::PointList2d | plot::Polygon2d | plot::Scatterplot

## plot::Lsys

Lindenmayer systems

### Syntax

```
plot::Lsys(alpha, start, trans, ..., <a = amin .. amax>, options)
```

### Description

`plot::Lsys` creates Lindenmayer systems, i.e., string rewriting systems controlling turtle graphics on page 24-989.

Lindenmayer systems, or L-systems for short, are based on the concept of iteratively transforming a string of symbols into another string. After a finite number of iterations, the resulting string is translated into a sequence of movement commands to a “turtle” (see `plot::Turtle`), which can be drawn on the screen.

In `plot::Lsys`, the string of symbols is represented by a string of characters, i.e., a `DOM_STRING`. *Transformation rules* are given as equations mapping strings of length 1 to strings of arbitrary length. *Turtle rules* are given as equations mapping strings of length 1 to simple movement commands: `Line`, `Move`, `Left`, `Right`, `Push`, `Pop`, `Noop`, or a color specification.

The commands are mostly self-explanatory. `Left` and `Right` turn by the amount set in the slot `RotationAngle`; the initial direction is “up”. `Line` and `Move` move by the amount set in `StepLength`, where `Move` does not draw a line. `Push` stores the current state (position, direction, color) on a stack from where it can later be reactivated using `Pop`. `Noop` means “ignore this, no operation”. A color specification changes the line color.

The following turtle rules are used by default (but can be disabled by giving other rules for the left-hand sides):

```
"F" = Line, "f" = Move, "[" = Push, "]" = Pop, "+" = Left, "-" = Right.
```

## Attributes

Attribute	Purpose	Default Value
AffectViewingBox	influence of objects on the ViewingBox of a scene	TRUE
AntiAliased	antialiased lines and points?	FALSE
Color	the main color	RGB::Blue
Frames	the number of frames in an animation	50
Generations	number of iterations of L-system rules	5
IterationRules	iteration rules of an L-system	
Legend	makes a legend entry	
LegendText	short explanatory text for legend	
LegendEntry	add this object to the legend?	FALSE
LineColor	color of lines	RGB::Blue
LineWidth	width of lines	0.35
LineStyle	solid, dashed or dotted lines?	Solid
LinesVisible	visibility of lines	TRUE
Name	the name of a plot object (for browser and legend)	
ParameterEnd	end value of the animation parameter	
ParameterName	name of the animation parameter	
ParameterBegin	initial value of the animation parameter	

<b>Attribute</b>	<b>Purpose</b>	<b>Default Value</b>
ParameterRange	range of the animation parameter	
RotationAngle	angle of rotation commands in L-systems	
StartRule	start rule of an L-system	
StepLength	length of movement commands in L-systems	1.0
TimeEnd	end time of the animation	10.0
TimeBegin	start time of the animation	0.0
TimeRange	the real time span of an animation	0.0 .. 10.0
Title	object title	
TitleFont	font of object titles	[" sans-serif ", 11]
TitlePosition	position of object titles	
TitleAlignment	horizontal alignment of titles w.r.t. their coordinates	Center
TitlePositionX	position of object titles, x component	
TitlePositionY	position of object titles, y component	
TurtleRules	rules translating L-system symbols to turtle movements	
Visible	visibility	TRUE
VisibleAfter	object visible after this time value	
VisibleBefore	object visible until this time value	
VisibleFromTo	object visible during this time range	

Attribute	Purpose	Default Value
VisibleAfterEnd	object visible after its animation time ended?	TRUE
VisibleBeforeBegin	object visible before its animation time starts?	TRUE

## Examples

### Example 1

As a very simple system, we consider the following iteration rule: “replace each line forward by the sequence “line forward, move forward without painting, line forward.””:

```
l := plot::Lsys(0, "F", "F" = "FfF");
```

Note that we do not provide an iteration rule for "f". This means “leave f alone, do not change it.”

The start state is displayed by plotting the system after zero generations:

```
l::Generations := 0:  
plot(l)
```



Increasing the number of generations, we see the effect of our transformation rule:

```
l::Generations := 1:  
plot(l)
```



```
l::Generations := 2:  
plot(l)
```

|

|

|

|

```
l::Generations := 3:  
plot(l)
```





The following variant of this simple example produces approximations to the Cantor set:

```
l := plot::Lsys(0, "F", "F" = "FfF", "f" = "fff");  
plot(l)
```



## Example 2

To get more interesting examples, we include rotations into our rules:

```
l := plot::Lsys(PI/2, "F-F-F-F", "F" = "F-F+F+FF-F-F+F",  
Generations = 3)
```

```
plot::Lsys( $\frac{\pi}{2}$ , "F-F-F-F", IterationRules = ["F" = "F-F+F+FF-F-F+F"], TurtleRules =  
[], Generations = 3)
```

As you can see, `plot::Lsys` has detected that our rule is an iteration rule. We could have used this syntax directly when creating the object. We have not given turtle rules, so the defaults are used:

```
plot(l)
```

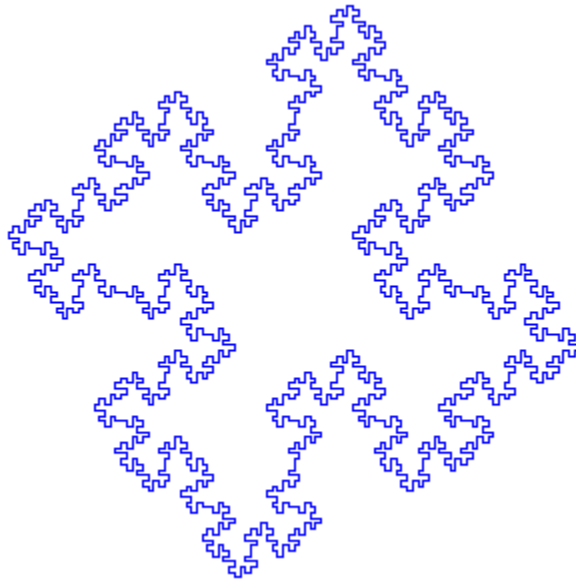

### Example 3

The Peano curve is a famous example of a space filling curve. In the limit process, increasing the number of iterations while decreasing the length of the forward steps, it actually fills the plane. There are different constructions known, the one shown here fills a square tilted by  $45^\circ$ :

```
peano := plot::Lsys(PI/2, "F", "F" = "F+F-F-F-F+F+F-F"):
```

The transformation rule says to replace each straight line with the following construction:

```
peano::Generations := 1:
plot(peano)
```

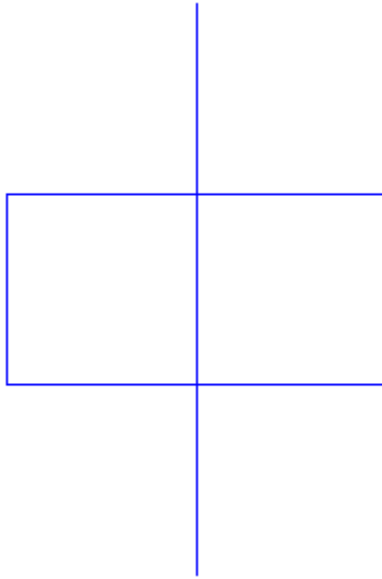

After a few iterations, the lines already get very close to one another:

```
peano::Generations := 5:  
plot(peano)
```

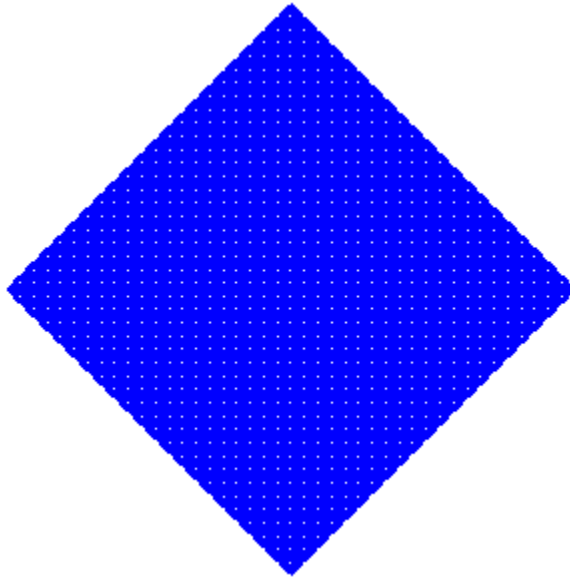

### Example 4

Many L-systems contain different types of lines: While they are drawn exactly the same, their transformation rules are different from one another. The following example shows an image similar to the Sierpinski triangle:

```
l := plot::Lsys(PI/3, "R", "L" = "R+L+R", "R" = "L-R-L",  
                "L" = Line, "R" = Line,  
                Generations = 7):  
plot(l)
```

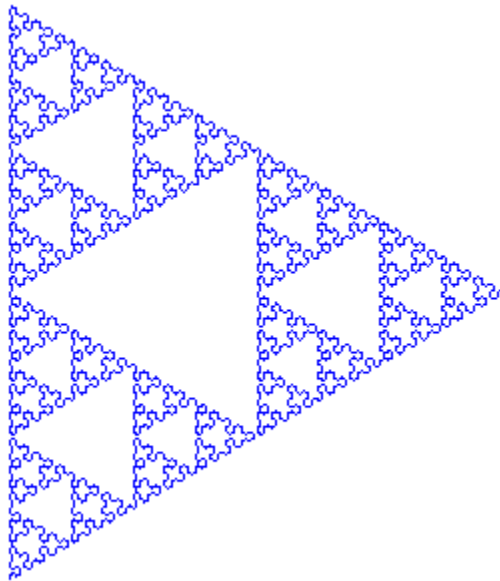

### Example 5

The Push and Pop operations can be used to draw “arms” in an L-system:

```
plot(plot::Lsys(23*PI/180, "F", "F" = "FF-[-F+F+F][+F-F-F]",  
Generations = 4))
```

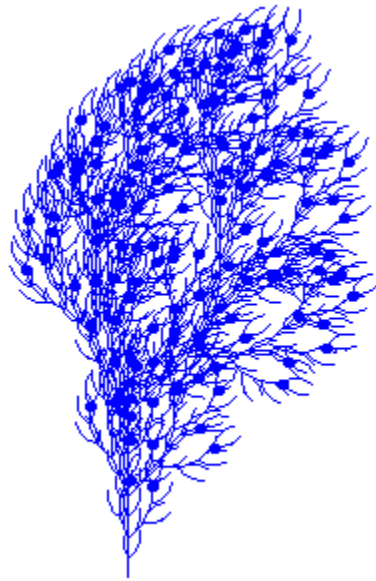

## Example 6

L-systems have been used to simulate plant growth. We show an example here that uses the symbols B, H, and G to change the color of lines:

```
l := plot::Lsys(PI/9, "BL", "L" = "BR[+HL]BR[-GL]+HL",  
                "R" = "RR", "L" = Line, "R" = Line,  
                "B" = RGB::Brown, "H" = RGB::ForestGreen,  
                "G" = RGB::SpringGreen, Generations = 6):  
plot(l)
```

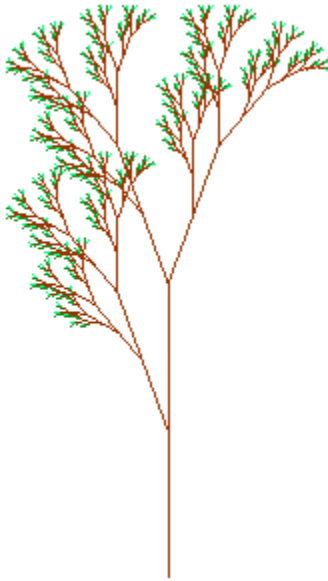

The attribute `Generations` can be animated. This way, we can actually make the “plant” “grow:”

```
plot(plot::Lsys(a*PI/45, "BL", "L" = "BR[+HL]BR[-GL]+HL", "R" = "RR",  
  "L" = Line, "R" = Line, "B" = RGB::Brown,  
  "H" = RGB::ForestGreen, "G" = RGB::SpringGreen,  
  Generations = a, a = 1 .. 6)):
```



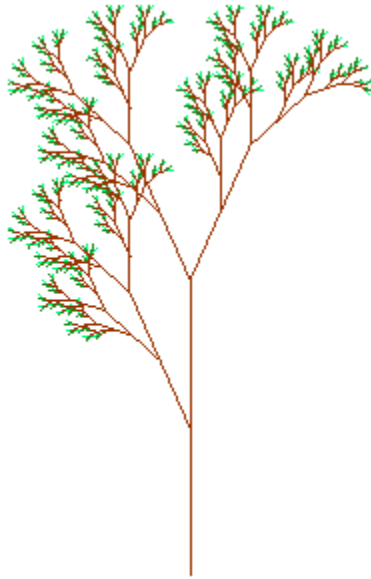

## Example 7

L-systems can display a couple of popular fractals. One example is the Koch snowflake, generated by replacing each straight line with a straight line, followed by a left turn of  $60^\circ$ , another straight line, a right turn of  $120^\circ$ , another straight line, another left turn of  $60^\circ$  and a final straight line:

```
koch := plot::Lsys(PI/3, "F--F--F", "F" = "F+F--F+F"):
```

The starting rule has been chosen to be an equilateral triangle:

```
koch::Generations := 0:  
plot(koch)
```

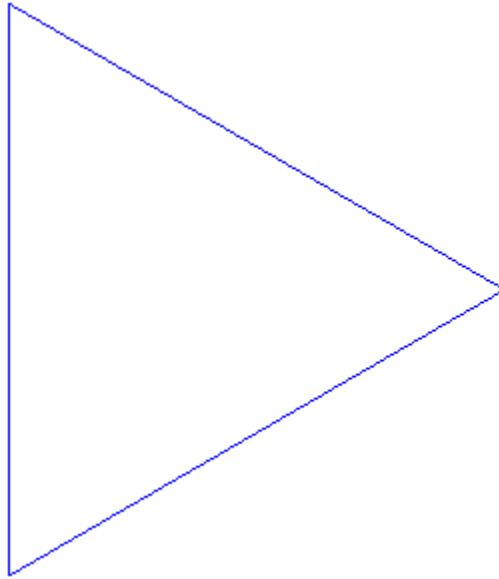

The first generation looks like this:

```
koch::Generations := 1:  
plot(koch)
```

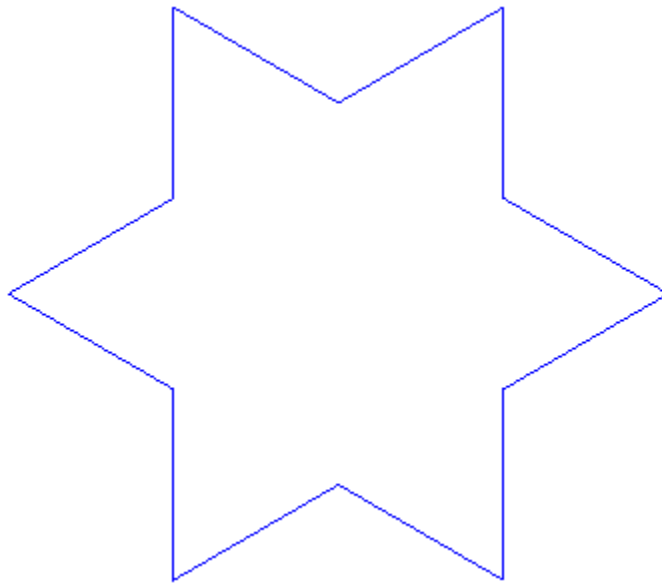

The limit is pretty well approximated after five generations:

```
koch::Generations := 5:  
plot(koch)
```

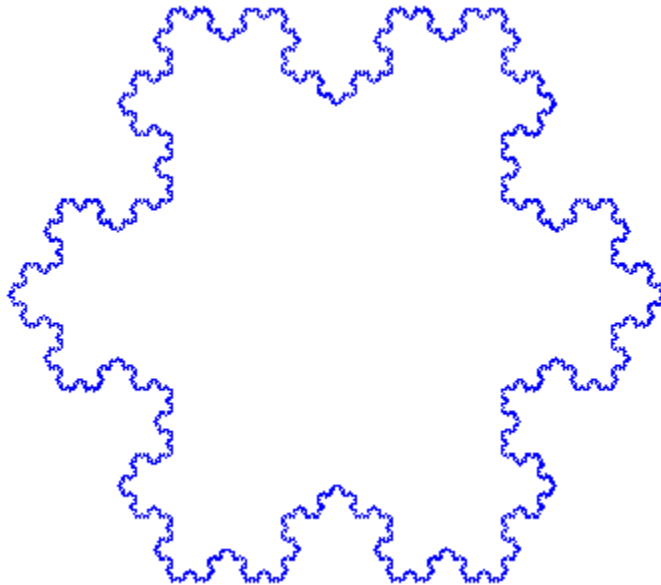

Finally, we use `plot::modify` and the "StepLength" slot to show the first couple of iterations superimposed on one another:

```
colors := [RGB::Red, RGB::Green, RGB::Blue, RGB::Yellow, RGB::DimGrey]:  
plot(plot::modify(koch, Generations = i,  
                 StepLength = 3^(-i),  
                 LineColor = colors[i+1]) $ i = 0..4)
```

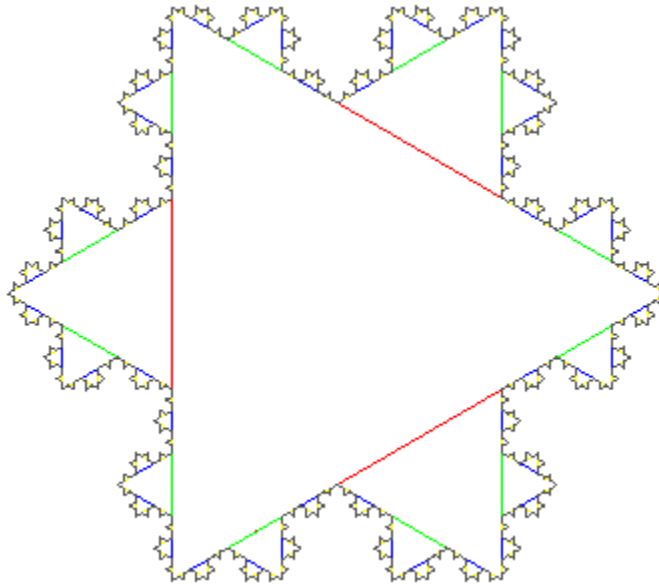

### Example 8

Another well-known example of a fractal generated by an L-system is Heighway's Dragon curve. Informally, it is generated by "drawing a right angle and then replacing each right angle by a smaller right angle" (Gardner). It has been used in the book "Jurassic Park" by Michael Crichton and thereby got another nickname, the "Jurassic Park fractal:"

```
plot(plot::Lsys(PI/2, "L", "L" = "L+R+", "R" = "-L-R",  
               "L" = Line, "R" = Line, Generations = 9))
```

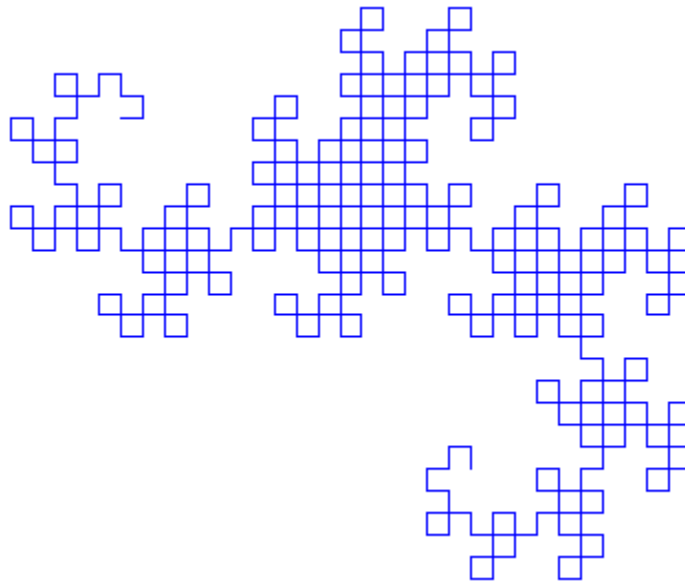

It is interesting to note that the iteration rules of this curve are equivalent to appending a mirrored copy of the curve to its end:

```
plot(plot::Lsys(PI/2, "L", "L" = "L+R+", "R" = "-L-R",  
             "L" = Line, "R" = Line, Generations = a,  
             a = 1..9))
```

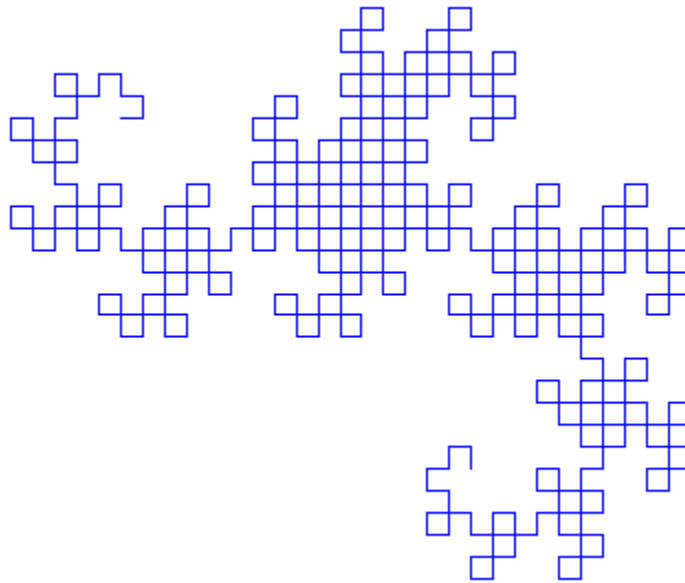

### Example 9

While the L-system of the previous example corresponds to the definition found in the literature, the images in at least one popular source show another system (while the definition given is the one from above), namely:

```
plot(plot::Lsys(PI/4, "X-F-Y", "X" = "X+F+Y", "Y" = "X-F-Y",  
"X" = Line, "Y" = Line, Generations = 9)):
```

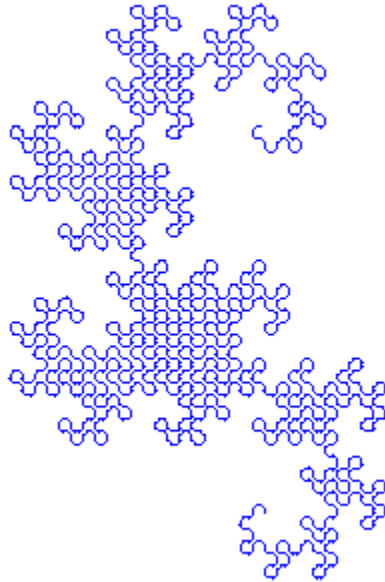

### Example 10

An L-system may contain letters that are not meant to show in the final graphic, so they form some sort of “markers” for subsequent iterations. For this purpose, you may use the turtle rule `Noop`:

```
plot(plot::Lsys(PI/12,  
  "X+X+X+X+X+X+X+X+X+X+X+X+X+X+X+X+X+X+X+X+X+X+X",  
  "X" = "[F+F+F+F[---X-Y]+++++F++++++F-F-F-F]",  
  "Y" = "[F+F+F+F[---Y]+++++F++++++F-F-F-F]",  
  "X" = Noop, "Y" = Noop,  
  Generations = 3))
```



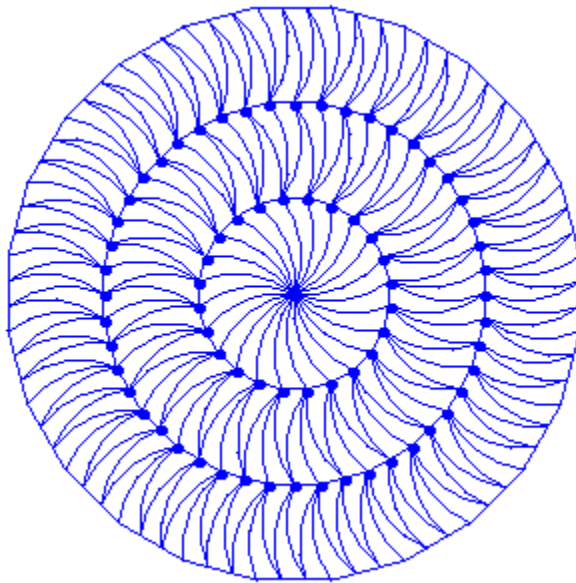

```
plot(plot::Lsys(PI/2, "FB",  
  "A" = "FBFA+HFA+FB-FA", "B" = "FB+FA-FB-JFBFA",  
  "F" = "", "H" = "-", "J" = "+",  
  "A" = Noop, "B" = Noop, "H" = Noop, "J" = Noop))
```

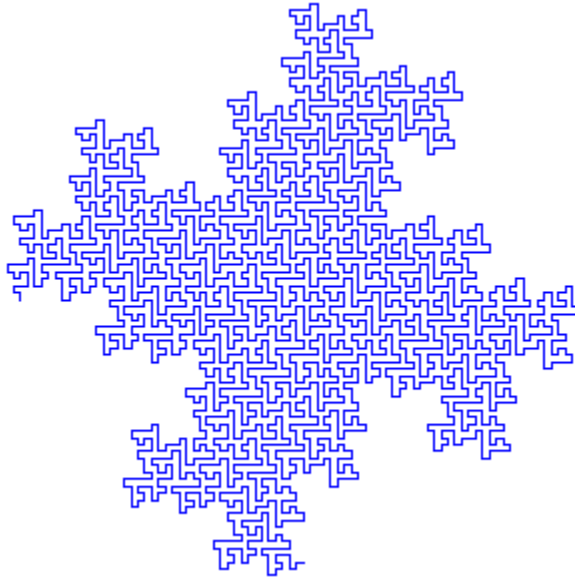

### Example 11

Using this rule, we can use the following formulation of the popular Hilbert curve due to Ken Philip:

```
plot(plot::Lsys(PI/2, "x", "x" = "-yF+xFx+Fy-", "y" = "+xF-yFy-Fx+",  
"x" = Noop, "y" = Noop))
```

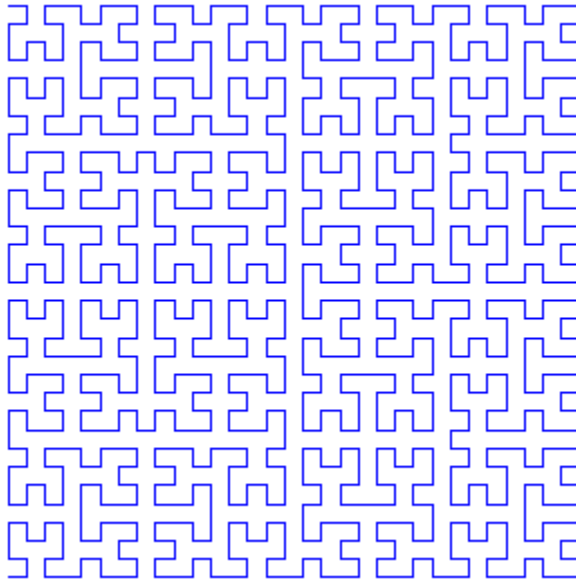

To animate the creation process of the Hilbert curve, we adjust the length of the lines to the current number of iteration steps:

```
plot(plot::Lsys(PI/2, "x", "x" = "-yF+xFx+Fy-", "y" = "+xF-yFy-Fx+",  
               "x" = Noop, "y" = Noop,  
               Generations = i, StepLength = 1/(2^i-1),  
               i = 1..6, Frames = 6))
```

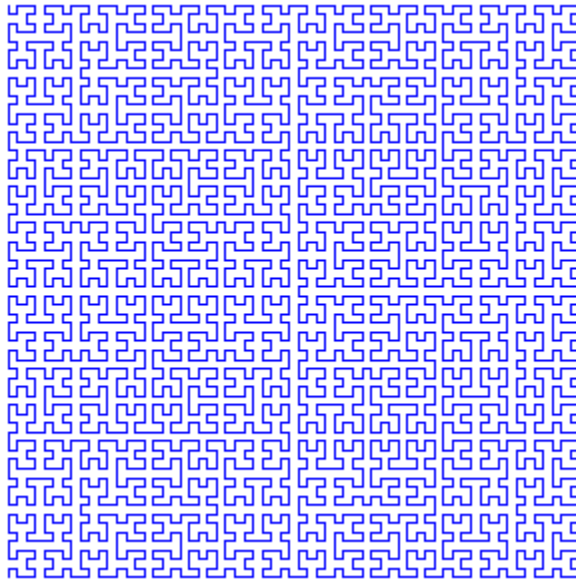

### Example 12

In some cases, systems will need small angles and long strings in order to specify the desired directions. Take for example the following system:

```
plot(plot::Lsys(7*PI/15, "F", "F"="F+F--F+F",  
Generations=4))
```

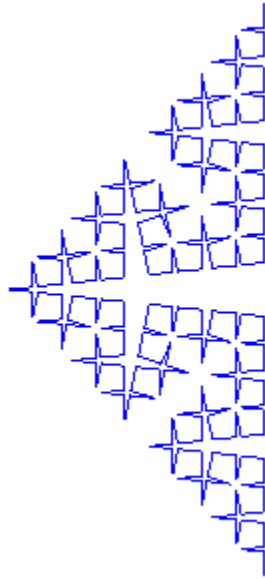

The rotations to the right use an angle of  $\frac{7\pi}{15}$ , while that to the left (the sharp spike) is a turn of  $\frac{14\pi}{15}$ . It would look more natural, however, to have the turtle start to the right, i.e., at an angle of  $-\frac{\pi}{2}$ . Since no multiple of  $\frac{7\pi}{15}$  is equal to  $\frac{\pi}{2}$  modulo  $2\pi$ , this requires that we use a smaller angle, adjusting our iteration rule:

```
plot(plot::Lsys(7*PI/30,"+++++F",
  "F"="F++F----F++F", Generations=4))
```

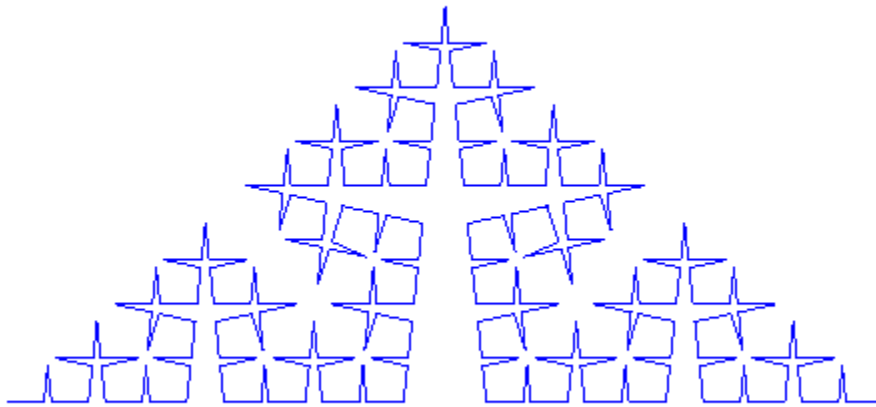

## Parameters

### **alpha**

Angle (in radians) for turning commands. Animatable.

alpha is equivalent to the attribute `RotationAngle`.

### **start**

String on page 7-53 used as the starting rule.

start is equivalent to the attribute `StartRule`.

### **trans, ...**

Iteration and Turtle command rules (see below).

trans, ... is equivalent to the attributes `IterationRules`, `TurtleRules`.

**a**

Animation parameter, specified as  $\mathbf{a} = \mathbf{a}_{\min} \dots \mathbf{a}_{\max}$ , where  $\mathbf{a}_{\min}$  is the initial parameter value, and  $\mathbf{a}_{\max}$  is the final parameter value.

## Algorithms

Lindenmayer systems are “string rewriting systems.” MuPAD implements only context-free L-systems, which are analyzed in a similar context as context-free grammars.

Many examples of L-systems can be found, among other places, in “The Fractal Geometry of Nature” by Benoît Mandelbrot.

## See Also

**MuPAD Functions**

plot | plot::copy

**MuPAD Graphical Primitives**

plot::Turtle

## plot::Matrixplot

Surface plot of matrix data

### Syntax

```
plot::Matrixplot(A, options)
```

```
plot::Matrixplot(A, x = x_min .. x_max, y = y_min .. y_max, <a = a_min .. a_max>, options)
```

```
plot::Matrixplot(row_1, row_2, ..., options)
```

```
plot::Matrixplot(row_1, row_2, ..., x = x_min .. x_max, y = y_min .. y_max, <a = a_min .. a_max>, options)
```

```
plot::Matrixplot([row_1, row_2, ...], options)
```

```
plot::Matrixplot([row_1, row_2, ...], x = x_min .. x_max, y = y_min .. y_max, <a = a_min .. a_max>, options)
```

```
plot::Matrixplot(s, <c_1, c_2, ...>, options)
```

```
plot::Matrixplot(s, <c_1, c_2, ...>, x = x_min .. x_max, y = y_min .. y_max, <a = a_min .. a_max>, options)
```

```
plot::Matrixplot(s, <[c_1, c_2, ...]>, options)
```

```
plot::Matrixplot(s, <[c_1, c_2, ...]>, x = x_min .. x_max, y = y_min .. y_max, <a = a_min .. a_max>, options)
```

### Description

`plot::Matrixplot(A)` visualizes the matrix  $A$  as a 3D function graph by interpolating the matrix values as a function of the matrix indices.

`Matrixplot` interprets the indices of a matrix as  $x$  and  $y$  coordinates and the corresponding matrix entry as the corresponding  $z$  coordinate. Thus, the matrix is regarded as a discretized function in 2 variables. The function graph is displayed as a 3D surface using interpolation between the data points.

If no ranges  $x = x_{\min} \dots x_{\max}$ ,  $y = y_{\min} \dots y_{\max}$  are specified, the matrix entry  $A[i, j]$  is displayed as the 3D point  $x = j, y = i, z = A[i, j]$  with integer positions  $i, j$ . If plot ranges are specified, the matrix indices  $i, j$  are used to define an equidistant mesh in the plot range.



The attribute `InterpolationStyle` allows to define the surface via linear or cubic spline interpolation of the data points: Choose between `InterpolationStyle = Linear` or `InterpolationStyle = Cubic`. The default is linear interpolation. With cubic interpolation, the data surface may be smoothed by setting the numbers  $m_x$ ,  $m_y$  of plot points between the data points via the attribute `Submesh = [m_x, m_y]`. The numbers  $m_x$ ,  $m_y$  must be (small) non-negative integers.

With `InterpolationStyle = Linear`, symbolic values and complex numbers are accepted and ignored, leading to gaps in the surface. With `InterpolationStyle = Cubic`, symbolic values or complex numbers lead to an error. Cf. “Example 4” on page 24-498 (Symbolic Math Toolbox).

Per default, the data points are rendered on the surface. Use `PointsVisible = FALSE` to make them disappear.

Animations are triggered by specifying a range `a = `a_{min}` .. `a_{max}`` for a parameter `a` that is different from the variables `x`, `y`. Thus, in animations, both the ranges `x = `x_{min}` .. `x_{max}``, `y = `y_{min}` .. `y_{max}`` as well as the animation range `a = `a_{min}` .. `a_{max}`` must be specified.

## Attributes

Attribute	Purpose	Default Value
<code>AffectViewingBox</code>	influence of objects on the <code>ViewingBox</code> of a scene	TRUE
<code>Color</code>	the main color	RGB: :Red
<code>Data</code>	the (statistical) data to plot	
<code>Filled</code>	filled or transparent areas and surfaces	TRUE
<code>FillColor</code>	color of areas and surfaces	RGB: :Red
<code>FillColor2</code>	second color of areas and surfaces for color blends	RGB: :CornflowerBlue
<code>FillColorType</code>	surface filling types	Dichromatic
<code>FillColorFunction</code>	functional area/surface coloring	

<b>Attribute</b>	<b>Purpose</b>	<b>Default Value</b>
FillColorDirection	the direction of color transitions on surfaces	[0, 0, 1]
FillColorDirectionX	x-component of the direction of color transitions on surfaces	0
FillColorDirectionY	y-component of the direction of color transitions on surfaces	0
FillColorDirectionZ	z-component of the direction of color transitions on surfaces	1
Frames	the number of frames in an animation	50
InterpolationStyle	interpolation via linear or cubic splines	Linear
Legend	makes a legend entry	
LegendText	short explanatory text for legend	
LegendEntry	add this object to the legend?	FALSE
LineColor	color of lines	RGB::Black.[0.25]
LineWidth	width of lines	0.35
LineColor2	color of lines	RGB::DeepPink
LineStyle	solid, dashed or dotted lines?	Solid
LineColorType	line coloring types	Flat
LineColorFunction	functional line coloring	
LineColorDirection	the direction of color transitions on lines	[0, 0, 1]
LineColorDirectionX	x-component of the direction of color transitions on lines	0

Attribute	Purpose	Default Value
LineColorDirectionY	y-component of the direction of color transitions on lines	0
LineColorDirectionZ	z-component of the direction of color transitions on lines	1
Name	the name of a plot object (for browser and legend)	
ParameterEnd	end value of the animation parameter	
ParameterName	name of the animation parameter	
ParameterBegin	initial value of the animation parameter	
ParameterRange	range of the animation parameter	
PointSize	the size of points	1.5
PointColor	the color of points	RGB::MidnightBlue
PointStyle	the presentation style of points	FilledCircles
PointsVisible	visibility of mesh points	TRUE
Shading	smooth color blend of surfaces	Smooth
Submesh	density of submesh (additional sample points)	[2, 2]
TimeEnd	end time of the animation	10.0
TimeBegin	start time of the animation	0.0
TimeRange	the real time span of an animation	0.0 .. 10.0
Title	object title	
TitleFont	font of object titles	[" sans-serif ", 11]
TitlePosition	position of object titles	

Attribute	Purpose	Default Value
TitleAlignment	horizontal alignment of titles w.r.t. their coordinates	Center
TitlePositionX	position of object titles, x component	
TitlePositionY	position of object titles, y component	
TitlePositionZ	position of object titles, z component	
Visible	visibility	TRUE
VisibleAfter	object visible after this time value	
VisibleBefore	object visible until this time value	
VisibleFromTo	object visible during this time range	
VisibleAfterEnd	object visible after its animation time ended?	TRUE
VisibleBeforeBegin	object visible before its animation time starts?	TRUE
XLinesVisible	visibility of parameter lines (x lines)	TRUE
XMax	final value of parameter "x"	
XMin	initial value of parameter "x"	
XName	name of parameter "x"	
XRange	range of parameter "x"	
XSubmesh	density of additional sample points for parameter "x"	2
YLinesVisible	visibility of parameter lines (y lines)	TRUE
YMax	final value of parameter "y"	

Attribute	Purpose	Default Value
YMin	initial value of parameter "y"	
YName	name of parameter "y"	
YRange	range of parameter "y"	
YSubmesh	density of additional sample points for parameter "y"	2

## Examples

### Example 1

This example demonstrates the general calling syntax. The data are passed in different ways using a list of rows, an array, and a matrix, respectively:

```
A := [[2, 1, 1],  
      [3, 4, 3],  
      [3, 5, 4],  
      [2, 6, 5]]:  
plot(plot::Matrixplot(A))
```

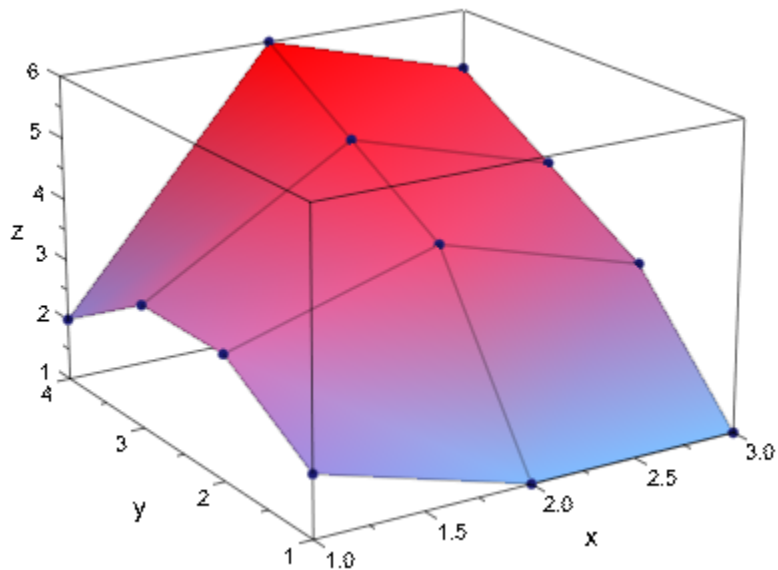

With `InterpolationStyle = Cubic`, the matrix data are plotted as a cubic spline surface:

```
A := array(1..4, 1..3, A):  
plot(plot::Matrixplot(A, InterpolationStyle = Cubic)):
```

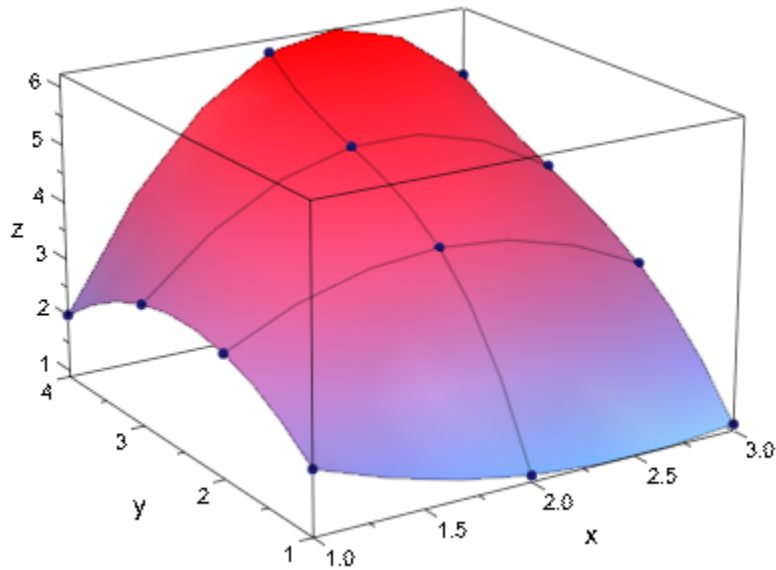

The spline surface can be smoothed by using the Submesh attribute to add further evaluation points:

```
A := matrix(A):  
plot(plot::Matrixplot(A, Submesh = [6, 6],  
    InterpolationStyle = Cubic)):
```

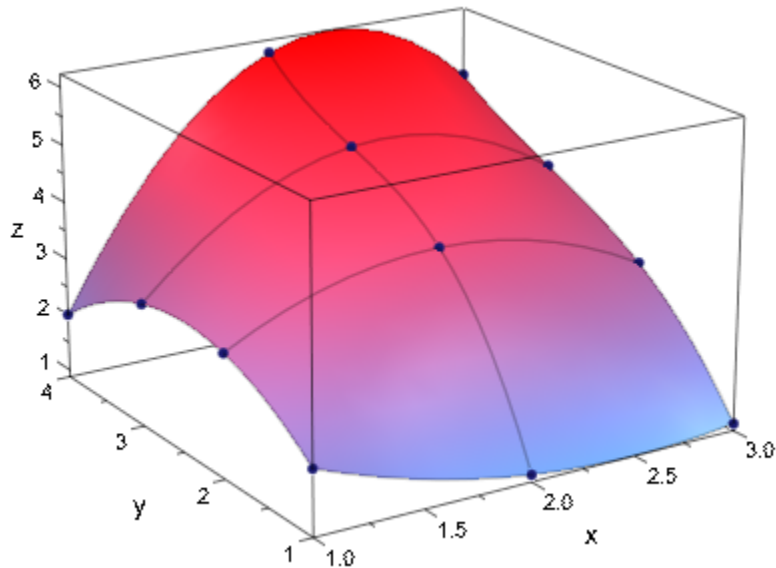

delete A:

## Example 2

Various plot attributes can be specified:

```
plot(plot::Matrixplot(  
  [[-0.5, 0.5, 0.7, 0.5, -1 ],  
   [ 1.2, 1.3, 1.4, 1.4, 1 ],  
   [ 1.4, 1.5, 1.6, 1.5, 1.2],  
   [ 0.6, 0.8, 1, 1, 1 ],  
   [-0.7, 0.5, 0.5, 0, -1 ]],  
  PointsVisible = FALSE,  
  FillColor = RGB::Green,  
  LineColor = RGB::Red))
```



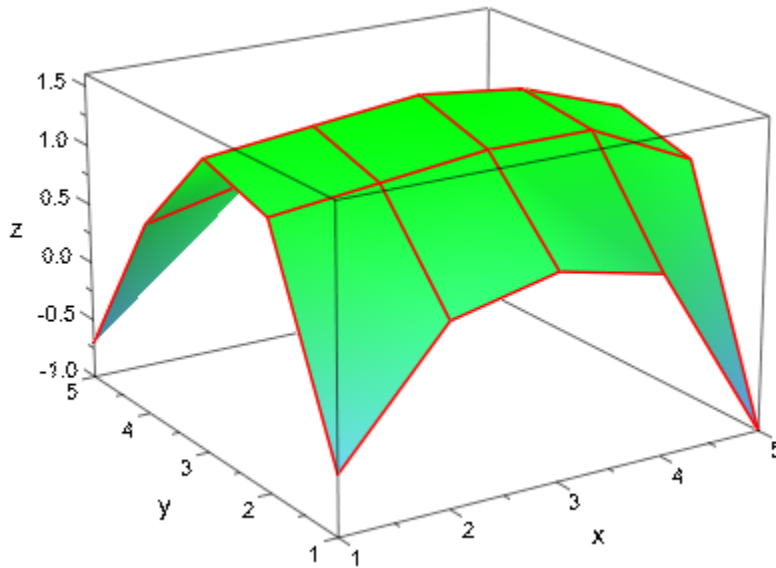

### Example 3

Choosing appropriate coordinate ranges, we place two matrix plots side by side:

```
plot(plot::Matrixplot(matrix::random(5, 5, frandom),  
    x = 0..1, y = 0..1,  
    Color = RGB::Red),  
plot::Matrixplot(matrix::random(6, 6, frandom),  
    x = 2..3, y = 0..1,  
    Color = RGB::Green),  
Scaling = Constrained)
```

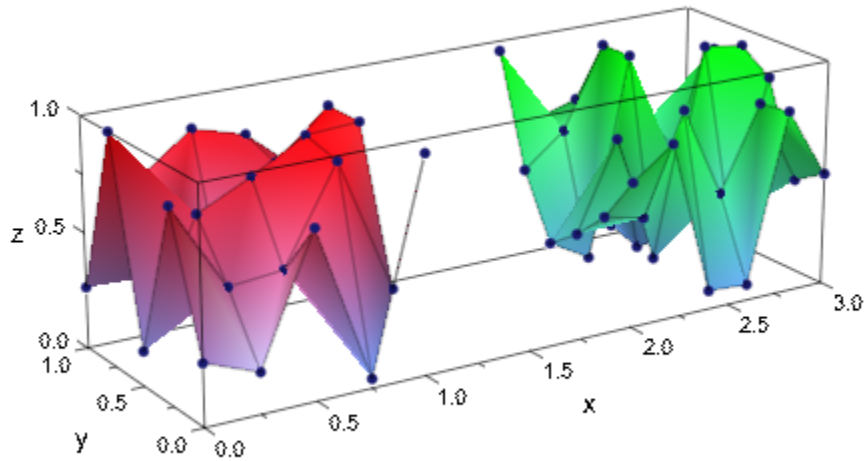

### Example 4

We plot a Hilbert matrix:

```
A := linalg::hilbert(10);  
plot(plot::Matrixplot(A), CameraDirection = [3, 2, 1])
```

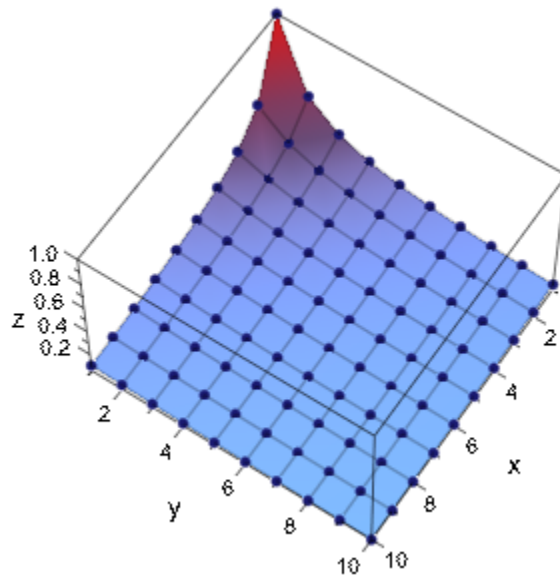

Some of the entries are replaced by values that cannot be plotted. Consequently, the plot contains holes:

```
A[2, 2] := NIL:  
A[4, 5] := infinity:  
A[5, 5] := x:  
plot(plot::Matrixplot(A), CameraDirection = [3, 2, 1])
```

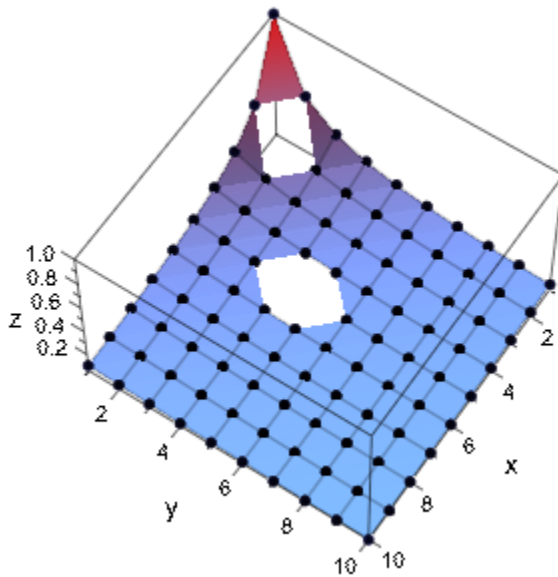

With `InterpolationStyle = Cubic`, an error is raised:

```
plot(plot::Matrixplot(A, InterpolationStyle = Cubic))
```

```
Error: Data contains nonreal numeric values. Use 'Style = Linear' to plot matrices containing  
Evaluating: plot
```

```
delete A:
```

## Parameters

**A**

A matrix on page 1-1340 of category `Cat::Matrix` or an array on page 7-2 containing real numerical values or expressions of the animation parameter `a`.

`A` is equivalent to the attribute `Data`.

**row<sub>1</sub>, row<sub>2</sub>, ...**

The matrix rows: each row must be a list of real numerical values or expressions of the animation parameter *a*. All rows must have the same length.

row<sub>1</sub>, row<sub>2</sub>, ... is equivalent to the attribute Data.

**s**

A data sample of domain type stats::sample.

s is equivalent to the attribute Data.

**c<sub>1</sub>, c<sub>2</sub>, ...**

Column indices of s: positive integers. These indices, if given, indicate that only the specified columns should be used. The indexed columns must contain real numerical values or expressions of the animation parameter *a*. If no columns are specified, all columns of s are used.

**x**

Name of the first coordinate: an identifier on page 7-29 or an indexed identifier on page 1-1017. It is used as the title of the coordinate axis in x direction.

x is equivalent to the attribute XName.

**x<sub>min</sub> .. x<sub>max</sub>**

The range of the first coordinate: x<sub>min</sub>, x<sub>max</sub> must be numerical real value or expressions of the animation parameter *a*.

x<sub>min</sub> .. x<sub>max</sub> is equivalent to the attributes XRange, XMin, XMax.

**y**

Name of the second coordinate: an identifier on page 7-29 or an indexed identifier on page 1-1017. It is used as the title of the coordinate axis in y direction.

y is equivalent to the attribute YName.

$y_{\min} \dots y_{\max}$

The range of the second coordinate:  $y_{\min}$ ,  $y_{\max}$  must be numerical real value or expressions of the animation parameter  $a$ .

$y_{\min} \dots y_{\max}$  is equivalent to the attributes YRange, YMin, YMax.

**a**

Animation parameter, specified as  $a = a_{\min} \dots a_{\max}$ , where  $a_{\min}$  is the initial parameter value, and  $a_{\max}$  is the final parameter value.

## See Also

### MuPAD Functions

`plot` | `plot::copy`

### MuPAD Graphical Primitives

`plot::Function3d` | `plot::Surface`

# plot::MuPADCube

“the cube” (the logo)

## Syntax

```
plot::MuPADCube(<r>, <[cx, cy, cz]>, <a = amin .. amax>, options)
```

## Description

`plot::MuPADCube()` creates the “MuPAD cube” as a graphical 3D primitive.

This object only exists for demonstration purposes.

`plot::MuPADCube` accepts the attribute `Colors` which defines the colors of the spheres and the cylinders between the spheres. Its value is a list of RGB (Symbolic Math Toolbox) or RGBA (Symbolic Math Toolbox) colors:

- The color list may contain one to four values determining the colors of the spheres.
- If a 5th color is given, it determines the color of the cylinders.
- If the list contains nine colors (not less), the first and last four determine the colors of the 8 spheres. The fifth color determines the color of the cylinders.

## Attributes

Attribute	Purpose	Default Value
<code>AffectViewingBox</code>	influence of objects on the <code>ViewingBox</code> of a scene	TRUE
<code>Center</code>	center of objects, rotation center	[0, 0, 0]
<code>CenterX</code>	center of objects, rotation center, x-component	0

<b>Attribute</b>	<b>Purpose</b>	<b>Default Value</b>
CenterY	center of objects, rotation center, y-component	0
CenterZ	center of objects, rotation center, z-component	0
Colors	list of colors to use	[RGB::Green, RGB::Blue, RGB::Red, RGB::Yellow, RGB::Antique]
Frames	the number of frames in an animation	50
Legend	makes a legend entry	
LegendText	short explanatory text for legend	
LegendEntry	add this object to the legend?	FALSE
Name	the name of a plot object (for browser and legend)	
ParameterEnd	end value of the animation parameter	
ParameterName	name of the animation parameter	
ParameterBegin	initial value of the animation parameter	
ParameterRange	range of the animation parameter	
Radius	radius of circles, spheres etc.	1
TimeEnd	end time of the animation	10.0
TimeBegin	start time of the animation	0.0
TimeRange	the real time span of an animation	0.0 .. 10.0
Title	object title	
TitleFont	font of object titles	[" sans-serif ", 11]



Attribute	Purpose	Default Value
TitlePosition	position of object titles	
TitleAlignment	horizontal alignment of titles w.r.t. their coordinates	Center
TitlePositionX	position of object titles, x component	
TitlePositionY	position of object titles, y component	
TitlePositionZ	position of object titles, z component	
Visible	visibility	TRUE
VisibleAfter	object visible after this time value	
VisibleBefore	object visible until this time value	
VisibleFromTo	object visible during this time range	
VisibleAfterEnd	object visible after its animation time ended?	TRUE
VisibleBeforeBegin	object visible before its animation time starts?	TRUE

## Examples

### Example 1

The MuPAD logo:

```
plot(plot::MuPADCube())
```

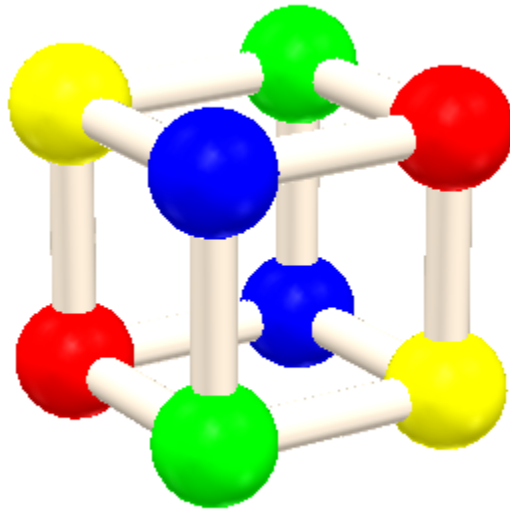

The MuPAD logo with strange colors:

```
plot(plot::MuPADCube(Colors = [RGB::Titanium $ 4, RGB::Gold],  
                    BackgroundColor = RGB::Cobalt))
```

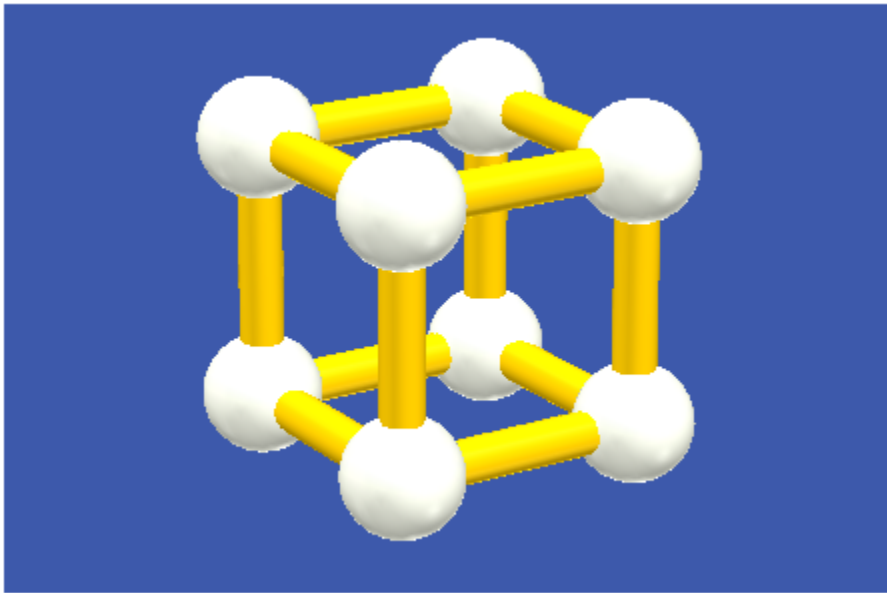

A collection of “MuPAD cubes”:

```
plot(plot::MuPADCube(Center = [2*k, 2*l, 2*m])  
      $ k = 0..1 $ l = 0..1 $ m = 0..1)
```

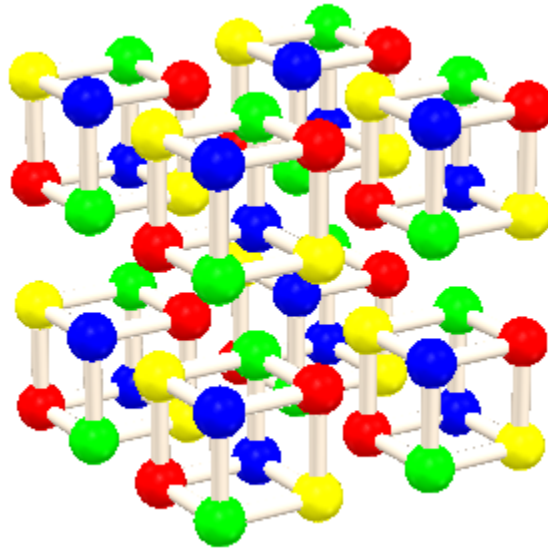

The MuPAD logo with animated size:

```
plot(plot::MuPADCube(1 - abs(a), [0, 0, 0], a = -1..1))
```

## Parameters

**r**

The size of the object (the radius of the surrounding sphere): a real numerical value or an arithmetical expression (Symbolic Math Toolbox) of the animation parameter **a**. The default value of the radius is 1.

**r** is equivalent to the attribute **Radius**.

**c<sub>x</sub>, c<sub>y</sub>, c<sub>z</sub>**

The coordinates of the center: real numerical values or arithmetical expressions (Symbolic Math Toolbox) of the animation parameter **a**. By default, a cube centered at the origin is created.

**c<sub>x</sub>, c<sub>y</sub>, c<sub>z</sub>** are equivalent to the attributes **CenterX**, **CenterY**, **CenterZ**.

**a**

Animation parameter, specified as  $a = a_{\min} \dots a_{\max}$ , where  $a_{\min}$  is the initial parameter value, and  $a_{\max}$  is the final parameter value.

## See Also

### MuPAD Functions

`plot` | `plot::copy`

### MuPAD Graphical Primitives

`plot::Cone` | `plot::Cylinder` | `plot::Sphere`

# plot::Ode2d

2D plots of ODE solutions

## Syntax

```
plot::Ode2d(f, [t_0, t_1, ...], Y_0, <[G_1, <Style = style_1>, <Color = c_1>], [G_2, <Style = style_2>, <Color = c_2>],
plot::Ode2d(f, [Automatic, t_start, t_end, t_step], Y_0, <[G_1, <Style = style_1>, <Color = c_1>],
plot::Ode2d([t_0, t_1, ...], f, Y_0, <[G_1, <Style = style_1>, <Color = c_1>], [G_2, <Style = style_2>, <Color = c_2>],
plot::Ode2d([Automatic, t_start, t_end, t_step], f, Y_0, <[G_1, <Style = style_1>, <Color = c_1>],
```

## Description

`plot::Ode2d(f, [t_0, t_1, ...], Y_0)` renders two-dimensional projections of the solutions of the initial value problem given by  $f$ ,  $t_0$  and  $Y_0$ .

`plot::Ode2d(f, [t_0, t_1, ...], Y_0, [G])` computes a mesh of numerical sample points  $Y(t_0), Y(t_1), \dots$  representing the solution  $Y(t)$  of the first order differential equation (dynamical system)

$$\frac{\partial}{\partial t} Y = f(t, Y), Y(t_0) = Y_0, t_0, t \in \mathbb{R}, Y_0, Y(t) \in \mathbb{C}^n$$

The procedure

$$G: (t, Y) \rightarrow [x(t, Y), y(t, Y)] \quad \text{or} \quad G: (t, Y) \rightarrow [x(t, Y), y(t, Y), z(t, Y)]$$

maps these solution points  $(t_i, Y(t_i))$  in  $\mathbb{R} \times \mathbb{C}^n$  to a mesh of 2D plot points  $[x_i, y_i]$ . These points can be connected by straight lines or interpolating splines.

Internally, a sequence of numerical sample points

```
Y_1 := numeric::odesolve(f, t_0..t_1, Y_0, Options),
```

`Y_2 := numeric::odesolve(f, t_1..t_2, Y_1, Options)`, and so on

is computed, where `Options` is some combination of `method`, `RelativeError = rtol`, `AbsoluteError = atol`, and `Stepsize = h`. See `numeric::odesolve` for details on the vector field procedure `f`, the initial condition  $Y_0$ , and the options.

The utility function `numeric::ode2vectorfield` can be used to produce the input parameters `f`, `t_0`, `Y_0` from a set of differential expressions representing the ODE. See “Example 1” on page 24-516 (Symbolic Math Toolbox).

Each of the “generators of plot data”  $G_1, G_2$  etc. creates a graphical solution curve from the numerical sample points  $Y_0, Y_1$ , and so on. Each generator `G` is internally called in the form `G(t_0, Y_0), G(t_1, Y_1), ...` to produce a sequence of plot points in 2D.

The solver `numeric::odesolve` returns the solution points  $Y_0, Y_1$ , and so on, as lists or one-dimensional arrays (the actual type is determined by the initial value  $Y_0$ ). Consequently, each generator `G` must accept two arguments (`t, Y`): `t` is a real parameter, `Y` is a “vector” (either a list or a 1-dimensional array).

Each generator must return a list with 2 elements representing the  $(x, y)$  coordinates of the graphical point associated with a solution point  $(t, Y)$  of the ODE. All generators must produce graphical data of the same dimension, that is, 2D data as lists with 2 elements for `plot::Ode2d`. Here are some examples:

- `G := (t, Y) -> [t, Y_1]` creates a 2D plot of the first component of the solution vector along the  $y$ -axis, plotted against the time variable `t` along the  $x$ -axis
- `G := (t, Y) -> [Y_1, Y_2]` creates a 2D phase plot, plotting the first component of the solution along the  $x$ -axis and the second component along the  $y$ -axis. The result is a solution curve in phase space (parametrized by the time `t`).

If no generators are given, `plot::Ode2d` by default plots all components of the solution as functions of time, using `[Splines, Points]` as the style.

Note that arbitrary values associated with the solution curve may be displayed graphically by an appropriate generator `G`. See “Example 2” on page 24-518 (Symbolic Math Toolbox).

Several generators  $G_1, G_2$ , and so on can be specified to generate several curves associated with the same numerical mesh  $Y_0, Y_1, \dots$ . See “Example 1” on page 24-516 (Symbolic Math Toolbox), “Example 2” on page 24-518 (Symbolic Math Toolbox), and “Example 3” on page 24-520 (Symbolic Math Toolbox).



The graphical data produced by each of the generators  $G_1, G_2, \dots$  consists of a sequence of mesh points in 2D.

- With `Style = Points`, the graphical data are displayed as a discrete set of points.
- With `Style = Lines`, the graphical data points are displayed as a curve consisting of straight line segments between the sample points. The points themselves are not displayed.
- With `Style = Splines`, the graphical data points are displayed as a smooth spline curve connecting the sample points. The points themselves are not displayed.
- With `Style = [Splines, Points]` and `Style = [Lines, Points]`, the effects of the styles used are combined, that is, both the evaluation points and the straight lines or splines, respectively, are displayed.

The plot attributes accepted by `plot::Ode2d` include `Submesh = n`, where  $n$  is some positive integer. This attribute only has an effect on the curves which are returned for the graphical generators with `Style = Splines` and `Style = [Splines, Points]`, respectively. It serves for smoothening the graphical spline curve using a sufficiently high number of plot points.

$n$  is the number of plot points between two consecutive numerical points corresponding to the time mesh. The default value is  $n = 4$ , that is, the splines are plotted as five straight line segments connecting the numerical sample points.

## Attributes

Attribute	Purpose	Default Value
<code>AbsoluteError</code>	maximal absolute discretization error	
<code>AffectViewingBox</code>	influence of objects on the <code>ViewingBox</code> of a scene	TRUE
<code>AntiAliased</code>	antialiased lines and points?	TRUE

<b>Attribute</b>	<b>Purpose</b>	<b>Default Value</b>
Colors	list of colors to use	[RGB::Blue, RGB::Red, RGB::Green, RGB::MuPADGold, RGB::Orange, RGB::Cyan, RGB::Magenta, RGB::LimeGreen, RGB::CadmiumYellowLight, RGB::AlizarinCrimson, RGB::Aqua, RGB::Lavender, RGB::SeaGreen, RGB::AureolineYellow, RGB::Banana, RGB::Beige, RGB::YellowGreen, RGB::Wheat, RGB::IndianRed, RGB::Black]
Frames	the number of frames in an animation	50
Function	function expression or procedure	
InitialConditions	initial conditions of the ODE	
Legend	makes a legend entry	
LegendText	short explanatory text for legend	
LegendEntry	add this object to the legend?	FALSE
LineWidth	width of lines	0.35
LineStyle	solid, dashed or dotted lines?	Solid
LinesVisible	visibility of lines	TRUE

<b>Attribute</b>	<b>Purpose</b>	<b>Default Value</b>
Name	the name of a plot object (for browser and legend)	
ODEMethod	the numerical scheme used for solving the ODE	DOPRI78
ParameterEnd	end value of the animation parameter	
ParameterName	name of the animation parameter	
ParameterBegin	initial value of the animation parameter	
ParameterRange	range of the animation parameter	
PointSize	the size of points	1.5
PointStyle	the presentation style of points	FilledCircles
PointsVisible	visibility of mesh points	TRUE
Projectors	project an ODE solution to graphical points	
RelativeError	maximal relative discretization error	
Stepsize	set a constant step size	
Submesh	density of submesh (additional sample points)	4
TimeEnd	end time of the animation	10.0
TimeMesh	the numerical time mesh	
TimeBegin	start time of the animation	0.0
TimeRange	the real time span of an animation	0.0 .. 10.0
Title	object title	
TitleFont	font of object titles	[" sans-serif ", 11]
TitlePosition	position of object titles	

Attribute	Purpose	Default Value
TitleAlignment	horizontal alignment of titles w.r.t. their coordinates	Center
TitlePositionX	position of object titles, x component	
TitlePositionY	position of object titles, y component	
USubmesh	density of additional sample points for parameter "u"	4
Visible	visibility	TRUE
VisibleAfter	object visible after this time value	
VisibleBefore	object visible until this time value	
VisibleFromTo	object visible during this time range	
VisibleAfterEnd	object visible after its animation time ended?	TRUE
VisibleBeforeBegin	object visible before its animation time starts?	TRUE

## Examples

### Example 1

The following procedure  $f$  together with the initial value  $Y_0$  represent the initial value

problem  $\frac{d}{dt} Y = f(t, Y) = tY - Y^2$ ,  $Y(0) = 2$ . In MuPAD, the one-dimensional vector  $Y$  is represented by a list with one element. The body of the function  $f$  below addresses the first (and only) entry of this list as  $Y_1$  and returns the one-dimensional vector  $tY - Y^2$  as a list with one element. Also the initial condition  $Y_0$  is a one-dimensional vector represented by a list. For details on the format of  $f$ , please see `numeric::odesolve`:

```
f := (t, Y) -> [t*Y[1] - Y[1]^2]:
Y0 := [2]:
```

Alternatively, the utility function `numeric::ode2vectorfield` can be used to generate the input parameters in a more intuitive way:

```
[f, t0, Y0] := [numeric::ode2vectorfield(
    {y'(t) = t*y(t) - y(t)^2, y(0) = 2}, [y(t)])]

[proc f(t, Y) ... end, 0, [2]]
```

The numerical solution is to consist of sample points over the time mesh  $t_i = i, i = 0, 1, \dots, 10$ . We use the default generator of `plot::Ode2d`. This generates the sample points together with a smooth spline curve connecting these points:

```
p := plot::Ode2d(f, [$ 0..10], Y0,
    PointSize = 2*unit::mm,
    PointStyle = Stars):
```

Finally, the ode solution is rendered by a call to `plot`:

```
plot(p, TicksDistance = 2.0, GridVisible = TRUE,
    SubgridVisible = TRUE):
```

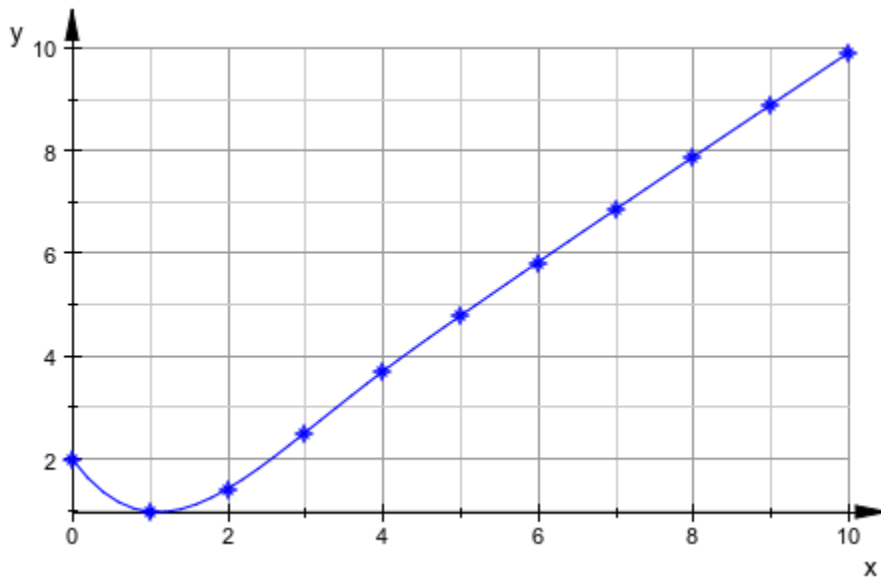

## Example 2

Consider the nonlinear oscillator  $y'' + y^7 = 0$ ,  $y(0) = 1$ ,  $y'(0) = 0$ . As a dynamical system

for  $Y = [y, y']$ , solve the following initial value problem  $\frac{\partial}{\partial t} Y = f(t, Y)$ ,  $Y(0) = Y_0$ . For details on the format of  $f$ , see `numeric::odesolve`:

```
f := (t, Y) -> [Y[2], - Y[1]^7]:
Y0 := [1, 0]:
```

The following generator produces a plot of the solution  $Y(t)$  against the time parameter  $t$ :

```
G1 := (t, Y) -> [t, Y[1]]:
```

For demonstration purposes, plot the function  $\frac{y^2}{2} + \frac{y'^2}{2}$ . The generator G2 produces the values  $y(t)$ ,  $y'(t)$  along the solution and plots these values against  $t$ :

```
G2 := (t, Y) -> [t, Y[1]^2/2 + Y[2]^2/2]:
```

The energy function, or “Hamiltonian”,  $\frac{y^2}{2} + \frac{y'^8}{8}$  must be conserved along the solution curve because the total energy of the system is constant. Define a corresponding generator G3 to plot  $y(t)$ ,  $y'(t)$  as a function of  $t$ :

```
G3 := (t, Y) -> [t, Y[1]^8/8 + Y[2]^2/2]:
```

The solution curve is combined with the graph of the function and the Hamiltonian:

```
p := plot::Ode2d(f, [i/2 $ i = 0..40], Y0,
  [G1, Style = Lines, Color = RGB::Red],
  [G1, Style = Points, Color = RGB::Black],
  [G2, Style = Lines, Color = RGB::Blue],
  [G2, Style = Points, Color = RGB::Black],
  [G3, Style = Lines, Color = RGB::Green],
  [G3, Style = Points, Color = RGB::Black],
  PointSize = 1.5*unit::mm,
  LineWidth = 0.2*unit::mm
):
```

Note that by using each generator twice, you can set different colors for the lines and points. The renderer is called:

```
plot(p):
```

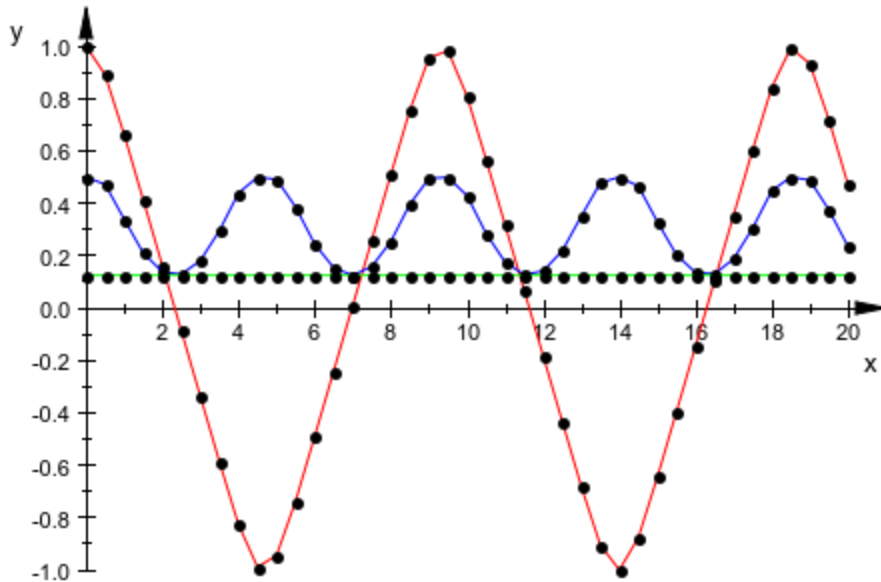

The Hamiltonian  $G_3$  is constant which verifies the accuracy of the integrator.

To visualize the dependency of the trajectory on the initial conditions, animate `plot::0de2d` over different values of  $y'(0)$ :

```
plot(plot::0de2d(f, [i/6 $ i = 0..120], [1, a], a = -1/2..1/2,
  [G1, Style = Lines, Color = RGB::Red],
  [G2, Style = Lines, Color = RGB::Blue],
  [G3, Style = Lines, Color = RGB::Green],
  LineWidth = 0.2*unit::mm, Frames=25))
```

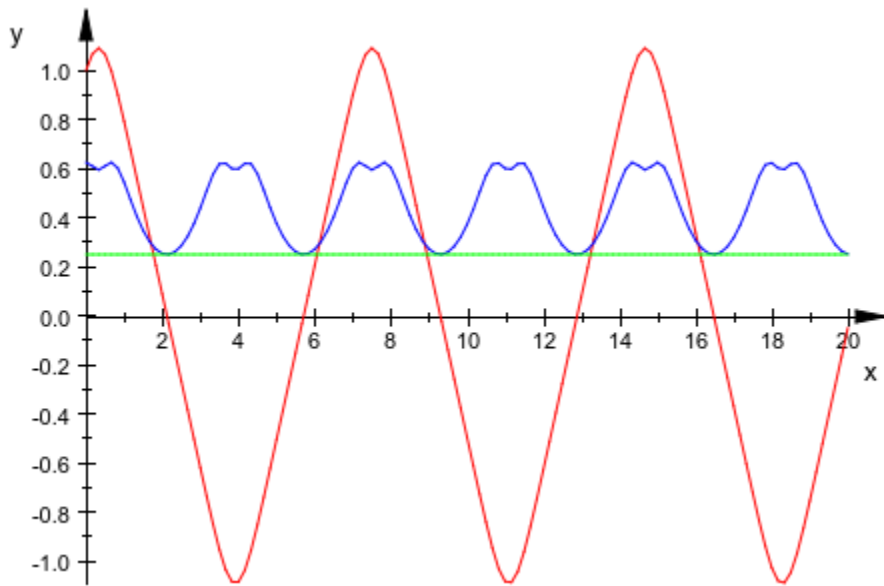

### Example 3

Consider the initial value problem  $y' = f(t, y) = t \sin(t + y^2)$ ,  $y(0) = 0$ :

```
f := (t, y) -> t*sin(t + y^2): Y0:= [0]:
```

Use `numeric::ode2vectorfield` to generate the following vector field which is tangent to the solution curves:

```
p1 := plot::VectorField2d([1, f(t, y)], t = 0..4, y = -1.2..1.2,
    Mesh = [21, 25], Color = RGB::Black):
```

The following object represents the plot of the solution as a function of t:

```
p2 := plot::Ode2d(
    (t,Y) -> [f(t, Y[1])], [i/3 $ i=0..12], Y0,
    [(t, Y) -> [t, Y[1]], Style = Points, Color = RGB::Red],
    [(t, Y) -> [t, Y[1]], Style = Splines, Color = RGB::Blue]):
```

Define the point size explicitly:

```
p2::PointSize := 2*unit::mm:
```



Finally, combine the vector field and the ODE plot to a scene and call the renderer:

```
plot(p1, p2, XTicksDistance = 0.5, YTicksDistance = 0.2,
     Axes = Frame, AxesTitles = ["t", "y"],
     GridVisible = TRUE):
```

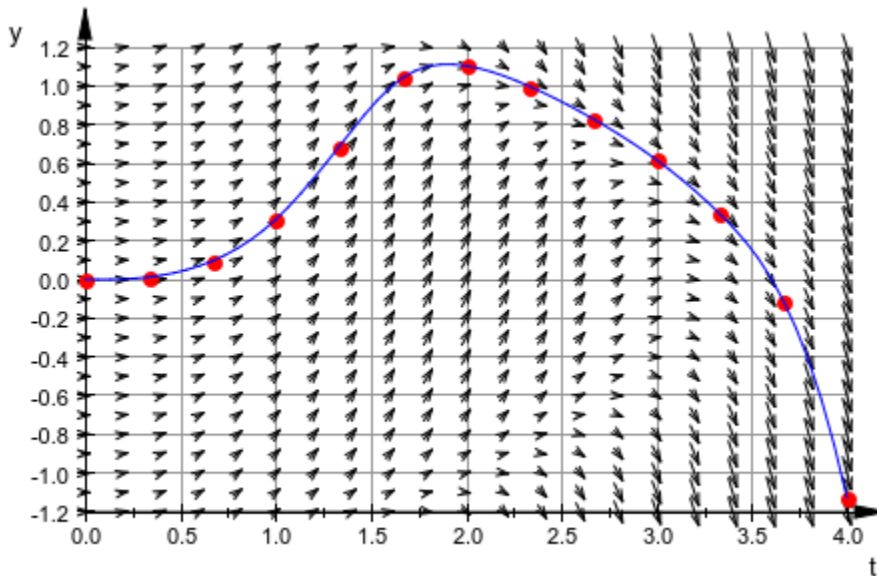

## Example 4

By default, `numeric::odesolve` (which is used by `plot::Ode2d` internally) uses adaptive step sizes and a method of order 8. Usually, there is no reason to change these settings, except for demonstrative purposes. In the following animation, use a straightforward explicit Euler method (of first order) and show how decreasing the step size improves the quality of the calculated solution.

The differential equation is  $y' = y$ , obviously fulfilled by the exponential function:

```
[f, t0, Y0] := [numeric::ode2vectorfield(
                {y'(t)=y(t), y(0)=1}, [y(t)]):
```

To judge the quality of the numerical solution, plot the symbolic solution alongside the approximation:

```

plot(plot::Function2d(exp(x), x=0..3,
                      Color = RGB::Black, LineStyle = Dashed),
     plot::Ode2d(f, [Automatic, 0, 3, 1/n], Y0, n = 1..50,
                 EULER1, StepSize = 1/n,
                 [(t, Y) -> [t, Y[1]], Style=[Lines, Points]]))

```

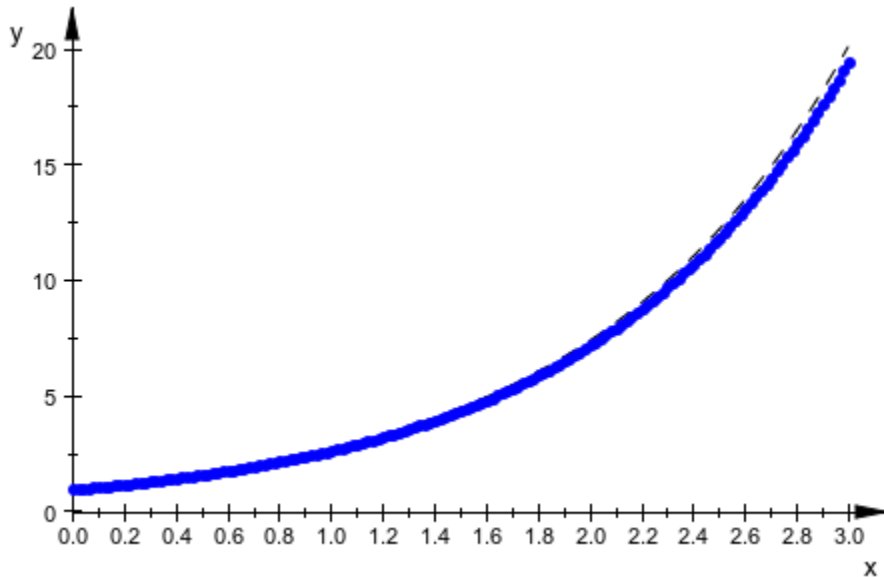

## Parameters

**f**

The vector field of the ODE: a procedure on page 1-1654. See `numeric::odesolve` for details.

f is equivalent to the attribute `Function`.

**t<sub>0</sub>, t<sub>1</sub>, ...**

The time mesh: real numerical values. If data are displayed with `Style = Splines`, these values must be in ascending order.

t<sub>0</sub>, t<sub>1</sub>, ... is equivalent to the attribute `TimeMesh`.

**$t_{start}$ ,  $t_{end}$ ,  $t_{step}$**

The time mesh: real numerical values.  $t_{end}$  must be larger than  $t_{start}$  and  $t_{step}$  must be positive and should be smaller than  $t_{end} - t_{start}$ .

$t_{start}$ ,  $t_{end}$ ,  $t_{step}$  are equivalent to the attribute `TimeMesh`.

**$Y_0$**

The initial condition of the ODE: a list on page 7-41 or a 1-dimensional array on page 7-2. See `numeric::odesolve`.

$Y_0$  is equivalent to the attribute `InitialConditions`.

**$G_1$ ,  $G_2$ , ...**

“generators of plot data”: procedures mapping a solution point ( $t$ ,  $Y(t)$ ) to a list [ $x$ ,  $y$ ] or [ $x$ ,  $y$ ,  $z$ ] representing a plot point in 2D or 3D, respectively.

$G_1$ ,  $G_2$ , ... is equivalent to the attribute `Projectors`.

**method**

Use a specific numerical scheme (see `numeric::odesolve`)

**a**

Animation parameter, specified as  $a = a_{min} .. a_{max}$ , where  $a_{min}$  is the initial parameter value, and  $a_{max}$  is the final parameter value.

## Options

### Style

Option, specified as `Style = style`

Sets the style in which the plot data are displayed. The following styles are available: `Points`, `Lines`, `Splines`, `[Lines, Points]`, and `[Splines, Points]`. The default style is `[Splines, Points]`.

**Color**

Option, specified as `Color = c`

Sets the RGB color (Symbolic Math Toolbox) `c` in which the plot data are displayed. The default color of the *i*th generator is the *i*th entry of the attribute `Colors`.

**RelErr**

Option, specified as `RelErr = rtol`

Sets a numerical discretization tolerance (see `numeric::odesolve`)

**AbsErr**

Option, specified as `AbsErr = atol`

Sets a numerical discretization tolerance (see `numeric::odesolve`)

**Stepsize**

Option, specified as `Stepsize = h`

Sets a constant stepsize (see `numeric::odesolve`)

**See Also****MuPAD Functions**

`numeric::ode2vectorfield` | `numeric::odesolve` | `numeric::odesolve2`

**MuPAD Graphical Primitives**

`plot::Curve2d` | `plot::Curve3d` | `plot::Ode3d` | `plot::PointList2d` |  
`plot::PointList3d` | `plot::Polygon2d` | `plot::Polygon3d` |  
`plot::Streamlines2d`

# plot::Ode3d

3D plots of ODE solutions

## Syntax

```
plot::Ode3d(f, [t_0, t_1, ...], Y_0, <[G_1, <Style = style_1>, <Color = c_1>], [G_2, <Style = style_2>, <Color = c_2>],
plot::Ode3d(f, [Automatic, t_start, t_end, t_step], Y_0, <[G_1, <Style = style_1>, <Color = c_1>],
plot::Ode3d([t_0, t_1, ...], f, Y_0, <[G_1, <Style = style_1>, <Color = c_1>], [G_2, <Style = style_2>, <Color = c_2>],
plot::Ode3d([Automatic, t_start, t_end, t_step], f, Y_0, <[G_1, <Style = style_1>, <Color = c_1>],
```

## Description

`plot::Ode3d(f, [t_0, t_1, ...], Y_0)` renders three-dimensional projections of the solutions of the initial value problem given by  $f$ ,  $t_0$  and  $Y_0$ .

`plot::Ode3d(f, [t_0, t_1, ...], Y_0, [G])` computes a mesh of numerical sample points  $Y(t_0), Y(t_1), \dots$  representing the solution  $Y(t)$  of the first order differential equation (dynamical system)

$$\frac{\partial}{\partial t} Y = f(t, Y), Y(t_0) = Y_0, t_0, t \in \mathbb{R}, Y_0, Y(t) \in \mathbb{C}^n$$

The procedure

$$G: (t, Y) \rightarrow [x(t, Y), y(t, Y)] \quad \text{or} \quad G: (t, Y) \rightarrow [x(t, Y), y(t, Y), z(t, Y)]$$

maps these solution points  $(t_i, Y(t_i))$  in  $\mathbb{R} \times \mathbb{C}^n$  to a mesh of 3D plot points  $[x_i, y_i, z_i]$ . These points can be connected by straight lines or interpolating splines.

Internally, a sequence of numerical sample points

```
Y_1 := numeric::odesolve(f, t_0..t_1, Y_0, Options),
```

`Y_2 := numeric::odesolve(f, t_1..t_2, Y_1, Options)`, and so on

is computed, where `Options` is some combination of `method`, `RelativeError = rtol`, `AbsoluteError = atol`, and `Stepsize = h`. See `numeric::odesolve` for details on the vector field procedure `f`, the initial condition  $Y_0$ , and the options.

The utility function `numeric::ode2vectorfield` may be used to produce the input parameters `f`, `t_0`,  $Y_0$  from a set of differential expressions representing the ODE.

Each of the “generators of plot data”  $G_1, G_2$  etc. creates a graphical solution curve from the numerical sample points  $Y_0, Y_1$  etc. Each generator  $G$ , say, is internally called in the form  $G(t_0, Y_0), G(t_1, Y_1), \dots$  to produce a sequence of plot points in 3D.

The solver `numeric::odesolve` returns the solution points  $Y_0, Y_1$ , and so on, as lists or one-dimensional arrays (the actual type is determined by the initial value  $Y_0$ ).

Consequently, each generator  $G$  must accept two arguments  $(t, Y)$ :  $t$  is a real parameter,  $Y$  is a “vector” (either a list or a 1-dimensional array).

Each generator must return a list with 3 elements representing the  $(x, y, z)$  coordinates of the graphical point associated with a solution point  $(t, Y)$  of the ODE. All generators must produce graphical data of the same dimension, that is, for `plot::Ode3d`, 3D data as lists with 3 elements. For example, `G := (t, Y) -> [Y_1, Y_2, Y_3]` creates a 3D phase plot of the first three components of the solution curve.

If no generators are given, `plot::Ode3d` by default plots each group of two components as functions of time with the same style.

Note that arbitrary values associated with the solution curve may be displayed graphically by an appropriate generator  $G$ .

Several generators  $G_1, G_2$ , and so on, can be specified to generate several curves associated with the same numerical mesh  $Y_0, Y_1, \dots$

The graphical data produced by each of the generators  $G_1, G_2, \dots$  consists of a sequence of mesh points in 3D.

- With `Style = Points`, the graphical data are displayed as a discrete set of points.
- With `Style = Lines`, the graphical data points are displayed as a curve consisting of straight line segments between the sample points. The points themselves are not displayed.
- With `Style = Splines`, the graphical data points are displayed as a smooth spline curve connecting the sample points. The points themselves are not displayed.

- With `Style = [Splines, Points]` and `Style = [Lines, Points]`, the effects of the styles used are combined, that is, both the evaluation points and the straight lines or splines, respectively, are displayed.

The plot attributes accepted by `plot::Ode3d` include `Submesh = n`, where  $n$  is some positive integer. This attribute only has an effect on the curves which are returned for the graphical generators with `Style = Splines` and `Style = [Splines, Points]`, respectively. It serves for smoothening the graphical spline curve using a sufficiently high number of plot points.

$n$  is the number of plot points between two consecutive numerical points corresponding to the time mesh. The default value is  $n = 4$ , that is, the splines are plotted as five straight line segments connecting the numerical sample points.

## Attributes

Attribute	Purpose	Default Value
<code>AbsoluteError</code>	maximal absolute discretization error	
<code>AffectViewingBox</code>	influence of objects on the <code>ViewingBox</code> of a scene	TRUE

<b>Attribute</b>	<b>Purpose</b>	<b>Default Value</b>
Colors	list of colors to use	[RGB::Blue, RGB::Red, RGB::Green, RGB::MuPADGold, RGB::Orange, RGB::Cyan, RGB::Magenta, RGB::LimeGreen, RGB::CadmiumYellowLight, RGB::AlizarinCrimson, RGB::Aqua, RGB::Lavender, RGB::SeaGreen, RGB::AureolineYellow, RGB::Banana, RGB::Beige, RGB::YellowGreen, RGB::Wheat, RGB::IndianRed, RGB::Black]
Frames	the number of frames in an animation	50
Function	function expression or procedure	
InitialConditions	initial conditions of the ODE	
Legend	makes a legend entry	
LegendText	short explanatory text for legend	
LegendEntry	add this object to the legend?	FALSE
LineWidth	width of lines	0.35
LineStyle	solid, dashed or dotted lines?	Solid
LinesVisible	visibility of lines	TRUE



Attribute	Purpose	Default Value
Name	the name of a plot object (for browser and legend)	
ODEMethod	the numerical scheme used for solving the ODE	DOPRI78
ParameterEnd	end value of the animation parameter	
ParameterName	name of the animation parameter	
ParameterBegin	initial value of the animation parameter	
ParameterRange	range of the animation parameter	
PointSize	the size of points	1.5
PointStyle	the presentation style of points	FilledCircles
PointsVisible	visibility of mesh points	TRUE
Projectors	project an ODE solution to graphical points	
RelativeError	maximal relative discretization error	
Stepsize	set a constant step size	
Submesh	density of submesh (additional sample points)	4
TimeEnd	end time of the animation	10.0
TimeMesh	the numerical time mesh	
TimeBegin	start time of the animation	0.0
TimeRange	the real time span of an animation	0.0 .. 10.0
Title	object title	
TitleFont	font of object titles	[" sans-serif ", 11]
TitlePosition	position of object titles	

Attribute	Purpose	Default Value
TitleAlignment	horizontal alignment of titles w.r.t. their coordinates	Center
TitlePositionX	position of object titles, x component	
TitlePositionY	position of object titles, y component	
TitlePositionZ	position of object titles, z component	
USubmesh	density of additional sample points for parameter "u"	4
Visible	visibility	TRUE
VisibleAfter	object visible after this time value	
VisibleBefore	object visible until this time value	
VisibleFromTo	object visible during this time range	
VisibleAfterEnd	object visible after its animation time ended?	TRUE
VisibleBeforeBegin	object visible before its animation time starts?	TRUE

## Examples

### Example 1

Consider the nonlinear oscillator  $y'' + y^3 = \sin(t)$ ,  $y(0) = 0$ ,  $y'(0) = 0.5$ . As a dynamical system for  $Y = [y, y']$ , solve the following initial value problem  $\frac{\partial}{\partial t} Y = f(t, Y)$ ,  $Y(0) = Y_0$ :

```
f := (t, Y) -> [Y[2], sin(t) - Y[1]^3]:
Y0 := [0, 0.5]:
```

The following generator produces a phase plot in the  $(x, y)$  plane, embedded in a 3D plot:

```
G1 := (t, Y) -> [Y[1], Y[2], 0]:
```

Further, use the  $z$  coordinate of the 3D plot to display the value of the “energy” function

$E = \frac{y^2}{2} + \frac{y'^2}{2}$  over the phase curve:

```
G2 := (t, Y) -> [Y[1], Y[2], (Y[1]^2 + Y[2]^2)/2]:
```

The phase curve in the  $(x, y)$  plane is combined with the graph of the energy function:

```
p := plot::Ode3d(f, [i/5 $ i = 0..100], Y0,
                [G1, Style = Splines, Color = RGB::Red],
                [G2, Style = Points, Color = RGB::Black],
                [G2, Style = Lines, Color = RGB::Blue]):
```

Set an explicit size of the points used in the representation of the energy:

```
p::PointSize := 2*unit::mm:
```

The renderer is called:

```
plot(p, AxesTitles = ["y", "y'", "E"],
     CameraDirection = [10, -15, 5]):
```

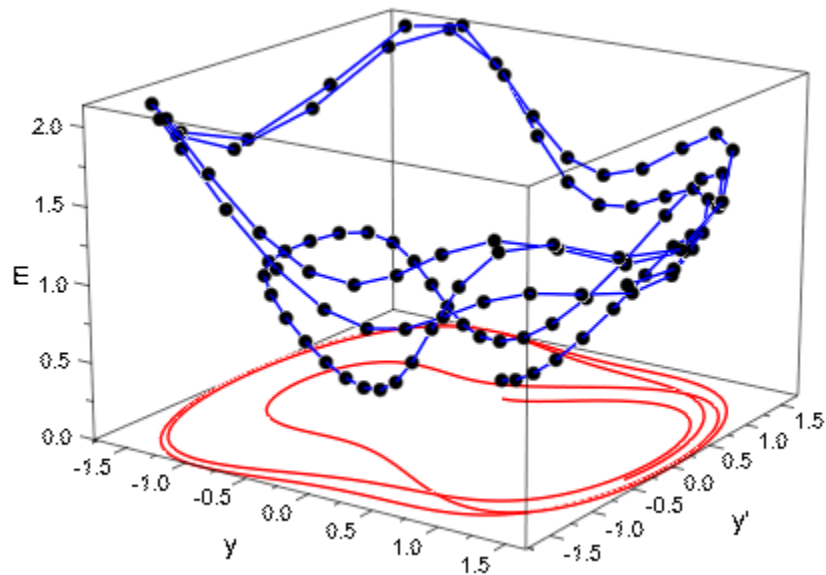

## Example 2

The Lorenz ODE is the system

$$\frac{\partial}{\partial t} \begin{pmatrix} x \\ y \\ z \end{pmatrix} = \begin{pmatrix} p(y-x) \\ -xz + rx - y \\ xy - bz \end{pmatrix}$$

with fixed parameters  $p, r, b$ . As a dynamical system for  $Y = [x, y, z]$ , solve the ODE

$\frac{\partial}{\partial t} Y = f(t, Y)$  with the following vector field:

```
f := proc(t, Y)
  local x, y, z;
  begin
    [x, y, z] := Y;
    [p*(y - x), -x*z + r*x - y, x*y - b*z]
  end_proc;
```

Consider the following parameters and the following initial condition  $Y_0$ :

```
p := 10: r := 28: b := 1:
Y0 := [1, 1, 1]:
```

The following generator Gxyz produces a 3D phase plot of the solution. The generator Gyz projects the solution curve to the (y, z) plane with  $x = 20$ ; the generator Gxz projects the solution curve to the (x, z) plane with  $y = -15$ ; the generator Gxy projects the solution curve to the (x, y) plane with  $z = 0$ :

```
Gxyz := (t, Y) -> Y:
Gyz := (t, Y) -> [ 20, Y[2], Y[3]]:
Gxz := (t, Y) -> [Y[1], -15, Y[3]]:
Gxy := (t, Y) -> [Y[1], Y[2], 0 ]:
```

With these generators, create a 3D plot object consisting of the phase curve and its projections.

```
object := plot::Ode3d(f, [i/10 $ i=1..100], Y0,
  [Gxyz, Style = Splines, Color = RGB::Red],
  [Gyz, Style = Splines, Color = RGB::Grey50],
  [Gxz, Style = Splines, Color = RGB::Grey50],
  [Gxy, Style = Splines, Color = RGB::Grey50],
  Submesh = 7):
```

Finally, the plot is rendered. This call is somewhat time consuming because it calls the numerical solver `numeric::odesolve` to produce the graphical data:

```
plot(object, CameraDirection = [-220, 110, 150])
```

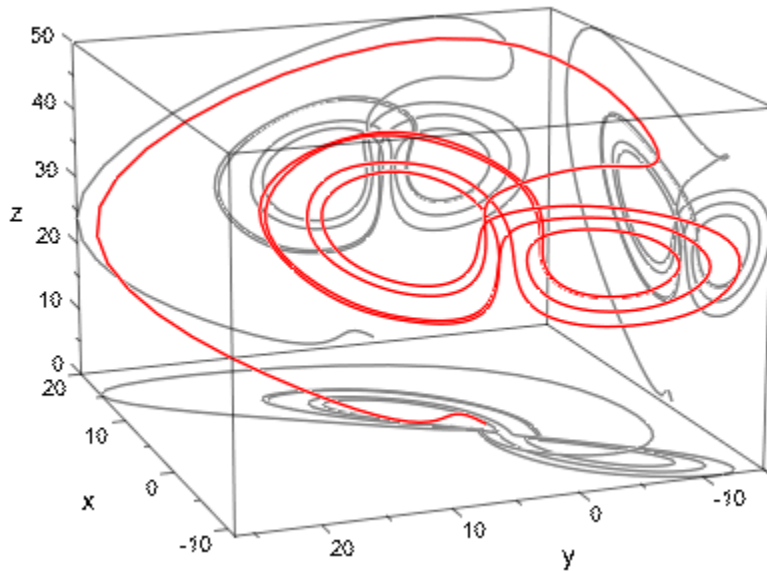

## Parameters

**f**

The vector field of the ODE: a procedure on page 1-1654. See `numeric::odesolve` for details.

f is equivalent to the attribute `Function`.

**t<sub>0</sub>, t<sub>1</sub>, ...**

The time mesh: real numerical values. If data are displayed with `Style = Splines`, these values must be in ascending order.

t<sub>0</sub>, t<sub>1</sub>, ... is equivalent to the attribute `TimeMesh`.

**t<sub>start</sub>, t<sub>end</sub>, t<sub>step</sub>**

The time mesh: real numerical values. t<sub>end</sub> must be larger than t<sub>start</sub> and t<sub>step</sub> must be positive and should be smaller than  $t_{end} - t_{start}$ .

$t_{\text{start}}$ ,  $t_{\text{end}}$ ,  $t_{\text{step}}$  are equivalent to the attribute `TimeMesh`.

### $Y_0$

The initial condition of the ODE: a list on page 7-41 or a 1-dimensional array on page 7-2. See `numeric::odesolve`.

$Y_0$  is equivalent to the attribute `InitialConditions`.

### $G_1, G_2, \dots$

“generators of plot data”: procedures mapping a solution point  $(t, Y(t))$  to a list  $[x, y]$  or  $[x, y, z]$  representing a plot point in 2D or 3D, respectively.

$G_1, G_2, \dots$  is equivalent to the attribute `Projectors`.

### **method**

Use a specific numerical scheme (see `numeric::odesolve`)

### **a**

Animation parameter, specified as  $a = a_{\text{min}} \dots a_{\text{max}}$ , where  $a_{\text{min}}$  is the initial parameter value, and  $a_{\text{max}}$  is the final parameter value.

## Options

### **Style**

Option, specified as `Style = style`

Sets the style in which the plot data are displayed. The following styles are available: `Points`, `Lines`, `Splines`, `[Lines, Points]`, and `[Splines, Points]`. The default style is `[Splines, Points]`.

### **Color**

Option, specified as `Color = c`

Sets the RGB color (Symbolic Math Toolbox)  $c$  in which the plot data are displayed. The default color of the  $i$ th generator is the  $i$ th entry of the attribute `Colors`.

**RelErr**

Option, specified as `RelErr = rtol`

Sets a numerical discretization tolerance (see `numeric::odesolve`)

**AbsErr**

Option, specified as `AbsErr = atol`

Sets a numerical discretization tolerance (see `numeric::odesolve`)

**Stepsize**

Option, specified as `Stepsize = h`

Sets a constant stepsize (see `numeric::odesolve`)

## See Also

**MuPAD Functions**

`numeric::ode2vectorfield` | `numeric::odesolve` | `numeric::odesolve2`

**MuPAD Graphical Primitives**

`plot::Curve2d` | `plot::Curve3d` | `plot::Ode2d` | `plot::PointList2d` |

`plot::PointList3d` | `plot::Polygon2d` | `plot::Polygon3d` |

`plot::Streamlines2d`



# plot::Parallelogram2d

2D parallelograms

## Syntax

plot::Parallelogram2d([c<sub>x</sub>, c<sub>y</sub>], [u<sub>x</sub>, u<sub>y</sub>], [v<sub>x</sub>, v<sub>y</sub>], <a = a<sub>min</sub> .. a<sub>max</sub>>, options)

## Description

plot::Parallelogram2d(c, u, v) defines a 2D parallelogram

$\{\vec{c} + \lambda \vec{u} + \mu \vec{v} \mid \lambda \in [-1, 1], \mu \in [-1, 1]\}$  with center  $\vec{c}$  and vectors  $\vec{u}, \vec{v}$  spanning the plane of the parallelogram. This is a rectangle with sides of length  $2|\vec{u}|, 2|\vec{v}|$  if the vectors  $\vec{u}$  and  $\vec{v}$  are orthogonal.

plot::Parallelogram2d creates a 2D parallelogram with center  $\vec{c} = [c_x, c_y]$  and sides given by the vectors  $2\vec{u} = [2 u_x, 2 u_y]$  and  $2\vec{v} = [2 v_x, 2 v_y]$ . The corners of the parallelogram are given by  $\vec{c} - \vec{u} - \vec{v}, \vec{c} - \vec{u} + \vec{v}, \vec{c} + \vec{u} - \vec{v},$  and  $\vec{c} + \vec{u} + \vec{v}$ :

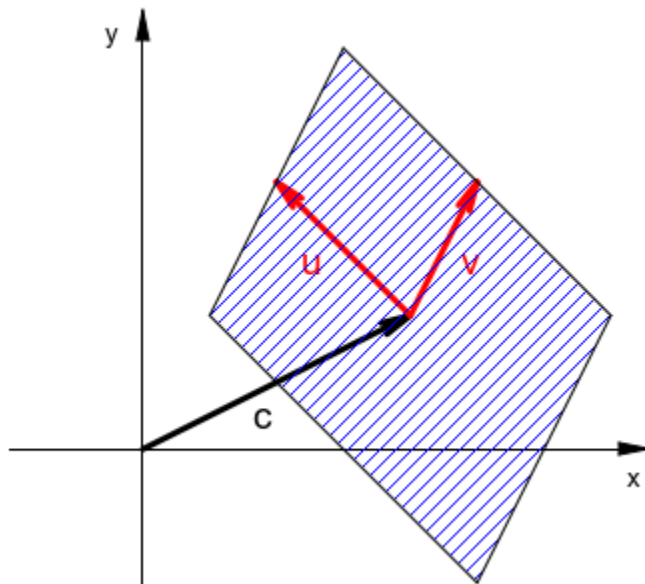

By default, only the border lines of the parallelogram are visible. Their color is set by the attribute `LineColor`. With `Filled = TRUE`, the area of the parallelogram is filled with the color specified by the attribute `Color` or, equivalently, `FillColor`.

Alternatively, the center and the spanning vectors can be given as vectors.

## Attributes

Attribute	Purpose	Default Value
<code>AffectViewingBox</code>	influence of objects on the <code>ViewingBox</code> of a scene	<code>TRUE</code>
<code>AntiAliased</code>	antialiased lines and points?	<code>TRUE</code>
<code>Center</code>	center of objects, rotation center	<code>[0, 0]</code>
<code>CenterX</code>	center of objects, rotation center, x-component	<code>0</code>

Attribute	Purpose	Default Value
CenterY	center of objects, rotation center, y-component	0
Color	the main color	RGB::Blue
Filled	filled or transparent areas and surfaces	FALSE
FillColor	color of areas and surfaces	RGB::Red
FillPattern	type of area filling	DiagonalLines
Frames	the number of frames in an animation	50
Legend	makes a legend entry	
LegendText	short explanatory text for legend	
LegendEntry	add this object to the legend?	FALSE
LineColor	color of lines	RGB::Blue
LineWidth	width of lines	0.35
LineStyle	solid, dashed or dotted lines?	Solid
LinesVisible	visibility of lines	TRUE
Name	the name of a plot object (for browser and legend)	
ParameterEnd	end value of the animation parameter	
ParameterName	name of the animation parameter	
ParameterBegin	initial value of the animation parameter	
ParameterRange	range of the animation parameter	
Tangent1	first vector spanning parallelograms	[0, 1]

<b>Attribute</b>	<b>Purpose</b>	<b>Default Value</b>
Tangent2	second vector spanning parallelograms	[1, 0]
Tangent1X	first vector spanning parallelograms, x component	0
Tangent1Y	first vector spanning parallelograms, y component	1
Tangent2X	second vector spanning parallelograms, x component	1
Tangent2Y	second vector spanning parallelograms, y component	0
TimeEnd	end time of the animation	10.0
TimeBegin	start time of the animation	0.0
TimeRange	the real time span of an animation	0.0 .. 10.0
Title	object title	
TitleFont	font of object titles	[" sans-serif ", 11]
TitlePosition	position of object titles	
TitleAlignment	horizontal alignment of titles w.r.t. their coordinates	Center
TitlePositionX	position of object titles, x component	
TitlePositionY	position of object titles, y component	
Visible	visibility	TRUE
VisibleAfter	object visible after this time value	
VisibleBefore	object visible until this time value	

Attribute	Purpose	Default Value
VisibleFromTo	object visible during this time range	
VisibleAfterEnd	object visible after its animation time ended?	TRUE
VisibleBeforeBegin	object visible before its animation time starts?	TRUE

## Examples

### Example 1

Plot several rectangles and parallelograms using different presentation styles:

```
plot(plot::Parallelogram2d([2, 2], [0.5, 1]),  
      plot::Parallelogram2d([3, 3], [-1, 1],  
                             Filled = TRUE,  
                             Color = RGB::Red),  
      plot::Parallelogram2d([4, 4], [0, 1],  
                             LineStyle = Dashed,  
                             LineColor = RGB::Black),  
      plot::Parallelogram2d([5, 5], [0, 2],  
                             Filled = TRUE,  
                             FillColor = RGB::Red,  
                             LineColor = RGB::Green)  
)
```

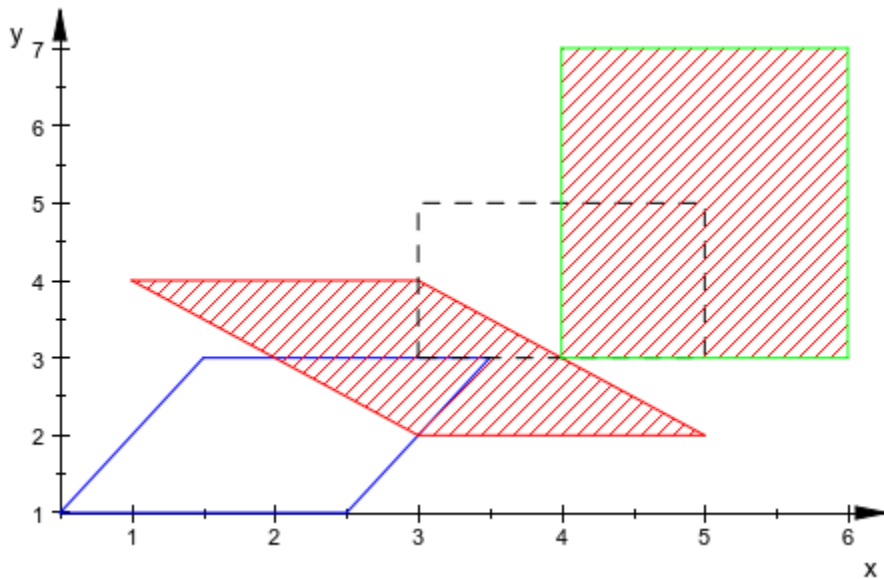

## Parameters

### $c_x, c_y$

Coordinates of the center: real numerical values or expressions of the animation parameter  $a$ .

$c_x, c_y$  are equivalent to the attributes CenterX, CenterY.

### $u_x, u_y$

Components of the first vector spanning the parallelogram: real numerical values or expressions of the animation parameter  $a$ .

$u_x, u_y$  are equivalent to the attributes Tangent1X, Tangent1Y.

### $v_x, v_y$

Components of the second vector spanning the parallelogram: real numerical values or expressions of the animation parameter  $a$ .

$v_x, v_y$  are equivalent to the attributes Tangent2X, Tangent2Y.

**a**

Animation parameter, specified as  $a = a_{min}..a_{max}$ , where  $a_{min}$  is the initial parameter value, and  $a_{max}$  is the final parameter value.

## See Also

**MuPAD Functions**

plot | plot::copy

**MuPAD Graphical Primitives**

plot::Box | plot::Line3d | plot::Parallelogram3d | plot::Polygon3d |  
plot::Rectangle

## plot::Parallelogram3d

3D parallelograms

### Syntax

`plot::Parallelogram3d([cx, cy, cz], [ux, uy, uz], [vx, vy, vz], <a = amin .. amax>, options)`

### Description

`plot::Parallelogram3d(c, u, v)` defines a 3D parallelogram

$\{\vec{c} + \lambda \vec{u} + \mu \vec{v} \mid \lambda \in [-1, 1], \mu \in [-1, 1]\}$  with center  $\vec{c}$  and vectors  $\vec{u}, \vec{v}$  spanning the plane of the parallelogram. This is a rectangle with sides of length  $2|\vec{u}|, 2|\vec{v}|$  if the vectors  $\vec{u}$  and  $\vec{v}$  are orthogonal.

`plot::Parallelogram3d` creates a 3D parallelogram with center  $\vec{c} = [c_x, c_y, c_z]$  and sides given by the vectors  $2\vec{u} = [2 u_x, 2 u_y, 2 u_z]$  and  $2\vec{v} = [2 v_x, 2 v_y, 2 v_z]$ . The corners of the parallelogram are given by  $\vec{c} - \vec{u} - \vec{v}$ ,  $\vec{c} - \vec{u} + \vec{v}$ ,  $\vec{c} + \vec{u} - \vec{v}$ , and  $\vec{c} + \vec{u} + \vec{v}$ :



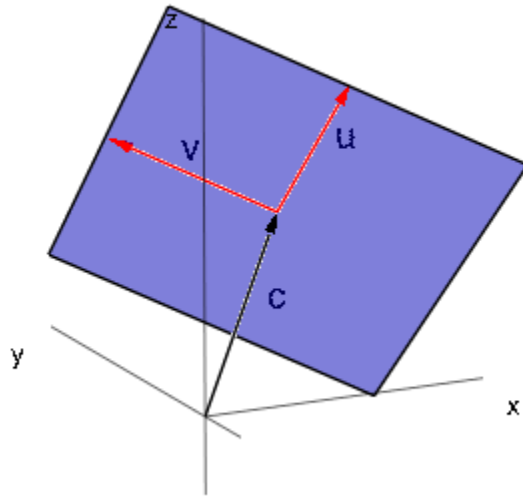

By default, the area of the parallelogram is filled with the color specified by the attribute `Color` or, equivalently, `FillColor`. With `Filled = FALSE`, only the border lines of the parallelogram are visible. Their color is set by the attribute `LineColor`.

Alternatively, the center and the spanning vectors can be given as vectors.

## Attributes

Attribute	Purpose	Default Value
<code>AffectViewingBox</code>	influence of objects on the <code>ViewingBox</code> of a scene	TRUE
<code>Center</code>	center of objects, rotation center	$[0, 0, 0]$
<code>CenterX</code>	center of objects, rotation center, x-component	0
<code>CenterY</code>	center of objects, rotation center, y-component	0

<b>Attribute</b>	<b>Purpose</b>	<b>Default Value</b>
CenterZ	center of objects, rotation center, z-component	0
Color	the main color	RGB::LightBlue
Filled	filled or transparent areas and surfaces	TRUE
FillColor	color of areas and surfaces	RGB::LightBlue
FillColor2	second color of areas and surfaces for color blends	RGB::CornflowerBlue
FillColorType	surface filling types	Flat
FillColorDirection	the direction of color transitions on surfaces	[0, 0, 1]
FillColorDirectionX	x-component of the direction of color transitions on surfaces	0
FillColorDirectionY	y-component of the direction of color transitions on surfaces	0
FillColorDirectionZ	z-component of the direction of color transitions on surfaces	1
Frames	the number of frames in an animation	50
Legend	makes a legend entry	
LegendText	short explanatory text for legend	
LegendEntry	add this object to the legend?	FALSE
LineColor	color of lines	RGB::Black.[0.25]
LineWidth	width of lines	0.35
LineStyle	solid, dashed or dotted lines?	Solid
LinesVisible	visibility of lines	TRUE

Attribute	Purpose	Default Value
Name	the name of a plot object (for browser and legend)	
ParameterEnd	end value of the animation parameter	
ParameterName	name of the animation parameter	
ParameterBegin	initial value of the animation parameter	
ParameterRange	range of the animation parameter	
Tangent1	first vector spanning parallelograms	[0, 1, 0]
Tangent2	second vector spanning parallelograms	[1, 0, 0]
Tangent1X	first vector spanning parallelograms, x component	0
Tangent1Y	first vector spanning parallelograms, y component	1
Tangent2X	second vector spanning parallelograms, x component	1
Tangent1Z	first vector spanning parallelograms, z component	0
Tangent2Y	second vector spanning parallelograms, y component	0
Tangent2Z	second vector spanning parallelograms, z component	0
TimeEnd	end time of the animation	10.0

Attribute	Purpose	Default Value
TimeBegin	start time of the animation	0.0
TimeRange	the real time span of an animation	0.0 .. 10.0
Title	object title	
TitleFont	font of object titles	[" sans-serif ", 11]
TitlePosition	position of object titles	
TitleAlignment	horizontal alignment of titles w.r.t. their coordinates	Center
TitlePositionX	position of object titles, x component	
TitlePositionY	position of object titles, y component	
TitlePositionZ	position of object titles, z component	
Visible	visibility	TRUE
VisibleAfter	object visible after this time value	
VisibleBefore	object visible until this time value	
VisibleFromTo	object visible during this time range	
VisibleAfterEnd	object visible after its animation time ended?	TRUE
VisibleBeforeBegin	object visible before its animation time starts?	TRUE

## Examples

### Example 1

Plot several rectangles and parallelograms using different presentation styles:

```

plot(plot::Parallelogram3d([1, 1, 1], [0, 0, 2], [0, 3, 0]),
      plot::Parallelogram3d([2, 2, 2], [0, 1, 4], [0, 2, 0],
                             FillColor = RGB::Red.[0.5]),
      plot::Parallelogram3d([3, 3, 3], [0, 1, 1], [0, 1, -1],
                             Filled = FALSE, LineStyle = Dashed,
                             LineColor = RGB::Black),
      plot::Parallelogram3d([4, 4, 4], [0, 1, 2], [0, 2, -2],
                             Filled = FALSE, LineColor = RGB::Green)
):

```

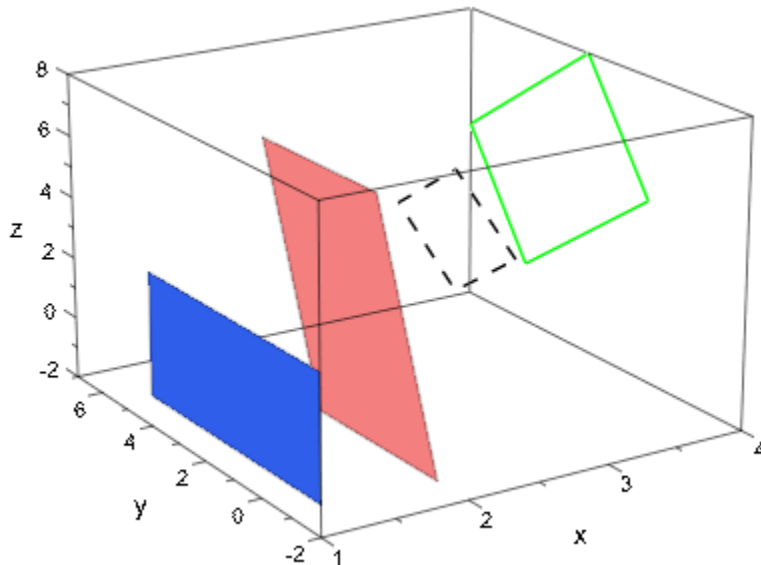

## Example 2

Use `plot::Parallelogram3d` to visualize tangent planes of a surface. The first surface is the graph of the function  $f(x, y) = x^2 + y^2$ . At a point  $(x, y, f(x, y))$  on the graph, the tangent vectors in the  $x$  and  $y$  direction are given by  $(1, 0, 2x)$  and  $(0, 1, 2y)$ , respectively. After normalization to the length 0.4, they yield the tangent vectors  $u, v$  used in the construction of the tangent planes:

```

f := (x, y) -> x^2 + y^2:
c := (x, y) -> [x, y, f(x, y)]:
u := (x, y) -> [0.4/sqrt(1+4*x^2), 0, 0.8*x/sqrt(1+4*x^2)]:

```

```

v := (x, y) -> [0, 0.4/sqrt(1+4*y^2), 0.8*y/sqrt(1+4*y^2)]:
plot(plot::Function3d(f(x, y), x = -1..1, y = -1..1),
      plot::Parallelogram3d(c(0, 0), u(0, 0), v(0, 0),
                           Color = RGB::Grey.[0.5]),
      plot::Parallelogram3d(c(0, -1), u(0, -1), v(0, -1),
                           Color = RGB::Grey.[0.5]),
      plot::Parallelogram3d(c(-1, 0), u(-1, 0), v(-1, 0),
                           Color = RGB::Grey.[0.5]),
      plot::Parallelogram3d(c(-1/2, -1/2), u(-1/2, -1/2),
                           v(-1/2, -1/2),
                           Color = RGB::Grey.[0.5]))):

```

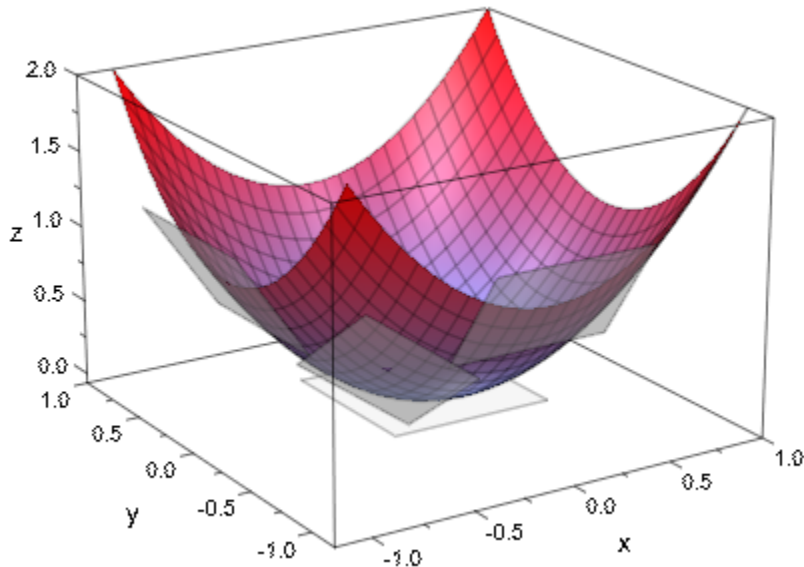

The second surface is a sphere, parametrized by spherical coordinates  $p$  and  $t$  (polar and azimuth angle). At a point  $(x(p, t), y(p, t), z(p, t))$  on the sphere, the tangent vectors in the  $p$  and  $t$  direction are given by differentiation of  $x, y, z$  with respect to  $p$  and  $t$ , respectively. After normalization to the length 0.5, they yield the tangent vectors  $u, v$  used in the construction of the tangent planes:

```

x := (p, t) -> cos(p)*sin(t):
y := (p, t) -> sin(p)*sin(t):
z := (p, t) -> cos(t):
c := (p, t) -> [x(p, t), y(p, t), z(p, t)]:

```

```
u := (p, t) -> [-0.5*sin(p), 0.5*cos(p), 0]:
v := (p, t) -> [0.5*cos(p)*cos(t), 0.5*sin(p)*cos(t),
               -0.5*sin(t)]:
plot(plot::Surface(c(p, t), p = 0..2*PI, t = 0..PI),
      plot::Point3d(c(0, 0), Color = RGB::Black),
      plot::Parallelogram3d(c(0, 0), u(0, 0), v(0, 0),
                            Color = RGB::Grey.[0.5]),
      plot::Point3d(c(-3*PI/4, PI/4), Color = RGB::Black),
      plot::Parallelogram3d(c(-3*PI/4, PI/4),
                            u(-3*PI/4, PI/4),
                            v(-3*PI/4, PI/4),
                            Color = RGB::Grey.[0.5]),
      plot::Point3d(c(-PI/2, PI/3), Color = RGB::Black),
      plot::Parallelogram3d(c(-PI/2, PI/3),
                            u(-PI/2, PI/3),
                            v(-PI/2, PI/3),
                            Color = RGB::Grey.[0.5]),
      plot::Point3d(c(PI, PI/2), Color = RGB::Black),
      plot::Parallelogram3d(c(PI, PI/2),
                            u(PI, PI/2),
                            v(PI, PI/2),
                            Color = RGB::Grey.[0.5]),
      Scaling = Constrained):
```

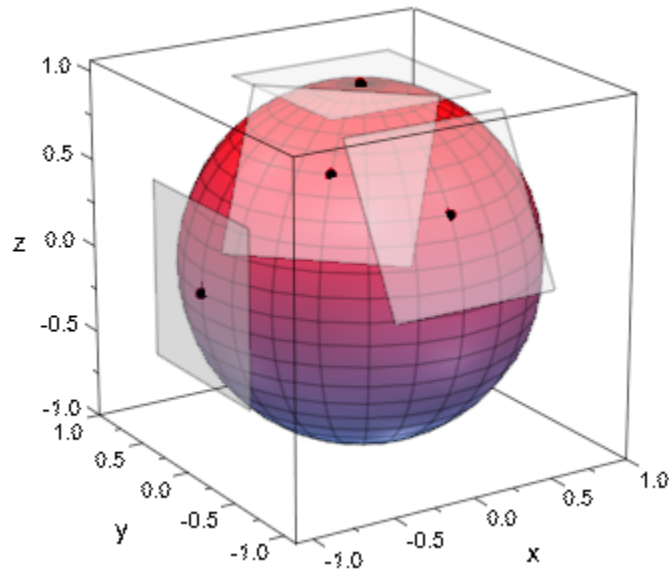

delete f, c, u, v, x, y, z:

## Parameters

**$c_x, c_y, c_z$**

Coordinates of the center: real numerical values or expressions of the animation parameter  $a$ .

$c_x, c_y, c_z$  are equivalent to the attributes CenterX, CenterY, CenterZ.

**$u_x, u_y, u_z$**

Components of the first vector spanning the parallelogram: real numerical values or expressions of the animation parameter  $a$ .

$u_x, u_y, u_z$  are equivalent to the attributes Tangent1X, Tangent1Y, Tangent1Z.



**$v_x, v_y, v_z$** 

Components of the second vector spanning the parallelogram: real numerical values or expressions of the animation parameter  $a$ .

$v_x, v_y, v_z$  are equivalent to the attributes Tangent2X, Tangent2Y, Tangent2Z.

 **$a$** 

Animation parameter, specified as  $a = a_{\min}..a_{\max}$ , where  $a_{\min}$  is the initial parameter value, and  $a_{\max}$  is the final parameter value.

## See Also

### MuPAD Functions

plot | plot::copy

### MuPAD Graphical Primitives

plot::Box | plot::Line3d | plot::Parallelogram2d | plot::Polygon3d |  
plot::Rectangle

## plot::Piechart2d

2D pie charts

### Syntax

```
plot::Piechart2d([d1, d2, ...], <a = amin .. amax>, options)
```

```
plot::Piechart2d(A, <a = amin .. amax>, options)
```

### Description

`plot::Piechart2d([d1, d2, d3, ...])` creates a 2D pie chart with pieces of size ratios  $d_1 : d_2 : d_3 : \dots$ .

With the input data  $d_1, d_2$  etc., the  $i$ -th piece of the pie has the opening angle  $\frac{2\pi d_i}{d_1 d_2 \dots}$ .

The attribute `Titles` lets you attach titles to the pieces of the pie chart. In contrast to the overall title of the pie chart (`Title`, `TitleFont`), the titles of the pieces react to `TextFont`.

The attribute `Moves` lets you move the pieces away from the pie center for highlighting.

The attributes `Center` and `Radius` let you position and scale a pie chart relative to other graphical objects in the same scene.

### Attributes

Attribute	Purpose	Default Value
<code>AffectViewingBox</code>	influence of objects on the <code>ViewingBox</code> of a scene	TRUE
<code>AntiAliased</code>	antialiased lines and points?	TRUE

<b>Attribute</b>	<b>Purpose</b>	<b>Default Value</b>
Center	center of objects, rotation center	[0, 0]
CenterX	center of objects, rotation center, x-component	0
CenterY	center of objects, rotation center, y-component	0
Color	the main color	
Colors	list of colors to use	[RGB::Blue, RGB::Red, RGB::Green, RGB::MuPADGold, RGB::Orange, RGB::Cyan, RGB::Magenta, RGB::LimeGreen, RGB::CadmiumYellowLight, RGB::AlizarinCrimson]
Data	the (statistical) data to plot	[1]
Filled	filled or transparent areas and surfaces	TRUE
FillPattern	type of area filling	Solid
Frames	the number of frames in an animation	50
Legend	makes a legend entry	
LegendText	short explanatory text for legend	
LegendEntry	add this object to the legend?	FALSE
LineColor	color of lines	RGB::Black
LineWidth	width of lines	0.35
LineStyle	solid, dashed or dotted lines?	Solid
LinesVisible	visibility of lines	TRUE

<b>Attribute</b>	<b>Purpose</b>	<b>Default Value</b>
Moves	displacements of pieces in pie charts	[0]
Name	the name of a plot object (for browser and legend)	
ParameterEnd	end value of the animation parameter	
ParameterName	name of the animation parameter	
ParameterBegin	initial value of the animation parameter	
ParameterRange	range of the animation parameter	
Radius	radius of circles, spheres etc.	1
TextFont	font of text objects	[" sans-serif ", 11]
TimeEnd	end time of the animation	10.0
TimeBegin	start time of the animation	0.0
TimeRange	the real time span of an animation	0.0 .. 10.0
Title	object title	
Titles	list of titles for object parts	[" "]
TitleFont	font of object titles	[" sans-serif ", 11]
TitlePosition	position of object titles	
TitleAlignment	horizontal alignment of titles w.r.t. their coordinates	Center
TitlePositionX	position of object titles, x component	
TitlePositionY	position of object titles, y component	
Visible	visibility	TRUE

Attribute	Purpose	Default Value
VisibleAfter	object visible after this time value	
VisibleBefore	object visible until this time value	
VisibleFromTo	object visible during this time range	
VisibleAfterEnd	object visible after its animation time ended?	TRUE
VisibleBeforeBegin	object visible before its animation time starts?	TRUE

## Examples

### Example 1

Create a 2D pie chart with pieces of the size ratios 1:2:1:3:2.5.

```
p := plot::Piechart2d([1, 2, 1, 3, 2.5]):  
plot(p)
```

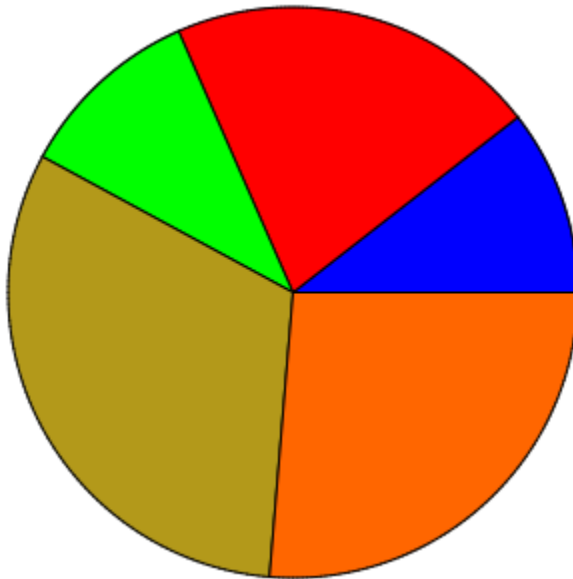

Set titles for the pieces:

```
p::Titles := ["10.5%", "21.1%", "10.5%", "31.6%", "26.3%"]:
plot(p)
```

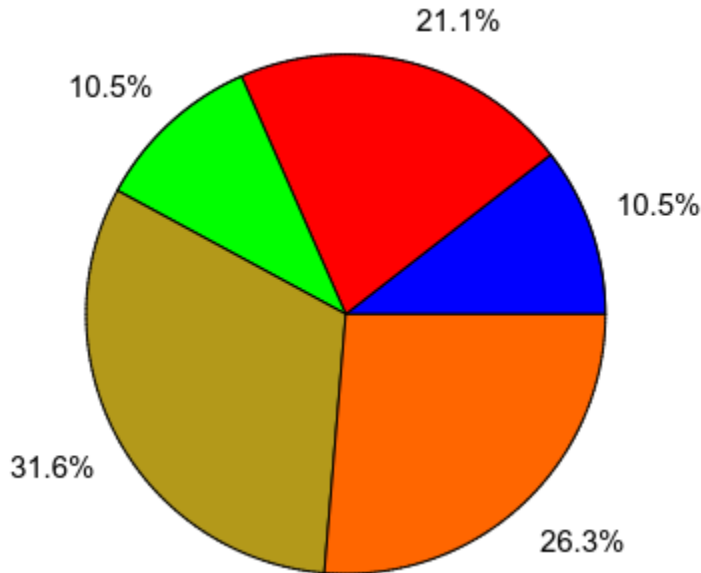

Pieces can be moved away from the pie center with the attribute `Moves`. One or more moves can be given as a list of values `[f1, f2, ...]`. The “move factors”  $f_1$ ,  $f_2$ , and so on, are positive real values that represent fractions of the pie radius. The  $i$ -th piece is moved away from the center by  $f_i$ . To move only some pieces, you can specify `Moves = [n1 = f1, n2 = f2, ...]`, such that only the pieces with indices  $n_1$ ,  $n_2$ , and so on, are moved:

```
p::Moves := [1 = 0.3, 3 = 0.5]:  
plot(p)
```

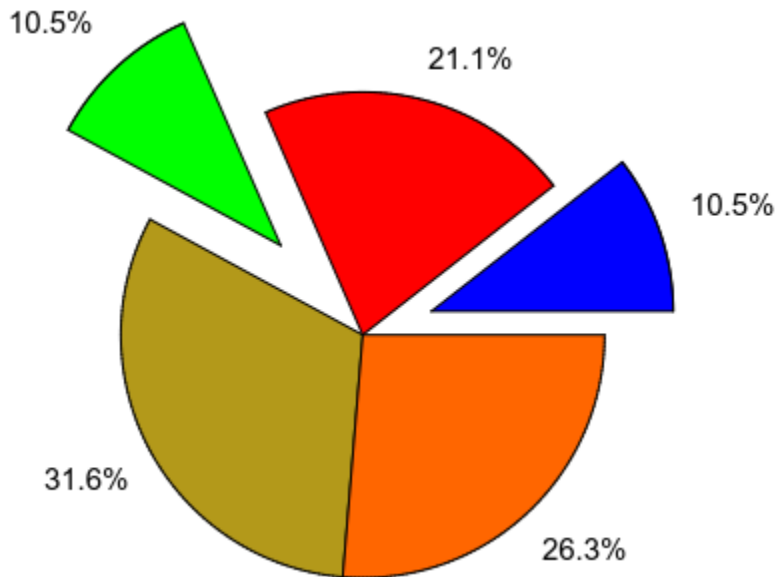

delete p:

## Parameters

$d_1, d_2, \dots$

The sizes of the pieces: nonnegative real values or arithmetical expressions (Symbolic Math Toolbox) of the animation parameter  $a$ .

$d_1, d_2, \dots$  is equivalent to the attribute Data.

**A**

A matrix or array containing the data  $d_1, d_2$ , and so on.

**a**

Animation parameter, specified as  $a = a_{\min} \dots a_{\max}$ , where  $a_{\min}$  is the initial parameter value, and  $a_{\max}$  is the final parameter value.



## See Also

### MuPAD Functions

plot | plot::copy

### MuPAD Graphical Primitives

plot::Bars2d | plot::Bars3d | plot::Boxplot | plot::Histogram2d |  
plot::Matrixplot | plot::Piechart3d

## Topics

“Create Bar Charts, Histograms, and Pie Charts” (Symbolic Math Toolbox)

## plot::Piechart3d

3D pie charts

### Syntax

```
plot::Piechart3d([d1, d2, ...], <a = amin .. amax>, options)
```

```
plot::Piechart3d(A, <a = amin .. amax>, options)
```

### Description

`plot::Piechart3d([d1, d2, d3, ...])` creates a corresponding 3D pie chart.

With the input data  $d_1, d_2$  etc., the  $i$ -th piece of the pie has the opening angle  $\frac{2\pi d_i}{d_1 d_2 \dots}$ .

The attribute `Titles` lets you attach titles to the pieces of the pie. In contrast to the overall title of the pie chart (`Title`, `TitleFont`), the titles of the pieces react to `TextFont`.

The attribute `Moves` lets you move the pieces away from the pie center for highlighting.

The attribute `Heights` lets you vary heights of the pieces.

The attributes `Center` and `Radius` let you position and scale a pie chart relative to other graphical objects in the same scene.

### Attributes

Attribute	Purpose	Default Value
<code>AffectViewingBox</code>	influence of objects on the <code>ViewingBox</code> of a scene	TRUE

Attribute	Purpose	Default Value
Billboarding	text orientation in space or towards observer	TRUE
Center	center of objects, rotation center	[0, 0, 0]
CenterX	center of objects, rotation center, x-component	0
CenterY	center of objects, rotation center, y-component	0
CenterZ	center of objects, rotation center, z-component	0
Color	the main color	
Colors	list of colors to use	[RGB::Blue, RGB::Red, RGB::Green, RGB::MuPADGold, RGB::Orange, RGB::Cyan, RGB::Magenta, RGB::LimeGreen, RGB::CadmiumYellowLight, RGB::AlizarinCrimson]
Data	the (statistical) data to plot	[1]
Filled	filled or transparent areas and surfaces	TRUE
Frames	the number of frames in an animation	50
Heights	heights of pieces in pie charts	[0.3]
Legend	makes a legend entry	
LegendText	short explanatory text for legend	
LegendEntry	add this object to the legend?	FALSE
LineColor	color of lines	RGB::Black.[0.25]

<b>Attribute</b>	<b>Purpose</b>	<b>Default Value</b>
LineWidth	width of lines	0.35
LineStyle	solid, dashed or dotted lines?	Solid
LinesVisible	visibility of lines	TRUE
Moves	displacements of pieces in pie charts	[0]
Name	the name of a plot object (for browser and legend)	
ParameterEnd	end value of the animation parameter	
ParameterName	name of the animation parameter	
ParameterBegin	initial value of the animation parameter	
ParameterRange	range of the animation parameter	
Radius	radius of circles, spheres etc.	1
TextFont	font of text objects	[" sans-serif ", 11]
TimeEnd	end time of the animation	10.0
TimeBegin	start time of the animation	0.0
TimeRange	the real time span of an animation	0.0 .. 10.0
Title	object title	
Titles	list of titles for object parts	[" "]
TitleFont	font of object titles	[" sans-serif ", 11]
TitlePosition	position of object titles	
TitleAlignment	horizontal alignment of titles w.r.t. their coordinates	Center
TitlePositionX	position of object titles, x component	

Attribute	Purpose	Default Value
TitlePositionY	position of object titles, y component	
TitlePositionZ	position of object titles, z component	
Visible	visibility	TRUE
VisibleAfter	object visible after this time value	
VisibleBefore	object visible until this time value	
VisibleFromTo	object visible during this time range	
VisibleAfterEnd	object visible after its animation time ended?	TRUE
VisibleBeforeBegin	object visible before its animation time starts?	TRUE

## Examples

### Example 1

Create a 3D pie chart with pieces of the size ratios 1:2:1:3:2.5.

```
p := plot::Piechart3d([1, 2, 1, 3, 2.5]):
plot(p)
```

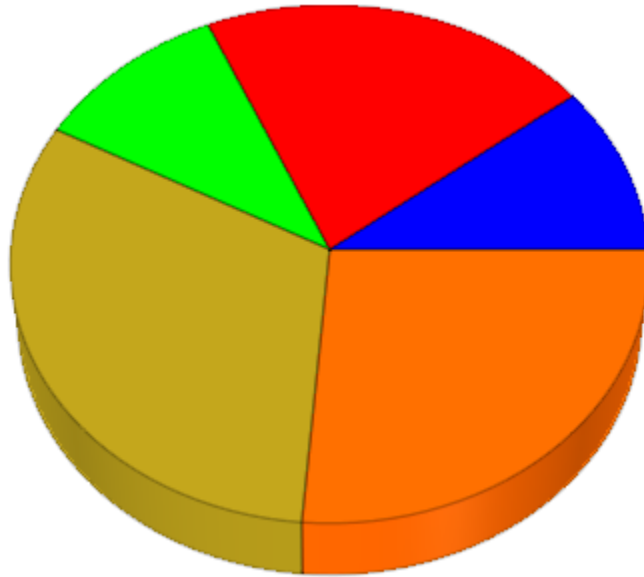

Set titles for the pieces:

```
p::Titles := ["10.5%", "21.1%", "10.5%", "31.6%", "26.3%"]:
plot(p)
```

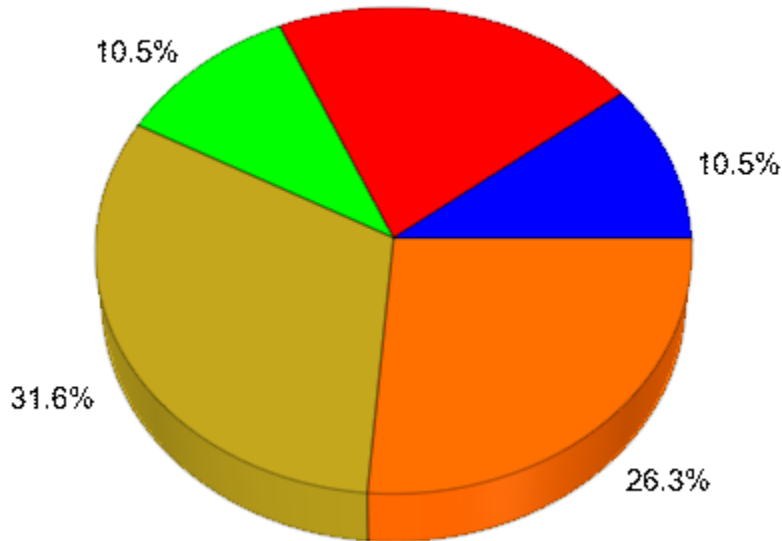

Pieces can be moved away from the pie center with the attribute `Moves`. One or more moves can be given as a list of values `[f1, f2, ...]`. The “move factors”  $f_1$ ,  $f_2$ , and so on, are positive real values that represent fractions of the pie radius. The  $i$ -th piece is moved away from the center by  $f_i$ . To move only some pieces, you can specify `Moves = [n1 = f1, n2 = f2, ...]`, such that only the pieces with indices  $n_1$ ,  $n_2$ , and so on, are moved:

```
p::Moves := [1 = 0.3, 3 = 0.5]:  
plot(p)
```

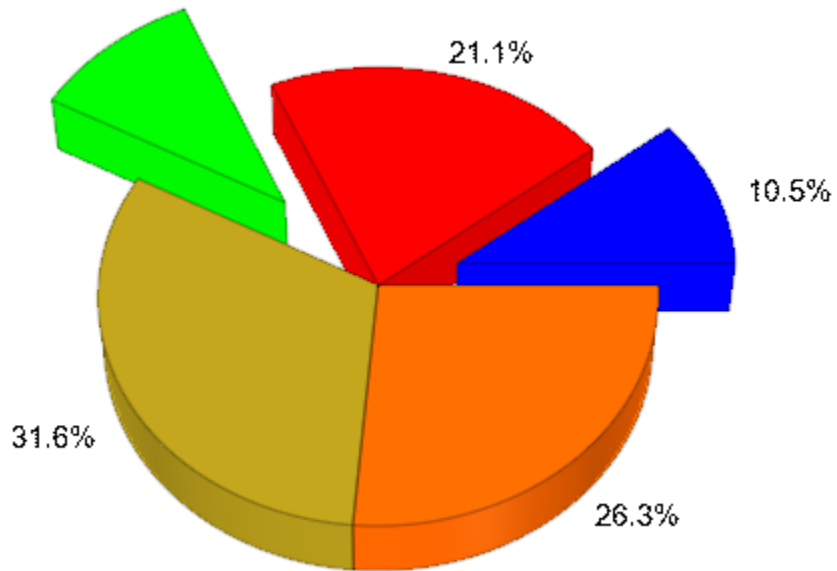

The heights of the pieces in a 3D pie chart can vary:

```
p::Heights := [0.1, 0.2, 0.1, 0.3, 0.25]:  
plot(p)
```



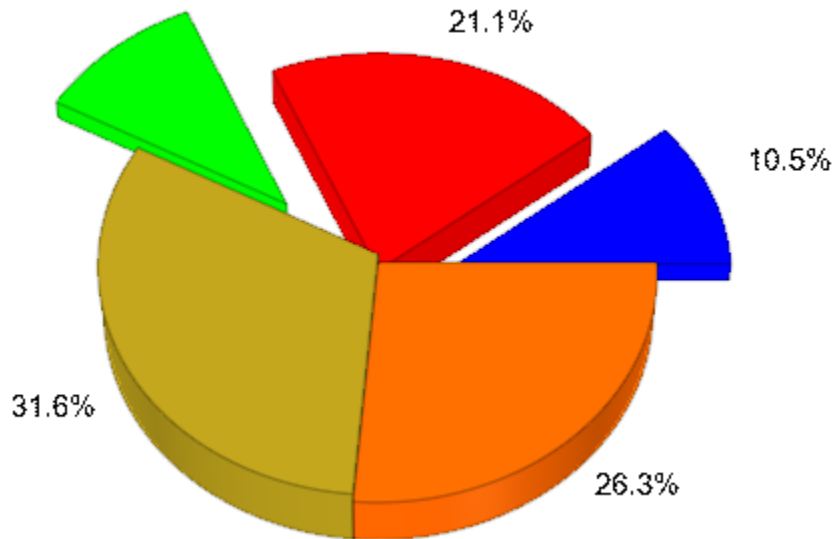

delete p:

## Example 2

A pie chart can be animated. Plot a pie chart with an animated radius. The pieces move in and out, changing their size:

```
m1 := piecewise([abs(a - PI/4) <= PI/4, sin(2*a)^2/3],
               [abs(a - PI/4) > PI/4, 0]):
m2 := piecewise([abs(a - 3*PI/4) <= PI/4, sin(2*a)^2/3],
               [abs(a - 3*PI/4) > PI/4, 0]):
m3 := piecewise([abs(a - 5*PI/4) <= PI/4, sin(2*a)^2/3],
               [abs(a - 5*PI/4) > PI/4, 0]):
m4 := piecewise([abs(a - 7*PI/4) <= PI/4, sin(2*a)^2/3],
               [abs(a - 7*PI/4) > PI/4, 0]):
p := plot::Piechart3d([5 + sin(a)/4, 2, 1 + sin(a)/2, 4],
                    Title = "crazy pie chart",
                    TitlePosition = [0, 15, 5],
                    TitleFont = [Italic, 18],
                    Center = [0, 0, 0],
                    Radius = 10 + sin(2*a),
                    Heights = [1.5 + sin(a), 1.5 + cos(2*a),
```

```
1.5 + sin(a), 1.5 + cos(4*a)],  
Titles = [1 = "piece 1", 2 = "piece 2",  
          3 = "piece 3", 4 = "piece 4"],  
Moves = [m1, m2, m3, m4],  
a = 0..2*PI):  
plot(p):
```

*crazy pie chart*



```
delete m1, m2, m3, m4, p:
```

## Parameters

$d_1, d_2, \dots$

The sizes of the pieces: non-negative real values or arithmetical expressions (Symbolic Math Toolbox) of the animation parameter  $a$ .

$d_1, d_2, \dots$  is equivalent to the attribute Data.

**A**

A matrix or array containing the data  $d_1, d_2$ , and so on.

**a**

Animation parameter, specified as  $a = a_{\min} \dots a_{\max}$ , where  $a_{\min}$  is the initial parameter value, and  $a_{\max}$  is the final parameter value.

## See Also

**MuPAD Functions**

plot | plot::copy

**MuPAD Graphical Primitives**

plot::Bars2d | plot::Bars3d | plot::Boxplot | plot::Histogram2d |  
plot::Matrixplot | plot::Piechart2d

## Topics

“Create Bar Charts, Histograms, and Pie Charts” (Symbolic Math Toolbox)

## plot::Plane

Infinite plane in 3D

### Syntax

```
plot::Plane([x, y, z], <[nx, ny, nz]>, <a = amin .. amax>, options)
```

```
plot::Plane(X, <N>, <a = amin .. amax>, options)
```

```
plot::Plane(XN, <a = amin .. amax>, options)
```

```
plot::Plane(p1, p2, p3, <a = amin .. amax>, options)
```

```
plot::Plane(p123, <a = amin .. amax>, options)
```

### Description

`plot::Plane(x, n)` creates the (infinite) plane with normal vector  $n$  passing through the point  $x$ .

`plot::Plane` provides a graphical plane in 3D that does not require a specification, which part of the plane is to be seen in the picture. The visible part of the plane is determined automatically by the `ViewingBox` of the entire 3D scene.

The contribution of a plane of type `plot::Plane` to the `ViewingBox` of a 3D scene consists only of the single point  $[x, y, z]$  (this is  $p_1$ , if the plane is specified by three points  $p_1, p_2, p_3$  on the plane).

Thus, two planes with the same normal but different points may be mathematically equivalent, but may produce different pictures due to different viewing boxes. Cf. “Example 3” on page 24-579 (Symbolic Math Toolbox).

By default, a mesh of lines is displayed on the plane. Use the attribute `Mesh = [n1, n2]` with positive integer values  $n_1, n_2$  to control the number of mesh lines.

## Attributes

Attribute	Purpose	Default Value
AffectViewingBox	influence of objects on the ViewingBox of a scene	TRUE
Color	the main color	RGB::LightBlue
Filled	filled or transparent areas and surfaces	TRUE
FillColor	color of areas and surfaces	RGB::LightBlue
Frames	the number of frames in an animation	50
Legend	makes a legend entry	
LegendText	short explanatory text for legend	
LegendEntry	add this object to the legend?	FALSE
LineColor	color of lines	RGB::Black.[0.25]
LinesVisible	visibility of lines	TRUE
Mesh	number of sample points	[15, 15]
Name	the name of a plot object (for browser and legend)	
Normal	normal vector of circles and discs, etc. in 3D	[0, 0, 1]
NormalX	normal vector of circles and discs, etc. in 3D, x-component	0
NormalY	normal vector of circles and discs, etc. in 3D, y-component	0
NormalZ	normal vector of circles and discs, etc. in 3D, z-component	1

<b>Attribute</b>	<b>Purpose</b>	<b>Default Value</b>
ParameterEnd	end value of the animation parameter	
ParameterName	name of the animation parameter	
ParameterBegin	initial value of the animation parameter	
ParameterRange	range of the animation parameter	
Position	positions of cameras, lights, and text objects	[0, 0, 0]
PositionX	x-positions of cameras, lights, and text objects	0
PositionY	y-positions of cameras, lights, and text objects	0
PositionZ	z-positions of cameras, lights, and text objects	0
TimeEnd	end time of the animation	10.0
TimeBegin	start time of the animation	0.0
TimeRange	the real time span of an animation	0.0 .. 10.0
Title	object title	
TitleFont	font of object titles	[" sans-serif ", 11]
TitlePosition	position of object titles	
TitleAlignment	horizontal alignment of titles w.r.t. their coordinates	Center
TitlePositionX	position of object titles, x component	
TitlePositionY	position of object titles, y component	
TitlePositionZ	position of object titles, z component	

Attribute	Purpose	Default Value
UMesh	number of sample points for parameter "u"	15
VMesh	number of sample points for parameter "v"	15
Visible	visibility	TRUE
VisibleAfter	object visible after this time value	
VisibleBefore	object visible until this time value	
VisibleFromTo	object visible during this time range	
VisibleAfterEnd	object visible after its animation time ended?	TRUE
VisibleBeforeBegin	object visible before its animation time starts?	TRUE

## Examples

### Example 1

We generate two spheres and a plane:

```
plot(plot::Sphere(1, [-1, -1, -1], Color = RGB::Red),
      plot::Sphere(1, [ 1,  1,  1], Color = RGB::Green),
      plot::Plane([0, 0, 0], [0, 0, 1], Color = RGB::Blue)):
```

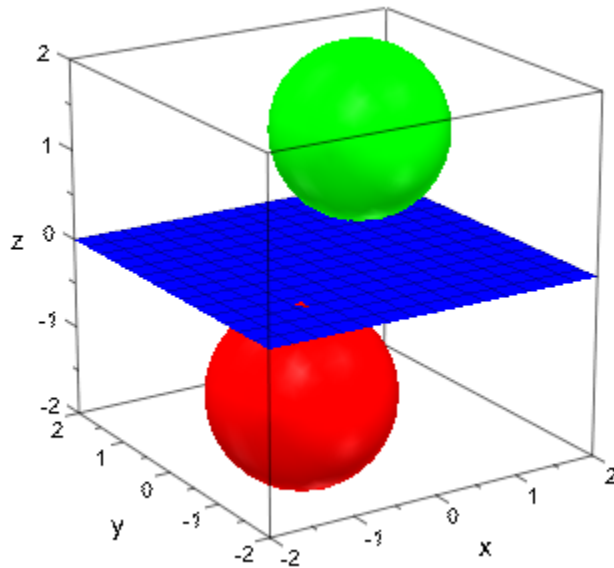

We specify an explicit `ViewingBox` for the scene:

```
plot(plot::Sphere(1, [-1, -1, -1], Color = RGB::Red),  
      plot::Sphere(1, [ 1,  1,  1], Color = RGB::Green),  
      plot::Plane([0, 0, 0], [0, 0, 1], Color = RGB::Blue),  
      ViewingBox = [-3..8, -3..8, -3..3]):
```



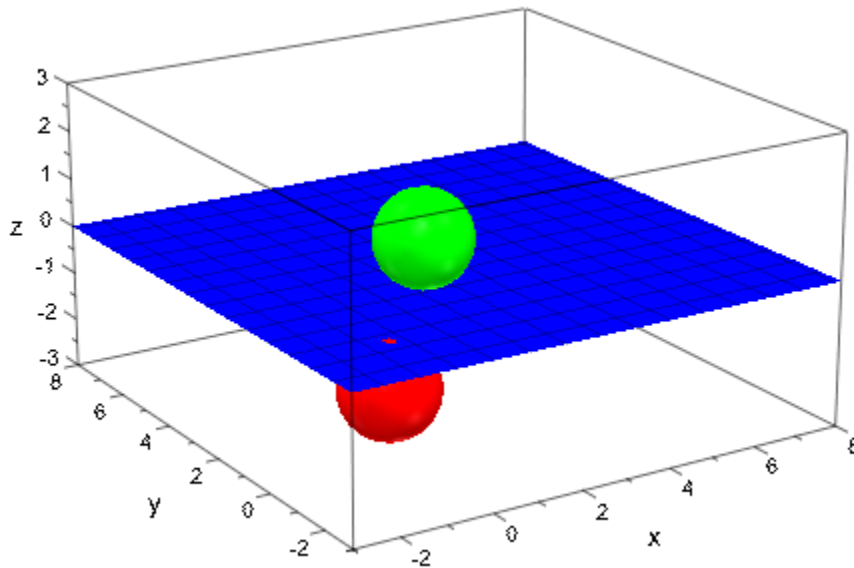

## Example 2

We demonstrate the effect of the attribute `Mesh` that controls the number of mesh lines displayed on planes:

```
plot(plot::Plane([0, 0, 0], [1, -1, 1], Color = RGB::Red,  
                Mesh = [5, 5]),  
      plot::Plane([0, 1, 0], [2, 1, -1], Color = RGB::Green,  
                Mesh = [10, 10]),  
      plot::Plane([1, -1, 0], [1, 1, 1], Color = RGB::Blue,  
                Mesh = [20, 20]),  
      ViewingBox = [-1..3, -2..2, -2..2])
```

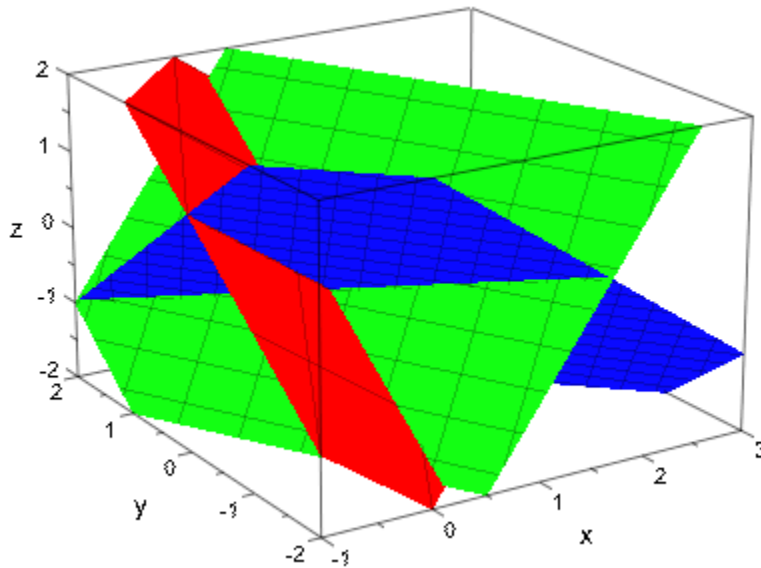

We change the number of mesh lines:

```
plot(plot::Plane([0, 0, 0], [1, -1, 1], Color = RGB::Red,  
                Mesh = [10, 10]),  
      plot::Plane([0, 1, 0], [2, 1, -1], Color = RGB::Green,  
                Mesh = [20, 10]),  
      plot::Plane([1, -1, 0], [1, 1, 1], Color = RGB::Blue,  
                Mesh = [15, 5]),  
      ViewingBox = [-1..3, -2..2, -2..2])
```

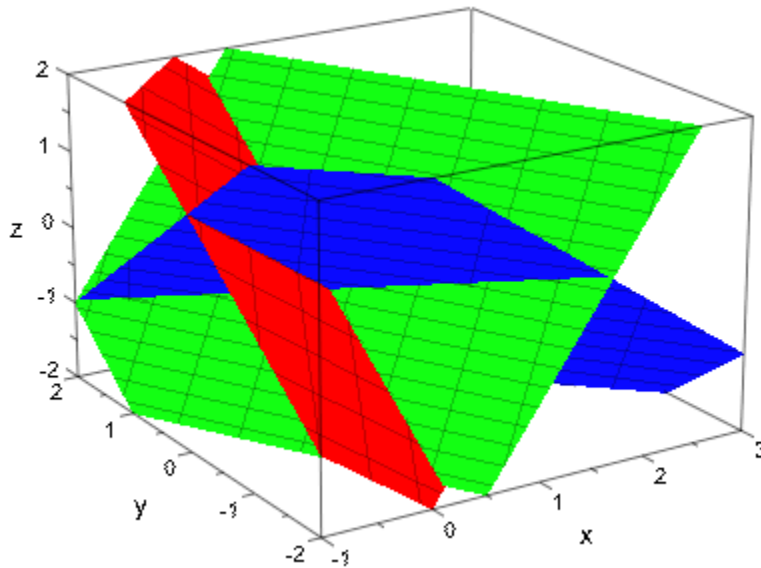

### Example 3

The contribution of a plane to the automatic `ViewingBox` of the whole scene consists only of the point used to specify the plane. In the following scene, this point is the origin. It lies inside the `ViewingBox` generated by the two spheres. Thus, the `ViewingBox` of the scene is determined by the two spheres only:

```
plot(plot::Sphere(1, [1, 1, 1], Color = RGB::Red),  
      plot::Sphere(1, [-1, -1, -1], Color = RGB::Green),  
      plot::Plane([0, 0, 0], [0, 0, 1], Color = RGB::Blue)):
```

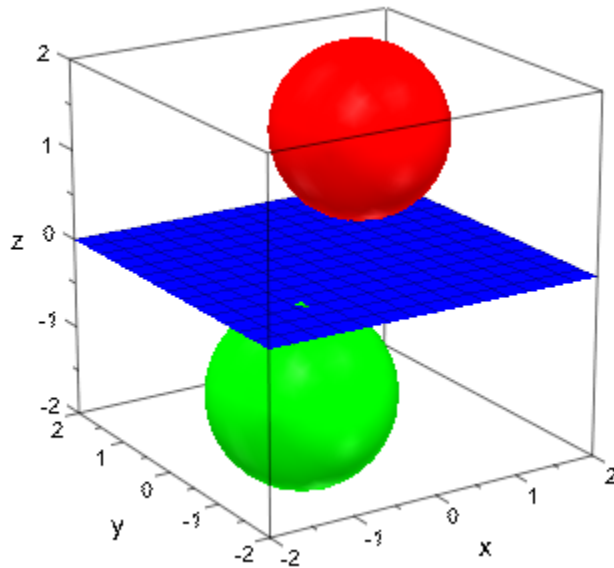

Now, a different point  $[5, 0, 0]$  is used to specify the same plane. It does not lie inside the ViewingBox generated by the two spheres and thus enlarges the ViewingBox of the scene:

```
plot(plot::Sphere(1, [1, 1, 1], Color = RGB::Red),  
      plot::Sphere(1, [-1, -1, -1], Color = RGB::Green),  
      plot::Plane([5, 0, 0], [0, 0, 1], Color = RGB::Blue)):
```

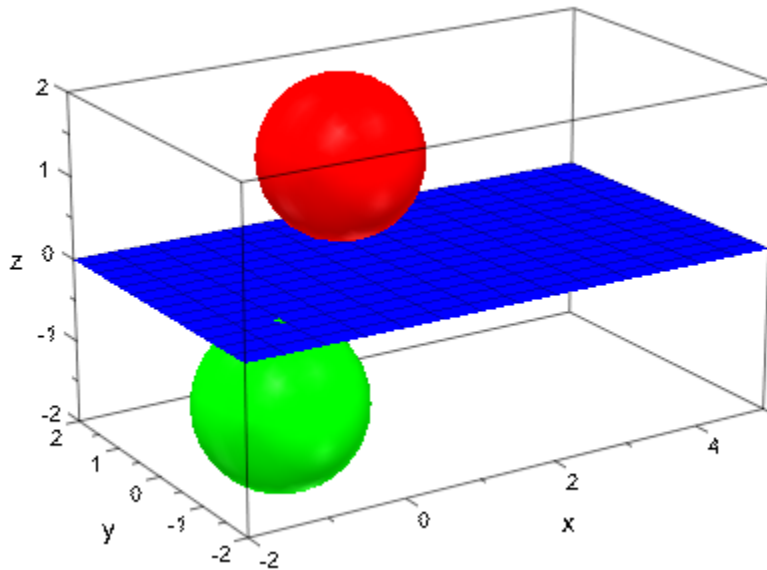

## Example 4

We create animated planes:

```
plot(plot::Plane([0, 0, 0], [cos(a), sin(a), 0], a = 0..PI,
  Color = RGB::Red),
  plot::Plane([0, 0, 0], [0, cos(a), sin(a)], a = 0..PI,
  Color = RGB::Green),
  plot::Plane([0, 0, a], [0, 0, 1], a = 0..1,
  Color = RGB::Blue),
  ViewingBox = [-1..1, -1..1, -1..1])
```

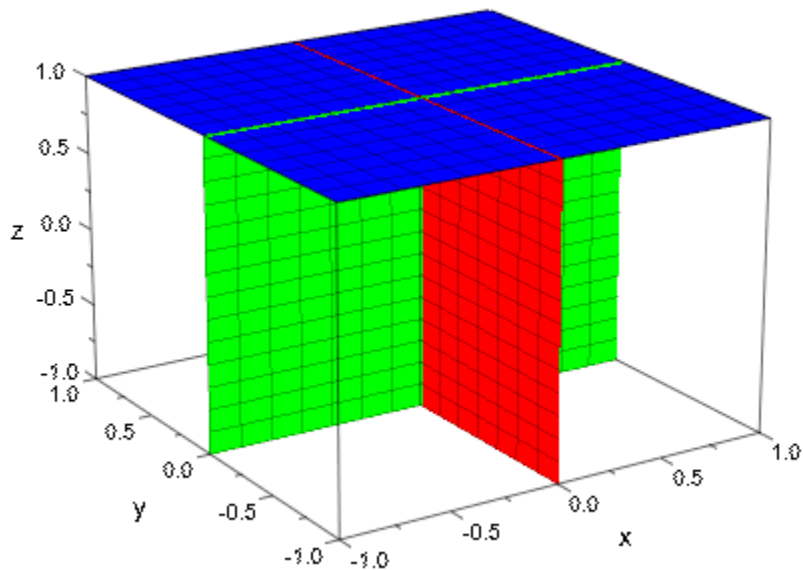

## Parameters

### **x, y, z**

The coordinates of a point on the plane: numerical real values or arithmetical expressions (Symbolic Math Toolbox) in the animation parameter **a**.

**x, y, z** are equivalent to the attributes **PositionX, PositionY, PositionZ**.

### **n<sub>x</sub>, n<sub>y</sub>, n<sub>z</sub>**

The components of the normal vector; **n<sub>x</sub>, n<sub>y</sub>, n<sub>z</sub>** must be numerical real values or arithmetical expressions (Symbolic Math Toolbox) in the animation parameter **a**. If no normal is specified, the normal (0, 0, 1) is used.

**n<sub>x</sub>, n<sub>y</sub>, n<sub>z</sub>** are equivalent to the attributes **NormalX, NormalY, NormalZ**.

**X**

A matrix on page 1-1340 of category `Cat::Matrix` with three entries that provide the coordinates  $x$ ,  $y$ ,  $z$  of a point on the plane.

X is equivalent to the attribute `Position`.

**N**

A matrix on page 1-1340 of category `Cat::Matrix` with three entries that provide the components  $n_x$ ,  $n_y$ ,  $n_z$  of the normal.

N is equivalent to the attribute `Normal`.

**XN**

A matrix on page 1-1340 of category `Cat::Matrix` with 3 rows and 2 columns. The first column provides the coordinates  $x$ ,  $y$ ,  $z$  of a point on the plane, the second column provides the components  $n_x$ ,  $n_y$ ,  $n_z$  of the normal.

XN is equivalent to the attributes `Position`, `Normal`.

**p<sub>1</sub>, p<sub>2</sub>, p<sub>3</sub>**

Three points on the plane: either lists with 3 entries each or matrices on page 1-1340 of category `Cat::Matrix` with 3 entries each. The point  $p_1$  corresponds to the attribute `Position`, the normal of the plane (the attribute `Normal`) is computed as the cross product  $(p_2 - p_1) \times (p_3 - p_1)$ .

**p<sub>123</sub>**

A matrix on page 1-1340 of category `Cat::Matrix` with 3 rows and 3 columns. Each column corresponds to a point on the plane.

**a**

Animation parameter, specified as  $a = a_{\min} \dots a_{\max}$ , where  $a_{\min}$  is the initial parameter value, and  $a_{\max}$  is the final parameter value.

## See Also

### **MuPAD Functions**

`plot` | `plot::copy`

### **MuPAD Graphical Primitives**

`plot::Parallelogram3d` | `plot::Surface`



# plot::Point2d

2D points

## Syntax

```
plot::Point2d(x, y, <a = amin .. amax>, options)
```

```
plot::Point2d([x, y], <a = amin .. amax>, options)
```

```
plot::Point2d(matrix([x, y]), <a = amin .. amax>, options)
```

## Description

`plot::Point2d(x, y)` creates a two-dimensional point with the coordinates  $(x, y)$ . You also can specify the point by a list  $[x, y]$  or a vector `matrix([x, y])` of its coordinates.

## Attributes

Attribute	Purpose	Default Value
AffectViewingBox	influence of objects on the ViewingBox of a scene	TRUE
AntiAliased	antialiased lines and points?	TRUE
Color	the main color	RGB::MidnightBlue
Frames	the number of frames in an animation	50
Legend	makes a legend entry	
LegendText	short explanatory text for legend	
LegendEntry	add this object to the legend?	FALSE

<b>Attribute</b>	<b>Purpose</b>	<b>Default Value</b>
Name	the name of a plot object (for browser and legend)	
ParameterEnd	end value of the animation parameter	
ParameterName	name of the animation parameter	
ParameterBegin	initial value of the animation parameter	
ParameterRange	range of the animation parameter	
PointSize	the size of points	1.5
PointColor	the color of points	RGB::MidnightBlue
PointStyle	the presentation style of points	FilledCircles
Position	positions of cameras, lights, and text objects	[0, 0]
PositionX	x-positions of cameras, lights, and text objects	0
PositionY	y-positions of cameras, lights, and text objects	0
TimeEnd	end time of the animation	10.0
TimeBegin	start time of the animation	0.0
TimeRange	the real time span of an animation	0.0 .. 10.0
Title	object title	
TitleFont	font of object titles	[" sans-serif ", 11]
TitlePosition	position of object titles	
TitleAlignment	horizontal alignment of titles w.r.t. their coordinates	Center
TitlePositionX	position of object titles, x component	

Attribute	Purpose	Default Value
TitlePositionY	position of object titles, y component	
Visible	visibility	TRUE
VisibleAfter	object visible after this time value	
VisibleBefore	object visible until this time value	
VisibleFromTo	object visible during this time range	
VisibleAfterEnd	object visible after its animation time ended?	TRUE
VisibleBeforeBegin	object visible before its animation time starts?	TRUE

## Examples

### Example 1

Create three points:

```
p1 := plot::Point2d(1, 3, PointSize = 4*unit::mm);
p2 := plot::Point2d(2, 2, PointSize = 5*unit::mm);
p3 := plot::Point2d(3, 1, Color = RGB::Green,
                    PointSize = 6*unit::mm);
```

```
plot::Point2d(1, 3, PointSize = 4)
```

```
plot::Point2d(2, 2, PointSize = 5)
```

```
plot::Point2d(3, 1, PointColor = RGB::Green, PointSize = 6)
```

To have these points displayed, use `plot`:

```
plot(p1, p2, p3)
```

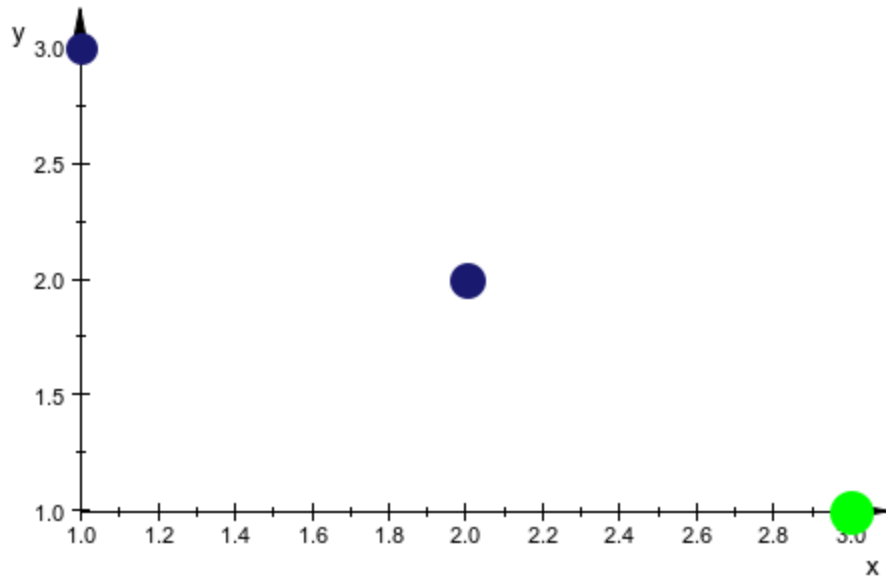

You can set global options directly in the call to `plot`:

```
plot(p1, p2, p3, PointStyle = FilledDiamonds)
```

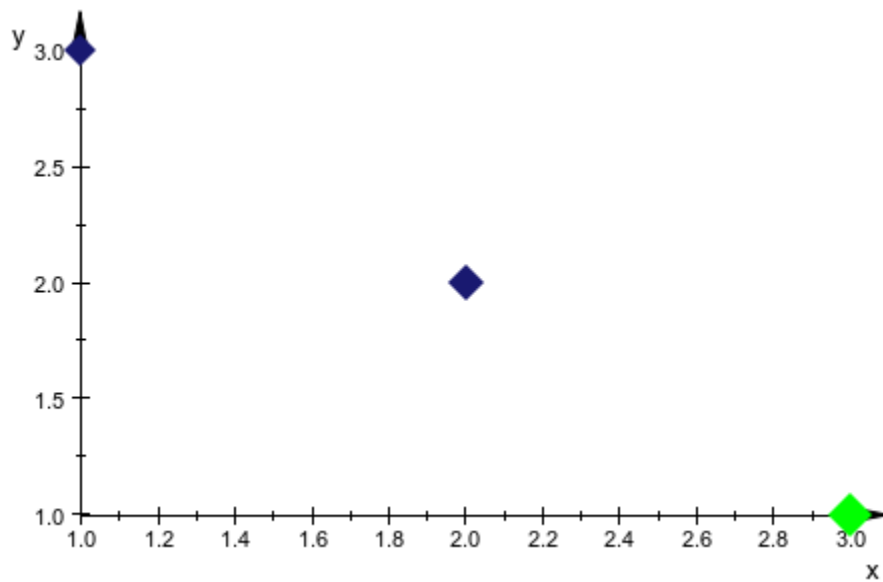

These options are regarded as the new *defaults*. This implies that objects having an option set explicitly will silently ignore these options. The green point stays green:

```
plot(p1, p2, p3, PointStyle = FilledDiamonds,  
     PointColor = RGB::Red)
```

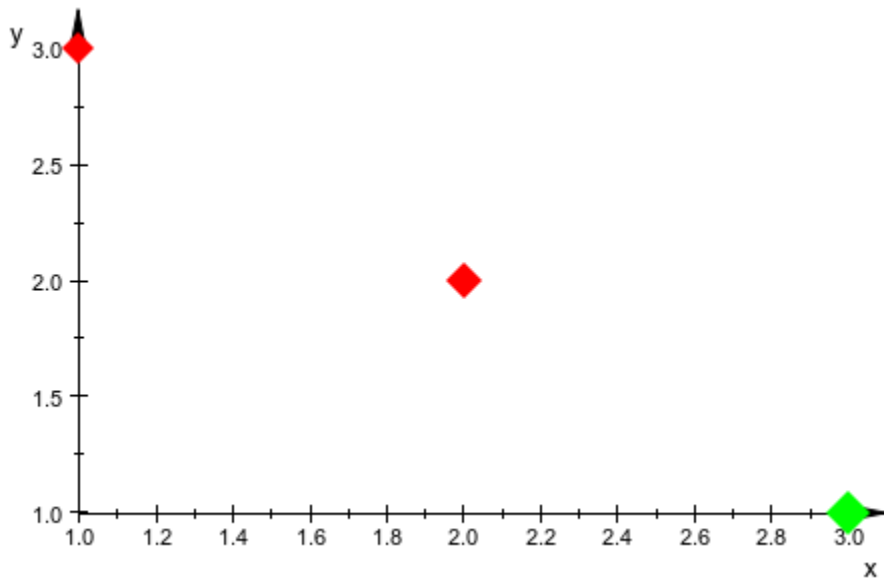

## Example 2

The point position can be animated. As an example, combine a point with a curve that traces the path of the point:

```
x := t -> sin(3*t);
y := t -> cos(5*t);
p := plot::Point2d([x(t), y(t)], t = 0..2*PI);
c := plot::Curve2d([x(t), y(t)], t = 0..tmax, tmax = 0..2*PI)
```

$$t \rightarrow \sin(3 t)$$

$$t \rightarrow \cos(5 t)$$

$$\text{plot}::\text{Point2d}(\sin(3 t), \cos(5 t), t = 0..2 \pi)$$

$$\text{plot}::\text{Curve2d}([\sin(3 t), \cos(5 t)], t = 0..tmax)$$

```
plot(c, p, PointSize = 3*unit::mm, LineWidth = 0.5*unit::mm)
```

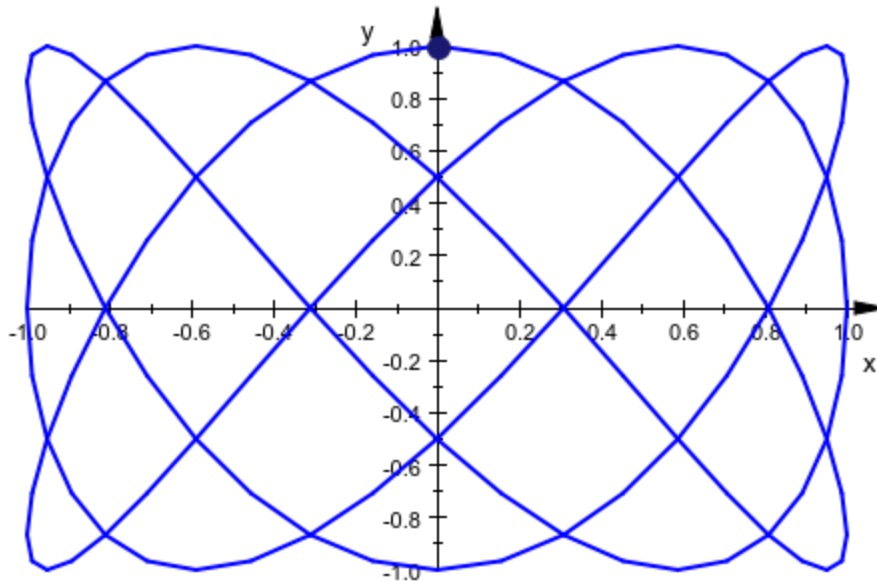

## Parameters

**x, y**

Arithmetical expressions

x, y are equivalent to the attributes Position, PositionX, PositionY.

**a**

Animation parameter, specified as  $a = a_{\min}..a_{\max}$ , where  $a_{\min}$  is the initial parameter value, and  $a_{\max}$  is the final parameter value.

## Algorithms

For reasons of efficiency and clarity in the object browser, avoid generating large numbers of `plot::Point2d` objects. Use `plot::PointList2d` instead.

## See Also

### **MuPAD Functions**

`plot` | `plot::copy`

### **MuPAD Graphical Primitives**

`plot::Point3d` | `plot::Polygon2d` | `plot::Polygon3d`



# plot::Point3d

3D points

## Syntax

```
plot::Point3d(x, y, z, <a = amin .. amax>, options)
```

```
plot::Point3d([x, y, z], <a = amin .. amax>, options)
```

```
plot::Point3d(matrix([x, y, z]), <a = amin .. amax>, options)
```

## Description

`plot::Point3d(x, y, z)` creates a three-dimensional point with the coordinates  $(x, y, z)$ . You also can specify the point by a list  $[x, y, z]$  or a vector `matrix([x, y, z])` of its coordinates.

## Attributes

Attribute	Purpose	Default Value
AffectViewingBox	influence of objects on the ViewingBox of a scene	TRUE
Color	the main color	RGB::MidnightBlue
Frames	the number of frames in an animation	50
Legend	makes a legend entry	
LegendText	short explanatory text for legend	
LegendEntry	add this object to the legend?	FALSE

Attribute	Purpose	Default Value
Name	the name of a plot object (for browser and legend)	
ParameterEnd	end value of the animation parameter	
ParameterName	name of the animation parameter	
ParameterBegin	initial value of the animation parameter	
ParameterRange	range of the animation parameter	
PointSize	the size of points	1.5
PointColor	the color of points	RGB::MidnightBlue
PointStyle	the presentation style of points	FilledCircles
Position	positions of cameras, lights, and text objects	[0, 0, 0]
PositionX	x-positions of cameras, lights, and text objects	0
PositionY	y-positions of cameras, lights, and text objects	0
PositionZ	z-positions of cameras, lights, and text objects	0
TimeEnd	end time of the animation	10.0
TimeBegin	start time of the animation	0.0
TimeRange	the real time span of an animation	0.0 .. 10.0
Title	object title	
TitleFont	font of object titles	[" sans-serif ", 11]
TitlePosition	position of object titles	
TitleAlignment	horizontal alignment of titles w.r.t. their coordinates	Center

Attribute	Purpose	Default Value
TitlePositionX	position of object titles, x component	
TitlePositionY	position of object titles, y component	
TitlePositionZ	position of object titles, z component	
Visible	visibility	TRUE
VisibleAfter	object visible after this time value	
VisibleBefore	object visible until this time value	
VisibleFromTo	object visible during this time range	
VisibleAfterEnd	object visible after its animation time ended?	TRUE
VisibleBeforeBegin	object visible before its animation time starts?	TRUE

## Examples

### Example 1

Create three points:

```
p1 := plot::Point3d(1,3,1, PointSize = 4*unit::mm);
p2 := plot::Point3d(2,2,2, PointSize = 5*unit::mm);
p3 := plot::Point3d(3,1,3, Color = RGB::Green,
                    PointSize = 6*unit::mm);
```

```
plot::Point3d(1, 3, 1, PointSize = 4)
```

```
plot::Point3d(2, 2, 2, PointSize = 5)
```

```
plot::Point3d(3, 1, 3, PointColor = RGB::Green, PointSize = 6)
```

To have these points displayed, use plot:

```
plot(p1, p2, p3)
```

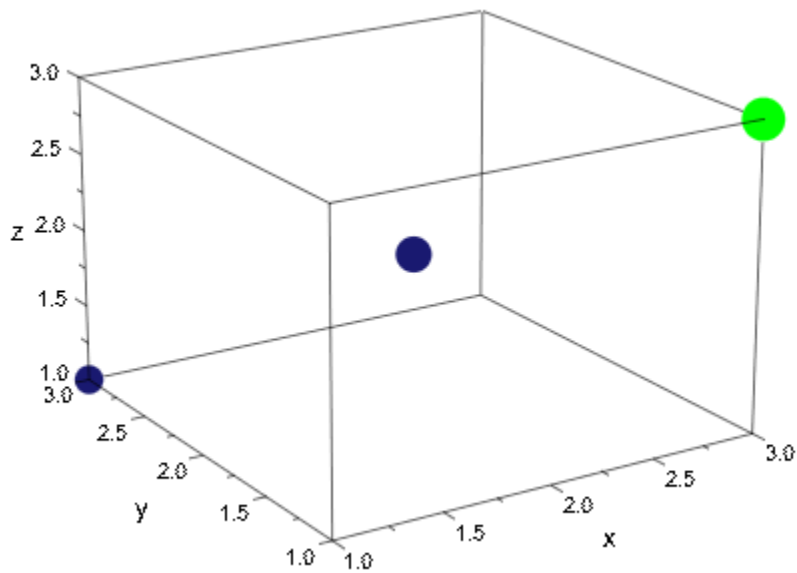

You can set global options directly in the call to plot:

```
plot(p1, p2, p3, PointStyle = FilledSquares)
```

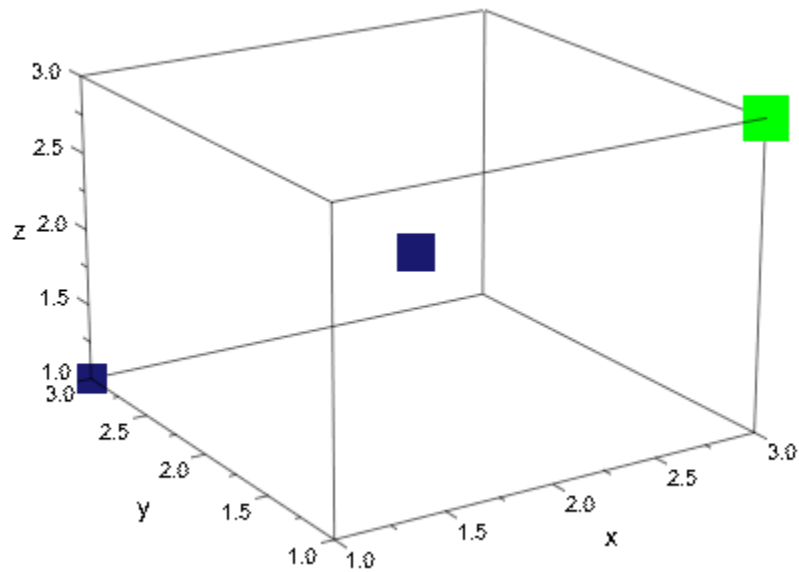

These options are regarded as the new *defaults*. This implies that objects having an option set explicitly will silently ignore these options. The green point stays green:

```
plot(p1, p2, p3, PointStyle = FilledSquares,  
      PointColor = RGB::Red)
```

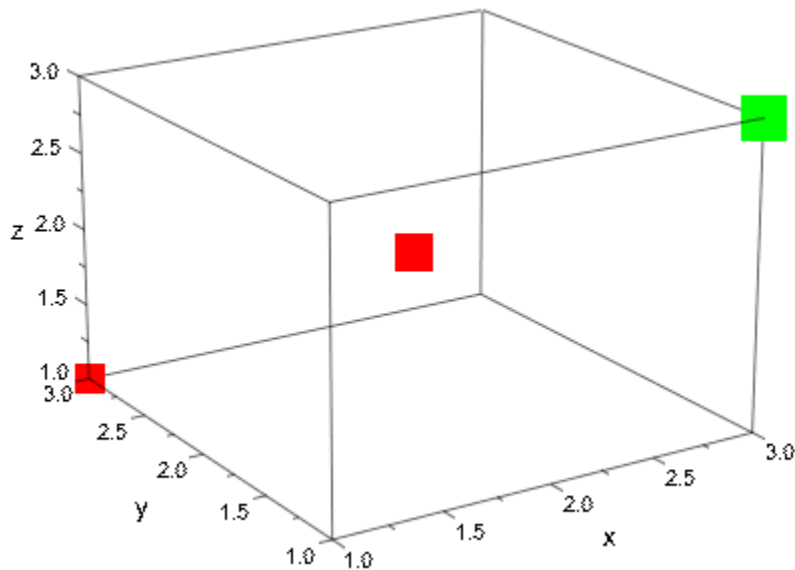

## Parameters

**x, y, z**

Arithmetical expressions

x, y, z are equivalent to the attributes `Position`, `PositionX`, `PositionY`, `PositionZ`.

**a**

Animation parameter, specified as  $a = a_{\min} \dots a_{\max}$ , where  $a_{\min}$  is the initial parameter value, and  $a_{\max}$  is the final parameter value.

## Algorithms

For reasons of efficiency and clarity in the object browser, avoid generating large numbers of `plot::Point3d` objects. Use `plot::PointList3d` instead.

## See Also

### **MuPAD Functions**

plot | plot::copy

### **MuPAD Graphical Primitives**

plot::Point2d | plot::Polygon2d | plot::Polygon3d

## plot::PointList2d

Finite lists of 2D points

### Syntax

```
plot::PointList2d(pts, <a = amin .. amax>, options)
```

```
plot::PointList2d(M2d, <a = amin .. amax>, options)
```

### Description

`plot::PointList2d` holds lists of points in 2D.

This is a container for a large finite number of points. It lets you avoid constructing large numbers of objects of type `plot::Point2d` for two reasons. First, the point types have non-negligible overhead and constructing and plotting a large number of them (say, five thousand) takes more time than plotting the same number of points in a single container object. Second, having five thousand points in the object browser takes a significant amount of memory and is not as lucid as having a single point list.

The attribute `Points2d` is displayed in the inspector (Symbolic Math Toolbox) in the user interface only for short lists.

`plot::PointList2d` internally uses lists for storing the points. It is therefore not recommended to add a large number of points one-by-one. See “Example 1” on page 24-602 (Symbolic Math Toolbox) for a better method of collecting data.

If you specify the color of one point, you must specify the colors of all other points in the list. See “Example 2” on page 24-604 (Symbolic Math Toolbox).



## Attributes

Attribute	Purpose	Default Value
AffectViewingBox	influence of objects on the ViewingBox of a scene	TRUE
AntiAliased	antialiased lines and points?	TRUE
Color	the main color	RGB::MidnightBlue
Frames	the number of frames in an animation	50
Legend	makes a legend entry	
LegendText	short explanatory text for legend	
LegendEntry	add this object to the legend?	FALSE
Name	the name of a plot object (for browser and legend)	
ParameterEnd	end value of the animation parameter	
ParameterName	name of the animation parameter	
ParameterBegin	initial value of the animation parameter	
ParameterRange	range of the animation parameter	
Points2d	list of 2D points	
PointSize	the size of points	1.5
PointColor	the color of points	RGB::MidnightBlue
PointStyle	the presentation style of points	FilledCircles
TimeEnd	end time of the animation	10.0
TimeBegin	start time of the animation	0.0

Attribute	Purpose	Default Value
TimeRange	the real time span of an animation	0.0 .. 10.0
Title	object title	
TitleFont	font of object titles	[" sans-serif ", 11]
TitlePosition	position of object titles	
TitleAlignment	horizontal alignment of titles w.r.t. their coordinates	Center
TitlePositionX	position of object titles, x component	
TitlePositionY	position of object titles, y component	
Visible	visibility	TRUE
VisibleAfter	object visible after this time value	
VisibleBefore	object visible until this time value	
VisibleFromTo	object visible during this time range	
VisibleAfterEnd	object visible after its animation time ended?	TRUE
VisibleBeforeBegin	object visible before its animation time starts?	TRUE

## Examples

### Example 1

The following iteration leads to the so-called Hénon attractor (from chaos theory):

```

c1 := 1.4:
c2 := 0.3:
henon_iter := (x, y) -> [c1*x^2+y-1, c2*x]:

```

Start at  $(0, 0)$ , let hundred iteration cycles pass by (to only plot the attractor), and then collect the next three thousand points:

```
[x, y] := [0, 0]:  
for i from 1 to 100 do  
  [x, y] := henon_iter(x, y);  
end_for:  
data := {}:  
for i from 1 to 3000 do  
  [x, y] := henon_iter(x, y);  
  data := data union {[x, y]};  
end_for:
```

In this example, you collect the data in a set on page 7-50, because adding elements to a set is a fast operation, unlike changing the length of a list, and you don't have to care for the order in which points were reached. To plot the data, convert it to a list first:

```
data := coerce(data, DOM_LIST):  
plot(plot::PointList2d(data))
```

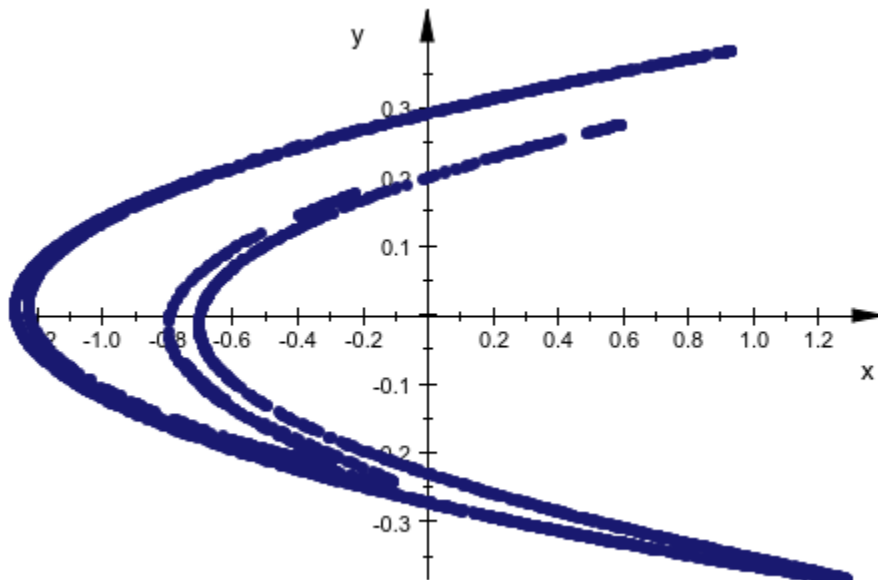

## Example 2

`plot::PointList2d` lets you specify the colors of the points. For example, the following list contains two points. When you plot this list, the first point appears in red, and the second point appears in green:

```
Coords := [[3, 4, RGB::Red], [5, 5, RGB::Green]];
plotCoords := plot::PointList2d(Coords);
plot(plotCoords, PointSize=5)
```

```
[[3, 4, [1.0, 0.0, 0.0]], [5, 5, [0.0, 1.0, 0.0]]]
```

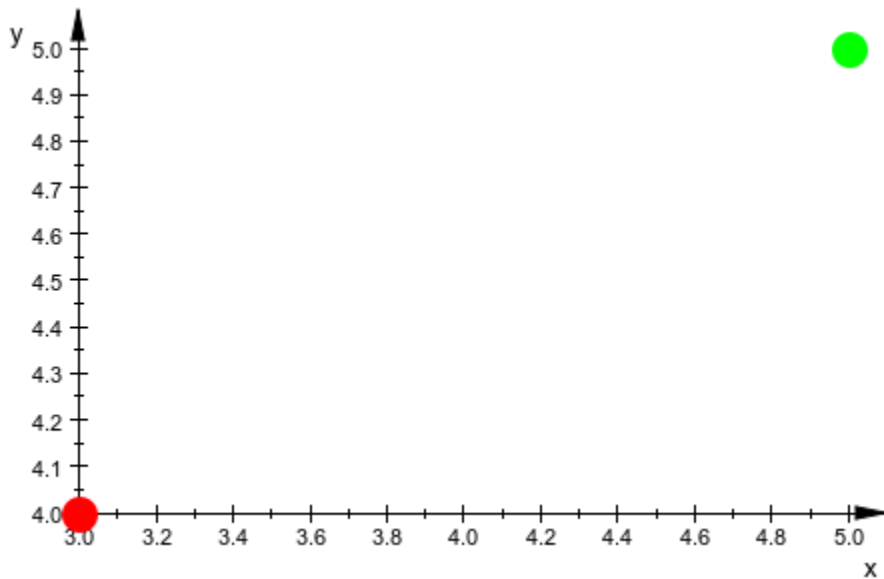

If you specify the color of one point, you must also specify the colors of all other points in the list:

```
Coords := [[3, 4, RGB::Red], [5, 5]];
plotCoords := plot::PointList2d(Coords)
```

```
[[3, 4, [1.0, 0.0, 0.0]], [5, 5]]
```

Error: Attribute 'Points2d' in the 'PointList2d' object must be a list of lists of two

### Example 3

(Feigenbaum's period doubling route to chaos)

Consider the iteration  $x_{n+1} = f_p(x_n)$  where  $f_p: x \rightarrow px(1-x)$  is the “logistic map” with a parameter  $p$ . The iteration map  $f_p$  maps the interval  $[0, 1]$  to itself for  $0 \leq p \leq 4$ . For small values of  $p$ , the sequence  $(x_n)$  has a finite number of accumulation points that are visited cyclically. Increasing  $p$ , the accumulation points split into 2 separate accumulation points for certain critical values of  $p$  (“period doubling”). For  $p \approx 3.569945672\dots$ , there are infinitely many accumulation points and the sequence  $(x_n)$  behaves chaotically.

Visualize the accumulation points as functions of  $p$  (“Feigenbaum diagram”).

For  $P$  closely spaced values of  $p$ , construct the sequence  $(x_n)$  starting with  $x_0 = 0.5$ . Ignore the first  $N$  values, expecting that the next  $M$  values cycle over the accumulation points. These points are added to a list `plotdata` that is finally fed into a `PointList2d` for plotting:

```
f:= (p, x) -> p*x*(1-x):

P:= 500: // number of steps in p direction
N:= 200: // transitional steps before we are close to the cycle
M:= 300: // maximal number of points on the cycle

pmin:= 2.8: // Consider p between
pmax:= 4.0: // pmin and pmax
plotdata:= [ ]:
for p in [pmin + i*(pmax - pmin)/P $ i = 0..P] do
  // First, do N iterations to drive the
  // point x towards the limit cycle
  x:= 0.5:
  for i from 1 to N do
    x:= f(p, x):
  end_for:

  // consider the next M iterates and use them as plot data:
  xSequence:= table():
  xSequence[1]:= x:
  for i from 2 to M do
```

```

x:= f(p, x):
if abs(x - xSequence[1]) < 10^(-5) then
  // We are back at the beginning of the cycle;
  // the points will repeat. Go to the next p.
  break;
else
  xSequence[i]:= x;
end_if;
end_for:
plotdata:= plotdata . [[p, rhs(x)] $ x in xSequence];
end_for:

plot(plot::PointList2d(plotdata,
  PointColor = RGB::Black,
  PointSize = 0.5*unit::mm)):

```

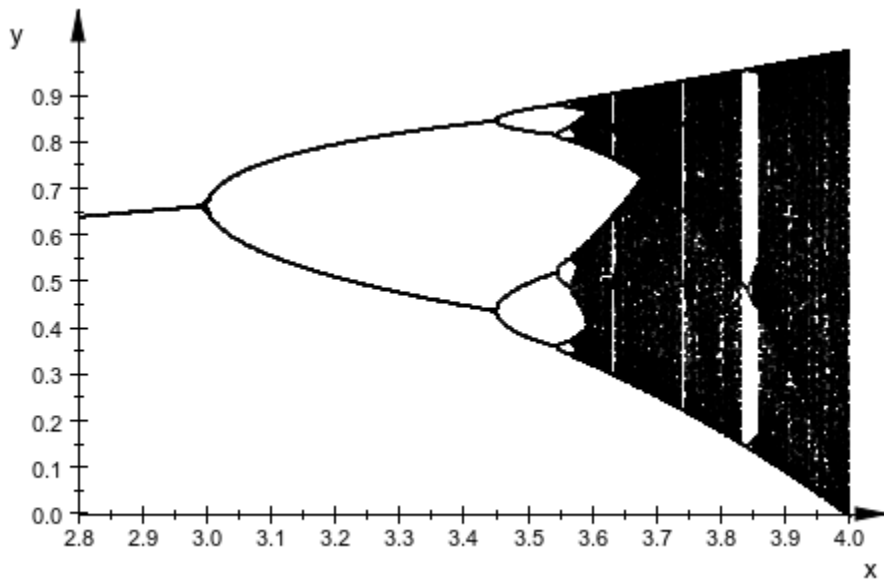

```
delete f, P, N, M, pmin, pmax, plotdata, x, xSequence, i;
```

#### Example 4

Create the following number spiral by plotting only prime numbers. This plot shows that primes cluster along particular curves called prime-generating curves.

```
plot(  
  plot::PointList2d([[sqrt(n)*cos(2*PI*sqrt(n)),  
                    sqrt(n)*sin(2*PI*sqrt(n))]  
    $ n in [ithprime(j) $ j = 1..2345]],  
    PointSize = 1  
),  
  Axes = None, Scaling = Constrained,  
  Height = 100, Width = 100)
```



## Parameters

### pts

A list of points. A point must not be of type `plot::Point2d`. Each point must be a list of two real-valued expressions (the coordinates) and an optional RGB (Symbolic Math

Toolbox) color. The lists specifying the points and the colors must all have the same length.

`pts` is equivalent to the attributes `Points2d`.

**`M2d`**

An array on page 7-2 or a matrix on page 1-1340 with two columns. Each row provides the coordinates of one point.

`M2d` is equivalent to the attribute `Points2d`.

**`a`**

Animation parameter, specified as `a = amin..amax`, where `amin` is the initial parameter value, and `amax` is the final parameter value.

## See Also

### **MuPAD Functions**

`plot` | `plot::copy`

### **MuPAD Graphical Primitives**

`plot::Listplot` | `plot::Point2d` | `plot::Point3d` | `plot::PointList3d` |  
`plot::Polygon2d` | `plot::Polygon3d` | `plot::Scatterplot`



# plot::PointList3d

Finite lists of 3D points

## Syntax

```
plot::PointList3d(pts, <a = amin .. amax>, options)
```

```
plot::PointList3d(M3d, <a = amin .. amax>, options)
```

## Description

`plot::PointList3d` holds lists of points in 3D.

This is a container for a large finite number of points. It lets you avoid constructing large numbers of objects of type `plot::Point3d`, for two reasons. First, the point types have non-negligible overhead and constructing and plotting a large number of them (say, five thousand) takes more time than plotting the same number of points in a single container object. Second, having five thousand points in the object browser takes a significant amount of memory and is not as lucid as having a single point list.

The attribute `Points3d` is displayed in the inspector (Symbolic Math Toolbox) in the user interface only for short lists.

`plot::PointList3d` internally uses lists for storing the points. It is therefore not recommended to add a large number of points one-by-one.

If you specify the color of one point, you must specify the colors of all other points in the list. See “Example 2” on page 24-615 (Symbolic Math Toolbox).

## Attributes

Attribute	Purpose	Default Value
<code>AffectViewingBox</code>	influence of objects on the <code>ViewingBox</code> of a scene	TRUE

<b>Attribute</b>	<b>Purpose</b>	<b>Default Value</b>
Color	the main color	RGB::MidnightBlue
Frames	the number of frames in an animation	50
Legend	makes a legend entry	
LegendText	short explanatory text for legend	
LegendEntry	add this object to the legend?	FALSE
Name	the name of a plot object (for browser and legend)	
ParameterEnd	end value of the animation parameter	
ParameterName	name of the animation parameter	
ParameterBegin	initial value of the animation parameter	
ParameterRange	range of the animation parameter	
Points3d	list of 3D points	
PointSize	the size of points	1.5
PointColor	the color of points	RGB::MidnightBlue
PointStyle	the presentation style of points	FilledCircles
TimeEnd	end time of the animation	10.0
TimeBegin	start time of the animation	0.0
TimeRange	the real time span of an animation	0.0 .. 10.0
Title	object title	
TitleFont	font of object titles	[" sans-serif ", 11]
TitlePosition	position of object titles	

Attribute	Purpose	Default Value
TitleAlignment	horizontal alignment of titles w.r.t. their coordinates	Center
TitlePositionX	position of object titles, x component	
TitlePositionY	position of object titles, y component	
TitlePositionZ	position of object titles, z component	
Visible	visibility	TRUE
VisibleAfter	object visible after this time value	
VisibleBefore	object visible until this time value	
VisibleFromTo	object visible during this time range	
VisibleAfterEnd	object visible after its animation time ended?	TRUE
VisibleBeforeBegin	object visible before its animation time starts?	TRUE

## Examples

### Example 1

plot::PointList3d provides a basic form of scatter plot:

```
plot(plot::PointList3d([[1,1,1], [1,2,2], [1,3,2], [1,3,4],
                       [2,1,1], [2,2,3], [2,3.5, 4]],
      PointSize=5))
```

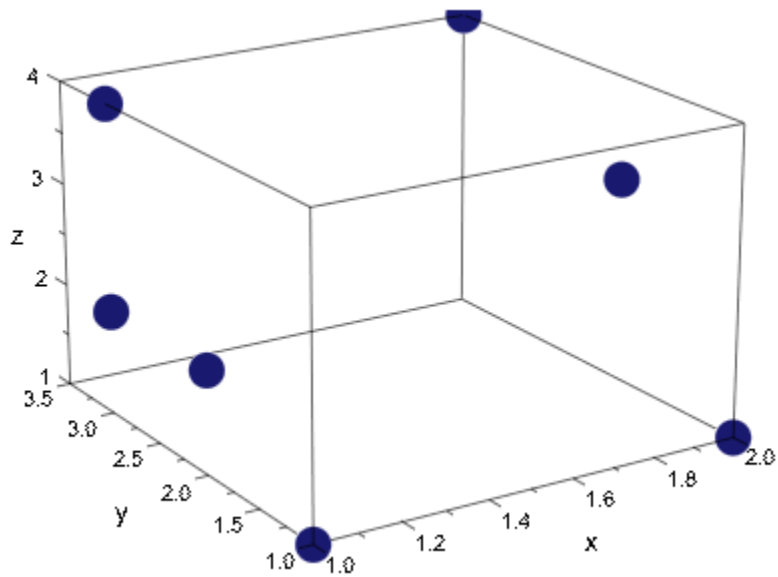

We can use this, for example, to get a visual test of random number generators:

```
r := frandom(0):  
plot(plot::PointList3d([[r(), r(), r()] $ i=1..10000)):
```

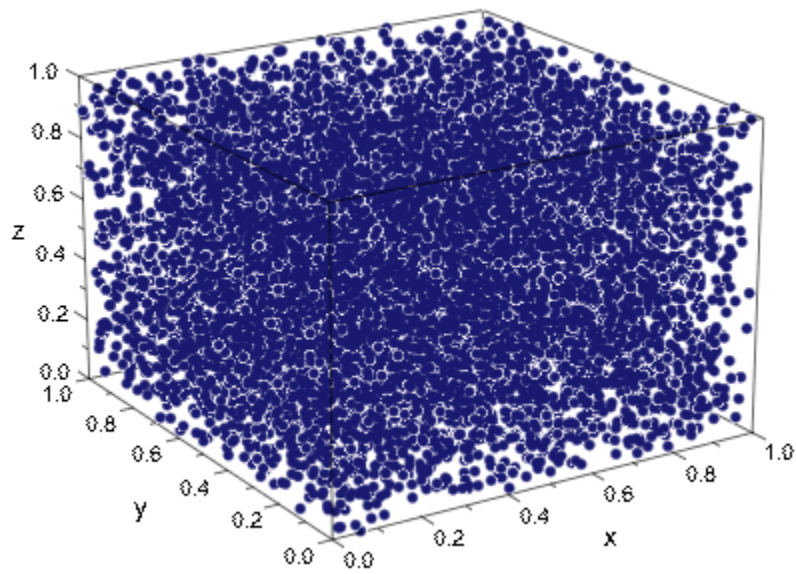

```
r := random(10^10)*1e-10:  
plot(plot::PointList3d([[r(), r(), r()] $ i=1..10000])):
```

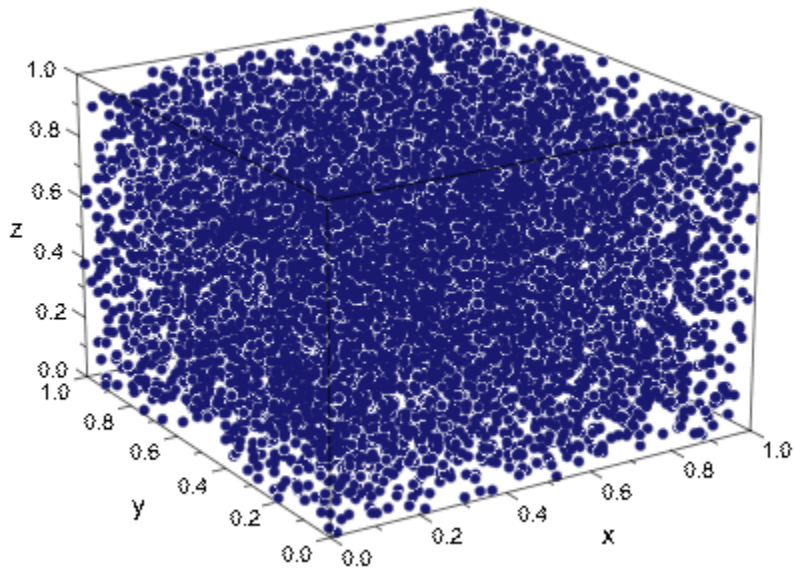

`random` and `random` fill the cube nicely, without noticeable patterns. The following generator, however, should probably not be used:

```
randseed := 12345:  
r := proc()  
begin  
    randseed := (randseed * 17 + 8) mod 10^10:  
    1e-10 * randseed;  
end:  
plot(plot::PointList3d([[r(), r(), r()] $ i=1..10000))):
```

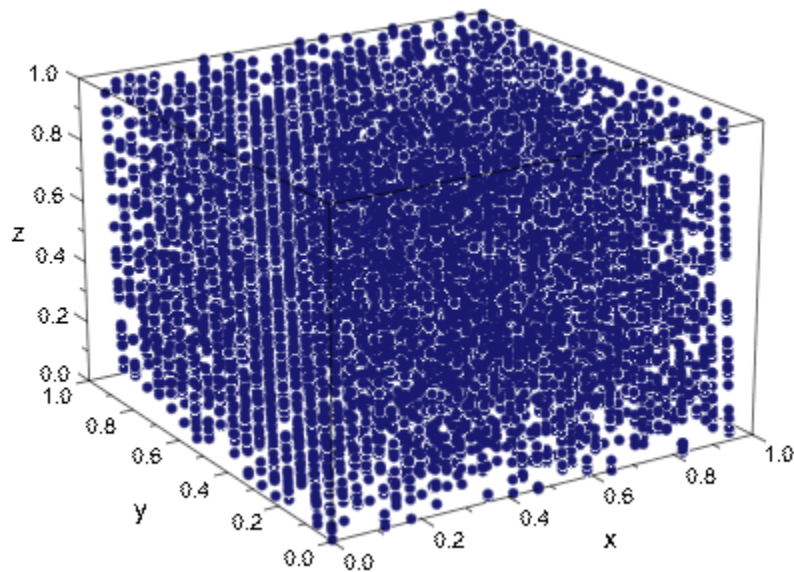

## Example 2

`plot::PointList3d` lets you specify the colors of the points. For example, the following list contains three points. When you plot this list, the first point appears in red, and the second point appears in green, and the third point appears in blue:

```
plot(plot::PointList3d([[1,1,1,RGB::Red],  
                        [2,2,2,RGB::Green],  
                        [1,3,3,RGB::Blue]],  
      PointSize=5))
```

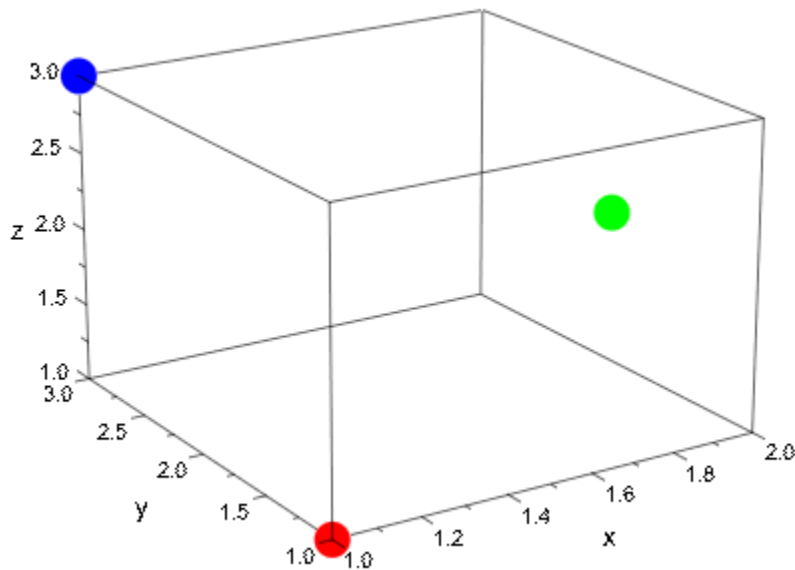

If you specify the color of one point, you must also specify the colors of all other points in the list:

```
plot(plot::PointList3d([[1,1,1,RGB::Red],
                       [2,2,2],
                       [1,3,3]],
     PointSize=5))
```

Error: Attribute 'Points3d' in the 'PointList3d' object must be a list of lists of three

## Parameters

### pts

A list of points. A point must not be of type `plot::Point3d`. Each point must be a list of three expressions (the coordinates) and an optional RGB (Symbolic Math Toolbox) or RGBA (Symbolic Math Toolbox) color. The lists specifying the points and the colors must all have the same length.

`pts` is equivalent to the attributes `Points3d`.



**M<sub>3d</sub>**

An array on page 7-2 or a matrix on page 1-1340 with three columns. Each row provides the coordinates of one point.

M<sub>3d</sub> is equivalent to the attribute Points3d.

**a**

Animation parameter, specified as  $a = a_{\min} .. a_{\max}$ , where  $a_{\min}$  is the initial parameter value, and  $a_{\max}$  is the final parameter value.

## See Also

**MuPAD Functions**

plot | plot::copy

**MuPAD Graphical Primitives**

plot::Listplot | plot::Point2d | plot::Point3d | plot::PointList2d |  
plot::Polygon2d | plot::Polygon3d | plot::Scatterplot

## plot::Polar

Curves in 2D parameterized in polar coordinates

### Syntax

```
plot::Polar([r,  $\phi$ ], u = umin .. umax, <a = amin .. amax>, options)
```

### Description

`plot::Polar` creates parameterized curves in 2D, with parametrization in polar coordinates.

`plot::Polar` creates curves in one parameter, with parametrization in polar coordinates and possibly animated (see “Example 1” on page 24-621 (Symbolic Math Toolbox) and “Example 2” on page 24-625 (Symbolic Math Toolbox)). The curves may contain poles, in which case automatic clipping is used by default, see “Example 4” on page 24-629 (Symbolic Math Toolbox).

Polar coordinates consist of a radius and an angle. The radius of a point is its distance from the origin (0, 0), while the angle is the angle between the positive “x”-axis (the ordinate) and the connection between the point and the origin, measured in radians and counter-clockwise.

By default, curves are sampled at equidistant values of the parameter  $t$ . The attribute `AdaptiveMesh` can be used to change this behavior, such that a denser sampling rate is used in areas of higher curvature. Cf. “Example 3” on page 24-626 (Symbolic Math Toolbox).

Curves are graphical objects that can be manipulated, see the examples and the documentation of the parameters listed below for details.

## Attributes

Attribute	Purpose	Default Value
AdaptiveMesh	adaptive sampling	0
AffectViewingBox	influence of objects on the ViewingBox of a scene	TRUE
AntiAliased	antialiased lines and points?	TRUE
Color	the main color	RGB::Blue
DiscontinuitySearch	semi-symbolic search for discontinuities	TRUE
Frames	the number of frames in an animation	50
Legend	makes a legend entry	
LegendText	short explanatory text for legend	
LegendEntry	add this object to the legend?	TRUE
LineColor	color of lines	RGB::Blue
LineWidth	width of lines	0.35
LineColor2	color of lines	RGB::DeepPink
LineStyle	solid, dashed or dotted lines?	Solid
LinesVisible	visibility of lines	TRUE
LineColorType	line coloring types	Flat
LineColorFunction	functional line coloring	
LineColorDirection	the direction of color transitions on lines	[0, 1]
LineColorDirectionX	x-component of the direction of color transitions on lines	0
LineColorDirectionY	y-component of the direction of color transitions on lines	1

<b>Attribute</b>	<b>Purpose</b>	<b>Default Value</b>
Mesh	number of sample points	121
Name	the name of a plot object (for browser and legend)	
ParameterEnd	end value of the animation parameter	
ParameterName	name of the animation parameter	
ParameterBegin	initial value of the animation parameter	
ParameterRange	range of the animation parameter	
PointSize	the size of points	1.5
PointStyle	the presentation style of points	FilledCircles
PointsVisible	visibility of mesh points	FALSE
Submesh	density of submesh (additional sample points)	0
TimeEnd	end time of the animation	10.0
TimeBegin	start time of the animation	0.0
TimeRange	the real time span of an animation	0.0 .. 10.0
Title	object title	
TitleFont	font of object titles	[" sans-serif ", 11]
TitlePosition	position of object titles	
TitleAlignment	horizontal alignment of titles w.r.t. their coordinates	Center
TitlePositionX	position of object titles, x component	
TitlePositionY	position of object titles, y component	
UMax	final value of parameter "u"	

Attribute	Purpose	Default Value
UMesh	number of sample points for parameter “u”	121
UMin	initial value of parameter “u”	
UName	name of parameter “u”	
URange	range of parameter “u”	
USubmesh	density of additional sample points for parameter “u”	0
Visible	visibility	TRUE
VisibleAfter	object visible after this time value	
VisibleBefore	object visible until this time value	
VisibleFromTo	object visible during this time range	
VisibleAfterEnd	object visible after its animation time ended?	TRUE
VisibleBeforeBegin	object visible before its animation time starts?	TRUE
XFunction	function for x values	
YFunction	function for y values	

## Examples

### Example 1

The most basic example of a curve in polar coordinates is a circle: Using a constant radius, the angle goes from 0 to  $2\pi$ :

```
plot(plot::Polar([1, u], u = 0..2*PI))
```

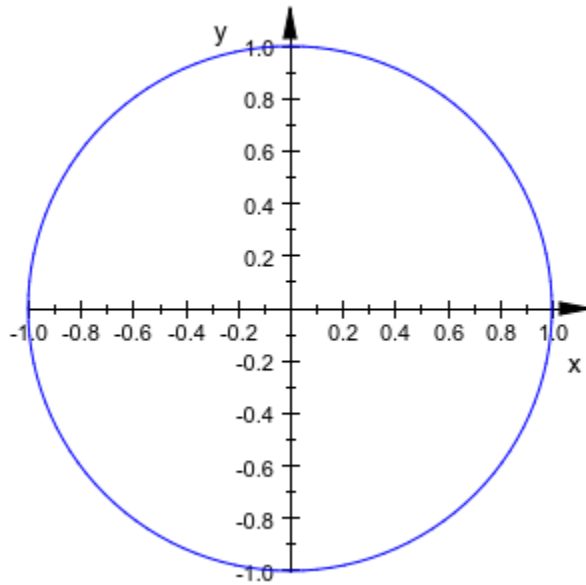

A constant angle, on the other hand, means a straight line through the origin:

```
plot(plot::Polar([r, 1], r = 0..1))
```

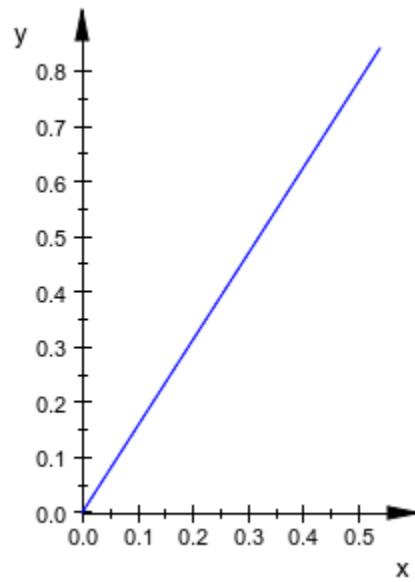

plot::Polar accepts negative radii:

```
plot(plot::Polar([r, 1], r = -1..1))
```

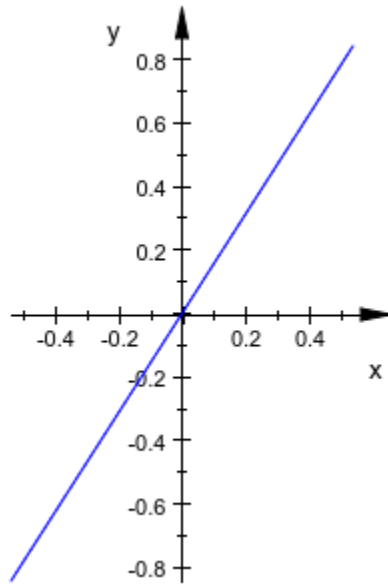

The most simple “interesting” example is probably Archimedes' spiral:

```
plot(plot::Polar([r, r], r = 0..5*PI))
```



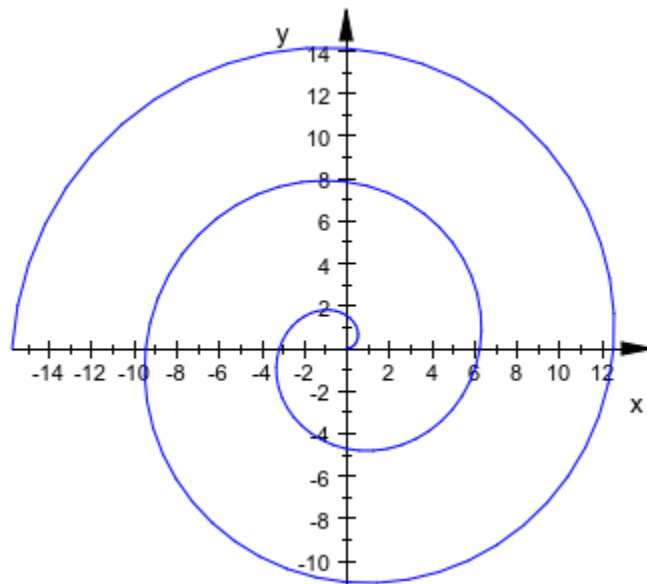

## Example 2

Polar curves can be animated just like almost anything else:

```
plot(plot::Polar([r, a*r], r = 0..5*PI, a = -1..1))
```

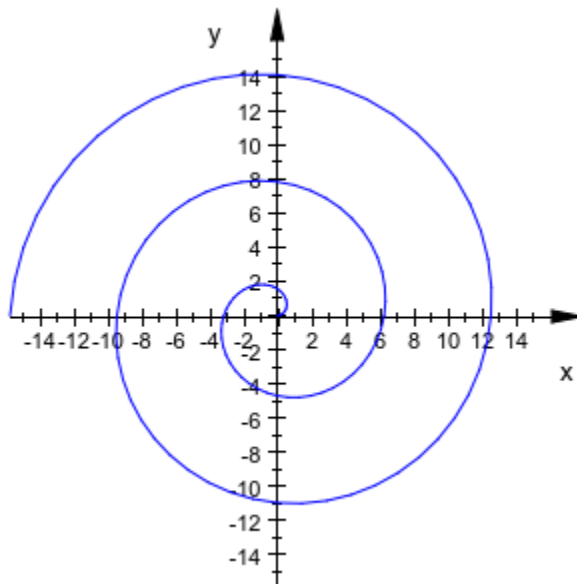

### Example 3

In some cases, the default of 121 evaluations on the curve is not sufficient and causes visible artifacts:

```
plot(plot::Polar([r, 4*r^2], r = 0..PI))
```

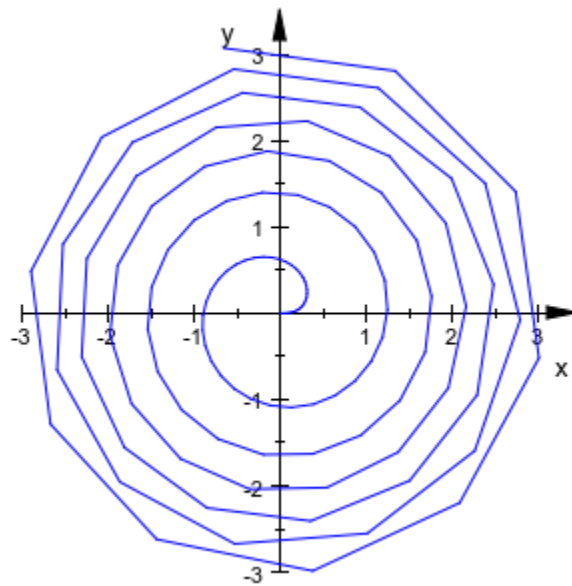

One remedy for this problem is to increase the number of evaluation points:

```
plot(plot::Polar([r, 4*r^2], r = 0..PI, Mesh = 400))
```

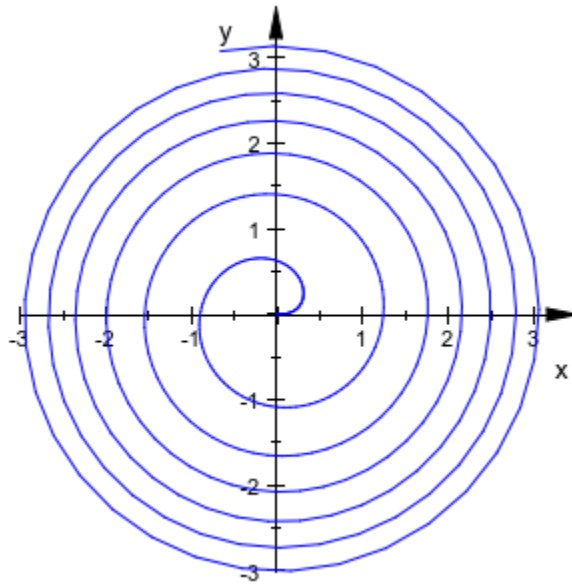

This method is, however, wasteful: Near the center, the initial density was perfectly sufficient, while on the outer edge still more points would be desirable. `plot::Polar` offers adaptive mesh refinement on page 24-1684 for exactly these situations. In the following example, we switch on adaptive mesh refinement with up to  $2^4 = 16$  points introduced between each two consecutive points of the initial mesh:

```
plot(plot::Polar([r, 4*r^2], r = 0..PI, AdaptiveMesh=4))
```

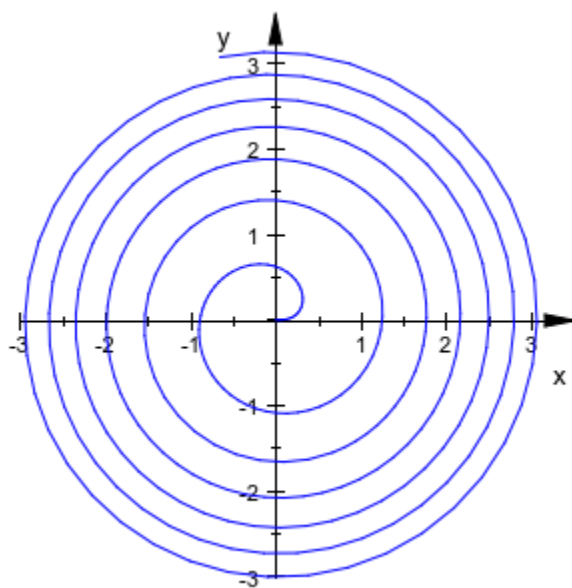

### Example 4

If the curve (i.e., the radius expression/function) contains poles, `plot::Polar` will use heuristics to clip the viewing box:

```
plot(plot::Polar([tan(t)+1, t], t = 0..2*PI))
```

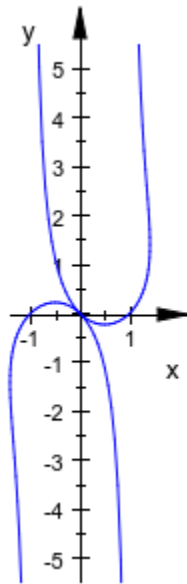

To select a different area, use the attribute `ViewingBox`:

```
plot(plot::Polar([tan(t)+1, t], t = 0..2*PI,  
ViewingBox = [-2..2, -2..2]))
```

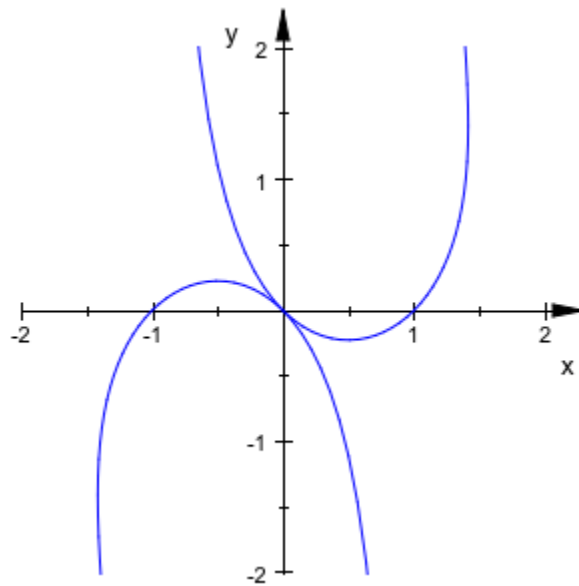

## Example 5

plot::Polar creates objects that can be manipulated interactively and/or programmatically:

```
p := plot::Polar([tan(t)+1, t], t = 0..PI)
```

```
plot::Polar([tan(t) + 1, t], t = 0..π)
```

```
p::UMax := 2*PI:  
p
```

```
plot::Polar([tan(t) + 1, t], t = 0..2 π)
```

```
p::ViewingBox := [-2..2, -2..2]:  
p::LineColor := RGB::Blue:  
p::LineWidth := 1*unit::mm:  
plot(p)
```

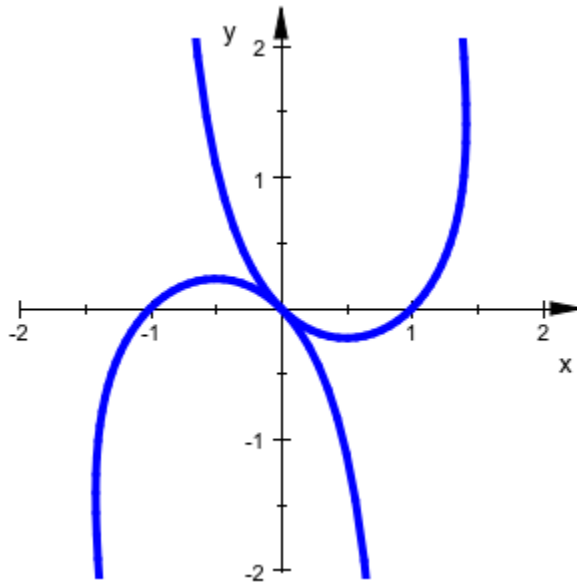

## Parameters

$r, \phi$

The coordinate functions: arithmetical expressions (Symbolic Math Toolbox) or piecewise objects depending on the curve parameter  $u$  and the animation parameter  $a$ . Alternatively, procedures on page 1-1654 that accept 1 input parameter  $u$  or 2 input parameters  $u, a$  and return a real numerical value when the input parameters are numerical.

$r, \phi$  are equivalent to the attributes XFunction, YFunction.

$u$

The curve parameter: an identifier on page 7-29 or an indexed identifier on page 1-1017.

$u$  is equivalent to the attribute UName.



**$u_{\min} .. u_{\max}$**

The plot range for the parameter  $u$ :  $u_{\min}$ ,  $u_{\max}$  must be numerical real values or expressions of the animation parameter  $a$ .

$u_{\min} .. u_{\max}$  is equivalent to the attributes `URange`, `UMin`, `UMax`.

**$a$**

Animation parameter, specified as  $a = a_{\min} .. a_{\max}$ , where  $a_{\min}$  is the initial parameter value, and  $a_{\max}$  is the final parameter value.

## See Also

### MuPAD Functions

`plot` | `plot::copy`

### MuPAD Graphical Primitives

`plot::Curve2d` | `plot::Cylindrical` | `plot::Spherical`

## plot::Polygon2d

2D polygons

### Syntax

```
plot::Polygon2d([pt2d1, pt2d2, ...], <a = amin .. amax>, options)
```

```
plot::Polygon2d(M2d, <a = amin .. amax>, options)
```

### Description

`plot::Polygon2d` defines polygons in 2D by a given list of vertex points. A polygon consists of points and edges. The edges are made up of the lines traversing from the first to the second point, the second to the third point, and so on. The last point is automatically connected with the first point if the attribute `Closed = TRUE` is specified.

Points and lines can be hidden via `PointsVisible = FALSE` and `LinesVisible = FALSE`. By default, the vertex points are hidden, and the edges are visible.

All points as a whole can be manipulated via `PointStyle` and `PointSize`. The attribute `LineColor` sets the color for all points and all lines. Likewise all lines can be manipulated via `LineStyle` and `LineWidth`.

You can vary the color of all lines and points via `LineColorType`. The default value is `Flat`. Specifying the values `Dichromatic` or `Rainbow` lets you set the second color `LineColor2`. With `Functional`, the colors are taken from a custom `LineColorFunction`.

The area of any closed 2D polygon can be filled by specifying `Filled = TRUE`. The filled area is defined by connecting the last and the first vertex. This additional edge itself, however, is only displayed if `Closed = TRUE` is set. A fill color and a fill pattern can be chosen by `FillColor` and `FillPattern`.

In case of a self-intersecting polygon, a `FillStyle` can be selected. See “Example 2” on page 24-639 (Symbolic Math Toolbox).

## Attributes

Attribute	Purpose	Default Value
AffectViewingBox	influence of objects on the ViewingBox of a scene	TRUE
AntiAliased	antialiased lines and points?	TRUE
Closed	open or closed polygons	FALSE
Color	the main color	RGB::Blue
Filled	filled or transparent areas and surfaces	FALSE
FillColor	color of areas and surfaces	RGB::Red
FillStyle	definition of inside/outside	EvenOdd
FillPattern	type of area filling	DiagonalLines
Frames	the number of frames in an animation	50
Legend	makes a legend entry	
LegendText	short explanatory text for legend	
LegendEntry	add this object to the legend?	FALSE
LineColor	color of lines	RGB::Blue
LineWidth	width of lines	0.35
LineColor2	color of lines	RGB::DeepPink
LineStyle	solid, dashed or dotted lines?	Solid
LinesVisible	visibility of lines	TRUE
LineColorType	line coloring types	Flat
LineColorFunction	functional line coloring	
LineColorDirection	the direction of color transitions on lines	[0, 1]

<b>Attribute</b>	<b>Purpose</b>	<b>Default Value</b>
LineColorDirectionX	x-component of the direction of color transitions on lines	0
LineColorDirectionY	y-component of the direction of color transitions on lines	1
Name	the name of a plot object (for browser and legend)	
ParameterEnd	end value of the animation parameter	
ParameterName	name of the animation parameter	
ParameterBegin	initial value of the animation parameter	
ParameterRange	range of the animation parameter	
Points2d	list of 2D points	
PointSize	the size of points	1.5
PointStyle	the presentation style of points	FilledCircles
PointsVisible	visibility of mesh points	FALSE
TimeEnd	end time of the animation	10.0
TimeBegin	start time of the animation	0.0
TimeRange	the real time span of an animation	0.0 .. 10.0
Title	object title	
TitleFont	font of object titles	[" sans-serif ", 11]
TitlePosition	position of object titles	
TitleAlignment	horizontal alignment of titles w.r.t. their coordinates	Center
TitlePositionX	position of object titles, x component	

Attribute	Purpose	Default Value
TitlePositionY	position of object titles, y component	
Visible	visibility	TRUE
VisibleAfter	object visible after this time value	
VisibleBefore	object visible until this time value	
VisibleFromTo	object visible during this time range	
VisibleAfterEnd	object visible after its animation time ended?	TRUE
VisibleBeforeBegin	object visible before its animation time starts?	TRUE

## Examples

### Example 1

Create a polygon with vertices located at the 5 complex 5<sup>th</sup> roots of 1. The polygon consists of the 4 lines joining the 5 points in the order given:

```
p := plot::Polygon2d(
  [[cos(2*PI*k/5), sin(2*PI*k/5)] $ k = 0..4]):
plot(p, plot::Circle2d(1, [0, 0])):
```

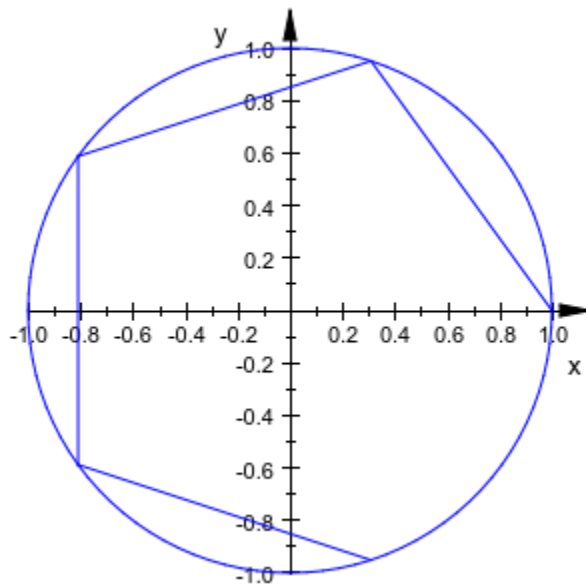

In order to include the line connecting the last with the first point, pass the attribute `Closed` to the polygon:

```
p::Closed := TRUE:  
plot(p, plot::Circle2d(1, [0, 0])):
```

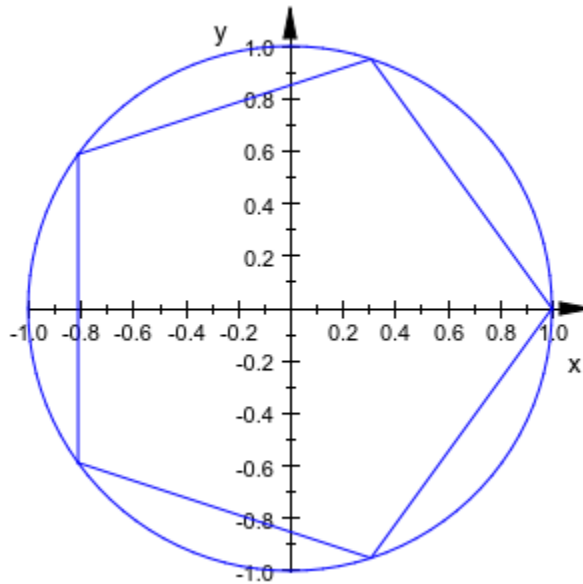

delete p

## Example 2

Plot a closed 2D polygon and fill the area inside. In fact, there are two possible interpretations of what “inside” really means. In the first plot, the complement of the unbound component of the complement of the polygon is filled. In the second plot only that area is filled that contains points with nonzero winding number with respect to the polygon. See `FillStyle` for a detailed discussion.

```
p := plot::Polygon2d(
    [[cos(PI*k/3), sin(PI*k/3)] $k = 1..6,
     [cos(PI*k/3 + PI/6)/2, sin(PI*k/3 + PI/6)/2] $k = 1..6
    ], Closed = TRUE):
S1 := plot::Scene2d(p, Filled = TRUE):
S2 := plot::Scene2d(p, Filled = TRUE, FillStyle = Winding):
plot(S1, S2, Layout = Horizontal, Axes = Frame,
     Scaling = Constrained)
```

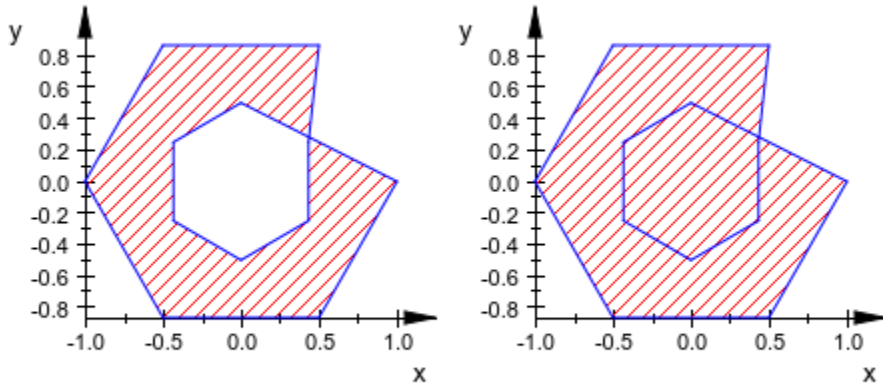

delete p, S1, S2:

## Parameters

**pt2d<sub>1</sub>, pt2d<sub>2</sub>, ...**

The 2D vertices. These must not be of type `plot::Point2d`, but lists of two numerical real values or arithmetical expressions (Symbolic Math Toolbox) of the animation parameter `a` (the coordinates).

pt2d<sub>1</sub>, pt2d<sub>2</sub>, ... is equivalent to the attribute `Points2d`.

**M<sub>2d</sub>**

An array on page 7-2 or a matrix on page 1-1340 with 2 columns. Each row provides the coordinates of one point.

M<sub>2d</sub> is equivalent to the attribute `Points2d`.



**a**

Animation parameter, specified as  $a = a_{\min} .. a_{\max}$ , where  $a_{\min}$  is the initial parameter value, and  $a_{\max}$  is the final parameter value.

## See Also

**MuPAD Functions**

plot | plot::copy

**MuPAD Graphical Primitives**

plot::Line2d | plot::Line3d | plot::Listplot | plot::Polygon3d

## plot::Polygon3d

3D polygons

### Syntax

```
plot::Polygon3d([pt3d1, pt3d2, ...], <a = amin .. amax>, options)
```

```
plot::Polygon3d(M3d, <a = amin .. amax>, options)
```

### Description

`plot::Polygon3d` defines polygons in 3D by a given list of vertex points. A polygon consists of points and edges. The edges are made up of the lines traversing from the first to the second point, the second to the third point, and so on. The last point is automatically connected with the first point if the attribute `Closed = TRUE` is specified.

Points and lines can be hidden via `PointsVisible = FALSE` and `LinesVisible = FALSE`. By default, the vertex points are hidden, and the edges are visible.

All points as a whole can be manipulated via `PointSize` and `PointStyle`. The attribute `LineColor` sets the color for all points and all lines. Likewise all lines can be manipulated via `LineStyle` and `LineWidth`.

You can vary the color of all lines and points via `LineColorType`. The default value is `Flat`. Specifying the values `Dichromatic` or `Rainbow` lets you set the second color `LineColor2`. With `Functional`, the colors are taken from a custom `LineColorFunction`. See “Example 2” on page 24-645 (Symbolic Math Toolbox).

A 3D polygon can only be filled if it is defined by three vertices (a triangle). The attribute `Filled = TRUE` is ignored for other 3D polygons.

## Attributes

Attribute	Purpose	Default Value
AffectViewingBox	influence of objects on the ViewingBox of a scene	TRUE
Closed	open or closed polygons	FALSE
Color	the main color	RGB::Blue
Filled	filled or transparent areas and surfaces	FALSE
FillColor	color of areas and surfaces	RGB::LightBlue
Frames	the number of frames in an animation	50
Legend	makes a legend entry	
LegendText	short explanatory text for legend	
LegendEntry	add this object to the legend?	FALSE
LineColor	color of lines	RGB::Blue
LineWidth	width of lines	0.35
LineColor2	color of lines	RGB::DeepPink
LineStyle	solid, dashed or dotted lines?	Solid
LinesVisible	visibility of lines	TRUE
LineColorType	line coloring types	Flat
LineColorFunction	functional line coloring	
LineColorDirection	the direction of color transitions on lines	[0, 0, 1]
LineColorDirectionX	x-component of the direction of color transitions on lines	0
LineColorDirectionY	y-component of the direction of color transitions on lines	0

<b>Attribute</b>	<b>Purpose</b>	<b>Default Value</b>
LineColorDirectionZ	z-component of the direction of color transitions on lines	1
Name	the name of a plot object (for browser and legend)	
ParameterEnd	end value of the animation parameter	
ParameterName	name of the animation parameter	
ParameterBegin	initial value of the animation parameter	
ParameterRange	range of the animation parameter	
Points3d	list of 3D points	
PointSize	the size of points	1.5
PointStyle	the presentation style of points	FilledCircles
PointsVisible	visibility of mesh points	FALSE
TimeEnd	end time of the animation	10.0
TimeBegin	start time of the animation	0.0
TimeRange	the real time span of an animation	0.0 .. 10.0
Title	object title	
TitleFont	font of object titles	[" sans-serif ", 11]
TitlePosition	position of object titles	
TitleAlignment	horizontal alignment of titles w.r.t. their coordinates	Center
TitlePositionX	position of object titles, x component	
TitlePositionY	position of object titles, y component	

Attribute	Purpose	Default Value
TitlePositionZ	position of object titles, z component	
Visible	visibility	TRUE
VisibleAfter	object visible after this time value	
VisibleBefore	object visible until this time value	
VisibleFromTo	object visible during this time range	
VisibleAfterEnd	object visible after its animation time ended?	TRUE
VisibleBeforeBegin	object visible before its animation time starts?	TRUE

## Examples

### Example 2

Plot a closed star-shaped 3D polygon with various color attributes:

```

p := plot::Polygon3d(
  [[cos(PI*k/3), sin(PI*k/3), sin(PI*k/3)],
   [cos(PI*k/3 + PI/6)/2,
    sin(PI*k/3 + PI/6)/2,
    sin(PI*k/3 + PI/6)/2]) $k = 1..6
], Closed = TRUE):
S1 := plot::Scene3d(p, LineColorType = Flat):
S2 := plot::Scene3d(p, LineColorType = Dichromatic):
S3 := plot::Scene3d(p, LineColorType = Dichromatic,
  LineColor = RGB::Blue,
  LineColor2 = RGB::Green):
S4 := plot::Scene3d(p, LineColorType = Rainbow,
  LineColor = RGB::Blue,
  LineColor2 = RGB::Green):
plot(S1, S2, S3, S4)

```

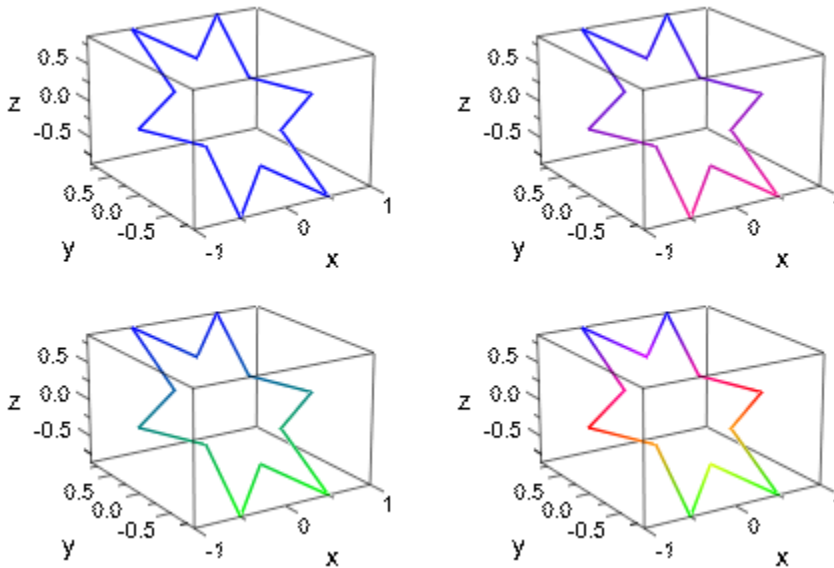

Plot the same polygon while animating its line color using a color function on page 24-785 (Symbolic Math Toolbox). The result is a dazzling star:

```
p := plot::Polygon3d(
    [[cos(PI*k/3), sin(PI*k/3), sin(PI*k/3)],
     [cos(PI*k/3 + PI/6)/2,
      sin(PI*k/3 + PI/6)/2,
      sin(PI*k/3 + PI/6)/2]] $k = 1..6
    ], Closed = TRUE,
    LineColorFunction =
        proc(x, y, z, i, a) begin
            [sin(x + a*i)^2, sin(y + a*i)^2, sin(z + a*i)^2]:
        end_proc,
    a = 0..10):
plot(p)
```

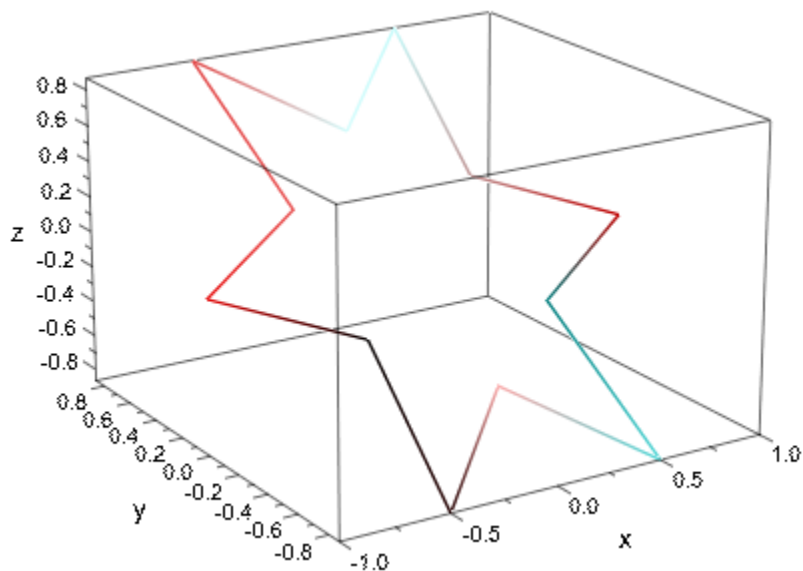

delete p, S1, S2, S3, S4

## Parameters

**pt3d<sub>1</sub>, pt3d<sub>2</sub>, ...**

The 3D vertices. These must not be of type `plot::Point3d`, but lists of three numerical real values or arithmetical expressions (Symbolic Math Toolbox) of the animation parameter `a` (the coordinates).

`pt3d1, pt3d2, ...` is equivalent to the attribute `Points3d`.

**M<sub>3d</sub>**

An array on page 7-2 or a matrix on page 1-1340 with 3 columns. Each row provides the coordinates of one point.

`M3d` is equivalent to the attribute `Points3d`.

**a**

Animation parameter, specified as  $a = a_{\min} .. a_{\max}$ , where  $a_{\min}$  is the initial parameter value, and  $a_{\max}$  is the final parameter value.

## See Also

### MuPAD Functions

`plot` | `plot::copy`

### MuPAD Graphical Primitives

`plot::Line2d` | `plot::Line3d` | `plot::Listplot` | `plot::Polygon2d`



# plot::Prism

Prisms

## Syntax

```
plot::Prism(r, [x1, y1, z1], [x2, y2, z2], <a = amin .. amax>, options)
```

## Description

`plot::Prism(r, [x1, y1, z1], [x2, y2, z2])` creates a prism with a regular base plane with a circumcircle of radius  $r$  and an axis from the point  $[x_1, y_1, z_1]$  to the point  $[x_2, y_2, z_2]$ .

The base center and top center of the prism can also be passed as vectors.

Note that only prisms with a regular base can be created with `plot::Prism`. For other bases, use a `plot::SurfaceSet` primitive.

## Attributes

Attribute	Purpose	Default Value
AffectViewingBox	influence of objects on the ViewingBox of a scene	TRUE
Angle	rotation angle	0
Base	base center of cones, cylinders, pyramids and prisms	[0, 0, 0]
BaseX	x-coordinate of top center of cones, cylinders, pyramids and prisms	0

<b>Attribute</b>	<b>Purpose</b>	<b>Default Value</b>
BaseY	y-coordinate of top center of cones, cylinders, pyramids and prisms	0
BaseZ	z-coordinate of top center of cones, cylinders, pyramids and prisms	0
Color	the main color	RGB::Red
Edges	Number of Edges	3
Filled	filled or transparent areas and surfaces	TRUE
FillColor	color of areas and surfaces	RGB::Red
FillColor2	second color of areas and surfaces for color blends	RGB::CornflowerBlue
FillColorType	surface filling types	Dichromatic
FillColorFunction	functional area/surface coloring	
FillColorDirection	the direction of color transitions on surfaces	[0, 0, 1]
FillColorDirectionX	x-component of the direction of color transitions on surfaces	0
FillColorDirectionY	y-component of the direction of color transitions on surfaces	0
FillColorDirectionZ	z-component of the direction of color transitions on surfaces	1
Frames	the number of frames in an animation	50
Legend	makes a legend entry	
LegendText	short explanatory text for legend	

Attribute	Purpose	Default Value
LegendEntry	add this object to the legend?	FALSE
LineColor	color of lines	RGB::Black.[0.25]
LineWidth	width of lines	0.35
LineColor2	color of lines	RGB::DeepPink
LineStyle	solid, dashed or dotted lines?	Solid
LinesVisible	visibility of lines	TRUE
LineColorType	line coloring types	Flat
LineColorFunction	functional line coloring	
LineColorDirection	the direction of color transitions on lines	[0, 0, 1]
LineColorDirectionX	x-component of the direction of color transitions on lines	0
LineColorDirectionY	y-component of the direction of color transitions on lines	0
LineColorDirectionZ	z-component of the direction of color transitions on lines	1
Name	the name of a plot object (for browser and legend)	
Normal	normal vector of circles and discs, etc. in 3D	[0, 0, 0]
NormalX	normal vector of circles and discs, etc. in 3D, x-component	0
NormalY	normal vector of circles and discs, etc. in 3D, y-component	0
NormalZ	normal vector of circles and discs, etc. in 3D, z-component	0

Attribute	Purpose	Default Value
ParameterEnd	end value of the animation parameter	
ParameterName	name of the animation parameter	
ParameterBegin	initial value of the animation parameter	
ParameterRange	range of the animation parameter	
PointSize	the size of points	1.5
PointStyle	the presentation style of points	FilledCircles
PointsVisible	visibility of mesh points	FALSE
Radius	radius of circles, spheres etc.	1
Shading	smooth color blend of surfaces	Smooth
TimeEnd	end time of the animation	10.0
TimeBegin	start time of the animation	0.0
TimeRange	the real time span of an animation	0.0 .. 10.0
Title	object title	
TitleFont	font of object titles	[" sans-serif ", 11]
TitlePosition	position of object titles	
TitleAlignment	horizontal alignment of titles w.r.t. their coordinates	Center
TitlePositionX	position of object titles, x component	
TitlePositionY	position of object titles, y component	
TitlePositionZ	position of object titles, z component	

Attribute	Purpose	Default Value
Top	top center of cones, cylinders, pyramids and prisms	[0, 0, 1]
TopX	base and top center of cones, cylinders, pyramids and prisms	0
TopY	base and top center of cones, cylinders, pyramids and prisms	0
TopZ	base and top center of cones, cylinders, pyramids and prisms	1
Visible	visibility	TRUE
VisibleAfter	object visible after this time value	
VisibleBefore	object visible until this time value	
VisibleFromTo	object visible during this time range	
VisibleAfterEnd	object visible after its animation time ended?	TRUE
VisibleBeforeBegin	object visible before its animation time starts?	TRUE

## Examples

### Example 1

We plot three regular prisms with axes given by the coordinate axes:

```
plot(plot::Prism(1, [-3, 0, 0], [3, 0, 0], Color = RGB::Red),
      plot::Prism(1, [0, -4, 0], [0, 4, 0], Color = RGB::Green),
      plot::Prism(1, [0, 0, -5], [0, 0, 5], Color = RGB::Blue)):
```

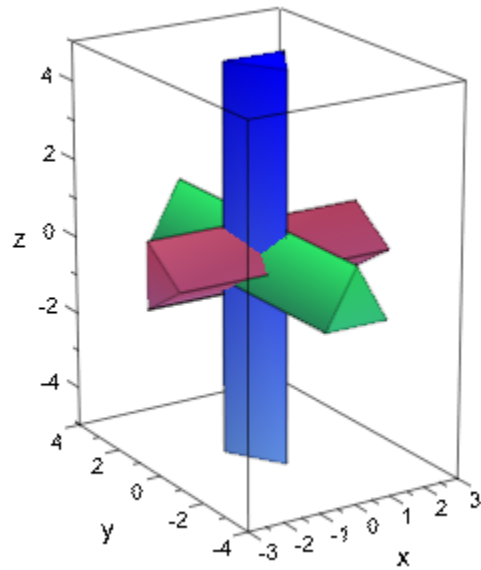

## Example 2

All parameters of a prism can be animated:

```
plot(plot::Prism(a, [0, 0, a], [0, 0, 3-a], a = 1..2)):
```

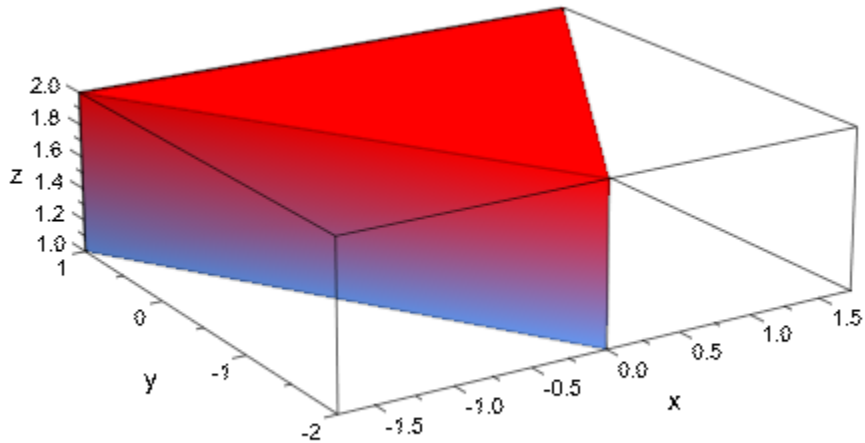

### Example 3

The number of edges of the regular base plane of the prism are determined with the attribute Edges:

```
plot(plot::Prism(1, [0, 0, 0], [0, 0, 1], Edges = 7)):
```

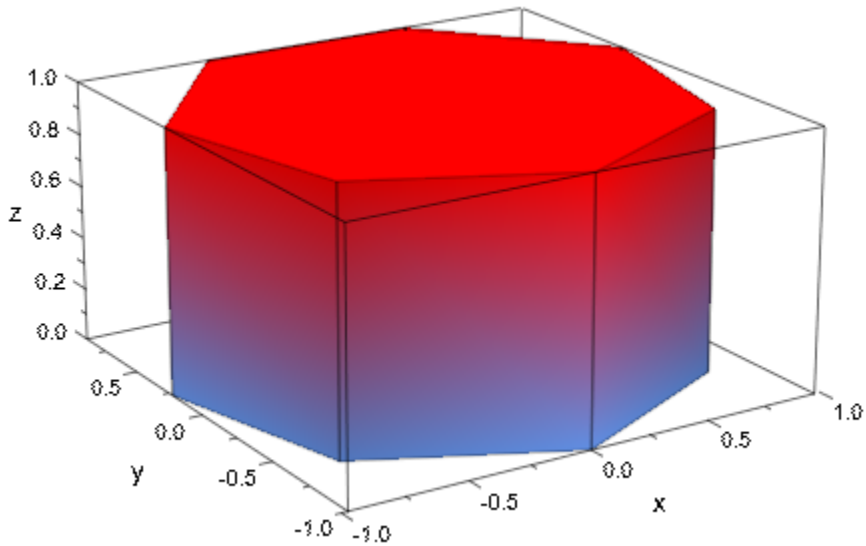

### Example 4

To create a crooked regular prism, the normal vector of its base plane is specified with the attribute `Normal`. If this attribute is set to `[0, 0, 0]`, the axis between `Base` and `Top` is used as normal vector:

```
plot(plot::Scene3d(plot::Pyramid(2,[0,0,0],1,[0,4,4], Normal=[0,0,0])),  
      plot::Scene3d(plot::Pyramid(2,[0,0,0],1,[0,4,4], Normal=[0,0,1]))):
```



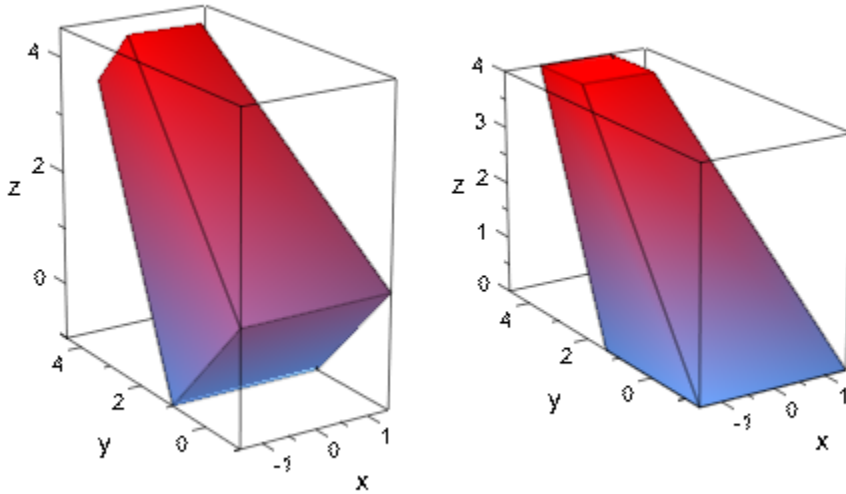

## Example 5

Additionally, the orientation of the edges of the base can be changed with the rotation angle `Angle`:

```
plot(plot::Prism(1/2, Angle=0),  
      plot::Prism(1/2, Angle=PI/4, FillColor2=RGB::Yellow))
```

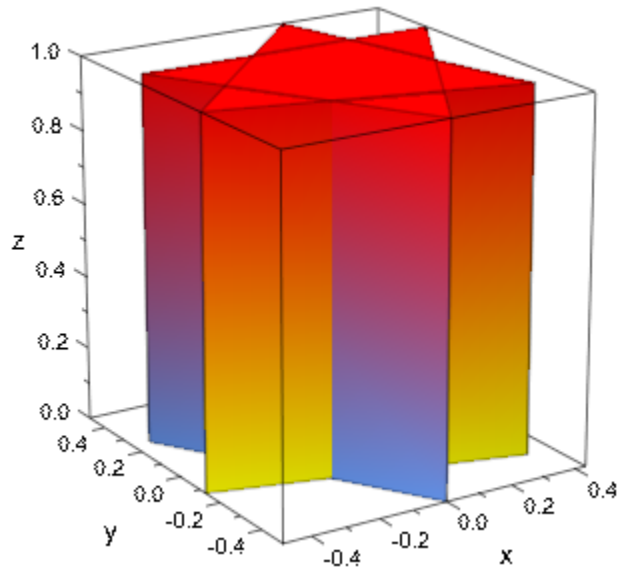

## Parameters

**r**

The radius of the circumcircle of the regular base plane: a real numerical value or an arithmetical expression (Symbolic Math Toolbox) of the animation parameter **a**.

**r** is equivalent to the attribute **Radius**.

**x<sub>1</sub>, y<sub>1</sub>, z<sub>1</sub>**

Components of the base center: real numerical values or expressions of the animation parameter **a**.

**x<sub>1</sub>, y<sub>1</sub>, z<sub>1</sub>** are equivalent to the attributes **BaseX**, **BaseY**, **BaseZ**.

**x<sub>2</sub>, y<sub>2</sub>, z<sub>2</sub>**

Components of the top center: real numerical values or expressions of the animation parameter **a**.

$x_2, y_2, z_2$  are equivalent to the attributes TopX, TopY, TopZ.

**a**

Animation parameter, specified as  $a = a_{\min}..a_{\max}$ , where  $a_{\min}$  is the initial parameter value, and  $a_{\max}$  is the final parameter value.

## See Also

### MuPAD Functions

plot | plot::copy

### MuPAD Graphical Primitives

plot::Cone | plot::Cylinder | plot::Pyramid

## plot::Pyramid

Pyramids and frustums of pyramids

### Syntax

```
plot::Pyramid(br, [bx, by, bz], <tr>, [tx, ty, tz], <a = amin .. amax>, options)
```

### Description

`plot::Pyramid(br, [ bx, by, bz], [ tx, ty, tz])` creates a pyramid stretching from the regular base plane with a circumcircle of radius *br* and center [b<sub>x</sub>, b<sub>y</sub>, b<sub>z</sub>] to the top [t<sub>x</sub>, t<sub>y</sub>, t<sub>z</sub>].

`plot::Pyramid(br, [ bx, by, bz], tr, [ tx, ty, tz])` creates a frustum of pyramid from the base with center [b<sub>x</sub>, b<sub>y</sub>, b<sub>z</sub>] to the top with center [t<sub>x</sub>, t<sub>y</sub>, t<sub>z</sub>]. The radius of the circumcircle of the regular base is *br*. The radius of the circumcircle of the regular top is *tr*.

The optional “top radius” *tr* for creating a frustum may also be specified as the attribute `TopRadius = tr`.

Note that only pyramids with a regular base can be created with `plot::Pyramid`. For other bases, use a `plot::SurfaceSet` primitive.

### Attributes

Attribute	Purpose	Default Value
<code>AffectViewingBox</code>	influence of objects on the <code>ViewingBox</code> of a scene	TRUE
<code>Angle</code>	rotation angle	0

Attribute	Purpose	Default Value
Base	base center of cones, cylinders, pyramids and prisms	[0, 0, 0]
BaseX	x-coordinate of top center of cones, cylinders, pyramids and prisms	0
BaseY	y-coordinate of top center of cones, cylinders, pyramids and prisms	0
BaseZ	z-coordinate of top center of cones, cylinders, pyramids and prisms	0
BaseRadius	base radius of cones/conical frustums and pyramids/frustums of pyramids	1
Color	the main color	RGB: :Red
Edges	Number of Edges	4
Filled	filled or transparent areas and surfaces	TRUE
FillColor	color of areas and surfaces	RGB: :Red
FillColor2	second color of areas and surfaces for color blends	RGB: :CornflowerBlue
FillColorType	surface filling types	Dichromatic
FillColorFunction	functional area/surface coloring	
FillColorDirection	the direction of color transitions on surfaces	[0, 0, 1]
FillColorDirectionX	x-component of the direction of color transitions on surfaces	0
FillColorDirectionY	y-component of the direction of color transitions on surfaces	0

<b>Attribute</b>	<b>Purpose</b>	<b>Default Value</b>
FillColorDirectionZ	z-component of the direction of color transitions on surfaces	1
Frames	the number of frames in an animation	50
Legend	makes a legend entry	
LegendText	short explanatory text for legend	
LegendEntry	add this object to the legend?	FALSE
LineColor	color of lines	RGB::Black.[0.25]
LineWidth	width of lines	0.35
LineColor2	color of lines	RGB::DeepPink
LineStyle	solid, dashed or dotted lines?	Solid
LinesVisible	visibility of lines	TRUE
LineColorType	line coloring types	Flat
LineColorFunction	functional line coloring	
LineColorDirection	the direction of color transitions on lines	[0, 0, 1]
LineColorDirectionX	x-component of the direction of color transitions on lines	0
LineColorDirectionY	y-component of the direction of color transitions on lines	0
LineColorDirectionZ	z-component of the direction of color transitions on lines	1
Name	the name of a plot object (for browser and legend)	
Normal	normal vector of circles and discs, etc. in 3D	[0, 0, 0]

Attribute	Purpose	Default Value
NormalX	normal vector of circles and discs, etc. in 3D, x-component	0
NormalY	normal vector of circles and discs, etc. in 3D, y-component	0
NormalZ	normal vector of circles and discs, etc. in 3D, z-component	0
ParameterEnd	end value of the animation parameter	
ParameterName	name of the animation parameter	
ParameterBegin	initial value of the animation parameter	
ParameterRange	range of the animation parameter	
PointSize	the size of points	1.5
PointStyle	the presentation style of points	FilledCircles
PointsVisible	visibility of mesh points	FALSE
Shading	smooth color blend of surfaces	Smooth
TimeEnd	end time of the animation	10.0
TimeBegin	start time of the animation	0.0
TimeRange	the real time span of an animation	0.0 .. 10.0
Title	object title	
TitleFont	font of object titles	[" sans-serif ", 11]
TitlePosition	position of object titles	
TitleAlignment	horizontal alignment of titles w.r.t. their coordinates	Center

<b>Attribute</b>	<b>Purpose</b>	<b>Default Value</b>
TitlePositionX	position of object titles, x component	
TitlePositionY	position of object titles, y component	
TitlePositionZ	position of object titles, z component	
Top	top center of cones, cylinders, pyramids and prisms	[0, 0, 1]
TopX	base and top center of cones, cylinders, pyramids and prisms	0
TopY	base and top center of cones, cylinders, pyramids and prisms	0
TopZ	base and top center of cones, cylinders, pyramids and prisms	1
TopRadius	top radius of cones/conical frustums and pyramids/frustums of pyramids	0
Visible	visibility	TRUE
VisibleAfter	object visible after this time value	
VisibleBefore	object visible until this time value	
VisibleFromTo	object visible during this time range	
VisibleAfterEnd	object visible after its animation time ended?	TRUE
VisibleBeforeBegin	object visible before its animation time starts?	TRUE



## Examples

### Example 1

We draw a pyramid with base radius 6:

```
plot(plot::Pyramid(6, [0, 0, 0], [0, 0, 10])):
```

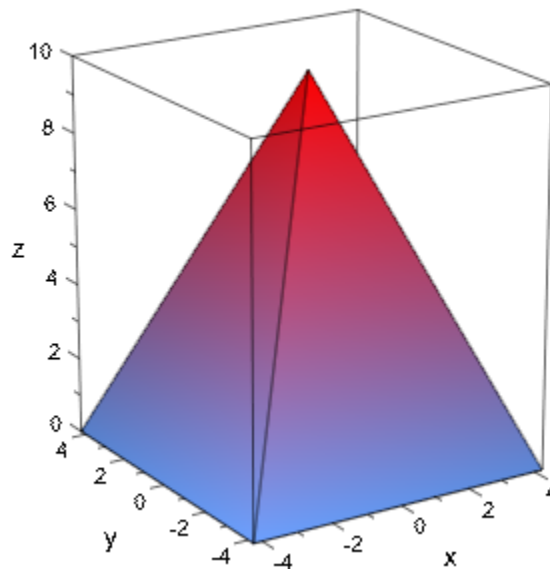

### Example 2

We create a frustum of pyramid by specifying a non-zero top radius:

```
br := 16: base := [3, 4, 5]:  
tr:= 7: top := [11, 12, 13]:  
plot(plot::Pyramid(br, base, tr, top)):
```

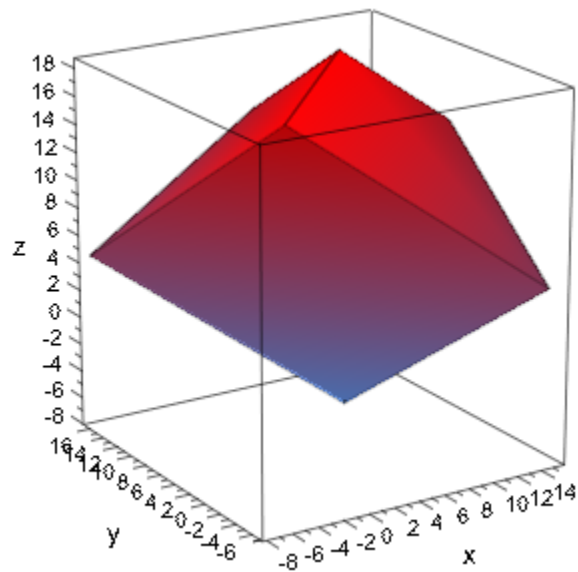

```
delete br, base, tr, top, n:
```

### Example 3

Bottom and top radii and centers can be animated:

```
plot(plot::Pyramid(sin(a)^2, [sin(2*a), cos(2*a), 0],  
                  cos(a)^2, [cos(2*a), sin(2*a), 1],  
                  a = 0..PI)):
```

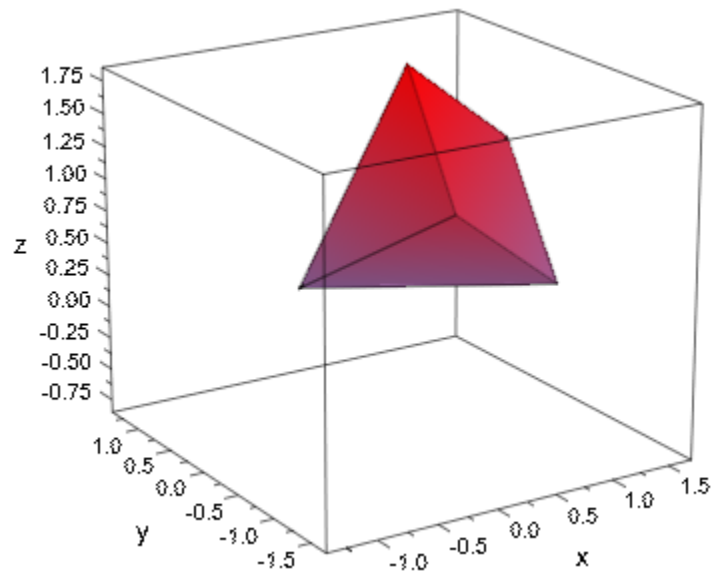

## Example 4

Additionally, the orientation of the edges of the base can be changed with the rotation angle `Angle`:

```
plot(plot::Pyramid(1/2, Angle=0),  
      plot::Pyramid(1/2, Angle=PI/4, FillColor2=RGB::Yellow))
```

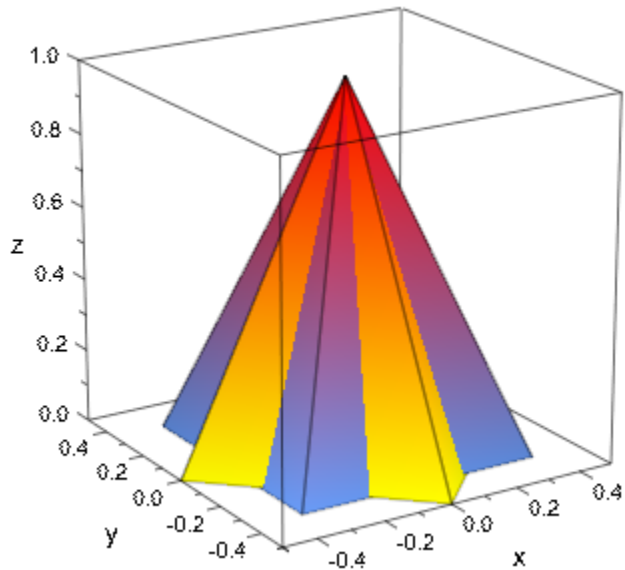

## Parameters

### **br**

The radius of the circumcircle of the regular base. This must be a real numerical value or an arithmetical expression (Symbolic Math Toolbox) of the animation parameter  $a$ .

$br$  is equivalent to the attribute `BaseRadius`.

### **$b_x$ , $b_y$ , $b_z$**

The lower center point. The coordinates  $b_x$ ,  $b_y$ ,  $b_z$  must be real numerical values or arithmetical expressions (Symbolic Math Toolbox) of the animation parameter  $a$ .

$b_x$ ,  $b_y$ ,  $b_z$  are equivalent to the attributes `BaseX`, `BaseY`, `BaseZ`.

### **tr**

The radius of the circumcircle of the regular top of the frustum of pyramid. This must be a real numerical value or an arithmetical expression (Symbolic Math Toolbox) of the

animation parameter  $a$ . If no top radius is specified, a pyramid with top radius  $tr = 0$  is created.

$tr$  is equivalent to the attribute `TopRadius`.

**$t_x, t_y, t_z$**

The upper center point. The coordinates  $t_x, t_y, t_z$  must be real numerical values or arithmetical expressions (Symbolic Math Toolbox) of the animation parameter  $a$ .

$t_x, t_y, t_z$  are equivalent to the attributes `TopX`, `TopY`, `TopZ`.

**$a$**

Animation parameter, specified as  $a = a_{\min} \dots a_{\max}$ , where  $a_{\min}$  is the initial parameter value, and  $a_{\max}$  is the final parameter value.

## See Also

### MuPAD Functions

`plot` | `plot::copy`

### MuPAD Graphical Primitives

`plot::Cone` | `plot::Cylinder` | `plot::Prism`

## plot::QQplot

Statistical quantile-quantile plots

### Syntax

```
plot::QQplot([a1, a2, ...], [b1, b2, ...], <a = amin .. amax>, options)
```

```
plot::QQplot([[a1, a2, ...], [b1, b2, ...]], <a = amin .. amax>, options)
```

```
plot::QQplot(A, <a = amin .. amax>, options)
```

```
plot::QQplot(s, <c1, c2>, <a = amin .. amax>, options)
```

```
plot::QQplot(s, <[c1, c2]>, <a = amin .. amax>, options)
```

### Description

`plot::QQplot(data1, data2)` plots the quantiles of the first data set against the quantiles of the second data set.

`plot::QQplot` creates a quantile-quantile plot of two discrete data samples  $[a_1, a_2, \dots]$  and  $[b_1, b_2, \dots]$ . A QQ plot displays the collection of points with coordinates  $[x_1, y_1], [x_2, y_2]$  etc., where  $x_i = \text{stats::empiricalQuantile}([a_1, a_2, \dots], i/(n - 1))$  and  $y_i = \text{stats::empiricalQuantile}([b_1, b_2, \dots], i/(n - 1))$  with  $i$  running from 0 through  $n - 1$ . The number of plot points  $n$  is set by the attribute `Size = n`. If no value is specified by the user,  $n$  is chosen as the minimum of the lengths of the data lists  $[a_1, a_2, \dots]$  and  $[b_1, b_2, \dots]$ .

In addition, the diagonal reference line  $y = x$  is displayed in the plot. This line can be suppressed by the attribute `LinesVisible = FALSE`.

The samples  $[a_1, a_2, \dots]$  and  $[b_1, b_2, \dots]$  do not need to have the same length.

A QQ plot is a graphical technique for determining if two data sets come from populations with a common distribution.

If the two sets come from a population with the same distribution, the points of the QQ plot should fall approximately along the reference line  $y = x$ . The greater the departure

from this reference line, the greater the evidence for the conclusion that the two data sets have come from populations with different distributions.

A specialized version of the QQ plot is the “probability plot”, where the quantiles of one of the data samples are replaced with the quantiles of a theoretical distribution. You can use `plot::QQplot` for this type of plot, too, by using a reference list such as

```
[stats::normalQuantile(0, 1)(i/n) $ i = 1 .. n-1]
```

as one of the data lists. In this particular case, data obeying a standard normal distribution on page 30-370 should produce plot points close to the diagonal reference line  $y = x$ .

Cf. “Example 3” on page 24-676 (Symbolic Math Toolbox).

## Attributes

Attribute	Purpose	Default Value
AffectViewingBox	influence of objects on the ViewingBox of a scene	TRUE
AntiAliased	antialiased lines and points?	TRUE
Data	the (statistical) data to plot	
Frames	the number of frames in an animation	50
Legend	makes a legend entry	
LegendText	short explanatory text for legend	
LegendEntry	add this object to the legend?	FALSE
LineColor	color of lines	RGB::Red
LineWidth	width of lines	0.35
LineStyle	solid, dashed or dotted lines?	Solid
LinesVisible	visibility of lines	TRUE

<b>Attribute</b>	<b>Purpose</b>	<b>Default Value</b>
Name	the name of a plot object (for browser and legend)	
ParameterEnd	end value of the animation parameter	
ParameterName	name of the animation parameter	
ParameterBegin	initial value of the animation parameter	
ParameterRange	range of the animation parameter	
PointSize	the size of points	1.5
PointColor	the color of points	RGB::Black
PointStyle	the presentation style of points	FilledCircles
PointsVisible	visibility of mesh points	TRUE
Size	size of a point list	
TimeEnd	end time of the animation	10.0
TimeBegin	start time of the animation	0.0
TimeRange	the real time span of an animation	0.0 .. 10.0
Title	object title	
TitleFont	font of object titles	[" sans-serif ", 11]
TitlePosition	position of object titles	
TitleAlignment	horizontal alignment of titles w.r.t. their coordinates	Center
TitlePositionX	position of object titles, x component	
TitlePositionY	position of object titles, y component	
Visible	visibility	TRUE



Attribute	Purpose	Default Value
VisibleAfter	object visible after this time value	
VisibleBefore	object visible until this time value	
VisibleFromTo	object visible during this time range	
VisibleAfterEnd	object visible after its animation time ended?	TRUE
VisibleBeforeBegin	object visible before its animation time starts?	TRUE

## Examples

### Example 1

We create a QQ plot of some data samples:

```
a := [6, 9, 17, 0, 13, 9, 9, 12, 12, 12]:  
b := [7, 8, 20, 2, 11, 8, 9, 12, 13, 15, 2, 14]:  
q := plot::QQplot(a, b):  
plot(q)
```

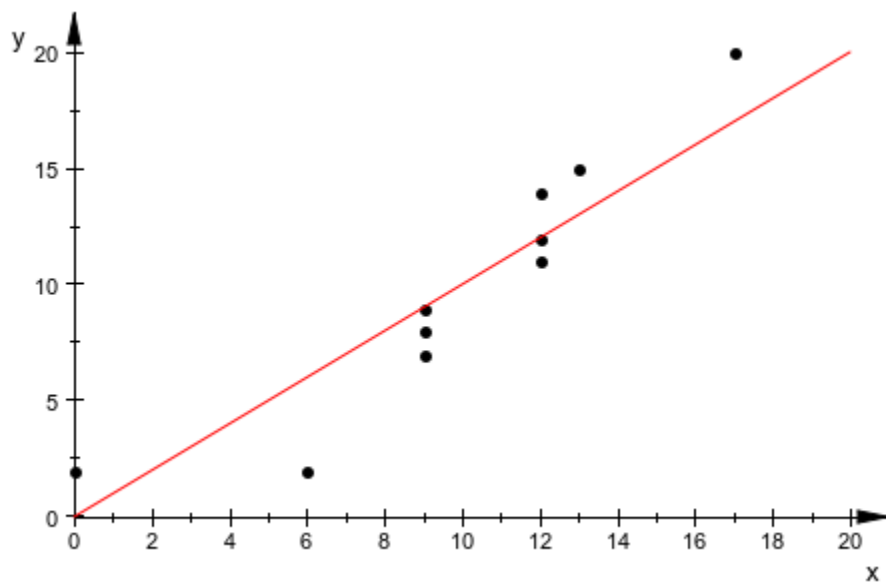

We can modify the appearance of the QQ plot in various ways:

```
q::PointColor := RGB::Red:  
q::PointSize := 3*unit::mm:  
q::LineColor := RGB::Black:  
q::LineWidth := 1*unit::mm:  
  
plot(q)
```

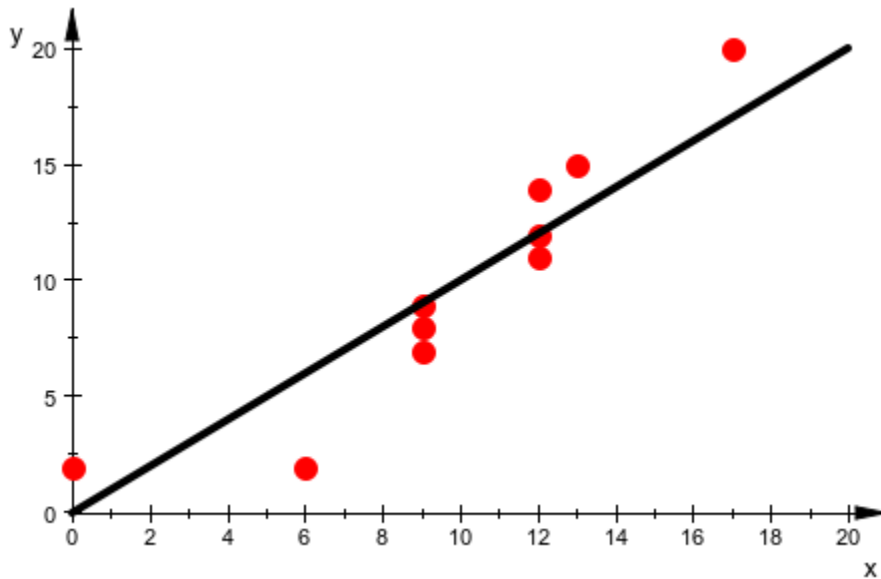

delete a, b, q:

## Example 2

We create some samples:

```
a := [stats::uniformRandom(-1, 1)() $ k = 1..100]:
b := [stats::normalRandom(0, 1)() $ k = 1..300]:
c := [stats::normalRandom(0, 1)() $ k = 1..500]:
```

The left QQ-plot shows a clear deviation from the reference line  $y = x$ . The samples  $a$  and  $b$  do not seem to be chosen from the same population. The QQ plot of the samples  $b$  and  $c$  (both normally distributed with mean 0 and variance 1), however, shows data points close to the reference line:

```
plot(plot::Scene2d(plot::QQplot(a, b)),
      plot::Scene2d(plot::QQplot(b, c)),
      Width = 20*unit::cm, Rows = 1)
```

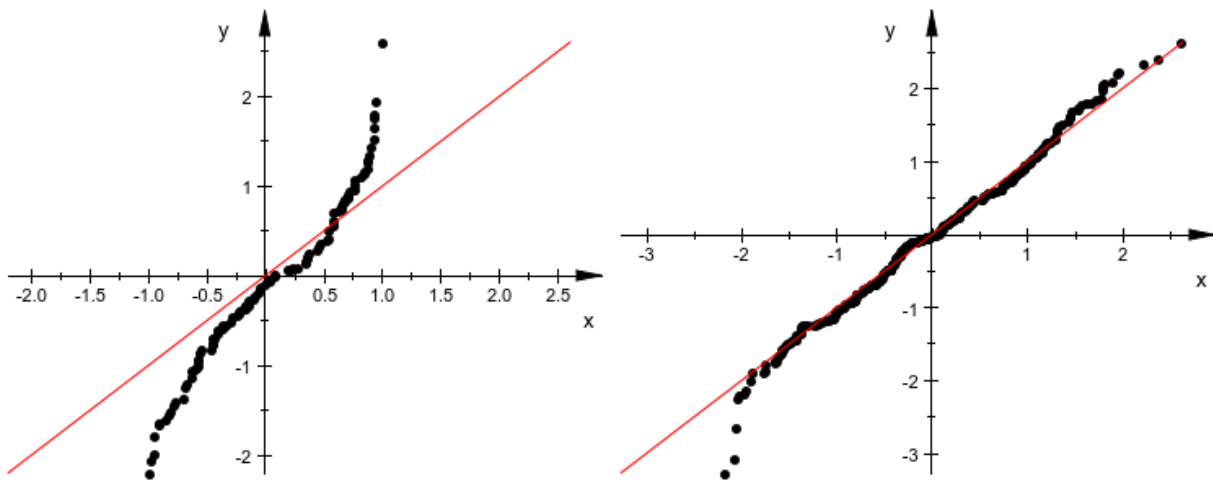

delete a, b, c:

### Example 3

We create a normally distributed sample:

```
data1 := [stats::normalRandom(0, 1)() $ k = 1..100]:
```

We wish to investigate whether these data can indeed be regarded as normally distributed. We create a reference sample of data that are definitely normally distributed:

```
n:= nops(data1):
data2 := [stats::normalQuantile(0, 1)(i/n) $ i = 1 .. n-1]:
```

The QQ plot of the data shows plot points close to the reference line  $y = x$ :

```
plot(plot::QQplot(data1, data2))
```

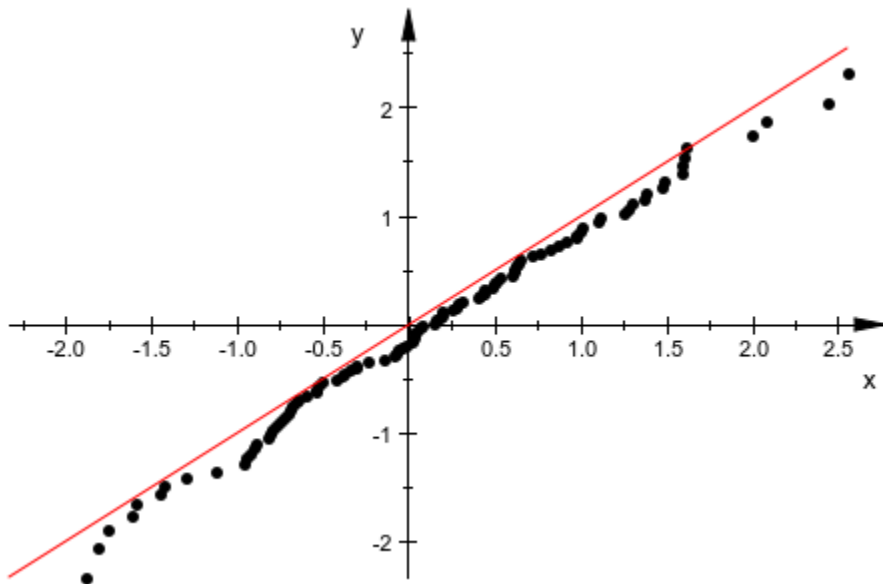

delete data1, n, data2:

## Parameters

$a_1, a_2, \dots, b_1, b_2, \dots$

The statistical data: numerical real values or arithmetical expressions (Symbolic Math Toolbox) of the animation parameter  $a$ .

$a_1, a_2, \dots, b_1, b_2, \dots$  are equivalent to the attribute Data.

### A

An array of domain type `DOM_ARRAY` or a matrix of category `Cat::Matrix` (e.g., of type `matrix` or `densematrix`) providing numerical real values or arithmetical expressions (Symbolic Math Toolbox) of the animation parameter  $a$ . The array/matrix must have 2 columns. The first column is regarded as the data set  $[a_1, a_2, \dots]$  the second column is regarded as the data set  $[b_1, b_2, \dots]$ . If more columns are provided, the superfluous columns are ignored.

A is equivalent to the attribute `Data`.

**s**

A data collection of domain type `stats::sample`. Two columns in `s` are regarded as the data lists `[a1, a2, ...]` and `[b1, b2, ...]` respectively.

`s` is equivalent to the attribute `Data`.

**c<sub>1</sub>, c<sub>2</sub>**

Column indices into `s`: positive integers. These indices, if given, indicate that only the specified columns in `s` should be used. If no column indices are specified, the first two columns in `s` are used as the data sets `[a1, a2, ...]` and `[b1, b2, ...]`, respectively.

**a**

Animation parameter, specified as `a = amin..amax`, where `amin` is the initial parameter value, and `amax` is the final parameter value.

## See Also

### MuPAD Functions

`plot` | `plot::copy`

### MuPAD Graphical Primitives

`plot::Bars2d` | `plot::Bars3d` | `plot::Boxplot` | `plot::Histogram2d` |  
`plot::Listplot` | `plot::Scatterplot`

# plot::Raster

Raster plot

## Syntax

```
plot::Raster(A, options)
```

```
plot::Raster(A, x = x_min .. x_max, y = y_min .. y_max, <a = a_min .. a_max>, options)
```

```
plot::Raster(L, options)
```

```
plot::Raster(L, x = x_min .. x_max, y = y_min .. y_max, <a = a_min .. a_max>, options)
```

## Description

`plot::Raster(A, x = x_min..x_max, y = y_min..y_max)` translates a matrix  $A$  of RGB values into a regular 2D mesh of rectangles extending from the lower left corner ( $x_{\min}$ ,  $y_{\min}$ ) to the upper right corner ( $x_{\max}$ ,  $y_{\max}$ ). The rectangles are colored according to the color entries in  $A$ .

`plot::Raster` serves for generating 2D raster objects such as bitmaps. External bitmap data can be imported to a MuPAD session via `import::readbitmap`. The resulting array of color values can be passed directly to `plot::Raster` to embed the imported bitmap in a 2D MuPAD scene.

When color values are specified by an array or a matrix  $A$ , the low indices correspond to the lower left corner of the graphics. The high indices correspond to the upper right corner.

---

**Note** Note that the bitmap data of most standard graphical formats are stored in the usual Western reading order: the first pixels correspond to the upper left corner, the last pixels correspond to the lower right corner. The utility `import::readbitmap` produces an array in which the first element corresponds to the lower left corner. Bitmap data imported this way can be passed directly to `plot::Raster`.

---

Arrays/matrices do not need to be indexed from 1. E.g.,

`A = array( imin..imax, jmin..jmax, [..RGB values..])`

yields a graphical array with

`XMesh = jmax - jmin + 1, YMesh = imax - imin + 1.`

If no plot range `xmin..xmax, ymin..ymax` is specified,

`xmin = jmin - 1, xmax = jmax, ymin = imin - 1, ymax = imax`

is used.

When color values are specified by a list of lists *L*, the first entries in the list correspond to the lower left corner of the graphics. The last entries correspond to the upper right corner.

If no plot range `xmin..xmax, ymin..ymax` is specified,

`xmin = 0, xmax = m, ymin = 0, ymax = n`

is used, where *n* is the length of *L* and *m* is the (common) length of the sublists in *L*. All sublists (“rows”) must have the same length.

Animations are triggered by specifying a range `a = amin .. amax` for a parameter *a* that is different from the variables *x*, *y*. Thus, in animations, both the ranges `x = xmin..xmax, y = ymin..ymax` as well as the animation range `a = amin..amax` must be specified.

The related plot routine `plot::Density` provides a similar functionality offering an automatic color scheme based on scalar density values.

## Attributes

Attribute	Purpose	Default Value
<code>AffectViewingBox</code>	influence of objects on the <code>ViewingBox</code> of a scene	TRUE
<code>AntiAliased</code>	antialiased lines and points?	FALSE
<code>Color</code>	the main color	RGB::Blue



<b>Attribute</b>	<b>Purpose</b>	<b>Default Value</b>
ColorData	color values of a raster plot	
Frames	the number of frames in an animation	50
Legend	makes a legend entry	
LegendText	short explanatory text for legend	
LegendEntry	add this object to the legend?	FALSE
LineColor	color of lines	RGB::Blue
LineWidth	width of lines	0.35
LineStyle	solid, dashed or dotted lines?	Solid
LinesVisible	visibility of lines	FALSE
Mesh	number of sample points	[11, 11]
Name	the name of a plot object (for browser and legend)	
ParameterEnd	end value of the animation parameter	
ParameterName	name of the animation parameter	
ParameterBegin	initial value of the animation parameter	
ParameterRange	range of the animation parameter	
TimeEnd	end time of the animation	10.0
TimeBegin	start time of the animation	0.0
TimeRange	the real time span of an animation	0.0 .. 10.0
Title	object title	
TitleFont	font of object titles	[" sans-serif ", 11]

<b>Attribute</b>	<b>Purpose</b>	<b>Default Value</b>
TitlePosition	position of object titles	
TitleAlignment	horizontal alignment of titles w.r.t. their coordinates	Center
TitlePositionX	position of object titles, x component	
TitlePositionY	position of object titles, y component	
Visible	visibility	TRUE
VisibleAfter	object visible after this time value	
VisibleBefore	object visible until this time value	
VisibleFromTo	object visible during this time range	
VisibleAfterEnd	object visible after its animation time ended?	TRUE
VisibleBeforeBegin	object visible before its animation time starts?	TRUE
XMax	final value of parameter "x"	
XMesh	number of sample points for parameter "x"	11
XMin	initial value of parameter "x"	
XName	name of parameter "x"	
XRange	range of parameter "x"	
YMax	final value of parameter "y"	
YMesh	number of sample points for parameter "y"	11
YMin	initial value of parameter "y"	
YName	name of parameter "y"	

Attribute	Purpose	Default Value
YRange	range of parameter "y"	

## Examples

### Example 1

We generate a raster plot:

```
checkerboard:= array(1..8, 1..8):
for i from 1 to 8 do
  for j from 1 to 8 do
    if i + j mod 2 = 0 then
      checkerboard[i,j] := RGB::Black;
    else
      checkerboard[i,j] := RGB::White;
    end_if;
  end_for;
end_for;
p := plot::Raster(checkerboard):
```

The plot object is rendered:

```
plot(p):
```

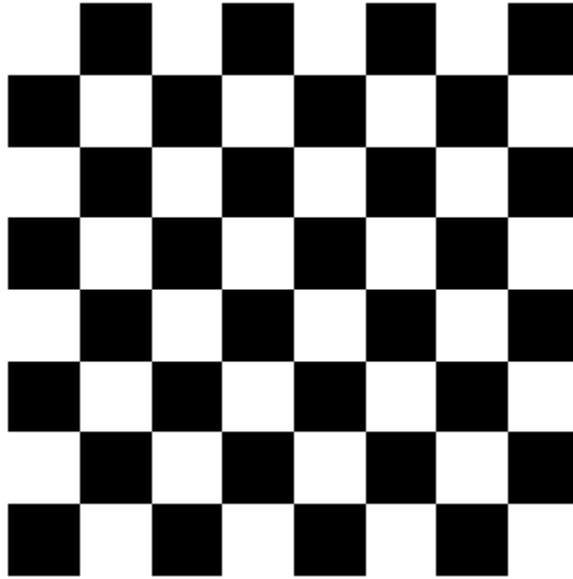

```
delete checkerboard, p:
```

## Example 2

We import an external bitmap file:

```
[width, height, colordata] := import::readbitmap("Eva.jpeg"):
```

The array `colordata` can be passed directly to `plot::Raster`:

```
scenewidth:= 80*unit::mm:  
sceneheight:= height/width*scenewidth:  
plot(plot::Raster(colordata),  
      Width = scenewidth,  
      Height = sceneheight,  
      Footer = "This is Eva"):
```



This is Eva

```
delete width, height, colordata, scenewidth, sceneheight:
```

### Example 3

This is Tom:

```
[widthT, heightT, Tom] :=  
  import::readbitmap("Tom.jpeg", Returntype = DOM_ARRAY):  
  plot(plot::Raster(Tom), Width = widthT/3, Height = heightT/3):
```



This is Jerry:

```
[widthJ, heightJ, Jerry] :=  
  import::readbitmap("Jerry.jpeg", Returntype = DOM_ARRAY):  
  plot(plot::Raster(Jerry), Width = widthT/3, Height = heightT/3):
```



Although they look different, they are topologically equivalent. We demonstrate this by deforming Tom to Jerry via a smooth map  $(1 - a)T + aJ$ ,  $a \in [0, 1]$ :

```
blend := (T, J, a) -> zip(T, J, (t,j) -> (1-a)*t + a*j):
Tom2Jerry:= array(1..heightT, 1..widthT):
for i from 1 to heightT do
  for j from 1 to widthT do
    Tom2Jerry[i, j]:= blend(Tom[i, j], Jerry[i, j], a):
  end_for:
end_for:
```

The following call produces an animated plot of the deformation. Note that x and y ranges must be specified for an animation:

```
plot(plot::Raster(Tom2Jerry,
  x = 1..widthT,
  y = 1..heightT,
  a = 0..1, Frames = 10,
  Footer = "Tom & Jerry"),
  Width = widthT/3, Height = heightT/3):
```



Tom & Jerry

This is the arithmetical mean of Tom and Jerry:

```
plot(plot::Raster(map(subs(Tom2Jerry, a = 0.5), eval)),  
      Footer = "(Tom + Jerry)/2", FooterFont = [12],  
      Width = widthT/3, Height = heightT/3):
```





(Tom + Jerry)/2

## Parameters

### A

An array of domain type `DOM_ARRAY` or a matrix of category `Cat::Matrix` (e.g., of type `matrix` or `densematrix`) providing RGB values or color expressions of the animation parameter  $a$ . Rows/columns of the array, respectively matrix, correspond to rows/columns of the graphical array.

A is equivalent to the attribute `ColorData`.

### L

A list of lists RGB values or color expressions of the animation parameter  $a$ . Each sublist of  $L$  represents a row of the graphical array.

L is equivalent to the attribute `ColorData`.

**x**

Name of the horizontal variable: an identifier on page 7-29 or an indexed identifier on page 1-1017. It is used as the title of the coordinate axis in x direction.

x is equivalent to the attribute XName.

**$x_{\min}$  ..  $x_{\max}$**

The range of the horizontal variable:  $x_{\min}$ ,  $x_{\max}$  must be numerical real value or expressions of the animation parameter  $a$ .

$x_{\min}$  ..  $x_{\max}$  is equivalent to the attributes XRange, XMin, XMax.

**y**

Name of the vertical variable: an identifier on page 7-29 or an indexed identifier on page 1-1017. It is used as the title of the coordinate axis in y direction.

y is equivalent to the attribute YName.

**$y_{\min}$  ..  $y_{\max}$**

The range of the vertical variable:  $y_{\min}$ ,  $y_{\max}$  must be numerical real value or expressions of the animation parameter  $a$ .

$y_{\min}$  ..  $y_{\max}$  is equivalent to the attributes YRange, YMin, YMax.

**a**

Animation parameter, specified as  $a = a_{\min} .. a_{\max}$ , where  $a_{\min}$  is the initial parameter value, and  $a_{\max}$  is the final parameter value.

## See Also

**MuPAD Functions**

`import::readbitmap` | `plot` | `plot::copy`

**MuPAD Graphical Primitives**

`plot::Density` | `plot::Inequality`

# plot::Rectangle

Rectangles in 2D

## Syntax

```
plot::Rectangle( $x_{\min}$  ..  $x_{\max}$ ,  $y_{\min}$  ..  $y_{\max}$ , <a =  $a_{\min}$  ..  $a_{\max}$ >, options)
```

## Description

`plot::Rectangle(  $x_{\min}$  ..  $x_{\max}$  ,  $y_{\min}$  ..  $y_{\max}$  )` generates the 2D rectangle with the corners  $(x_{\min}, y_{\min})$ ,  $(x_{\min}, y_{\max})$ ,  $(x_{\max}, y_{\min})$ ,  $(x_{\max}, y_{\max})$ .

`plot::Rectangle` creates a 2D rectangle with edges parallel to the coordinate axes.

With `Filled = FALSE`, the rectangle consists only of its edges. With `Filled = TRUE`, it is a filled area.

The lines can be set as desired with `LineStyle`, `LineWidth`, and `LineColor`. Cf. “Example 1” on page 24-694 (Symbolic Math Toolbox).

With `LinesVisible = FALSE`, the edges are rendered invisible.

For filled rectangles, a `FillColor` and a `FillPattern` can be selected. Cf. “Example 2” on page 24-695 (Symbolic Math Toolbox).

## Attributes

Attribute	Purpose	Default Value
<code>AffectViewingBox</code>	influence of objects on the <code>ViewingBox</code> of a scene	TRUE
<code>AntiAliased</code>	antialiased lines and points?	FALSE
<code>Color</code>	the main color	RGB::Blue

<b>Attribute</b>	<b>Purpose</b>	<b>Default Value</b>
Filled	filled or transparent areas and surfaces	FALSE
FillColor	color of areas and surfaces	RGB::Red
FillPattern	type of area filling	DiagonalLines
Frames	the number of frames in an animation	50
Legend	makes a legend entry	
LegendText	short explanatory text for legend	
LegendEntry	add this object to the legend?	FALSE
LineColor	color of lines	RGB::Blue
LineWidth	width of lines	0.35
LineStyle	solid, dashed or dotted lines?	Solid
LinesVisible	visibility of lines	TRUE
LineColorDirection	the direction of color transitions on lines	[0, 1]
LineColorDirectionX	x-component of the direction of color transitions on lines	0
LineColorDirectionY	y-component of the direction of color transitions on lines	1
Name	the name of a plot object (for browser and legend)	
ParameterEnd	end value of the animation parameter	
ParameterName	name of the animation parameter	
ParameterBegin	initial value of the animation parameter	

Attribute	Purpose	Default Value
ParameterRange	range of the animation parameter	
TimeEnd	end time of the animation	10.0
TimeBegin	start time of the animation	0.0
TimeRange	the real time span of an animation	0.0 .. 10.0
Title	object title	
TitleFont	font of object titles	[" sans-serif ", 11]
TitlePosition	position of object titles	
TitleAlignment	horizontal alignment of titles w.r.t. their coordinates	Center
TitlePositionX	position of object titles, x component	
TitlePositionY	position of object titles, y component	
Visible	visibility	TRUE
VisibleAfter	object visible after this time value	
VisibleBefore	object visible until this time value	
VisibleFromTo	object visible during this time range	
VisibleAfterEnd	object visible after its animation time ended?	TRUE
VisibleBeforeBegin	object visible before its animation time starts?	TRUE
XMax	final value of parameter "x"	1
XMin	initial value of parameter "x"	-1
XRange	range of parameter "x"	-1 .. 1
YMax	final value of parameter "y"	1

Attribute	Purpose	Default Value
YMin	initial value of parameter "y"	-1
YRange	range of parameter "y"	-1 .. 1

## Examples

### Example 1

We plot two rectangles:

```
plot(plot::Rectangle(-2..2, -2..2, Filled = TRUE,  
      FillColor = RGB::Red),  
      plot::Rectangle(1..5, 1..5, Filled = FALSE,  
      LineColor = RGB::Black,  
      LineStyle = Dashed))
```

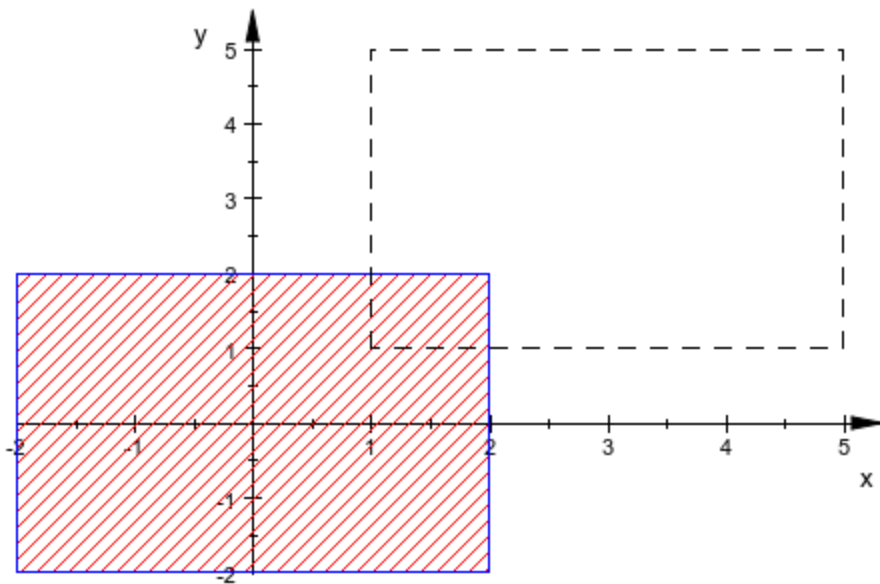

## Example 2

We plot rectangles with different fill patterns (`FillPattern`):

```
plot(plot::Rectangle(0..1, 2..3, Filled = TRUE,
                    FillPattern = Solid,
                    FillColor = RGB::Red),
     plot::Rectangle(1..2, 2..3, Filled = TRUE,
                    FillPattern = CrossedLines,
                    FillColor = RGB::Green),
     plot::Rectangle(2..3, 2..3, Filled = TRUE,
                    FillPattern = XCrossedLines,
                    FillColor = RGB::Blue),
     plot::Rectangle(0..1, 1..2, Filled = TRUE,
                    FillPattern = HorizontalLines,
                    FillColor = RGB::Orange),
     plot::Rectangle(1..2, 1..2, Filled = TRUE,
                    FillPattern = VerticalLines,
                    FillColor = RGB::Violet),
     plot::Rectangle(0..1, 0..1, Filled = TRUE,
                    FillPattern = DiagonalLines,
                    FillColor = RGB::Brown),
     plot::Rectangle(1..2, 0..1, Filled = TRUE,
                    FillPattern = FDiagonalLines,
                    FillColor = RGB::Cyan))
```

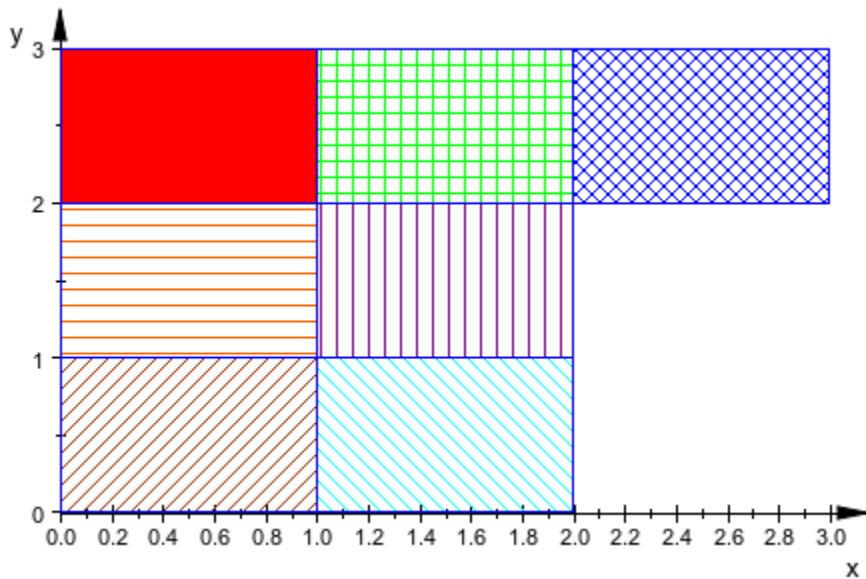

## Parameters

$x_{\min} \dots x_{\max}$

The left and right border of the rectangle: real numerical values or arithmetical expressions (Symbolic Math Toolbox) of the animation parameter  $a$ .

$x_{\min} \dots x_{\max}$  is equivalent to the attributes XRange, XMin, XMax.

$y_{\min} \dots y_{\max}$

The lower and upper border of the rectangle: real numerical values or arithmetical expressions (Symbolic Math Toolbox) of the animation parameter  $a$ .

$y_{\min} \dots y_{\max}$  is equivalent to the attributes YRange, YMin, YMax.

$a$

Animation parameter, specified as  $a = a_{\min} \dots a_{\max}$ , where  $a_{\min}$  is the initial parameter value, and  $a_{\max}$  is the final parameter value.



## See Also

### **MuPAD Functions**

plot | plot::copy

### **MuPAD Graphical Primitives**

plot::Box | plot::Line2d | plot::Line3d | plot::Polygon2d |  
plot::Polygon3d

## plot::Rootlocus

Curves of roots of rational expressions

### Syntax

```
plot::Rootlocus(p(z, u), u = u_min .. u_max, <a = a_min .. a_max>, options)
```

### Description

`plot::Rootlocus(p(z, u), u = u_min .. u_max)` creates a 2D plot of the curves in the complex plane given by the roots of  $p(z, u) = 0$  (solved for  $z$ ) as the parameter  $u$  varies between  $u_{\min}$  and  $u_{\max}$ .

For any given value of  $u$ , `plot::Rootlocus` solves the equation  $p(z, u) = 0$  for  $z$ . The solutions define points with coordinates  $x = \Re(z)$ ,  $y = \Im(z)$  in the complex plane. As the parameter  $u$  varies, the solutions form continuous curves that are depicted by `plot::Rootlocus`.

The roots of the numerator of  $p(z, u)$  are considered. All complex solutions of this polynomial in  $z$  are computed numerically via `numeric::polyroots`.

The polynomial is initially solved for some values  $u$  from the range  $u = u_{\min} .. u_{\max}$ . The optional argument `Mesh = n` can be used to specify the number  $n$  of these initial points (the default value is 51). These points are not equally spaced, but accumulate close to the end of the range.

The routine then tries to pair up the roots for adjacent values of  $u$  by choosing those closest to each other.

Finally, the routine tries to trace out the different curves by joining up adjacent points with line segments. If adjacent line segments exhibit angles that are not close to 180 degrees, additional roots are computed for parameter values  $u$  between the values of the initial mesh. Up to  $m$  such bisectioning steps are possible, where  $m$  is specified by the optional argument `AdaptiveMesh = m` (the default value is 4). With `AdaptiveMesh = 0`, this adaptive mechanism may be switched off.

Sometimes, the matching up of the roots to continuous curves can be fooled and the result is a messy plot. In such a case, the user can take the following measures to improve the plot:

- The parameter range  $u = u_{\min} \dots u_{\max}$  may be unreasonably large. Reduce this range to a reasonable size!
- Increase the size  $n$  of the initial mesh using the option `Mesh = n`. Note that increasing  $n$  by some factor may increase the runtime of the plot by the same factor!
- Increase the number  $m$  of possible adaptive bisectioning steps using the option `AdaptiveMesh = m`. Note that increasing  $m$  by 1 may increase the runtime of the plot by a factor of 2!
- Using the options `LinesVisible = FALSE` in conjunction with `PointsVisible = TRUE`, the roots are displayed as separate points without joining line segments.

Cf. “Example 2” on page 24-706 (Symbolic Math Toolbox).

Animations are triggered by specifying a range  $a = a_{\min} \dots a_{\max}$  for a parameter  $a$  that is different from the variables  $z$  and  $u$ . Cf. “Example 3” on page 24-710 (Symbolic Math Toolbox).

The curves can be colored by a user defined color scheme. Just pass the option `LineColorFunction = mycolor`, where `mycolor` is a user defined procedure that returns an RGB color value. The routine `plot::Rootlocus` calls `mycolor(u, x, y)`, where  $u$  is the parameter value and  $x, y$  are the real and imaginary parts of the root of  $p(x + iy, u) = 0$ . Cf. “Example 4” on page 24-712 (Symbolic Math Toolbox).

## Attributes

Attribute	Purpose	Default Value
<code>AdaptiveMesh</code>	adaptive sampling	4
<code>AffectViewingBox</code>	influence of objects on the <code>ViewingBox</code> of a scene	TRUE
<code>AntiAliased</code>	antialiased lines and points?	TRUE
<code>Frames</code>	the number of frames in an animation	50
<code>Legend</code>	makes a legend entry	

<b>Attribute</b>	<b>Purpose</b>	<b>Default Value</b>
LegendText	short explanatory text for legend	
LegendEntry	add this object to the legend?	FALSE
LineColor	color of lines	RGB::Blue
LineWidth	width of lines	0.35
LineStyle	solid, dashed or dotted lines?	Solid
LinesVisible	visibility of lines	TRUE
LineColorType	line coloring types	Flat
LineColorFunction	functional line coloring	
Mesh	number of sample points	51
Name	the name of a plot object (for browser and legend)	
ParameterEnd	end value of the animation parameter	
ParameterName	name of the animation parameter	
ParameterBegin	initial value of the animation parameter	
ParameterRange	range of the animation parameter	
PointSize	the size of points	1.0
PointStyle	the presentation style of points	FilledCircles
PointsVisible	visibility of mesh points	FALSE
RationalExpression	rational expression in a rootlocus plot	
TimeEnd	end time of the animation	10.0
TimeBegin	start time of the animation	0.0

<b>Attribute</b>	<b>Purpose</b>	<b>Default Value</b>
TimeRange	the real time span of an animation	0.0 .. 10.0
Title	object title	
TitleFont	font of object titles	[" sans-serif ", 11]
TitlePosition	position of object titles	
TitleAlignment	horizontal alignment of titles w.r.t. their coordinates	Center
TitlePositionX	position of object titles, x component	
TitlePositionY	position of object titles, y component	
UMax	final value of parameter "u"	
UMesh	number of sample points for parameter "u"	51
UMin	initial value of parameter "u"	
UName	name of parameter "u"	
URange	range of parameter "u"	
Visible	visibility	TRUE
VisibleAfter	object visible after this time value	
VisibleBefore	object visible until this time value	
VisibleFromTo	object visible during this time range	
VisibleAfterEnd	object visible after its animation time ended?	TRUE
VisibleBeforeBegin	object visible before its animation time starts?	TRUE

## Examples

### Example 1

The roots of the polynomial  $z^2 - 2uz + 1$  are given by  $z = u + \sqrt{u^2 - 1}$  and  $z = u - \sqrt{u^2 - 1}$ . We visualise these two curves via a rootlocus plot:

```
plot(plot::Rootlocus(z^2 - 2*u*z + 1, u = -1.5..1.5))
```

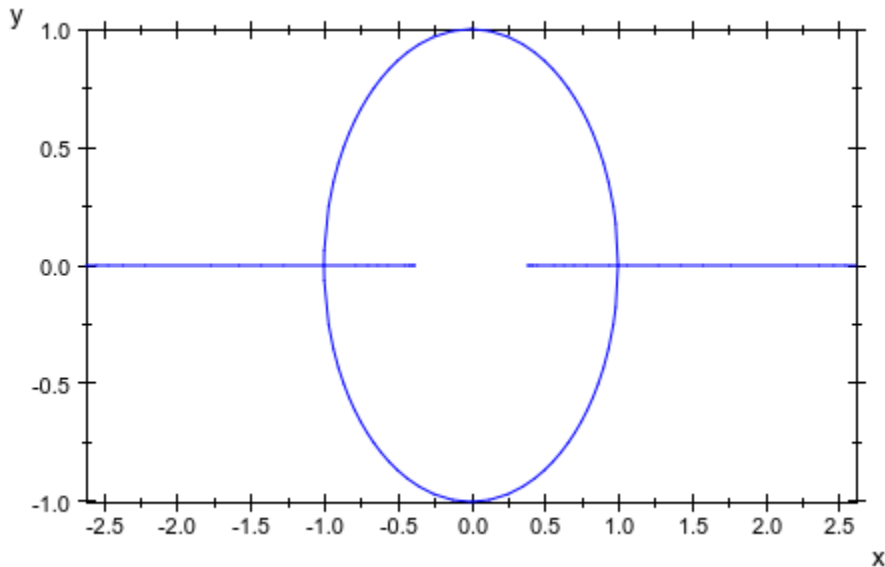

For rational expressions, the roots of the numerator are considered. The following plot displays the roots of the numerator polynomial  $(z^2 - u)^2 + u(z - u)^3$ :

```
plot(plot::Rootlocus(1 + u * (z - u)^3 / (z^2 - u)^2, u = -1..1)):
```

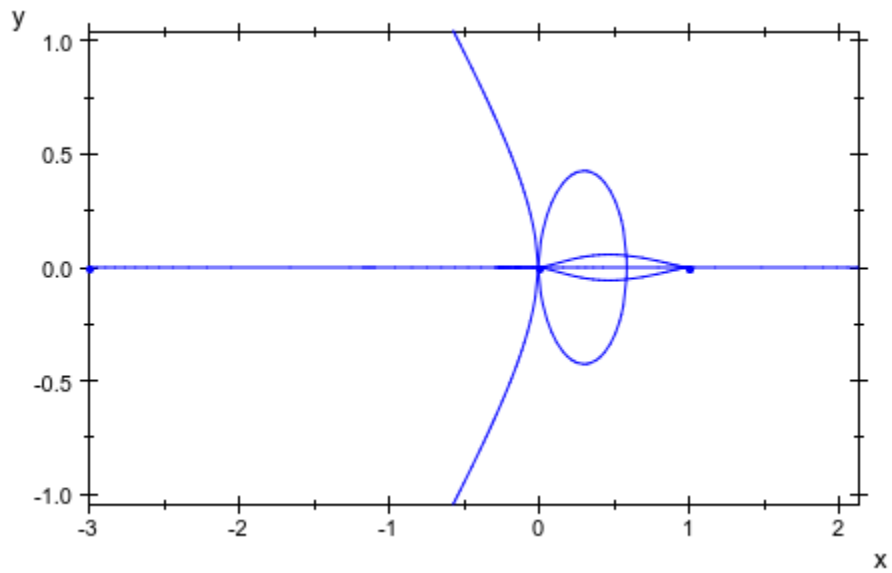

Here are various other examples:

```
plot(plot::Rootlocus((z^2 - 2*u*z + 1)^2 + u, u = -1..1))
```

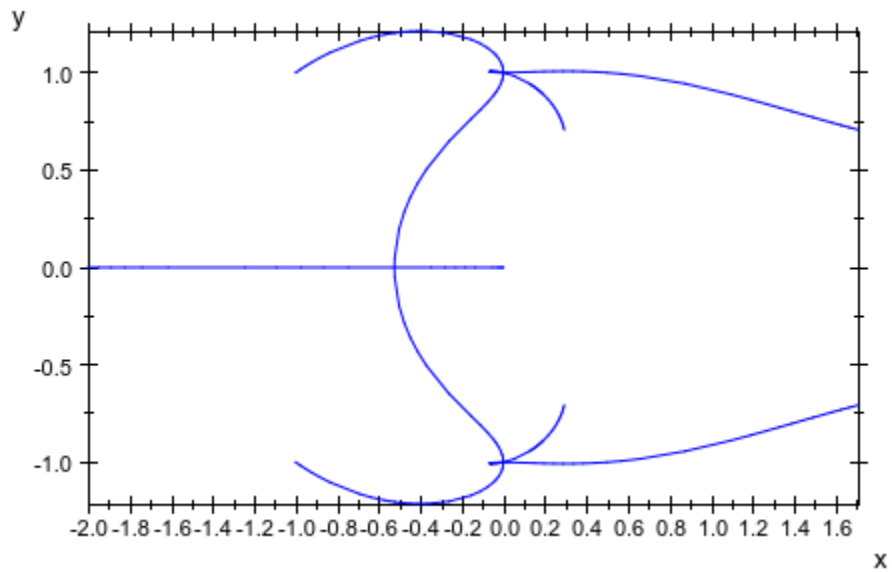

```
plot(plot::Rootlocus((z^2 - u)^6 + u^2, u = -2..2,  
Color = RGB::Red))
```



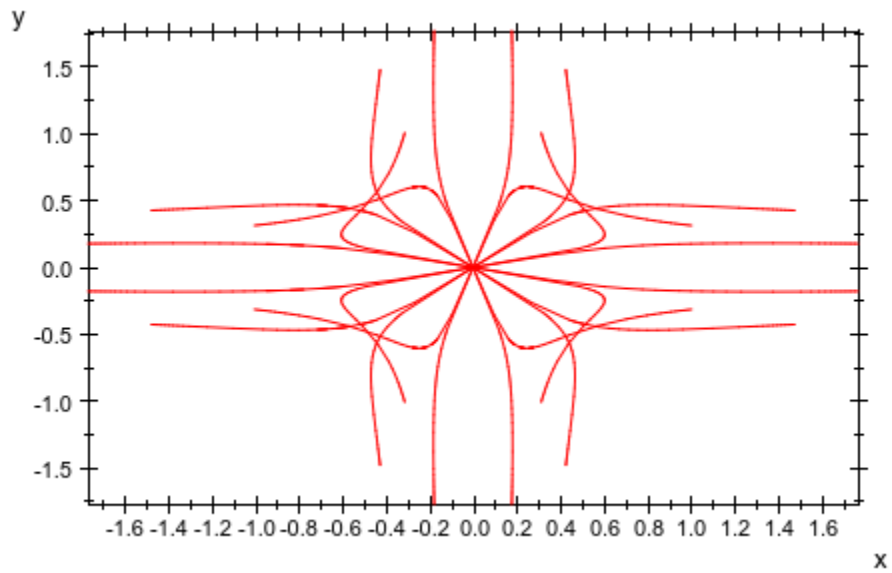

```
plot(plot::Rootlocus((z^5 - 1)^3 + u, u = -1..1, PointsVisible,  
                    PointSize = 1.5))
```

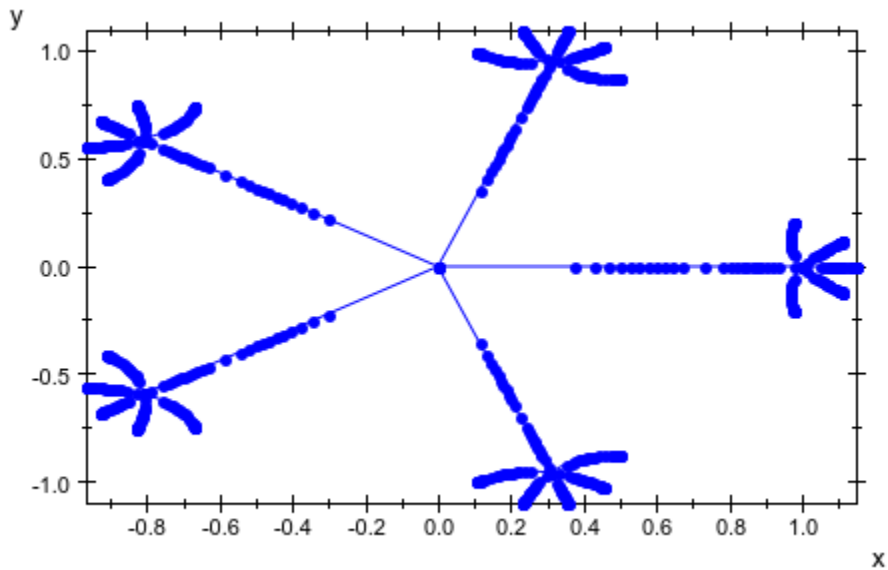

## Example 2

The following plot is rather messy, since the default mesh size of 51 initial points on each curve is not sufficient to obtain a good resolution:

```
plot(plot::Rootlocus((z-u)^3 - u/z^3, u = -10^3 .. 10^3)):
```

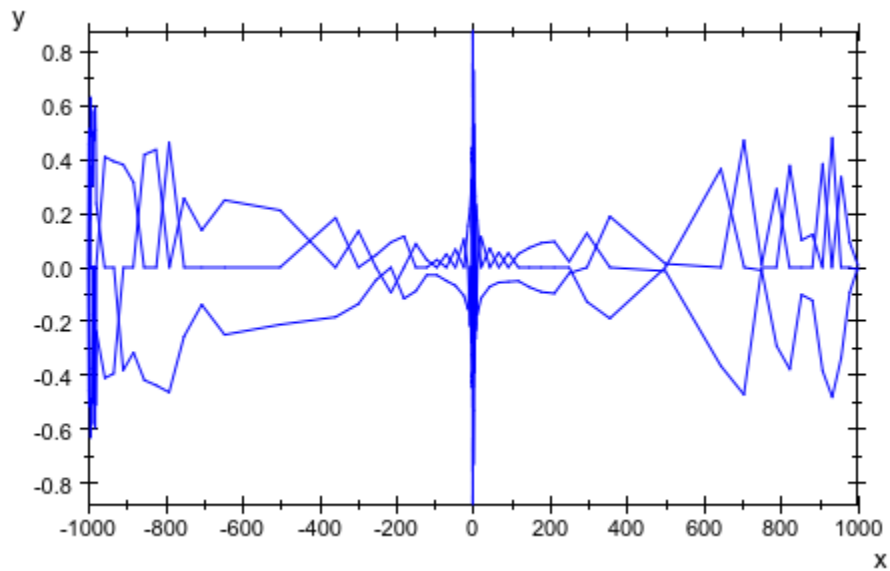

We obtain a better resolution by decreasing the range of the parameter  $u$  to a reasonable size. There are still a few points that are not properly matched up with the curves:

```
plot(plot::Rootlocus((z-u)^3 - u/z^3, u = -10 .. 10)):
```

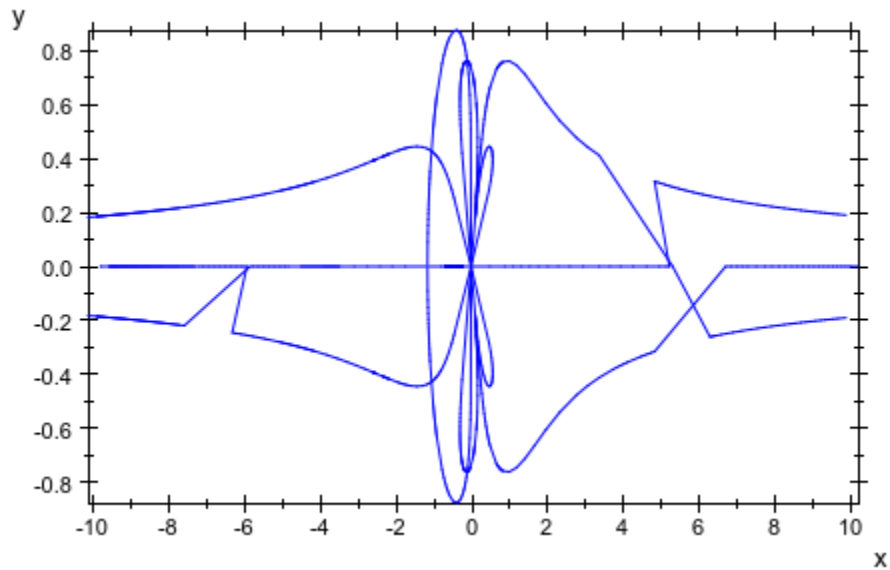

We increase the mesh size to cure this problem:

```
plot(plot::Rootlocus((z-u)^3 - u/z^3, u = -10 .. 10, Mesh = 251)):
```

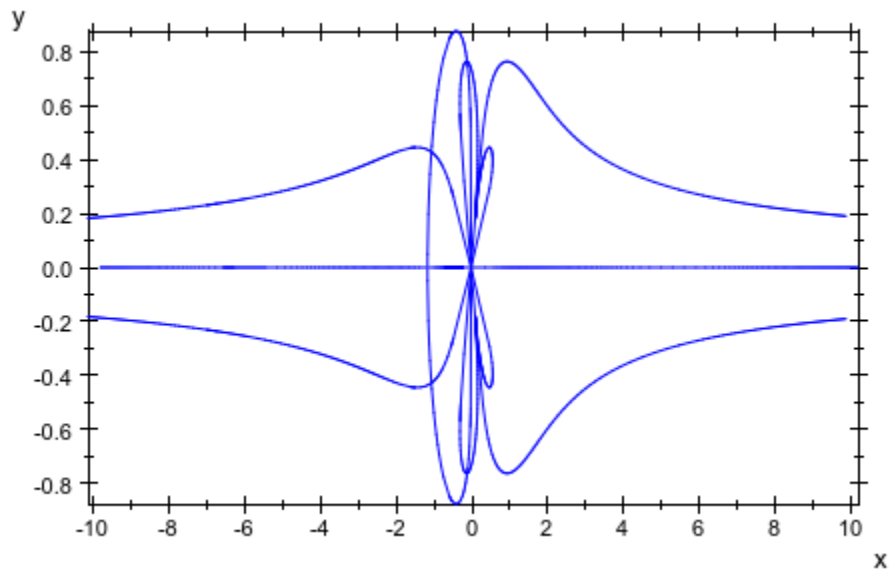

We plot the roots as separate points without displaying connecting line segments:

```
plot(plot::Rootlocus((z-u)^3 - u/z^3, u = -10 .. 10, Mesh = 501,  
LinesVisible = FALSE, PointsVisible)):
```

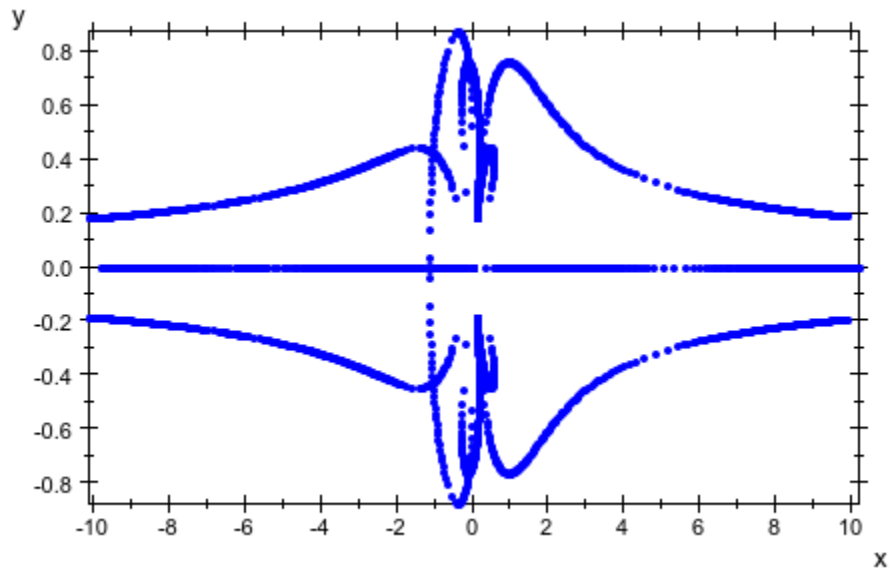

### Example 3

We animate the expression whose roots are to plotted:

```
plot(plot::Rootlocus(z^2 - 2*u*z + a, u = -1..1, a = -0.2 .. 2, Mesh = 10),  
      plot::Text2d(a -> "a = ".stringlib::formatf(a, 2, 5), [1.2, 1.0], a = -0.2 .. 1))
```

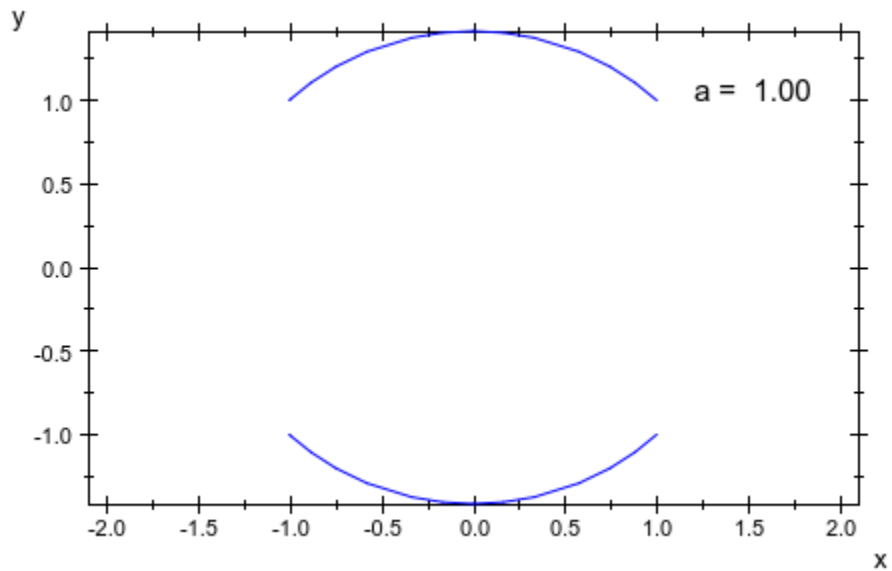

We animate the parameter range:

```
plot(plot::Rootlocus(z^2 - 2*u*z + 0.81, u = -1 .. a, a = -1 .. 1, Mesh = 10))
```

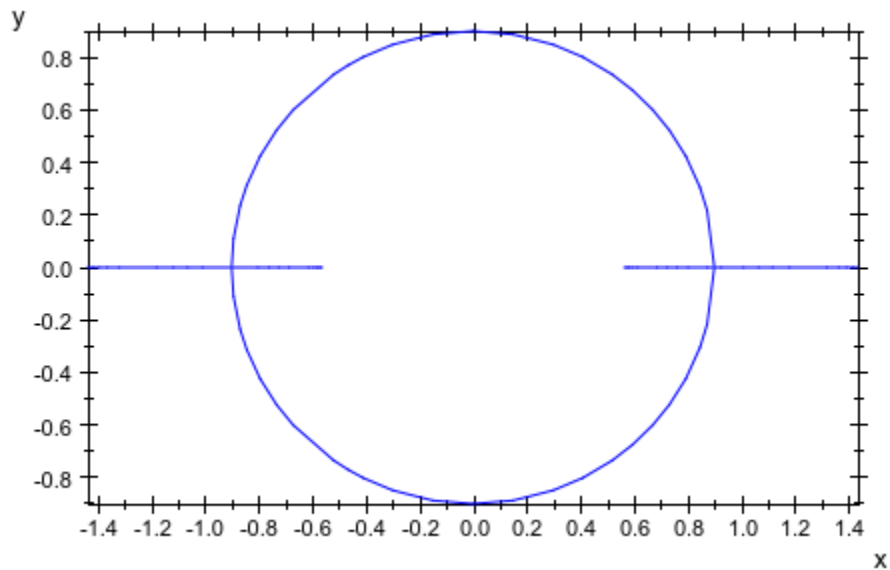

### Example 4

We provide a color function: roots for small values of the parameter  $u$  are displayed in red, whereas roots for large parameter values are displayed in blue:

```
plot(plot::Rootlocus(z^2 - 2*u*z + 0.81, u = -1..1,  
  LineColorFunction = ((u, x, y) -> [(1 - u)/2, 0, (1 + u)/2])))
```



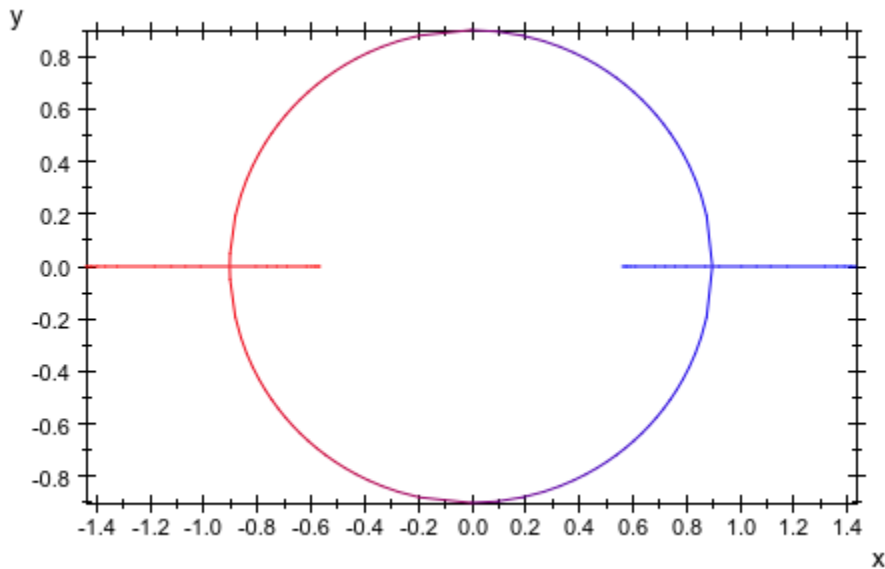

## Parameters

### $p(z, u)$

An arithmetical expression on page 1-1340 in two unknowns  $z$  and  $u$  and, possibly, the animation parameter  $a$ . It must be a rational expression in  $z$ .

$p(z, u)$  is equivalent to the attribute `RationalExpression`.

### $z$

Name of the unknown: an identifier on page 7-29 or an indexed identifier on page 1-1017.

### $u$

Name of the curve parameter: an identifier on page 7-29 or an indexed identifier on page 1-1017.

$u$  is equivalent to the attribute `UName`.

**$u_{\min} .. u_{\max}$**

The range of the curve parameter:  $u_{\min}$ ,  $u_{\max}$  must be numerical real values or expressions of the animation parameter  $a$ .

$u_{\min} .. u_{\max}$  is equivalent to the attributes `URange`, `UMin`, `UMax`.

**$a$**

Animation parameter, specified as  $a = a_{\min} .. a_{\max}$ , where  $a_{\min}$  is the initial parameter value, and  $a_{\max}$  is the final parameter value.

## See Also

### MuPAD Functions

`numeric::polyroots` | `plot` | `plot::copy`

### MuPAD Graphical Primitives

`plot::Curve2d`

# plot::Scatterplot

Statistical scatter plots

## Syntax

```
plot::Scatterplot([x1, x2, ...], [y1, y2, ...], <a = amin .. amax>, options)
plot::Scatterplot([[x1, x2, ...], [y1, y2, ...]], <a = amin .. amax>, options)
plot::Scatterplot([x1, y1], [x2, y2], ..., <a = amin .. amax>, options)
plot::Scatterplot([[x1, y1], [x2, y2], ...], <a = amin .. amax>, options)
plot::Scatterplot(A, <a = amin .. amax>, options)
plot::Scatterplot(s, <c1, c2>, <a = amin .. amax>, options)
```

## Description

`plot::Scatterplot` creates a scatter plot of two discrete data samples  $[x_1, x_2, \dots]$  and  $[y_1, y_2, \dots]$ . A scatter plot displays the collection of points with coordinates  $[x_1, y_1]$ ,  $[x_2, y_2]$  etc.

In addition, a regression line  $y = a + bx$  through the given data pairs  $[x_1, y_1]$  etc. is computed and added to the plot. The estimators  $a, b$  of the regression are computed by `stats::linReg`.

The regression line can be suppressed by specifying the attribute `LinesVisible = FALSE`.

The samples  $[x_1, x_2, \dots]$  and  $[y_1, y_2, \dots]$  should have the same number of elements. Otherwise, superfluous elements in the longer list are ignored.

There is an ambiguity between the various input formats if only 2 data points are provided:

---

**Note** For two data points the calls `plot::Scatterplot([a, b], [c, d])` and `plot::Scatterplot([[a, b], [c, d]])` both yield plots of the two points  $(x_1, y_1)$

= (a, b) and  $(x_2, y_2) = (c, d)$ , not of the points  $(x_1, y_1) = (a, c)$  and  $(x_2, y_2) = (b, d)$ !

---

The routines `plot::Listplot` and `plot::PointList2d` have a similar functionality. The main additional feature of `plot::Scatterplot` is the regression line.

Scatter plots are useful to visualize the relationship between two variables  $x$  (the “predictor”) and  $y$  (the “criterion”).

The variable regarded as a predictor corresponds to the horizontal axis while the variable regarded as the criterion corresponds to the vertical axis. The criterion variable represents the behavior to be predicted. The predictor variable represents the activity which is believed to be associated with the criterion.

The scatter plot consists of points  $(x, y)$  where  $x$  is a predictor value and  $y$  is the corresponding value of the criterion.

If there is a linear relation  $y = a + bx$  between  $x$  and  $y$ , the data points should form a line, potentially marred by statistical deviations. The regression line provided by the scatter plot allows a visual test of such a relation between  $x$  and  $y$ .

## Attributes

Attribute	Purpose	Default Value
<code>AffectViewingBox</code>	influence of objects on the <code>ViewingBox</code> of a scene	TRUE
<code>AntiAliased</code>	antialiased lines and points?	TRUE
<code>Data</code>	the (statistical) data to plot	
<code>Frames</code>	the number of frames in an animation	50
<code>Legend</code>	makes a legend entry	
<code>LegendText</code>	short explanatory text for legend	
<code>LegendEntry</code>	add this object to the legend?	FALSE

<b>Attribute</b>	<b>Purpose</b>	<b>Default Value</b>
LineColor	color of lines	RGB: :Red
LineWidth	width of lines	0.35
LineStyle	solid, dashed or dotted lines?	Solid
LinesVisible	visibility of lines	TRUE
Name	the name of a plot object (for browser and legend)	
ParameterEnd	end value of the animation parameter	
ParameterName	name of the animation parameter	
ParameterBegin	initial value of the animation parameter	
ParameterRange	range of the animation parameter	
PointSize	the size of points	1.5
PointColor	the color of points	RGB: :Black
PointStyle	the presentation style of points	FilledCircles
PointsVisible	visibility of mesh points	TRUE
TimeEnd	end time of the animation	10.0
TimeBegin	start time of the animation	0.0
TimeRange	the real time span of an animation	0.0 .. 10.0
Title	object title	
TitleFont	font of object titles	[" sans-serif ", 11]
TitlePosition	position of object titles	
TitleAlignment	horizontal alignment of titles w.r.t. their coordinates	Center

Attribute	Purpose	Default Value
TitlePositionX	position of object titles, x component	
TitlePositionY	position of object titles, y component	
Visible	visibility	TRUE
VisibleAfter	object visible after this time value	
VisibleBefore	object visible until this time value	
VisibleFromTo	object visible during this time range	
VisibleAfterEnd	object visible after its animation time ended?	TRUE
VisibleBeforeBegin	object visible before its animation time starts?	TRUE

## Examples

### Example 1

We plot some data samples:

```
xdata := [6, 9, 17, 0, 13, 9, 9, 12, 12, 12]:  
ydata := [7, 8, 20, 2, 11, 8, 9, 12, 13, 15]:  
b := plot::Scatterplot(xdata, ydata):  
plot(b)
```

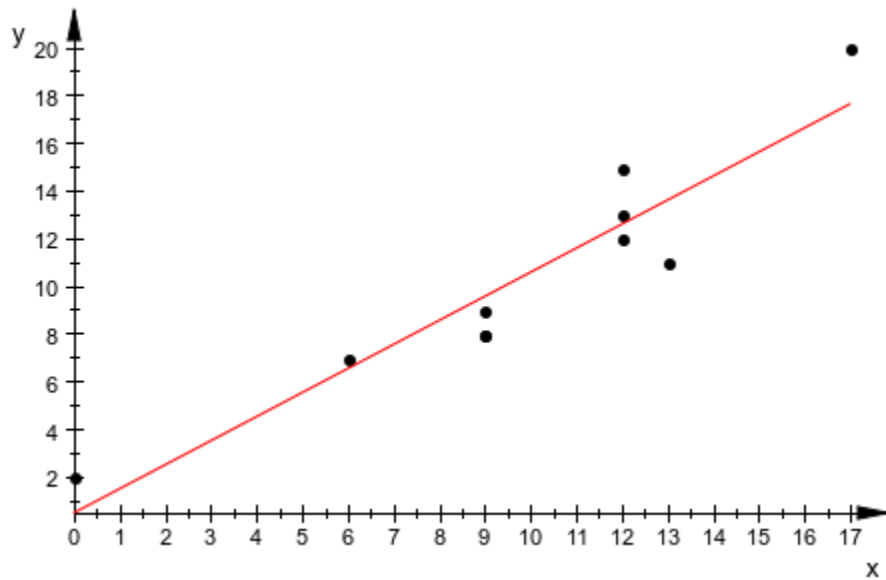

We can modify the appearance of the scatter plot in various ways:

```
b::PointColor := RGB::Red:  
b::PointSize := 3*unit::mm:  
b::LineColor := RGB::Black:  
b::LineWidth := 1*unit::mm:  
  
plot(b)
```

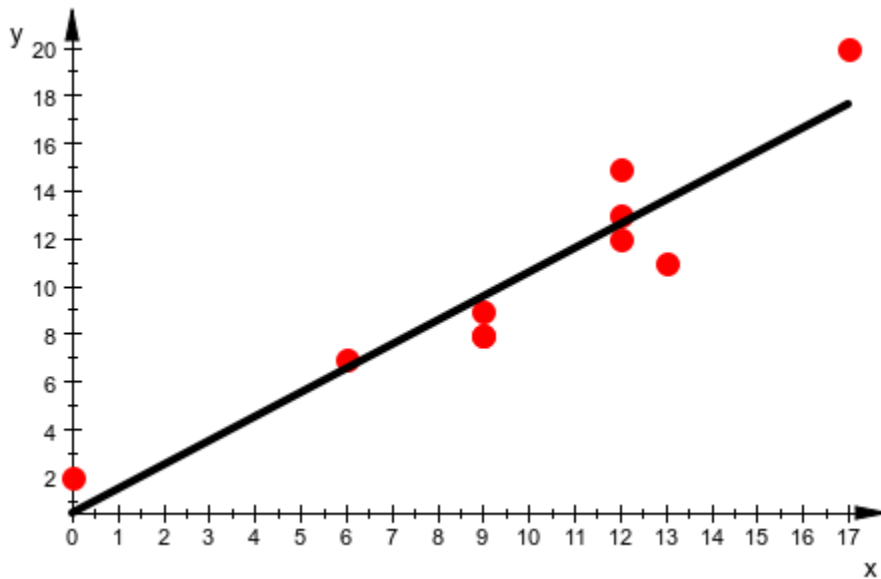

```
delete xdata, ydata, b:
```

## Example 2

We analyze the relationship between the time students spent on preparing for a test and the result of the test. We collect the data in a matrix. Each row corresponds to a student. The first column describes the numbers of hours spent for the preparation, the second column contains the corresponding test score (points out of 100):

```
TimesAndScores := matrix([[ 1, 61],  
                          [10, 75],  
                          [ 4, 55],  
                          [ 3, 18],  
                          [ 4, 77],  
                          [ 6, 72],  
                          [ 3, 18],  
                          [ 1, 25],  
                          [ 0, 50],  
                          [ 4, 68],  
                          [ 4, 68],  
                          [ 8, 87],
```



```
[9, 74],  
[11, 79],  
[6, 28],  
[4, 65],  
[7, 52],  
[8, 78],  
[2, 36],  
[3, 48],  
[4, 39]  
):
```

We draw a scatter plot to identify a possible relationship between the two variables:

```
plot(plot::Scatterplot(TimesAndScores))
```

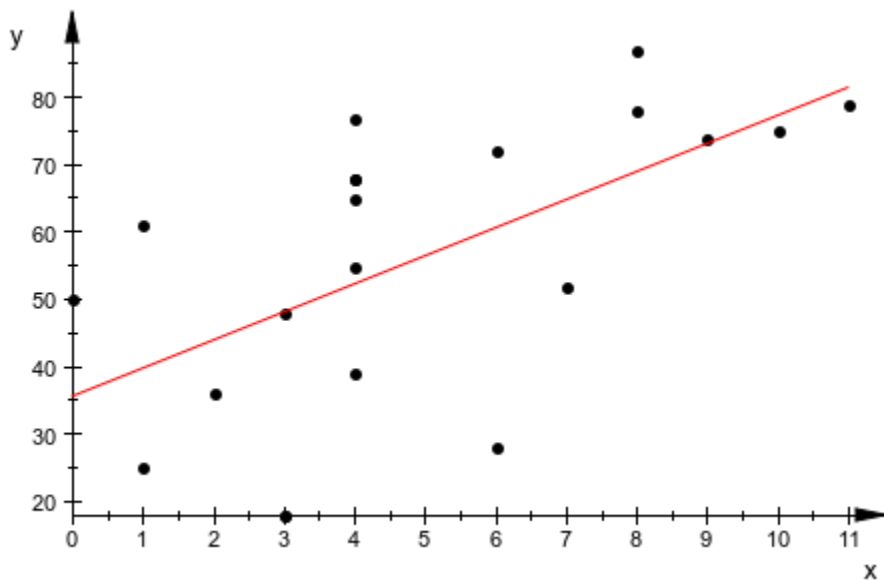

There seems to be a relationship, indeed.

```
delete TimesAndScores:
```

## Parameters

$x_1, y_1, x_2, y_2, \dots$

The statistical data: numerical real values or arithmetical expressions (Symbolic Math Toolbox) of the animation parameter  $a$ .

$x_1, y_1, x_2, y_2, \dots$  is equivalent to the attribute `Data`.

**A**

An array of domain type `DOM_ARRAY` or a matrix of category `Cat::Matrix` (e.g., of type `matrix` or `densematrix`) providing numerical real values or arithmetical expressions (Symbolic Math Toolbox) of the animation parameter  $a$ . The  $i$ -th row is regarded as the data point  $(x_i, y_i)$ . The array/matrix must have 2 columns. If more columns are provided, the superfluous columns are ignored.

`A` is equivalent to the attribute `Data`.

**s**

A data collection of domain type `stats::sample`. The columns in `s` are regarded as  $x$ - and  $y$ -values, respectively.

`s` is equivalent to the attribute `Data`.

**c<sub>1</sub>, c<sub>2</sub>**

Column indices into `s`: positive integers. These indices, if given, indicate that only the specified columns in `s` should be used. If no column indices are specified, the first two columns in `s` are used as  $x$  and  $y$ -values, respectively.

**a**

Animation parameter, specified as  $a = a_{\min} \dots a_{\max}$ , where  $a_{\min}$  is the initial parameter value, and  $a_{\max}$  is the final parameter value.

## See Also

### MuPAD Functions

`plot` | `plot::copy` | `stats::correlation` | `stats::linReg`

**MuPAD Graphical Primitives**

plot::Bars2d | plot::Bars3d | plot::Boxplot | plot::Histogram2d |  
plot::Listplot

## plot::Sequence

Sequences

### Syntax

```
plot::Sequence(y, n = n_1 .. n_2, <a = a_min .. a_max>, options)
```

```
plot::Sequence(x, y, n = n_1 .. n_2, <a = a_min .. a_max>, options)
```

### Description

`plot::Sequence(y(n), n = n_1 .. n_2 )` creates the points

$$(n_1, y(n_1)), (n_1 + 1, y(n_1 + 1)), \dots, (n_2, y(n_2))$$

`plot::Sequence(x(n), y(n), n = n_1 .. n_2 )` creates the sequence of points

$$(x(n_1), y(n_1)), (x(n_1 + 1), y(n_1 + 1)), \dots, (x(n_2), y(n_2))$$

`plot::Sequence` creates graphs of sequences, i.e., functions and curves defined over (some subset of) the integers.

`plot::Sequence(y(n), n = n_1 .. n_2 )` is functionally equivalent to the call `plot::PointList2d([[n, y(n)] $ n = n_1 .. n_2 ])`, and `plot::Sequence(x(n), y(n), n = n_1 .. n_2 )` creates the same image as `plot::PointList2d([[x(n), y(n)] $ n = n_1 .. n_2 ])`. See “Example 2” on page 24-728 (Symbolic Math Toolbox) for some extra functionality.

## Attributes

Attribute	Purpose	Default Value
AffectViewingBox	influence of objects on the ViewingBox of a scene	TRUE
AntiAliased	antialiased lines and points?	TRUE
Color	the main color	RGB::Blue
Frames	the number of frames in an animation	50
Legend	makes a legend entry	
LegendText	short explanatory text for legend	
LegendEntry	add this object to the legend?	FALSE
LineColor	color of lines	RGB::Blue
LineWidth	width of lines	0.35
LineColor2	color of lines	RGB::DeepPink
LineStyle	solid, dashed or dotted lines?	Solid
LinesVisible	visibility of lines	FALSE
LineColorType	line coloring types	Flat
LineColorFunction	functional line coloring	
Name	the name of a plot object (for browser and legend)	
ParameterEnd	end value of the animation parameter	
ParameterName	name of the animation parameter	
ParameterBegin	initial value of the animation parameter	
ParameterRange	range of the animation parameter	

<b>Attribute</b>	<b>Purpose</b>	<b>Default Value</b>
PointSize	the size of points	2
PointStyle	the presentation style of points	FilledCircles
PointsVisible	visibility of mesh points	TRUE
TimeEnd	end time of the animation	10.0
TimeBegin	start time of the animation	0.0
TimeRange	the real time span of an animation	0.0 .. 10.0
Title	object title	
TitleFont	font of object titles	[" sans-serif ", 11]
TitlePosition	position of object titles	
TitleAlignment	horizontal alignment of titles w.r.t. their coordinates	Center
TitlePositionX	position of object titles, x component	
TitlePositionY	position of object titles, y component	
UMax	final value of parameter "u"	
UMin	initial value of parameter "u"	
UName	name of parameter "u"	
URange	range of parameter "u"	
Visible	visibility	TRUE
VisibleAfter	object visible after this time value	
VisibleBefore	object visible until this time value	
VisibleFromTo	object visible during this time range	

Attribute	Purpose	Default Value
VisibleAfterEnd	object visible after its animation time ended?	TRUE
VisibleBeforeBegin	object visible before its animation time starts?	TRUE
XFunction	function for x values	
YFunction	function for y values	

## Examples

### Example 1

When given one expression and a range, `plot::Sequence` plots the sequence in function style:

```
plot(plot::Sequence((-1)^n/n, n=1..10))
```

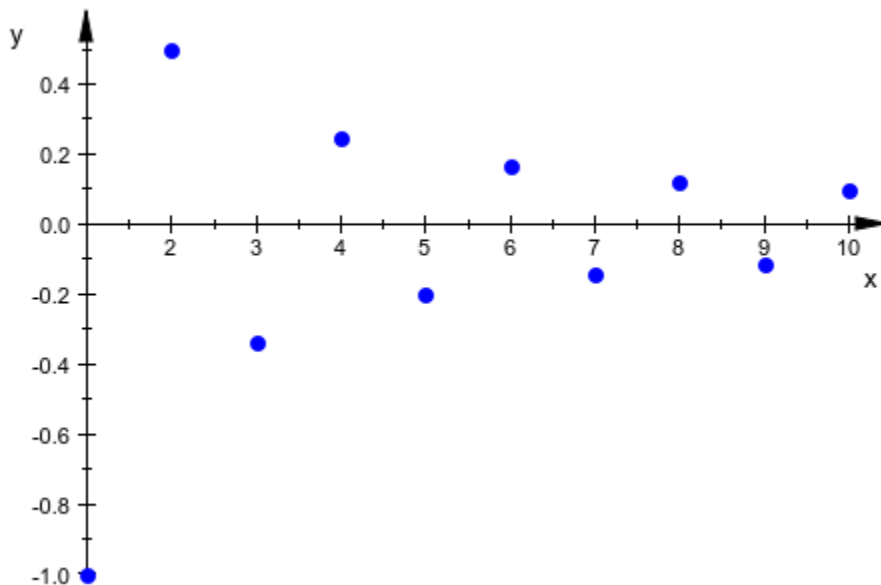

`plot::Sequence` accepts a variety of attributes to influence the appearance of the plot:

```
plot(plot::Sequence((-1)^n/n, n=1..10,
  PointStyle = FilledDiamonds,
  PointSize = 4*unit::mm,
  Color = RGB::Red),
  plot::Sequence(1/n, n=1..10,
  PointsVisible = FALSE,
  LinesVisible = TRUE),
  plot::Sequence(-1/n, n=1..10,
  PointsVisible = FALSE,
  LinesVisible = TRUE))
```

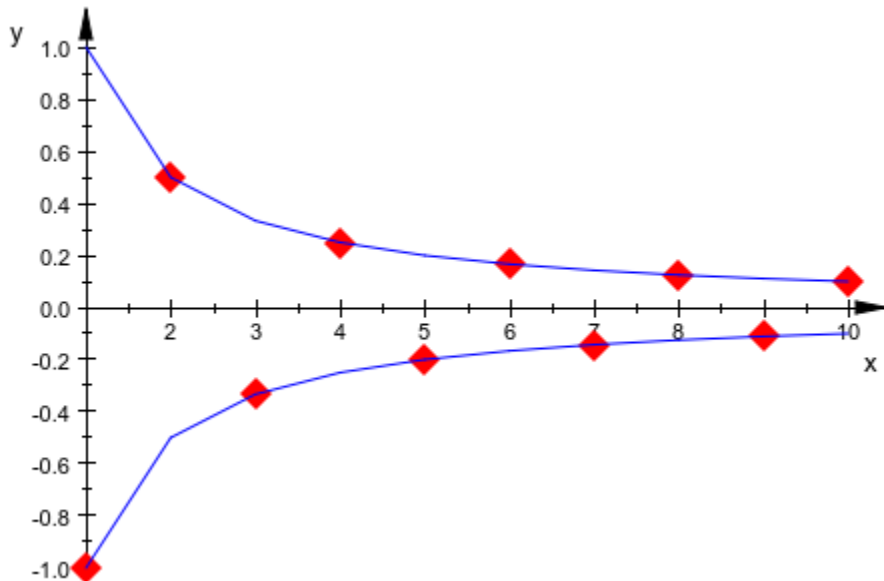

## Example 2

By giving two expressions, we can make `plot::Sequence` plot a sequence of points given by two expressions, for the x- and y-coordinate:

```
plot(plot::Sequence(sin(2*PI*n/60), cos(2*PI*n/60),
  n = 1..60), Scaling=Constrained)
```



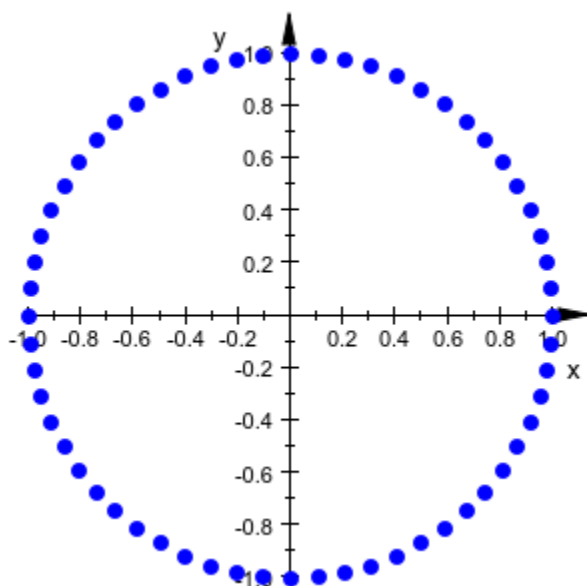

In contrast to the `plot::PointList2d` call listed above as equivalent, `plot::Sequence` allows to easily animate the number of points:

```
plot(plot::Sequence(sin(2*PI*n/60), cos(2*PI*n/60),  
                    n = 1..nmax, nmax = 1.60),  
      Scaling=Constrained, Frames = 60, TimeRange = 1..60)
```

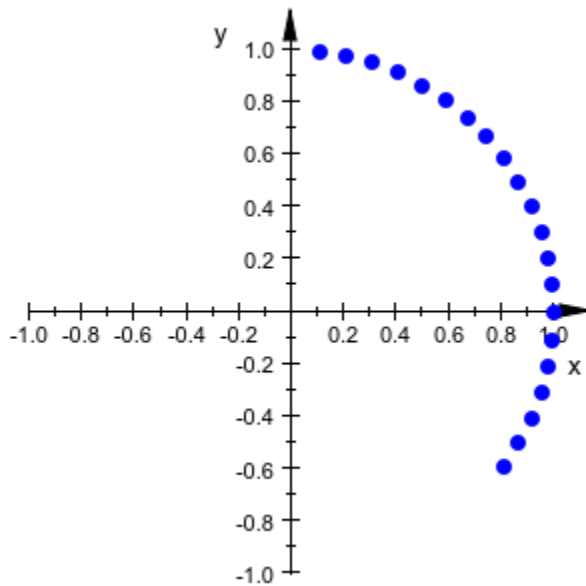

### Example 3

By including the animation parameter in the expressions  $x$  and  $y$ , more complex animations are possible. As an example, we animate Newton iteration for different starting values. First of all, we define the iteration step which maps an approximation to its refinement:

```
newton := x -> x - f(x)/f'(x):
```

For concrete calculations, we will need to use a specific function  $f$ :

```
f := x -> sin(2*x) + x^2:
```

To get successive iteration steps, we will employ the function iteration operator `@@`. For example, the third improvement of the starting value  $1.0$  is calculated as follows:

```
(newton@@3)(1.0)
```

```
- 1.064963748
```

For our animation, we want to show the approximations, the corresponding function values, and the order in which the approximations are found. Additionally, we display the function itself:

```
function := plot::Function2d(f, x = -2..2):
steps := plot::Sequence((newton@@n)(x0), f((newton@@n)(x0)),
    n = 0..5, x0 = -1.25..1.5,
    Color = RGB::Green,
    LinesVisible = TRUE):
plot(function, steps,
    ViewingBox = [-2..2, -1..5], PointSize = 2.5)
```

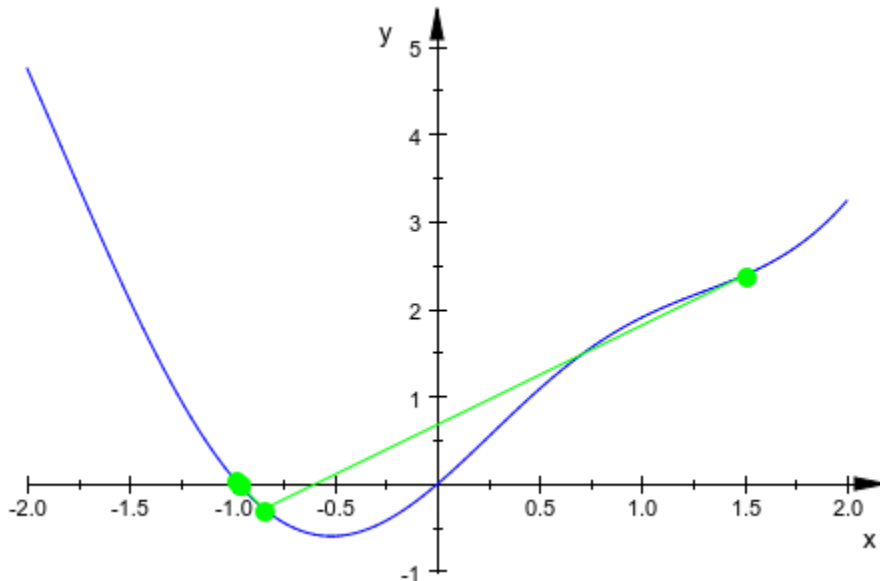

To further increase the number of iteration steps, we should reuse previously computed approximations. To this end, we use a function with option `remember`:

```
newtonIter := proc(x0, n)
    option remember;
    begin
        if domtype(n) <> DOM_INT then
            return(procname(args()));
        end_if;
        if iszero(n) then x0
```

```
        else newton(newtonIter(x0, n-1));  
        end_if;  
    end_proc;
```

Additionally, we use `plot::Point2d` to display the initial point in a different color.

```
steps := plot::Sequence(newtonIter(x0, n), f(newtonIter(x0, n)),  
    n = 0..10, x0 = -1.25..1.5,  
    Color = RGB::Green,  
    LinesVisible = TRUE);  
start := plot::Point2d(x0, f(x0), x0 = -1.25..1.5):  
plot(function, steps, start,  
    ViewingBox = [-2..2, -1..5], PointSize = 2.5)
```

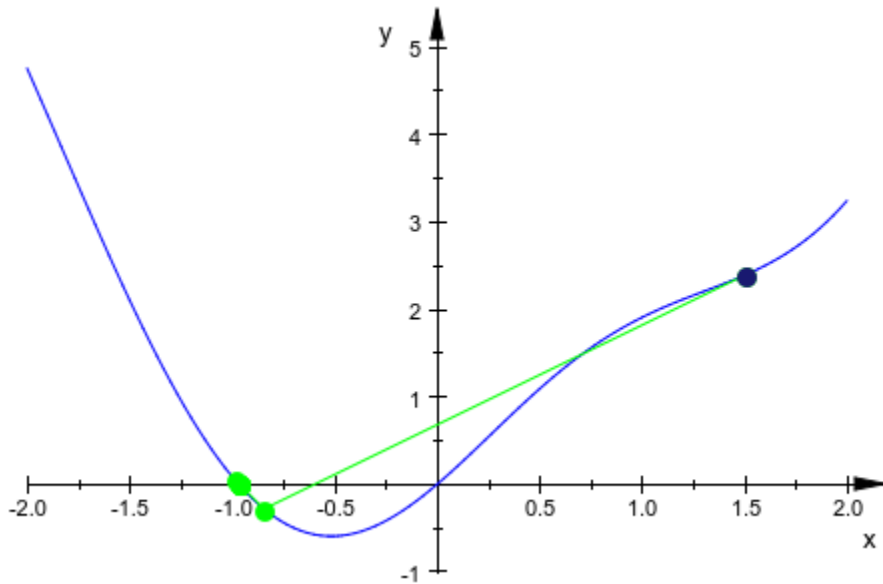

Since `f` was evaluated in our object definitions, we will need to reissue the corresponding commands when changing `f`.

## Parameters

### **x, y**

Real-valued arithmetical expressions in  $n$  and possibly the animation parameter  $a$ .

$x, y$  are equivalent to the attributes XFunction, YFunction.

### **n**

The index of the sequence: an identifier on page 7-29 or an indexed identifier on page 1-1017.

$n$  is equivalent to the attribute UName.

### **$n_1 \dots n_2$**

The range of the index  $n$ : real-valued expressions, possibly of the animation parameter  $a$ .

$n_1 \dots n_2$  is equivalent to the attributes URange, UMin, UMax.

### **a**

Animation parameter, specified as  $a = a_{\min} \dots a_{\max}$ , where  $a_{\min}$  is the initial parameter value, and  $a_{\max}$  is the final parameter value.

## See Also

### **MuPAD Functions**

plot | plot::copy

### **MuPAD Graphical Primitives**

plot::Curve2d | plot::Function2d | plot::PointList2d

## plot::SparseMatrixplot

Sparsity pattern of a matrix

### Syntax

```
plot::SparseMatrixplot(A, options)
```

```
plot::SparseMatrixplot(A, x = xmin .. xmax, y = ymin .. ymax, <a = amin .. amax>, options)
```

```
plot::SparseMatrixplot([row1, row2, ...], options)
```

```
plot::SparseMatrixplot([row1, row2, ...], x = xmin .. xmax, y = ymin .. ymax, <a = amin .. amax>, options)
```

### Description

`plot::SparseMatrixplot(A)` creates a 2D plot with the axes representing the rows and columns of the matrix  $A$ . For each nonzero entry of  $A$  a point is plotted, thus displaying sparsity patterns in the matrix.

`plot::SparseMatrixplot` interprets the indices of a matrix as  $x$  and  $y$  coordinates, respectively. The indices are ordered according to the standard orientation of the axes, i.e., low matrix indices are found in the lower left corner of the plot.

If  $x = x_{\min} .. x_{\max}$  is specified, the  $j$ -th column of an  $m \times n$  matrix  $A$  corresponds to the

coordinate  $x = x_{\min} + \frac{(j-1)}{(n-1)} (x_{\max} - x_{\min})$ .

If  $y = y_{\min} .. y_{\max}$  is specified, the  $i$ -th row corresponds to the coordinate

$y = y_{\min} + \frac{(i-1)}{(m-1)} (y_{\max} - y_{\min})$ .

If no coordinate range is specified,  $x_{\min} = 1$ ,  $x_{\max} = n$ , and  $y_{\min} = 1$ ,  $y_{\max} = m$  is used, i.e., the coordinate  $x = j$  corresponds to the  $j$ -th column, the coordinate  $y = i$  corresponds to the  $i$ -th row.

A point is plotted for each non-zero matrix entry  $A_{ij}$ .

By default, the attribute `PointColorType = Flat` is used. The color of all points is given by `PointColor`.

With `PointColorType = Dichromatic`, a color blend from `PointColor` to `PointColor2` is used to indicate the size of the non-zero matrix entries. The color of points corresponding to small entries  $A_{ij}$  is `PointColor`. Large entries are colored with `PointColor2`.

Animations are triggered by specifying a range  $a = a_{\min} \dots a_{\max}$  for a parameter  $a$  that is different from the variables  $x, y$ . Thus, in animations, both the ranges  $x = x_{\min} \dots x_{\max}, y = y_{\min} \dots y_{\max}$  as well as the animation range  $a = a_{\min} \dots a_{\max}$  must be specified.

## Attributes

Attribute	Purpose	Default Value
<code>AffectViewingBox</code>	influence of objects on the <code>ViewingBox</code> of a scene	TRUE
<code>AntiAliased</code>	antialiased lines and points?	TRUE
<code>Color</code>	the main color	<code>RGB::MidnightBlue</code>
<code>Data</code>	the (statistical) data to plot	
<code>Frames</code>	the number of frames in an animation	50
<code>Legend</code>	makes a legend entry	
<code>LegendText</code>	short explanatory text for legend	
<code>LegendEntry</code>	add this object to the legend?	FALSE
<code>Name</code>	the name of a plot object (for browser and legend)	
<code>ParameterEnd</code>	end value of the animation parameter	
<code>ParameterName</code>	name of the animation parameter	

<b>Attribute</b>	<b>Purpose</b>	<b>Default Value</b>
ParameterBegin	initial value of the animation parameter	
ParameterRange	range of the animation parameter	
PointSize	the size of points	1.0
PointColor	the color of points	RGB::MidnightBlue
PointColor2	secondary point color for color blends	RGB::Red
PointStyle	the presentation style of points	Diamonds
PointsVisible	visibility of mesh points	TRUE
PointColorType	point coloring types	Flat
TimeEnd	end time of the animation	10.0
TimeBegin	start time of the animation	0.0
TimeRange	the real time span of an animation	0.0 .. 10.0
Title	object title	
TitleFont	font of object titles	[" sans-serif ", 11]
TitlePosition	position of object titles	
TitleAlignment	horizontal alignment of titles w.r.t. their coordinates	Center
TitlePositionX	position of object titles, x component	
TitlePositionY	position of object titles, y component	
Visible	visibility	TRUE
VisibleAfter	object visible after this time value	
VisibleBefore	object visible until this time value	



Attribute	Purpose	Default Value
VisibleFromTo	object visible during this time range	
VisibleAfterEnd	object visible after its animation time ended?	TRUE
VisibleBeforeBegin	object visible before its animation time starts?	TRUE
XMax	final value of parameter "x"	
XMin	initial value of parameter "x"	
XName	name of parameter "x"	
XRange	range of parameter "x"	
YMax	final value of parameter "y"	
YMin	initial value of parameter "y"	
YName	name of parameter "y"	
YRange	range of parameter "y"	

## Examples

### Example 1

We create a random matrix of dimension  $100 \times 200$  with 1000 nonzero entries:

```
A := matrix::random(100, 200, 1000, frandom):
plot(plot::SparseMatrixplot(A))
```

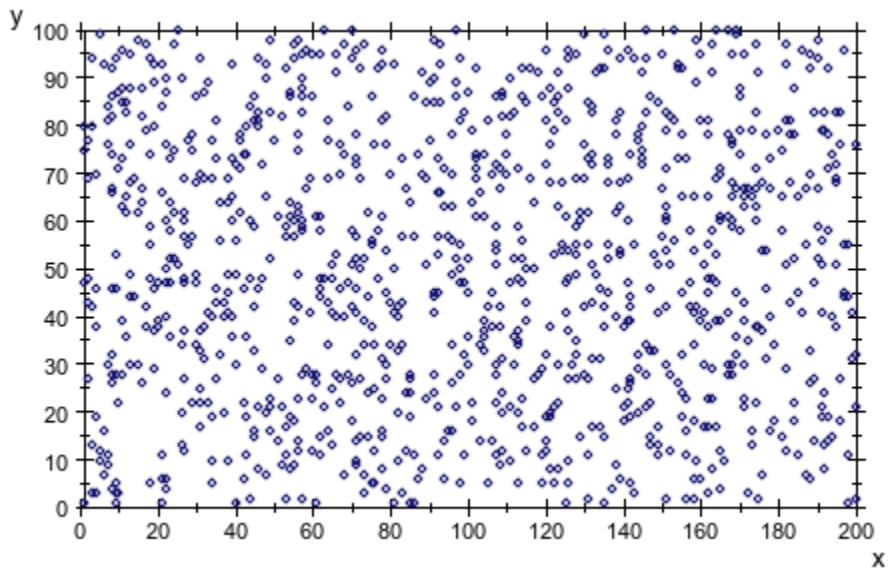

With `PointColorType = Dichromatic`, the color of the points indicates the size of the matrix entries:

```
plot(plot::SparseMatrixplot(A, PointColorType = Dichromatic)):
```

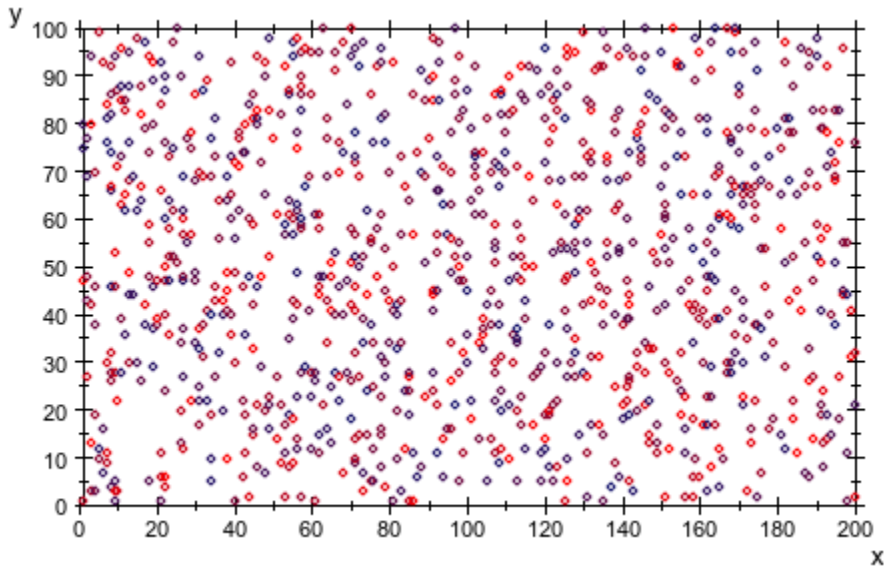

delete A:

## Example 2

Choosing appropriate coordinate ranges, we let two sparse matrix plots overlap each other. The red points correspond to a sparse  $10 \times 10$  matrix with 50 random entries. The blue points indicate the corresponding upper triangular form obtained by Gaussian elimination:

```
A := matrix::random(10, 10, 50, random(1..5)):
B := A::dom::gaussElim(A)[1]:
plot(plot::SparseMatrixplot(A, x = 1..10, y = 1..10,
    Color = RGB::Red),
    plot::SparseMatrixplot(B, x = 1.3..10.3, y = 1..10,
    Color = RGB::Blue,
    PointStyle = FilledCircles),
    PointSize = 2*unit::mm, Scaling = Constrained,
    Axes = Frame)
```

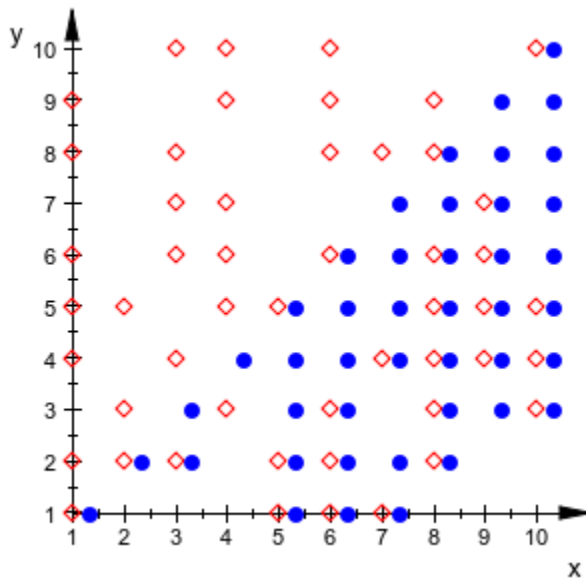

delete A, B:

## Parameters

### A

A matrix on page 1-1340 of category `Cat::Matrix` or an array on page 7-2 containing real numerical values or expressions of the animation parameter `a`.

A is equivalent to the attribute `Data`.

### `row1`, `row2`, ...

The matrix rows: each row must be a list of real numerical values or expressions of the animation parameter `a`. All rows must have the same length.

`row1`, `row2`, ... is equivalent to the attribute `Data`.

**x**

Name of the horizontal coordinate: an identifier on page 7-29 or an indexed identifier on page 1-1017. It is used as the title of the coordinate axis in x direction.

x is equivalent to the attribute XName.

**$x_{\min}$  ..  $x_{\max}$**

The range of the horizontal coordinate:  $x_{\min}$ ,  $x_{\max}$  must be numerical real value or expressions of the animation parameter  $a$ .

$x_{\min}$  ..  $x_{\max}$  is equivalent to the attributes XRange, XMin, XMax.

**y**

Name of the vertical coordinate: an identifier on page 7-29 or an indexed identifier on page 1-1017. It is used as the title of the coordinate axis in y direction.

y is equivalent to the attribute YName.

**$y_{\min}$  ..  $y_{\max}$**

The range of the vertical coordinate:  $y_{\min}$ ,  $y_{\max}$  must be numerical real value or expressions of the animation parameter  $a$ .

$y_{\min}$  ..  $y_{\max}$  is equivalent to the attributes YRange, YMin, YMax.

**a**

Animation parameter, specified as  $a = a_{\min} .. a_{\max}$ , where  $a_{\min}$  is the initial parameter value, and  $a_{\max}$  is the final parameter value.

## See Also

**MuPAD Functions**

plot | plot::copy

**MuPAD Graphical Primitives**

plot::Density | plot::Matrixplot | plot::Raster

## plot::Sphere

Graphical primitive for spheres

### Syntax

```
plot::Sphere(r, <[cx, cy, cz]>, <a = amin .. amax>, options)
```

### Description

`plot::Sphere(r, c)` creates a sphere of radius `r` and center `c`.

### Attributes

Attribute	Purpose	Default Value
AffectViewingBox	influence of objects on the ViewingBox of a scene	TRUE
Center	center of objects, rotation center	[0, 0, 0]
CenterX	center of objects, rotation center, x-component	0
CenterY	center of objects, rotation center, y-component	0
CenterZ	center of objects, rotation center, z-component	0
Color	the main color	RGB::LightBlue
FillColor	color of areas and surfaces	RGB::LightBlue
Frames	the number of frames in an animation	50
Legend	makes a legend entry	

<b>Attribute</b>	<b>Purpose</b>	<b>Default Value</b>
LegendText	short explanatory text for legend	
LegendEntry	add this object to the legend?	FALSE
Name	the name of a plot object (for browser and legend)	
ParameterEnd	end value of the animation parameter	
ParameterName	name of the animation parameter	
ParameterBegin	initial value of the animation parameter	
ParameterRange	range of the animation parameter	
Radius	radius of circles, spheres etc.	1
Shading	smooth color blend of surfaces	Smooth
TimeEnd	end time of the animation	10.0
TimeBegin	start time of the animation	0.0
TimeRange	the real time span of an animation	0.0 .. 10.0
Title	object title	
TitleFont	font of object titles	[" sans-serif ", 11]
TitlePosition	position of object titles	
TitleAlignment	horizontal alignment of titles w.r.t. their coordinates	Center
TitlePositionX	position of object titles, x component	
TitlePositionY	position of object titles, y component	

Attribute	Purpose	Default Value
TitlePositionZ	position of object titles, z component	
Visible	visibility	TRUE
VisibleAfter	object visible after this time value	
VisibleBefore	object visible until this time value	
VisibleFromTo	object visible during this time range	
VisibleAfterEnd	object visible after its animation time ended?	TRUE
VisibleBeforeBegin	object visible before its animation time starts?	TRUE

## Examples

### Example 1

Create a blue sphere with center (9, 9, 9) and radius 3:

```
s := plot::Sphere(3, [9, 9, 9], Color = RGB::Blue)
```

```
plot::Sphere(3, [9, 9, 9])
```

Call plot to plot the sphere:

```
plot(s)
```



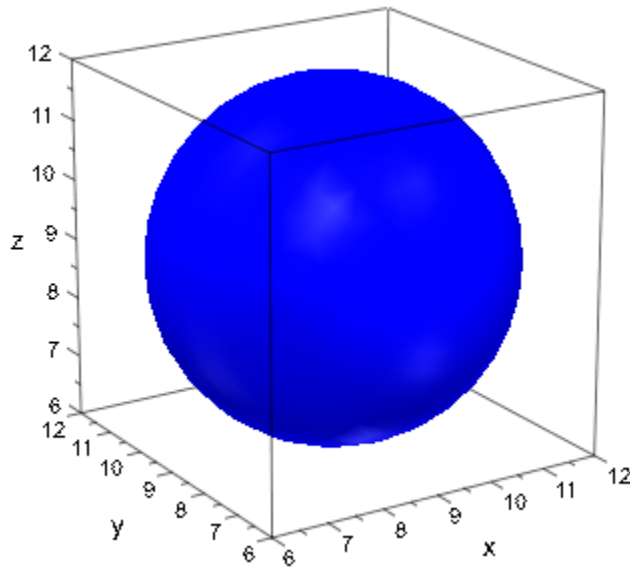

delete s:

## Example 2

Create a sphere with center  $(-1, -1, 5)$  and radius 3. At two points on the sphere, add 3D discs indicating the tangent planes.

```
c := [-1, -1, 3]:
s := plot::Sphere(3, c):
p1 := [ 1, -3, 4]:
p2 := [-3, -2, 1]:
```

The discs are created via `plot::Circle3d` as filled 3D circles of radius 2.5, centered at the points  $p_1$  and  $p_2$ , respectively. The normals  $n_i$  are given by  $p_i - c$ . Compute them by subtracting the center  $c$  from the points  $p_i$  via `zip`:

```
n1 := zip(p1, c, _subtract):
n2 := zip(p2, c, _subtract):
t1 := plot::Circle3d(2.5, p1, n1, Filled = TRUE,
                    LineColor = RGB::Black,
                    FillColor = RGB::Red.[0.5]):
```

```
t2 := plot::Circle3d(2.5, p2, n2, Filled = TRUE,
                    LineColor = RGB::Black,
                    FillColor = RGB::Red.[0.5]):
```

Finally, convert the points  $p_i$  to graphical points and add them to the plot:

```
p1 := plot::Point3d(p1, PointColor = RGB::Red,
                    PointSize = 2*unit::mm):
p2 := plot::Point3d(p2, PointColor = RGB::Red,
                    PointSize = 2*unit::mm):
plot(s, p1, p2, t1, t2)
```

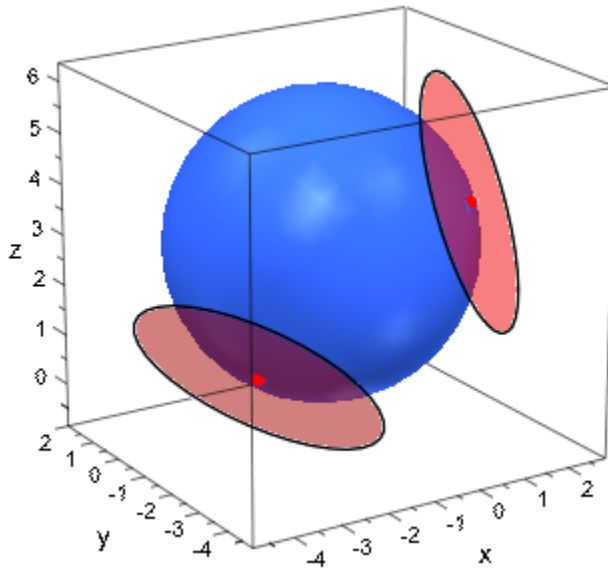

```
delete c, s, p1, p2, n1, n2, t1, t2:
```

### Example 3

Consider the same sphere as in the previous example:

```
radius := 3: center := [-1, -1, 5]:
s := plot::Sphere(radius, center):
```

Using spherical coordinates, define a curve on the sphere:

```

phi := a -> PI*sin(7*a):
thet := a -> PI/2 + 1.3*sin(5*a):
x := a -> center[1] + radius*cos(phi(a))*sin(thet(a)):
y := a -> center[2] + radius*sin(phi(a))*sin(thet(a)):
z := a -> center[3] + radius*cos(thet(a)):

```

The curve  $c$  is defined as an object of type `plot::Curve3d`. Further, define an animated point  $p$  that runs along the curve. An animated filled disc of type `plot::Circle3d` indicating the tangent plane at the point  $p$  as well as the corresponding normal are added to the plot:

```

c := plot::Curve3d([x(t), y(t), z(t)], t = 0..2*PI,
                  Mesh = 1000, Color = RGB::Black):
p := a -> [x(a), y(a), z(a)]:
n := a -> zip([x(a), y(a), z(a)], center, _subtract):
d := plot::Circle3d(2.5, p(a), n(a), a = 0..2*PI, Filled = TRUE,
                  FillColor = RGB::BlueLight.[0.5],
                  LinesVisible = FALSE):
n := plot::Arrow3d(p(a), [p(a)[i] + n(a)[i]/2 $ i=1..3],
                  a = 0..2*PI, TipLength = 0.8*unit::mm):
p := plot::Point3d(p(a), a = 0..2*PI, PointColor = RGB::Black,
                  PointSize = 2*unit::mm):

plot(s, c, p, n, d, Frames = 200, TimeEnd = 50):

```

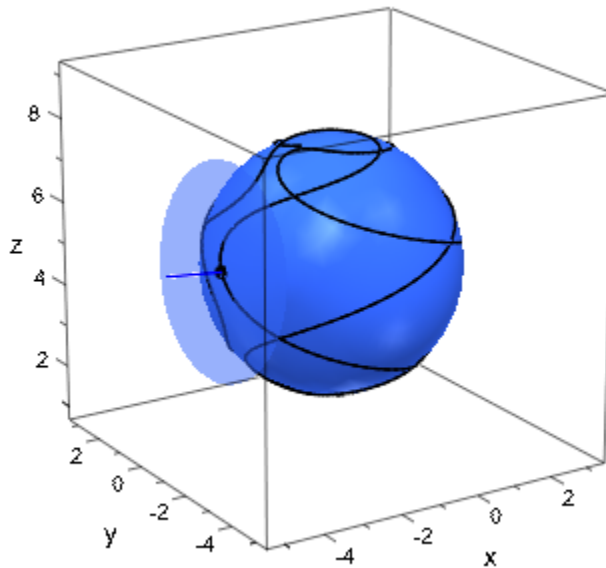

delete radius, center, s, phi, thet,  
x, y, z, c, p, n, d:

## Parameters

**r**

The radius of the sphere: a real numerical value or an arithmetical expression (Symbolic Math Toolbox) of the animation parameter **a**.

**r** is equivalent to the attribute **Radius**.

**c<sub>x</sub>, c<sub>y</sub>, c<sub>z</sub>**

The coordinates of the center: real numerical values or arithmetical expressions (Symbolic Math Toolbox) of the animation parameter **a**. If no center is specified, a sphere/ellipsoid centered at the origin is created.

**c<sub>x</sub>, c<sub>y</sub>, c<sub>z</sub>** are equivalent to the attributes **Center, CenterX, CenterY, CenterZ**.

**a**

Animation parameter, specified as  $a = a_{\min} .. a_{\max}$ , where  $a_{\min}$  is the initial parameter value, and  $a_{\max}$  is the final parameter value.

## See Also

**MuPAD Functions**

plot | plot::copy

**MuPAD Graphical Primitives**

plot::Circle3d | plot::Ellipsoid | plot::Surface

## plot::Ellipsoid

Graphical primitive for ellipsoids

### Syntax

```
plot::Ellipsoid( $r_x$ ,  $r_y$ ,  $r_z$ , <[ $c_x$ ,  $c_y$ ,  $c_z$ ]>, < $a = a_{\min} \dots a_{\max}$ >, options)
```

### Description

`plot::Ellipsoid( $r_x$ ,  $r_y$ ,  $r_z$ ,  $c$ )` creates an ellipsoid with the center  $c$  and symmetry axes parallel to the coordinate axes. The semi axes have the lengths  $r_x$ ,  $r_y$ ,  $r_z$ .

Ellipsoids with arbitrary orientations of the symmetry axes can be generated via `plot::Rotate3d`.

### Attributes

Attribute	Purpose	Default Value
AffectViewingBox	influence of objects on the ViewingBox of a scene	TRUE
Center	center of objects, rotation center	[0, 0, 0]
CenterX	center of objects, rotation center, x-component	0
CenterY	center of objects, rotation center, y-component	0
CenterZ	center of objects, rotation center, z-component	0
Color	the main color	RGB::LightBlue
FillColor	color of areas and surfaces	RGB::LightBlue

<b>Attribute</b>	<b>Purpose</b>	<b>Default Value</b>
Frames	the number of frames in an animation	50
Legend	makes a legend entry	
LegendText	short explanatory text for legend	
LegendEntry	add this object to the legend?	FALSE
Name	the name of a plot object (for browser and legend)	
ParameterEnd	end value of the animation parameter	
ParameterName	name of the animation parameter	
ParameterBegin	initial value of the animation parameter	
ParameterRange	range of the animation parameter	
SemiAxes	semi axes of ellipses and ellipsoids	[1, 2, 3]
SemiAxisX	first semi axis of ellipses and ellipsoids	1
SemiAxisY	second semi axis of ellipses and ellipsoids	2
SemiAxisZ	third semi axis of ellipsoids	3
Shading	smooth color blend of surfaces	Smooth
TimeEnd	end time of the animation	10.0
TimeBegin	start time of the animation	0.0
TimeRange	the real time span of an animation	0.0 .. 10.0
Title	object title	

Attribute	Purpose	Default Value
TitleFont	font of object titles	[" sans-serif ", 11]
TitlePosition	position of object titles	
TitleAlignment	horizontal alignment of titles w.r.t. their coordinates	Center
TitlePositionX	position of object titles, x component	
TitlePositionY	position of object titles, y component	
TitlePositionZ	position of object titles, z component	
Visible	visibility	TRUE
VisibleAfter	object visible after this time value	
VisibleBefore	object visible until this time value	
VisibleFromTo	object visible during this time range	
VisibleAfterEnd	object visible after its animation time ended?	TRUE
VisibleBeforeBegin	object visible before its animation time starts?	TRUE

## Examples

### Example 1

Create a blue ellipsoid around the origin with semi axes of lengths 1, 2, 3:

```
plot(plot::Ellipsoid(1, 2, 3, [0, 0, 0]))
```



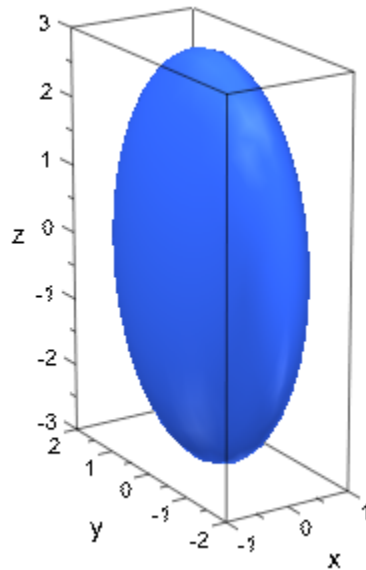

delete s:

## Parameters

$r_x$ ,  $r_y$ ,  $r_z$

The length of the semi axes of the ellipsoid: real numerical values or arithmetical expressions (Symbolic Math Toolbox) of the animation parameter  $a$ .

$r_x$ ,  $r_y$ ,  $r_z$  are equivalent to the attributes `SemiAxes`, `SemiAxisX`, `SemiAxisY`, `SemiAxisZ`.

$c_x$ ,  $c_y$ ,  $c_z$

The coordinates of the center: real numerical values or arithmetical expressions (Symbolic Math Toolbox) of the animation parameter  $a$ . If no center is specified, a sphere/ellipsoid centered at the origin is created.

$c_x$ ,  $c_y$ ,  $c_z$  are equivalent to the attributes `Center`, `CenterX`, `CenterY`, `CenterZ`.

**a**

Animation parameter, specified as  $\mathbf{a} = \mathbf{a}_{\min} \dots \mathbf{a}_{\max}$ , where  $\mathbf{a}_{\min}$  is the initial parameter value, and  $\mathbf{a}_{\max}$  is the final parameter value.

## See Also

### MuPAD Functions

`plot` | `plot::copy`

### MuPAD Graphical Primitives

`plot::Circle3d` | `plot::Sphere` | `plot::Surface`

# plot::Spherical

Surfaces in 3D parameterized in spherical coordinates

## Syntax

```
plot::Spherical([r,  $\phi$ ,  $\theta$ ], u = umin .. umax, v = vmin .. vmax, <a = amin .. amax>, options)
```

## Description

plot::Spherical creates surfaces parametrized in spherical coordinates.

The surface given by a mapping (“parametrization”)  $(u, v) \rightarrow (r(u, v), \phi(u, v), \theta(u, v))$  is the set of all image points

$$\left\{ \begin{pmatrix} r(u, v) \\ \phi(u, v) \\ \theta(u, v) \end{pmatrix} \middle| u \in [u_{\min}, u_{\max}], v \in [v_{\min}, v_{\max}] \right\}$$

in spherical coordinates, which translate to the usual “Cartesian” coordinates as

$$x = r \cos(\phi) \sin(\theta)$$

$$y = r \sin(\phi) \sin(\theta)$$

$$z = r \cos(\theta)$$

$r$  is referred to as “radius”,  $\phi$  as “azimuthal angle”, and  $\theta$  is known as “polar angle.”

The functions  $r$ ,  $\phi$ ,  $\theta$  are evaluated on a regular equidistant mesh of sample points in the  $u$ - $v$  plane. This mesh is determined by the attributes `UMesh`, `VMesh`. By default, the attribute `AdaptiveMesh = 0` is set, i.e., no adaptive refinement of the equidistant mesh is used.

If the standard mesh does not suffice to produce a sufficiently detailed plot, one may either increase the value of `UMesh`, `VMesh` or `USubmesh`, `VSubmesh`, or set

`AdaptiveMesh = n` with some (small) positive integer  $n$ . If necessary, up to  $2^n - 1$  additional points are placed in each direction of the  $u$ - $v$  plane between adjacent points of the initial equidistant mesh. Cf. “Example 3” on page 24-763 (Symbolic Math Toolbox).

“Coordinate lines” (“parameter lines”) are curves on the surface.

The phrase “`ULines`” refers to the curves  $(r(u, v_0), \phi(u, v_0), \theta(u, v_0))$  with the parameter  $u$  running from  $u_{\min}$  to  $u_{\max}$ , while  $v_0$  is some fixed value from the interval  $[v_{\min}, v_{\max}]$ .

The phrase “`VLines`” refers to the curves  $(r(u_0, v), \phi(u_0, v), \theta(u_0, v))$  with the parameter  $v$  running from  $v_{\min}$  to  $v_{\max}$ , while  $u_0$  is some fixed value from the interval  $[u_{\min}, u_{\max}]$ .

By default, the parameter curves are visible. They may be switched off by specifying `ULinesVisible = FALSE` and `VLinesVisible = FALSE`, respectively.

The coordinate lines controlled by `ULinesVisible = TRUE/FALSE` and `VLinesVisible = TRUE/FALSE` indicate the equidistant mesh in the  $u$ - $v$  plane set via the `UMesh`, `VMesh` attributes. If the mesh is refined by the `USubmesh`, `VSubmesh` attributes, or by the adaptive mechanism controlled by `AdaptiveMesh = n`, no additional parameter lines are drawn.

As far as the numerical approximation of the surface is concerned, the settings

`UMesh = nu`, `VMesh = nv`, `USubmesh = mu`, `VSubmesh = mv`

and

`UMesh = (nu - 1) (mu + 1) + 1`, `VMesh = (nv - 1) (mv + 1) + 1`,

`USubmesh = 0`, `VSubmesh = 0`

are equivalent. However, in the first setting,  $n_u$  parameter lines are visible in the  $u$  direction, while in the latter setting  $(n_u - 1)(m_u + 1) + 1$  parameter lines are visible. Cf. “Example 3” on page 24-763 (Symbolic Math Toolbox).

Use `Filled = FALSE` to obtain a wireframe representation of the surface.

If the expression/function  $r$  contains singularities, it is recommended (but not strictly necessary) to use the attribute `ViewingBox` to set a suitable viewing box. No such precautions are necessary for  $\phi$  and  $\theta$ , although singularities in these functions may result in poorly rendered surfaces - in many cases setting the attributes `Mesh` and/or `AdaptiveMesh` to higher values will help. Cf. “Example 6” on page 24-769 (Symbolic Math Toolbox).

## Attributes

Attribute	Purpose	Default Value
AdaptiveMesh	adaptive sampling	0
AffectViewingBox	influence of objects on the ViewingBox of a scene	TRUE
Color	the main color	RGB::Red
Filled	filled or transparent areas and surfaces	TRUE
FillColor	color of areas and surfaces	RGB::Red
FillColor2	second color of areas and surfaces for color blends	RGB::CornflowerBlue
FillColorType	surface filling types	Dichromatic
FillColorFunction	functional area/surface coloring	
FillColorDirection	the direction of color transitions on surfaces	[0, 0, 1]
FillColorDirectionX	x-component of the direction of color transitions on surfaces	0
FillColorDirectionY	y-component of the direction of color transitions on surfaces	0
FillColorDirectionZ	z-component of the direction of color transitions on surfaces	1
Frames	the number of frames in an animation	50
Legend	makes a legend entry	
LegendText	short explanatory text for legend	
LegendEntry	add this object to the legend?	TRUE

<b>Attribute</b>	<b>Purpose</b>	<b>Default Value</b>
LineColor	color of lines	RGB::Black.[0.25]
LineWidth	width of lines	0.35
LineColor2	color of lines	RGB::DeepPink
LineStyle	solid, dashed or dotted lines?	Solid
LineColorType	line coloring types	Flat
LineColorFunction	functional line coloring	
LineColorDirection	the direction of color transitions on lines	[0, 0, 1]
LineColorDirectionX	x-component of the direction of color transitions on lines	0
LineColorDirectionY	y-component of the direction of color transitions on lines	0
LineColorDirectionZ	z-component of the direction of color transitions on lines	1
Mesh	number of sample points	[25, 25]
MeshVisible	visibility of irregular mesh lines in 3D	FALSE
Name	the name of a plot object (for browser and legend)	
ParameterEnd	end value of the animation parameter	
ParameterName	name of the animation parameter	
ParameterBegin	initial value of the animation parameter	
ParameterRange	range of the animation parameter	
PointSize	the size of points	1.5
PointStyle	the presentation style of points	FilledCircles

Attribute	Purpose	Default Value
PointsVisible	visibility of mesh points	FALSE
Submesh	density of submesh (additional sample points)	[0, 0]
TimeEnd	end time of the animation	10.0
TimeBegin	start time of the animation	0.0
TimeRange	the real time span of an animation	0.0 .. 10.0
Title	object title	
TitleFont	font of object titles	[" sans-serif ", 11]
TitlePosition	position of object titles	
TitleAlignment	horizontal alignment of titles w.r.t. their coordinates	Center
TitlePositionX	position of object titles, x component	
TitlePositionY	position of object titles, y component	
TitlePositionZ	position of object titles, z component	
ULinesVisible	visibility of parameter lines (u lines)	TRUE
UMax	final value of parameter "u"	
UMesh	number of sample points for parameter "u"	25
UMin	initial value of parameter "u"	
UName	name of parameter "u"	
URange	range of parameter "u"	
USubmesh	density of additional sample points for parameter "u"	0
VLinesVisible	visibility of parameter lines (v lines)	TRUE

<b>Attribute</b>	<b>Purpose</b>	<b>Default Value</b>
VMax	final value of parameter "v"	
VMesh	number of sample points for parameter "v"	25
VMin	initial value of parameter "v"	
VName	name of parameter "v"	
VRange	range of parameter "v"	
VSubmesh	density of additional sample points for parameter "v"	0
Visible	visibility	TRUE
VisibleAfter	object visible after this time value	
VisibleBefore	object visible until this time value	
VisibleFromTo	object visible during this time range	
VisibleAfterEnd	object visible after its animation time ended?	TRUE
VisibleBeforeBegin	object visible before its animation time starts?	TRUE
XContours	contour lines at constant x values	[]
XFunction	function for x values	
YContours	contour lines at constant y values	[]
YFunction	function for y values	
ZContours	contour lines at constant z values	[]
ZFunction	function for z values	



## Examples

### Example 1

Spherical coordinates get their name from the fact that, with a constant radius, they parameterize a sphere:

```
plot(plot::Spherical([1, u, v], u = 0..2*PI, v = 0..PI))
```

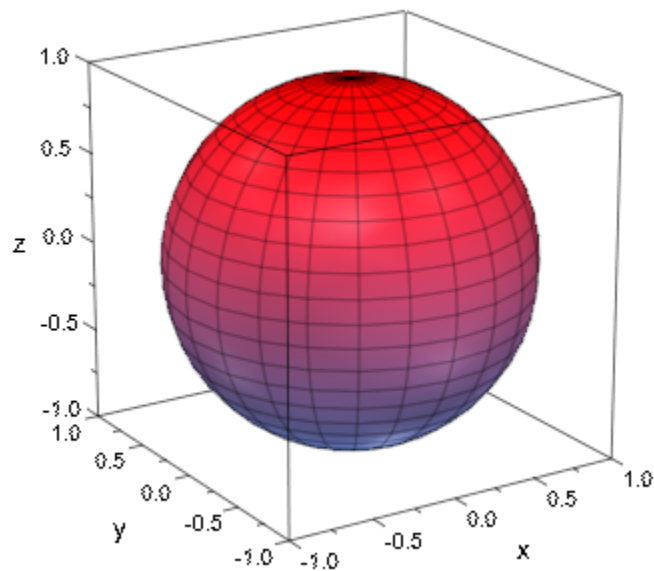

```
plot(plot::Spherical([1, u, v], u = 0..PI, v = 0..2*PI))
```

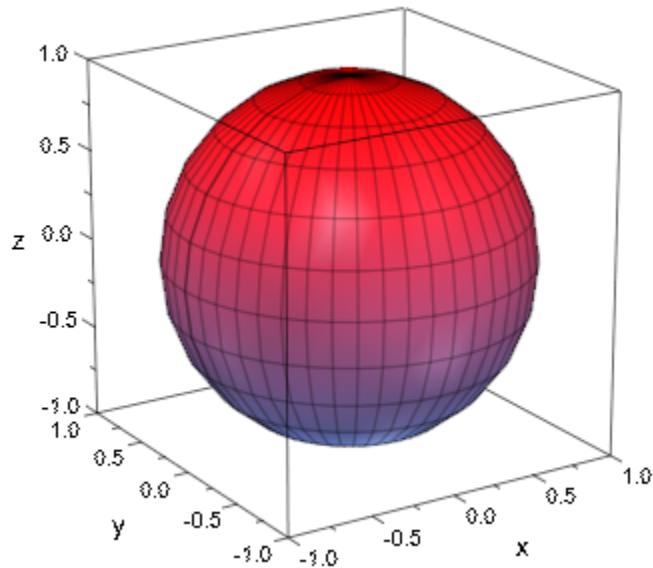

## Example 2

The following plot demonstrates that spherical plots can exhibit singular surface features even with differentiable parameterizations; in this case, the rim in the middle is actually a border of both the left- and the right-hand part:

```
plot(plot::Spherical(  
    [(phi^2*thet), phi, thet^2],  
    phi = -PI..PI, thet=0..0.25*PI,  
    Mesh = [40,40], Submesh=[3,0],  
    Color = [0.9$3], FillColorType=Flat, LineColor=[0.8$3]),  
    Axes = None, CameraDirection = [1, 0, 0])
```

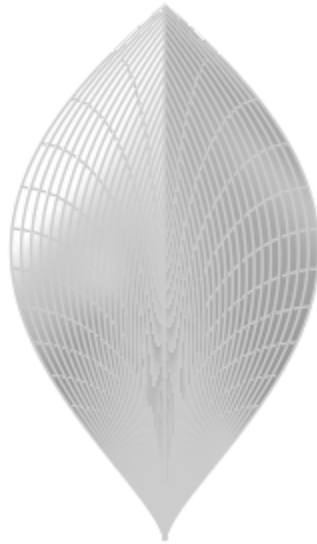

### Example 3

For oscillating parameterizations or other surfaces with fine details, the default mesh may be too coarse. As stated above, the three attributes `Mesh`, `Submesh`, and `AdaptiveMesh` can be used for improving plots of these objects.

First, note that the following plot is not rendered with a sufficient resolution:

```
surf := plot::Spherical([4+sin(5*(u+v)), u, v], u = 0..PI, v = 0..2*PI):  
plot(surf, Axes = None)
```

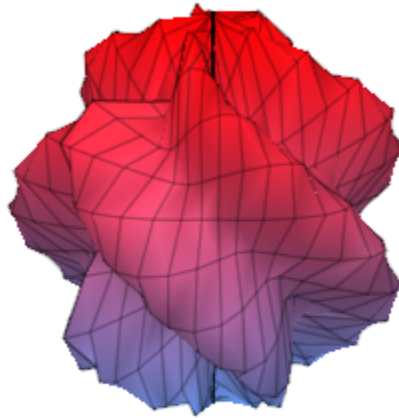

Setting Mesh to twice its default, we get a smoother surface with additional parameter lines:

```
surf::Mesh := [50, 50]:  
plot(surf, Axes = None)
```

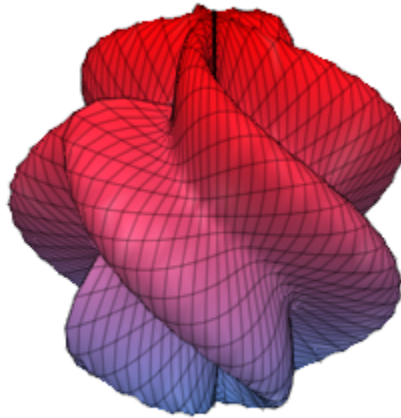

Almost the same effect, but without the additional parameter lines, can be achieved by setting `Submesh = [1, 1]`:

```
delete surf::Mesh:  
surf::Submesh := [1, 1]:  
plot(surf, Axes = None)
```

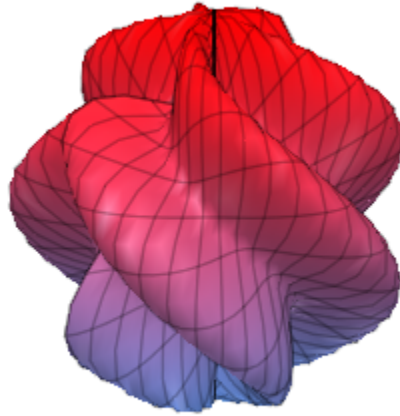

It is also possible to use adaptive mesh refinement in areas where neighboring patches have an angle of more than 10 degrees. While this option is mostly useful for surfaces which require refinement only in some parts, it is certainly feasible with a plot like this, too (but increasing `Submesh` is faster):

```
delete surf::Submesh:  
surf::AdaptiveMesh := 2:  
plot(surf, Axes = None)
```

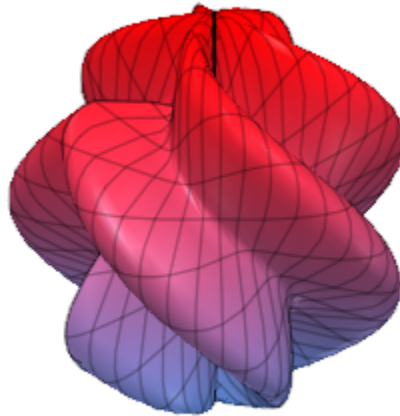

### Example 4

The radius function  $r$  may also take on negative values. With radius functions of changing sign, spherical surfaces often do self-intersect:

```
plot(plot::Spherical(  
  [sin(phi^2*thet), phi, thet],  
  phi = -PI..PI, thet = 0..0.5*PI,  
  Mesh = [40, 20], Submesh=[0, 3]))
```

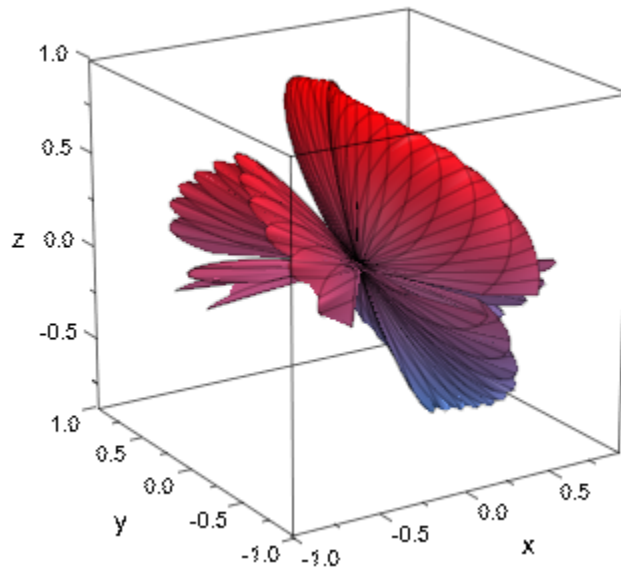

### Example 5

The angular functions ( $\phi$  and  $\theta$ ) are not limited in value:

```
plot(plot::Spherical([r, r, thet], r = 0..9, thet = -PI..PI,  
                    Mesh = [60, 60], Filled = FALSE),  
      Axes = None,  
      plot::Camera([100, 100, 50], [0,0,0], 0.1))
```



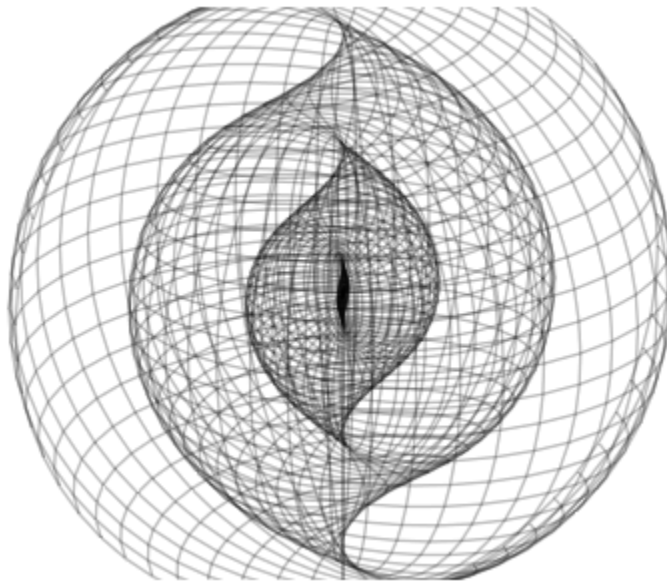

Note that we used an explicit `plot::Camera` object here because the automatic camera is always placed such that all of an object is visible, even when using `CameraDirection`. To get a “closer” look, use the interactive manipulation possibilities or an explicit camera.

## Example 6

Singularities in the radius function are heuristically handled:

```
plot(plot::Spherical([1/(u + v), u, v], u = 0..PI, v = 0..PI))
```

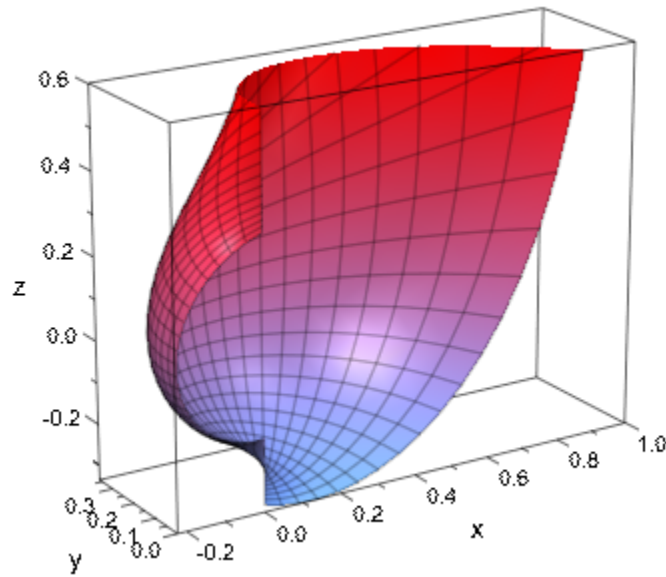

However, the heuristics fails for some examples:

```
plot(plot::Spherical([1/(u + v)^2, u, v], u = 0..PI, v = 0..PI))
```

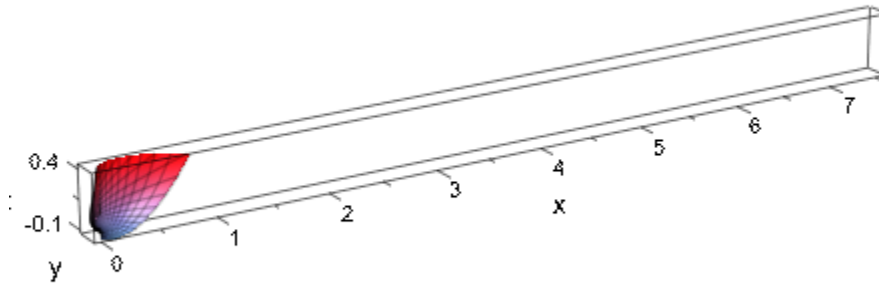

In cases like this, we recommend setting a viewing box explicitly with the attribute `ViewingBox`:

```
plot(plot::Spherical([1/(u + v)^2, u, v], u = 0..PI, v = 0..PI),  
      ViewingBox = [-1/10..0.7, 0..1/4, -0.2..0.3])
```

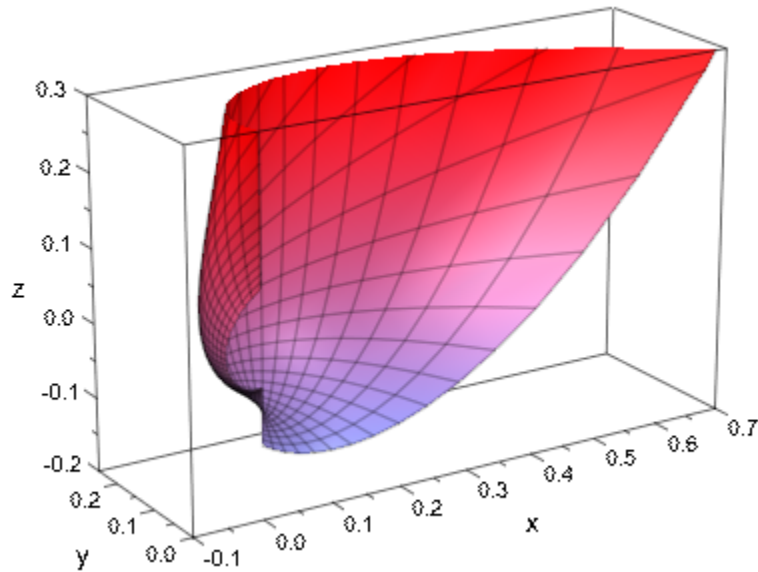

### Example 7

By setting one of the parameter ranges to a degenerate interval, it is possible to draw curves on a spherical surface:

```
f := (u, v) -> [1 + u/10, u, v]:  
surface := plot::Spherical(f(u,v), u = 0..2, v = 0..2,  
    FillColor = RGB::Grey, FillColorType = Flat):  
curve := plot::Spherical(f((1 + sin(u)), (1 + sin(2*u))),  
    u = 0..2*PI, v = 0..0, Mesh = [200, 1],  
    LineColor = RGB::Red, LineWidth = 1):  
plot(surface, curve)
```

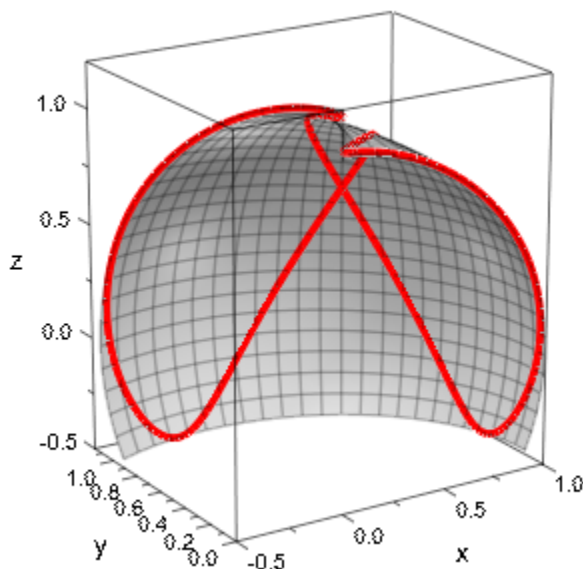

## Example 8

While the transformation from spherical to Cartesian coordinates is not invertible, there are at least two ways of expressing each Cartesian point in spherical coordinates and any surface parameterizable in Cartesian coordinates can also be plotted using `plot::Spherical`:

```
trans := linalg::ogCoordTab[Spherical, InverseTransformation]:
spher := trans(x, y, sin(x^2+y^2))
```

$$\left[ \sigma_1, \arccos\left(\frac{\sin(x^2+y^2)}{\sigma_1}\right), \arccos\left(\frac{x}{\sqrt{x^2+y^2}}\right) + \text{sign}(y) (\text{sign}(y) - 1) \left(\pi - \arccos\left(\frac{x}{\sqrt{x^2+y^2}}\right)\right) \right]$$

where

$$\sigma_1 = \sqrt{x^2 + y^2 + \sin(x^2 + y^2)^2}$$

```
plot(plot::Spherical(spher, x = -2..2, y = -2..2))
```

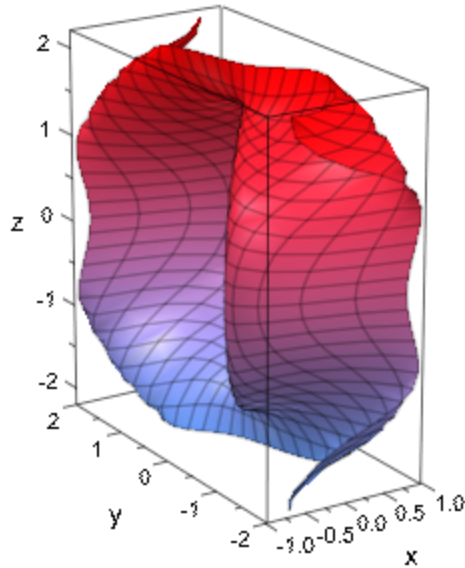

## Example 9

Last but not least we can also produce animations with the help of `plot::Spherical`. The following shows a deformation from a general spherical object to a sphere. We have used the animation parameter `a` inside of the argument for the sine function to obtain a slight rotation during the deformation process:

```
plot(  
  plot::Spherical(  
    [1+a*sin(3*Phi+a)*sin(2*Theta),Phi,Theta],  
    Theta=0..PI, Phi=0..2*PI, a=5..0  
  )  
)
```

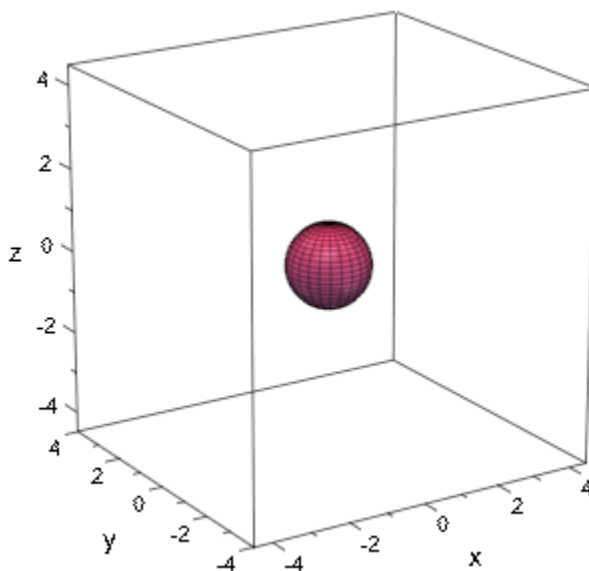

## Parameters

$r, \phi, \theta$

The coordinate functions: arithmetical expressions (Symbolic Math Toolbox) or piecewise objects depending on the surface parameters  $u, v$  and the animation parameter  $a$ . Alternatively, procedures on page 1-1654 that accept 2 input parameters  $u, v$  or 3 input parameters  $u, v, a$  and return a real numerical value when the input parameters are numerical.

$r, \phi, \theta$  are equivalent to the attributes XFunction, YFunction, ZFunction.

$u$

The first surface parameter: an identifier on page 7-29 or an indexed identifier on page 1-1017.

$u$  is equivalent to the attribute UName.

**$u_{\min} \dots u_{\max}$**

The plot range for the parameter  $u$ :  $u_{\min}$ ,  $u_{\max}$  must be numerical real values or expressions of the animation parameter  $a$ .

$u_{\min} \dots u_{\max}$  is equivalent to the attributes `URange`, `UMin`, `UMax`.

**$v$**

The second surface parameter: an identifier on page 7-29 or an indexed identifier on page 1-1017.

$v$  is equivalent to the attribute `VName`.

**$v_{\min} \dots v_{\max}$**

The plot range for the parameter  $v$ :  $v_{\min}$ ,  $v_{\max}$  must be numerical real values or expressions of the animation parameter  $a$ .

$v_{\min} \dots v_{\max}$  is equivalent to the attributes `VRange`, `VMin`, `VMax`.

**$a$**

Animation parameter, specified as  $a = a_{\min} \dots a_{\max}$ , where  $a_{\min}$  is the initial parameter value, and  $a_{\max}$  is the final parameter value.

## See Also

### MuPAD Functions

`linalg::ogCoordTab` | `plot` | `plot::copy`

### MuPAD Graphical Primitives

`plot::Cylindrical` | `plot::Polar` | `plot::Surface`



# plot::Streamlines2d

Streamlines of vector fields

## Syntax

```
plot::Streamlines2d([v1, v2], x = xmin .. xmax, y = ymin .. ymax, <a = amin .. amax>, options)
```

```
plot::Streamlines2d(v1, v2, x = xmin .. xmax, y = ymin .. ymax, <a = amin .. amax>, options)
```

```
plot::Streamlines2d(V, x = xmin .. xmax, y = ymin .. ymax, <a = amin .. amax>, options)
```

## Description

`plot::Streamlines2d( [v1, v2] , x = `x_{min}` .. `x_{max}` , y = `y_{min}` .. `y_{max}` )` creates streamlines of the vector field defined by

$(x, y) \rightarrow (v_1(x, y), v_2(x, y))$  with  $(x, y) \in [x_{min}, x_{max}] \times [y_{min}, y_{max}]$ .

A vector field is defined by a function  $f: \mathbb{R}^2 \rightarrow \mathbb{R}^2$ . `plot::Streamlines2d` displays a vector field by drawing almost evenly spaced streamlines of the vector field, i.e., curves to which the vector field is tangential at every point. The density of stream lines (and the time needed for calculation) is controlled with the attribute `MinimumDistance`.

As a rule of thumb: decreasing the value of `MinimumDistance` by a factor of 2 leads to an increase of the runtime by a factor of 4.

A user defined color scheme may be specified by `LineColorFunction = color`, where `color` is a MuPAD procedure accepting 6 input parameters and returning a list of RGB values. During plotting, this function is called in the form `color(x, y, v1, v2, t, l, n)`:

The values `x, y` are the coordinates of the current point.

The values `v1, v2` are the components of the vector field at the current point.

The value `t` is the “time” of the current point  $(x, y)$  on the current streamline. The scaling of this parameter depends on the vector field.

The value  $l$  is the curve length of the current streamline from its starting point the current point  $(x, y)$ , as a Euclidean distance. This parameter is invariant with respect to scalar changes of the vector field (up to changing the direction of the streamline).

The integer value  $n$  is a count of the current streamline. Each separate streamline has a different value.

Cf. “Example 3” on page 24-785 (Symbolic Math Toolbox).

## Attributes

Attribute	Purpose	Default Value
AbsoluteError	maximal absolute discretization error	
AffectViewingBox	influence of objects on the ViewingBox of a scene	TRUE
AntiAliased	antialiased lines and points?	TRUE
Frames	the number of frames in an animation	50
Legend	makes a legend entry	
LegendText	short explanatory text for legend	
LegendEntry	add this object to the legend?	FALSE
LineColor	color of lines	RGB::Black
LineWidth	width of lines	0.35*unit::mm
LineColor2	color of lines	RGB::DeepPink
LineStyle	solid, dashed or dotted lines?	Solid
LineColorType	line coloring types	Flat
LineColorFunction	functional line coloring	
MinimumDistance	space between stream lines	

Attribute	Purpose	Default Value
Name	the name of a plot object (for browser and legend)	
ODEMethod	the numerical scheme used for solving the ODE	ABM4
ParameterEnd	end value of the animation parameter	
ParameterName	name of the animation parameter	
ParameterBegin	initial value of the animation parameter	
ParameterRange	range of the animation parameter	
RelativeError	maximal relative discretization error	1/100000
Stepsize	set a constant step size	
TimeEnd	end time of the animation	10.0
TimeBegin	start time of the animation	0.0
TimeRange	the real time span of an animation	0.0 .. 10.0
TipAngle	opening angle of arrow heads	(2*PI)/15
TipStyle	presentation style of arrow heads	Filled
TipLength	length of arrow heads	0
Title	object title	
TitleFont	font of object titles	[" sans-serif ", 11]
TitlePosition	position of object titles	
TitleAlignment	horizontal alignment of titles w.r.t. their coordinates	Center
TitlePositionX	position of object titles, x component	

Attribute	Purpose	Default Value
TitlePositionY	position of object titles, y component	
Visible	visibility	TRUE
VisibleAfter	object visible after this time value	
VisibleBefore	object visible until this time value	
VisibleFromTo	object visible during this time range	
VisibleAfterEnd	object visible after its animation time ended?	TRUE
VisibleBeforeBegin	object visible before its animation time starts?	TRUE
XFunction	function for x values	
XMax	final value of parameter "x"	
XMin	initial value of parameter "x"	
XName	name of parameter "x"	
XRange	range of parameter "x"	
YFunction	function for y values	
YMax	final value of parameter "y"	
YMin	initial value of parameter "y"	
YName	name of parameter "y"	
YRange	range of parameter "y"	

## Examples

### Example 1

`plot::Streamlines2d` depicts vector fields by (more or less) equidistant stream lines:

```
plot(plot::Streamlines2d(-x, -y, x=-2..2, y=-2..2))
```

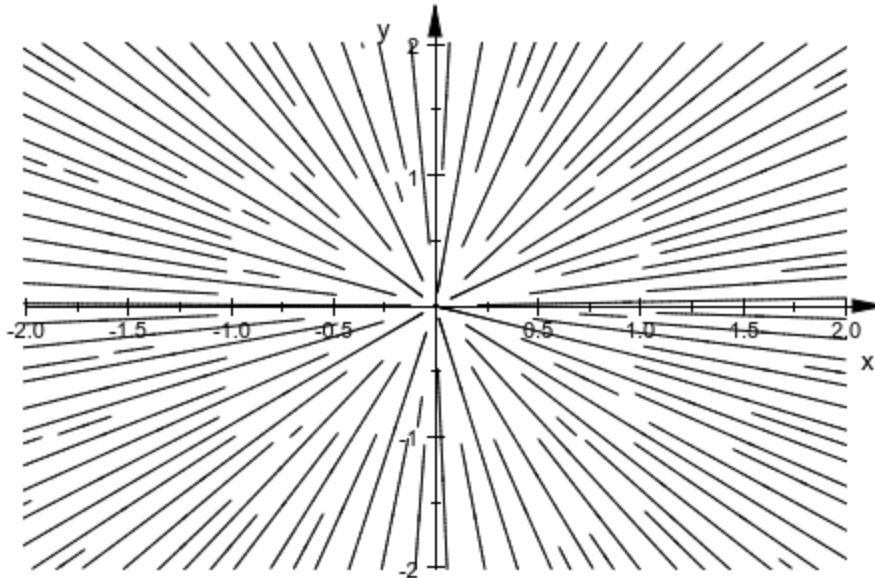

Note that this style of display necessarily breaks symmetries, in this case the perfect rotational symmetry of the vector field.

Additionally, cycles will not be closed, but leave a gap:

```
plot(plot::Streamlines2d(-y, x, x=-2..2, y=-2..2))
```

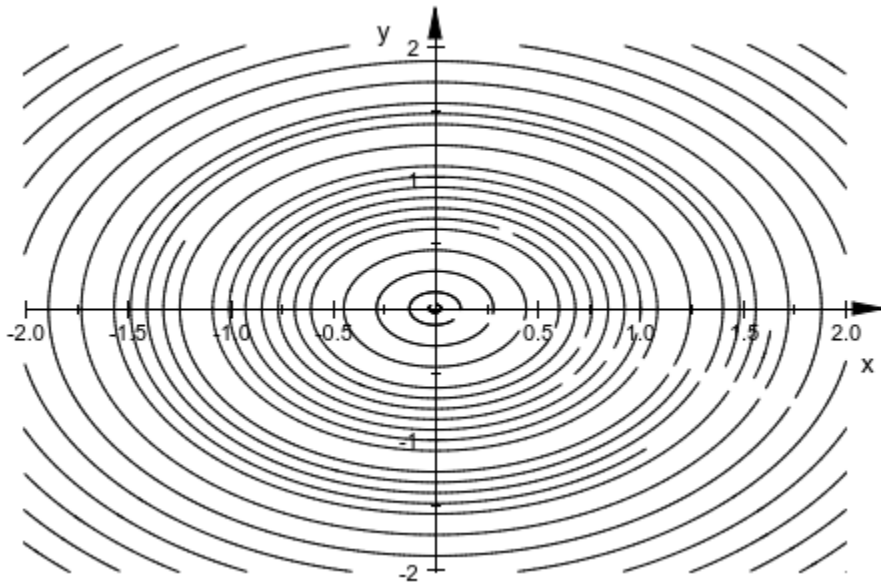

### Example 2

Apart from the “usual” parameters such as parameter ranges on page 24-1417, line color on page 24-1859, or line width on page 24-1890, `plot::Streamlines2d` can be controlled with the attribute `MinimumDistance`, which sets the minimum distance between stream lines:

```
plot(plot::Streamlines2d(sin(x^2+y^2), cos(x^2+y^2),  
                          x = -3..3, y = -2..2))
```

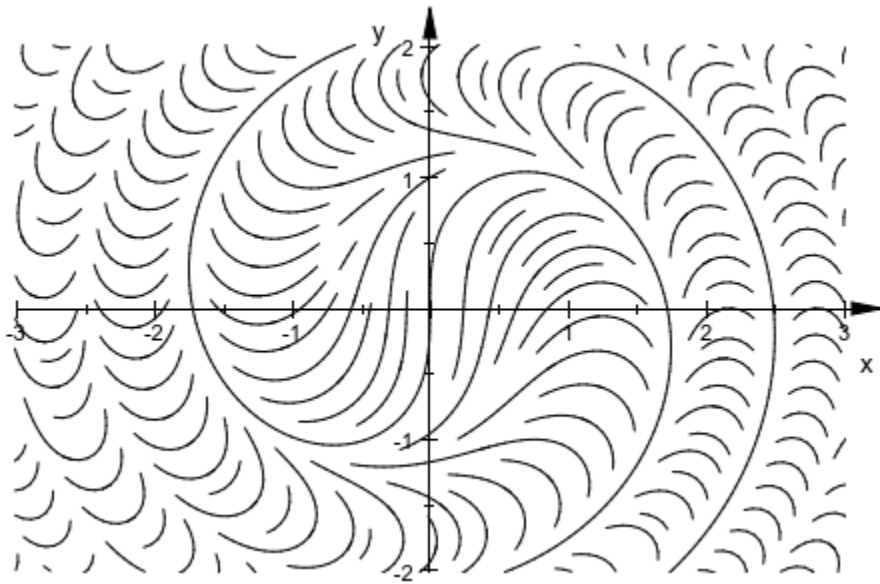

```
plot(plot::Streamlines2d(sin(x^2+y^2), cos(x^2+y^2),  
x = -3..3, y = -2..2,  
MinimumDistance = 0.2))
```

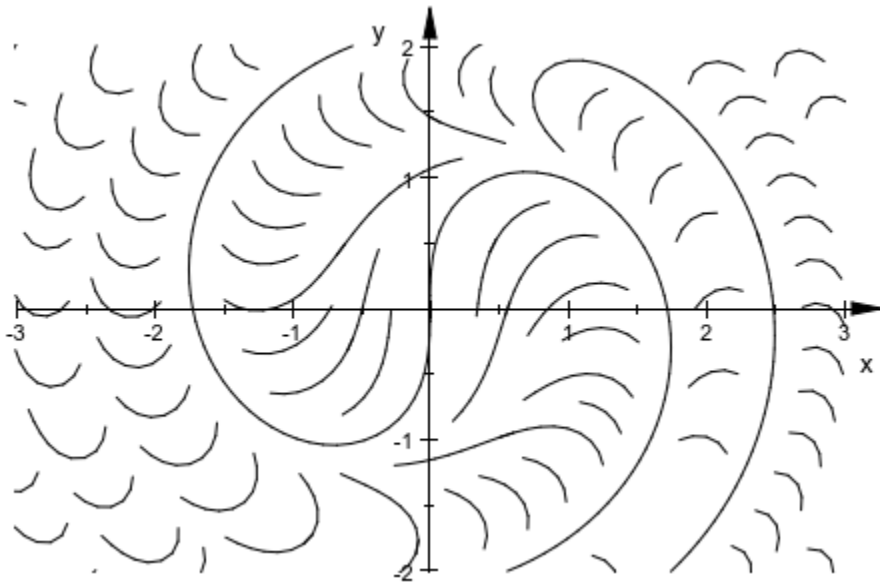

```
plot(plot::Streamlines2d(sin(x^2+y^2), cos(x^2+y^2),  
x = -3..3, y = -2..2,  
MinimumDistance = 0.05))
```



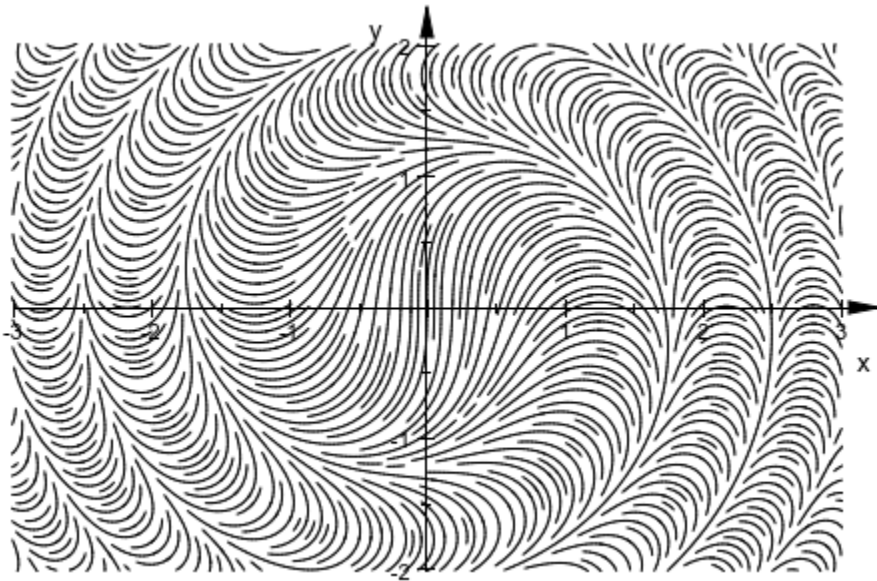

### Example 3

A line color function on page 24-785 (Symbolic Math Toolbox) for `plot::Streamlines2d` has access to the current coordinates, to the components of the vector field at the current point, to the current length on the curve (both in terms of the “time” parameter and Euclidean distance) and an integer count of the current curve (which are not found in some predefined order). We use the curve number to generate a colorful display:

```
num2col := (x, y, vx, vy, t, l, n) -> RGB::fromHSV([111*n, 1, 1]):
plot(plot::Streamlines2d(sin(x^2+y^2), cos(x^2+y^2),
    x = -3..3, y = -2..2,
    LineColorFunction = num2col))
```

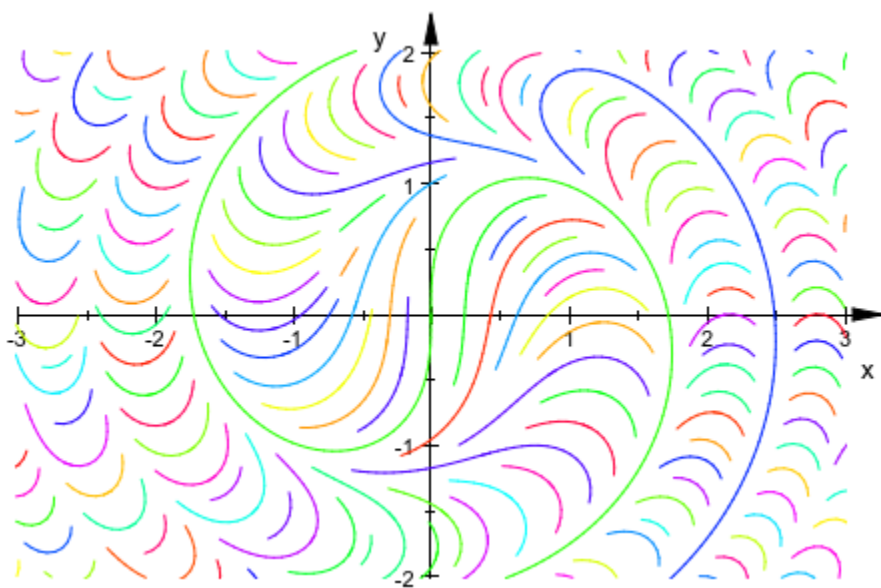

Using the curve length information allows us to include directional information in the visual display:

```
l2col := (x, y, vx, vy, t, l) -> [frac(5*l) $ 3]:  
plot(plot::Streamlines2d(sin(x^2+y^2), cos(x^2+y^2),  
    x = -3..3, y = -2..2,  
    LineWidth = 0.75,  
    LineColorFunction = l2col))
```

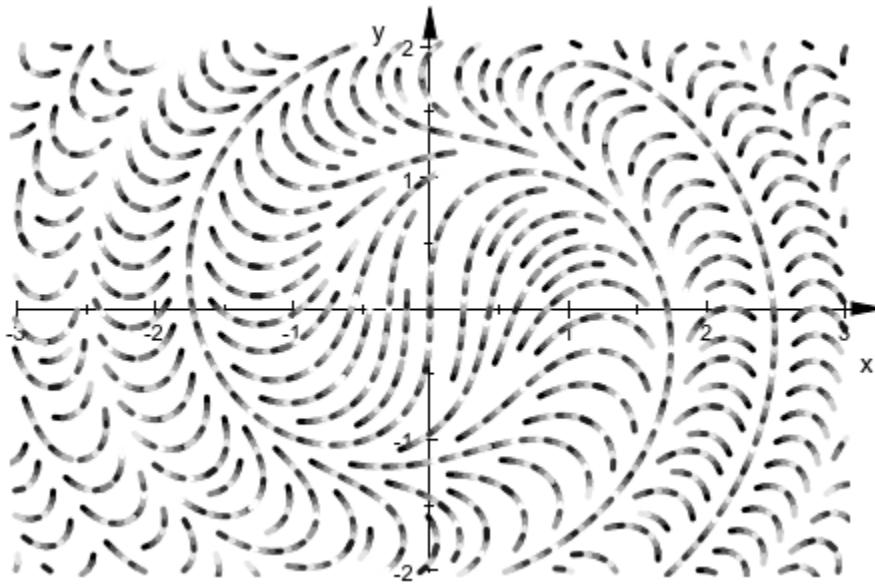

Often, an easier way of plotting the orientation of the stream lines is to activate the arrow heads `plot::Streamlines2d` plots at the middle of each sufficiently long) stream line. These are made invisible by the default tip length on page 24-2013 of 0:

```
plot(plot::Streamlines2d(0.3*x-y, 0.3*y+x,  
x = -3..3, y = -2..2,  
TipLength = 3*unit::mm))
```

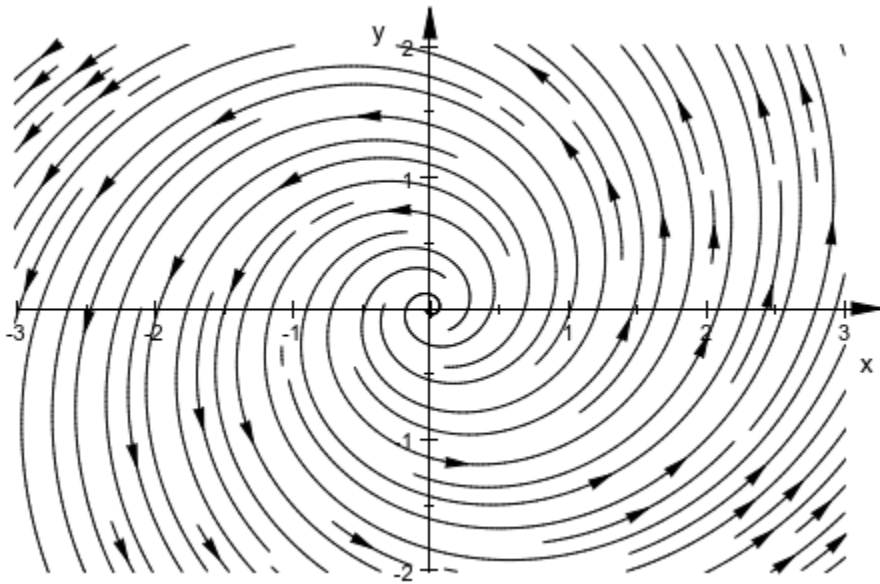

### Example 4

Since the placement of stream lines is hard to predict, `plot::Streamlines2d` is not really suitable for animations. It is possible to animate `plot::Streamlines2d`, but coherence between the animation frames is less than usual:

```
plot(plot::Streamlines2d(sin(x^2+y^2), cos(x^2-y^2+a),  
    x = -2..2, y = -2..2, a = -PI..PI,  
    MinimumDistance = 0.1,  
    Frames=10))
```

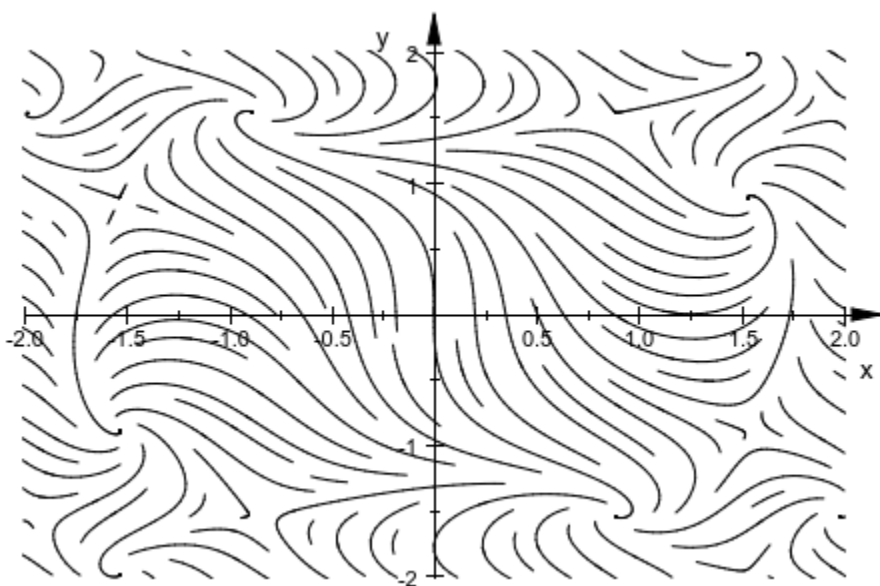

### Example 5

With the default settings, `plot::Streamlines2d` is not able to plot the vector field

$[1, 3^{2/y}]$  (which is not Lipschitz continuous) in a satisfying way:

```
plot(plot::Streamlines2d([1, surd(3,y)^2],
                        x=-3..3, y=-2..2))
```

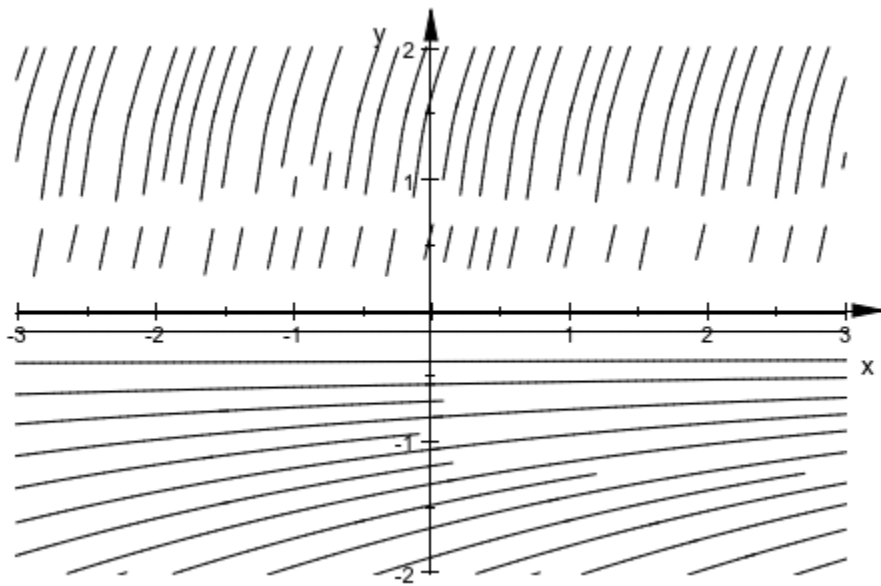

By using a different numerical integrator, the problems can be overcome (at the cost of longer computation):

```
plot(plot::Streamlines2d([1, surd(3,y)^2],  
  x=-3..3, y=-2..2,  
  ODEMethod=RKF43,  
  RelativeError=1e-3))
```

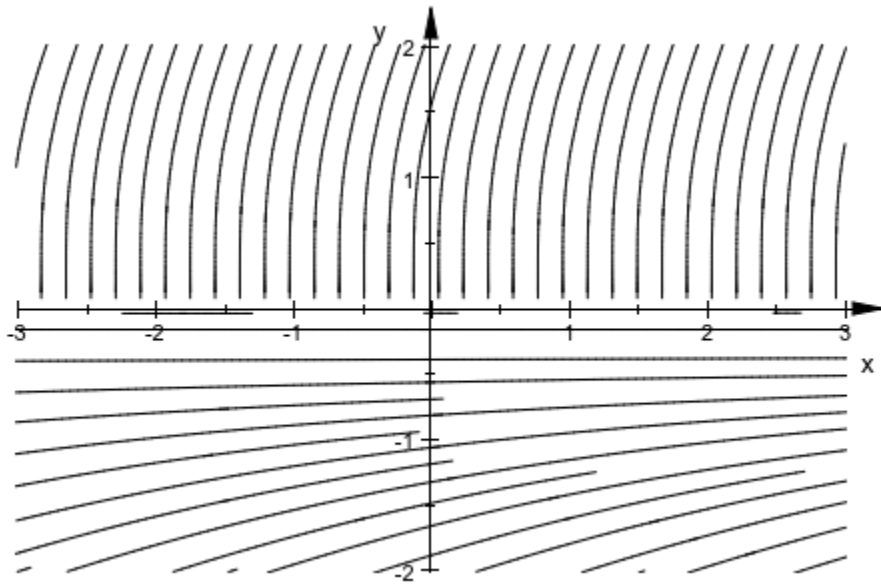

## Parameters

### $v_1, v_2$

The x- and y-component of the vector field: arithmetical expressions in  $x$ ,  $y$ , and, possibly, the animation parameter  $a$ .

$v_1, v_2$  are equivalent to the attributes XFunction, YFunction.

### $V$

A matrix on page 1-1340 of category `Cat::Matrix` with two entries that provide the components  $v_1, v_2$  of the vector field.

### $x, y$

Identifiers.

$x, y$  are equivalent to the attributes XName, YName.

$x_{\min} \dots x_{\max}, y_{\min} \dots y_{\max}$

Real numerical values.

$x_{\min} \dots x_{\max}, y_{\min} \dots y_{\max}$  are equivalent to the attributes `XRange`, `YRange`, `XMin`, `XMax`, `YMin`, `YMax`.

**a**

Animation parameter, specified as  $a = a_{\min} \dots a_{\max}$ , where  $a_{\min}$  is the initial parameter value, and  $a_{\max}$  is the final parameter value.

## Algorithms

The algorithm used in `plot::Streamlines2d` has been published in “Creating Evenly-Spaced Streamlines of Arbitrary Density” by Bruno Jobard and Wilfrid Lefer at the Eurographics Workshop in Boulogne-sur-Mer, France.

## See Also

### MuPAD Functions

`plot` | `plot::copy`

### MuPAD Graphical Primitives

`plot::ode2d` | `plot::ode3d` | `plot::VectorField2d` | `plot::VectorField3d`



# plot::Sum

Graphical primitive for symbolic sums

## Syntax

```
plot::Sum(ex, i = m .. n, <a = amin .. amax>, options)
```

```
plot::Sum(sum(ex, i = m .. n), <a = amin .. amax>, options)
```

## Description

`plot::Sum(ex, i = m..n)` creates a plot of summing `ex` over the range `m..n`.

`plot::Sum` creates a visual display of partial sums over a finite interval. Mathematically,

`plot::Sum(ex, i = m..n)` plots the function  $x \rightarrow \sum_{i=m} (m + [x - m] \text{ex})$ .

To ease the use of `plot::Sum` in programs, symbolic sums are accepted in the input and `plot::Sum` takes care not to evaluate these. It is highly recommended, though, not to use this syntax in interactive applications, to avoid premature evaluation.

## Attributes

Attribute	Purpose	Default Value
AffectViewingBox	influence of objects on the ViewingBox of a scene	TRUE
AntiAliased	antialiased lines and points?	FALSE
Color	the main color	RGB::Blue
Filled	filled or transparent areas and surfaces	FALSE
FillColor	color of areas and surfaces	RGB::Red
FillPattern	type of area filling	Solid

<b>Attribute</b>	<b>Purpose</b>	<b>Default Value</b>
Frames	the number of frames in an animation	50
Function	function expression or procedure	
Legend	makes a legend entry	
LegendText	short explanatory text for legend	
LegendEntry	add this object to the legend?	FALSE
LineColor	color of lines	RGB::Blue
LineWidth	width of lines	0.35
LineColor2	color of lines	RGB::DeepPink
LineStyle	solid, dashed or dotted lines?	Solid
LinesVisible	visibility of lines	TRUE
LineColorType	line coloring types	Flat
LineColorFunction	functional line coloring	
LineColorDirection	the direction of color transitions on lines	[0, 1]
LineColorDirectionX	x-component of the direction of color transitions on lines	0
LineColorDirectionY	y-component of the direction of color transitions on lines	1
Name	the name of a plot object (for browser and legend)	
ParameterEnd	end value of the animation parameter	
ParameterName	name of the animation parameter	
ParameterBegin	initial value of the animation parameter	

Attribute	Purpose	Default Value
ParameterRange	range of the animation parameter	
PointColor	the color of points	RGB::MidnightBlue
PointsVisible	visibility of mesh points	FALSE
TimeEnd	end time of the animation	10.0
TimeBegin	start time of the animation	0.0
TimeRange	the real time span of an animation	0.0 .. 10.0
Title	object title	
TitleFont	font of object titles	[" sans-serif ", 11]
TitlePosition	position of object titles	
TitleAlignment	horizontal alignment of titles w.r.t. their coordinates	Center
TitlePositionX	position of object titles, x component	
TitlePositionY	position of object titles, y component	
Visible	visibility	TRUE
VisibleAfter	object visible after this time value	
VisibleBefore	object visible until this time value	
VisibleFromTo	object visible during this time range	
VisibleAfterEnd	object visible after its animation time ended?	TRUE
VisibleBeforeBegin	object visible before its animation time starts?	TRUE
XMax	final value of parameter "x"	
XMin	initial value of parameter "x"	

Attribute	Purpose	Default Value
XName	name of parameter "x"	
XRange	range of parameter "x"	

## Examples

### Example 1

It is well known that  $\sum_{j=1}^{\infty} \frac{1}{j^2} = \frac{\pi^2}{6}$ . We use `plot::Sum` to display the first 100 partial sums:

```
plot(plot::Sum(1/j^2, j = 1..100),
      plot::Function2d(PI^2/6, x=1..101, LineStyle = Dashed))
```

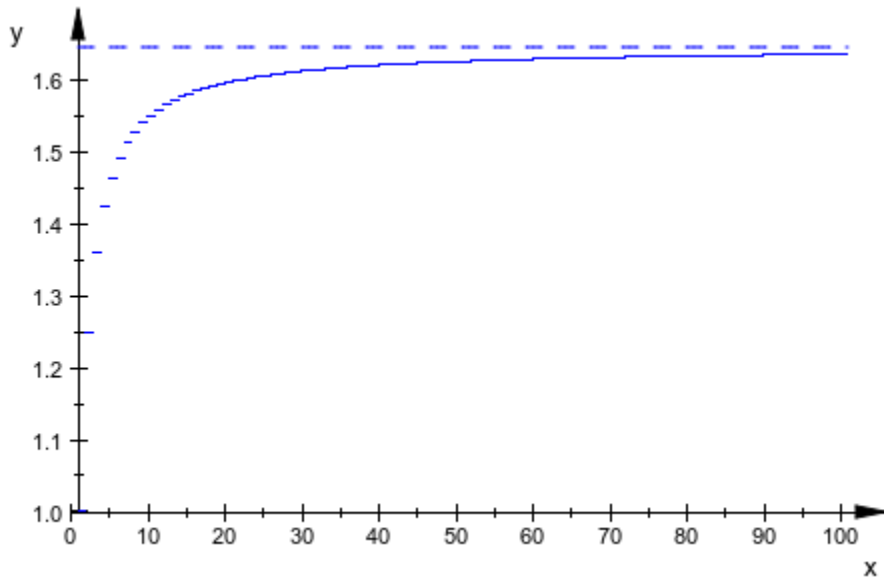

With more partial sums, the steps approximate points:

```
plot(plot::Sum(sin(j^2)/j, j=1..500))
```

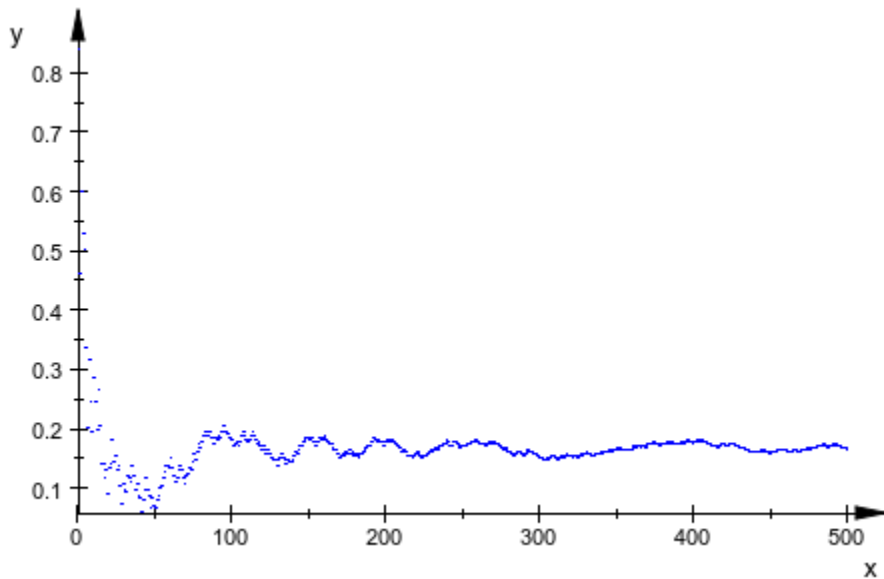

## Example 2

To show some of the formatting options of `plot::Sum`, we use the following sum:

```
s := plot::Sum(1/j, j = 1..20)
```

$$\text{plot::Sum}\left(\frac{1}{j}, j = 1..20\right)$$

By default, this object is displayed as follows:

```
plot(s)
```

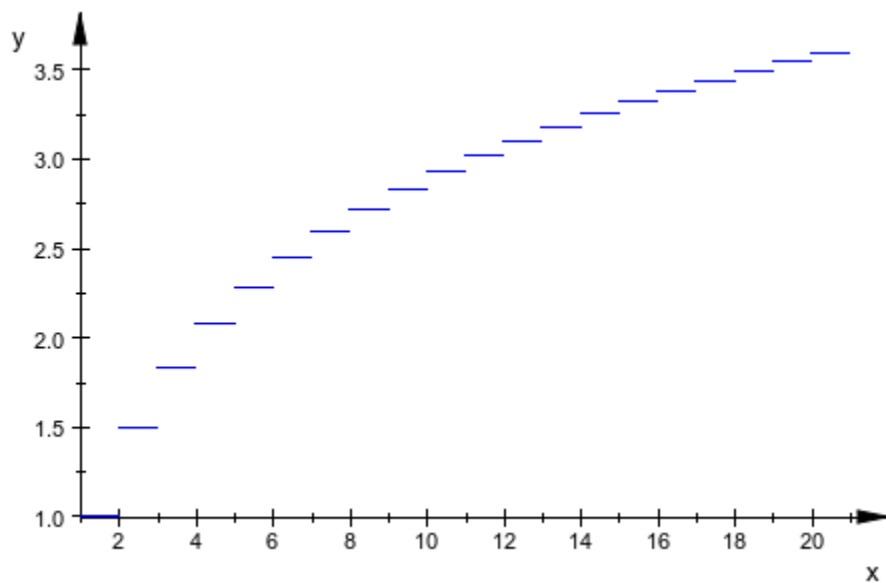

To change parameters, we can select them in the inspector (Symbolic Math Toolbox) and change the values, we can give other values directly in the `plot` command or we can set the new values in our object `s`:

```
s::PointsVisible := TRUE:  
s::LinesVisible := FALSE:  
s::PointColor := RGB::Green:  
plot(s)
```

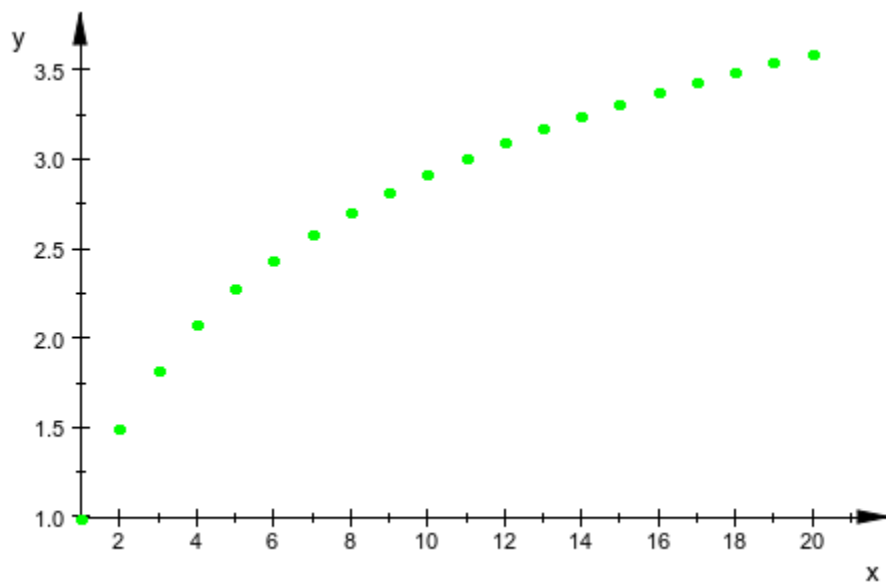

### Example 3

`plot::Sum` allows animation in the usual way, for example, in the term to sum:

```
plot(plot::Sum(sin(a*i^2)/i, i = 1..50, a = 0..PI))
```

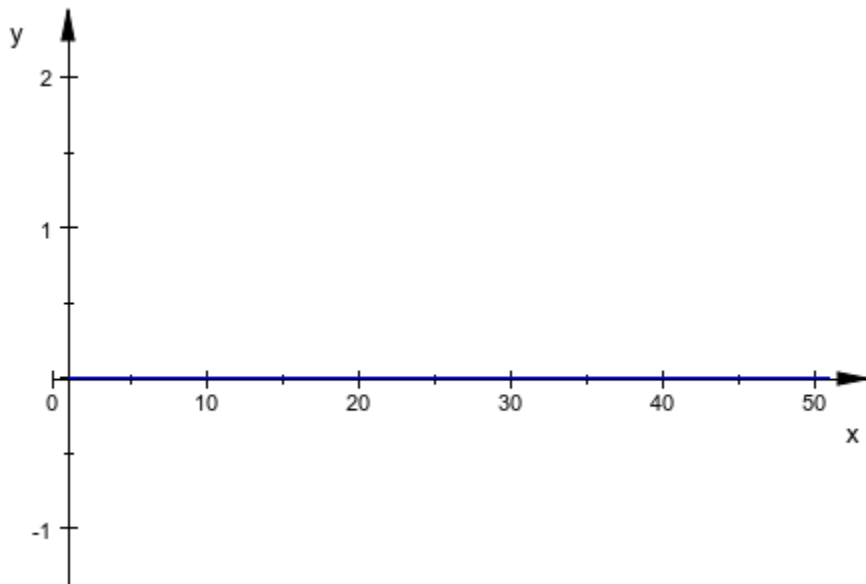

Another interesting parameter to animate is the summation range:

```
plot(plot::Sum((-1)^j/j, j = 1..jmax, jmax = 1..50))
```



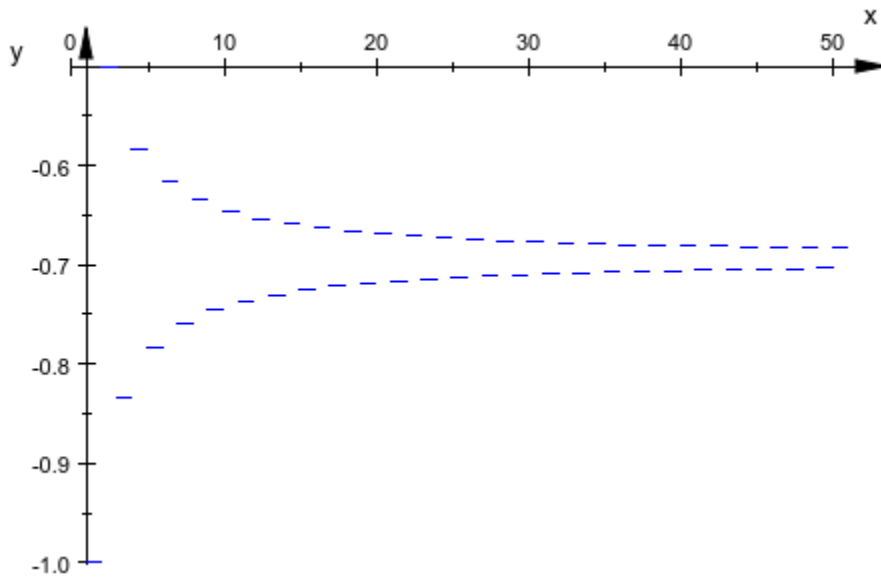

## Parameters

### ex

Arithmetical expression in *i* and the animation parameter *a*, if that is used.

*ex* is equivalent to the attribute *Function*.

### *i*

An identifier or indexed identifier.

*i* is equivalent to the attribute *XName*.

### *m* .. *n*

The range of *i*. *m* and *n* may be expressions in the animation parameter *a*. Summation goes over *m* + integer. If *n* - *m* is not an integer, *n* will not be reached.

*m* .. *n* is equivalent to the attributes *XRange*, *XMin*, *XMax*.

**a**

Animation parameter, specified as  $a = a_{\min} .. a_{\max}$ , where  $a_{\min}$  is the initial parameter value, and  $a_{\max}$  is the final parameter value.

## See Also

### MuPAD Functions

`plot` | `plot::copy`

### MuPAD Graphical Primitives

`plot::Function2d` | `plot::PointList2d`

# plot::Surface

Parametrized surfaces in 3D

## Syntax

```
plot::Surface([x, y, z], u = u_min .. u_max, v = v_min .. v_max, <a = a_min .. a_max>, options)
```

```
plot::Surface(xyz, u = u_min .. u_max, v = v_min .. v_max, <a = a_min .. a_max>, options)
```

```
plot::Surface(A, u = u_min .. u_max, v = v_min .. v_max, <a = a_min .. a_max>, options)
```

## Description

`plot::Surface` creates a parametrized surface in 3D.

The surface given by a mapping (“parametrization”)  $(u, v) \rightarrow (x(u, v), y(u, v), z(u, v))$  is the set of all image points

$$\left\{ \begin{pmatrix} x(u, v) \\ y(u, v) \\ z(u, v) \end{pmatrix} \middle| u \in [u_{\min}, u_{\max}], v \in [v_{\min}, v_{\max}] \right\} \in \mathbb{R}^3$$

The expressions/functions  $x, y, z$  may have singularities in the plot range. Although a heuristics is used to find a reasonable viewing range when singularities are present, it is highly recommended to specify a viewing box via the attribute `ViewingBox = [x_min .. x_max, y_min .. y_max, z_min .. z_max]` with suitable numerical real values  $x_{\min}, \dots, z_{\max}$ . See “Example 3” on page 24-811 (Symbolic Math Toolbox).

Animations are triggered by specifying a range  $a = a_{\min} .. a_{\max}$  for a parameter  $a$  that is different from the surface parameters  $u, v$ . See “Example 5” on page 24-814 (Symbolic Math Toolbox).

The functions  $x, y, z$  are evaluated on a regular equidistant mesh of sample points in the  $u$ - $v$  plane. This mesh is determined by the attributes `UMesh, VMesh`. By default, the

attribute `AdaptiveMesh = 0` is set, i.e., no adaptive refinement of the equidistant mesh is used.

If the standard mesh does not suffice to produce a sufficiently detailed plot, one may either increase the value of `UMesh`, `VMesh` or `USubmesh`, `VSubmesh`, or set `AdaptiveMesh = n` with some (small) positive integer  $n$ . If necessary, up to  $2^n - 1$  additional points are placed in each direction of the  $u$ - $v$  plane between adjacent points of the initial equidistant mesh. See “Example 6” on page 24-815 (Symbolic Math Toolbox).

The “coordinate lines” (“parameter lines”) are curves on the surface.

The phrase “`ULines`” refers to the curves  $(x(u, v_0), y(u, v_0), z(u, v_0))$  with the parameter  $u$  running from  $u_{\min}$  to  $u_{\max}$ , while  $v_0$  is some fixed value from the interval  $[v_{\min}, v_{\max}]$ .

The phrase “`VLines`” refers to the curves  $(x(u_0, v), y(u_0, v), z(u_0, v))$  with the parameter  $v$  running from  $v_{\min}$  to  $v_{\max}$ , while  $u_0$  is some fixed value from the interval  $[u_{\min}, u_{\max}]$ .

By default, the parameter curves are visible. They may be “switched off” by specifying `ULinesVisible = FALSE` and `VLinesVisible = FALSE`, respectively.

The coordinate lines controlled by `ULinesVisible = TRUE/FALSE` and `VLinesVisible = TRUE/FALSE` indicate the equidistant mesh in the  $u$ - $v$  plane set via the `UMesh`, `VMesh` attributes. If the mesh is refined by the `USubmesh`, `VSubmesh` attributes, or by the adaptive mechanism controlled by `AdaptiveMesh = n`, no additional parameter lines are drawn.

As far as the numerical approximation of the surface is concerned, the settings `UMesh =  $n_u$` , `VMesh =  $n_v$` , `USubmesh =  $m_u$` , `VSubmesh =  $m_v$`  and `UMesh =  $(n_u - 1) (m_u + 1) + 1$` , `VMesh =  $(n_v - 1) (m_v + 1) + 1$` , `USubmesh = 0`, `VSubmesh = 0` are equivalent. However, in the first setting,  $n_u$  parameter lines are visible in the  $u$  direction, while in the latter setting  $(n_u - 1) (m_u + 1) + 1$  parameter lines are visible. See “Example 7” on page 24-818 (Symbolic Math Toolbox).

Use `Filled = FALSE` to render the surface as a wireframe.

## Attributes

Attribute	Purpose	Default Value
<code>AdaptiveMesh</code>	adaptive sampling	0

Attribute	Purpose	Default Value
AffectViewingBox	influence of objects on the ViewingBox of a scene	TRUE
Color	the main color	RGB::Red
Filled	filled or transparent areas and surfaces	TRUE
FillColor	color of areas and surfaces	RGB::Red
FillColor2	second color of areas and surfaces for color blends	RGB::CornflowerBlue
FillColorType	surface filling types	Dichromatic
FillColorFunction	functional area/surface coloring	
FillColorDirection	the direction of color transitions on surfaces	[0, 0, 1]
FillColorDirectionX	x-component of the direction of color transitions on surfaces	0
FillColorDirectionY	y-component of the direction of color transitions on surfaces	0
FillColorDirectionZ	z-component of the direction of color transitions on surfaces	1
Frames	the number of frames in an animation	50
Legend	makes a legend entry	
LegendText	short explanatory text for legend	
LegendEntry	add this object to the legend?	TRUE
LineColor	color of lines	RGB::Black.[0.25]
LineWidth	width of lines	0.35
LineColor2	color of lines	RGB::DeepPink

<b>Attribute</b>	<b>Purpose</b>	<b>Default Value</b>
LineStyle	solid, dashed or dotted lines?	Solid
LineColorType	line coloring types	Flat
LineColorFunction	functional line coloring	
LineColorDirection	the direction of color transitions on lines	[0, 0, 1]
LineColorDirectionX	x-component of the direction of color transitions on lines	0
LineColorDirectionY	y-component of the direction of color transitions on lines	0
LineColorDirectionZ	z-component of the direction of color transitions on lines	1
Mesh	number of sample points	[25, 25]
MeshVisible	visibility of irregular mesh lines in 3D	FALSE
Name	the name of a plot object (for browser and legend)	
ParameterEnd	end value of the animation parameter	
ParameterName	name of the animation parameter	
ParameterBegin	initial value of the animation parameter	
ParameterRange	range of the animation parameter	
PointSize	the size of points	1.5
PointStyle	the presentation style of points	FilledCircles
PointsVisible	visibility of mesh points	FALSE
Shading	smooth color blend of surfaces	Smooth

Attribute	Purpose	Default Value
Submesh	density of submesh (additional sample points)	[0, 0]
TimeEnd	end time of the animation	10.0
TimeBegin	start time of the animation	0.0
TimeRange	the real time span of an animation	0.0 .. 10.0
Title	object title	
TitleFont	font of object titles	[" sans-serif ", 11]
TitlePosition	position of object titles	
TitleAlignment	horizontal alignment of titles w.r.t. their coordinates	Center
TitlePositionX	position of object titles, x component	
TitlePositionY	position of object titles, y component	
TitlePositionZ	position of object titles, z component	
ULinesVisible	visibility of parameter lines (u lines)	TRUE
UMax	final value of parameter "u"	
UMesh	number of sample points for parameter "u"	25
UMin	initial value of parameter "u"	
UName	name of parameter "u"	
URange	range of parameter "u"	
USubmesh	density of additional sample points for parameter "u"	0
VLinesVisible	visibility of parameter lines (v lines)	TRUE
VMax	final value of parameter "v"	

<b>Attribute</b>	<b>Purpose</b>	<b>Default Value</b>
VMesh	number of sample points for parameter "v"	25
VMin	initial value of parameter "v"	
VName	name of parameter "v"	
VRange	range of parameter "v"	
VSubmesh	density of additional sample points for parameter "v"	0
Visible	visibility	TRUE
VisibleAfter	object visible after this time value	
VisibleBefore	object visible until this time value	
VisibleFromTo	object visible during this time range	
VisibleAfterEnd	object visible after its animation time ended?	TRUE
VisibleBeforeBegin	object visible before its animation time starts?	TRUE
XContours	contour lines at constant x values	[]
XFunction	function for x values	
YContours	contour lines at constant y values	[]
YFunction	function for y values	
ZContours	contour lines at constant z values	[]
ZFunction	function for z values	



## Examples

### Example 1

Using standard spherical coordinates, a parametrization of a sphere of radius  $r$  by the azimuth angle  $u \in [0, 2\pi]$  and the polar angle  $v \in [0, \pi]$  is given by:

```
x := r*cos(u)*sin(v):
y := r*sin(u)*sin(v):
z := r*cos(v):
```

We fix  $r = 1$  and create the surface object:

```
r := 1:
s := plot::Surface([x, y, z], u = 0 .. 2*PI, v = 0 .. PI)
```

```
plot::Surface([cos(u) sin(v), sin(u) sin(v), cos(v)], u = 0..2 *pi, v = 0..pi)
```

We call `plot` to plot the surface:

```
plot(s, Scaling = Constrained):
```

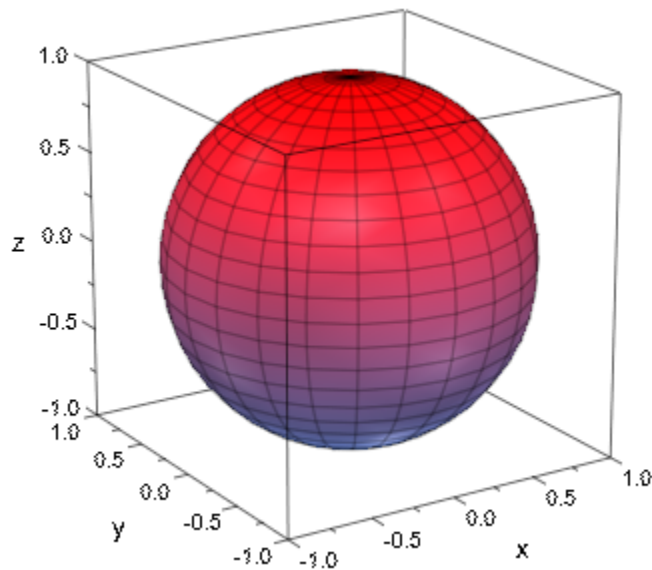

```
delete x, y, z, r, s:
```

## Example 2

The parametrization can also be specified by piecewise objects or procedures:

```
x := u*cos(v):  
y := piecewise([u <= 1, u*sin(v)], [u >= 1, u^2*sin(v)]):  
z := proc(u, v)  
begin  
  if u <= 1 then  
    0  
  else  
    cos(4*v)  
  end_if:  
end_proc:  
plot(plot::Surface([x, y, z], u = 0 .. sqrt(2), v = 0 .. 2*PI)):
```

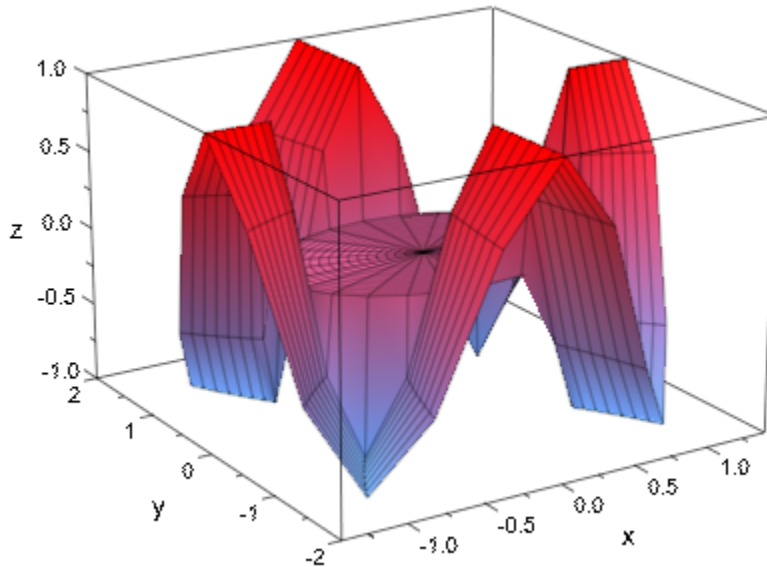

We enable adaptive sampling to get a smoother graphical result:

```
plot(plot::Surface([x, y, z], u = 0 .. sqrt(2), v = 0 .. 2*PI),  
      AdaptiveMesh = 3):
```

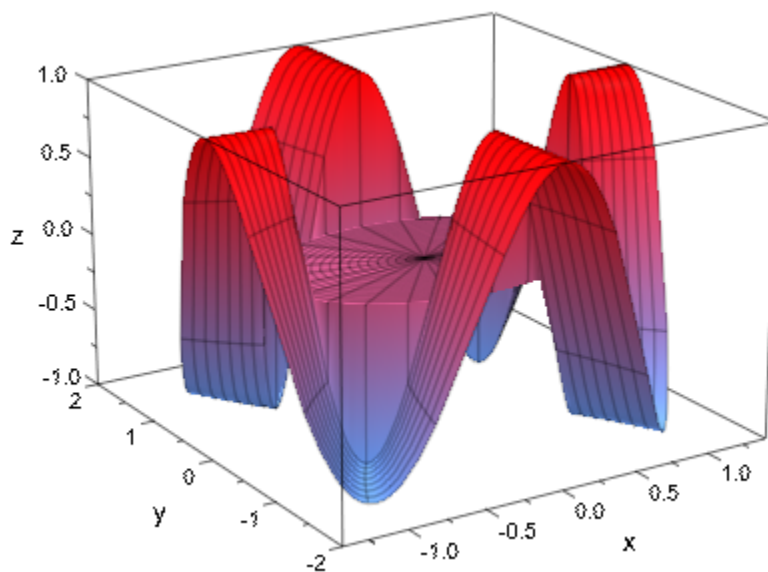

```
delete x, y, z, s, r:
```

### Example 3

We plot a surface with singularities:

```
s := plot::Surface([u*cos(v), u*sin(v), 1/u^2],  
                  u = 0 .. 1, v = 0 .. 2*PI):  
plot(s):
```

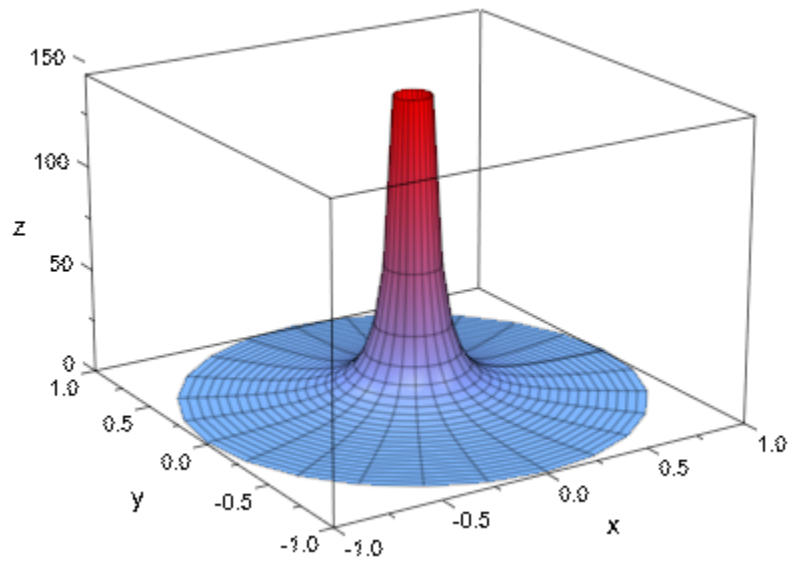

We specify an explicit viewing range for the z coordinate:

```
plot(s, ViewingBox = [Automatic, Automatic, 0 .. 10]):
```

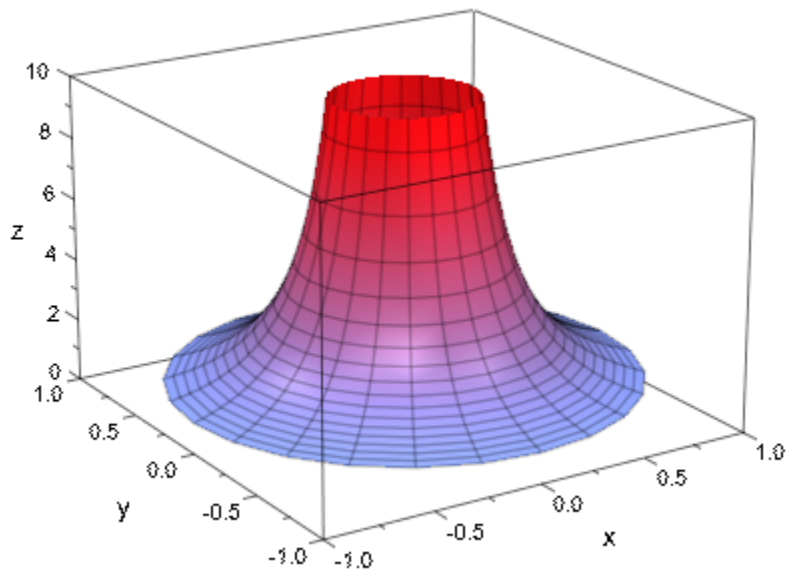

delete s:

#### Example 4

By introducing non-real function evaluations, we can plot surfaces with holes:

```
chi := piecewise([sin(4*u) < cos(3*v)+0.5, 1]):
plot(plot::Surface([cos(u)*sin(v),
                    sin(u)*sin(v),
                    chi*cos(v)],
                u = 0 .. 2*PI, v = 0 .. PI,
                AdaptiveMesh=2), Scaling = Constrained)
```

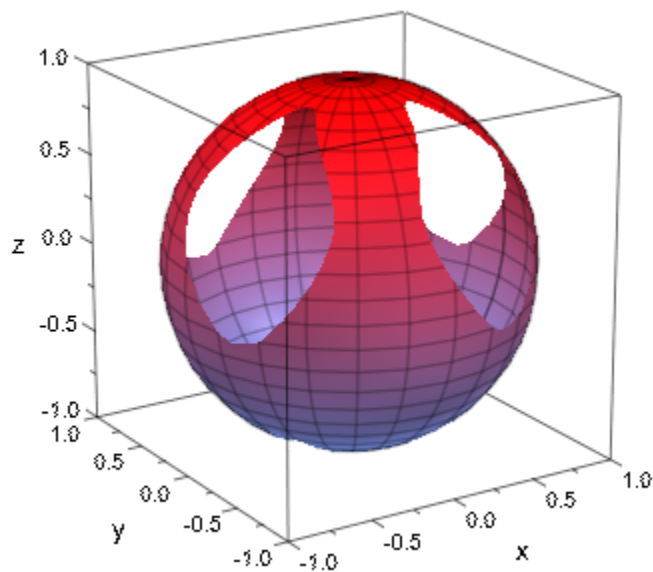

### Example 5

We generate an animation of a surface of revolution. The graph of the function

$f(u) = \frac{1}{1+u^2}$  is rotated around the x-axis:

```
f := u->1/(1+u^2);
plot(plot::Surface([u, f(u)*sin(v), f(u)*cos(v)], u = -2 .. 2,
                   v = 0 .. a*2*PI, a = 0 .. 1)):
```

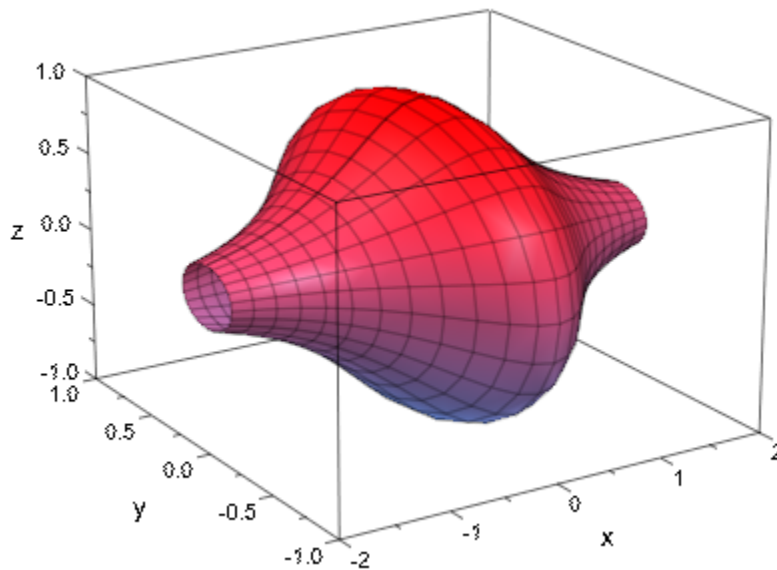

See `plot::XRotate`, `plot::ZRotate` for an alternative way to create surfaces of revolution.

`delete f:`

## Example 6

The standard mesh for the numerical evaluation of a surface does not suffice to generate a satisfying plot in the following case:

```
r := 2 + sin(7*u + 5*v):  
x := r*cos(u)*sin(v):  
y := r*sin(u)*sin(v):  
z:=  r*cos(v):  
plot(plot::Surface([x, y, z], u = 0 .. 2*PI, v = 0 .. PI)):
```

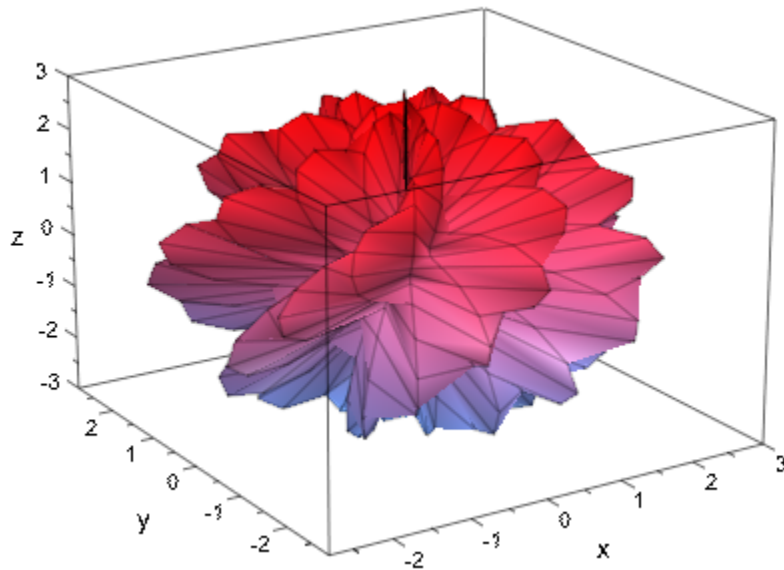

We increase the number of mesh points. Here, we use `USubmesh`, `VSubmesh` to place 2 additional points in each direction between each pair of neighboring points of the default mesh. This increases the runtime for computing the plot by a factor of 9:

```
plot(plot::Surface([x, y, z], u = 0 .. 2*PI, v = 0 .. PI,  
                  USubmesh = 2, VSubmesh = 2)):
```



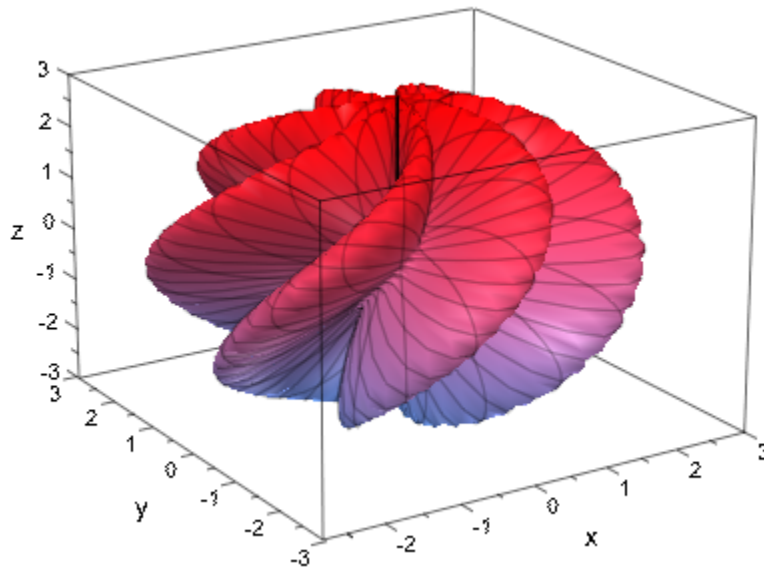

Alternatively, we enable adaptive sampling by setting the value of `AdaptiveMesh` to some positive value:

```
plot(plot::Surface([x, y, z], u = 0 .. 2*PI, v = 0 .. PI,  
AdaptiveMesh = 2)):
```

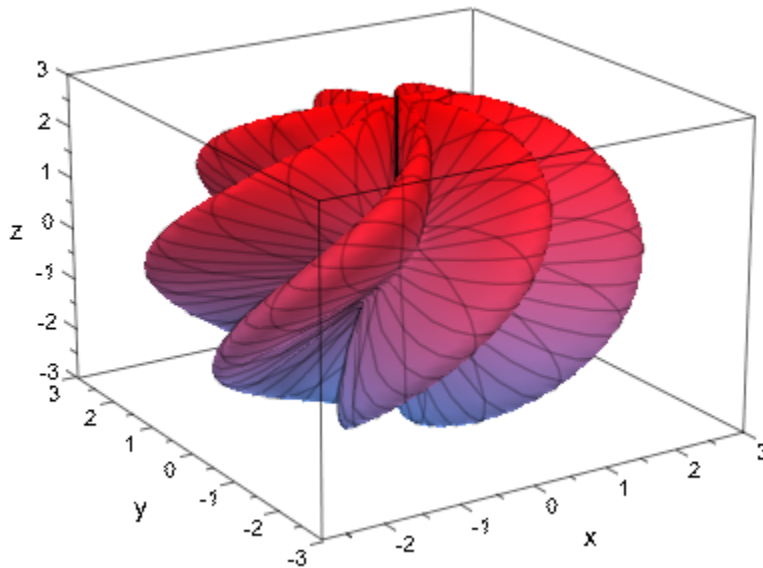

```
delete r, x, y, z:
```

### Example 7

By default, the parameter lines of a parametrized surface are “switched on”:

```
x := r*cos(phi):  
y := r*sin(phi):  
z := r^2:  
plot(plot::Surface([x, y, z], r = 1/3 .. 1, phi = 0 .. 2*PI)):
```

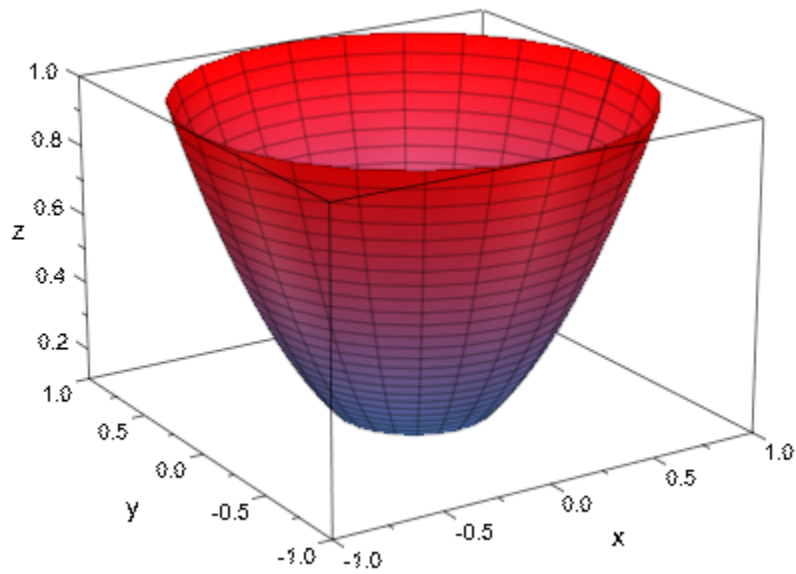

The parameter lines are “switched off”:

```
plot(plot::Surface([x, y, z], r = 1/3 .. 1, phi = 0 .. 2*PI,  
                 ULinesVisible = FALSE,  
                 VLinesVisible = FALSE)):
```

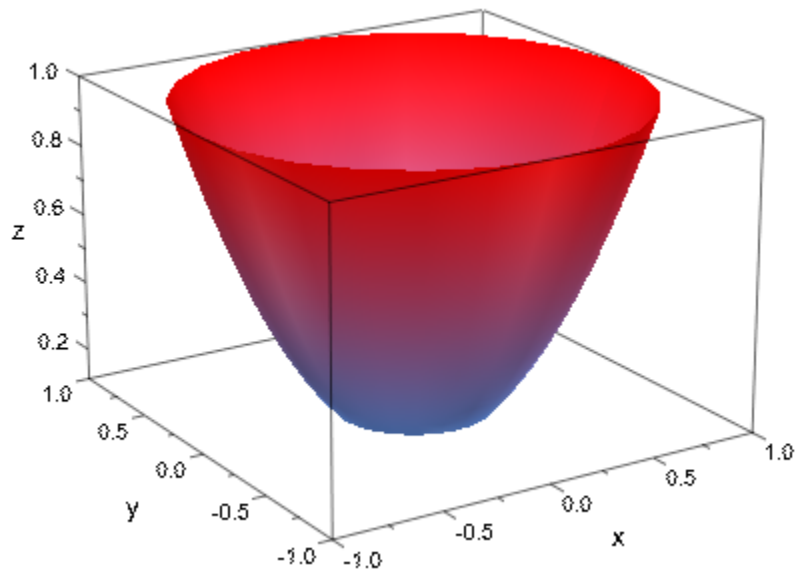

The number of parameter lines are determined by the attributes UMesh and VMesh:

```
plot(plot::Surface([x, y, z], r = 1/3 .. 1, phi = 0 .. 2*PI,  
UMesh = 5, VMesh = 12)):
```

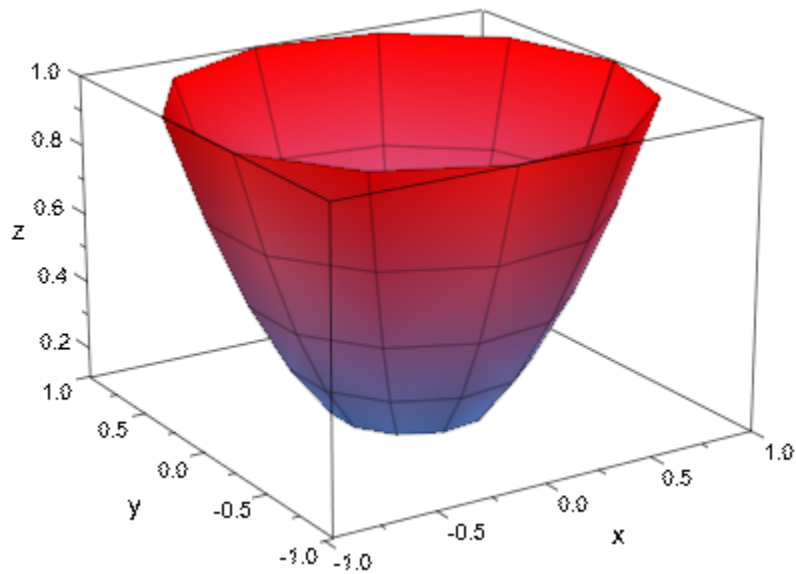

When the mesh is refined via the attributes USubmesh, VSubmesh, the numerical approximation of the surface becomes smoother. However, the number of parameter lines is determined by the values of UMesh, VMesh and is not increased:

```
plot(plot::Surface([x, y, z], r = 1/3 .. 1, phi = 0 .. 2*PI,  
    UMesh = 5, VMesh = 12,  
    USubmesh = 1, VSubmesh = 2)):
```

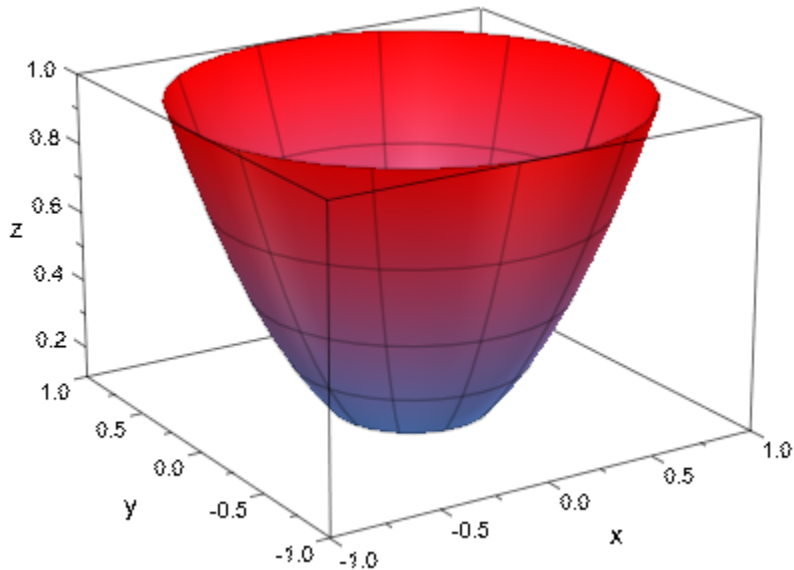

### Example 8

Klein's bottle is a surface without orientation. There is no “inside” and no “outside” of the following object:

```

bx := u -> -6*cos(u)*(1 + sin(u)):
by := u -> -14*sin(u):
r := u -> 4 - 2*cos(u):
x := (u, v) -> piecewise([u <= PI, bx(u) - r(u)*cos(u)*cos(v)],
                        [PI < u, bx(u) + r(u)*cos(v)]):
y := (u, v) -> r(u)*sin(v):
z := (u, v) -> piecewise([u <= PI, by(u) - r(u)*sin(u)*cos(v)],
                        [PI < u, by(u)]):
KleinBottle:= plot::Surface(
    [x, y, z], u = 0 .. 2*PI, v = 0 .. 2*PI,
    Mesh = [35, 31], LineColor = RGB::Black.[0.2],
    FillColorFunction = RGB::MuPADGold):
plot(KleinBottle, Axes = None, Scaling = Constrained,
     Width = 60*unit::mm, Height = 72*unit::mm,
     BackgroundStyle = Pyramid):

```

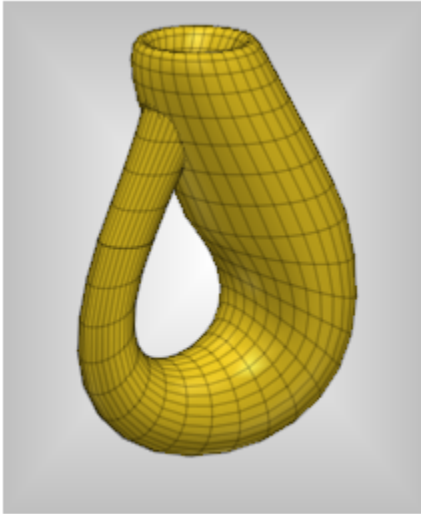

delete bx, by, r, x, y, z, KleinBottle:

## Example 9

Finally we create an animated surface plot of  $(u, v) \rightarrow (\sin(u), \sin(v), a \sin(u+v))$  where  $a$  is the animation parameter:

```
plot(  
  plot::Surface(  
    [sin(u),sin(v),a*sin(u+v)],  
    u=0..2*PI, v=0..2*PI, a=1..0,  
    AnimationStyle = BackAndForth  
  )  
)
```

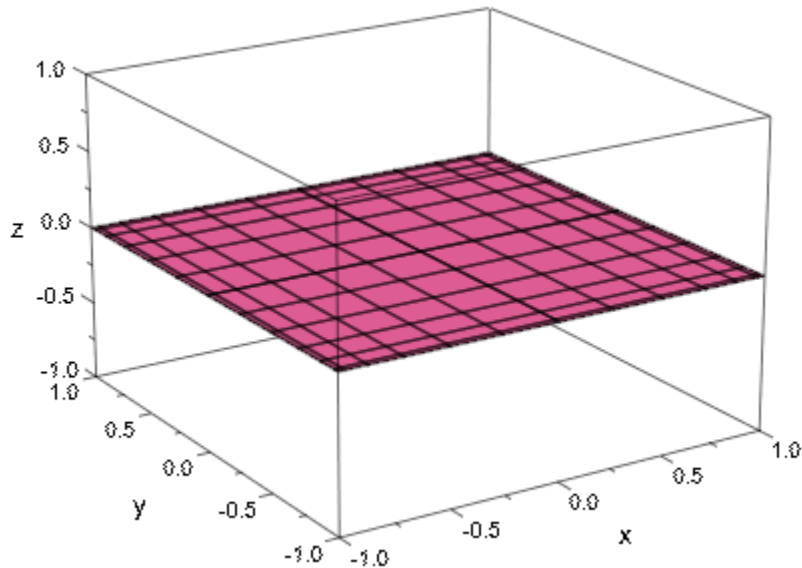

## Parameters

### **x, y, z**

The coordinate functions: arithmetical expressions (Symbolic Math Toolbox) or piecewise objects depending on the surface parameters  $u$ ,  $v$  and the animation parameter  $a$ . Alternatively, procedures on page 1-1654 that accept 2 input parameters  $u$ ,  $v$  or 3 input parameters  $u$ ,  $v$ ,  $a$  and return a numerical value when the input parameters are numerical.

$x$ ,  $y$ ,  $z$  are equivalent to the attributes XFunction, YFunction, ZFunction.

### **xyz**

The parametrization: a procedure on page 1-1654 that accepts 2 input parameters  $u$ ,  $v$  or 3 input parameters  $u$ ,  $v$ ,  $a$  and returns a list of 3 numerical values  $[x, y, z]$ .



**A**

A matrix on page 1-1340 of category `Cat::Matrix` with three entries that provide the parametrization  $x, y, z$

**u**

The first surface parameter: an identifier on page 7-29 or an indexed identifier on page 1-1017.

$u$  is equivalent to the attribute `UName`.

 **$u_{\min} \dots u_{\max}$** 

The plot range for the parameter  $u$ :  $u_{\min}, u_{\max}$  must be numerical real values or expressions of the animation parameter  $a$ .

$u_{\min} \dots u_{\max}$  is equivalent to the attributes `URange`, `UMin`, `UMax`.

**v**

The second surface parameter: an identifier on page 7-29 or an indexed identifier on page 1-1017.

$v$  is equivalent to the attribute `VName`.

 **$v_{\min} \dots v_{\max}$** 

The plot range for the parameter  $v$ :  $v_{\min}, v_{\max}$  must be numerical real values or expressions of the animation parameter  $a$ .

$v_{\min} \dots v_{\max}$  is equivalent to the attributes `VRange`, `VMin`, `VMax`.

**a**

Animation parameter, specified as  $a = a_{\min} \dots a_{\max}$ , where  $a_{\min}$  is the initial parameter value, and  $a_{\max}$  is the final parameter value.

## See Also

**MuPAD Functions**

`plot` | `plot::copy` | `plotfunc3d`

**MuPAD Graphical Primitives**

`plot::Function3d | plot::Matrixplot`

# plot::SurfaceSet

Triangle and quad surface meshes

## Syntax

```
plot::SurfaceSet(meshlist, <MeshListType = t>, <MeshListNormals = n>, <UseNormals = b>
```

## Description

`plot::SurfaceSet(MeshList)` creates a 3D graphical object from a given list of triangle or quad coordinates.

`MeshList` contains coordinates of points (and optional normals) of either triangles or quads which define a mesh of a 3D surface. The points must be given homogenous: If a normal is given, it must be given for all points or facets, respectively. The attribute `MeshListType` specifies how these points are to be interpreted for plotting the surface. The attribute `MeshListNormals` specifies whether the list contains normal vectors and at which positions they located.

`MeshListType` specifies how the points in `MeshList` are to be interpreted for plotting the surface. See `MeshList` for more information about mesh list types. Cf. “Example 4” on page 24-836 (Symbolic Math Toolbox).

`MeshListNormals` specifies whether `MeshList` contains normals and at which positions they are located. See `MeshList` for more information about normals and facet orientation.

When setting the attribute `UseNormals` to `FALSE` the normals defined in `MeshList` are ignored when plotting the object in MuPAD. This reduces the data volume of the graphics object and the computing time as well. However, it leads to a less brilliant image.

User-defined color functions `LineColorFunction` and `FillColorFunction` will be called with the index of the current point as its first parameter, followed by the  $x$ ,  $y$ , and  $z$  coordinate of the current point.

The transformation objects `plot::Rotate3d`, `plot::Scale3d`, `plot::Translate3d` and `plot::Transform3d` can be applied to the imported STL object. Cf. “Example 8” on page 24-848 (Symbolic Math Toolbox).

## Attributes

Attribute	Purpose	Default Value
<code>AffectViewingBox</code>	influence of objects on the <code>ViewingBox</code> of a scene	TRUE
<code>Color</code>	the main color	<code>RGB::Red</code>
<code>Filled</code>	filled or transparent areas and surfaces	TRUE
<code>FillColor</code>	color of areas and surfaces	<code>RGB::Red</code>
<code>FillColor2</code>	second color of areas and surfaces for color blends	<code>RGB::CornflowerBlue</code>
<code>FillColorType</code>	surface filling types	Dichromatic
<code>FillColorFunction</code>	functional area/surface coloring	
<code>FillColorDirection</code>	the direction of color transitions on surfaces	[0, 0, 1]
<code>FillColorDirectionX</code>	x-component of the direction of color transitions on surfaces	0
<code>FillColorDirectionY</code>	y-component of the direction of color transitions on surfaces	0
<code>FillColorDirectionZ</code>	z-component of the direction of color transitions on surfaces	1
<code>Frames</code>	the number of frames in an animation	50
<code>Legend</code>	makes a legend entry	

Attribute	Purpose	Default Value
LegendText	short explanatory text for legend	
LegendEntry	add this object to the legend?	FALSE
LineColor	color of lines	RGB::Black.[0.25]
LineWidth	width of lines	0.35
LineColor2	color of lines	RGB::DeepPink
LineStyle	solid, dashed or dotted lines?	Solid
LineColorType	line coloring types	Flat
LineColorFunction	functional line coloring	
LineColorDirection	the direction of color transitions on lines	[0, 0, 1]
LineColorDirectionX	x-component of the direction of color transitions on lines	0
LineColorDirectionY	y-component of the direction of color transitions on lines	0
LineColorDirectionZ	z-component of the direction of color transitions on lines	1
MeshList	triangulation data	
MeshVisible	visibility of irregular mesh lines in 3D	FALSE
MeshListType	triangulation data	Triangles
MeshListNormals	triangulation data	None
Name	the name of a plot object (for browser and legend)	
ParameterEnd	end value of the animation parameter	
ParameterName	name of the animation parameter	

<b>Attribute</b>	<b>Purpose</b>	<b>Default Value</b>
ParameterBegin	initial value of the animation parameter	
ParameterRange	range of the animation parameter	
PointSize	the size of points	1.5
PointStyle	the presentation style of points	FilledCircles
PointsVisible	visibility of mesh points	FALSE
Shading	smooth color blend of surfaces	Smooth
TimeEnd	end time of the animation	10.0
TimeBegin	start time of the animation	0.0
TimeRange	the real time span of an animation	0.0 .. 10.0
Title	object title	
TitleFont	font of object titles	[" sans-serif ", 11]
TitlePosition	position of object titles	
TitleAlignment	horizontal alignment of titles w.r.t. their coordinates	Center
TitlePositionX	position of object titles, x component	
TitlePositionY	position of object titles, y component	
TitlePositionZ	position of object titles, z component	
UseNormals	use pre-defined normals?	TRUE
Visible	visibility	TRUE
VisibleAfter	object visible after this time value	
VisibleBefore	object visible until this time value	

Attribute	Purpose	Default Value
VisibleFromTo	object visible during this time range	
VisibleAfterEnd	object visible after its animation time ended?	TRUE
VisibleBeforeBegin	object visible before its animation time starts?	TRUE

## Examples

### Example 1

When given a list of real numbers, `plot::SurfaceSet` by default considers them as the coordinates of points in 3D forming triangles. Note that we are using `FillColorFunction` here to make the triangles easier to see and that the number of values must be divisible by 9, since each triangle needs 9 numbers to be specified:

```
plot(plot::SurfaceSet([frandom() $ i = 1..9*5],  
  FillColorFunction = (i -> RGB::ColorList[floor((i+2)/3)]))):
```

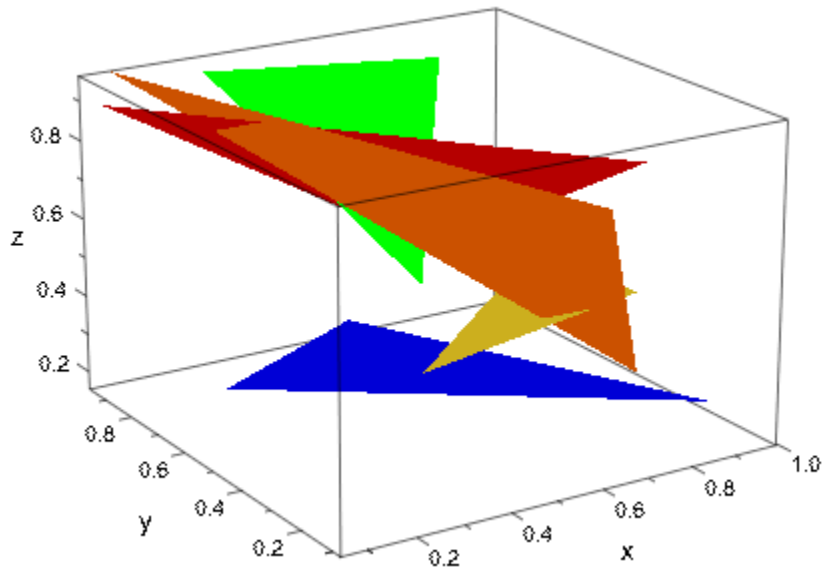

## Example 2

This example demonstrates how surface sets can be created and animated in MuPAD. First we create a mesh of points:

```
delete cx, cy, cz, r:
F:= [[cx-r ,cy-r+a,cz+r], [cx-r+a,cy-r ,cz+r],
      [cx+r-a,cy-r ,cz+r], [cx+r ,cy-r+a,cz+r],
      [cx+r ,cy+r-a,cz+r], [cx+r-a,cy+r ,cz+r],
      [cx-r+a,cy+r ,cz+r], [cx-r ,cy+r-a,cz+r]],
     [[cx+r,cy-r ,cz-r+a], [cx+r,cy-r+a,cz-r ],
      [cx+r,cy+r-a,cz-r ], [cx+r,cy+r ,cz-r+a],
      [cx+r,cy+r ,cz+r-a], [cx+r,cy+r-a,cz+r ],
      [cx+r,cy-r+a,cz+r ], [cx+r,cy-r ,cz+r-a]],
     [[cx-r ,cy+r,cz-r+a], [cx-r+a,cy+r,cz-r ],
      [cx+r-a,cy+r,cz-r ], [cx+r ,cy+r,cz-r+a],
      [cx+r ,cy+r,cz+r-a], [cx+r-a,cy+r,cz+r ],
      [cx-r+a,cy+r,cz+r ], [cx-r ,cy+r,cz+r-a]]]:
F:= F.[subs(F[1], cz+r=cz-r),
      subs(F[2], cx+r=cx-r),
```



```

subs(F[3], cy+r=cy-r]):
T:= [[cx+r,cy-r+a,cz+r], [cx+r-a,cy-r,cz+r], [cx+r,cy-r,cz+r-a]]:
T:= T.subs(T, cx+r-a=cx-r+a, cx+r=cx-r):
T:= T.subs(T, cy-r+a=cy+r-a, cy-r=cy+r):
T:= T.subs(T, cz+r-a=cz-r+a, cz+r=cz-r):

```

Then we create plot objects using the mesh above:

```

cx := 0: cy := 0: cz := 0:
r := 1:
P := range ->
  plot::Group3d(
    plot::Group3d(
      plot::SurfaceSet(map(F[i], op), a = range,
        MeshListType = TriangleFan)
      $ i=1..6),
    plot::Group3d(
      plot::Polygon3d(F[i], a = range, Closed) $ i=1..6,
      LineWidth = 1.5,
      LineColor = RGB::Grey,
      PointsVisible,
      PointSize = 3),
    plot::Group3d(
      plot::SurfaceSet(map(T, op), a = range),
      FillColorType = Flat,
      FillColor=RGB::Yellow,
      Filled)
  ):
plot(P(0..r),
  Scaling = Constrained,
  Width = 120, Height = 120,
  Axes = None):

```

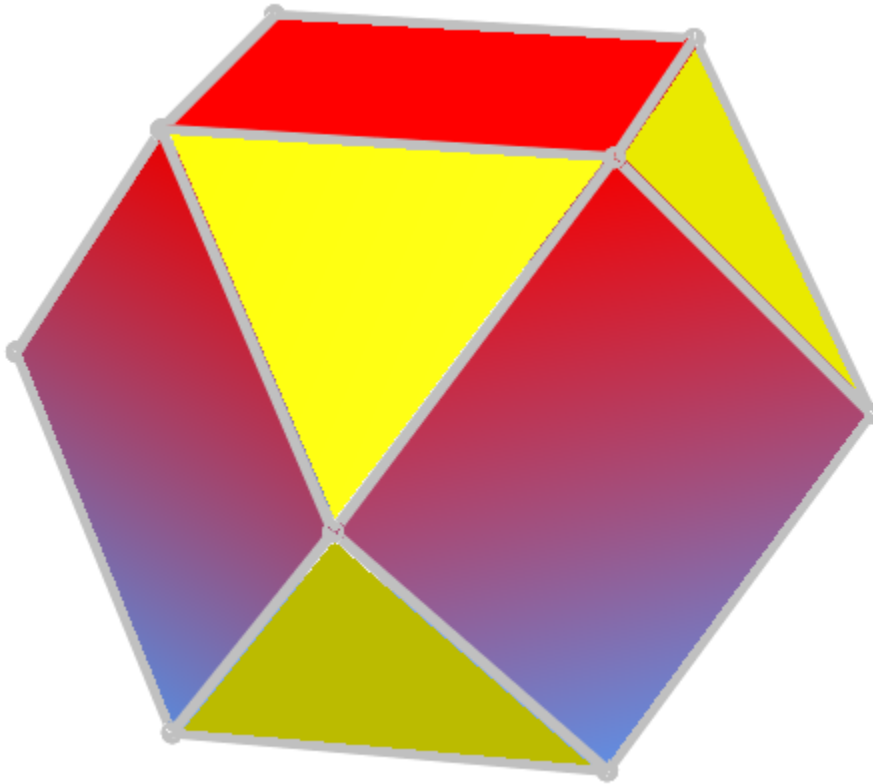

The first half of this animation is plotted again. In the left image we can see how parts of the surface set are constructed as triangle fan. In the right image parts of the surface are displayed as wireframe:

```
plot(  
  plot::Scene3d(P(0..r/2), MeshVisible = TRUE),  
  plot::Scene3d(P(0..r/2), Filled = FALSE),  
  Scaling = Constrained, Width = 150, Height = 75,  
  Axes = None, Layout = Horizontal  
):
```

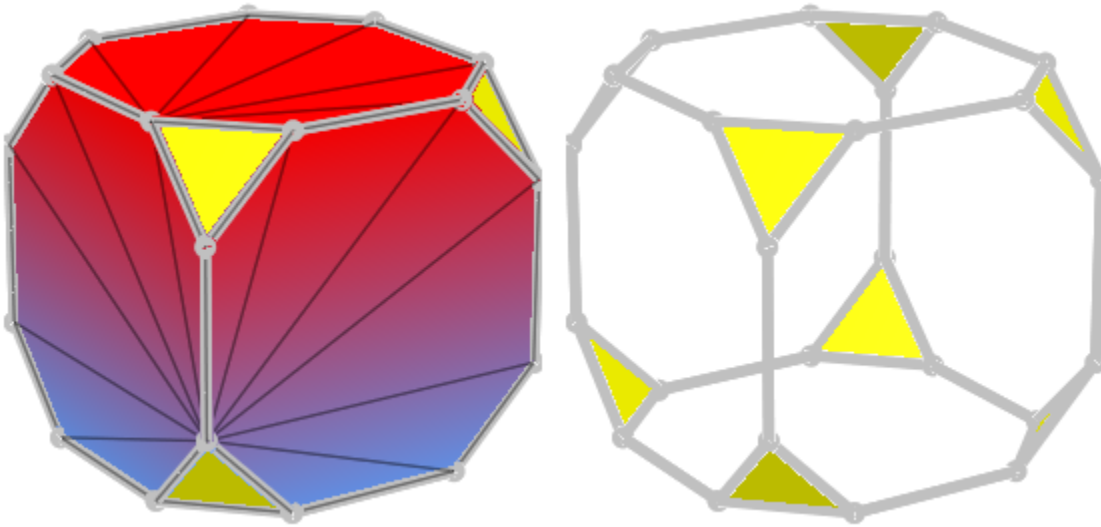

### Example 3

A second animation demonstrates the fold back of a cube:

```

r := 1:
bottom := [[0, 0, 0], [r, 0, 0],
           [r, r, 0], [0, r, 0]]:
left    := [[0, 0, 0], [0, -r*sin(a), r*cos(a)],
           [r, -r*sin(a), r*cos(a)], [r, 0, 0]]:
right   := map(left, l -> [l[1], r-l[2], l[3]]):
front   := map(left, l -> [l[2], l[1], l[3]]):
back    := map(right, l -> [l[2], l[1], l[3]]):
top     := [left[3], left[2],
           zip(left[2], [0, -r*sin(2*a-PI/2), r*cos(2*a-PI/2)], `+`),
           zip(left[3], [0, -r*sin(2*a-PI/2), r*cos(2*a-PI/2)], `+`)]:

plot(plot::SurfaceSet(map(bottom.left.top.right.front.back, op),
                        MeshListType = Quads,
                        PointsVisible = TRUE,
                        PointSize = 3,
                        MeshVisible = TRUE,
                        LineWidth = 1.5,
                        LineColor = RGB::Grey,

```

```
a=0..PI/2),  
plot::MuPADCube(Radius = r/3, Center = [r/2 $ 3]),  
Scaling = Constrained)
```

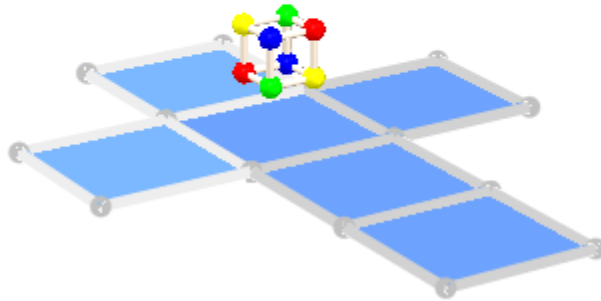

```
delete r, bottom, left, right, front, back, top:
```

## Example 4

Let's have a deeper look on the different kind of mesh types. We create a mesh of points first and then plot it using the different mesh types available. The first point will always be plotted in red color:

```
PL:= [((0,i,0.5-0.1*i), (1,i,0.5-0.1*i)) $ i = 0..5]:  
S0:= FillColorFunction =  
  ((n,x,y,z)->[RGB::Blue,RGB::Red,RGB::Green][(n mod 3)+1]),  
  LineColorFunction =  
  ((n,x,y,z)-> if n=1 then RGB::Red else RGB::Black end_if),  
  PointsVisible:  
V0:= plot::Camera([0.5,2.5,4.5], [0.5,2.51,0], 0.2),  
  ViewingBox = [0..1,0..5,0..0.5],  
  Axes = None:
```

We tell MuPAD to interpret the given mesh list as a set of separate triangles. The corresponding plot looks like this:

```
plot(plot::SurfaceSet(PL, S0, MeshListType = Triangles), V0):
```

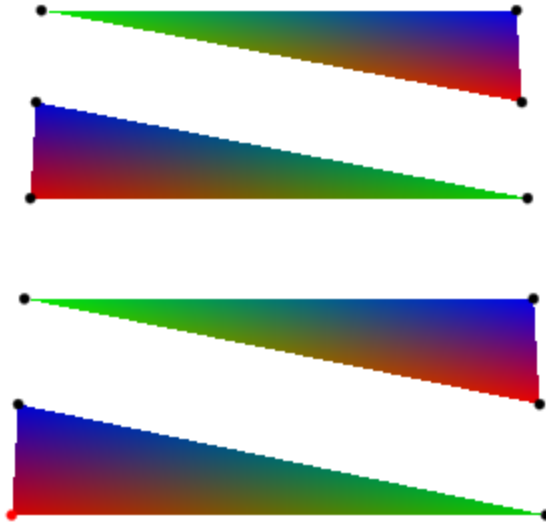

We tell MuPAD to interpret the given mesh list as a triangle fan. The corresponding plot looks like this:

```
plot(plot::SurfaceSet(PL, S0, MeshListType = TriangleFan), V0):
```

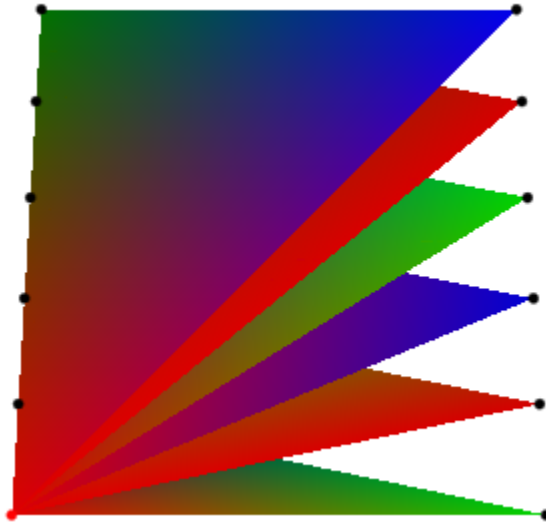

The plot above looks a little bit confusing, thus we let MuPAD plot the first four triangles step by step in order to learn how the whole fan will be created:

```
plot(  
  plot::Scene3d(  
    plot::SurfaceSet(PL[1..3*n], S0, MeshListType = TriangleFan),  
    V0  
  ) $ n=3..6  
):
```

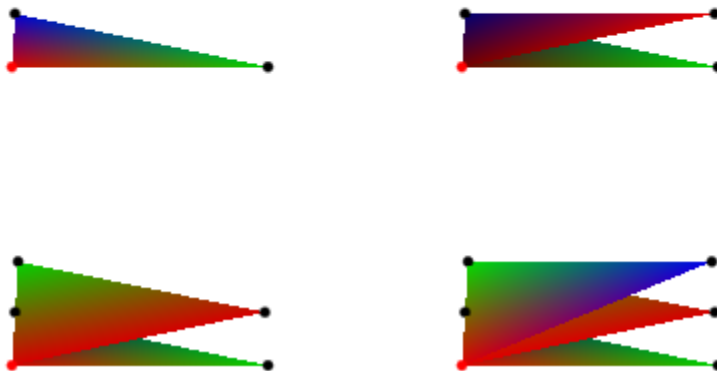

We tell MuPAD to interpret the given mesh list as a triangle strip. The corresponding plot looks like this:

```
plot(plot::SurfaceSet(PL, S0, MeshListType = TriangleStrip), V0):
```

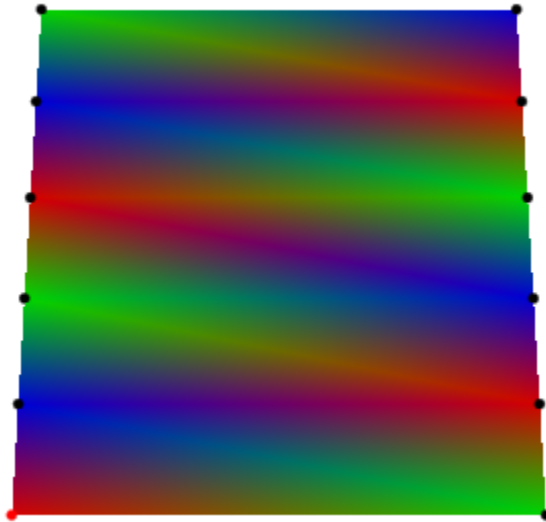

We tell MuPAD to interpret the given mesh list as a set of separate quads. The corresponding plot looks like this:

```
plot(plot::SurfaceSet(PL, S0, MeshListType = Quads), V0):
```



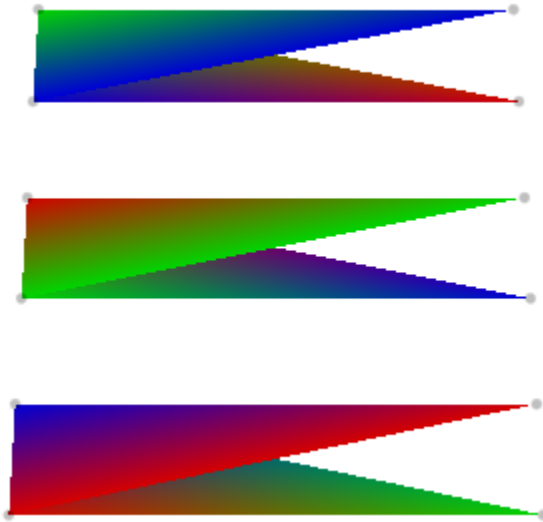

The reason for plotting triangles instead of (the expected) rectangles is the order of the points in the point list. Changing the order of the second and third point, we get the expected result:

```
PK:= PL: tmp:= PK[7]: PK[7]:= PK[10]: PK[10]:=tmp:  
plot(plot::SurfaceSet(PK, S0, MeshListType = Quads), V0):  
delete PK, tmp:
```

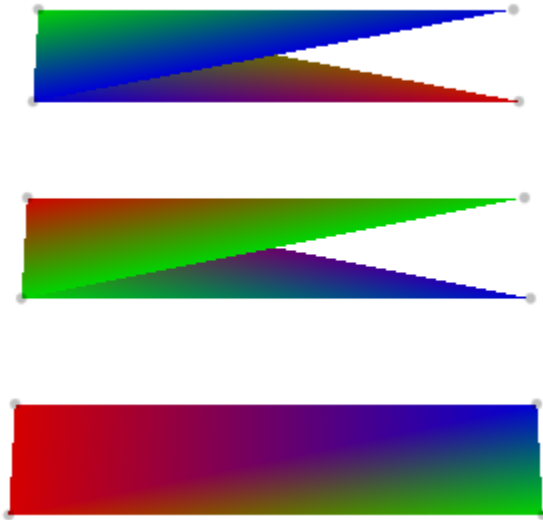

We tell MuPAD to interpret the given mesh list as a quad strip. The corresponding plot looks like this:

```
plot(plot::SurfaceSet(PL, S0, MeshListType = QuadStrip), V0):  
delete PL, S0, V0:
```

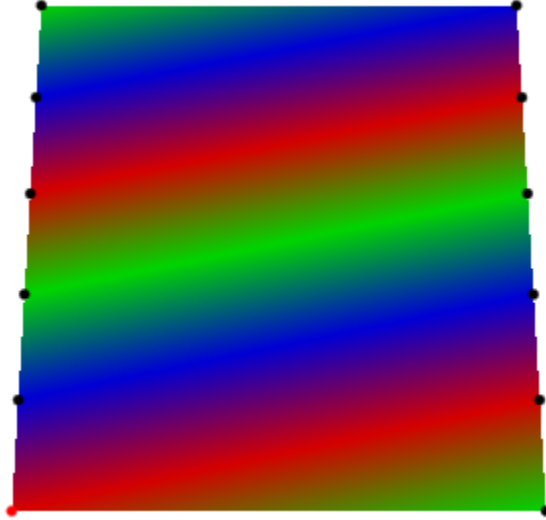

### Example 5

It is possible to include normals to give smooth shading for surfaces that are not supposed to look like flat triangles. In the following example, we use a triangulation of a rectangle:

```
trias := ([[x, y ], [(x+1), y], [ x , (y+1)],
           [x, (y+1)], [(x+1), y], [(x+1), (y+1)]]
          $ x = 1..4 $ y = 1..4):
```

Mapping the function  $(x, y) \rightarrow \sin(x) \cos(y)$  to these points, we get the following surface plot:

```
f := (x,y) -> sin(x)*cos(y):
meshList := map(trias, l -> [l[1], l[2], f(l[1], l[2])]):
plot(plot::SurfaceSet(meshList, MeshListType = Triangles))
```

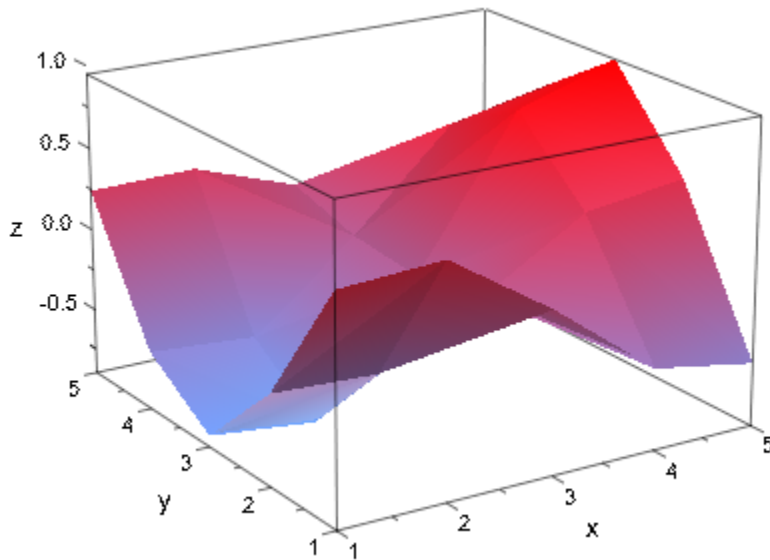

The triangulation is clearly visible. One way to reduce this would be to refine the mesh, but this may take a lot of time with more complicated functions or be completely impossible for measurement data. It is much faster to give MuPAD more information on the surface, namely, the direction of the tangent planes at the points we evaluated:

```
normals := map(trias, l -> [D([1], f)(l[1], l[2]),
                           D([2], f)(l[1], l[2]), 1]):
plot(plot::SurfaceSet(zip(meshList, normals, _exprseq),
                        MeshListType = Triangles,
                        MeshListNormals = BehindPoints))
```

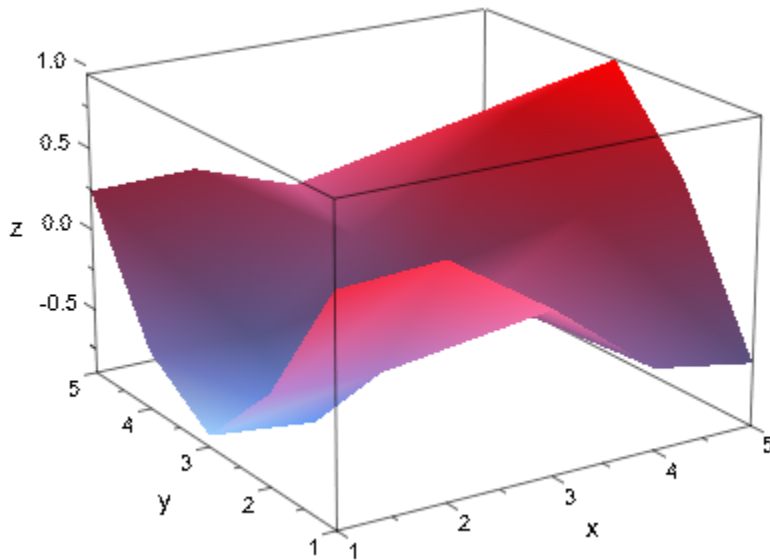

As you can see (especially at the border; otherwise, switch on `LinesVisible`), MuPAD still draws the triangles at exactly the same places, but uses a color shading to create the illusion of a smooth surface.

## Example 6

We create a triangle mesh with normals in front of each triangle and plot this object, a tetrahedron, afterwards:

```
meshList:= [
  0.0 ,  0.0 , -1.0 ,
 -1.5 , -1.5 , 1.4 ,  0.0,  1.7, 1.4, 1.5, -1.5,  1.4,
  0.0 ,  0.88,  0.47,
 -1.5 , -1.5 , 1.4 ,  1.5, -1.5, 1.4, 0.0,  0.0, -1.4,
 -0.88, -0.41,  0.25,
  1.5 , -1.5 , 1.4 ,  0.0,  1.7, 1.4, 0.0,  0.0, -1.4,
  0.88, -0.41,  0.25,
  0.0 ,  1.7 ,  1.4 , -1.5, -1.5, 1.4, 0.0,  0.0, -1.4
]:
plot(
  plot::SurfaceSet(meshList,
```

```

MeshListType    = Triangles,
MeshListNormals = BeforeFacets
)
):

```

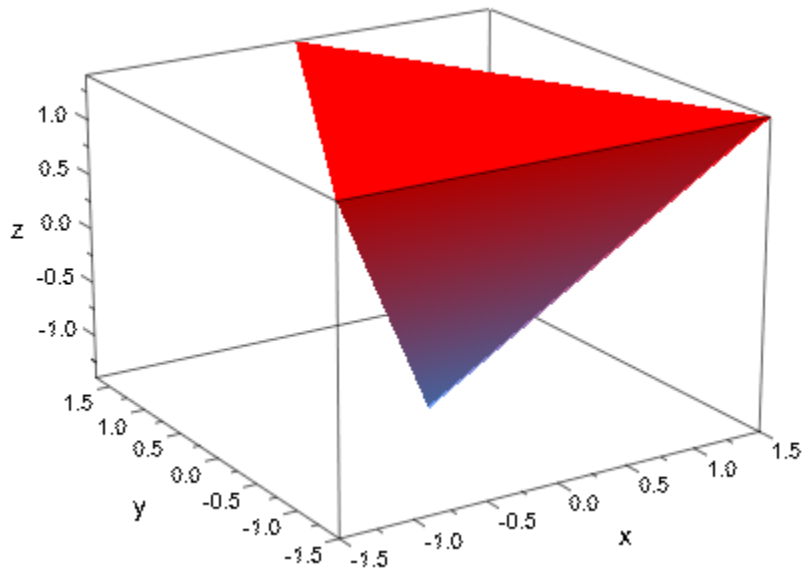

## Example 7

A color function `FillColorFunction` can be specified. The procedure is called for each vertex: the parameters are the index of the current triangle followed by the x-, y- and z-coordinate of the current vertex:

```

plot(
  plot::Scene3d(
    plot::SurfaceSet(meshList, MeshListNormals = BeforeFacets,
      MeshVisible = TRUE,
      LineColor    = RGB::Black,
      FillColorFunction =
        (n ->[RGB::Red,RGB::Blue,RGB::Green,RGB::Yellow]
          [n+2 div 3])
    )
  ),
)

```

```

plot::Scene3d(
  plot::SurfaceSet(meshList, MeshListNormals = BeforeFacets,
    MeshVisible = TRUE,
    LineColor    = RGB::Black,
    FillColorFunction = ((n,x,y,z) -> [x/2,y/2,z/2])
  )
),
Axes = None, Layout = Horizontal
):

```



The same is true for a LineColorFunction:

```

plot(
  plot::Scene3d(
    plot::SurfaceSet(meshList, MeshListNormals = BeforeFacets,
      MeshVisible = TRUE,
      PointsVisible = TRUE,
      Filled = FALSE,
      LineWidth = 2,
      LineColorFunction =
        (n -> [RGB::Red,RGB::Blue,RGB::Green,RGB::Yellow][n+2 div 3])
    )
  ),
):

```

```
plot::Scene3d(
  plot::SurfaceSet(meshList, MeshListNormals = BeforeFacets,
    MeshVisible = TRUE,
    PointsVisible = TRUE,
    Filled = FALSE,
    LineWidth = 2,
    LineColorFunction = ((n,x,y,z) -> [x/4,y/4,z/4])
  )
),
Axes = None, Layout = Horizontal
):
```

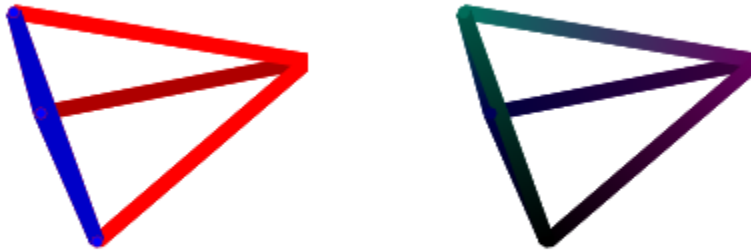

## Example 8

Again we plot the object defined in “Example 6” on page 24-845 (Symbolic Math Toolbox), but now we add a rotated, scaled and translated copy of it:

```
plot(
  plot::Scene3d(
    plot::SurfaceSet(meshList, MeshListNormals = BeforeFacets),
    plot::Scale3d([2,2,2],
      plot::SurfaceSet(meshList, MeshListNormals = BeforeFacets,
```



```
        Color = RGB::Blue.[0.1])
    ),
    plot::Scene3d(
        plot::SurfaceSet(meshList, MeshListNormals = BeforeFacets),
        plot::Rotate3d(PI, Axis=[1,0,0],
            plot::SurfaceSet(meshList, MeshListNormals = BeforeFacets,
                Color = RGB::Blue.[0.1])
        )
    ),
    plot::Scene3d(
        plot::SurfaceSet(meshList, MeshListNormals = BeforeFacets),
        plot::Translate3d([1,1,1],
            plot::SurfaceSet(meshList, MeshListNormals = BeforeFacets,
                Color = RGB::Blue.[0.1])
        )
    ),
    plot::Scene3d(
        plot::SurfaceSet(meshList, MeshListNormals = BeforeFacets),
        plot::Transform3d([0,0,0], [1,0,0, 0,1,0, 0,0,-1],
            plot::SurfaceSet(meshList, MeshListNormals = BeforeFacets,
                Color = RGB::Blue.[0.1])
        )
    ),
    Width = 120, Height = 120
):
```

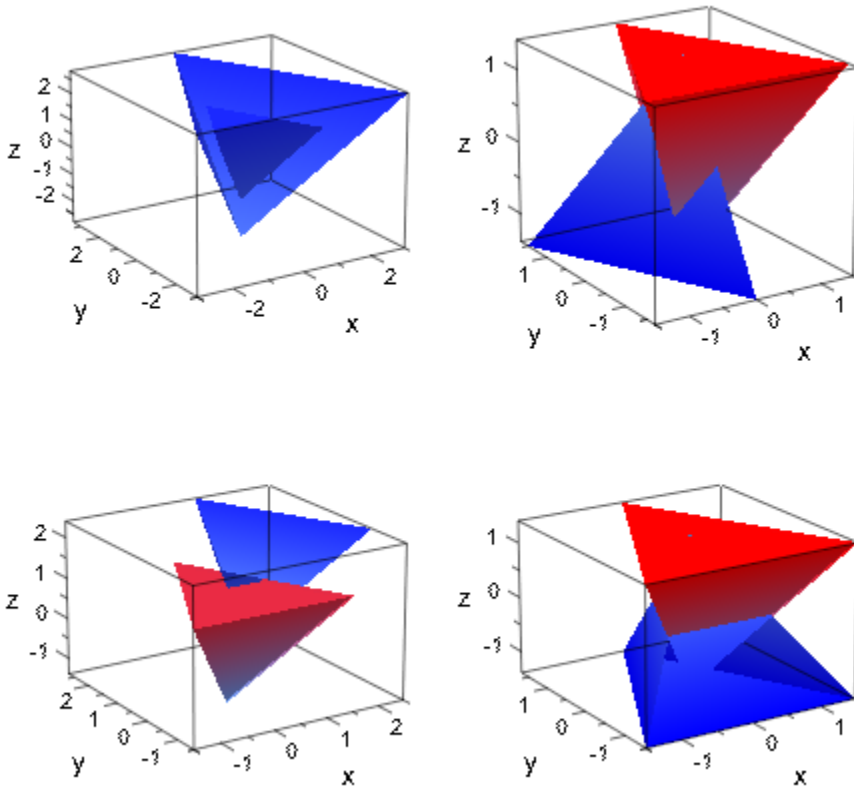

## Parameters

### **meshlist**

The point list: a list of coordinates of type DOM\_FLOAT.

meshlist is equivalent to the attribute MeshList.

**a**

Animation parameter, specified as  $a = a_{\min} \dots a_{\max}$ , where  $a_{\min}$  is the initial parameter value, and  $a_{\max}$  is the final parameter value.

## Options

### MeshListType

Option, specified as `MeshListType = t`

`t` may be `Triangles`, `TriangleFan`, `TriangleStrip`, `Quads` or `QuadStrip`. This attribute specifies the kind of surface mesh given in `MeshList`. This means it specifies how the point coordinates in `MeshList` are to be interpreted.

### MeshListNormals

Option, specified as `MeshListNormals = n`

`n` may be `None`, `BeforePoints`, `BehindPoints`, `BeforeFacets` or `BehindFacets`. This attribute specifies whether `MeshList` contains normal vectors and at which positions they are located.

### UseNormals

Option, specified as `UseNormals = b`

`b` may be `TRUE` or `FALSE`. This attribute specifies whether the normals defined in the STL file are used for the MuPAD plot.

## Algorithms

The normal of a facet (a triangle or quad) given in `MeshList` is used for all its vertices when plotting this object. Due to the fact that some facets may share points with other facets, these points may be specified with different normals.

## See Also

### **MuPAD Functions**

`plot` | `readbytes`

### **MuPAD Graphical Primitives**

`plot::Rotate3d` | `plot::Scale3d` | `plot::Surface` | `plot::SurfaceSTL` |  
`plot::Transform3d` | `plot::Translate3d`

# plot::SurfaceSTL

Import of STL graphics files

## Syntax

```
plot::SurfaceSTL(filename, <UseNormals = b>, <a = amin .. amax>, options)
```

## Description

`plot::SurfaceSTL(filename)` creates a 3D surface object from the data of a given STL graphics file named "filename".

Stereolithography (STL) files were introduced in software by 3D Systems of Valencia, CA, as a simple method of storing information about 3D objects.

STL files contain triangulation data of 3D surfaces. Each triangle is stored as a unit normal and three vertices. The normal and the vertices are specified by three coordinates each, so there is a total of 12 numbers stored for each triangle. Read the 'Background' section of this help page for further details.

Depending on your hardware we recommend to plot STL objects with no more than 50.000 to 150.000 facets (triangles). You should activate the option 'Accelerate OpenGL<sup>®</sup>' in the VCam options menu.

`plot::SurfaceSTL` reacts to the MuPAD environment variable `READPATH`. For example, after

```
>> READPATH := READPATH, "C:\\STLFILES":
```

the file 'C:\\STLFILES\\xyz.stl' is found by the command

```
>> S := plot::SurfaceSTL("xyz.stl"):
```

Alternatively, the file name can be specified as an absolute pathname:

```
>> S := plot::SurfaceSTL("C:\\STLFILES\\xyz.stl"):
```

If a MuPAD notebook was saved to a file, its location is available inside the notebook as the environment variable `NOTEBOOKPATH`. If your STL file is in the same folder as the notebook, you may call

```
>> S := plot::SurfaceSTL(NOTEBOOKPATH."xyz.stl");
```

When setting the attribute `UseNormals` to `FALSE`, the normals defined in the STL graphics file are ignored when plotting the object in MuPAD. This reduces the data volume of the graphics object in the MuPAD session and improves the computing time as well. However, it leads to a slightly less brilliant image. Cf. “Example 2” on page 24-859 (Symbolic Math Toolbox).

The STL data do not include any color information. Hence, the imported graphics reacts to the usual settings of `FillColor`, `FillColorType` etc. for MuPAD surfaces.

Also user-defined color functions `LineColorFunction` and `FillColorFunction` can be used to color the imported surface. These functions are called with the index of the current triangle as its first parameter, followed by the  $x$ ,  $y$ , and  $z$  coordinate of the current point.

The transformation objects `plot::Rotate3d`, `plot::Scale3d`, `plot::Translate3d` and `plot::Transform3d` can be applied to the imported STL object. Cf. “Example 7” on page 24-868 (Symbolic Math Toolbox).

If an object of type `plot::SurfaceSTL` is to be plotted together with other objects, one needs to know the coordinates of the surface objects. To this end, an object `S := plot::SurfaceSTL(...)` provides the methods `S::center` and `S::boundingBox`.

The call `S::center()` returns a list of 3 floating-point values representing the 3D center of the STL object.

The call `S::boundingBox()` returns a list of 3 ranges of floating-point values representing the ranges for the  $x$ ,  $y$ , and  $z$  coordinates of the STL surface.

See “Example 2” on page 24-859 (Symbolic Math Toolbox) and “Example 5” on page 24-865 (Symbolic Math Toolbox).

`plot::SurfaceSTL::center(S)` and `plot::SurfaceSTL::boundingBox(S)`, respectively, are alternative calls.

Note that the STL graphics file must be read completely for computing these data. Also note that after a first call to `S::center()` or `S::boundingBox()`, the data are not

recomputed by these functions even if the STL object *S* has changed. Use `plot::SurfaceSTL::center(S)`, `plot::SurfaceSTL::boundingBox(S)` in such a case.

## Attributes

Attribute	Purpose	Default Value
AffectViewingBox	influence of objects on the ViewingBox of a scene	TRUE
Color	the main color	RGB::Red
Filled	filled or transparent areas and surfaces	TRUE
FillColor	color of areas and surfaces	RGB::Red
FillColor2	second color of areas and surfaces for color blends	RGB::CornflowerBlue
FillColorType	surface filling types	Dichromatic
FillColorFunction	functional area/surface coloring	
FillColorDirection	the direction of color transitions on surfaces	[0, 0, 1]
FillColorDirectionX	x-component of the direction of color transitions on surfaces	0
FillColorDirectionY	y-component of the direction of color transitions on surfaces	0
FillColorDirectionZ	z-component of the direction of color transitions on surfaces	1
Frames	the number of frames in an animation	50
InputFile	input file for import functions	

<b>Attribute</b>	<b>Purpose</b>	<b>Default Value</b>
Legend	makes a legend entry	
LegendText	short explanatory text for legend	
LegendEntry	add this object to the legend?	FALSE
LineColor	color of lines	RGB::Black.[0.25]
LineWidth	width of lines	0.35
LineColor2	color of lines	RGB::DeepPink
LineStyle	solid, dashed or dotted lines?	Solid
LineColorType	line coloring types	Flat
LineColorFunction	functional line coloring	
LineColorDirection	the direction of color transitions on lines	[0, 0, 1]
LineColorDirectionX	x-component of the direction of color transitions on lines	0
LineColorDirectionY	y-component of the direction of color transitions on lines	0
LineColorDirectionZ	z-component of the direction of color transitions on lines	1
MeshVisible	visibility of irregular mesh lines in 3D	FALSE
Name	the name of a plot object (for browser and legend)	
ParameterEnd	end value of the animation parameter	
ParameterName	name of the animation parameter	
ParameterBegin	initial value of the animation parameter	



<b>Attribute</b>	<b>Purpose</b>	<b>Default Value</b>
ParameterRange	range of the animation parameter	
PointSize	the size of points	1.5
PointStyle	the presentation style of points	FilledCircles
PointsVisible	visibility of mesh points	FALSE
Shading	smooth color blend of surfaces	Smooth
TimeEnd	end time of the animation	10.0
TimeBegin	start time of the animation	0.0
TimeRange	the real time span of an animation	0.0 .. 10.0
Title	object title	
TitleFont	font of object titles	[" sans-serif ", 11]
TitlePosition	position of object titles	
TitleAlignment	horizontal alignment of titles w.r.t. their coordinates	Center
TitlePositionX	position of object titles, x component	
TitlePositionY	position of object titles, y component	
TitlePositionZ	position of object titles, z component	
UseNormals	use pre-defined normals?	TRUE
Visible	visibility	TRUE
VisibleAfter	object visible after this time value	
VisibleBefore	object visible until this time value	
VisibleFromTo	object visible during this time range	

Attribute	Purpose	Default Value
VisibleAfterEnd	object visible after its animation time ended?	TRUE
VisibleBeforeBegin	object visible before its animation time starts?	TRUE

## Examples

### Example 1

The following imported STL graphics consists of about 110.000 triangles:

```
plot(plot::SurfaceSTL("hand.stl"),  
      CameraDirection = [15, 13, 22])
```

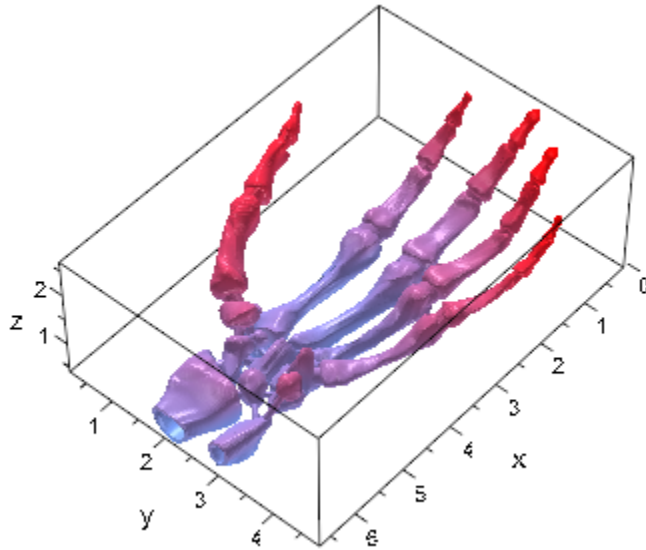

## Example 2

By default, the normals defined in an STL graphics file are used when plotting the object in MuPAD. Suppressing the use of these normals may reduce the data volume of the graphical object and speed up plotting. However, in general, this leads to slightly less brilliant images. For comparison, the following STL graphics is plotted with and without using its normals:

```
S1 := plot::SurfaceSTL("skin.stl"):
S2 := plot::SurfaceSTL("skin.stl", UseNormals = FALSE):
plot(plot::Scene3d(S1), plot::Scene3d(S2), Layout = Vertical,
      Width = 120*unit::mm, Height = 140*unit::mm,
      Axes = None, BackgroundStyle = Pyramid):
```

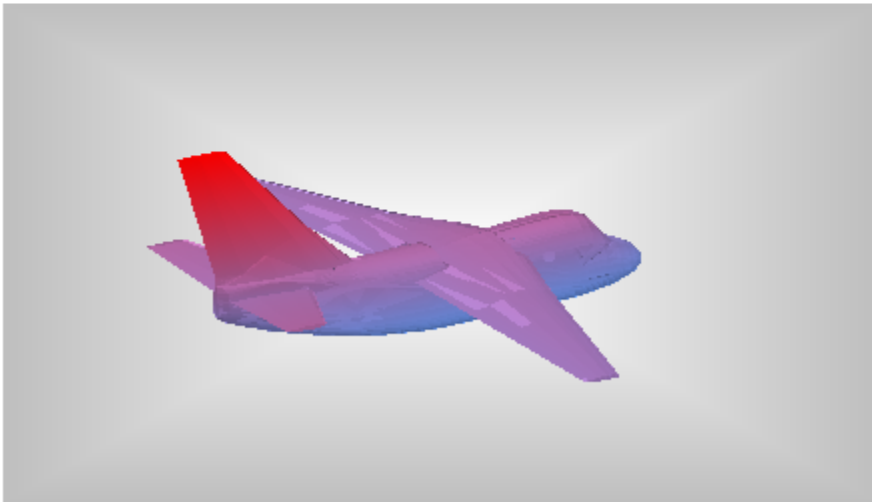
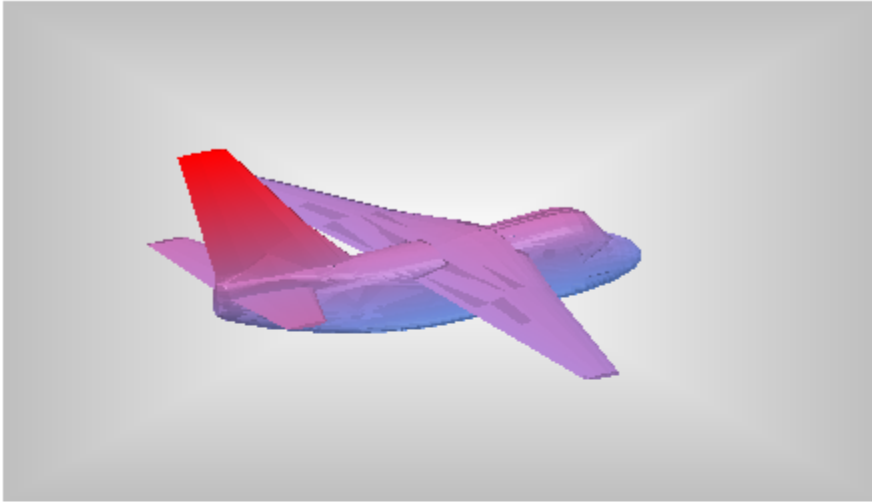

We compute the center and the bounding box of the surface:

```
S1::center()
```

```
[-422.035, 0.0, 282.1]
```

```
S1::boundingBox()
```

```
[-738.07.. -106.0, -401.5..401.5, 156.0..408.2]
```

We rotate the object around its center:

```
plot(plot::Rotate3d(a, S1::center(), [0, 0, 1], S1,
  a = 0..2*PI), Axes = None)
```

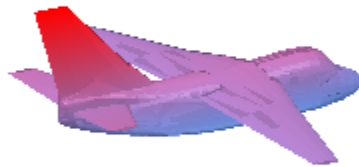

```
delete S1, S2:
```

### Example 3

The following STL graphics is displayed as a surface model and as a wireframe model:

```
nut := plot::SurfaceSTL("nut.stl"):
plot(plot::Scene3d(nut, CameraDirection = [10, 15, 30]),
  plot::Scene3d(nut, CameraDirection = [10, 15, 30],
    MeshVisible = TRUE, Filled = FALSE,
    LineColor = RGB::Black),
```

```
Axes = None, Layout = Horizontal,  
BackgroundStyle = Pyramid):
```

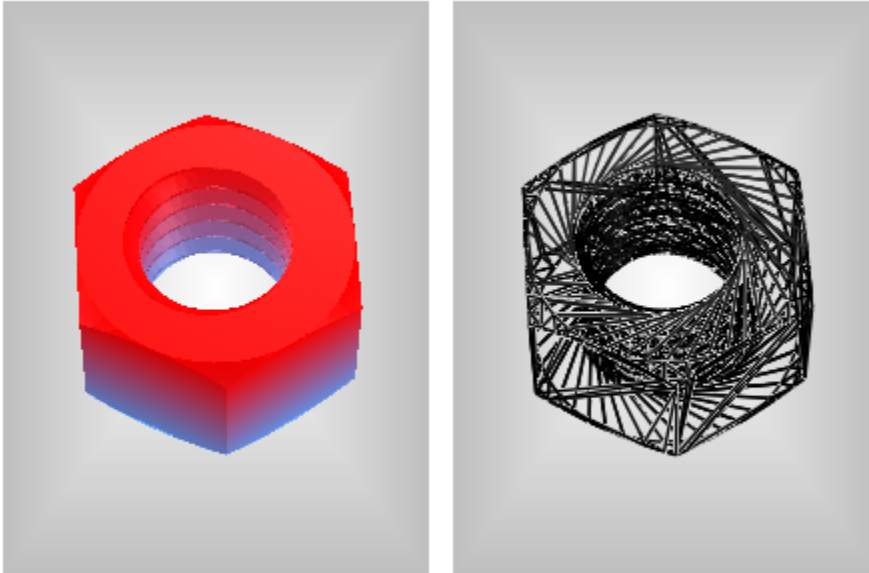

```
delete nut:
```

## Example 4

For demonstrating further features of STL file import, we first create our own STL graphics file which defines a tetrahedron:

```
stlFile := "demo.stl":  
  
fprintf(Unquoted, Text, stlFile,  
        "SOLID TRI  
        FACET NORMAL 0.0 0.0 -1.0  
        OUTER LOOP  
          VERTEX -1.5 -1.5 1.4  
          VERTEX 0.0 1.7 1.4  
          VERTEX 1.5 -1.5 1.4  
        ENDLLOOP  
        ENDFACET  
        FACET NORMAL 0.0 0.88148 0.472221
```

```
    OUTER LOOP
      VERTEX -1.5 -1.5 1.4
      VERTEX 1.5 -1.5 1.4
      VERTEX 0.0 0.0 -1.4
    ENDLLOOP
  ENDFACET
  FACET NORMAL -0.876814 -0.411007 0.24954
  OUTER LOOP
    VERTEX 1.5 -1.5 1.4
    VERTEX 0.0 1.7 1.4
    VERTEX 0.0 0.0 -1.4
  ENDLLOOP
  ENDFACET
  FACET NORMAL 0.876814 -0.411007 0.24954
  OUTER LOOP
    VERTEX 0.0 1.7 1.4
    VERTEX -1.5 -1.5 1.4
    VERTEX 0.0 0.0 -1.4
  ENDLLOOP
  ENDFACET
  ENDSOLID TRI"
)
```

This STL graphics file is imported as a MuPAD plot object and rendered:

```
plot(plot::SurfaceSTL(stlFile, MeshVisible = TRUE)):
```

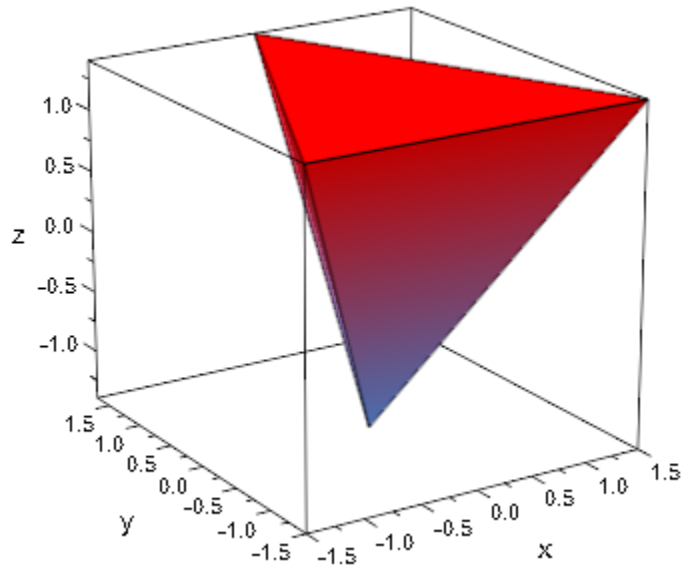

We create another STL file using `export::stl`. It contains a sphere of radius 1 parametrized by spherical coordinates:

```
export::stl("sphere.stl", [cos(u)*sin(v), sin(u)*sin(v), cos(v)],  
                          u = 0 .. 2*PI, v = 0 .. 2*PI,  
                          Mesh = [50, 50], Scaling = Constrained,  
                          OutputBox = [-1 .. 1, -1 .. 1, -1 .. 1]):  
  
plot(plot::SurfaceSTL("sphere.stl", Scaling = Constrained)):
```



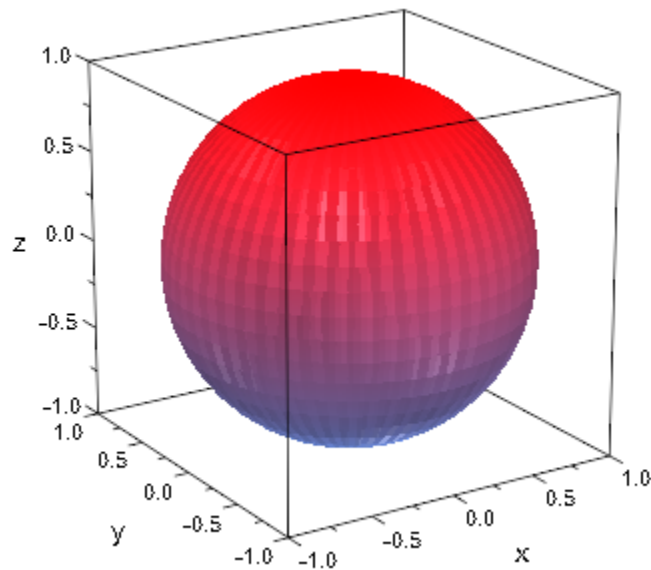

## Example 5

We plot the object defined in the STL graphics file of “Example 4” on page 24-862 (Symbolic Math Toolbox) with its bounding box:

```
S := plot::SurfaceSTL(stlFile):  
plot(S, plot::Box(op(S::boundingBox()),  
Color = RGB::Blue.[0.1])):
```

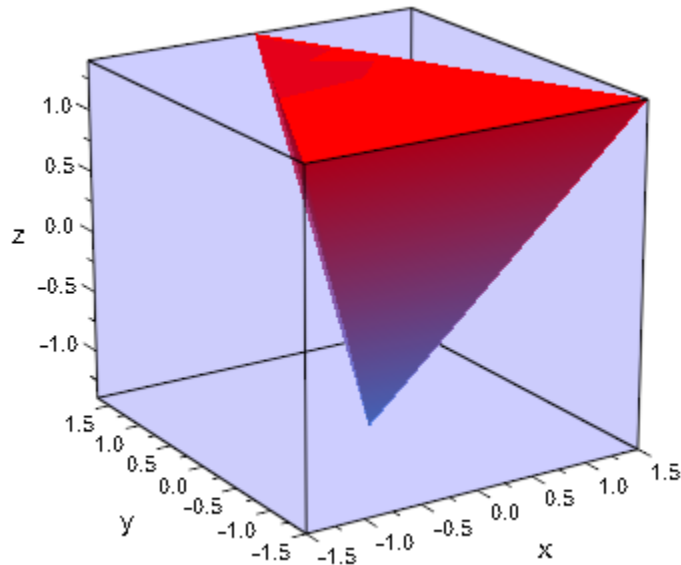

delete S:

## Example 6

A color function `FillColorFunction` can be specified. This will be called with the index of the current facet as its first parameter followed by the x-, y- and z-coordinate of the current point.

We use the object defined in the STL graphics file of “Example 4” on page 24-862 (Symbolic Math Toolbox):

```
mycolorlist:= [RGB::Red, RGB::Blue, RGB::Green, RGB::Yellow]:
plot(plot::Scene3d(plot::SurfaceSTL(stlFile,
    FillColorFunction =
        proc(n, x, y, z) begin
            mycolorlist[n]
        end_proc)),
    plot::Scene3d(plot::SurfaceSTL(stlFile,
        FillColorFunction =
            proc(n, x, y, z) begin
                [abs(x)/2, abs(y)/2, abs(z)/2]
```

```

        end_proc)),
Axes = None, Layout = Horizontal):

```

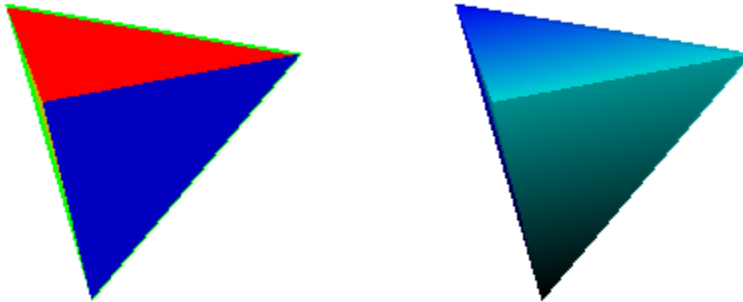

We define a `LineColorFunction`:

```

plot(plot::Scene3d(plot::SurfaceSTL(stlFile,
    LineColorFunction =
        proc(n, x, y, z) begin
            mycolorlist[n]
        end_proc)),
plot::Scene3d(plot::SurfaceSTL(stlFile,
    LineColorFunction =
        proc(n, x, y, z) begin
            [abs(x)/2, abs(y)/2, abs(z)/2]
        end_proc)),
Axes = None, Filled = FALSE, MeshVisible = TRUE,
LineWidth = 2*unit::mm, Layout = Horizontal):

```

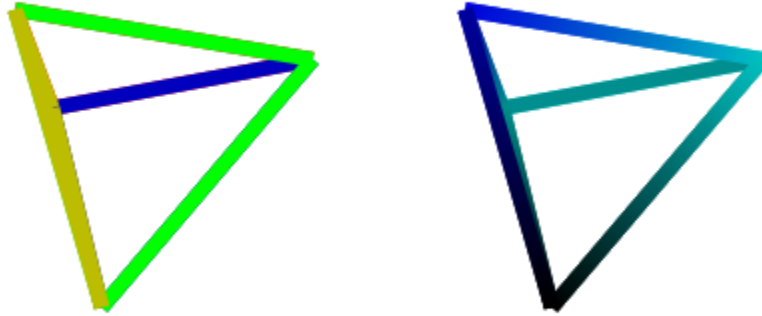

```
delete mycolorlist:
```

### Example 7

Again, we plot the object of the STL graphics file defined in “Example 4” on page 24-862 (Symbolic Math Toolbox). Here, we add rotated, scaled and translated copies:

```
plot(  
    plot::Scene3d(  
        plot::SurfaceSTL(stlFile),  
        plot::Scale3d([2, 2, 2],  
            plot::SurfaceSTL(stlFile, Color = RGB::Blue.[0.1])  
        )  
    ),  
    plot::Scene3d(  
        plot::SurfaceSTL(stlFile),  
        plot::Rotate3d(PI, Axis = [1, 0, 0],  
            plot::SurfaceSTL(stlFile, Color = RGB::Blue.[0.1])  
        )  
    ),  
    plot::Scene3d(  
        plot::SurfaceSTL(stlFile),
```

```

    plot::Translate3d([1, 1, 1],
        plot::SurfaceSTL(stlFile, Color = RGB::Blue.[0.1])
    )
),
plot::Scene3d(
    plot::SurfaceSTL(stlFile),
    plot::Transform3d([0, 0, 0], [1, 0, 0, 0, 1, 0, 0, 0, -1],
        plot::SurfaceSTL(stlFile, Color = RGB::Blue.[0.1])
    )
),
Width = 120*unit::mm, Height = 120*unit::mm):

```

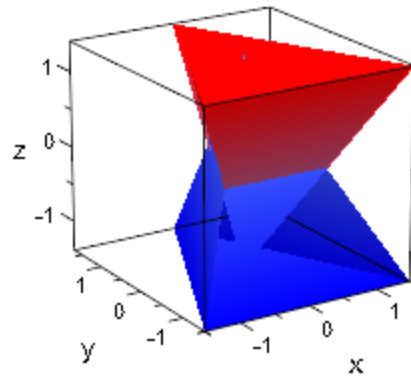
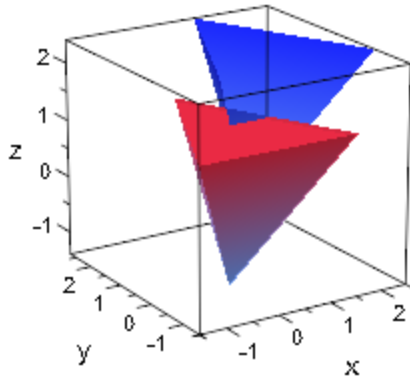
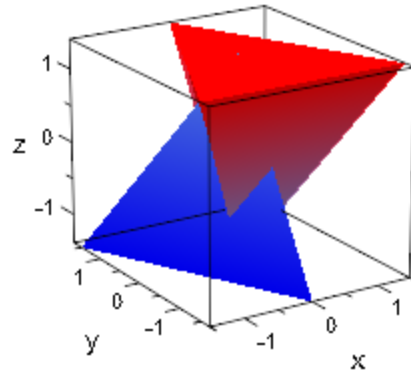
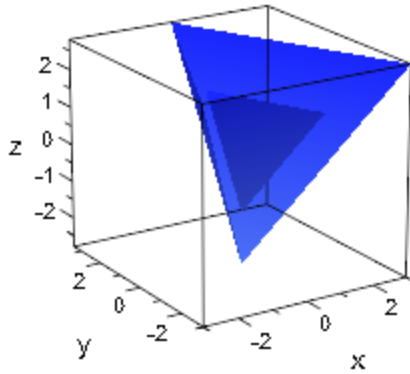

## Example 8

STL objects can be animated. The tetrahedron defined in “Example 4” on page 24-862 (Symbolic Math Toolbox) moves around a box:

```
S0 := plot::SurfaceSTL(stlFile):
B0 := plot::Box(op(S0::boundingBox(S0)), Color = RGB::Blue.[0.1]):
G0 := [6*sin(a), -6*cos(a), 4*cos(2*a)], a = 0..2*PI:
CU := plot::Curve3d(G0):
plot(B0, CU, plot::Translate3d(G0, S0),
     ViewingBox = [-8..8, -8..8, -6..6]):
```

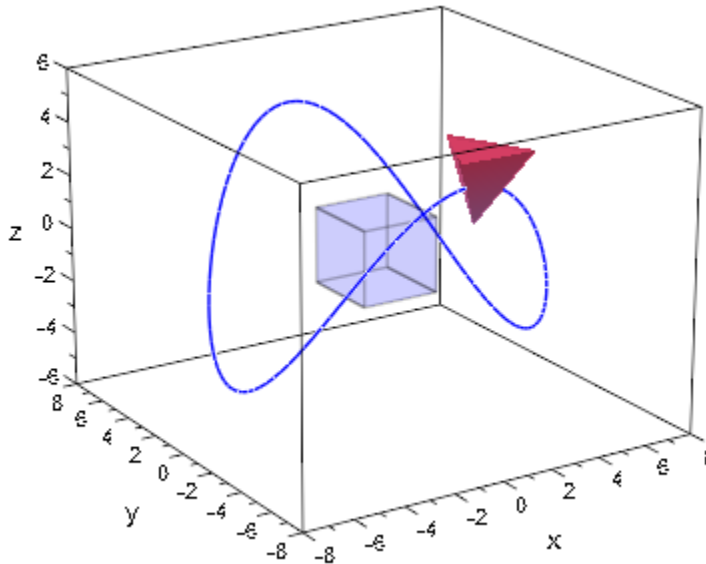

Below, the color function FillColorFunction of an STL object is animated:

```
plot(plot::SurfaceSTL(stlFile,
    MeshVisible = TRUE,
    LineColor = RGB::Black,
    FillColorFunction =
        proc(n, x, y, z) begin
            [sin(x + a)^2, sin(y + a)^2, sin(z + a)^2]
        end_proc,
```

```
a = 0..2*PI, TimeRange = 1..4),  
Axes = None, Layout = Horizontal)
```

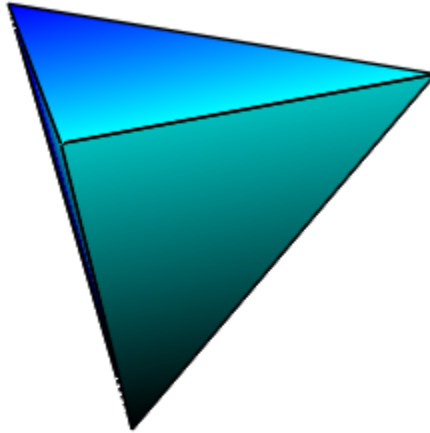

```
delete S0, B0, G0, CU, stlFile:
```

## Parameters

### filename

The file name: a character string of type DOM\_STRING.

filename is equivalent to the attribute InputFile.

### a

Animation parameter, specified as  $a = a_{\min}..a_{\max}$ , where  $a_{\min}$  is the initial parameter value, and  $a_{\max}$  is the final parameter value.

## Options

### UseNormals

Option, specified as `UseNormals = b`

`b` may be `TRUE` or `FALSE`. This attribute specifies whether the normals defined in the STL file are used for the MuPAD plot.

## Algorithms

The STL sample files presented on this help page were taken from the ftp site of the Clemson University, South Carolina, USA:

`ftp.vr.clemson.edu/pub/rp/STL_objects`.

There are two storage formats available for STL files, which are ASCII and BINARY. ASCII files are human-readable while BINARY files are smaller and faster to process. Both formats can be read by `plot::SurfaceSTL`. A typical ASCII STL file looks like this:

```
solid sample
facet normal -4.470293E-02 7.003503E-01 -7.123981E-01
  outer loop
    vertex -2.812284E+00 2.298693E+01 0.000000E+00
    vertex -2.812284E+00 2.296699E+01 -1.960784E-02
    vertex -3.124760E+00 2.296699E+01 0.000000E+00
  endloop
endfacet
...
endsolid sample
```

STL BINARY files have the following format:

Bytes	Type	Description
80	ASCII	header, no data significance
4	uint	number of facets in file
4	float	normal x - start of facet
4	float	normal y
4	float	normal z



```
4      float  vertex1 x
4      float  vertex1 y
4      float  vertex1 z
4      float  vertex2 x
4      float  vertex2 y
4      float  vertex2 z
4      float  vertex3 x
4      float  vertex3 y
4      float  vertex3 z
2      byte   not used - end of facet
...

```

Facet orientation: The facets define the surface of a 3D object. As such, each facet is part of the boundary between the interior and the exterior of the object. The orientation of the facets (which way is "out" and which way is "in") is specified redundantly in two ways which should be consistent. First, the direction of the normal is outward. Second, which is most commonly used nowadays, the facet vertices are listed in counterclockwise order when looking at the object from the outside (right-hand rule).

Vertex-to-vertex rule: Each triangle must share two vertices with each of its adjacent triangles. In other words, a vertex of one triangle cannot lie on the side of another.

Axes: The format specifies that all vertex coordinates must be strictly positive numbers. However, it seems that — with a few exceptions — most software used today (MuPAD included) allow negative coordinates as well.

Units: The STL file does not contain any scale information; the coordinates may be interpreted in arbitrary units.

Further details about the STL file format are available in the web, e.g., at:

- [www.ennex.com/fabbers/StL.asp](http://www.ennex.com/fabbers/StL.asp),
- [www.math.iastate.edu/burkardt/data/stl/stl.html](http://www.math.iastate.edu/burkardt/data/stl/stl.html) and
- [rpdrc.ic.polyu.edu.hk/content/stl/stl\\_introduction.htm](http://rpdrc.ic.polyu.edu.hk/content/stl/stl_introduction.htm).

Collections of STL sample files can be found in the web, e.g., at:

- [www.wohlersassociates.com/Software-for-Rapid-Prototyping.html](http://www.wohlersassociates.com/Software-for-Rapid-Prototyping.html) and
- [www.cs.duke.edu/~edels/Tubes](http://www.cs.duke.edu/~edels/Tubes).

Information about rapid prototyping technologies is available in the web, e.g., at:

[www.cs.hut.fi/~ado/rp/rp.html](http://www.cs.hut.fi/~ado/rp/rp.html).

Note that MuPAD only accepts the following notations for the keywords “facet” and “vertex” in STL ASCII files: facet, FACET, Facet and vertex, VERTEX, Vertex, respectively.

The normal of a facet defined in an STL file is used for all its vertices when plotting this object. Due to the fact that some facets (triangles) share points with other ones, these points are plotted with different normals.

## See Also

### **MuPAD Functions**

`export::stl` | `import::readbitmap` | `plot`

### **MuPAD Graphical Primitives**

`plot::Rotate3d` | `plot::Scale3d` | `plot::Surface` | `plot::SurfaceSet` |  
`plot::Transform3d` | `plot::Translate3d`

## plot::Sweep

Sweep surface from the deformation of a 3D curve

### Syntax

```
plot::Sweep([x1, y1, z1], <Ground = g>, u = umin .. umax, <a = amin .. amax>, options)
```

```
plot::Sweep(A1, <Ground = g>, u = umin .. umax, <a = amin .. amax>, options)
```

```
plot::Sweep(C1, <Ground = g>, options)
```

```
plot::Sweep([x1, y1, z1], [x2, y2, z2], u = umin .. umax, <a = amin .. amax>, options)
```

```
plot::Sweep(A1, A2, u = umin .. umax, <a = amin .. amax>, options)
```

```
plot::Sweep(C1, C2, options)
```

### Description

`plot::Sweep([x1(u), y1(u), z1(u)], u = `umin` .. `umax`)` creates the surface swept out by the (linear) deformation of the parameterized curve  $(x_1(u), y_1(u), z_1(u))$  to its projection  $(x_1(u), y_1(u), 0)$  to the  $x$ - $y$ -plane.

`plot::Sweep([x1(u), y1(u), z1(u)], [x2(u), y2(u), z2(u)], u = `umin` .. `umax`)` creates the surface swept out by the (linear) deformation of the parameterized curve  $(x_1(u), y_1(u), z_1(u))$  to the parameterized curve  $(x_2(u), y_2(u), z_2(u))$ .

`plot::Sweep` creates the parametrized surface

$$x(u, v) = x_1(u) + v(x_2(u) - x_1(u))$$

$$y(u, v) = y_1(u) + v(y_2(u) - y_1(u))$$

$$z(u, v) = z_1(u) + v(z_2(u) - z_1(u))$$

with the two surface parameters  $u$  (ranging from  $u_{\min}$  to  $u_{\max}$ ) and  $v$  (ranging from 0 to 1). This is the linear deformation of the curve  $(x_1(u), y_1(u), z_1(u))$  defining one border of the surface to the curve  $(x_2(u), y_2(u), z_2(u))$  defining the other border of the surface.

If no "target curve"  $(x_2(u), y_2(u), z_2(u))$  is specified, the projection  $x_2(u) = x_1(u)$ ,  $y_2(u) = y_1(u)$ ,  $z_2(u) = g$  of the "source curve"  $(x_1(u), y_1(u), z_1(u))$  to the  $x$ - $y$ -plane with constant value  $z = g$  is used. The value  $g$  is set by the attribute `Ground = g`. The default value is `g = 0`.

When a target curve  $[x_2(u), y_2(u), z_2(u)]$  is specified, the `Ground` attribute does not have any effect.

If the curves are specified by objects  $C_1$ ,  $C_2$  of type `plot::Curve3d`, the graphical attributes of the object created by `plot::Sweep` are copied from  $C_1$ . The parametrization of  $C_2$  is automatically rewritten in terms of the curve parameter used in the definition of  $C_1$ . This, however, will only work if the parametrization of  $C_2$  is defined by symbolic expressions.

---

**Note** If the parametrization of  $C_2$  is defined by procedures, make sure that the parameter ranges of  $C_1$  and  $C_2$  coincide!

---

## Attributes

Attribute	Purpose	Default Value
<code>AdaptiveMesh</code>	adaptive sampling	0
<code>AffectViewingBox</code>	influence of objects on the <code>ViewingBox</code> of a scene	TRUE
<code>Color</code>	the main color	<code>RGB::Black.[0.25]</code>
<code>DiscontinuitySearch</code>	semi-symbolic search for discontinuities	TRUE
<code>Filled</code>	filled or transparent areas and surfaces	TRUE
<code>FillColor</code>	color of areas and surfaces	<code>RGB::Red</code>
<code>FillColor2</code>	second color of areas and surfaces for color blends	<code>RGB::CornflowerBlue</code>

Attribute	Purpose	Default Value
FillColorType	surface filling types	Dichromatic
FillColorFunction	functional area/surface coloring	
FillColorDirection	the direction of color transitions on surfaces	[0, 0, 1]
FillColorDirectionX	x-component of the direction of color transitions on surfaces	0
FillColorDirectionY	y-component of the direction of color transitions on surfaces	0
FillColorDirectionZ	z-component of the direction of color transitions on surfaces	1
Frames	the number of frames in an animation	50
Ground	base value	0
Legend	makes a legend entry	
LegendText	short explanatory text for legend	
LegendEntry	add this object to the legend?	TRUE
LineColor	color of lines	RGB::Black.[0.25]
LineWidth	width of lines	0.35
LineColor2	color of lines	RGB::DeepPink
LineStyle	solid, dashed or dotted lines?	Solid
LineColorType	line coloring types	Flat
LineColorFunction	functional line coloring	
LineColorDirection	the direction of color transitions on lines	[0, 0, 1]

<b>Attribute</b>	<b>Purpose</b>	<b>Default Value</b>
LineColorDirectionX	x-component of the direction of color transitions on lines	0
LineColorDirectionY	y-component of the direction of color transitions on lines	0
LineColorDirectionZ	z-component of the direction of color transitions on lines	1
Mesh	number of sample points	25
Name	the name of a plot object (for browser and legend)	
ParameterEnd	end value of the animation parameter	
ParameterName	name of the animation parameter	
ParameterBegin	initial value of the animation parameter	
ParameterRange	range of the animation parameter	
PointSize	the size of points	1.5
PointStyle	the presentation style of points	FilledCircles
PointsVisible	visibility of mesh points	FALSE
Submesh	density of submesh (additional sample points)	4
TimeEnd	end time of the animation	10.0
TimeBegin	start time of the animation	0.0
TimeRange	the real time span of an animation	0.0 .. 10.0
Title	object title	
TitleFont	font of object titles	[" sans-serif ", 11]
TitlePosition	position of object titles	

<b>Attribute</b>	<b>Purpose</b>	<b>Default Value</b>
TitleAlignment	horizontal alignment of titles w.r.t. their coordinates	Center
TitlePositionX	position of object titles, x component	
TitlePositionY	position of object titles, y component	
TitlePositionZ	position of object titles, z component	
ULinesVisible	visibility of parameter lines (u lines)	TRUE
UMax	final value of parameter "u"	
UMesh	number of sample points for parameter "u"	25
UMin	initial value of parameter "u"	
UName	name of parameter "u"	
URange	range of parameter "u"	
USubmesh	density of additional sample points for parameter "u"	4
VLinesVisible	visibility of parameter lines (v lines)	TRUE
Visible	visibility	TRUE
VisibleAfter	object visible after this time value	
VisibleBefore	object visible until this time value	
VisibleFromTo	object visible during this time range	
VisibleAfterEnd	object visible after its animation time ended?	TRUE
VisibleBeforeBegin	object visible before its animation time starts?	TRUE

Attribute	Purpose	Default Value
XFunction1	parametrization of the curves in sweep surfaces	
XFunction2	parametrization of the curves in sweep surfaces	
YFunction1	parametrization of the curves in sweep surfaces	
YFunction2	parametrization of the curves in sweep surfaces	
ZFunction1	parametrization of the curves in sweep surfaces	
ZFunction2	parametrization of the curves in sweep surfaces	

## Examples

### Example 1

We deform a 3D spiral to its projection to the x-y-plane:

```
plot(plot::Sweep([u*cos(u), u*sin(u), u], u = 0..4*PI),  
      CameraDirection = [90, 50, 120])
```



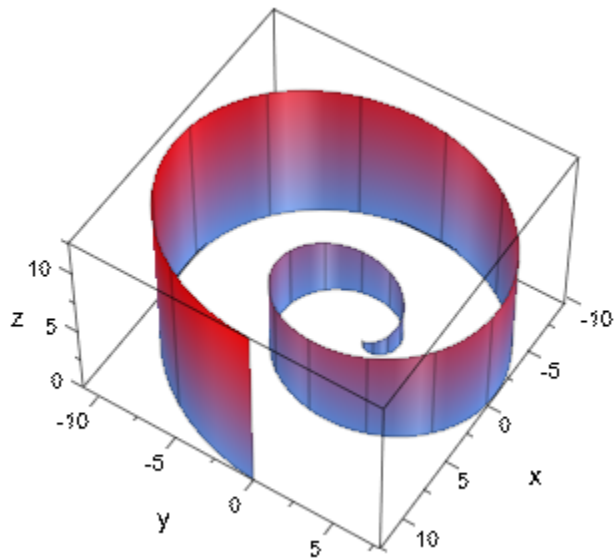

We use the Ground attribute to project the spiral to the x-y-plane with  $z = 9$ :

```
plot(plot::Sweep([u*cos(u), u*sin(u), u], u = 0..4*PI, Ground = 9),  
      CameraDirection = [130, 60, 45])
```

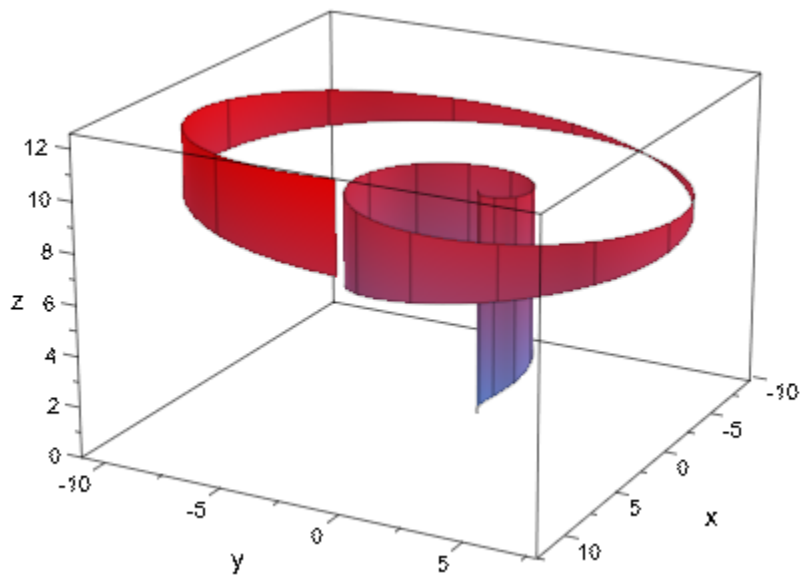

## Example 2

We deform a circle in the x-y-plane to a planar spiral:

```
plot(plot::Sweep([cos(u), sin(u), 0], [u*cos(u), u*sin(u), 0],  
                u = PI/3..7/3*PI), Scaling = Constrained)
```

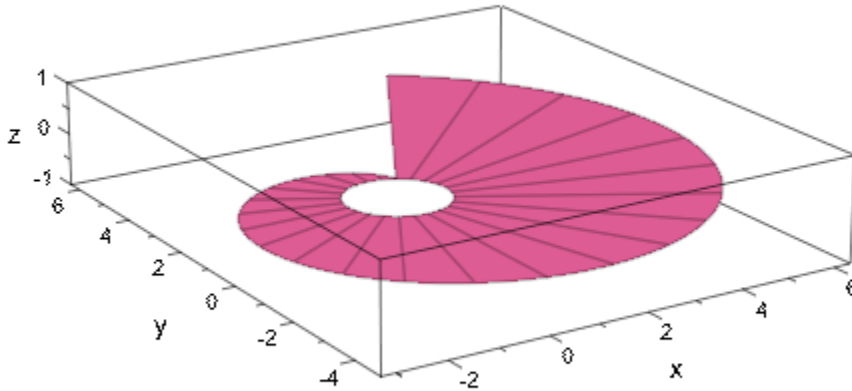

With `Filled = FALSE`, only the lines are visible along which the mesh points of the curves are moved:

```
plot(plot::Sweep([cos(u), sin(u), 0], [u*cos(u), u*sin(u), 0],  
                u = PI/3..7/3*PI), Scaling = Constrained,  
      Filled = FALSE)
```

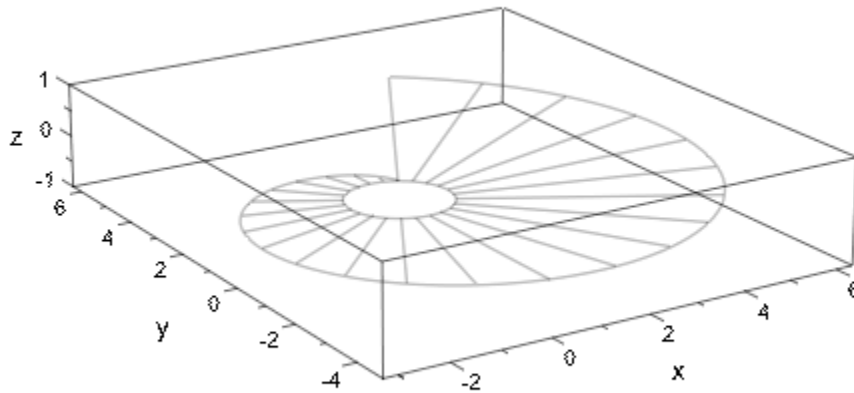

We increase the number of mesh points:

```
plot(plot::Sweep([cos(u), sin(u), 0], [u*cos(u), u*sin(u), 0],  
u = PI/3..7/3*PI, Mesh = 50),  
Scaling = Constrained, Filled = FALSE)
```

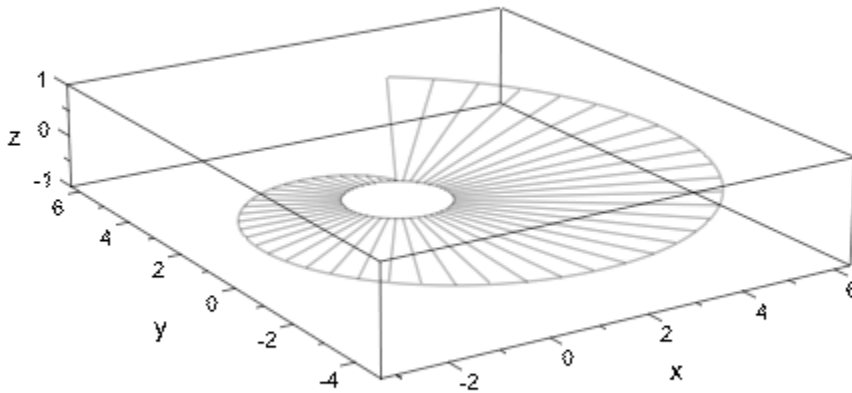

### Example 3

We deform a circle to an animated point. The resulting sweep surface is an animated cone:

```
plot(plot::Sweep([cos(u), sin(u), 0], [a, 0, a],  
                u = 0..2*PI, a = 0..2))
```

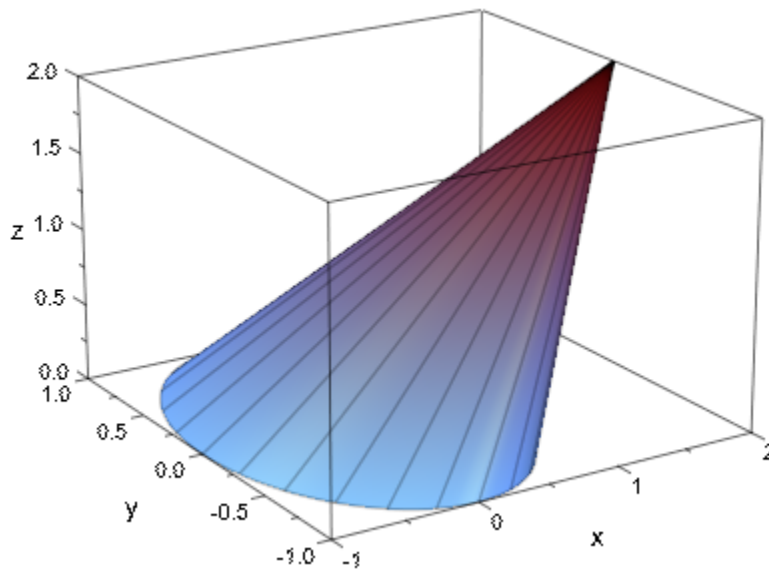

## Parameters

### $x_1, y_1, z_1$

The parametrization of the initial 3D curve: real-valued expressions in  $u$  (and possibly the animation parameter).

$x_1, y_1, z_1$  are equivalent to the attributes XFunction1, YFunction1, ZFunction1.

### $x_2, y_2, z_2$

The parametrization of the “target curve”: real-valued expressions in  $u$  (and possibly the animation parameter).

$x_2, y_2, z_2$  are equivalent to the attributes XFunction2, YFunction2, ZFunction2.

### $u$

The curve parameter: an identifier on page 7-29 or an indexed identifier on page 1-1017.

$u$  is equivalent to the attribute `UName`.

**$u_{\min}, u_{\max}$**

Real-valued expressions (possibly in the animation parameter).

$u_{\min}, u_{\max}$  are equivalent to the attributes `UMin, UMax`.

**$g$**

Real-valued expression (possibly in the animation parameter).

$g$  is equivalent to the attribute `Ground`.

**$A_1, A_2$**

matrices on page 1-1340 of category `Cat::Matrix` with three entries that provide the parametrizations  $x_1, y_1, z_1$  and  $x_2, y_2, z_2$ , respectively.

**$C_1, C_2$**

Curves of type `plot::Curve3d`.  $C_1$  provides the “initial curve”  $[x_1, y_1, z_1]$ ,  $C_2$  provides the “target curve”  $[x_2, y_2, z_2]$ .

**$a$**

Animation parameter, specified as  $a = a_{\min} \dots a_{\max}$ , where  $a_{\min}$  is the initial parameter value, and  $a_{\max}$  is the final parameter value.

## See Also

### MuPAD Functions

`plot` | `plot::copy`

### MuPAD Graphical Primitives

`plot::Curve3d` | `plot::Hatch` | `plot::Polygon3d` | `plot::Surface`

## plot::Tetrahedron

Regular Tetrahedra

### Syntax

```
plot::Tetrahedron(<a = amin .. amax>, options)
```

### Description

`plot::Tetrahedron()` creates regular polyhedra.

Per default, all polyhedra are centered at the origin. The attribute `Center` allows to choose a different center. This is helpful to align the polyhedra relative to other objects in the graphical scene. Cf. “Example 1” on page 24-892 (Symbolic Math Toolbox).

All polyhedra fit into a box extending from -1 to 1 in all coordinate directions. Their size can be changed by the attribute `Radius`. In case of a hexahedron (a box), this attribute represents the radius of the inscribed sphere. For the other polyhedra, it is the radius of the circumscribed sphere.

The default value of `Radius` is 1 for all polyhedra.

Further to the attributes `Center` and `Radius`, you can modify the polyhedra by applying transformation objects of type `plot::Rotate3d`, `plot::Scale3d`, `plot::Translate3d`, and `plot::Transform3d`. Cf. “Example 3” on page 24-895 (Symbolic Math Toolbox).

User-defined color functions (`LineColorFunction`, `FillColorFunction`) are called with the index of the current facet as its first parameter, followed by the  $x$ ,  $y$ , and  $z$  coordinate of the current point, followed by the current value of the animation parameter (if animated). Cf. “Example 4” on page 24-896 (Symbolic Math Toolbox).



## Attributes

Attribute	Purpose	Default Value
AffectViewingBox	influence of objects on the ViewingBox of a scene	TRUE
Center	center of objects, rotation center	[0, 0, 0]
CenterX	center of objects, rotation center, x-component	0
CenterY	center of objects, rotation center, y-component	0
CenterZ	center of objects, rotation center, z-component	0
Color	the main color	RGB::Red
Filled	filled or transparent areas and surfaces	TRUE
FillColor	color of areas and surfaces	RGB::Red
FillColor2	second color of areas and surfaces for color blends	RGB::CornflowerBlue
FillColorType	surface filling types	Dichromatic
FillColorFunction	functional area/surface coloring	
FillColorDirection	the direction of color transitions on surfaces	[0, 0, 1]
FillColorDirectionX	x-component of the direction of color transitions on surfaces	0
FillColorDirectionY	y-component of the direction of color transitions on surfaces	0
FillColorDirectionZ	z-component of the direction of color transitions on surfaces	1

Attribute	Purpose	Default Value
Frames	the number of frames in an animation	50
Legend	makes a legend entry	
LegendText	short explanatory text for legend	
LegendEntry	add this object to the legend?	FALSE
LineColor	color of lines	RGB::Black.[0.25]
LineWidth	width of lines	0.35
LineColor2	color of lines	RGB::DeepPink
LineStyle	solid, dashed or dotted lines?	Solid
LinesVisible	visibility of lines	TRUE
LineColorType	line coloring types	Flat
LineColorFunction	functional line coloring	
LineColorDirection	the direction of color transitions on lines	[0, 0, 1]
LineColorDirectionX	x-component of the direction of color transitions on lines	0
LineColorDirectionY	y-component of the direction of color transitions on lines	0
LineColorDirectionZ	z-component of the direction of color transitions on lines	1
Name	the name of a plot object (for browser and legend)	
ParameterEnd	end value of the animation parameter	
ParameterName	name of the animation parameter	
ParameterBegin	initial value of the animation parameter	

<b>Attribute</b>	<b>Purpose</b>	<b>Default Value</b>
ParameterRange	range of the animation parameter	
PointSize	the size of points	1.5
PointStyle	the presentation style of points	FilledCircles
PointsVisible	visibility of mesh points	FALSE
Radius	radius of circles, spheres etc.	1
Shading	smooth color blend of surfaces	Smooth
TimeEnd	end time of the animation	10.0
TimeBegin	start time of the animation	0.0
TimeRange	the real time span of an animation	0.0 .. 10.0
Title	object title	
TitleFont	font of object titles	[" sans-serif ", 11]
TitlePosition	position of object titles	
TitleAlignment	horizontal alignment of titles w.r.t. their coordinates	Center
TitlePositionX	position of object titles, x component	
TitlePositionY	position of object titles, y component	
TitlePositionZ	position of object titles, z component	
Visible	visibility	TRUE
VisibleAfter	object visible after this time value	
VisibleBefore	object visible until this time value	

Attribute	Purpose	Default Value
VisibleFromTo	object visible during this time range	
VisibleAfterEnd	object visible after its animation time ended?	TRUE
VisibleBeforeBegin	object visible before its animation time starts?	TRUE

## Examples

### Example 1

Using different Centers, the five regular polyhedra are placed side by side:

```
plot(plot::Hexahedron (Center = [0, 0, 0]),  
      plot::Tetrahedron (Center = [3, 0, 0]),  
      plot::Octahedron (Center = [6, 0, 0]),  
      plot::Icosahedron (Center = [9, 0, 0]),  
      plot::Dodecahedron(Center = [12, 0, 0]),  
      Axes = Frame);
```

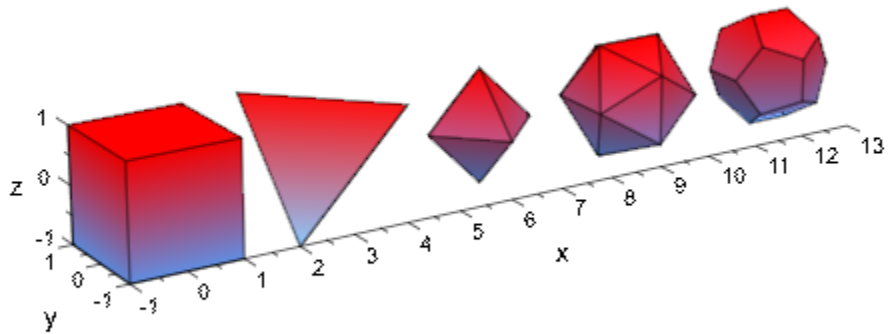

With the attribut Radius, the size of the polyhydra can be changed:

```
plot(plot::Hexahedron (Radius = 1.0, Center = [0, 0, 0]),  
      plot::Tetrahedron (Radius = 1.5, Center = [4, 0, 0]),  
      plot::Octahedron (Radius = 2.0, Center = [8, 0, 0]),  
      plot::Icosahedron (Radius = 2.5, Center = [13, 0, 0]),  
      plot::Dodecahedron(Radius = 3.0, Center = [19, 0, 0]),  
      Axes = Frame);
```

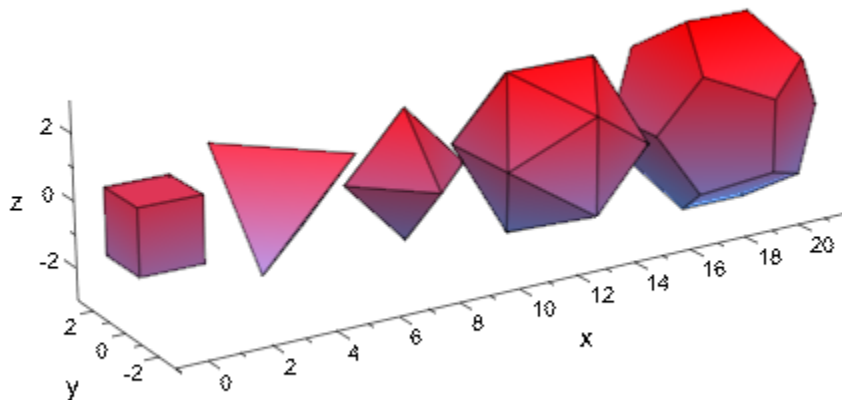

## Example 2

A tetrahedron and an octahedron are embedded in a hexahedron:

```
plot(plot::Hexahedron (FillColorFunction = RGB::Red.[0.2],  
                      VisibleFromTo = 0..8),  
      plot::Tetrahedron(FillColorFunction = RGB::Green.[0.2],  
                       VisibleFromTo = 1..5),  
      plot::Octahedron (FillColorFunction = RGB::Blue.[0.2],  
                      VisibleFromTo = 3..7),  
      Axes = None)
```

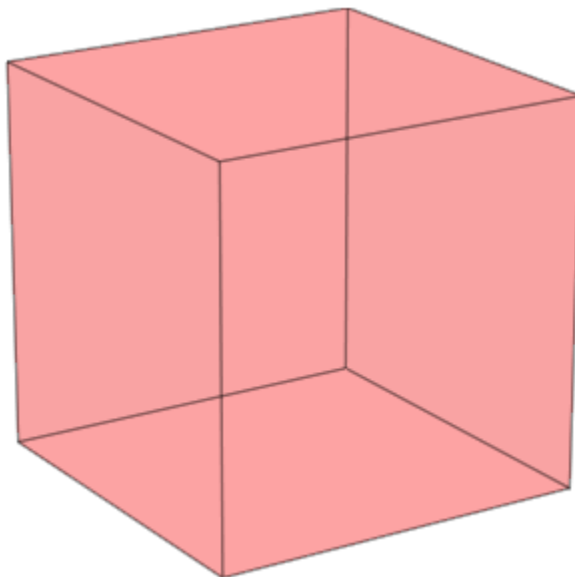

### Example 3

Transformation objects can be applied to polyhedra as demonstrated below:

```
H := plot::Hexahedron(Color = RGB::Blue.[0.2],
                      FillColorType = Flat):
T := plot::Tetrahedron(Color = RGB::Red):
plot(plot::Rotate3d(a, [0, 0, 0], [0, 0, 1], a = 0..2*PI,
                  H,
                  plot::Translate3d([0, 0, a], T, a = 0..2)
                ), Axes = None)
```

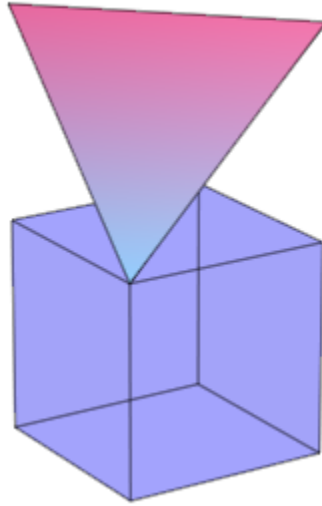

```
delete T, H:
```

#### Example 4

A `FillColorFunction` can be specified. This will be called with the index of the current facet as its first parameter, followed by the  $x$ -,  $y$ - and  $z$ -coordinate of the current point:

```
mycolorlist := [RGB::Red, RGB::Blue, RGB::Green, RGB::Yellow]:  
plot(plot::Dodecahedron(Center = [0, 0, 0],  
    FillColorFunction =  
        proc(n, x, y, z) begin  
            [(1 + x)/2, (1 + y)/2, (1 + z)/2]  
        end_proc),  
    plot::Dodecahedron(Center = [3, 0, 0],  
        FillColorFunction =  
            proc(n, x, y, z) begin  
                mycolorlist[(n mod 4)+1]  
            end_proc),  
    Axes = None):
```



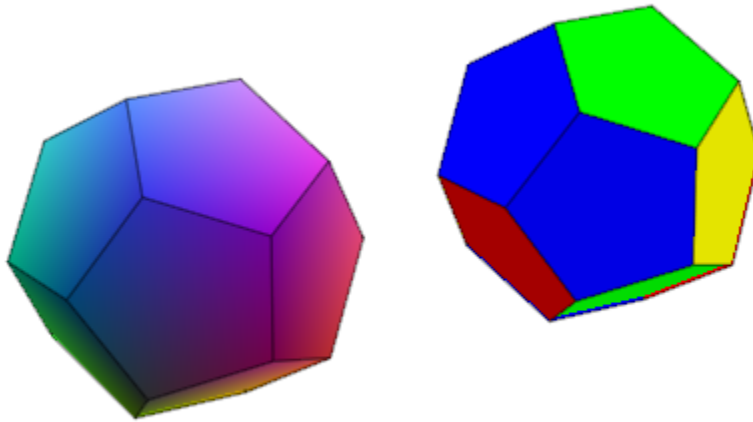

The same holds true for a LineColorFunction:

```
plot(plot::Icosahedron(Center = [0, 0, 0],
  LineColorFunction =
    proc(n, x, y, z) begin
      [(1 + x)/2, (1 + y)/2, (1 + z)/2]
    end_proc),
  plot::Icosahedron(Center = [3, 0, 0],
  LineColorFunction =
    proc(n, x, y, z) begin
      mycolorlist[(n mod 4)+1]
    end_proc),
  Axes = None, LineWidth = 1.0*unit::mm,
  FillColor = RGB::Grey80, FillColorType = Flat):
```

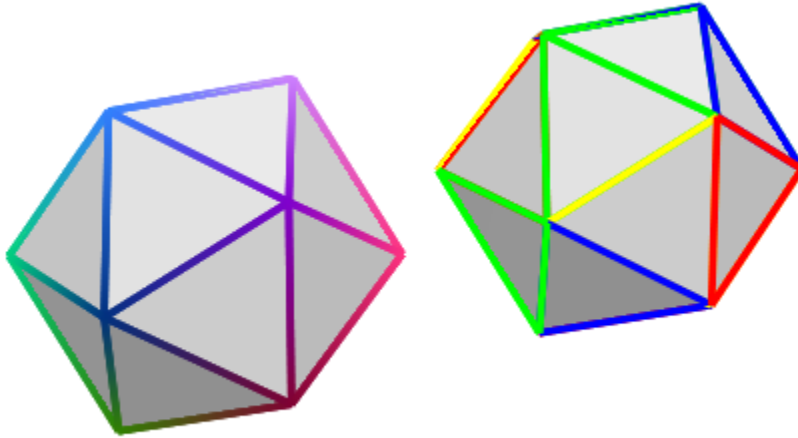

If the polyhedron is animated, the color functions are called with an additional argument: the current value of the animation parameter:

```
plot(plot::Octahedron(FillColorFunction =  
    proc(n, x, y, z, a)  
    begin  
        [sin(n*a)^2, cos(n*a)^2, 1]:  
    end_proc,  
    a = 0..2*PI))
```

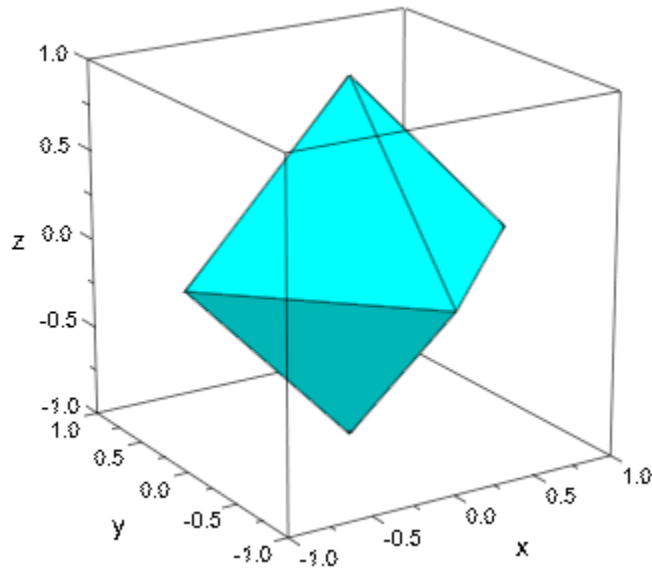

`delete mycolorlist:`

## Algorithms

A polyhedron is called regular if all its facets consist of the same regular polygon and each vertex has the same number of coincidence polygons.

Since Plato we know that only five regular polyhedrons exist:

- the tetrahedron with 4 (greek *tetra*) triangles,
- the hexahedron with 6 (greek *hexa*) squares,
- the octahedron with 8 (greek *okta*) triangles,
- the dodecahedron with 12 (greek *dodeka*) pentagons and
- the icosahedron with 20 (greek *eikosi*) triangles.

The following table lists some important geometrical data of the polyhedra with the edge length  $a$ . Where  $R$  is the radius of the outer spherem  $r$  the radius of the inner sphere,  $A$  the surface area and  $V$  the volume:

Ratio	Tetrahedron	Hexahedron	Octahedron	Dodecahedron	Icosahedron
$\frac{R}{a}$	$\frac{\sqrt{6}}{4}$	$\frac{\sqrt{3}}{2}$	$\frac{\sqrt{2}}{2}$	$\frac{\sqrt{3}(1+\sqrt{5})}{4}$	$\frac{\sqrt{10+2\sqrt{5}}}{4}$
$\frac{r}{a}$	$\frac{\sqrt{6}}{12}$	$\frac{1}{2}$	$\frac{\sqrt{6}}{6}$	$\frac{\sqrt{250+110\sqrt{5}}}{20}$	$\frac{\sqrt{3}(3+\sqrt{5})}{12}$
$\frac{A}{a^2}$	$\sqrt{3}$	6	$2\sqrt{3}$	$3\sqrt{25+10\sqrt{5}}$	$5\sqrt{3}$
$\frac{V}{a^3}$	$\frac{\sqrt{2}}{12}$	1	$\frac{\sqrt{2}}{3}$	$\frac{(15+7\sqrt{5})}{4}$	$\frac{5(3+\sqrt{5})}{12}$

## See Also

### MuPAD Functions

plot

### MuPAD Graphical Primitives

plot::Box | plot::Cone | plot::Cylinder | plot::Dodecahedron |

plot::Hexahedron | plot::Icosahedron | plot::Octahedron |

plot::Parallelogram3d | plot::Sphere | plot::Transform3d

# plot::Hexahedron

Regular Hexahedra

## Syntax

```
plot::Hexahedron(<a = amin .. amax>, options)
```

## Description

`plot::Hexahedron()` creates regular polyhedra.

Per default, all polyhedra are centered at the origin. The attribute `Center` allows to choose a different center. This is helpful to align the polyhedra relative to other objects in the graphical scene. Cf. “Example 1” on page 24-905 (Symbolic Math Toolbox).

All polyhedra fit into a box extending from -1 to 1 in all coordinate directions. Their size can be changed by the attribute `Radius`. In case of a hexahedron (a box), this attribute represents the radius of the inscribed sphere. For the other polyhedra, it is the radius of the circumscribed sphere.

The default value of `Radius` is 1 for all polyhedra.

Further to the attributes `Center` and `Radius`, you can modify the polyhedra by applying transformation objects of type `plot::Rotate3d`, `plot::Scale3d`, `plot::Translate3d`, and `plot::Transform3d`. Cf. “Example 3” on page 24-908 (Symbolic Math Toolbox).

User-defined color functions (`LineColorFunction`, `FillColorFunction`) are called with the index of the current facet as its first parameter, followed by the  $x$ ,  $y$ , and  $z$  coordinate of the current point, followed by the current value of the animation parameter (if animated). Cf. “Example 4” on page 24-909 (Symbolic Math Toolbox).

## Attributes

Attribute	Purpose	Default Value
AffectViewingBox	influence of objects on the ViewingBox of a scene	TRUE
Center	center of objects, rotation center	[0, 0, 0]
CenterX	center of objects, rotation center, x-component	0
CenterY	center of objects, rotation center, y-component	0
CenterZ	center of objects, rotation center, z-component	0
Color	the main color	RGB::Red
Filled	filled or transparent areas and surfaces	TRUE
FillColor	color of areas and surfaces	RGB::Red
FillColor2	second color of areas and surfaces for color blends	RGB::CornflowerBlue
FillColorType	surface filling types	Dichromatic
FillColorFunction	functional area/surface coloring	
FillColorDirection	the direction of color transitions on surfaces	[0, 0, 1]
FillColorDirectionX	x-component of the direction of color transitions on surfaces	0
FillColorDirectionY	y-component of the direction of color transitions on surfaces	0
FillColorDirectionZ	z-component of the direction of color transitions on surfaces	1

Attribute	Purpose	Default Value
Frames	the number of frames in an animation	50
Legend	makes a legend entry	
LegendText	short explanatory text for legend	
LegendEntry	add this object to the legend?	FALSE
LineColor	color of lines	RGB::Black.[0.25]
LineWidth	width of lines	0.35
LineColor2	color of lines	RGB::DeepPink
LineStyle	solid, dashed or dotted lines?	Solid
LinesVisible	visibility of lines	TRUE
LineColorType	line coloring types	Flat
LineColorFunction	functional line coloring	
LineColorDirection	the direction of color transitions on lines	[0, 0, 1]
LineColorDirectionX	x-component of the direction of color transitions on lines	0
LineColorDirectionY	y-component of the direction of color transitions on lines	0
LineColorDirectionZ	z-component of the direction of color transitions on lines	1
Name	the name of a plot object (for browser and legend)	
ParameterEnd	end value of the animation parameter	
ParameterName	name of the animation parameter	
ParameterBegin	initial value of the animation parameter	

<b>Attribute</b>	<b>Purpose</b>	<b>Default Value</b>
ParameterRange	range of the animation parameter	
PointSize	the size of points	1.5
PointStyle	the presentation style of points	FilledCircles
PointsVisible	visibility of mesh points	FALSE
Radius	radius of circles, spheres etc.	1
Shading	smooth color blend of surfaces	Smooth
TimeEnd	end time of the animation	10.0
TimeBegin	start time of the animation	0.0
TimeRange	the real time span of an animation	0.0 .. 10.0
Title	object title	
TitleFont	font of object titles	[" sans-serif ", 11]
TitlePosition	position of object titles	
TitleAlignment	horizontal alignment of titles w.r.t. their coordinates	Center
TitlePositionX	position of object titles, x component	
TitlePositionY	position of object titles, y component	
TitlePositionZ	position of object titles, z component	
Visible	visibility	TRUE
VisibleAfter	object visible after this time value	
VisibleBefore	object visible until this time value	



Attribute	Purpose	Default Value
VisibleFromTo	object visible during this time range	
VisibleAfterEnd	object visible after its animation time ended?	TRUE
VisibleBeforeBegin	object visible before its animation time starts?	TRUE

## Examples

### Example 1

Using different Centers, the five regular polyhedra are placed side by side:

```
plot(plot::Hexahedron (Center = [0, 0, 0]),  
      plot::Tetrahedron (Center = [3, 0, 0]),  
      plot::Octahedron (Center = [6, 0, 0]),  
      plot::Icosahedron (Center = [9, 0, 0]),  
      plot::Dodecahedron(Center = [12, 0, 0]),  
      Axes = Frame);
```

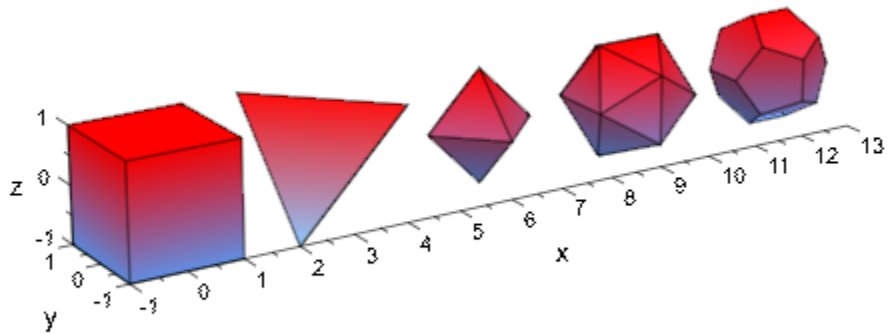

With the attribut Radius, the size of the polyhydra can be changed:

```
plot(plot::Hexahedron (Radius = 1.0, Center = [0, 0, 0]),  
      plot::Tetrahedron (Radius = 1.5, Center = [4, 0, 0]),  
      plot::Octahedron (Radius = 2.0, Center = [8, 0, 0]),  
      plot::Icosahedron (Radius = 2.5, Center = [13, 0, 0]),  
      plot::Dodecahedron(Radius = 3.0, Center = [19, 0, 0]),  
      Axes = Frame);
```

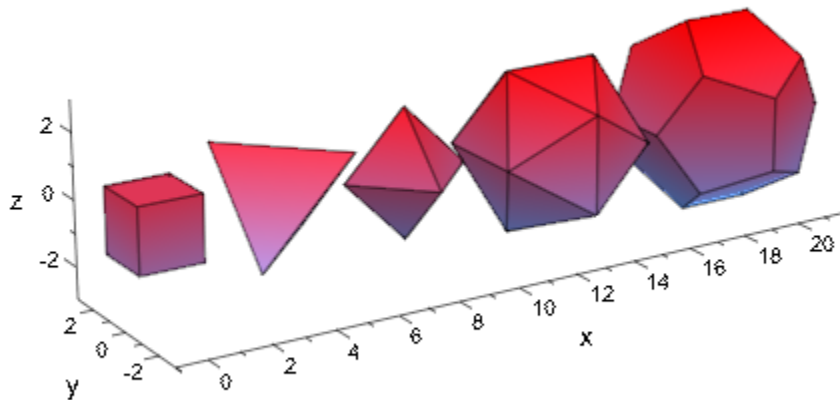

## Example 2

A tetrahedron and an octahedron are embedded in a hexahedron:

```
plot(plot::Hexahedron (FillColorFunction = RGB::Red.[0.2],
                      VisibleFromTo = 0..8),
      plot::Tetrahedron(FillColorFunction = RGB::Green.[0.2],
                       VisibleFromTo = 1..5),
      plot::Octahedron (FillColorFunction = RGB::Blue.[0.2],
                       VisibleFromTo = 3..7),
      Axes = None)
```

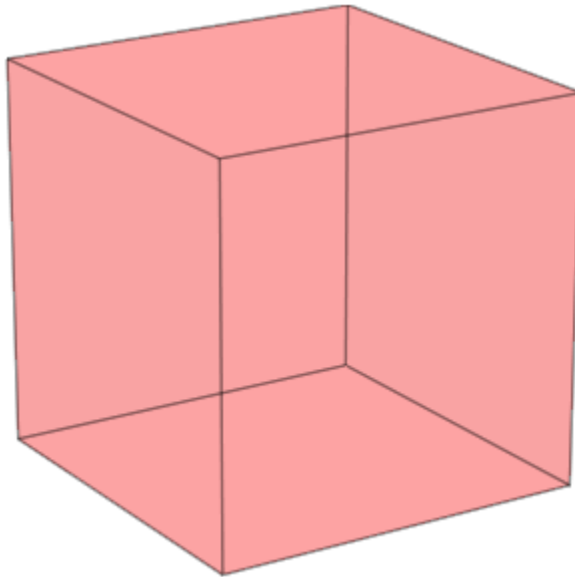

### Example 3

Transformation objects can be applied to polyhedra as demonstrated below:

```
H := plot::Hexahedron(Color = RGB::Blue.[0.2],  
                      FillColorType = Flat):  
T := plot::Tetrahedron(Color = RGB::Red):  
plot(plot::Rotate3d(a, [0, 0, 0], [0, 0, 1], a = 0..2*PI,  
                  H,  
                  plot::Translate3d([0, 0, a], T, a = 0..2)  
      ), Axes = None)
```

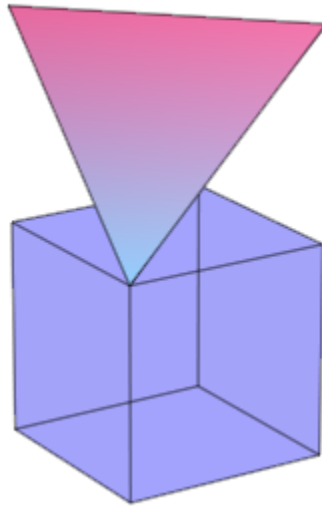

delete T, H:

#### Example 4

A `FillColorFunction` can be specified. This will be called with the index of the current facet as its first parameter, followed by the  $x$ -,  $y$ - and  $z$ -coordinate of the current point:

```
mycolorlist := [RGB::Red, RGB::Blue, RGB::Green, RGB::Yellow]:
plot(plot::Dodecahedron(Center = [0, 0, 0],
    FillColorFunction =
        proc(n, x, y, z) begin
            [(1 + x)/2, (1 + y)/2, (1 + z)/2]
        end_proc),
    plot::Dodecahedron(Center = [3, 0, 0],
        FillColorFunction =
            proc(n, x, y, z) begin
                mycolorlist[(n mod 4)+1]
            end_proc),
    Axes = None):
```

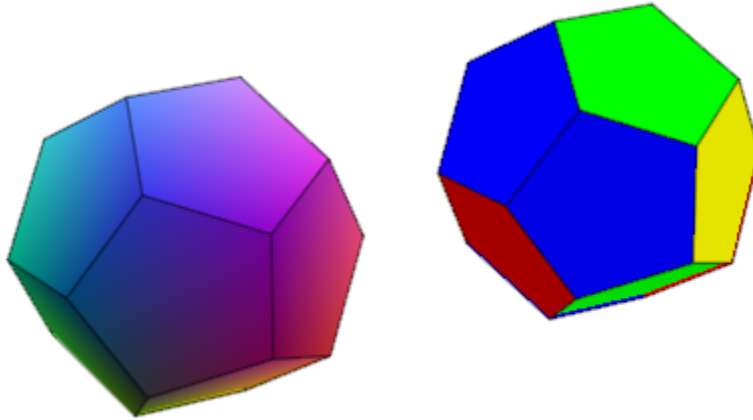

The same holds true for a `LineColorFunction`:

```
plot(plot::Icosahedron(Center = [0, 0, 0],
  LineColorFunction =
    proc(n, x, y, z) begin
      [(1 + x)/2, (1 + y)/2, (1 + z)/2]
    end_proc),
  plot::Icosahedron(Center = [3, 0, 0],
  LineColorFunction =
    proc(n, x, y, z) begin
      mycolorlist[(n mod 4)+1]
    end_proc),
  Axes = None, LineWidth = 1.0*unit::mm,
  FillColor = RGB::Grey80, FillColorType = Flat):
```

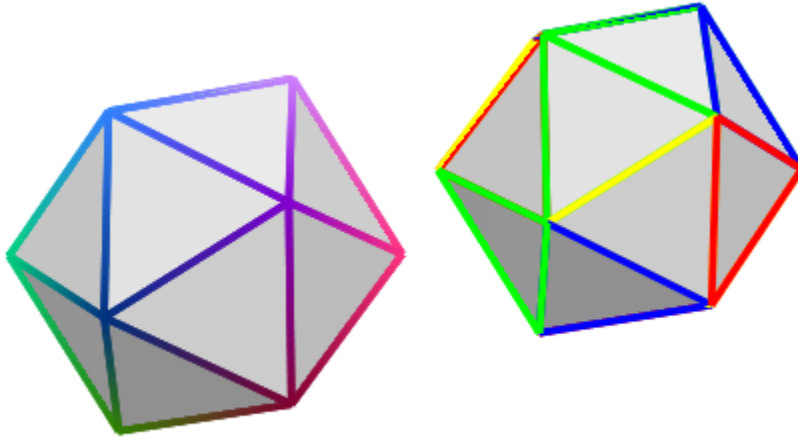

If the polyhedron is animated, the color functions are called with an additional argument: the current value of the animation parameter:

```
plot(plot::Octahedron(FillColorFunction =  
    proc(n, x, y, z, a)  
    begin  
        [sin(n*a)^2, cos(n*a)^2, 1]:  
    end_proc,  
    a = 0..2*PI))
```

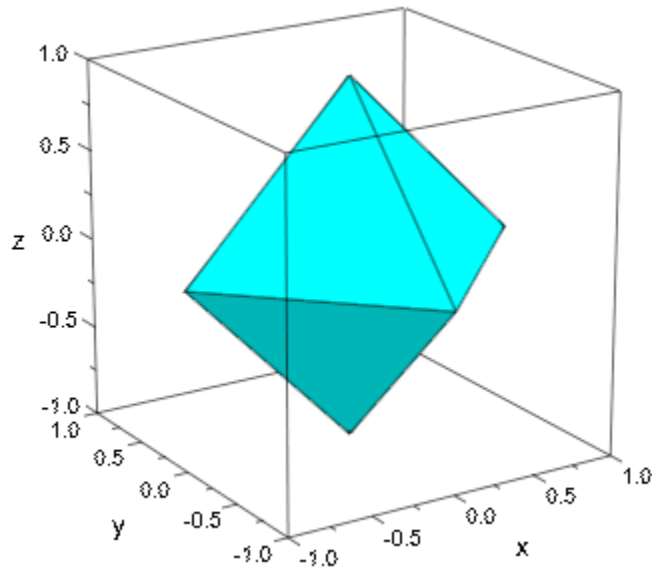

`delete mycolorlist:`

## Algorithms

A polyhedron is called regular if all its facets consist of the same regular polygon and each vertex has the same number of coincidence polygons.

Since Plato we know that only five regular polyhedrons exist:

- the tetrahedron with 4 (greek *tetra*) triangles,
- the hexahedron with 6 (greek *hexa*) squares,
- the octahedron with 8 (greek *okta*) triangles,
- the dodecahedron with 12 (greek *dodeka*) pentagons and
- the icosahedron with 20 (greek *eikosi*) triangles.

The following table lists some important geometrical data of the polyhedra with the edge length  $a$ . Where  $R$  is the radius of the outer spherem  $r$  the radius of the inner sphere,  $A$  the surface area and  $V$  the volume:



Ratio	Tetrahedron	Hexahedron	Octahedron	Dodecahedron	Icosahedron
$\frac{R}{a}$	$\frac{\sqrt{6}}{4}$	$\frac{\sqrt{3}}{2}$	$\frac{\sqrt{2}}{2}$	$\frac{\sqrt{3}(1+\sqrt{5})}{4}$	$\frac{\sqrt{10+2\sqrt{5}}}{4}$
$\frac{r}{a}$	$\frac{\sqrt{6}}{12}$	$\frac{1}{2}$	$\frac{\sqrt{6}}{6}$	$\frac{\sqrt{250+110\sqrt{5}}}{20}$	$\frac{\sqrt{3}(3+\sqrt{5})}{12}$
$\frac{A}{a^2}$	$\sqrt{3}$	6	$2\sqrt{3}$	$3\sqrt{25+10\sqrt{5}}$	$5\sqrt{3}$
$\frac{V}{a^3}$	$\frac{\sqrt{2}}{12}$	1	$\frac{\sqrt{2}}{3}$	$\frac{(15+7\sqrt{5})}{4}$	$\frac{5(3+\sqrt{5})}{12}$

## See Also

### MuPAD Functions

plot

### MuPAD Graphical Primitives

plot::Box | plot::Cone | plot::Cylinder | plot::Dodecahedron |  
 plot::Icosahedron | plot::Octahedron | plot::Parallelogram3d |  
 plot::Sphere | plot::Tetrahedron | plot::Transform3d

## plot::Octahedron

Regular Octahedra

### Syntax

```
plot::Octahedron(<a = amin .. amax>, options)
```

### Description

`plot::Octahedron()` creates regular polyhedra.

Per default, all polyhedra are centered at the origin. The attribute `Center` allows to choose a different center. This is helpful to align the polyhedra relative to other objects in the graphical scene. Cf. “Example 1” on page 24-918 (Symbolic Math Toolbox).

All polyhedra fit into a box extending from -1 to 1 in all coordinate directions. Their size can be changed by the attribute `Radius`. In case of a hexahedron (a box), this attribute represents the radius of the inscribed sphere. For the other polyhedra, it is the radius of the circumscribed sphere.

The default value of `Radius` is 1 for all polyhedra.

Further to the attributes `Center` and `Radius`, you can modify the polyhedra by applying transformation objects of type `plot::Rotate3d`, `plot::Scale3d`, `plot::Translate3d`, and `plot::Transform3d`. Cf. “Example 3” on page 24-921 (Symbolic Math Toolbox).

User-defined color functions (`LineColorFunction`, `FillColorFunction`) are called with the index of the current facet as its first parameter, followed by the  $x$ ,  $y$ , and  $z$  coordinate of the current point, followed by the current value of the animation parameter (if animated). Cf. “Example 4” on page 24-922 (Symbolic Math Toolbox).

## Attributes

Attribute	Purpose	Default Value
AffectViewingBox	influence of objects on the ViewingBox of a scene	TRUE
Center	center of objects, rotation center	[0, 0, 0]
CenterX	center of objects, rotation center, x-component	0
CenterY	center of objects, rotation center, y-component	0
CenterZ	center of objects, rotation center, z-component	0
Color	the main color	RGB::Red
Filled	filled or transparent areas and surfaces	TRUE
FillColor	color of areas and surfaces	RGB::Red
FillColor2	second color of areas and surfaces for color blends	RGB::CornflowerBlue
FillColorType	surface filling types	Dichromatic
FillColorFunction	functional area/surface coloring	
FillColorDirection	the direction of color transitions on surfaces	[0, 0, 1]
FillColorDirectionX	x-component of the direction of color transitions on surfaces	0
FillColorDirectionY	y-component of the direction of color transitions on surfaces	0
FillColorDirectionZ	z-component of the direction of color transitions on surfaces	1

<b>Attribute</b>	<b>Purpose</b>	<b>Default Value</b>
Frames	the number of frames in an animation	50
Legend	makes a legend entry	
LegendText	short explanatory text for legend	
LegendEntry	add this object to the legend?	FALSE
LineColor	color of lines	RGB::Black.[0.25]
LineWidth	width of lines	0.35
LineColor2	color of lines	RGB::DeepPink
LineStyle	solid, dashed or dotted lines?	Solid
LinesVisible	visibility of lines	TRUE
LineColorType	line coloring types	Flat
LineColorFunction	functional line coloring	
LineColorDirection	the direction of color transitions on lines	[0, 0, 1]
LineColorDirectionX	x-component of the direction of color transitions on lines	0
LineColorDirectionY	y-component of the direction of color transitions on lines	0
LineColorDirectionZ	z-component of the direction of color transitions on lines	1
Name	the name of a plot object (for browser and legend)	
ParameterEnd	end value of the animation parameter	
ParameterName	name of the animation parameter	
ParameterBegin	initial value of the animation parameter	

<b>Attribute</b>	<b>Purpose</b>	<b>Default Value</b>
ParameterRange	range of the animation parameter	
PointSize	the size of points	1.5
PointStyle	the presentation style of points	FilledCircles
PointsVisible	visibility of mesh points	FALSE
Radius	radius of circles, spheres etc.	1
Shading	smooth color blend of surfaces	Smooth
TimeEnd	end time of the animation	10.0
TimeBegin	start time of the animation	0.0
TimeRange	the real time span of an animation	0.0 .. 10.0
Title	object title	
TitleFont	font of object titles	[" sans-serif ", 11]
TitlePosition	position of object titles	
TitleAlignment	horizontal alignment of titles w.r.t. their coordinates	Center
TitlePositionX	position of object titles, x component	
TitlePositionY	position of object titles, y component	
TitlePositionZ	position of object titles, z component	
Visible	visibility	TRUE
VisibleAfter	object visible after this time value	
VisibleBefore	object visible until this time value	

Attribute	Purpose	Default Value
VisibleFromTo	object visible during this time range	
VisibleAfterEnd	object visible after its animation time ended?	TRUE
VisibleBeforeBegin	object visible before its animation time starts?	TRUE

## Examples

### Example 1

Using different Centers, the five regular polyhedra are placed side by side:

```
plot(plot::Hexahedron (Center = [0, 0, 0]),  
      plot::Tetrahedron (Center = [3, 0, 0]),  
      plot::Octahedron (Center = [6, 0, 0]),  
      plot::Icosahedron (Center = [9, 0, 0]),  
      plot::Dodecahedron(Center = [12, 0, 0]),  
      Axes = Frame);
```

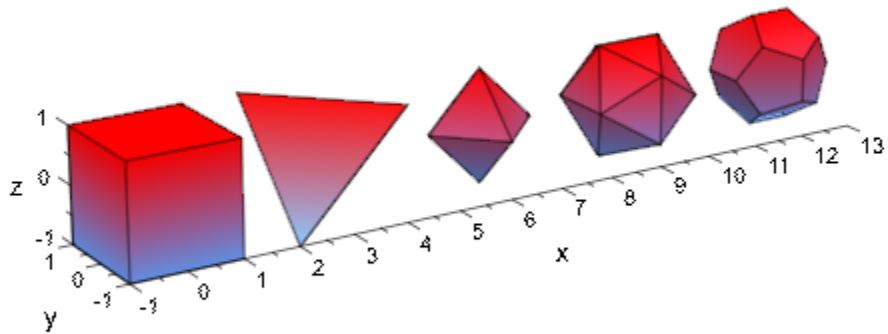

With the attribut Radius, the size of the polyhydra can be changed:

```
plot(plot::Hexahedron (Radius = 1.0, Center = [0, 0, 0]),  
      plot::Tetrahedron (Radius = 1.5, Center = [4, 0, 0]),  
      plot::Octahedron (Radius = 2.0, Center = [8, 0, 0]),  
      plot::Icosahedron (Radius = 2.5, Center = [13, 0, 0]),  
      plot::Dodecahedron(Radius = 3.0, Center = [19, 0, 0]),  
      Axes = Frame);
```

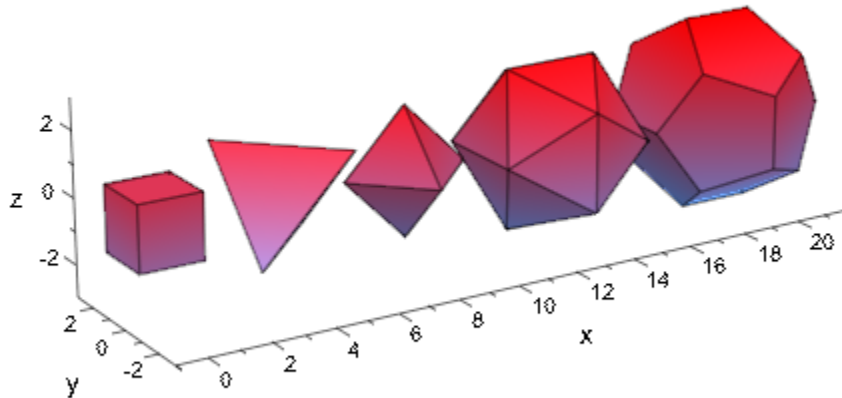

## Example 2

A tetrahedron and an octahedron are embedded in a hexahedron:

```
plot(plot::Hexahedron (FillColorFunction = RGB::Red.[0.2],
                      VisibleFromTo = 0..8),
      plot::Tetrahedron(FillColorFunction = RGB::Green.[0.2],
                       VisibleFromTo = 1..5),
      plot::Octahedron (FillColorFunction = RGB::Blue.[0.2],
                       VisibleFromTo = 3..7),
      Axes = None)
```



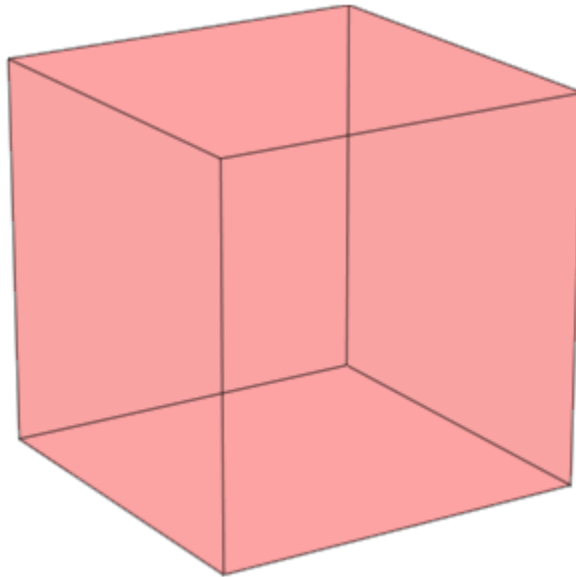

### Example 3

Transformation objects can be applied to polyhedra as demonstrated below:

```
H := plot::Hexahedron(Color = RGB::Blue.[0.2],
                      FillColorType = Flat):
T := plot::Tetrahedron(Color = RGB::Red):
plot(plot::Rotate3d(a, [0, 0, 0], [0, 0, 1], a = 0..2*PI,
                  H,
                  plot::Translate3d([0, 0, a], T, a = 0..2)
                ), Axes = None)
```

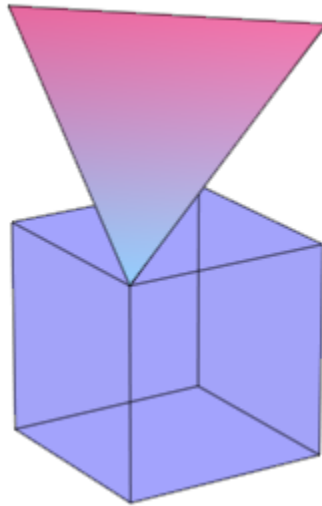

```
delete T, H:
```

#### Example 4

A `FillColorFunction` can be specified. This will be called with the index of the current facet as its first parameter, followed by the  $x$ -,  $y$ - and  $z$ -coordinate of the current point:

```
mycolorlist := [RGB::Red, RGB::Blue, RGB::Green, RGB::Yellow]:  
plot(plot::Dodecahedron(Center = [0, 0, 0],  
    FillColorFunction =  
        proc(n, x, y, z) begin  
            [(1 + x)/2, (1 + y)/2, (1 + z)/2]  
        end_proc),  
    plot::Dodecahedron(Center = [3, 0, 0],  
        FillColorFunction =  
            proc(n, x, y, z) begin  
                mycolorlist[(n mod 4)+1]  
            end_proc),  
    Axes = None):
```

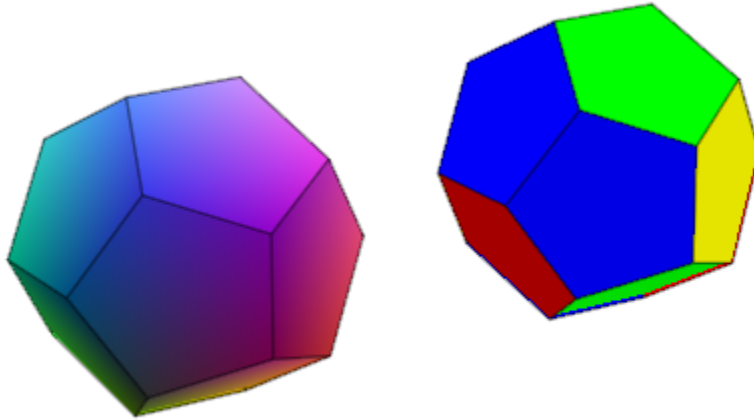

The same holds true for a LineColorFunction:

```
plot(plot::Icosahedron(Center = [0, 0, 0],
  LineColorFunction =
    proc(n, x, y, z) begin
      [(1 + x)/2, (1 + y)/2, (1 + z)/2]
    end_proc),
  plot::Icosahedron(Center = [3, 0, 0],
    LineColorFunction =
      proc(n, x, y, z) begin
        mycolorlist[(n mod 4)+1]
      end_proc),
  Axes = None, LineWidth = 1.0*unit::mm,
  FillColor = RGB::Grey80, FillColorType = Flat):
```

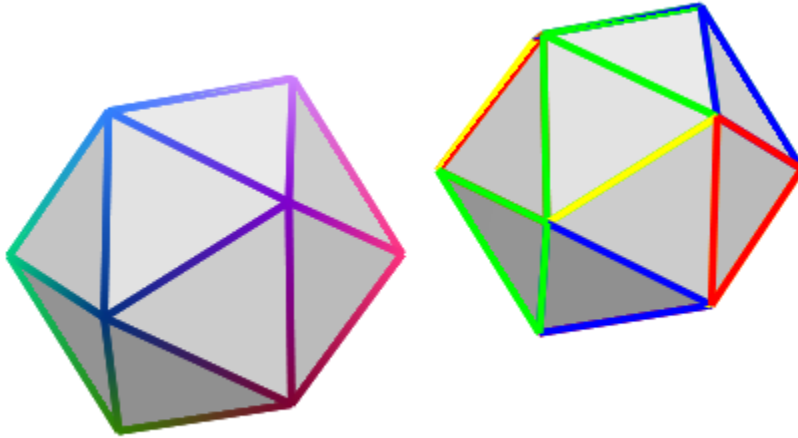

If the polyhedron is animated, the color functions are called with an additional argument: the current value of the animation parameter:

```
plot(plot::Octahedron(FillColorFunction =  
    proc(n, x, y, z, a)  
    begin  
        [sin(n*a)^2, cos(n*a)^2, 1]:  
    end_proc,  
    a = 0..2*PI))
```

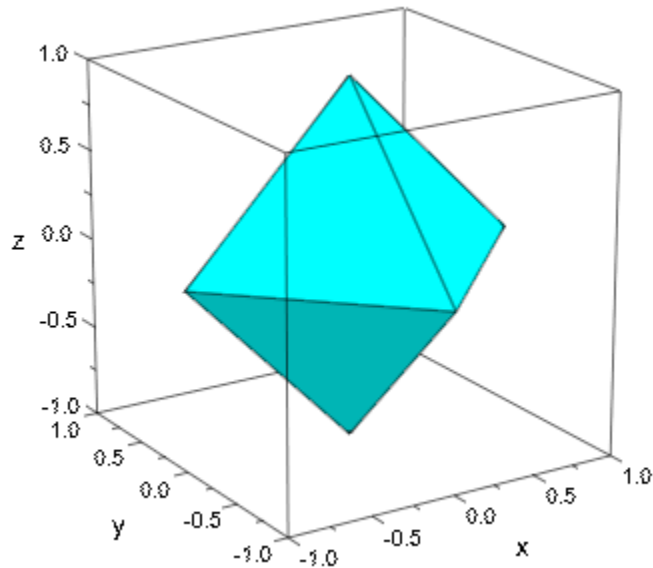

`delete mycolorlist:`

## Algorithms

A polyhedron is called regular if all its facets consist of the same regular polygon and each vertex has the same number of coincidence polygons.

Since Plato we know that only five regular polyhedrons exist:

- the tetrahedron with 4 (greek *tetra*) triangles,
- the hexahedron with 6 (greek *hexa*) squares,
- the octahedron with 8 (greek *okta*) triangles,
- the dodecahedron with 12 (greek *dodeka*) pentagons and
- the icosahedron with 20 (greek *eikosi*) triangles.

The following table lists some important geometrical data of the polyhedra with the edge length  $a$ . Where  $R$  is the radius of the outer spherem  $r$  the radius of the inner sphere,  $A$  the surface area and  $V$  the volume:

Ratio	Tetrahedron	Hexahedron	Octahedron	Dodecahedron	Icosahedron
$\frac{R}{a}$	$\frac{\sqrt{6}}{4}$	$\frac{\sqrt{3}}{2}$	$\frac{\sqrt{2}}{2}$	$\frac{\sqrt{3}(1+\sqrt{5})}{4}$	$\frac{\sqrt{10+2\sqrt{5}}}{4}$
$\frac{r}{a}$	$\frac{\sqrt{6}}{12}$	$\frac{1}{2}$	$\frac{\sqrt{6}}{6}$	$\frac{\sqrt{250+110\sqrt{5}}}{20}$	$\frac{\sqrt{3}(3+\sqrt{5})}{12}$
$\frac{A}{a^2}$	$\sqrt{3}$	6	$2\sqrt{3}$	$3\sqrt{25+10\sqrt{5}}$	$5\sqrt{3}$
$\frac{V}{a^3}$	$\frac{\sqrt{2}}{12}$	1	$\frac{\sqrt{2}}{3}$	$\frac{(15+7\sqrt{5})}{4}$	$\frac{5(3+\sqrt{5})}{12}$

## See Also

### MuPAD Functions

plot

### MuPAD Graphical Primitives

plot::Box | plot::Cone | plot::Cylinder | plot::Dodecahedron |  
 plot::Hexahedron | plot::Icosahedron | plot::Parallelogram3d |  
 plot::Sphere | plot::Tetrahedron | plot::Transform3d

# plot::Dodecahedron

Regular Dodecahedra

## Syntax

```
plot::Dodecahedron(<a = amin .. amax>, options)
```

## Description

`plot::Dodecahedron()` creates regular polyhedra.

Per default, all polyhedra are centered at the origin. The attribute `Center` allows to choose a different center. This is helpful to align the polyhedra relative to other objects in the graphical scene. Cf. “Example 1” on page 24-931 (Symbolic Math Toolbox).

All polyhedra fit into a box extending from -1 to 1 in all coordinate directions. Their size can be changed by the attribute `Radius`. In case of a hexahedron (a box), this attribute represents the radius of the inscribed sphere. For the other polyhedra, it is the radius of the circumscribed sphere.

The default value of `Radius` is 1 for all polyhedra.

Further to the attributes `Center` and `Radius`, you can modify the polyhedra by applying transformation objects of type `plot::Rotate3d`, `plot::Scale3d`, `plot::Translate3d`, and `plot::Transform3d`. Cf. “Example 3” on page 24-934 (Symbolic Math Toolbox).

User-defined color functions (`LineColorFunction`, `FillColorFunction`) are called with the index of the current facet as its first parameter, followed by the  $x$ ,  $y$ , and  $z$  coordinate of the current point, followed by the current value of the animation parameter (if animated). Cf. “Example 4” on page 24-935 (Symbolic Math Toolbox).

## Attributes

Attribute	Purpose	Default Value
AffectViewingBox	influence of objects on the ViewingBox of a scene	TRUE
Center	center of objects, rotation center	[0, 0, 0]
CenterX	center of objects, rotation center, x-component	0
CenterY	center of objects, rotation center, y-component	0
CenterZ	center of objects, rotation center, z-component	0
Color	the main color	RGB::Red
Filled	filled or transparent areas and surfaces	TRUE
FillColor	color of areas and surfaces	RGB::Red
FillColor2	second color of areas and surfaces for color blends	RGB::CornflowerBlue
FillColorType	surface filling types	Dichromatic
FillColorFunction	functional area/surface coloring	
FillColorDirection	the direction of color transitions on surfaces	[0, 0, 1]
FillColorDirectionX	x-component of the direction of color transitions on surfaces	0
FillColorDirectionY	y-component of the direction of color transitions on surfaces	0
FillColorDirectionZ	z-component of the direction of color transitions on surfaces	1



Attribute	Purpose	Default Value
Frames	the number of frames in an animation	50
Legend	makes a legend entry	
LegendText	short explanatory text for legend	
LegendEntry	add this object to the legend?	FALSE
LineColor	color of lines	RGB::Black.[0.25]
LineWidth	width of lines	0.35
LineColor2	color of lines	RGB::DeepPink
LineStyle	solid, dashed or dotted lines?	Solid
LinesVisible	visibility of lines	TRUE
LineColorType	line coloring types	Flat
LineColorFunction	functional line coloring	
LineColorDirection	the direction of color transitions on lines	[0, 0, 1]
LineColorDirectionX	x-component of the direction of color transitions on lines	0
LineColorDirectionY	y-component of the direction of color transitions on lines	0
LineColorDirectionZ	z-component of the direction of color transitions on lines	1
Name	the name of a plot object (for browser and legend)	
ParameterEnd	end value of the animation parameter	
ParameterName	name of the animation parameter	
ParameterBegin	initial value of the animation parameter	

<b>Attribute</b>	<b>Purpose</b>	<b>Default Value</b>
ParameterRange	range of the animation parameter	
PointSize	the size of points	1.5
PointStyle	the presentation style of points	FilledCircles
PointsVisible	visibility of mesh points	FALSE
Radius	radius of circles, spheres etc.	1
Shading	smooth color blend of surfaces	Smooth
TimeEnd	end time of the animation	10.0
TimeBegin	start time of the animation	0.0
TimeRange	the real time span of an animation	0.0 .. 10.0
Title	object title	
TitleFont	font of object titles	[" sans-serif ", 11]
TitlePosition	position of object titles	
TitleAlignment	horizontal alignment of titles w.r.t. their coordinates	Center
TitlePositionX	position of object titles, x component	
TitlePositionY	position of object titles, y component	
TitlePositionZ	position of object titles, z component	
Visible	visibility	TRUE
VisibleAfter	object visible after this time value	
VisibleBefore	object visible until this time value	

Attribute	Purpose	Default Value
VisibleFromTo	object visible during this time range	
VisibleAfterEnd	object visible after its animation time ended?	TRUE
VisibleBeforeBegin	object visible before its animation time starts?	TRUE

## Examples

### Example 1

Using different Centers, the five regular polyhedra are placed side by side:

```
plot(plot::Hexahedron (Center = [0, 0, 0]),  
      plot::Tetrahedron (Center = [3, 0, 0]),  
      plot::Octahedron (Center = [6, 0, 0]),  
      plot::Icosahedron (Center = [9, 0, 0]),  
      plot::Dodecahedron(Center = [12, 0, 0]),  
      Axes = Frame);
```

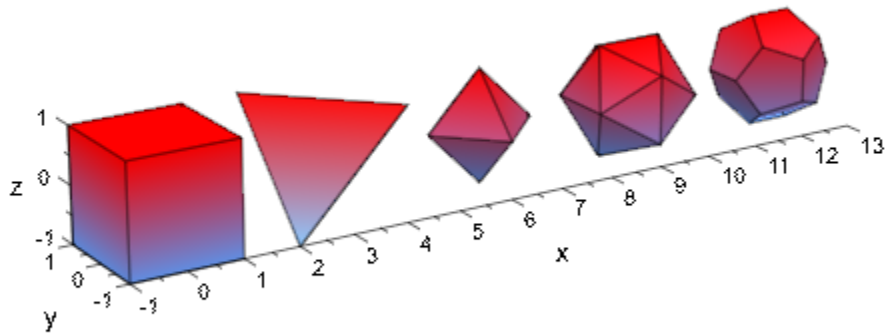

With the attribut Radius, the size of the polyhydra can be changed:

```
plot(plot::Hexahedron (Radius = 1.0, Center = [0, 0, 0]),  
      plot::Tetrahedron (Radius = 1.5, Center = [4, 0, 0]),  
      plot::Octahedron (Radius = 2.0, Center = [8, 0, 0]),  
      plot::Icosahedron (Radius = 2.5, Center = [13, 0, 0]),  
      plot::Dodecahedron(Radius = 3.0, Center = [19, 0, 0]),  
      Axes = Frame);
```

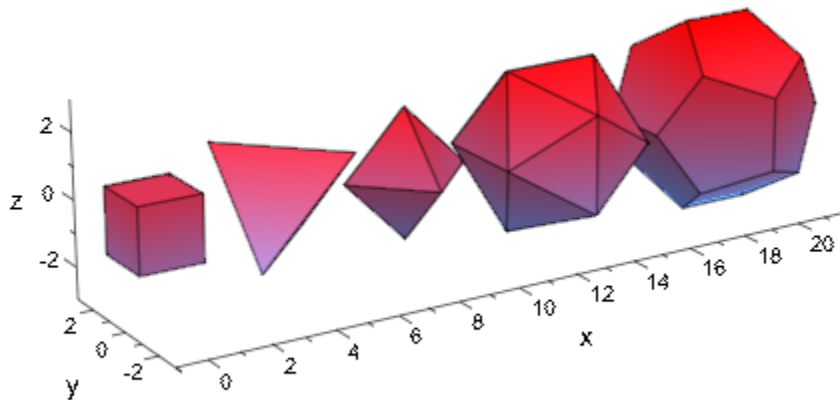

## Example 2

A tetrahedron and an octahedron are embedded in a hexahedron:

```
plot(plot::Hexahedron (FillColorFunction = RGB::Red.[0.2],
                      VisibleFromTo = 0..8),
      plot::Tetrahedron(FillColorFunction = RGB::Green.[0.2],
                       VisibleFromTo = 1..5),
      plot::Octahedron (FillColorFunction = RGB::Blue.[0.2],
                       VisibleFromTo = 3..7),
      Axes = None)
```

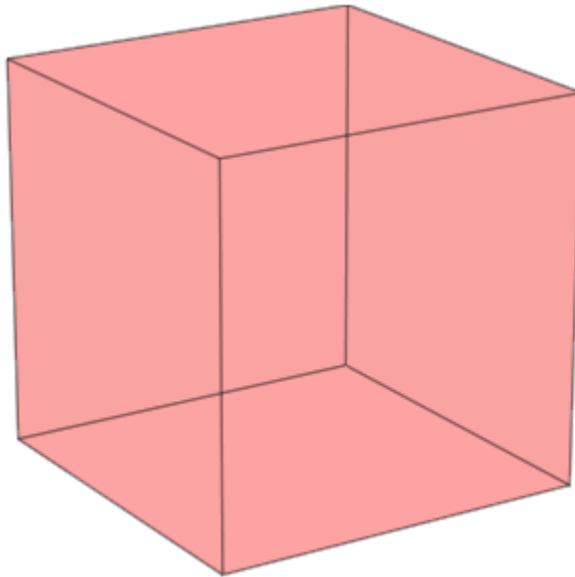

### Example 3

Transformation objects can be applied to polyhedra as demonstrated below:

```
H := plot::Hexahedron(Color = RGB::Blue.[0.2],
                      FillColorType = Flat):
T := plot::Tetrahedron(Color = RGB::Red):
plot(plot::Rotate3d(a, [0, 0, 0], [0, 0, 1], a = 0..2*PI,
                  H,
                  plot::Translate3d([0, 0, a], T, a = 0..2)
                ), Axes = None)
```

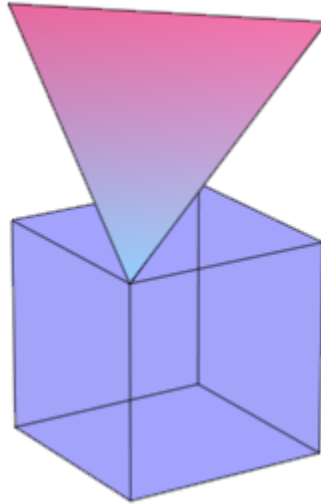

delete T, H:

#### Example 4

A `FillColorFunction` can be specified. This will be called with the index of the current facet as its first parameter, followed by the  $x$ -,  $y$ - and  $z$ -coordinate of the current point:

```
mycolorlist := [RGB::Red, RGB::Blue, RGB::Green, RGB::Yellow]:
plot(plot::Dodecahedron(Center = [0, 0, 0],
  FillColorFunction =
    proc(n, x, y, z) begin
      [(1 + x)/2, (1 + y)/2, (1 + z)/2]
    end_proc),
  plot::Dodecahedron(Center = [3, 0, 0],
    FillColorFunction =
      proc(n, x, y, z) begin
        mycolorlist[(n mod 4)+1]
      end_proc),
  Axes = None):
```

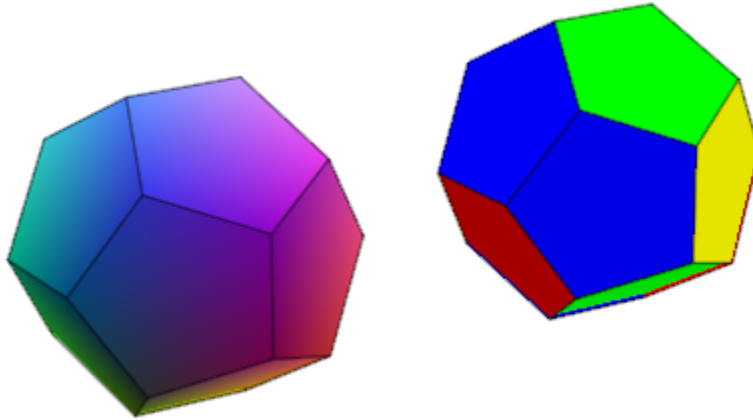

The same holds true for a `LineColorFunction`:

```
plot(plot::Icosahedron(Center = [0, 0, 0],
  LineColorFunction =
    proc(n, x, y, z) begin
      [(1 + x)/2, (1 + y)/2, (1 + z)/2]
    end_proc),
  plot::Icosahedron(Center = [3, 0, 0],
  LineColorFunction =
    proc(n, x, y, z) begin
      mycolorlist[(n mod 4)+1]
    end_proc),
  Axes = None, LineWidth = 1.0*unit::mm,
  FillColor = RGB::Grey80, FillColorType = Flat):
```



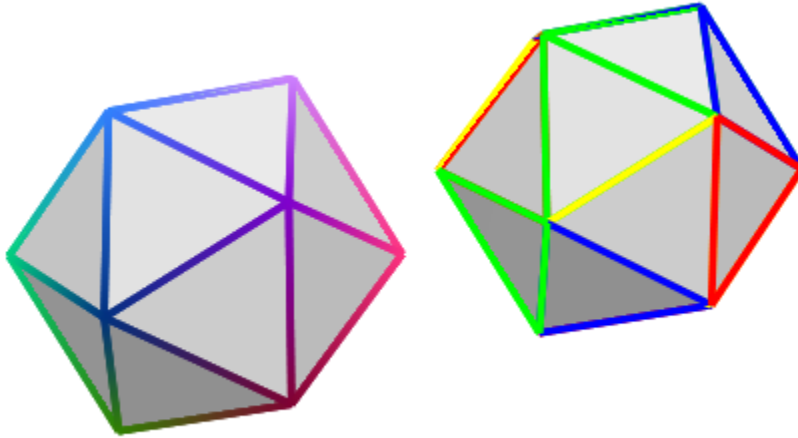

If the polyhedron is animated, the color functions are called with an additional argument: the current value of the animation parameter:

```
plot(plot::Octahedron(FillColorFunction =  
    proc(n, x, y, z, a)  
    begin  
        [sin(n*a)^2, cos(n*a)^2, 1]:  
    end_proc,  
    a = 0..2*PI))
```

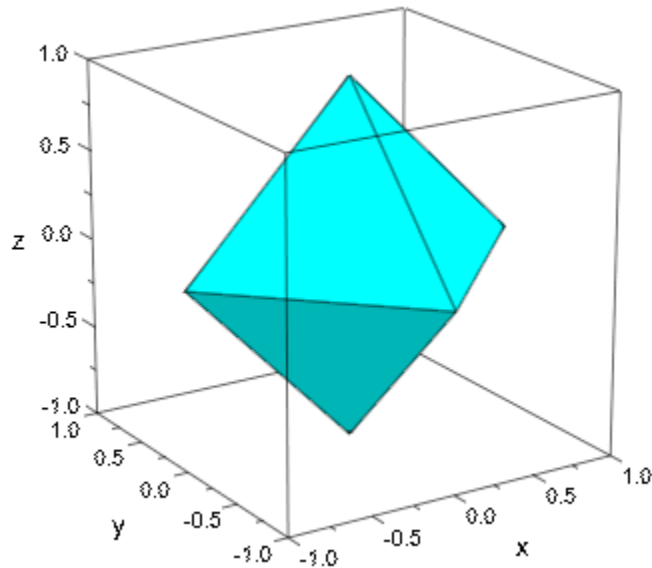

`delete mycolorlist:`

## Algorithms

A polyhedron is called regular if all its facets consist of the same regular polygon and each vertex has the same number of coincidence polygons.

Since Plato we know that only five regular polyhedrons exist:

- the tetrahedron with 4 (greek *tetra*) triangles,
- the hexahedron with 6 (greek *hexa*) squares,
- the octahedron with 8 (greek *okta*) triangles,
- the dodecahedron with 12 (greek *dodeka*) pentagons and
- the icosahedron with 20 (greek *eikosi*) triangles.

The following table lists some important geometrical data of the polyhedra with the edge length  $a$ . Where  $R$  is the radius of the outer sphere,  $r$  the radius of the inner sphere,  $A$  the surface area, and  $V$  the volume:

Ratio	Tetrahedron	Hexahedron	Octahedron	Dodecahedron	Icosahedron
$\frac{R}{a}$	$\frac{\sqrt{6}}{4}$	$\frac{\sqrt{3}}{2}$	$\frac{\sqrt{2}}{2}$	$\frac{\sqrt{3}(1+\sqrt{5})}{4}$	$\frac{\sqrt{10+2\sqrt{5}}}{4}$
$\frac{r}{a}$	$\frac{\sqrt{6}}{12}$	$\frac{1}{2}$	$\frac{\sqrt{6}}{6}$	$\frac{\sqrt{250+110\sqrt{5}}}{20}$	$\frac{\sqrt{3}(3+\sqrt{5})}{12}$
$\frac{A}{a^2}$	$\sqrt{3}$	6	$2\sqrt{3}$	$3\sqrt{25+10\sqrt{5}}$	$5\sqrt{3}$
$\frac{V}{a^3}$	$\frac{\sqrt{2}}{12}$	1	$\frac{\sqrt{2}}{3}$	$\frac{(15+7\sqrt{5})}{4}$	$\frac{5(3+\sqrt{5})}{12}$

## See Also

### MuPAD Functions

plot

### MuPAD Graphical Primitives

plot::Box | plot::Cone | plot::Cylinder | plot::Hexahedron |  
 plot::Icosahedron | plot::Octahedron | plot::Parallelogram3d |  
 plot::Sphere | plot::Tetrahedron | plot::Transform3d

## plot::Icosahedron

Regular Icosahedra

### Syntax

```
plot::Icosahedron(<a = amin .. amax>, options)
```

### Description

`plot::Icosahedron()` creates regular polyhedra.

Per default, all polyhedra are centered at the origin. The attribute `Center` allows to choose a different center. This is helpful to align the polyhedra relative to other objects in the graphical scene. Cf. “Example 1” on page 24-944 (Symbolic Math Toolbox).

All polyhedra fit into a box extending from -1 to 1 in all coordinate directions. Their size can be changed by the attribute `Radius`. In case of a hexahedron (a box), this attribute represents the radius of the inscribed sphere. For the other polyhedra, it is the radius of the circumscribed sphere.

The default value of `Radius` is 1 for all polyhedra.

Further to the attributes `Center` and `Radius`, you can modify the polyhedra by applying transformation objects of type `plot::Rotate3d`, `plot::Scale3d`, `plot::Translate3d`, and `plot::Transform3d`. Cf. “Example 3” on page 24-947 (Symbolic Math Toolbox).

User-defined color functions (`LineColorFunction`, `FillColorFunction`) are called with the index of the current facet as its first parameter, followed by the  $x$ ,  $y$ , and  $z$  coordinate of the current point, followed by the current value of the animation parameter (if animated). Cf. “Example 4” on page 24-948 (Symbolic Math Toolbox).

## Attributes

Attribute	Purpose	Default Value
AffectViewingBox	influence of objects on the ViewingBox of a scene	TRUE
Center	center of objects, rotation center	[0, 0, 0]
CenterX	center of objects, rotation center, x-component	0
CenterY	center of objects, rotation center, y-component	0
CenterZ	center of objects, rotation center, z-component	0
Color	the main color	RGB::Red
Filled	filled or transparent areas and surfaces	TRUE
FillColor	color of areas and surfaces	RGB::Red
FillColor2	second color of areas and surfaces for color blends	RGB::CornflowerBlue
FillColorType	surface filling types	Dichromatic
FillColorFunction	functional area/surface coloring	
FillColorDirection	the direction of color transitions on surfaces	[0, 0, 1]
FillColorDirectionX	x-component of the direction of color transitions on surfaces	0
FillColorDirectionY	y-component of the direction of color transitions on surfaces	0
FillColorDirectionZ	z-component of the direction of color transitions on surfaces	1

<b>Attribute</b>	<b>Purpose</b>	<b>Default Value</b>
Frames	the number of frames in an animation	50
Legend	makes a legend entry	
LegendText	short explanatory text for legend	
LegendEntry	add this object to the legend?	FALSE
LineColor	color of lines	RGB::Black.[0.25]
LineWidth	width of lines	0.35
LineColor2	color of lines	RGB::DeepPink
LineStyle	solid, dashed or dotted lines?	Solid
LinesVisible	visibility of lines	TRUE
LineColorType	line coloring types	Flat
LineColorFunction	functional line coloring	
LineColorDirection	the direction of color transitions on lines	[0, 0, 1]
LineColorDirectionX	x-component of the direction of color transitions on lines	0
LineColorDirectionY	y-component of the direction of color transitions on lines	0
LineColorDirectionZ	z-component of the direction of color transitions on lines	1
Name	the name of a plot object (for browser and legend)	
ParameterEnd	end value of the animation parameter	
ParameterName	name of the animation parameter	
ParameterBegin	initial value of the animation parameter	

<b>Attribute</b>	<b>Purpose</b>	<b>Default Value</b>
ParameterRange	range of the animation parameter	
PointSize	the size of points	1.5
PointStyle	the presentation style of points	FilledCircles
PointsVisible	visibility of mesh points	FALSE
Radius	radius of circles, spheres etc.	1
Shading	smooth color blend of surfaces	Smooth
TimeEnd	end time of the animation	10.0
TimeBegin	start time of the animation	0.0
TimeRange	the real time span of an animation	0.0 .. 10.0
Title	object title	
TitleFont	font of object titles	[" sans-serif ", 11]
TitlePosition	position of object titles	
TitleAlignment	horizontal alignment of titles w.r.t. their coordinates	Center
TitlePositionX	position of object titles, x component	
TitlePositionY	position of object titles, y component	
TitlePositionZ	position of object titles, z component	
Visible	visibility	TRUE
VisibleAfter	object visible after this time value	
VisibleBefore	object visible until this time value	

Attribute	Purpose	Default Value
VisibleFromTo	object visible during this time range	
VisibleAfterEnd	object visible after its animation time ended?	TRUE
VisibleBeforeBegin	object visible before its animation time starts?	TRUE

## Examples

### Example 1

Using different Centers, the five regular polyhedra are placed side by side:

```
plot(plot::Hexahedron (Center = [0, 0, 0]),  
      plot::Tetrahedron (Center = [3, 0, 0]),  
      plot::Octahedron (Center = [6, 0, 0]),  
      plot::Icosahedron (Center = [9, 0, 0]),  
      plot::Dodecahedron(Center = [12, 0, 0]),  
      Axes = Frame);
```



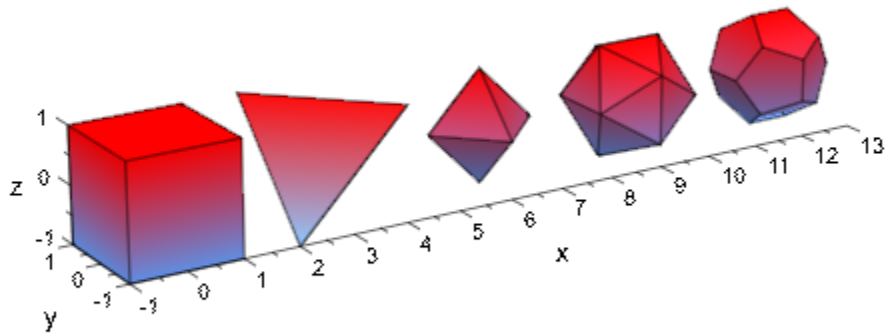

With the attribut Radius, the size of the polyhydra can be changed:

```
plot(plot::Hexahedron (Radius = 1.0, Center = [0, 0, 0]),  
      plot::Tetrahedron (Radius = 1.5, Center = [4, 0, 0]),  
      plot::Octahedron (Radius = 2.0, Center = [8, 0, 0]),  
      plot::Icosahedron (Radius = 2.5, Center = [13, 0, 0]),  
      plot::Dodecahedron(Radius = 3.0, Center = [19, 0, 0]),  
      Axes = Frame);
```

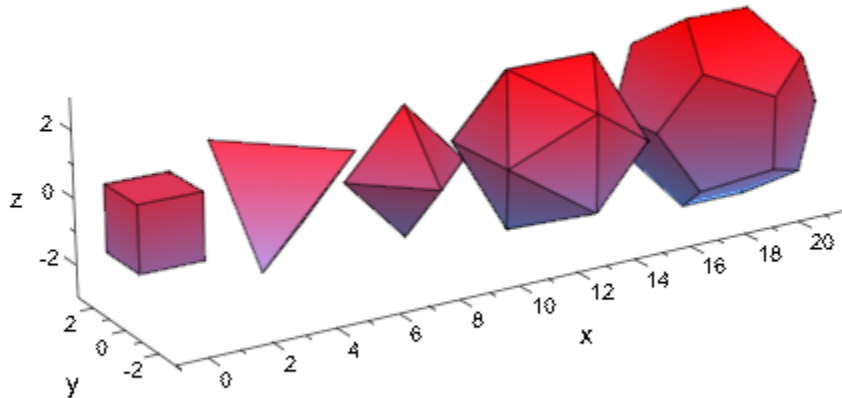

## Example 2

A tetrahedron and an octahedron are embedded in a hexahedron:

```
plot(plot::Hexahedron (FillColorFunction = RGB::Red.[0.2],
                      VisibleFromTo = 0..8),
      plot::Tetrahedron(FillColorFunction = RGB::Green.[0.2],
                       VisibleFromTo = 1..5),
      plot::Octahedron (FillColorFunction = RGB::Blue.[0.2],
                       VisibleFromTo = 3..7),
      Axes = None)
```

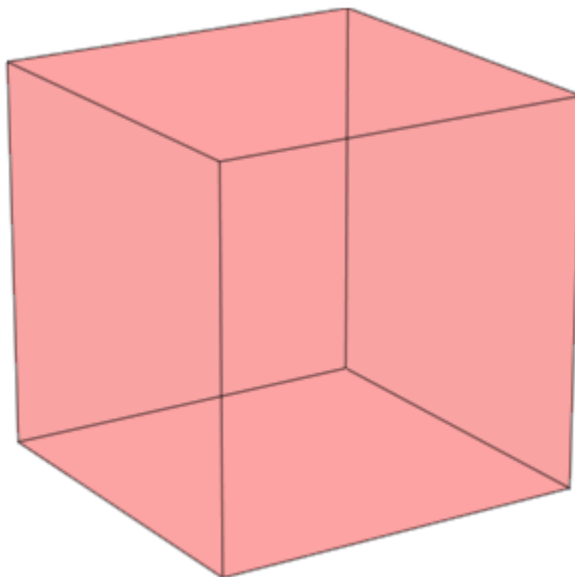

### Example 3

Transformation objects can be applied to polyhedra as demonstrated below:

```
H := plot::Hexahedron(Color = RGB::Blue.[0.2],
                      FillColorType = Flat):
T := plot::Tetrahedron(Color = RGB::Red):
plot(plot::Rotate3d(a, [0, 0, 0], [0, 0, 1], a = 0..2*PI,
                  H,
                  plot::Translate3d([0, 0, a], T, a = 0..2)
                ), Axes = None)
```

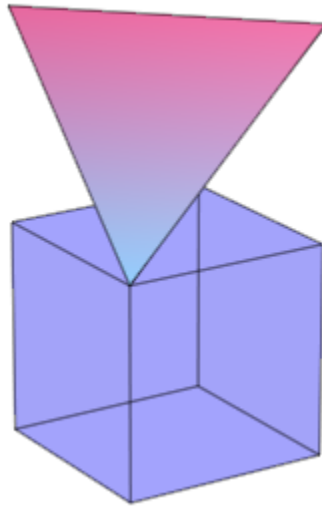

```
delete T, H:
```

#### Example 4

A `FillColorFunction` can be specified. This will be called with the index of the current facet as its first parameter, followed by the  $x$ -,  $y$ - and  $z$ -coordinate of the current point:

```
mycolorlist := [RGB::Red, RGB::Blue, RGB::Green, RGB::Yellow]:
plot(plot::Dodecahedron(Center = [0, 0, 0],
    FillColorFunction =
        proc(n, x, y, z) begin
            [(1 + x)/2, (1 + y)/2, (1 + z)/2]
        end_proc),
    plot::Dodecahedron(Center = [3, 0, 0],
        FillColorFunction =
            proc(n, x, y, z) begin
                mycolorlist[(n mod 4)+1]
            end_proc),
    Axes = None):
```

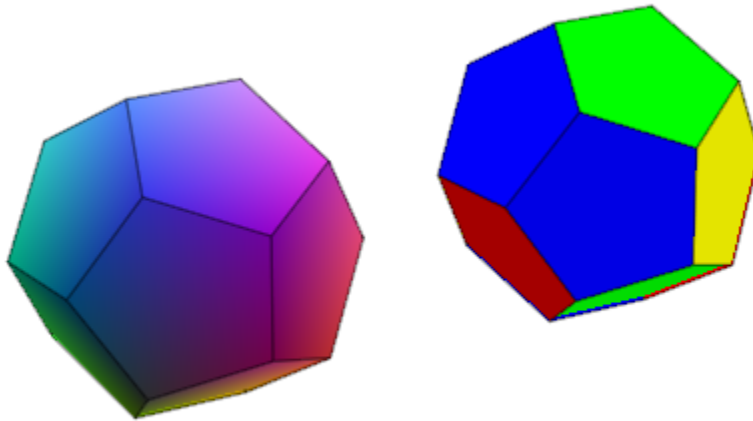

The same holds true for a LineColorFunction:

```
plot(plot::Icosahedron(Center = [0, 0, 0],
  LineColorFunction =
    proc(n, x, y, z) begin
      [(1 + x)/2, (1 + y)/2, (1 + z)/2]
    end_proc),
  plot::Icosahedron(Center = [3, 0, 0],
  LineColorFunction =
    proc(n, x, y, z) begin
      mycolorlist[(n mod 4)+1]
    end_proc),
  Axes = None, LineWidth = 1.0*unit::mm,
  FillColor = RGB::Grey80, FillColorType = Flat):
```

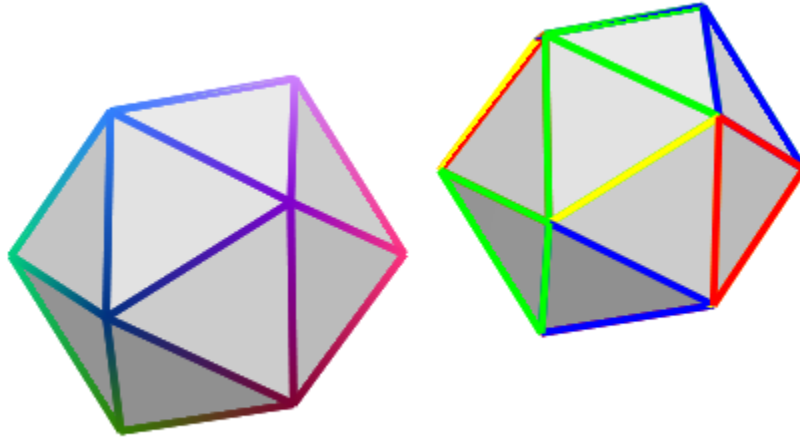

If the polyhedron is animated, the color functions are called with an additional argument: the current value of the animation parameter:

```
plot(plot::Octahedron(FillColorFunction =  
    proc(n, x, y, z, a)  
    begin  
        [sin(n*a)^2, cos(n*a)^2, 1]:  
    end_proc,  
    a = 0..2*PI))
```

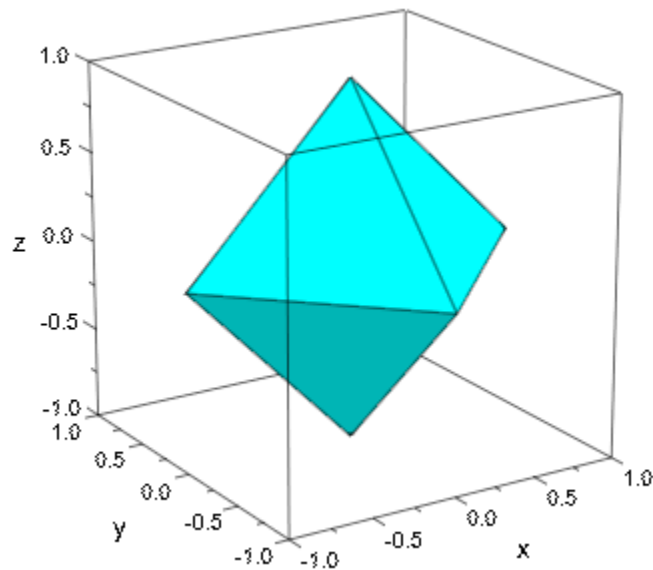

`delete mycolorlist:`

## Algorithms

A polyhedron is called regular if all its facets consist of the same regular polygon and each vertex has the same number of coincidence polygons.

Since Plato we know that only five regular polyhedrons exist:

- the tetrahedron with 4 (greek *tetra*) triangles,
- the hexahedron with 6 (greek *hexa*) squares,
- the octahedron with 8 (greek *okta*) triangles,
- the dodecahedron with 12 (greek *dodeka*) pentagons and
- the icosahedron with 20 (greek *eikosi*) triangles.

The following table lists some important geometrical data of the polyhedra with the edge length  $a$ . Where  $R$  is the radius of the outer sphere,  $r$  the radius of the inner sphere,  $A$  the surface area and  $V$  the volume:

Ratio	Tetrahedron	Hexahedron	Octahedron	Dodecahedron	Icosahedron
$\frac{R}{a}$	$\frac{\sqrt{6}}{4}$	$\frac{\sqrt{3}}{2}$	$\frac{\sqrt{2}}{2}$	$\frac{\sqrt{3}(1+\sqrt{5})}{4}$	$\frac{\sqrt{10+2\sqrt{5}}}{4}$
$\frac{r}{a}$	$\frac{\sqrt{6}}{12}$	$\frac{1}{2}$	$\frac{\sqrt{6}}{6}$	$\frac{\sqrt{250+110\sqrt{5}}}{20}$	$\frac{\sqrt{3}(3+\sqrt{5})}{12}$
$\frac{A}{a^2}$	$\sqrt{3}$	6	$2\sqrt{3}$	$3\sqrt{25+10\sqrt{5}}$	$5\sqrt{3}$
$\frac{V}{a^3}$	$\frac{\sqrt{2}}{12}$	1	$\frac{\sqrt{2}}{3}$	$\frac{(15+7\sqrt{5})}{4}$	$\frac{5(3+\sqrt{5})}{12}$

## See Also

### MuPAD Functions

plot

### MuPAD Graphical Primitives

plot::Box | plot::Cone | plot::Cylinder | plot::Dodecahedron |  
 plot::Hexahedron | plot::Octahedron | plot::Parallelogram3d |  
 plot::Sphere | plot::Tetrahedron | plot::Transform3d



# plot::Text2d

2D text

## Syntax

```
plot::Text2d(text, [x, y], <a = amin .. amax>, options)
```

## Description

`plot::Text2d` draws a text at a given position  $(x, y)$  (the “anchor point”). The attributes `VerticalAlignment` and `HorizontalAlignment` determine the alignment of the text w.r.t. its anchor.

Size, text color, font type etc. are controlled by the attribute `TextFont`.

A text may consist of several lines. The newline character in MuPAD strings is `\n`. For example: `"first line\nsecond line"`.

The attribute `TextRotation` allows to rotate the text on the screen.

The text of a text object can be animated if it is passed as a procedure that returns the text string during runtime. Cf. “Example 5” on page 24-959 (Symbolic Math Toolbox).

## Attributes

Attribute	Purpose	Default Value
<code>AffectViewingBox</code>	influence of objects on the <code>ViewingBox</code> of a scene	TRUE
<code>Frames</code>	the number of frames in an animation	50
<code>HorizontalAlignment</code>	horizontal alignment of text objects w.r.t. their coordinates	Left

<b>Attribute</b>	<b>Purpose</b>	<b>Default Value</b>
Legend	makes a legend entry	
LegendText	short explanatory text for legend	
LegendEntry	add this object to the legend?	FALSE
Name	the name of a plot object (for browser and legend)	
ParameterEnd	end value of the animation parameter	
ParameterName	name of the animation parameter	
ParameterBegin	initial value of the animation parameter	
ParameterRange	range of the animation parameter	
Position	positions of cameras, lights, and text objects	
PositionX	x-positions of cameras, lights, and text objects	
PositionY	y-positions of cameras, lights, and text objects	
Text	the text of a text object	
TextFont	font of text objects	[" sans-serif ", 11]
TextRotation	rotation of a 2D text	0
TimeEnd	end time of the animation	10.0
TimeBegin	start time of the animation	0.0
TimeRange	the real time span of an animation	0.0 .. 10.0
Title	object title	
TitleFont	font of object titles	[" sans-serif ", 11]
TitlePosition	position of object titles	

Attribute	Purpose	Default Value
TitleAlignment	horizontal alignment of titles w.r.t. their coordinates	Center
TitlePositionX	position of object titles, x component	
TitlePositionY	position of object titles, y component	
VerticalAlignment	vertical alignment of text objects w.r.t. their coordinates	BaseLine
Visible	visibility	TRUE
VisibleAfter	object visible after this time value	
VisibleBefore	object visible until this time value	
VisibleFromTo	object visible during this time range	
VisibleAfterEnd	object visible after its animation time ended?	TRUE
VisibleBeforeBegin	object visible before its animation time starts?	TRUE

## Examples

### Example 1

We draw the text string `Hello world!` at the anchor point (1, 2) which is indicated by a red dot:

```
plot(plot::Rectangle(0..2, 0..4),
      plot::Point2d([1, 2]),
      plot::Text2d("Hello world!", [1, 2],
                   HorizontalAlignment = Center),
      Axes = Frame, TextFont = [24],
      PointColor = RGB::Red, PointSize = 3*unit::mm)
```

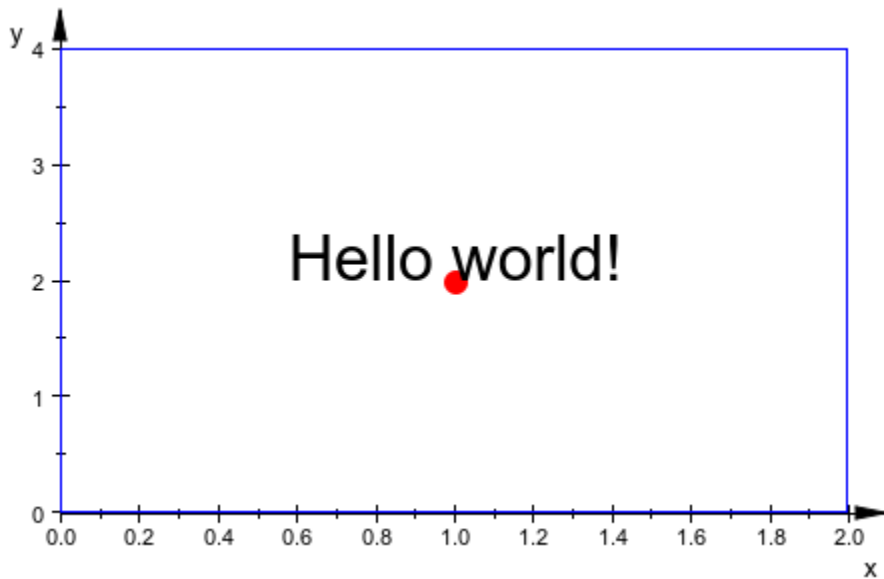

## Example 2

We animate the anchor points of the following texts and demonstrate various alignment possibilities:

```
plot(plot::Circle2d(1),
      plot::Point2d([sin(a), cos(a)], a = 0..2*PI),
      plot::Point2d([cos(a), -sin(a)], a = 0..2*PI),
      plot::Point2d([-sin(a), -cos(a)], a = 0..2*PI),
      plot::Point2d([-cos(a), sin(a)], a = 0..2*PI),
      PointColor = RGB::Red, PointSize = 3*unit::mm,
      plot::Text2d("Hello (1)", [sin(a), cos(a)], a = 0..2*PI),
      plot::Text2d("Hello (2)", [cos(a), -sin(a)], a = 0..2*PI,
                    HorizontalAlignment = Left,
                    VerticalAlignment = BaseLine),
      plot::Text2d("Hello (3)", [-sin(a), -cos(a)], a = 0..2*PI,
                    HorizontalAlignment = Center,
                    VerticalAlignment = Top),
      plot::Text2d("Hello (4)", [-cos(a), sin(a)], a = 0..2*PI,
                    HorizontalAlignment = Right,
                    VerticalAlignment = Bottom),
      TextFont = [Italic, 24], Axes = Frame)
```

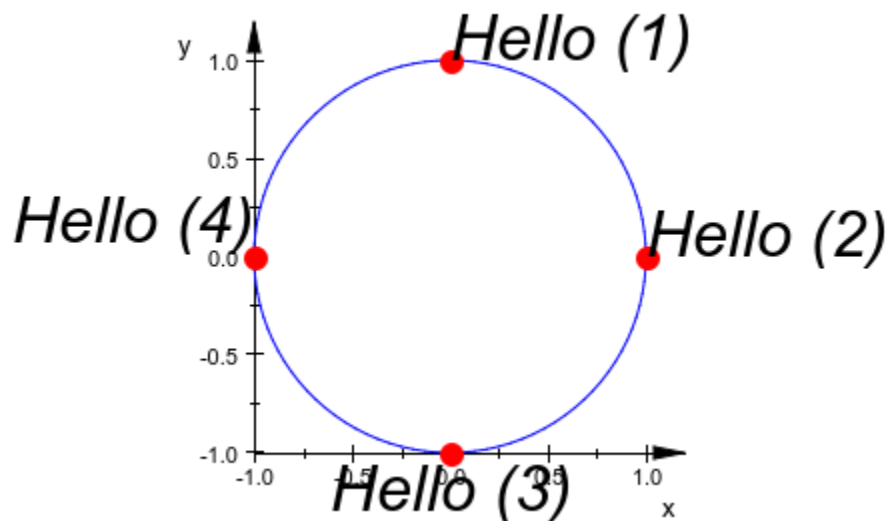

### Example 3

A text may consist of several lines. The newline character in MuPAD strings is `\n`:

```
plot(plot::Text2d("A text can\nhave several\nlines",  
                 [sin(a), cos(a)], a = 0..2*PI),  
     Axes = Frame, TextFont = [20])
```

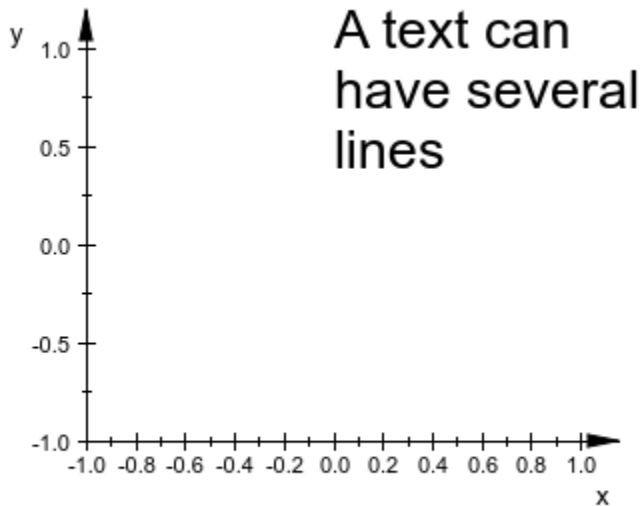

### Example 4

The attribute `TextRotation` allows to rotate a 2D text on the screen:

```
plot(plot::Circle2d(sqrt(2)),  
      plot::Text2d("Hello (1)", [ 1, 1],  
                  HorizontalAlignment = Left,  
                  TextRotation = PI/4),  
      plot::Text2d("Hello (2)", [ 1,-1],  
                  HorizontalAlignment = Left,  
                  TextRotation = -PI/4),  
      plot::Text2d("Hello (3)", [-1,-1],  
                  HorizontalAlignment = Right,  
                  TextRotation = PI/4),  
      plot::Text2d("Hello (4)", [-1, 1],  
                  HorizontalAlignment = Right,  
                  TextRotation = -PI/4),  
      HorizontalAlignment = Left, TextFont = [20])
```

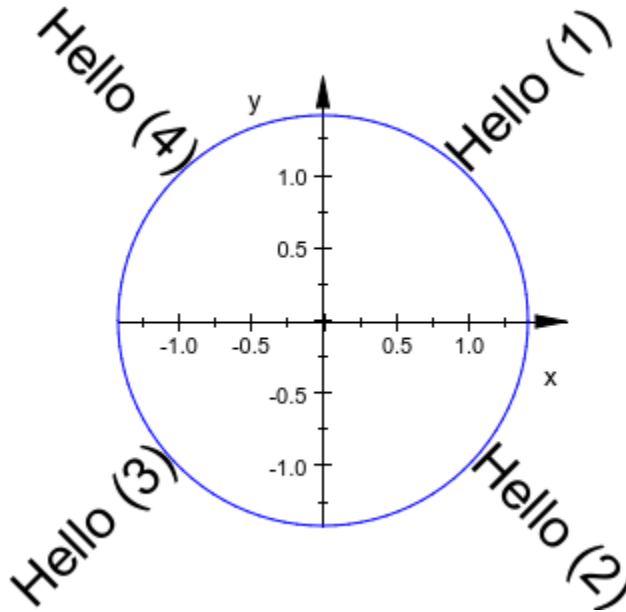

### Example 5

The text of a text object can be animated if the text string is provided by a procedure. We use `stringlib::formatf` to format the animation parameter that is passed to the procedure as a floating-point number for each frame of the animation:

```
plot(plot::Rectangle(-1..1, -1..1),
      plot::Text2d(a -> stringlib::formatf(a, 2, 5)." sec",
        [0, 0], a = 0..20),
      TextFont = [60],
      HorizontalAlignment = Center, VerticalAlignment = Center,
      Axes = Frame, Frames = 201, TimeRange = 0..20)
```

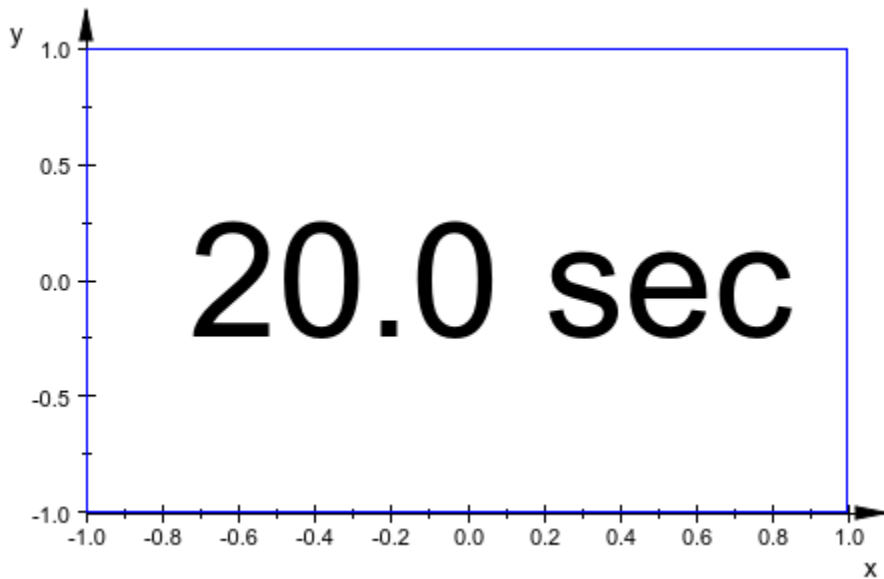

## Parameters

### text

The text: a string on page 7-53. Alternatively, a procedure that accepts one input parameter  $a$  (the animation parameter) and returns a string.

text is equivalent to the attribute Text.

### $x, y$

The position of the text. The coordinates  $x$  and  $y$  must be real numerical values or arithmetical expressions (Symbolic Math Toolbox) of the animation parameter  $a$ .

$x, y$  are equivalent to the attributes Position, PositionX, PositionY.

### $a$

Animation parameter, specified as  $a = a_{\min} \dots a_{\max}$ , where  $a_{\min}$  is the initial parameter value, and  $a_{\max}$  is the final parameter value.



## See Also

### **MuPAD Functions**

plot | plot::copy | stringlib::formatf

### **MuPAD Graphical Primitives**

plot::Text3d

## plot::Text3d

3D text

### Syntax

```
plot::Text3d(text, [x, y, z], <a = amin .. amax>, options)
```

### Description

`plot::Text3d` draws a text at a given position  $(x, y, z)$  (the “anchor point”). The attributes `VerticalAlignment` and `HorizontalAlignment` determine the alignment of the text w.r.t. its anchor.

Size, text color, font type etc. are controlled by the attribute `TextFont`.

In contrast to `plot::Text2d`, a 3D text cannot consist of several lines. The newline character `\n` in MuPAD strings does not have an effect.

By default, a 3D text uses `Billboarding = TRUE`, i.e., the text is automatically oriented such that it is readable by the observer. When setting `Billboarding = FALSE`, the attribute `TextOrientation` allows to fix the orientation of the text arbitrarily in space. See the help page of `TextOrientation` for details.

The text of a text object can be animated if it is passed as a procedure that returns the text string during runtime. Cf. “Example 5” on page 24-969 (Symbolic Math Toolbox).

### Attributes

Attribute	Purpose	Default Value
<code>AffectViewingBox</code>	influence of objects on the <code>ViewingBox</code> of a scene	TRUE
<code>Billboarding</code>	text orientation in space or towards observer	TRUE

<b>Attribute</b>	<b>Purpose</b>	<b>Default Value</b>
Frames	the number of frames in an animation	50
HorizontalAlignment	horizontal alignment of text objects w.r.t. their coordinates	Left
Legend	makes a legend entry	
LegendText	short explanatory text for legend	
LegendEntry	add this object to the legend?	FALSE
Name	the name of a plot object (for browser and legend)	
ParameterEnd	end value of the animation parameter	
ParameterName	name of the animation parameter	
ParameterBegin	initial value of the animation parameter	
ParameterRange	range of the animation parameter	
Position	positions of cameras, lights, and text objects	
PositionX	x-positions of cameras, lights, and text objects	
PositionY	y-positions of cameras, lights, and text objects	
PositionZ	z-positions of cameras, lights, and text objects	
Text	the text of a text object	
TextFont	font of text objects	[" sans-serif ", 11]
TextOrientation	orientation of a 3D text	[1, 0, 0, 0, 0, 1]
TimeEnd	end time of the animation	10.0

<b>Attribute</b>	<b>Purpose</b>	<b>Default Value</b>
TimeBegin	start time of the animation	0.0
TimeRange	the real time span of an animation	0.0 .. 10.0
Title	object title	
TitleFont	font of object titles	[" sans-serif ", 11]
TitlePosition	position of object titles	
TitleAlignment	horizontal alignment of titles w.r.t. their coordinates	Center
TitlePositionX	position of object titles, x component	
TitlePositionY	position of object titles, y component	
TitlePositionZ	position of object titles, z component	
VerticalAlignment	vertical alignment of text objects w.r.t. their coordinates	BaseLine
Visible	visibility	TRUE
VisibleAfter	object visible after this time value	
VisibleBefore	object visible until this time value	
VisibleFromTo	object visible during this time range	
VisibleAfterEnd	object visible after its animation time ended?	TRUE
VisibleBeforeBegin	object visible before its animation time starts?	TRUE

## Examples

### Example 1

We draw the text string `Hello world!` at the anchor point (1, 2, 3) which is indicated by a red dot:

```
plot(plot::Circle3d(3, [1, 2, 3], [0, 0, 1]),
      plot::Point3d([1, 2, 3]),
      plot::Text3d("Hello world!", [1, 2, 3],
                   HorizontalAlignment = Center),
      Axes = Frame, TextFont = [24],
      PointColor = RGB::Red, PointSize = 3*unit::mm)
```

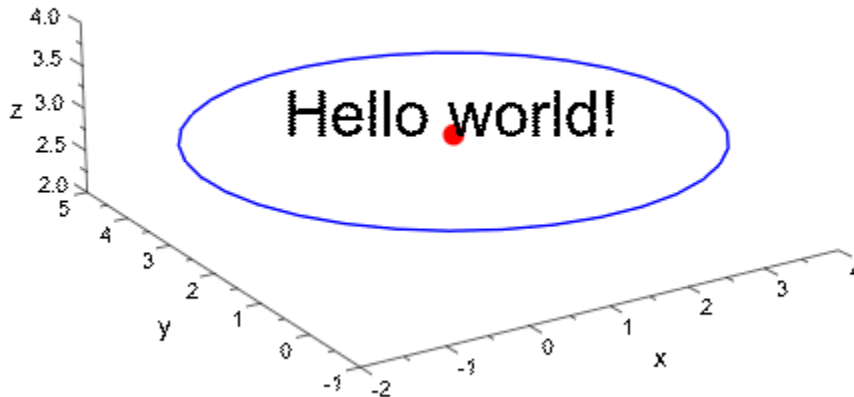

### Example 2

We animate the anchor points of the following texts and demonstrate various alignment possibilities:

```
plot(plot::Circle3d(1, [0, 0, 0], [0, 0, 1]),
      plot::Point3d([sin(a), cos(a), 0], a = 0..2*PI),
```

```

plot::Point3d([cos(a), -sin(a), 0], a = 0..2*PI),
plot::Point3d([-sin(a), -cos(a), 0], a = 0..2*PI),
plot::Point3d([-cos(a), sin(a), 0], a = 0..2*PI),
PointColor = RGB::Red, PointSize = 3*unit::mm,
plot::Text3d("Hello (1)", [sin(a), cos(a), 0], a = 0..2*PI),
plot::Text3d("Hello (2)", [cos(a), -sin(a), 0], a = 0..2*PI,
    HorizontalAlignment = Left,
    VerticalAlignment = BaseLine),
plot::Text3d("Hello (3)", [-sin(a), -cos(a), 0], a = 0..2*PI,
    HorizontalAlignment = Center,
    VerticalAlignment = Top),
plot::Text3d("Hello (4)", [-cos(a), sin(a), 0], a = 0..2*PI,
    HorizontalAlignment = Right,
    VerticalAlignment = Bottom),
TextFont = [Italic, 24], Axes = Frame,
CameraDirection = [0, -1, 10])

```

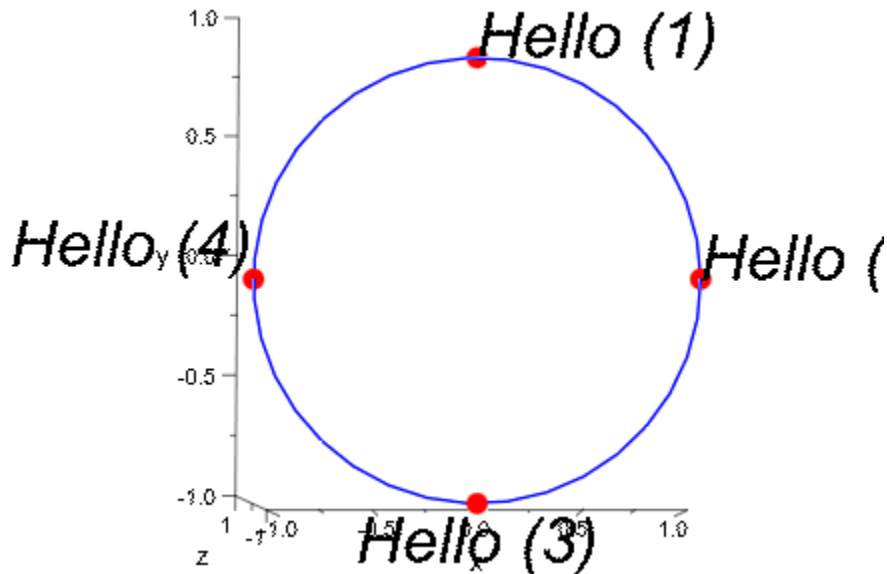

### Example 3

In contrast to `plot::Text2d`, a 3D text may not consist of several lines. The newline character `\n` in MuPAD strings does not have any effect:

```

plot(plot::Text3d("A 3D text cannot \nhave several\nlines",
                  HorizontalAlignment = Center,
                  [0, 0, 0]),
     Axes = Frame, TextFont = [20])

```

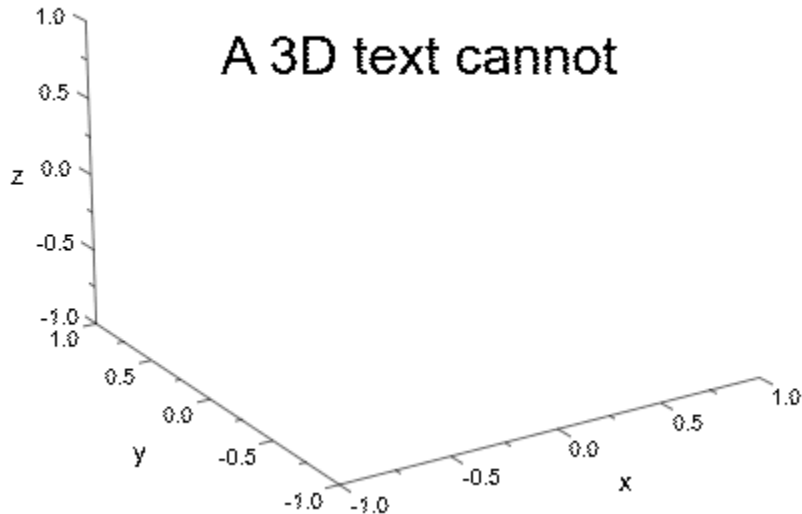

## Example 4

Per default, the attribute `Billboarding = TRUE` is set. The text always faces the observer:

```

plot(plot::Circle3d(1, [0, 0, 0], [0, 0, 1]),
     plot::Point3d([-cos(a), -sin(a), 0], a = 0 .. 2*PI),
     plot::Point3d([cos(a), sin(a), 0], a = 0 .. 2*PI),
     plot::Text3d("Hello (1)", [-cos(a), -sin(a), 0],
                  a = 0 .. 2*PI),
     plot::Text3d("Hello (2)", [cos(a), sin(a), 0],
                  a = 0 .. 2*PI),
     Axes = Frame, TextFont = [20],
     PointColor = RGB::Red, PointSize = 2*unit::mm)

```

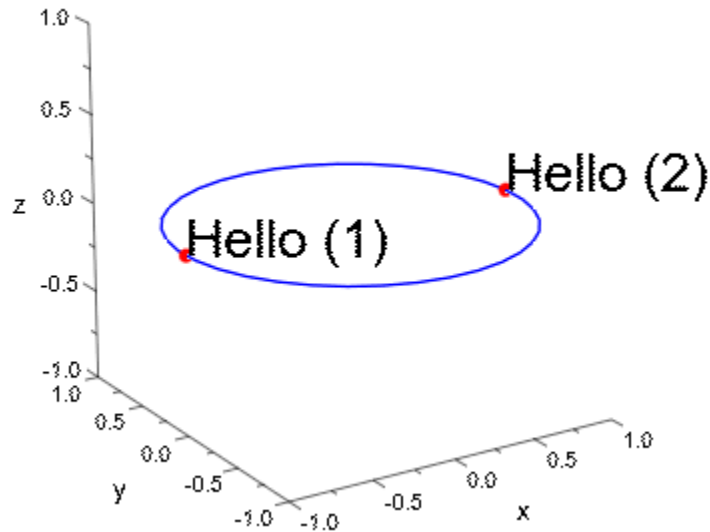

We use `TextOrientation` to fix the orientation of the texts in space. The first text lies in a plane parallel to the  $x$ - $y$  plane, the second text is parallel to the  $x$ - $z$  plane. Note that we have to specify `Billboarding = FALSE` for `TextOrientation` to have an effect:

```
plot(plot::Circle3d(1, [0, 0, 0], [0, 0, 1]),
      plot::Point3d([-cos(a), -sin(a), 0], a = 0 .. 2*PI),
      plot::Point3d([cos(a), sin(a), 0], a = 0 .. 2*PI),
      PointColor = RGB::Red, PointSize = 2*unit::mm,
      plot::Text3d("Hello (1)", [-cos(a), -sin(a), 0],
                  a = 0 .. 2*PI,
                  TextOrientation = [1, 0, 0, 0, 1, 0]),
      plot::Text3d("Hello (2)", [cos(a), sin(a), 0],
                  a = 0 .. 2*PI,
                  TextOrientation = [1, 0, 0, 0, 0, 1]),
      Billboarding = FALSE, TextFont = [20], Axes = Frame)
```



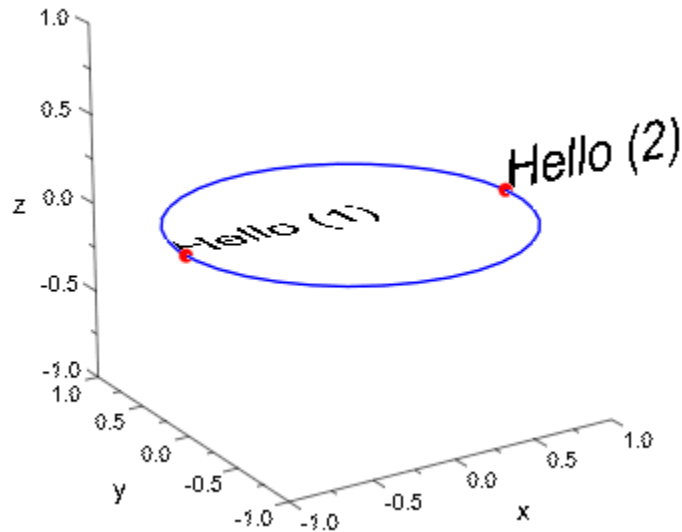

## Example 5

The text of a text object can be animated if the text string is provided by a procedure. We use `stringlib::formatf` to format the animation parameter that is passed to the procedure as a floating-point number for each frame of the animation:

```
plot(plot::Text3d(a -> stringlib::formatf(a, 2, 5)." sec",
      [0, 0, 0], a = 0..20),
      TextFont = [60],
      HorizontalAlignment = Center, VerticalAlignment = Center,
      Axes = Frame, Frames = 201, TimeRange = 0..20)
```

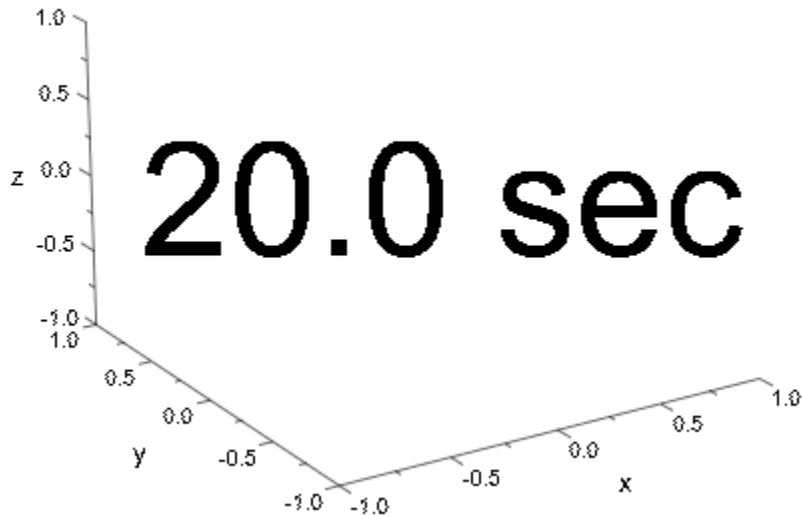

## Parameters

### text

The text: a string on page 7-53. Alternatively, a procedure that accepts one input parameter  $a$  (the animation parameter) and returns a string.

text is equivalent to the attribute Text.

### x, y, z

The position of the text. The coordinates  $x$ ,  $y$ ,  $z$  must be real numerical values or arithmetical expressions (Symbolic Math Toolbox) of the animation parameter  $a$ .

$x$ ,  $y$ ,  $z$  are equivalent to the attributes Position, PositionX, PositionY, PositionZ.

### a

Animation parameter, specified as  $a = a_{\min} \dots a_{\max}$ , where  $a_{\min}$  is the initial parameter value, and  $a_{\max}$  is the final parameter value.

## See Also

### MuPAD Functions

plot | plot::copy | stringlib::formatf

### MuPAD Graphical Primitives

plot::Text2d

## plot::Tube

Generalized tubular plots (canal surfaces)

### Syntax

```
plot::Tube([x, y, z], <r>, t = t_min .. t_max, <a = a_min .. a_max>, options)
```

### Description

`plot::Tube` creates generalized tubular plots, known as “canal surfaces”, with special cases known as “tube surface”, “pipe surface” or “tubular surfaces.”

Intuitively, canal surfaces are space curves with thickness. More formally, a canal surface `plot::Tube([x(t), y(t), z(t)], r(t), t = t_min..t_max)` is the envelope of spheres with center  $[x(t), y(t), z(t)]$  and radius  $r(t)$ , i.e., the thickness of the curve can vary with the curve parameter  $t$ .

### Attributes

Attribute	Purpose	Default Value
AffectViewingBox	influence of objects on the ViewingBox of a scene	TRUE
AngleEnd	end of angle range	2*PI
AngleBegin	begin of angle range	0
AngleRange	angle range	0 .. 2*PI
Filled	filled or transparent areas and surfaces	TRUE
FillColor	color of areas and surfaces	RGB::Red
FillColor2	second color of areas and surfaces for color blends	RGB::CornflowerBlue

Attribute	Purpose	Default Value
FillColorType	surface filling types	Dichromatic
FillColorFunction	functional area/surface coloring	
FillColorDirection	the direction of color transitions on surfaces	[0, 0, 1]
FillColorDirectionX	x-component of the direction of color transitions on surfaces	0
FillColorDirectionY	y-component of the direction of color transitions on surfaces	0
FillColorDirectionZ	z-component of the direction of color transitions on surfaces	1
Frames	the number of frames in an animation	50
Legend	makes a legend entry	
LegendText	short explanatory text for legend	
LegendEntry	add this object to the legend?	TRUE
LineColor	color of lines	RGB::Black.[0.25]
LineWidth	width of lines	0.35
LineColor2	color of lines	RGB::DeepPink
LineColorType	line coloring types	Flat
LineColorFunction	functional line coloring	
LineColorDirection	the direction of color transitions on lines	[0, 0, 1]
LineColorDirectionX	x-component of the direction of color transitions on lines	0
LineColorDirectionY	y-component of the direction of color transitions on lines	0

<b>Attribute</b>	<b>Purpose</b>	<b>Default Value</b>
LineColorDirectionZ	z-component of the direction of color transitions on lines	1
Mesh	number of sample points	[60, 11]
Name	the name of a plot object (for browser and legend)	
ParameterEnd	end value of the animation parameter	
ParameterName	name of the animation parameter	
ParameterBegin	initial value of the animation parameter	
ParameterRange	range of the animation parameter	
PointsVisible	visibility of mesh points	FALSE
RadiusFunction	radius of a tube plot	1/10
Shading	smooth color blend of surfaces	Smooth
Submesh	density of submesh (additional sample points)	[0, 1]
TimeEnd	end time of the animation	10.0
TimeBegin	start time of the animation	0.0
TimeRange	the real time span of an animation	0.0 .. 10.0
Title	object title	
TitleFont	font of object titles	[" sans-serif ", 11]
TitlePosition	position of object titles	
TitleAlignment	horizontal alignment of titles w.r.t. their coordinates	Center
TitlePositionX	position of object titles, x component	

Attribute	Purpose	Default Value
TitlePositionY	position of object titles, y component	
TitlePositionZ	position of object titles, z component	
ULinesVisible	visibility of parameter lines (u lines)	TRUE
UMax	final value of parameter "u"	
UMesh	number of sample points for parameter "u"	60
UMin	initial value of parameter "u"	
UName	name of parameter "u"	
URange	range of parameter "u"	
USubmesh	density of additional sample points for parameter "u"	0
VLinesVisible	visibility of parameter lines (v lines)	TRUE
VMesh	number of sample points for parameter "v"	11
VSubmesh	density of additional sample points for parameter "v"	1
Visible	visibility	TRUE
VisibleAfter	object visible after this time value	
VisibleBefore	object visible until this time value	
VisibleFromTo	object visible during this time range	
VisibleAfterEnd	object visible after its animation time ended?	TRUE
VisibleBeforeBegin	object visible before its animation time starts?	TRUE

Attribute	Purpose	Default Value
XFunction	function for x values	
YFunction	function for y values	
ZFunction	function for z values	

## Examples

### Example 1

A torus can be drawn as a tube around a circle:

```
plot(plot::Tube([cos(t), sin(t), 0], 0.4,  
  t = 0..2*PI))
```

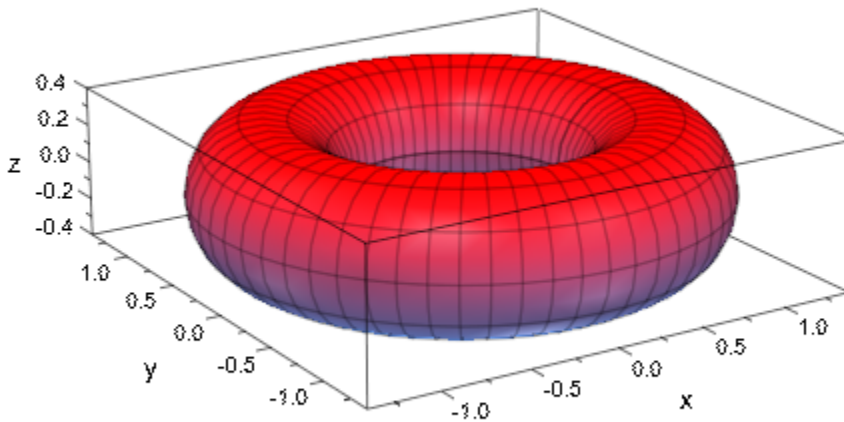

Varying the diameter of the tube, we deform the torus into a cyclide:

```
plot(plot::Tube([cos(t), sin(t), 0], 0.4 + 0.3*cos(t),  
  t = 0..2*PI))
```



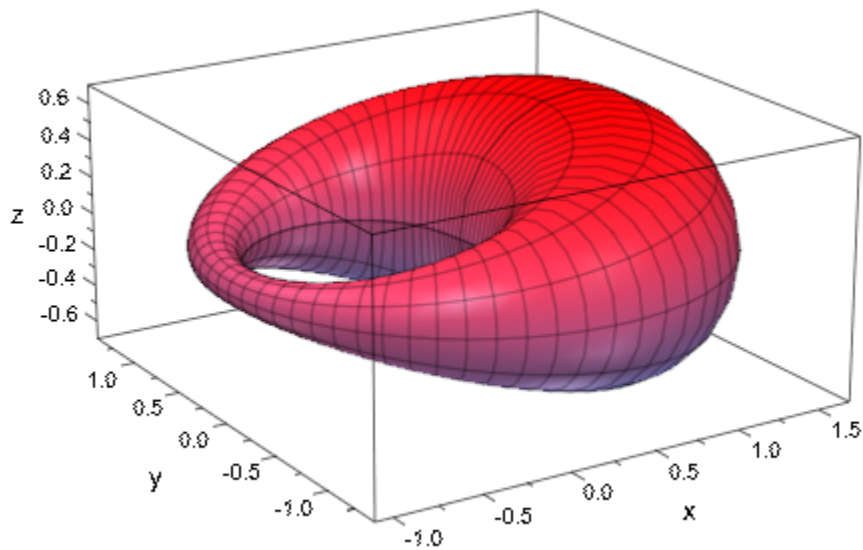

## Example 2

All surfaces of revolution are special cases of canal surfaces:

```
plot(plot::Scene3d(plot::XRotate(sin(u), u = 0..10)),  
      plot::Scene3d(plot::ZRotate(sin(u), u = 0..10)),  
      plot::Scene3d(plot::Tube([u, 0, 0], sin(u), u = 0..10)),  
      plot::Scene3d(plot::Tube([0, 0, sin(u)], u, u = 0..10)),  
      Width = 180 * unit::mm)
```

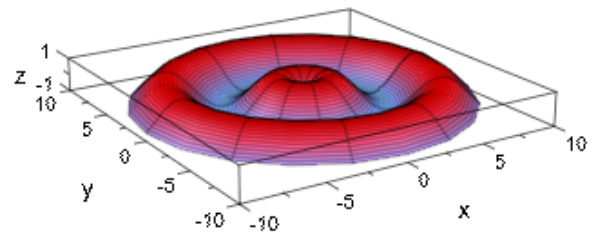
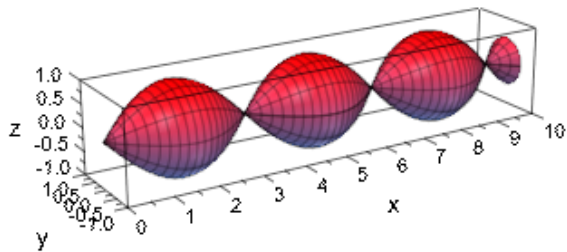
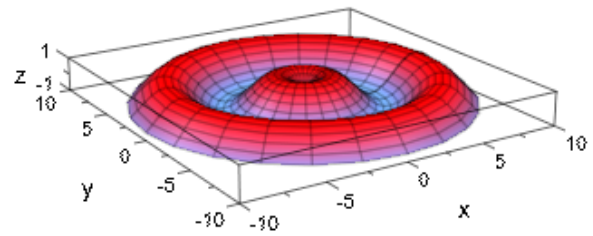
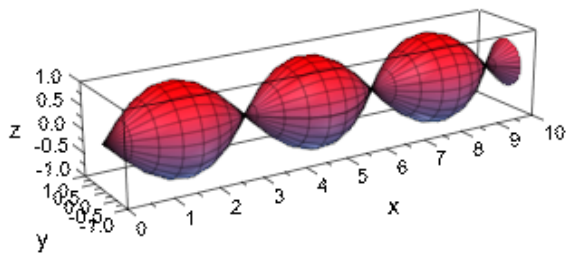

The last image shows that the defaults for the mesh are not always adequate and should be changed:

```
plot(plot::Tube([0, 0, sin(u)], u, u = 0..10,  
  Mesh = [20, 20]))
```

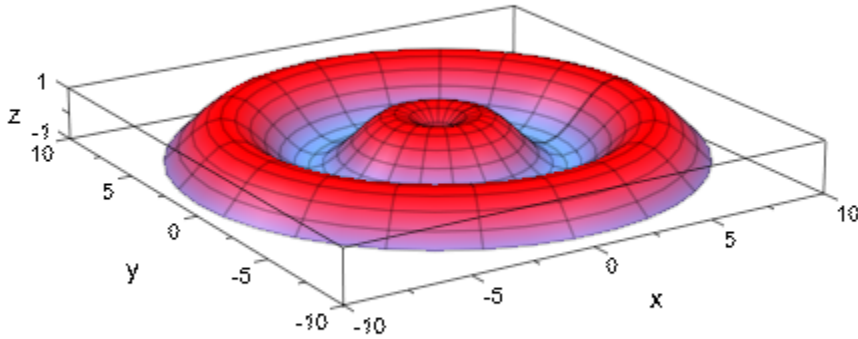

### Example 3

The famous Klein bottle can be obtained from a “drop silhouette” by using an appropriate radius parametrization:

```
plot(plot::Tube([6*cos(u)*(sin(u) - 1), 0, 14*sin(u)],  
                4 - 2*cos(u), u = -PI..PI))
```

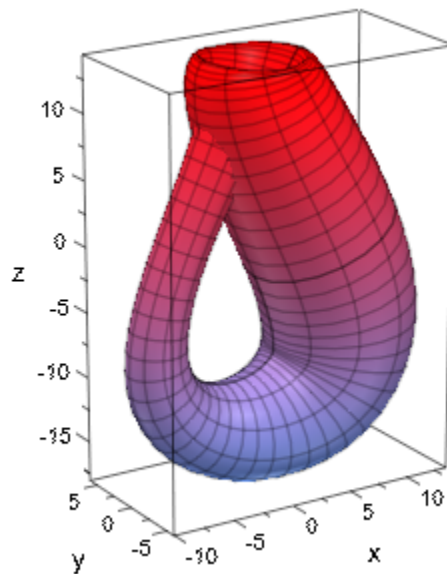

### Example 4

Re-using the cyclide from above, we demonstrate coloring a canal surface:

```
color := (t, phi) -> RGB::fromHSV([(t+sin(4*phi))*180/PI, 1, 1]):  
plot(plot::Tube([sin(t), cos(t), 0], 0.4 + 0.3*cos(t), t=0..2*PI,  
FillColorFunction = color))
```

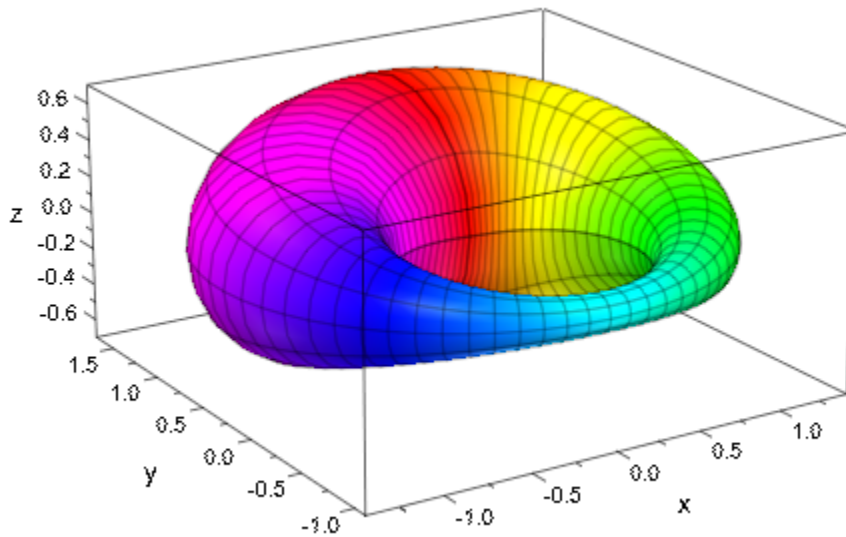

## Example 5

Yet another variation of the cyclide, we use a non-constant AngleRange to “slice” it:

```
plot(plot::Tube([sin(t), cos(t), 0], 0.4 - 0.3*sin(t), t=0..2*PI,  
               AngleRange = 0 .. 2*PI*sin(abs(t-PI/2)/2)),  
     Axes = None, CameraDirection = [14, 1, 5])
```

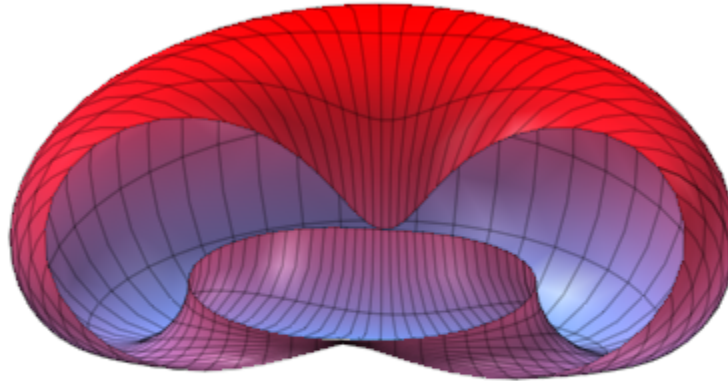

Combining more than one tubular plot with identical spine curves but different angle ranges, we can achieve a braid-like effect:

```
braid := i ->
  plot::Tube([sin(u), cos(u), 0], 0.2, u=0..2*PI,
    AngleRange = i*PI/3 + 3*u .. i*PI/3 + 3*u + 1/2,
    Color = RGB::EmeraldGreen, Mesh = [60, 2]):
torus := plot::Tube([sin(u), cos(u), 0], 0.18, u=0..2*PI,
  Color = RGB::BlueLight,
  Name = "Torus"):
plot(braid(i) $ i = 0..5,
  torus,
  ULinesVisible = FALSE, VLinesVisible = FALSE,
  FillColorType = Flat,
  Axes = None, CameraDirection = [0, 7, 10])
```

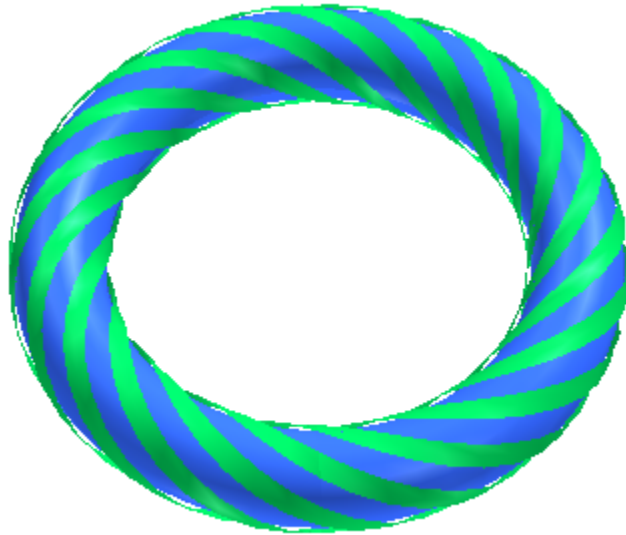

### Example 6

The spine curve, the radius function, color functions etc. can be animated as usual:

```
plot(plot::Tube([sin(t)*sin(a), cos(t)*cos(a), sin(a)],  
               0.4 - 0.3*sin(t-a),  
               t = 0..2*PI, a = 0..2*PI,  
               Frames = 20, TimeRange = 0..5))
```

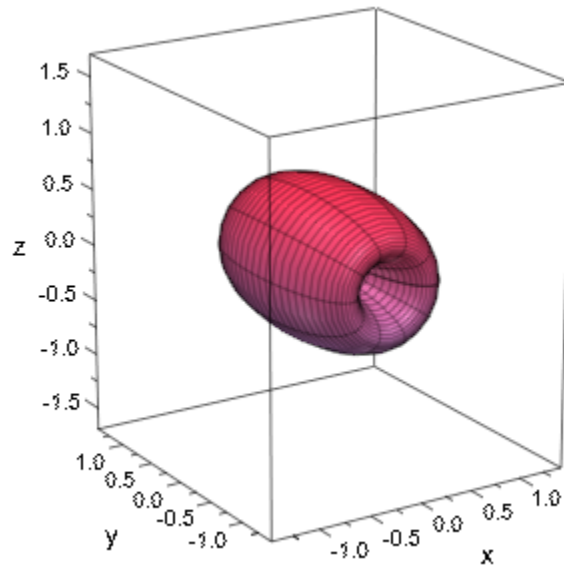

### Example 7

Note that in the presence of a sharp bend (in relation to the tube diameter), the surface plotted by `plot::Tube` may self-intersect:

```
plot(plot::Tube([x, 0, x^2], 1.2, x = -1.4..1.4,  
    Mesh = [20, 10]),  
    Axes = None, CameraDirection = [-3, 1, 2])
```



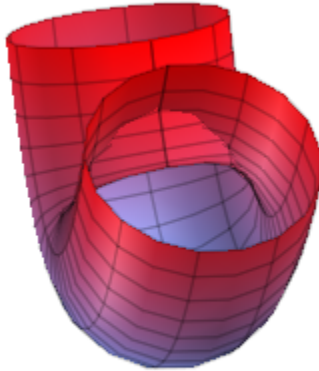

This effect is unavoidable. Sharp bends also cause another effect which can be avoided by increasing the mesh density: The tube might not follow the curve quickly enough:

```
plot(plot::Tube([sin(x^2), x, 0], x = -5..0))
```

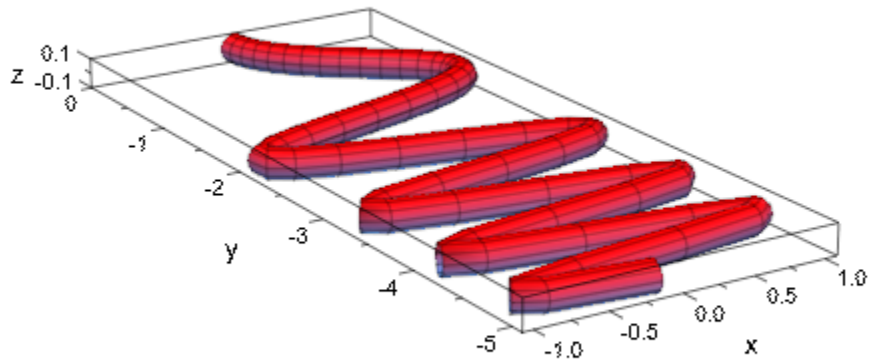

In this situation, you can set `USubmesh` to a positive value to request additional function evaluations:

```
plot(plot::Tube([sin(x^2), x, 0], x = -5..0, USubmesh = 5))
```

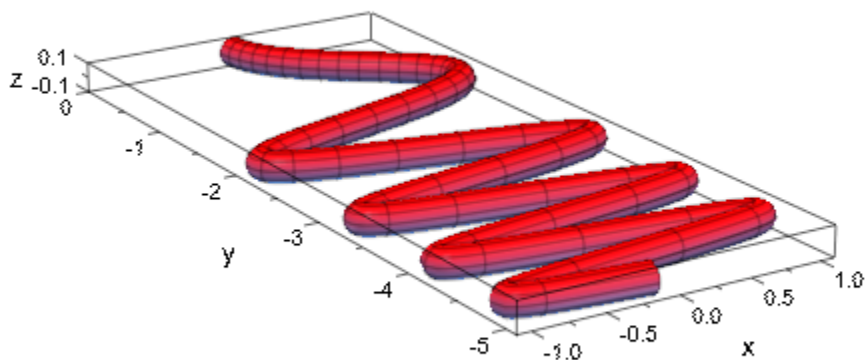

## Parameters

### **x, y, z**

The spine curve coordinates: real-valued expressions in **t** and the animation parameter.

**x, y, z** are equivalent to the attributes `XFunction`, `YFunction`, `ZFunction`.

### **r**

The tube radius: a real-valued expression in **t** and the animation parameter. Default is the constant  $\frac{1}{10}$ .

**r** is equivalent to the attribute `RadiusFunction`.

### **t**

The curve parameter: an (indexed) identifier.

**t** is equivalent to the attribute `UName`.

$t_{\min} .. t_{\max}$

The range of the curve parameter: real-valued expressions in the animation parameter.

$t_{\min} .. t_{\max}$  is equivalent to the attributes `URange`, `UMin`, `UMax`.

**a**

Animation parameter, specified as  $a = a_{\min} .. a_{\max}$ , where  $a_{\min}$  is the initial parameter value, and  $a_{\max}$  is the final parameter value.

## See Also

### MuPAD Functions

`plot` | `plot::copy`

### MuPAD Graphical Primitives

`plot::Curve3d` | `plot::Surface`

# plot::Turtle

“turtle graphics” (imperative drawings)

## Syntax

```
plot::Turtle(commands, <a = amin .. amax>, options)
```

## Description

Turtle graphics define a line drawing by a sequence of commands to an abstract robot.

`plot::Turtle` defines a graphic by sending movement commands to an abstract robot. This robot starts heading up and standing at the origin, with its pen ready for drawing (“down”) and the line color taken from the attribute `LineColor`.

The following commands are known to the robot:

- `Left( $\alpha$ )`  
Turn left by the angle  $\alpha$  (in radians).
- `Right( $\alpha$ )`  
Turn right by the angle  $\alpha$  (in radians).
- `Forward( $d$ )`  
Move forward distance  $d$ .
- `Up`  
Lift the “pen”, i.e., subsequent movement commands do not draw lines.
- `Down`  
Lower the “pen”, i.e., subsequent movement commands do draw lines.
- `Push`  
Remember the current state (position, angle, line color).

- Pop

Restore the last remembered state and remove it from the list of remembered states.

- Noop

This command is ignored.

- LineColor(c)

Set the line color to the colorc.

The commands not taking an argument may also be entered with empty parentheses ( ) after, e.g., Push( ).

A plot::Turtle-object can be manipulated dynamically by calling its methods left, right, forward, penUp, penDown, push, pop, and setLineColor, with the obvious connections to the commands above. These methods append a new command to the end of the list. Cf. “Example 3” on page 24-997 (Symbolic Math Toolbox).

---

**Note** For long command sequences, it is highly recommended to give the commands directly using the syntax above or by setting the CommandList attribute directly.

---

Both angles and distances can be animated. Colors can not.

## Attributes

Attribute	Purpose	Default Value
AffectViewingBox	influence of objects on the ViewingBox of a scene	TRUE
AntiAliased	antialiased lines and points?	TRUE
Color	the main color	RGB::Blue
CommandList	turtle movement commands	[]
Frames	the number of frames in an animation	50
Legend	makes a legend entry	

<b>Attribute</b>	<b>Purpose</b>	<b>Default Value</b>
LegendText	short explanatory text for legend	
LegendEntry	add this object to the legend?	FALSE
LineColor	color of lines	RGB::Blue
LineWidth	width of lines	0.35
LineStyle	solid, dashed or dotted lines?	Solid
LinesVisible	visibility of lines	TRUE
Name	the name of a plot object (for browser and legend)	
ParameterEnd	end value of the animation parameter	
ParameterName	name of the animation parameter	
ParameterBegin	initial value of the animation parameter	
ParameterRange	range of the animation parameter	
PointSize	the size of points	1.5
PointStyle	the presentation style of points	FilledCircles
PointsVisible	visibility of mesh points	FALSE
TimeEnd	end time of the animation	10.0
TimeBegin	start time of the animation	0.0
TimeRange	the real time span of an animation	0.0 .. 10.0
Title	object title	
TitleFont	font of object titles	[" sans-serif ", 11]
TitlePosition	position of object titles	

Attribute	Purpose	Default Value
TitleAlignment	horizontal alignment of titles w.r.t. their coordinates	Center
TitlePositionX	position of object titles, x component	
TitlePositionY	position of object titles, y component	
Visible	visibility	TRUE
VisibleAfter	object visible after this time value	
VisibleBefore	object visible until this time value	
VisibleFromTo	object visible during this time range	
VisibleAfterEnd	object visible after its animation time ended?	TRUE
VisibleBeforeBegin	object visible before its animation time starts?	TRUE

## Examples

### Example 1

A square can be drawn by four times moving forward, each time turning right 90°:

```
plot(plot::Turtle([Forward(1), Right(PI/2),  
                  Forward(1), Right(PI/2),  
                  Forward(1), Right(PI/2),  
                  Forward(1), Right(PI/2)]))
```





Using the \$ operator, this command list can be written much shorter:

```
plot(plot::Turtle([(Forward(1), Right(PI/2))$4]))
```



In the same fashion, we can draw any regular  $n$ -sided polygon:

```
n := 7:  
plot(plot::Turtle([(Forward(1), Right(2*PI/n)) $ n]))
```

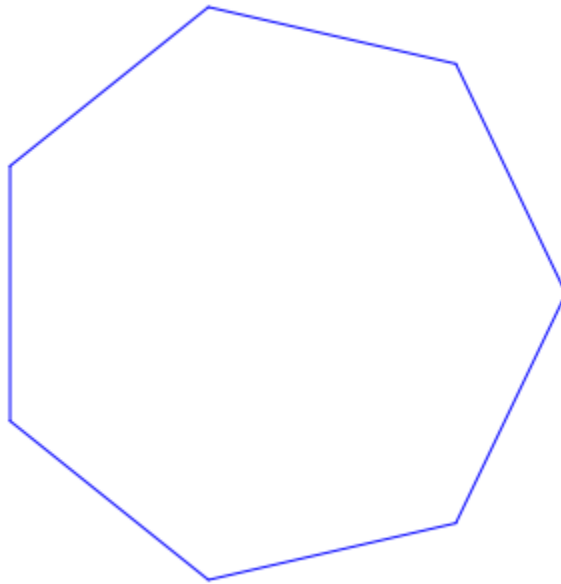

## Example 2

The distance to move may contain an animation parameter:

```
plot(plot::Turtle([Forward(1+a), Right(PI/2),  
                  Forward(1-2*a), Right(PI/2),  
                  Forward(1+3*a), Right(PI/2),  
                  Forward(1-4*a), Right(PI/2),  
                  Forward(1+5*a)], a=0..2))
```

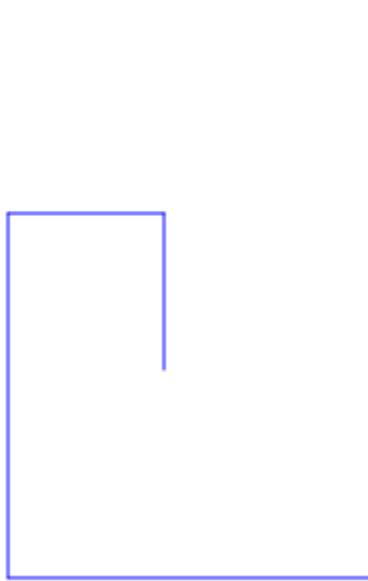

Likewise, the angle can be animated:

```
plot(plot::Turtle([(Forward(1), Right(a))$10],  
a = 0.25..2.5))
```



### Example 3

It is also possible to successively append commands to the list:

```
t := plot::Turtle()
```

```
plot::Turtle([])
```

```
t::forward(1)
```

```
plot::Turtle([Forward(1)])
```

```
for i from 1 to 9 do  
  t::left(3*PI/5);  
  t::forward(1);  
end_for
```

```
plot::Turtle([Forward(1), Left((3*PI)/...5), Forward(1)])
```

```
plot(t)
```

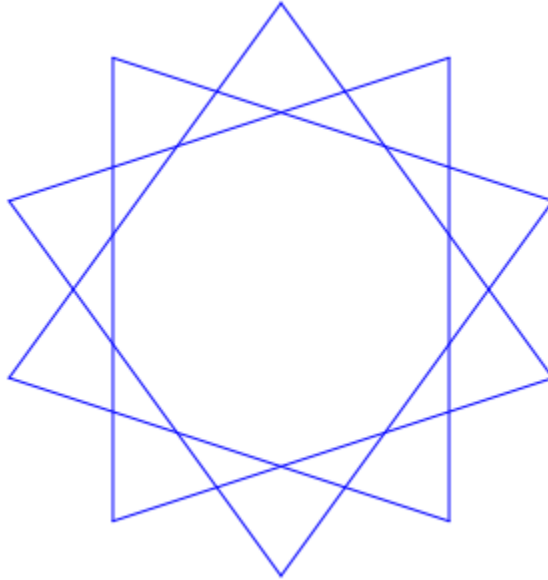

### Example 4

As an extension to the original turtle model, the line color may be changed while plotting:

```
t := plot::Turtle():
t::setLineColor(RGB::Red):
t::forward(1):
p := float(PI/5):
for i from 1 to 9 do
  t::left(108*PI/180);
  t::setLineColor([cos(i*p), sin(i*p), 0.0]);
  t::forward(1);
end_for;
```

```
plot::Turtle([LineColor([1.0, 0.0, 0.0...]), Forward(1)])
```

```
plot(t)
```

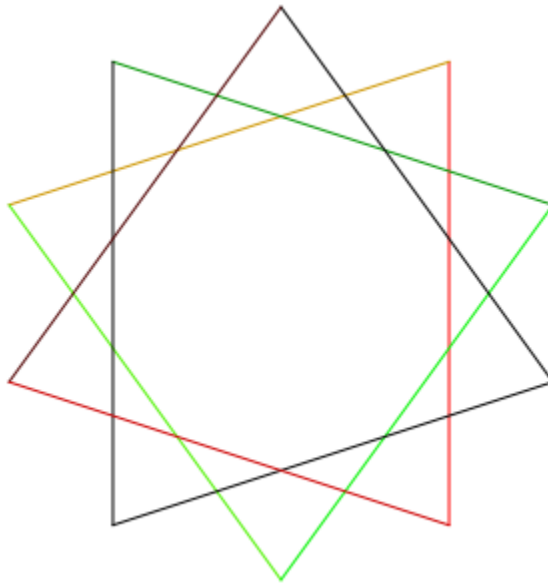

Note that the color within one line segment is constant.

### Example 5

Another extension to the turtle model is that `plot::Turtle` supports a stack of saved states, enabling the robot to return to previous positions:

```
t := plot::Turtle():
t::forward(5):
for i from -3 to 4 do
  t::push();
  t::left(PI/18*i);
  t::forward(3);
  t::pop();
end_for:
plot(t)
```

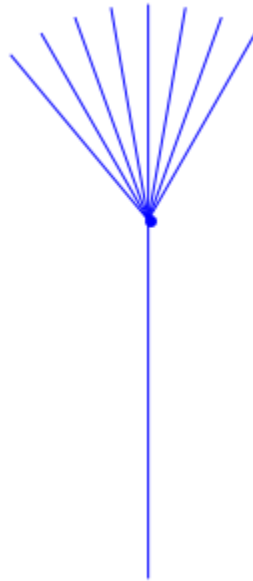

## Example 6

Using small steps, it is possible to create appealing curves with `plot::Turtle`:

```
t := plot::Turtle(LineColor = RGB::Green):
t::forward(2):
for dir in [-1, 1] do
  t::push():
  t::left(dir*PI/30):
  for i from 1 to 10 do
    t::forward(0.2):
    t::left(dir*PI/30):
  end_for:
  t::left(dir*2/3*PI):
  for i from 1 to 10 do
    t::forward(0.2):
    t::left(dir*PI/30):
  end_for:
  t::pop()
end_for:
t::forward(3):
t::setLineColor(RGB::Red):
```



```
for dir from -5 to 5 do
  t::push();
  t::left(dir*2*PI/11);
  for i from 1 to 10 do
    t::forward(0.1);
    t::left(PI/30);
  end_for;
  t::left(2*PI/3);
  for i from 1 to 10 do
    t::forward(0.1);
    t::left(PI/30);
  end_for;
  t::pop()
end_for:
plot(t)
```



## Parameters

### commands

A list of commands. See below for command definitions.

commands is equivalent to the attribute `CommandList`.

**a**

Animation parameter, specified as  $\mathbf{a} = \mathbf{a}_{\min} \dots \mathbf{a}_{\max}$ , where  $\mathbf{a}_{\min}$  is the initial parameter value, and  $\mathbf{a}_{\max}$  is the final parameter value.

## See Also

### **MuPAD Functions**

`plot` | `plot::copy`

### **MuPAD Graphical Primitives**

`plot::Lsys`

# plot::VectorField2d

2D vector field

## Syntax

```
plot::VectorField2d([v1, v2], x = xmin .. xmax, y = ymin .. ymax, <a = amin .. amax>, options)
```

```
plot::VectorField2d(v1, v2, x = xmin .. xmax, y = ymin .. ymax, <a = amin .. amax>, options)
```

## Description

`plot::VectorField2d([v1, v2], x = `x_{min}` .. `x_{max}`, y = `y_{min}` .. `y_{max}`)` represents a plot of the vector field defined by

$(x, y) \rightarrow (v_1(x, y), v_2(x, y))$  with  $(x, y) \in [x_{min}, x_{max}] \times [y_{min}, y_{max}]$ .

A vector field is defined by a function  $f: \mathbb{R}^2 \rightarrow \mathbb{R}^2$ . `plot::VectorField2d` displays a vector field by placing arrows at regular intervals with the arrow at  $(x, y)$  pointing in direction  $f(x, y)$ .

The length of the arrows depend on  $|f(x, y)|$  and the setting of the attribute `ArrowLength`: By default, arrow lengths are proportional to the magnitude of  $f$ , but can be set to be of fixed length or to scale logarithmically.

The density of arrows placed can be controlled with the attributes `XMesh`, `YMesh`, and `Mesh`. See the examples below.

## Attributes

Attribute	Purpose	Default Value
<code>AffectViewingBox</code>	influence of objects on the <code>ViewingBox</code> of a scene	TRUE
<code>AntiAliased</code>	antialiased lines and points?	TRUE

<b>Attribute</b>	<b>Purpose</b>	<b>Default Value</b>
ArrowLength	scaling of arrows in a vector field	Proportional
Color	the main color	RGB::Blue
Frames	the number of frames in an animation	50
Legend	makes a legend entry	
LegendText	short explanatory text for legend	
LegendEntry	add this object to the legend?	FALSE
LineColor	color of lines	RGB::Blue
LineWidth	width of lines	0.35
LineColor2	color of lines	RGB::DeepPink
LineColorType	line coloring types	Flat
LineColorFunction	functional line coloring	
LineColorDirection	the direction of color transitions on lines	[0, 1]
LineColorDirectionX	x-component of the direction of color transitions on lines	0
LineColorDirectionY	y-component of the direction of color transitions on lines	1
Mesh	number of sample points	[11, 11]
Name	the name of a plot object (for browser and legend)	
ParameterEnd	end value of the animation parameter	
ParameterName	name of the animation parameter	
ParameterBegin	initial value of the animation parameter	

<b>Attribute</b>	<b>Purpose</b>	<b>Default Value</b>
ParameterRange	range of the animation parameter	
TimeEnd	end time of the animation	10.0
TimeBegin	start time of the animation	0.0
TimeRange	the real time span of an animation	0.0 .. 10.0
TipAngle	opening angle of arrow heads	0.6283185307
TipStyle	presentation style of arrow heads	Open
TipLength	length of arrow heads	1.5
Title	object title	
TitleFont	font of object titles	[" sans-serif ", 11]
TitlePosition	position of object titles	
TitleAlignment	horizontal alignment of titles w.r.t. their coordinates	Center
TitlePositionX	position of object titles, x component	
TitlePositionY	position of object titles, y component	
Visible	visibility	TRUE
VisibleAfter	object visible after this time value	
VisibleBefore	object visible until this time value	
VisibleFromTo	object visible during this time range	
VisibleAfterEnd	object visible after its animation time ended?	TRUE
VisibleBeforeBegin	object visible before its animation time starts?	TRUE

Attribute	Purpose	Default Value
XFunction	function for x values	
XMax	final value of parameter "x"	
XMesh	number of sample points for parameter "x"	11
XMin	initial value of parameter "x"	
XName	name of parameter "x"	
XRange	range of parameter "x"	
YFunction	function for y values	
YMax	final value of parameter "y"	
YMesh	number of sample points for parameter "y"	11
YMin	initial value of parameter "y"	
YName	name of parameter "y"	
YRange	range of parameter "y"	

## Examples

### Example 1

We demonstrate a plot of the vector field  $v(x, y) = (1, \sin(x) + \cos(y))$ :

```
field := plot::VectorField2d([1, sin(x) + cos(y)],
                             x = 0..6, y = 0..2.5,
                             Mesh = [31, 26]):
```

It is the directional field associated with the ode  $y'(x) = \sin(x) + \cos(y)$ . We insert curves representing numerical solutions of this ode into this plot. We use `numeric::odesolve2` to compute the numerical solutions for the initial values  $y(0) = 0.4$ ,  $y(0.5) = 1.5$ , and  $y(1) = 1.2$ :

```
f := (x, y) -> [sin(x) + cos(y[1])]:
solution1 := numeric::odesolve2(f, 0, [0.4]):
```

```

curve1 := plot::Function2d(solution1(x)[1], x = 0 .. 6,
    LineColor = RGB::Blue):
solution2 := numeric::odesolve2(f, 0.5, [1.5]):
curve2 := plot::Function2d(solution2(x)[1], x = 0.5 .. 6,
    LineColor = RGB::Black):
solution3 := numeric::odesolve2(f, 1, [1.2]):
curve3 := plot::Function2d(solution3(x)[1], x = 1 .. 6,
    LineColor = RGB::GreenDark):

```

We plot the three objects in a single graphical scene:

```
plot(field, curve1, curve2, curve3, GridVisible = TRUE):
```

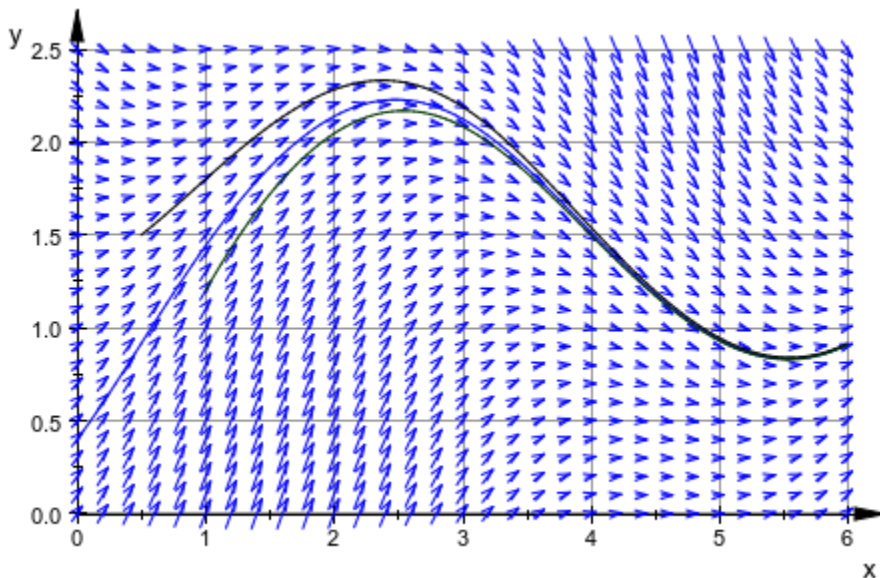

```
delete field, curve1, curve2, curve3:
```

## Example 2

Assume you want to plot an electrostatic potential field. The following routine generates the necessary formula in a format accepted by `plot::VectorField2d`:

```

potentialE :=
  proc(l)

```

```

    local p, x0, y0, f0, fx, fy, dist;
  begin
    fx := 0; fy := 0;
    for p in [args()] do
      [x0, y0, f0] := p;
      dist := sqrt((x-x0)^2 + (y-y0)^2);
      fx := fx + f0*(x-x0)/dist;
      fy := fy + f0*(y-y0)/dist;
    end_for;
    [fx, fy];
  end_proc;

  plot(plot::VectorField2d(potentialE([-1, -2, -1 ],
                                   [ 1,  3, 0.5],
                                   [ 2, -1, 0.5]),
                                   x = -3..3, y = -3..3,
                                   XMesh = 30, YMesh = 30)):

```

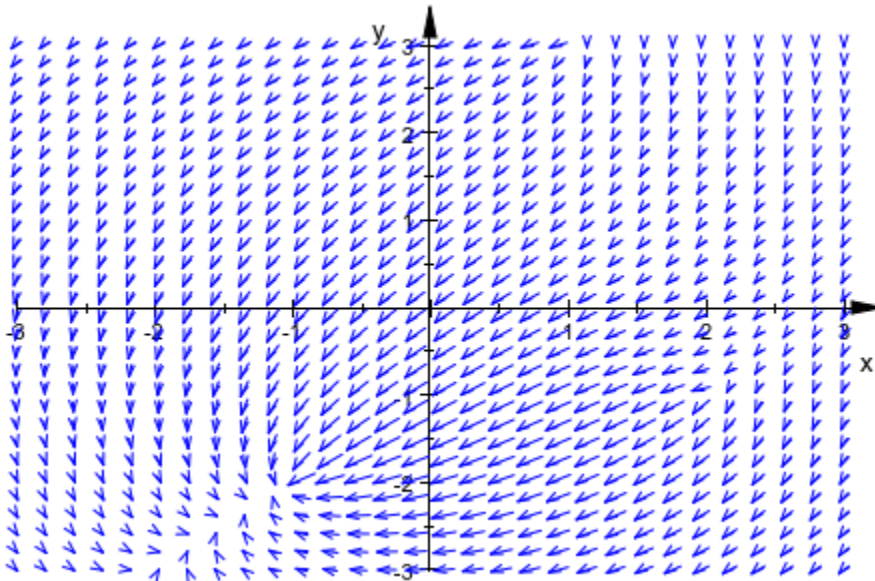

### Example 3

Like most other objects, `plot::VectorField2d` can be animated by supplying an extra parameter:



```

field := plot::VectorField2d([1, a*sin(x) + (a-1)*cos(y)],
                             x = 0..6, y = 0..2.5, a=-1..1):
text := plot::Text2d(a -> "a = ".stringlib::formatf(a, 2, 5), [2, -0.5],
                    a = -1..1, HorizontalAlignment = Left):
plot(field, text)

```

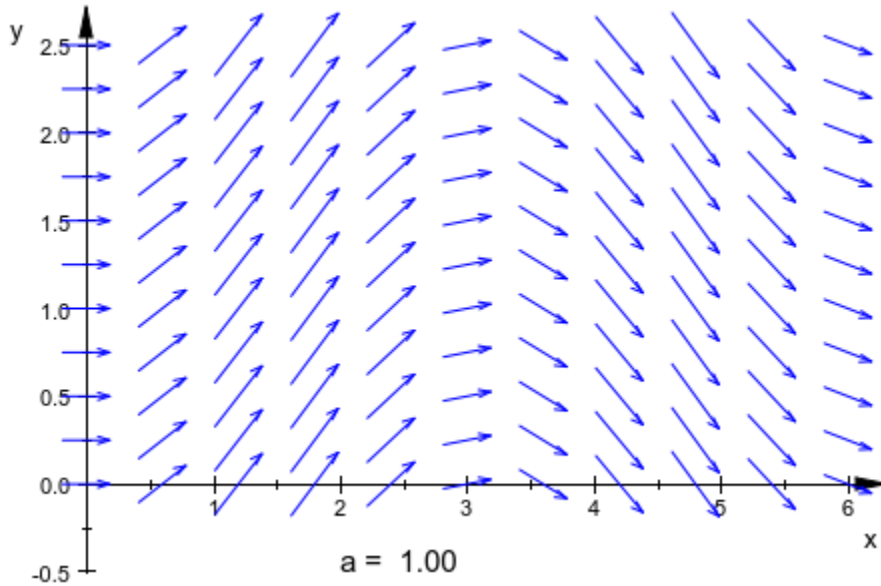

```
delete field, text:
```

## Parameters

**$v_1, v_2$**

The  $x$ - and  $y$ -component of the vector field: arithmetical expressions in  $x$ ,  $y$ , and, possibly, the animation parameter  $a$ .

$v_1, v_2$  are equivalent to the attributes `XFunction`, `YFunction`.

**$x, y$**

Identifiers.

$x, y$  are equivalent to the attributes  $XName, YName$ .

$x_{\min} \dots x_{\max}, y_{\min} \dots y_{\max}$

Real numerical values.

$x_{\min} \dots x_{\max}, y_{\min} \dots y_{\max}$  are equivalent to the attributes  $XRange, YRange, XMin, XMax, YMin, YMax$ .

**a**

Animation parameter, specified as  $a = a_{\min} \dots a_{\max}$ , where  $a_{\min}$  is the initial parameter value, and  $a_{\max}$  is the final parameter value.

## See Also

### MuPAD Functions

`plot` | `plot::copy`

### MuPAD Graphical Primitives

`plot::0de2d` | `plot::0de3d` | `plot::Streamlines2d` | `plot::VectorField3d`

# plot::VectorField3d

3D vector field

## Syntax

```
plot::VectorField3d([v_1, v_2, v_3], x = x_min .. x_max, y = y_min .. y_max, z = z_min .. z_max, <a = a
```

```
plot::VectorField3d(v_1, v_2, v_3, x = x_min .. x_max, y = y_min .. y_max, z = z_min .. z_max, <a = a_min
```

## Description

`plot::VectorField3d([v_1, v_2, v_3], x = `x_{min}` .. `x_{max}`, y = `y_{min}` .. `y_{max}`, z = `z_{min}` .. `z_{max}`)` represents a plot of the vector field defined by

$$(x, y, z) \rightarrow (v_1(x, y, z), v_2(x, y, z), v_3(x, y, z))$$

with  $(x, y, z) \in [x_{min}, x_{max}] \times [y_{min}, y_{max}] \times [z_{min}, z_{max}]$ .

A vector field is defined by a function  $f: \mathbb{R}^3 \rightarrow \mathbb{R}^3$ . `plot::VectorField3d` displays a vector field by placing arrows at regular intervals with the arrow at  $(x, y, z)$  pointing in the direction  $f(x, y, z)$ .

The length of the arrows depend on  $|f(x, y, z)|$  and the setting of the attribute `ArrowLength`: By default, arrow lengths are proportional to the magnitude of  $f$ , but can be set to be of fixed length or to scale logarithmically.

The density of arrows placed can be controlled with the attributes `XMesh`, `YMesh`, `ZMesh`, and `Mesh`. See the examples below.

## Attributes

Attribute	Purpose	Default Value
AffectViewingBox	influence of objects on the ViewingBox of a scene	TRUE
ArrowLength	scaling of arrows in a vector field	Proportional
Color	the main color	RGB::Blue
Frames	the number of frames in an animation	50
Legend	makes a legend entry	
LegendText	short explanatory text for legend	
LegendEntry	add this object to the legend?	FALSE
LineColor	color of lines	RGB::Blue
LineWidth	width of lines	0.1
LineColor2	color of lines	RGB::DeepPink
LineColorType	line coloring types	Flat
LineColorFunction	functional line coloring	
LineColorDirection	the direction of color transitions on lines	[0, 0, 1]
LineColorDirectionX	x-component of the direction of color transitions on lines	0
LineColorDirectionY	y-component of the direction of color transitions on lines	0
LineColorDirectionZ	z-component of the direction of color transitions on lines	1
Mesh	number of sample points	[7, 7, 7]
Name	the name of a plot object (for browser and legend)	

<b>Attribute</b>	<b>Purpose</b>	<b>Default Value</b>
ParameterEnd	end value of the animation parameter	
ParameterName	name of the animation parameter	
ParameterBegin	initial value of the animation parameter	
ParameterRange	range of the animation parameter	
PointSize	the size of points	1.5
PointStyle	the presentation style of points	FilledCircles
PointsVisible	visibility of mesh points	TRUE
TimeEnd	end time of the animation	10.0
TimeBegin	start time of the animation	0.0
TimeRange	the real time span of an animation	0.0 .. 10.0
Title	object title	
TitleFont	font of object titles	[" sans-serif ", 11]
TitlePosition	position of object titles	
TitleAlignment	horizontal alignment of titles w.r.t. their coordinates	Center
TitlePositionX	position of object titles, x component	
TitlePositionY	position of object titles, y component	
TitlePositionZ	position of object titles, z component	
Visible	visibility	TRUE
VisibleAfter	object visible after this time value	

<b>Attribute</b>	<b>Purpose</b>	<b>Default Value</b>
VisibleBefore	object visible until this time value	
VisibleFromTo	object visible during this time range	
VisibleAfterEnd	object visible after its animation time ended?	TRUE
VisibleBeforeBegin	object visible before its animation time starts?	TRUE
XFunction	function for x values	
XMax	final value of parameter "x"	
XMesh	number of sample points for parameter "x"	7
XMin	initial value of parameter "x"	
XName	name of parameter "x"	
XRange	range of parameter "x"	
YFunction	function for y values	
YMax	final value of parameter "y"	
YMesh	number of sample points for parameter "y"	7
YMin	initial value of parameter "y"	
YName	name of parameter "y"	
YRange	range of parameter "y"	
ZFunction	function for z values	
ZMax	final value of parameter "z"	
ZMesh	number of sample points for parameter "z"	7
ZMin	initial value of parameter "z"	

Attribute	Purpose	Default Value
ZName	name of parameter "z"	
ZRange	range of parameter "z"	

## Examples

### Example 1

We demonstrate a plot of the vector field  $v(x, y, z) = (1, \sin(x) + \cos(y), \sin(z))$ :

```
field := plot::VectorField3d([1, sin(x) + cos(y), sin(z)],
                             x = 0..6, y = 0..2.5, z = 0..5,
                             Mesh = [7, 7, 7]):
plot(field):
```

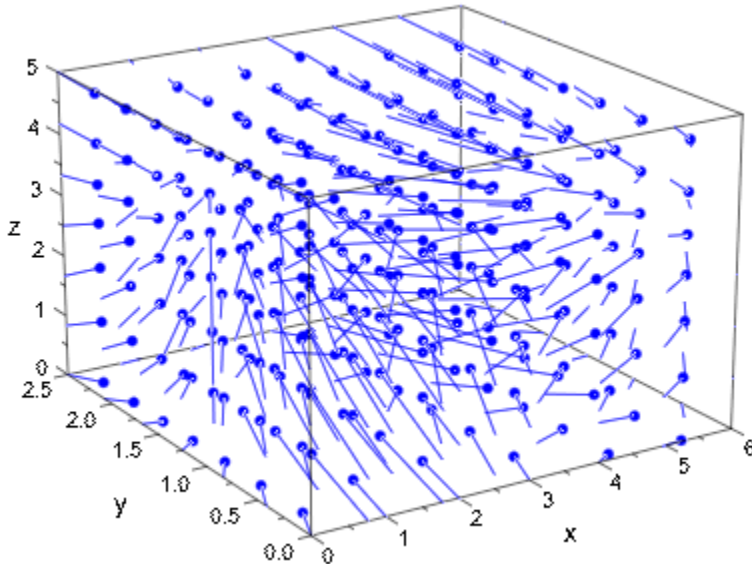

```
delete field:
```

## Example 2

Like most other objects, `plot::VectorField3d` can be animated by supplying an extra parameter:

```
mycolor := (x, y, z, vx, vy, vz, a) -> [a, a*z, 1 - a]:
field := plot::VectorField3d([ a*y + (1-a)*x ,
                              -a*x + (1-a)*y,
                              a*sin(PI*z)],
                             x = -1..1, y = -1..1, z = 0..1,
                             LineColorFunction = mycolor,
                             Mesh = [7, 7, 7], a = 0..1):
text := plot::Text3d(a -> "a = ".stringlib::formatf(a, 2, 5),
                    [1, 0.7, 1.2], a = 0..1):
plot(field, text, Axes = Frame)
```

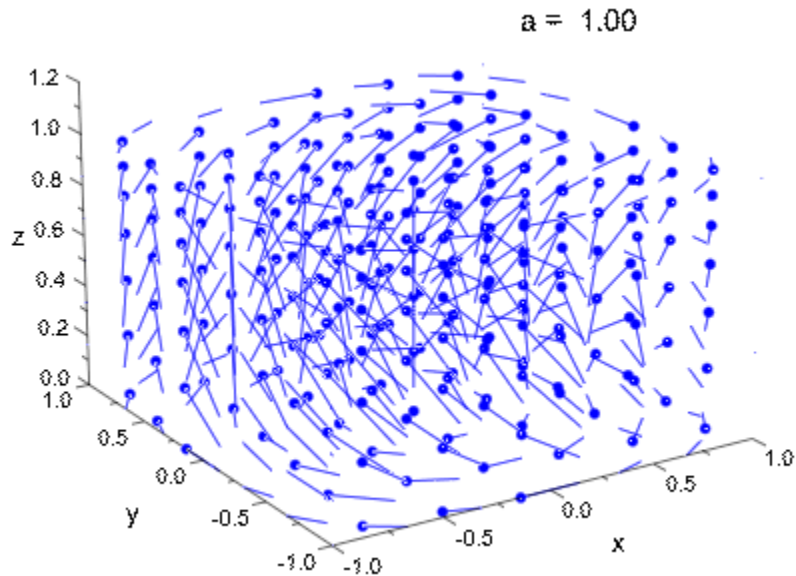

```
delete field, text:
```



## Parameters

**$v_1, v_2, v_3$**

The  $x$ -,  $y$ -, and  $z$ -component of the vector field: arithmetical expressions in  $x$ ,  $y$ ,  $z$  and, possibly, the animation parameter  $a$ .

$v_1, v_2, v_3$  are equivalent to the attributes XFunction, YFunction, ZFunction.

**$x, y, z$**

Identifiers.

$x, y, z$  are equivalent to the attributes XName, YName, ZName.

**$x_{\min} \dots x_{\max}, y_{\min} \dots y_{\max}, z_{\min} \dots z_{\max}$**

Real numerical values.

$x_{\min} \dots x_{\max}, y_{\min} \dots y_{\max}, z_{\min} \dots z_{\max}$  are equivalent to the attributes XRange, YRange, ZRange, XMin, XMax, YMin, YMax, ZMin, ZMax.

**$a$**

Animation parameter, specified as  $a = a_{\min} \dots a_{\max}$ , where  $a_{\min}$  is the initial parameter value, and  $a_{\max}$  is the final parameter value.

## See Also

### MuPAD Functions

plot | plot::copy

### MuPAD Graphical Primitives

plot::0de2d | plot::0de3d | plot::VectorField2d

## plot::Waterman

Waterman polyhedra

### Syntax

```
plot::Waterman(r, <a = amin .. amax>, options)
```

### Description

`plot::Waterman(r)` creates the Waterman polyhedron of radius  $r$ .

Waterman polyhedra, invented around 1990 by Steve Waterman, form a vast family of polyhedra. Some of them have a number of nice properties like multiple symmetries, or very interesting and regular shapes. Some other are just a bunch of faces formed out of irregular convex polygons.

Waterman polyhedra result from the examination of balls in face-centered cubic close packing (which is one of the two densest packings of equally sized balls in 3D space, according to the Kepler Conjecture, proofed by Hales and Ferguson, 1997-2005). A single

layer of spheres (of radius  $\frac{1}{\sqrt{2}}$ ) in this packing looks like this:

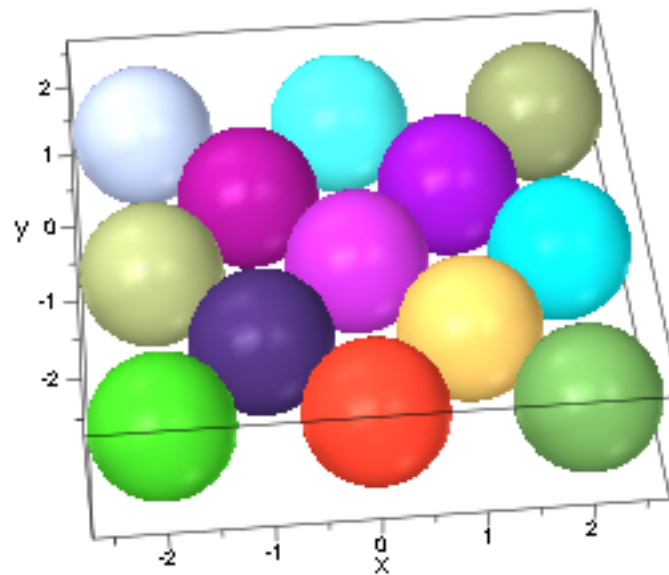

The close packing results from placing several of these layers over one another, shifted to optimally fill the gaps (in very much the same way your grocery store puts apples and oranges on display):

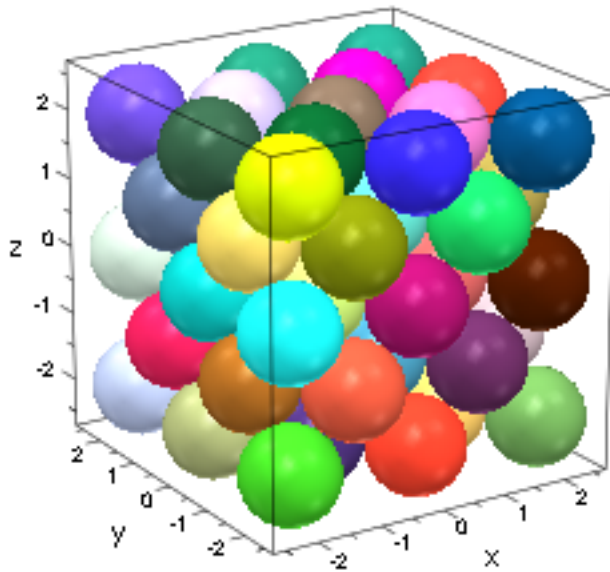

Given a radius  $r$  and a center  $c$  (which we let default to  $[0, 0, 0]$ ), now consider all those centers of spheres in this packing which fall into the sphere of radius  $r$  around  $c$ :

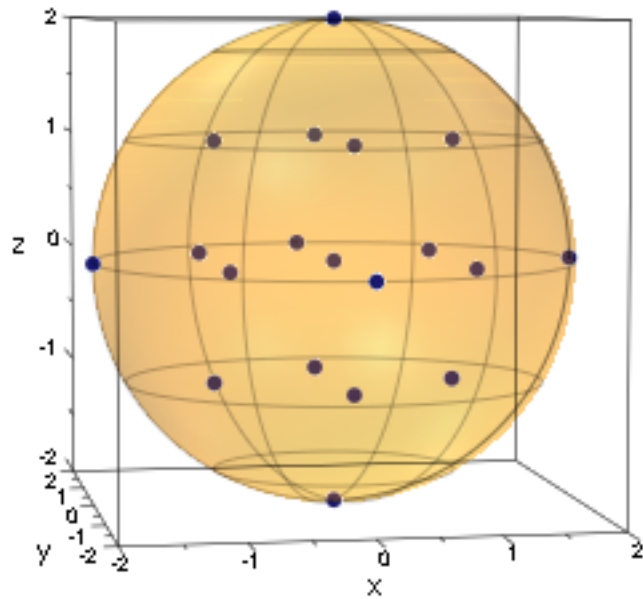

The convex hull of these points is the Waterman polyhedron of the given radius and center:

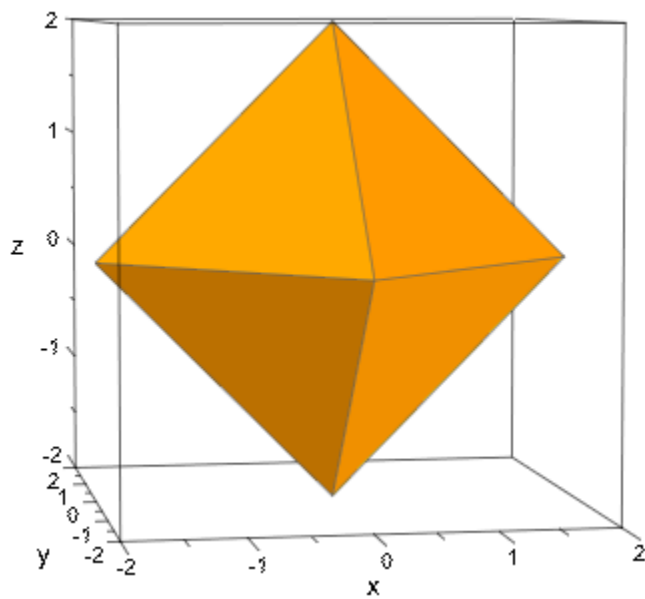
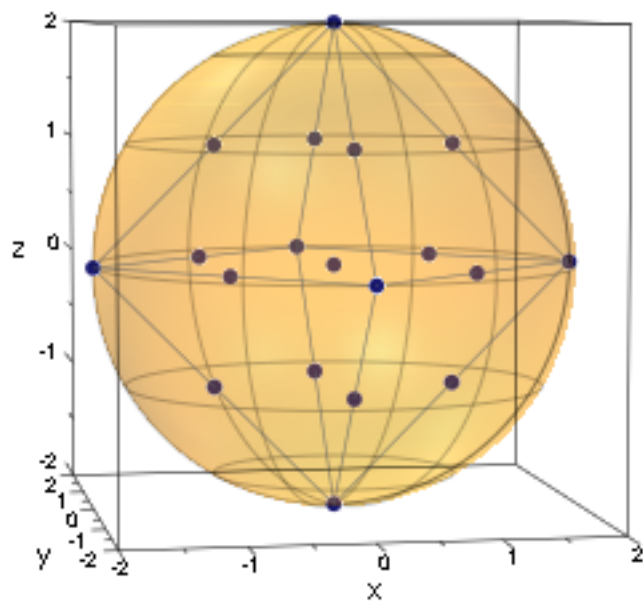

## Attributes

Attribute	Purpose	Default Value
AffectViewingBox	influence of objects on the ViewingBox of a scene	TRUE
Center	center of objects, rotation center	[0, 0, 0]
CenterX	center of objects, rotation center, x-component	0
CenterY	center of objects, rotation center, y-component	0
CenterZ	center of objects, rotation center, z-component	0
Color	the main color	RGB::SafetyOrange
Filled	filled or transparent areas and surfaces	TRUE
FillColor	color of areas and surfaces	RGB::SafetyOrange
FillColor2	second color of areas and surfaces for color blends	RGB::CornflowerBlue
FillColorType	surface filling types	Flat
FillColorFunction	functional area/surface coloring	
FillColorDirection	the direction of color transitions on surfaces	[0, 0, 1]
FillColorDirectionX	x-component of the direction of color transitions on surfaces	0
FillColorDirectionY	y-component of the direction of color transitions on surfaces	0
FillColorDirectionZ	z-component of the direction of color transitions on surfaces	1

<b>Attribute</b>	<b>Purpose</b>	<b>Default Value</b>
Frames	the number of frames in an animation	50
Legend	makes a legend entry	
LegendText	short explanatory text for legend	
LegendEntry	add this object to the legend?	FALSE
LineColor	color of lines	RGB::Grey40.[0.4]
LineWidth	width of lines	0.25
LineColor2	color of lines	RGB::DeepPink
LineStyle	solid, dashed or dotted lines?	Solid
LinesVisible	visibility of lines	TRUE
LineColorType	line coloring types	Flat
LineColorFunction	functional line coloring	
LineColorDirection	the direction of color transitions on lines	[0, 1, 1]
LineColorDirectionX	x-component of the direction of color transitions on lines	0
LineColorDirectionY	y-component of the direction of color transitions on lines	1
LineColorDirectionZ	z-component of the direction of color transitions on lines	1
Name	the name of a plot object (for browser and legend)	
ParameterEnd	end value of the animation parameter	
ParameterName	name of the animation parameter	
ParameterBegin	initial value of the animation parameter	



<b>Attribute</b>	<b>Purpose</b>	<b>Default Value</b>
ParameterRange	range of the animation parameter	
PointSize	the size of points	1.5
PointStyle	the presentation style of points	FilledCircles
PointsVisible	visibility of mesh points	FALSE
Radius	radius of circles, spheres etc.	
Shading	smooth color blend of surfaces	Smooth
TimeEnd	end time of the animation	10.0
TimeBegin	start time of the animation	0.0
TimeRange	the real time span of an animation	0.0 .. 10.0
Title	object title	
TitleFont	font of object titles	[" sans-serif ", 11]
TitlePosition	position of object titles	
TitleAlignment	horizontal alignment of titles w.r.t. their coordinates	Center
TitlePositionX	position of object titles, x component	
TitlePositionY	position of object titles, y component	
TitlePositionZ	position of object titles, z component	
Visible	visibility	TRUE
VisibleAfter	object visible after this time value	
VisibleBefore	object visible until this time value	

Attribute	Purpose	Default Value
VisibleFromTo	object visible during this time range	
VisibleAfterEnd	object visible after its animation time ended?	TRUE
VisibleBeforeBegin	object visible before its animation time starts?	TRUE

## Examples

### Example 1

With increasing radius, Waterman polyhedra get ever closer to spheres:

```
plot(plot::Waterman(r, r=0..10,  
    PointsVisible, PointSize=1,  
    LineColor=RGB::Black,  
    Color=RGB::Red.[0.75]),  
plot::Sphere(r, [0,0,0], r=0..10,  
    Color=RGB::Yellow.[0.3]),  
CameraDirection=[2,10,1])
```

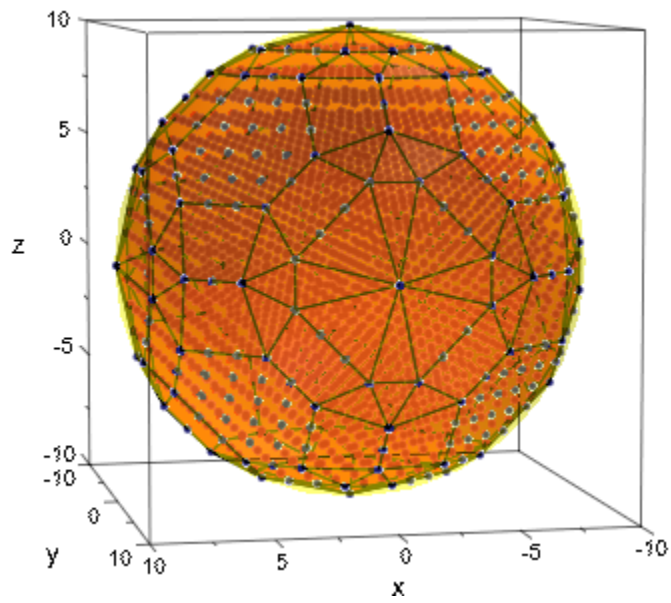

## Example 2

Waterman polyhedra have a rather general definition and can be made from spheres centered anywhere:

```
plot(plot::Waterman(5, Center=[0,0,0]))
```

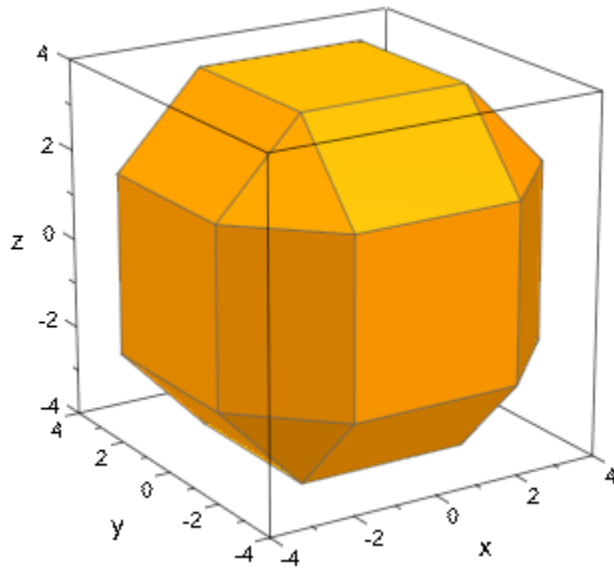

```
plot(plot::Waterman(5, Center=[0,0,1]))
```

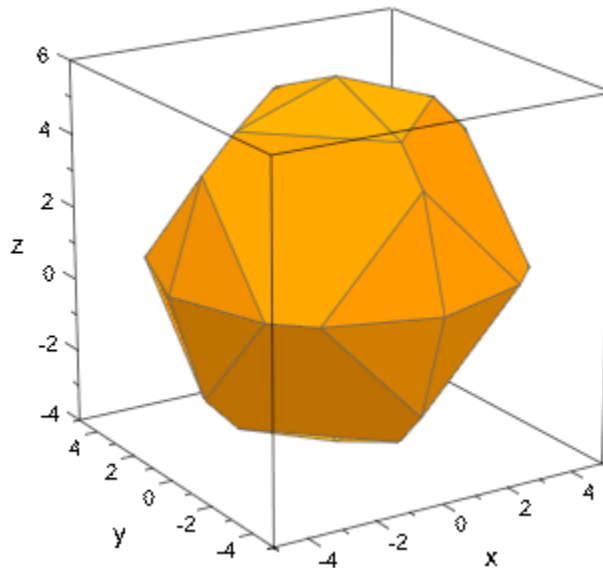

To translate or scale a Waterman polyhedron, use `plot::Translate3d` and `plot::Scale3d`:

```
n := 3:
r := i -> 3/2+sqrt(i+1):
plot(plot::Translate3d([i mod n, i div n, 0],
    plot::Scale3d([1/(3*r(i)) $ 3],
        plot::Waterman(r(i), Color=RGB::random()))))
$ i = 0..n^2-1, Axes=None)
```

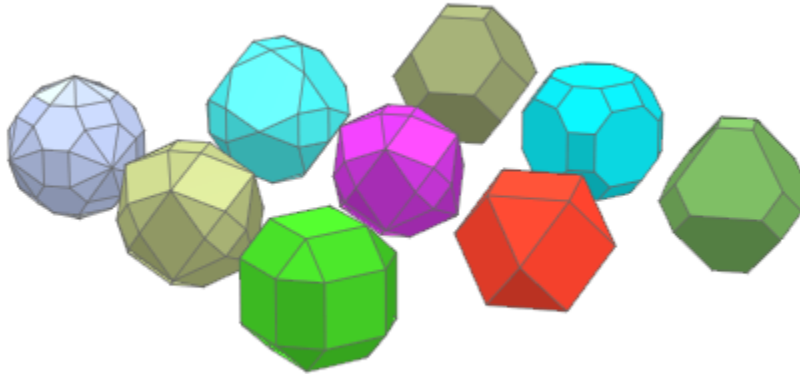

### Example 3

As usual, many attributes can be animated, although by the nature of Waterman polyhedra, the resulting animation will not be smooth:

```
plot(plot::Waterman(5, Center=[a/PI, cos(a), 0],  
      a=0..2*PI),  
      AnimationStyle=BackAndForth, CameraDirection=[0,0.1,1])
```

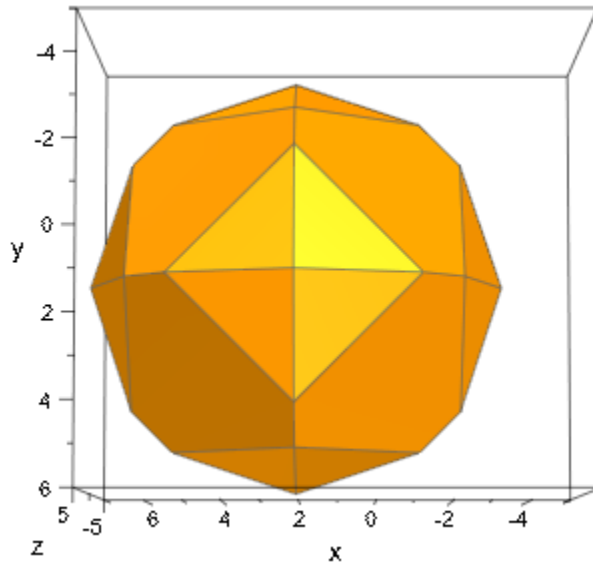

### Example 4

The `LineColorFunction` and `FillColorFunction` attributes can be set to functions which get indices of the currently painted surfacepolygon and its current vertex as fourth and fifth argument, respectively. This allows to color the polygons individually:

```
colors := [RGB::random() $ i = 1..42]:
plot(plot::Waterman(5, FillColorFunction=((x,y,z,i) -> colors[i])))
```

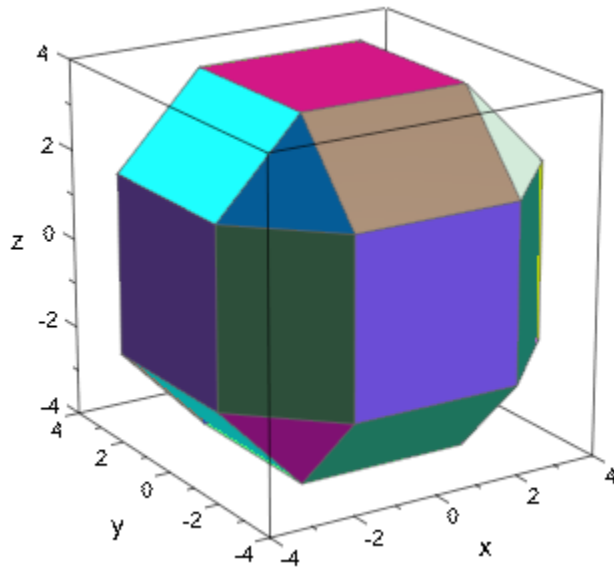

Another way of getting random colors which remain constant for each polygon is to use a procedure with option `remember`:

```
col :=  
proc(n)  
  option remember;  
begin  
  RGB::fromHSV([360*frandom(), 1, 1]);  
end;  
plot(plot::Waterman(7, FillColorFunction=((x,y,z,i) -> col(i))))
```



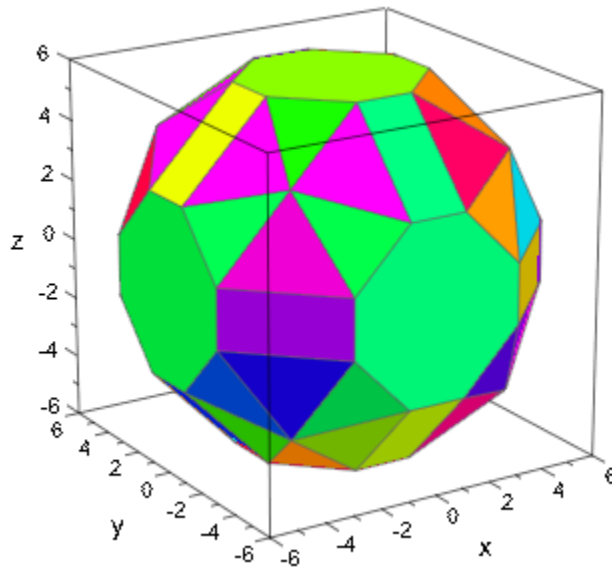

## Parameters

**r**

An arithmetical expression: the radius of the polyhedron (see below for details).

r is equivalent to the attribute `Radius`.

**a**

Animation parameter, specified as  $a = a_{\min}..a_{\max}$ , where  $a_{\min}$  is the initial parameter value, and  $a_{\max}$  is the final parameter value.

## Algorithms

`plot::Waterman` uses `plot::hull` (and therefore, the Geometry Centre's `qhull` code) to compute the convex hull of the coordinates. Most of the remaining code has been contributed by Mirek Majewski.

## See Also

### **MuPAD Functions**

`plot`

### **MuPAD Graphical Primitives**

`plot::Dodecahedron` | `plot::Hexahedron` | `plot::Icosahedron` |  
`plot::Octahedron` | `plot::Sphere` | `plot::Tetrahedron`

# plot::XRotate

Surfaces of revolution around x-axis

## Syntax

```
plot::XRotate(f, x = x_min .. x_max, <a = a_min .. a_max>, options)
```

## Description

`plot::XRotate(f, x = x_min .. x_max)` creates a surface of revolution by rotating the function graph  $y = f(x)$  with  $x \in [x_{\min}, x_{\max}]$  around the  $x$ -axis. The slice of the surface parallel to the  $y$ - $z$  plane at a point  $x$  is a circle of radius  $f(x)$ .

The range of the rotation can be restricted with the attributes `AngleBegin`, `AngleEnd`, `AngleRange`. The surface of revolution spans over the given range of the rotation angle.

Surfaces of revolution are parametrized surfaces on page 24-803. The first surface parameter is  $x$ , the second is the rotation angle. Surfaces of revolution react to most of the graphical attributes that surfaces of type `plot::Surface` react to. For example, use `Mesh` and `Submesh` to control the numerical mesh or use `ULinesVisible` and `VLinesVisible` to enable or disable the parameter lines.

## Attributes

Attribute	Purpose	Default Value
<code>AdaptiveMesh</code>	adaptive sampling	0
<code>AffectViewingBox</code>	influence of objects on the <code>ViewingBox</code> of a scene	TRUE
<code>AngleEnd</code>	end of angle range	2*PI
<code>AngleBegin</code>	begin of angle range	0
<code>AngleRange</code>	angle range	0 .. 2*PI

<b>Attribute</b>	<b>Purpose</b>	<b>Default Value</b>
Color	the main color	RGB::Red
Filled	filled or transparent areas and surfaces	TRUE
FillColor	color of areas and surfaces	RGB::Red
FillColor2	second color of areas and surfaces for color blends	RGB::CornflowerBlue
FillColorType	surface filling types	Dichromatic
FillColorFunction	functional area/surface coloring	
FillColorDirection	the direction of color transitions on surfaces	[0, 0, 1]
FillColorDirectionX	x-component of the direction of color transitions on surfaces	0
FillColorDirectionY	y-component of the direction of color transitions on surfaces	0
FillColorDirectionZ	z-component of the direction of color transitions on surfaces	1
Frames	the number of frames in an animation	50
Function	function expression or procedure	
Legend	makes a legend entry	
LegendText	short explanatory text for legend	
LegendEntry	add this object to the legend?	TRUE
LineColor	color of lines	RGB::Black.[0.25]
LineWidth	width of lines	0.35
LineColor2	color of lines	RGB::DeepPink

Attribute	Purpose	Default Value
LineStyle	solid, dashed or dotted lines?	Solid
LineColorType	line coloring types	Flat
LineColorFunction	functional line coloring	
LineColorDirection	the direction of color transitions on lines	[0, 0, 1]
LineColorDirectionX	x-component of the direction of color transitions on lines	0
LineColorDirectionY	y-component of the direction of color transitions on lines	0
LineColorDirectionZ	z-component of the direction of color transitions on lines	1
Mesh	number of sample points	[25, 25]
MeshVisible	visibility of irregular mesh lines in 3D	FALSE
Name	the name of a plot object (for browser and legend)	
ParameterEnd	end value of the animation parameter	
ParameterName	name of the animation parameter	
ParameterBegin	initial value of the animation parameter	
ParameterRange	range of the animation parameter	
PointSize	the size of points	1.5
PointStyle	the presentation style of points	FilledCircles
PointsVisible	visibility of mesh points	FALSE
Shading	smooth color blend of surfaces	Smooth

<b>Attribute</b>	<b>Purpose</b>	<b>Default Value</b>
Submesh	density of submesh (additional sample points)	[0, 0]
TimeEnd	end time of the animation	10.0
TimeBegin	start time of the animation	0.0
TimeRange	the real time span of an animation	0.0 .. 10.0
Title	object title	
TitleFont	font of object titles	[" sans-serif ", 11]
TitlePosition	position of object titles	
TitleAlignment	horizontal alignment of titles w.r.t. their coordinates	Center
TitlePositionX	position of object titles, x component	
TitlePositionY	position of object titles, y component	
TitlePositionZ	position of object titles, z component	
ULinesVisible	visibility of parameter lines (u lines)	TRUE
UMesh	number of sample points for parameter "u"	25
USubmesh	density of additional sample points for parameter "u"	0
VLinesVisible	visibility of parameter lines (v lines)	TRUE
VMesh	number of sample points for parameter "v"	25
VSubmesh	density of additional sample points for parameter "v"	0
Visible	visibility	TRUE

Attribute	Purpose	Default Value
VisibleAfter	object visible after this time value	
VisibleBefore	object visible until this time value	
VisibleFromTo	object visible during this time range	
VisibleAfterEnd	object visible after its animation time ended?	TRUE
VisibleBeforeBegin	object visible before its animation time starts?	TRUE
XContours	contour lines at constant x values	[]
XMax	final value of parameter "x"	5
XMin	initial value of parameter "x"	-5
XName	name of parameter "x"	
XRange	range of parameter "x"	-5 .. 5
YContours	contour lines at constant y values	[]
ZContours	contour lines at constant z values	[]

## Examples

### Example 1

By default, `plot::XRotate` displays a complete revolution, just as if an object was created on a lathe:

```
plot(plot::XRotate(2 - sin(x), x = 0..2*PI))
```

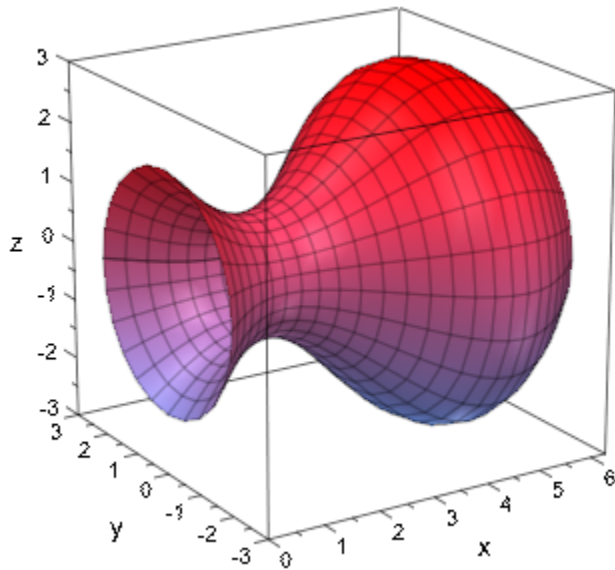

This rotation is insensitive to negative values. The surfaces of revolution of  $f(x)$  and  $|f(x)|$  are identical:

```
plot(plot::Scene3d(plot::XRotate(sin(x), x = 0..2*PI)),  
      plot::Scene3d(plot::XRotate(abs(sin(x)), x = 0..2*PI)),  
      Layout = Horizontal)
```



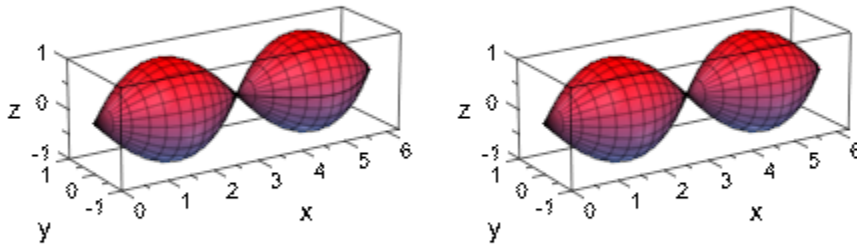

This symmetry is broken when not performing a whole revolution:

```
plot(plot::Scene3d(plot::XRotate(sin(x), x = 0..2*PI,  
                                AngleRange = -PI/2..PI/2)),  
      plot::Scene3d(plot::XRotate(abs(sin(x)), x = 0..2*PI,  
                                AngleRange = -PI/2..PI/2)),  
      Layout = Horizontal)
```

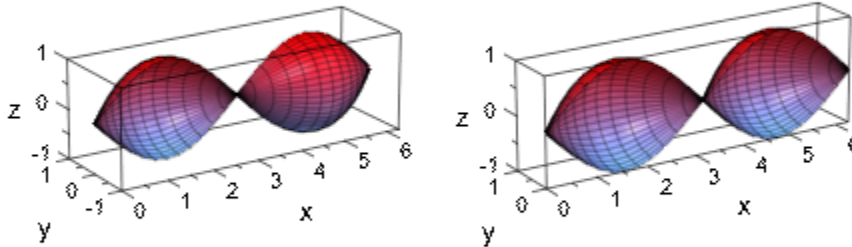

`plot::XRotate` can be animated, like almost every plot object:

```
plot(plot::XRotate(sin(x + a), x = 0 .. 2*a + PI,  
    AngleRange = 0 .. PI + a/2,  
    a = 0..2*PI))
```

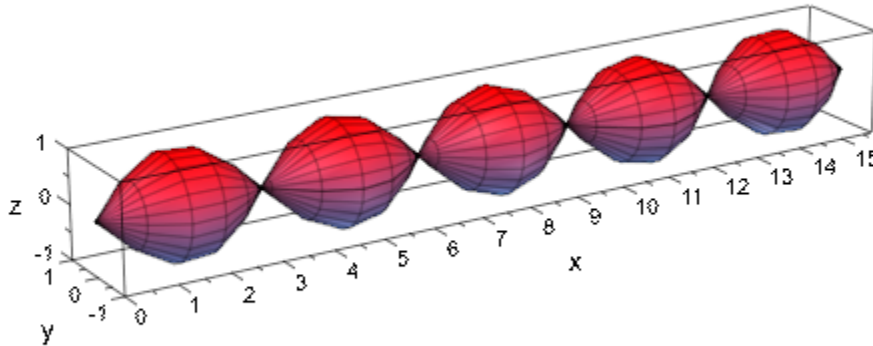

## Parameters

### f

The function: an arithmetical expression (Symbolic Math Toolbox) or a `piecewise` object in the independent variable  $x$  and the animation parameter  $a$ . Alternatively, a procedure on page 1-1654 that accepts 1 input parameter  $x$  or 2 input parameters  $x$ ,  $a$  and returns a real numerical value when the input parameters are numerical.

$f$  is equivalent to the attribute `Function`.

### x

The independent variable: an identifier on page 7-29 or an indexed identifier on page 1-1017.

$x$  is equivalent to the attribute `XName`.

$x_{\min} \dots x_{\max}$

The plot range:  $x_{\min}$ ,  $x_{\max}$  must be numerical real values or expressions of the animation parameter  $a$ .

$x_{\min} \dots x_{\max}$  is equivalent to the attributes `XRange`, `XMin`, `XMax`.

**a**

Animation parameter, specified as  $a = a_{\min} \dots a_{\max}$ , where  $a_{\min}$  is the initial parameter value, and  $a_{\max}$  is the final parameter value.

## See Also

### MuPAD Functions

`plot` | `plot::copy`

### MuPAD Graphical Primitives

`plot::Function2d` | `plot::Function3d` | `plot::Surface` | `plot::ZRotate`

# plot::ZRotate

Surfaces of revolution around z-axis

## Syntax

```
plot::ZRotate(f, x = xmin .. xmax, <a = amin .. amax>, options)
```

## Description

`plot::ZRotate(f, x = xmin .. xmax)` creates a surface of revolution by rotating the function graph  $z = f(x)$  with  $x \in [x_{\min}, x_{\max}]$  around the z-axis. The slice of the surface parallel to the x-y plane at a point  $z$  consists of circles with radii  $|x_i|$  given by the solutions of  $f(x) = z$ .

The range of the rotation can be restricted with the attributes `AngleBegin`, `AngleEnd`, `AngleRange`. The surface of revolution spans over the given range of the rotation angle.

Surfaces of revolution are parametrized surfaces on page 24-803. The first surface parameter is  $x$ , the second is the rotation angle. Surfaces of revolution react to most of the graphical attributes that surfaces of type `plot::Surface` react to. For example, use `Mesh` and `Submesh` to control the numerical mesh or use `ULinesVisible` and `VLinesVisible` to enable or disable the parameter lines.

## Attributes

Attribute	Purpose	Default Value
<code>AdaptiveMesh</code>	adaptive sampling	0
<code>AffectViewingBox</code>	influence of objects on the <code>ViewingBox</code> of a scene	TRUE
<code>AngleEnd</code>	end of angle range	2*PI
<code>AngleBegin</code>	begin of angle range	0
<code>AngleRange</code>	angle range	0 .. 2*PI

<b>Attribute</b>	<b>Purpose</b>	<b>Default Value</b>
Color	the main color	RGB::Red
Filled	filled or transparent areas and surfaces	TRUE
FillColor	color of areas and surfaces	RGB::Red
FillColor2	second color of areas and surfaces for color blends	RGB::CornflowerBlue
FillColorType	surface filling types	Dichromatic
FillColorFunction	functional area/surface coloring	
FillColorDirection	the direction of color transitions on surfaces	[0, 0, 1]
FillColorDirectionX	x-component of the direction of color transitions on surfaces	0
FillColorDirectionY	y-component of the direction of color transitions on surfaces	0
FillColorDirectionZ	z-component of the direction of color transitions on surfaces	1
Frames	the number of frames in an animation	50
Function	function expression or procedure	
Legend	makes a legend entry	
LegendText	short explanatory text for legend	
LegendEntry	add this object to the legend?	TRUE
LineColor	color of lines	RGB::Black.[0.25]
LineWidth	width of lines	0.35
LineColor2	color of lines	RGB::DeepPink

Attribute	Purpose	Default Value
LineStyle	solid, dashed or dotted lines?	Solid
LineColorType	line coloring types	Flat
LineColorFunction	functional line coloring	
LineColorDirection	the direction of color transitions on lines	[0, 0, 1]
LineColorDirectionX	x-component of the direction of color transitions on lines	0
LineColorDirectionY	y-component of the direction of color transitions on lines	0
LineColorDirectionZ	z-component of the direction of color transitions on lines	1
Mesh	number of sample points	[25, 25]
MeshVisible	visibility of irregular mesh lines in 3D	FALSE
Name	the name of a plot object (for browser and legend)	
ParameterEnd	end value of the animation parameter	
ParameterName	name of the animation parameter	
ParameterBegin	initial value of the animation parameter	
ParameterRange	range of the animation parameter	
PointSize	the size of points	1.5
PointStyle	the presentation style of points	FilledCircles
PointsVisible	visibility of mesh points	FALSE
Shading	smooth color blend of surfaces	Smooth

Attribute	Purpose	Default Value
Submesh	density of submesh (additional sample points)	[0, 0]
TimeEnd	end time of the animation	10.0
TimeBegin	start time of the animation	0.0
TimeRange	the real time span of an animation	0.0 .. 10.0
Title	object title	
TitleFont	font of object titles	[" sans-serif ", 11]
TitlePosition	position of object titles	
TitleAlignment	horizontal alignment of titles w.r.t. their coordinates	Center
TitlePositionX	position of object titles, x component	
TitlePositionY	position of object titles, y component	
TitlePositionZ	position of object titles, z component	
ULinesVisible	visibility of parameter lines (u lines)	TRUE
UMesh	number of sample points for parameter "u"	25
USubmesh	density of additional sample points for parameter "u"	0
VLinesVisible	visibility of parameter lines (v lines)	TRUE
VMesh	number of sample points for parameter "v"	25
VSubmesh	density of additional sample points for parameter "v"	0
Visible	visibility	TRUE



Attribute	Purpose	Default Value
VisibleAfter	object visible after this time value	
VisibleBefore	object visible until this time value	
VisibleFromTo	object visible during this time range	
VisibleAfterEnd	object visible after its animation time ended?	TRUE
VisibleBeforeBegin	object visible before its animation time starts?	TRUE
XContours	contour lines at constant x values	[]
XMax	final value of parameter "x"	5
XMin	initial value of parameter "x"	0
XName	name of parameter "x"	
XRange	range of parameter "x"	0 .. 5
YContours	contour lines at constant y values	[]
ZContours	contour lines at constant z values	[]

## Examples

### Example 1

For `plot::ZRotate`, the symmetry for a whole revolution is with respect to the x values:

```
plot(plot::Scene3d(plot::ZRotate(exp(x), x = -1..1)),
      plot::Scene3d(plot::ZRotate(exp(-x), x = -1..1)),
      Layout = Horizontal)
```

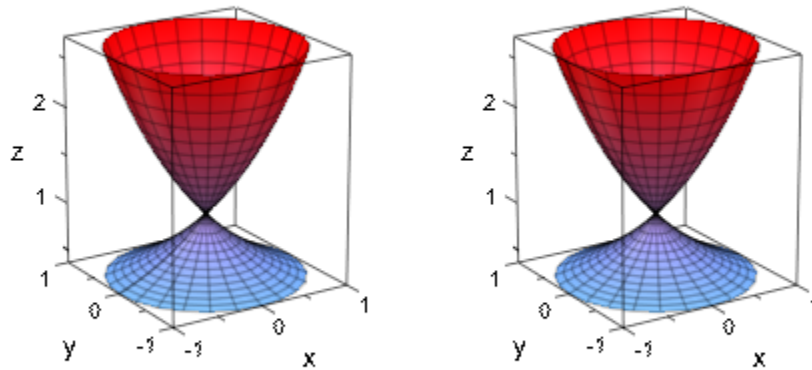

```
plot(plot::Scene3d(plot::ZRotate(exp(x), x = -1..1,  
    AngleRange = -a..a,  
    a = 0..PI)),  
plot::Scene3d(plot::ZRotate(exp(-x), x = -1..1,  
    AngleRange = -a..a,  
    a = 0..PI)),  
Layout = Horizontal)
```

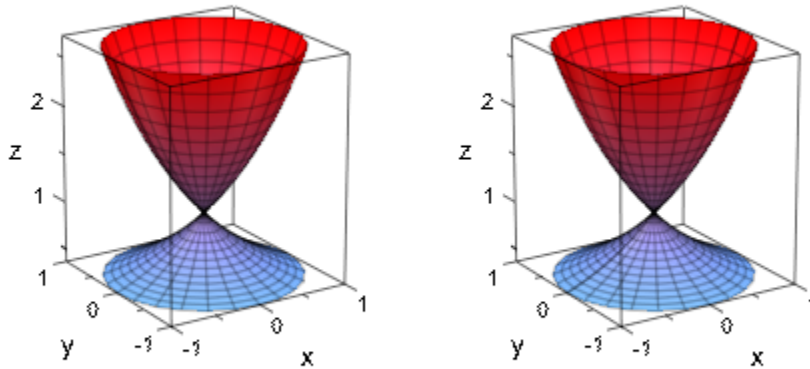

## Parameters

### f

The function: an arithmetical expression (Symbolic Math Toolbox) or a `piecewise` object in the independent variable  $x$  and the animation parameter  $a$ . Alternatively, a procedure on page 1-1654 that accepts 1 input parameter  $x$  or 2 input parameters  $x, a$  and returns a real numerical value when the input parameters are numerical.

`f` is equivalent to the attribute `Function`.

### x

The independent variable: an identifier on page 7-29 or an indexed identifier on page 1-1017.

`x` is equivalent to the attribute `XName`.

$x_{\min} \dots x_{\max}$

The plot range:  $x_{\min}$ ,  $x_{\max}$  must be numerical real values or expressions of the animation parameter  $a$ .

$x_{\min} \dots x_{\max}$  is equivalent to the attributes `XRange`, `XMin`, `XMax`.

**a**

Animation parameter, specified as  $a = a_{\min} \dots a_{\max}$ , where  $a_{\min}$  is the initial parameter value, and  $a_{\max}$  is the final parameter value.

## See Also

### MuPAD Functions

`plot` | `plot::copy`

### MuPAD Graphical Primitives

`plot::Function2d` | `plot::Function3d` | `plot::Surface` | `plot::XRotate`

# plot::Canvas

Drawing area

## Syntax

```
plot::Canvas(object1, object2, ..., <a = amin .. amax>, options)
```

## Description

`plot::Canvas` is the top level element of the hierarchy of graphical objects. It represents the 2 dimensional drawing area into which 2D and 3D plots are painted.

The user does not need to create a canvas object explicitly, because a `plot` command such as `plot(object1, object2, ...)` implicitly creates a default canvas object to display the graphical objects in.

Strictly speaking, a canvas object is a container for scenes of type `plot::Scene2d` or `plot::Scene3d`, respectively. The user, however, does not have to bother about this technicality, because a suitable default scene is created internally, when graphical primitives are passed to `plot::Canvas`.

A canvas can display several scenes simultaneously. However, all scenes must be of the same dimension. A mixture of 2D and 3D is not supported!

See the help page of the canvas attribute `Layout` for details on the layout of a canvas containing several scenes.

The canvas object is always visible in the interactive object browser of the MuPAD graphics tool (see section `Viewer, Browser, and Inspector: Interactive Manipulation (Symbolic Math Toolbox)` of this document). It can contain one or more scenes as its children. When the canvas object is selected, it provides access to a variety of attributes that are associated with the canvas. The canvas attributes allow to

- set `Height` and `Width` of the plot,
- set a `Header` and/or a `Footer`,

- control the layout (Layout, Rows, Columns),
- set various style parameters such as `BorderWidth`, `BorderColor`, `BackgroundColor` etc.

A complete listing of the attributes associated with a canvas is given below. Follow the links to the help pages of the attributes to find more detailed information.

Apart from these attributes of the canvas object, also attributes for scenes, coordinate systems and graphical objects inside the canvas can be specified when generating a canvas object. These attribute values are inherited to the objects inside the canvas as new default values.

## Attributes

Attribute	Purpose	Default Value
<code>AnimationStyle</code>	behaviour of the animation toolbar	<code>RunOnce</code>
<code>AutoPlay</code>	start animations automatically	<code>TRUE</code>
<code>BackgroundColor</code>	background color	<code>RGB::White</code>
<code>BorderColor</code>	color of frame/border around canvas and scenes	<code>RGB::Grey50</code>
<code>BorderWidth</code>	width of frame/border around canvas and scenes	<code>0</code>
<code>BottomMargin</code>	bottom margin width	<code>1</code>
<code>Columns</code>	number of columns of scenes	<code>0</code>
<code>Footer</code>	footer text	
<code>FooterFont</code>	font of footers (scene and canvas)	<code>[" sans-serif ", 12]</code>
<code>FooterAlignment</code>	alignment of footer of canvas and scenes	<code>Center</code>
<code>Header</code>	header text	

Attribute	Purpose	Default Value
HeaderFont	font of headers (scene and canvas)	[" sans-serif ", 12]
HeaderAlignment	alignment of header of canvas and scenes	Center
Height	heights of canvas/scenes	80
InitialTime	initial time of the animation slider	
Layout	arrangement/layout of several scenes in a canvas	Tabular
LeftMargin	left margin width	1
Margin	margins around canvas and scenes	1
Name	the name of a plot object (for browser and legend)	
OutputUnits	the physical length unit used by the inspector	unit::mm
RightMargin	right margin width	1
Rows	number of rows of scenes	0
Spacing	space between scenes	1.0
TopMargin	top margin width	1
Width	widths of canvas/scenes	120

## Examples

### Example 1

We display several scenes in a canvas. Various canvas attributes are passed when creating the canvas object:

```
S1 := plot::Scene2d(plot::Function2d(sin(x), x = 0..2*PI),
                    Header = "the sine function");
S2 := plot::Scene2d(plot::Function2d(cos(x), x = 0..2*PI),
```

```

Header = "the cosine function"):
S3 := plot::Scene2d(plot::Function2d(tan(x), x = 0..PI),
Header = "the tan function"):
S4 := plot::Scene2d(plot::Function2d(cot(x), x = 0..PI),
Header = "the cot function"):
C := plot::Canvas(S1, S2, S3, S4,
Width = 80*unit::mm, Height = 80*unit::mm,
BorderWidth = 0.5*unit::mm,
Header = "trigonometric functions",
HeaderFont = ["Times New Roman", Bold, 18]):
plot(C)

```

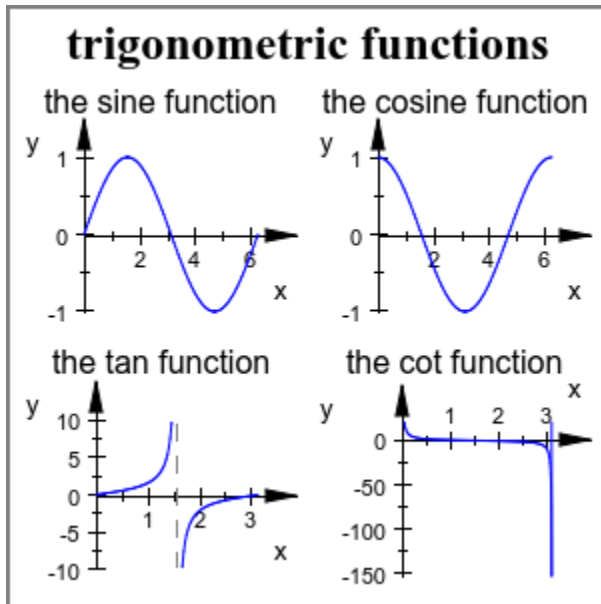

```
delete S1, S2, S3, S4, C:
```

## Parameters

**object<sub>1</sub>, object<sub>2</sub>, ...**

Graphical objects



## See Also

### **MuPAD Functions**

plot | plot::copy

### **MuPAD Graphical Primitives**

plot::CoordinateSystem2d | plot::CoordinateSystem3d | plot::Scene2d |  
plot::Scene3d

## plot::CoordinateSystem2d

Coordinate system to display 2D objects in

### Syntax

```
plot::CoordinateSystem2d(object1, object2, ..., <a = amin .. amax>, options)
```

### Description

`plot::CoordinateSystem2d` is a container to display graphical 2D objects within. Usually, the user does not need to create such an object explicitly, because a `plot` command such as `plot(object1, object2, ...)` creates a default object of type `plot::CoordinateSystem2d` implicitly to display the graphical objects in.

The `plot::CoordinateSystem2d` object is always visible in the interactive object browser of the MuPAD graphics tool (see [Viewer](#), [Browser](#), and [Inspector: Interactive Manipulation \(Symbolic Math Toolbox\)](#) of this document). It contains the graphical objects as its children. When the coordinate system object is selected, it provides access to a variety of attributes that are associated with the coordinate system. These attributes allow to manipulate:

- the `CoordinateType` (linear vs. logarithmic coordinates),
- the `ViewingBox` (visibility range),
- the coordinate axes on page 24-1445 (axes titles, visibility, alignment, type, tips etc.),
- the ticks on page 24-1520 along the coordinate axes (number of tick marks, visibility, tick labels etc.),
- the coordinate grid on page 24-1549 (visibility, color, line width etc.),
- the scaling ratios on page 24-1846 of the coordinate directions (`Constrained` vs. `UnConstrained`).

A complete listing of the attributes associated with the coordinate system is given below. Follow the links to the help pages of the attributes to find more detailed information.

Apart from these attributes of the coordinate system, also attributes for the graphical objects inside the coordinate system can be specified when generating an object of type

`plot::CoordinateSystem2d`. These attribute values are inherited to the graphical objects as new default values.

A graphical scene may contain more than one coordinate system. Each coordinate system provides separate coordinate axes, ticks, grid lines etc.

In such a case, separate `plot::CoordinateSystem2d` containers must be created explicitly by the user and passed to a `plot` command (or inserted into a scene of type `plot::Scene2d`). Cf. "Example 2" on page 24-1064 (Symbolic Math Toolbox).

## Attributes

Attribute	Purpose	Default Value
<code>Axes</code>	type of the coordinate axes	Automatic
<code>AxesTips</code>	arrow tips at the coordinate axes?	TRUE
<code>AxesOrigin</code>	crosspoint of the coordinate axes	[0, 0]
<code>AxesTitles</code>	titles for the coordinate axes	[" x ", " y "]
<code>AxesInFront</code>	coordinate axes in front of or behind graphical objects?	FALSE
<code>AxesOriginX</code>	crosspoint of the coordinate axes, x-coordinate	0
<code>AxesOriginY</code>	crosspoint of the coordinate axes, y-coordinate	0
<code>AxesVisible</code>	display coordinate axes?	TRUE
<code>AxesLineColor</code>	color of the coordinate axes	RGB::Black
<code>AxesLineWidth</code>	width of the coordinate axes	0.18
<code>AxesTitleFont</code>	font of axes titles	[" sans-serif ", 10]
<code>AxesTitleAlignment</code>	alignment of axes titles	End
<code>CoordinateType</code>	linear versus logarithmic plots in 2D	LinLin

<b>Attribute</b>	<b>Purpose</b>	<b>Default Value</b>
GridInFront	coordinate grid in front of or behind graphical objects?	FALSE
GridVisible	display a coordinate grid?	FALSE
GridLineColor	line color of the coordinate grid	RGB::Grey60
GridLineWidth	width of coordinate grid lines	0.1
GridLineStyle	line style of the coordinate grid	Solid
Name	the name of a plot object (for browser and legend)	
Scaling	scaling ratios	Unconstrained
SubgridVisible	display a coordinate subgrid?	FALSE
SubgridLineColor	line color of the coordinate subgrid	RGB::Grey80
SubgridLineWidth	width of coordinate subgrid lines	0.1
SubgridLineStyle	line style of the coordinate subgrid	Solid
TicksAt	special axes tick marks	
TicksAnchor	user defined start of axes tick marks	0
TicksLength	length of axes tick marks	2
TicksNumber	number of axes tick marks	Normal
TicksBetween	number of minor (unlabeled) axes tick marks between major (labeled) axes tick marks	1
TicksVisible	display axes tick marks?	TRUE
TicksDistance	user defined axes tick mark distance	0

Attribute	Purpose	Default Value
TicksLabelFont	font of tick labels	[" sans-serif ", 8]
TicksLabelStyle	display style of axes tick labels	Horizontal
TicksLabelsVisible	display axes tick labels?	TRUE
ViewingBox	the visible coordinate range	[Automatic .. Automatic, Automatic .. Automatic]
ViewingBoxXMin	the smallest visible x-values	Automatic
ViewingBoxYMin	the smallest visible y-values	Automatic
ViewingBoxXMax	the largest visible x-values	Automatic
ViewingBoxYMax	the largest visible y-values	Automatic
ViewingBoxXRange	the range of x-values visible	Automatic .. Automatic
ViewingBoxYRange	the range of y-values visible	Automatic .. Automatic
XAxisTitle	title for the x axis	" x "
XAxisVisible	display x axis?	TRUE
XAxisTitleAlignment	alignment of x axis title	End
XGridVisible	display a coordinate grid in x-direction?	FALSE
XSubgridVisible	display a coordinate subgrid in x-direction?	FALSE
XTicksAt	special x axis tick marks	
XTicksAnchor	user defined start of x axis tick marks	0
XTicksNumber	number of x axis tick marks	Normal
XTicksBetween	number of minor (unlabeled) x axis tick marks between major (labeled) x axis tick marks	1
XTicksVisible	display x axis tick marks?	TRUE
XTicksDistance	distance of tick marks on x axis	0

<b>Attribute</b>	<b>Purpose</b>	<b>Default Value</b>
XTicksLabelStyle	display style of x axis tick labels	Horizontal
XTicksLabelsVisible	display x axis tick labels?	TRUE
YAxisTitle	title for the y axis	" y "
YAxisVisible	display y axis?	TRUE
YAxisTitleAlignment	alignment of y axis title	End
YAxisTitleOrientation	orientation of the vertical axis title in 2D	Horizontal
YGridVisible	display a coordinate grid in y-direction?	FALSE
YSubgridVisible	display a coordinate subgrid in y-direction?	FALSE
YTicksAt	special y axis tick marks	
YTicksAnchor	user defined start of y axis tick marks	0
YTicksNumber	number of y axis tick marks	Normal
YTicksBetween	number of minor (unlabeled) y axis tick marks between major (labeled) y axis tick marks	1
YTicksVisible	display y axis tick marks?	TRUE
YTicksDistance	distance of tick marks on y axis	0
YTicksLabelStyle	display style of y axis tick labels	Horizontal
YTicksLabelsVisible	display y axis tick labels?	TRUE

## Examples

### Example 1

When executing a plot command, a default `plot::CoordinateSystem2d` is created implicitly which contains the specified graphical objects:

```
f := plot::Function2d(sin(x)^2, x = -PI..PI):  
g := plot::Function2d(cos(x)^2, x = -PI..PI):  
plot(f, g)
```

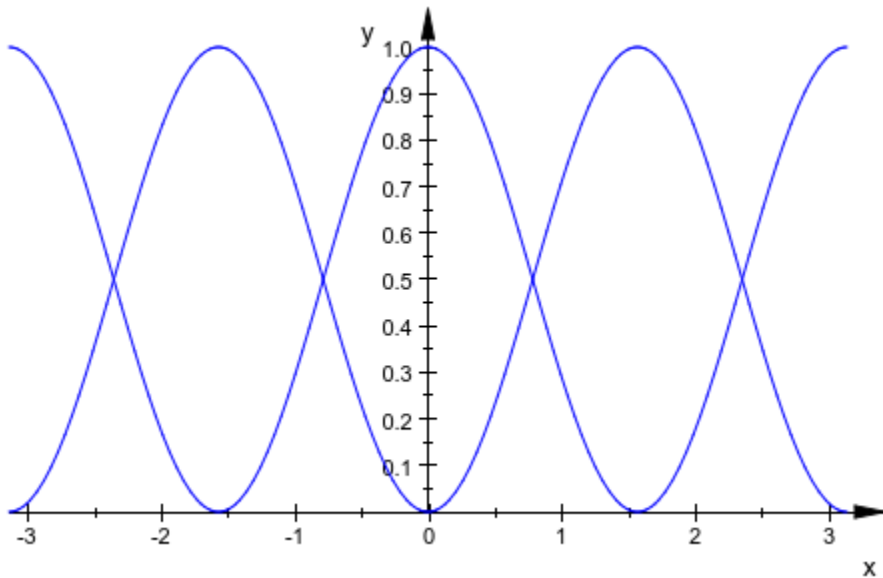

We can also create the coordinate system explicitly. The result is the same:

```
plot(plot::CoordinateSystem2d(f, g))
```

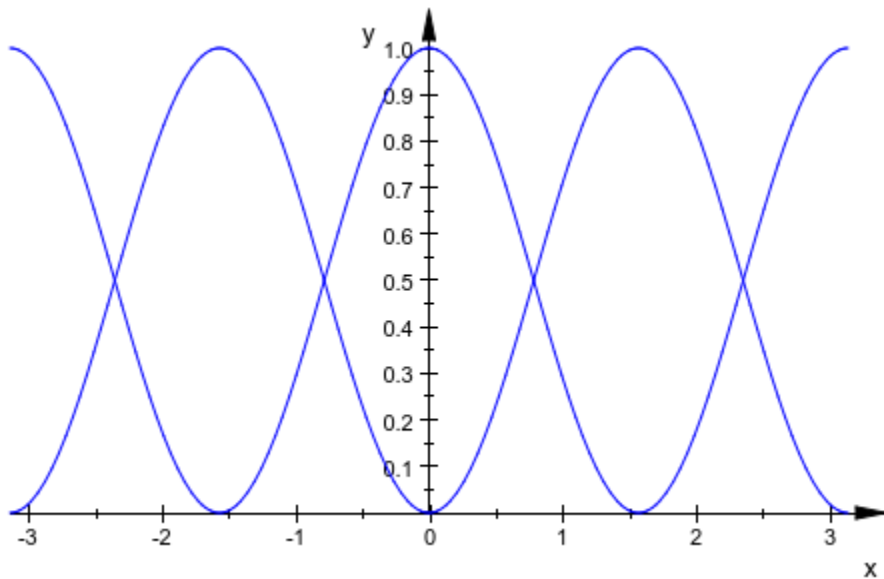

```
delete f, g:
```

## Example 2

We present the yearly sales of pears and apples in one scene. Different coordinate systems are used to obtain separate axes. We set various attributes to determine the positioning of the axes and their titles:

```
pears := plot::Polygon2d(  
    [[1998, 1.2], [1999, 1.4], [2000, 1.5],  
     [2001, 1.7], [2002, 2.1], [2003, 1.98]],  
    Color = RGB::Red, Title = "pears",  
    TitlePosition = [2000, 1.6],  
    TitleFont = [RGB::Red]):  
apples := plot::Polygon2d(  
    [[1998, 10.2], [1999, 14.4], [2000, 17.5],  
     [2001, 16.8], [2002, 18.0], [2003, 18.5]],  
    Color = RGB::Blue, Title = "apples",  
    TitlePosition = [2000, 18.0],  
    TitleFont = [RGB::Blue]):
```



```

CS1 := plot::CoordinateSystem2d(pears):
CS1::AxesOriginX := 1998:
CS1::ViewingBox := [1998..2003, 0..2.5]:
CS1::AxesTitleFont := [RGB::Red]:
CS1::XAxisTitle := "year":
CS1::YAxisTitle := "pears":

CS2 := plot::CoordinateSystem2d(apples):
CS2::AxesOriginX := 2003:
CS2::ViewingBox := [1998..2003, 0..20]:
CS2::AxesTitleFont := [RGB::Blue]:
CS2::XAxisTitle := "year":
CS2::YAxisTitle := "apples":
plot(CS1, CS2, Axes = Origin, YAxisTitleAlignment = Center,
     YAxisTitleOrientation = Vertical)

```

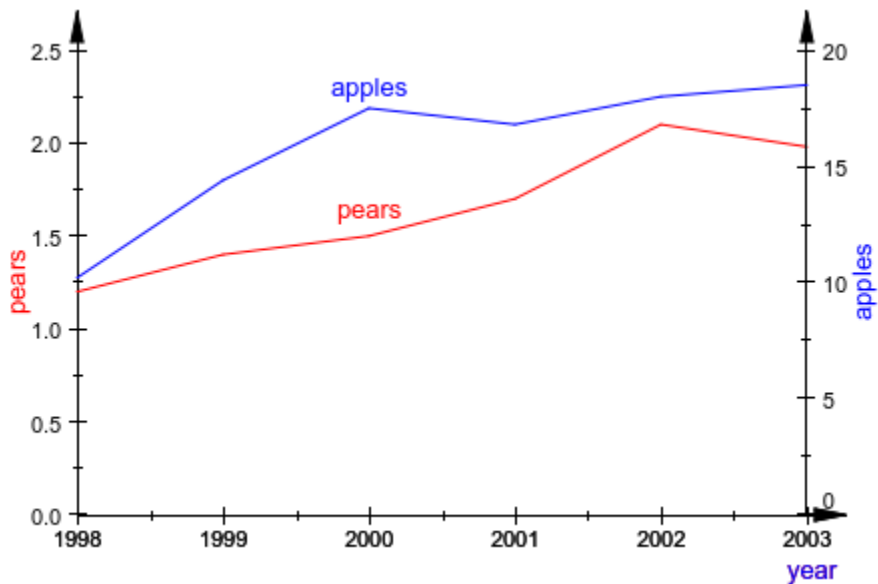

```
delete pears, apples, CS1, CS2:
```

## Parameters

`object1, object2, ...`

Graphical 2D objects

## See Also

### MuPAD Functions

`plot` | `plot::copy`

### MuPAD Graphical Primitives

`plot::Canvas` | `plot::CoordinateSystem2d` | `plot::Scene2d`

# plot::CoordinateSystem3d

Coordinate system to display 3D objects in

## Syntax

```
plot::CoordinateSystem3d(object1, object2, ..., <a = amin .. amax>, options)
```

## Description

`plot::CoordinateSystem3d` is a container to display graphical 3D objects within. Usually, the user does not need to create such an object explicitly, because a `plot` command such as `plot(object1, object2, ...)` creates a default object of type `plot::CoordinateSystem3d` implicitly to display the graphical objects in.

The `plot::CoordinateSystem3d` object is always visible in the interactive object browser of the MuPAD graphics tool (see section Viewer, Browser, and Inspector: Interactive Manipulation (Symbolic Math Toolbox) of this document). It contains the graphical objects as its children. When the coordinate system object is selected, it provides access to a variety of attributes that are associated with the coordinate system. These attributes allow to manipulate:

- the `ViewingBox` (visibility range),
- the coordinate axes on page 24-1445 (axes titles, visibility, alignment, type, tips etc.),
- the ticks on page 24-1520 along the coordinate axes (number of tick marks, visibility, tick labels etc.),
- the coordinate grid on page 24-1549 (visibility, color, line width etc.),
- the scaling ratios on page 24-1846 of the coordinate directions (`Constrained` vs. `UnConstrained`).

A complete listing of the attributes associated with the coordinate system is given below. Follow the links to the help pages of the attributes to find more detailed information.

Apart from these attributes of the coordinate system, also attributes for the graphical objects inside the coordinate system can be specified when generating an object of type

`plot::CoordinateSystem3d`. These attribute values are inherited to the graphical objects as new default values.

A graphical scene may contain more than one coordinate system. Each coordinate system provides separate coordinate axes, ticks, grid lines etc.

In such a case, separate `plot::CoordinateSystem3d` containers must be created explicitly by the user and passed to a `plot` command (or inserted into a scene of type `plot::Scene3d`). Cf. "Example 2" on page 24-1074 (Symbolic Math Toolbox).

## Attributes

Attribute	Purpose	Default Value
<code>Axes</code>	type of the coordinate axes	Boxed
<code>AxesTips</code>	arrow tips at the coordinate axes?	FALSE
<code>AxesOrigin</code>	crosspoint of the coordinate axes	[0, 0, 0]
<code>AxesTitles</code>	titles for the coordinate axes	[" x ", " y ", " z "]
<code>AxesOriginX</code>	crosspoint of the coordinate axes, x-coordinate	0
<code>AxesOriginY</code>	crosspoint of the coordinate axes, y-coordinate	0
<code>AxesOriginZ</code>	crosspoint of the coordinate axes, z-coordinate	0
<code>AxesVisible</code>	display coordinate axes?	TRUE
<code>AxesLineColor</code>	color of the coordinate axes	RGB::Black
<code>AxesLineWidth</code>	width of the coordinate axes	0.18
<code>AxesTitleFont</code>	font of axes titles	[" sans-serif ", 10]
<code>AxesTitleAlignment</code>	alignment of axes titles	Center
<code>GridVisible</code>	display a coordinate grid?	FALSE
<code>GridLineColor</code>	line color of the coordinate grid	RGB::Grey60

<b>Attribute</b>	<b>Purpose</b>	<b>Default Value</b>
GridLineWidth	width of coordinate grid lines	0.1
GridLineStyle	line style of the coordinate grid	Solid
Name	the name of a plot object (for browser and legend)	
Scaling	scaling ratios	Unconstrained
SubgridVisible	display a coordinate subgrid?	FALSE
SubgridLineColor	line color of the coordinate subgrid	RGB: :Grey80
SubgridLineWidth	width of coordinate subgrid lines	0.1
SubgridLineStyle	line style of the coordinate subgrid	Solid
TicksAt	special axes tick marks	
TicksAnchor	user defined start of axes tick marks	0
TicksLength	length of axes tick marks	2
TicksNumber	number of axes tick marks	Normal
TicksBetween	number of minor (unlabeled) axes tick marks between major (labeled) axes tick marks	1
TicksVisible	display axes tick marks?	TRUE
TicksDistance	user defined axes tick mark distance	0
TicksLabelFont	font of tick labels	[" sans-serif ", 8]
TicksLabelStyle	display style of axes tick labels	Horizontal
TicksLabelsVisible	display axes tick labels?	TRUE

<b>Attribute</b>	<b>Purpose</b>	<b>Default Value</b>
ViewingBox	the visible coordinate range	[Automatic .. Automatic, Automatic .. Automatic, Automatic .. Automatic]
ViewingBoxXMin	the smallest visible x-values	Automatic
ViewingBoxYMin	the smallest visible y-values	Automatic
ViewingBoxXMax	the largest visible x-values	Automatic
ViewingBoxZMin	the smallest visible z-values	Automatic
ViewingBoxYMax	the largest visible y-values	Automatic
ViewingBoxZMax	the largest visible z-values	Automatic
ViewingBoxXRRange	the range of x-values visible	Automatic .. Automatic
ViewingBoxYRange	the range of y-values visible	Automatic .. Automatic
ViewingBoxZRange	the range of z-values visible	Automatic .. Automatic
XAxisTitle	title for the x axis	" x "
XAxisVisible	display x axis?	TRUE
XAxisTitleAlignment	alignment of x axis title	Center
XGridVisible	display a coordinate grid in x-direction?	FALSE
XSubgridVisible	display a coordinate subgrid in x-direction?	FALSE
XTicksAt	special x axis tick marks	
XTicksAnchor	user defined start of x axis tick marks	0
XTicksNumber	number of x axis tick marks	Normal
XTicksBetween	number of minor (unlabeled) x axis tick marks between major (labeled) x axis tick marks	1
XTicksVisible	display x axis tick marks?	TRUE
XTicksDistance	distance of tick marks on x axis	0

<b>Attribute</b>	<b>Purpose</b>	<b>Default Value</b>
XTicksLabelStyle	display style of x axis tick labels	Horizontal
XTicksLabelsVisible	display x axis tick labels?	TRUE
YAxisTitle	title for the y axis	" y "
YAxisVisible	display y axis?	TRUE
YAxisTitleAlignment	alignment of y axis title	Center
YGridVisible	display a coordinate grid in y-direction?	FALSE
YSubgridVisible	display a coordinate subgrid in y-direction?	FALSE
YTicksAt	special y axis tick marks	
YTicksAnchor	user defined start of y axis tick marks	0
YTicksNumber	number of y axis tick marks	Normal
YTicksBetween	number of minor (unlabeled) y axis tick marks between major (labeled) y axis tick marks	1
YTicksVisible	display y axis tick marks?	TRUE
YTicksDistance	distance of tick marks on y axis	0
YTicksLabelStyle	display style of y axis tick labels	Horizontal
YTicksLabelsVisible	display y axis tick labels?	TRUE
ZAxisTitle	title for the z axis	" z "
ZAxisVisible	display z axis?	TRUE
ZAxisTitleAlignment	alignment of z axis title	Center
ZGridVisible	display a coordinate grid in z-direction?	FALSE
ZSubgridVisible	display a coordinate subgrid in z-direction?	FALSE

Attribute	Purpose	Default Value
ZTicksAt	special z axis tick marks	
ZTicksAnchor	user defined start of z axis tick marks	0
ZTicksNumber	number of z axis tick marks	Normal
ZTicksBetween	number of minor (unlabeled) z axis tick marks between major (labeled) z axis tick marks	1
ZTicksVisible	display z axis tick marks?	TRUE
ZTicksDistance	distance of tick marks on z axis	0
ZTicksLabelStyle	display style of z axis tick labels	Horizontal
ZTicksLabelsVisible	display z axis tick labels?	TRUE

## Examples

### Example 1

When executing a plot command, a default `plot::CoordinateSystem3d` is created implicitly which contains the specified graphical objects:

```
f := plot::Function3d(sin(x - y)^2, x = -PI..PI, y = -PI..PI):  
g := plot::Function3d(cos(x - y)^2, x = -PI..PI, y = -PI..PI):  
plot(f, g)
```



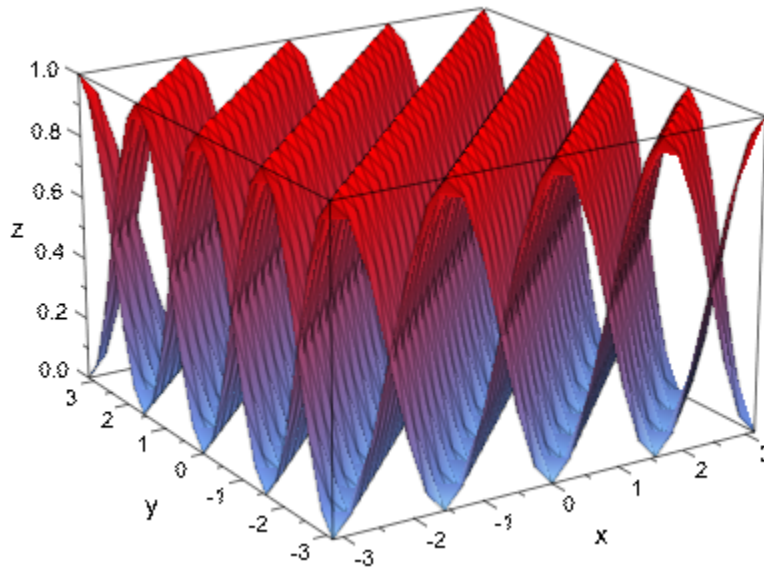

We can also create the coordinate system explicitly. The result is the same:

```
plot(plot::CoordinateSystem3d(f, g))
```

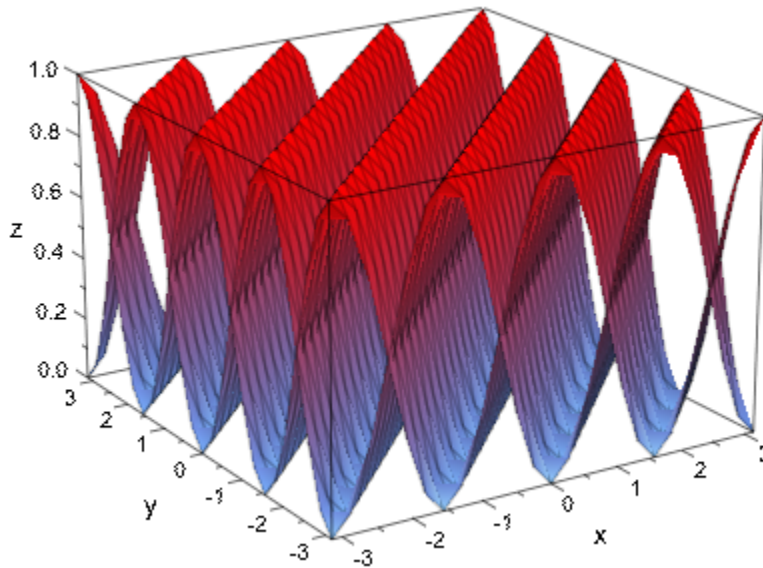

delete f, g:

## Example 2

The functions  $f_1 = \sin(x - y)$  and  $f_2 = \sin(h)(x + y)$  cannot be plotted simultaneously in one coordinate system over the range  $x \in [-10, 10]$ ,  $y \in [-10, 10]$ , because they produce function values of different orders of magnitude. To plot them together, we use two different coordinate systems. We request explicit vertical ranges for the (rather different) viewing boxes by the attribute `ViewingBoxZRange`.

We set various attributes of the coordinate systems to determine the positioning of the axes and their titles:

```
f1 := plot::Function3d(sin(x - y), x = -10..10, y = -10..10,
    Submesh = [2, 2],
    Color = RGB::Red, FillColorType = Flat,
    Legend = "sin(x - y)"):
CS1 := plot::CoordinateSystem3d(f1):
CS1::Axes := Origin:
CS1::AxesOrigin := [-10, 10, -3]:
CS1::ViewingBoxZRange := -3..3:
```

```

CS1::ZAxisTitle := "sin":

f2 := plot::Function3d(sinh(x + y), x = -10..10, y = -10..10,
    Color = RGB::Blue, FillColorType = Flat,
    Legend = "sinh(x + y)":
CS2 := plot::CoordinateSystem3d(f2):
CS2::Axes := Origin:
CS2::AxesOrigin := [10, -10, -3*10^8]:
CS2::ViewingBoxZRange := -3*10^8..3*10^8:
CS2::ZAxisTitle := "sinh":

plot(CS1, CS2):

```

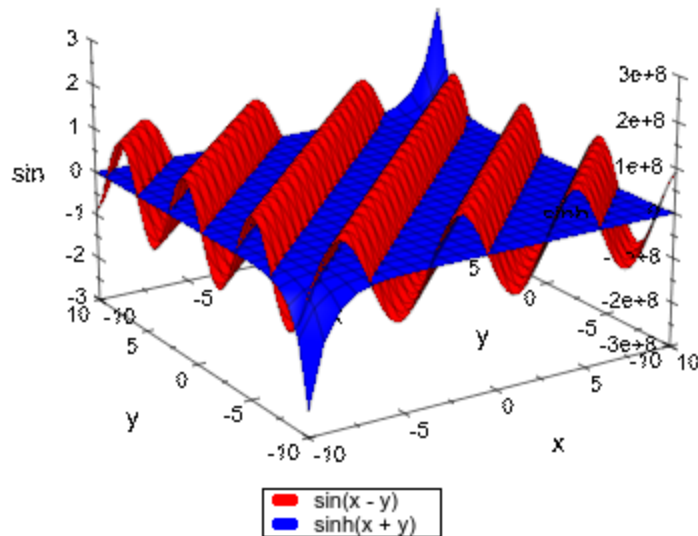

```
delete f1, CS1, f2, CS2:
```

## Parameters

**object<sub>1</sub>, object<sub>2</sub>, ...**

Graphical 3D objects

## See Also

### **MuPAD Functions**

`plot` | `plot::copy`

### **MuPAD Graphical Primitives**

`plot::Canvas` | `plot::CoordinateSystem3d` | `plot::Scene3d`

# plot::Group2d

Groups of 2D objects

## Syntax

```
plot::Group2d(object2d1, object2d2, ..., <a = amin .. amax>, options)
```

## Description

`plot::Group2d` forms a group of any number of graphical 2D objects.

Grouping together a larger number of graphical objects and accessing the group as a whole simplifies their handling. In particular, the main purpose of a group is to inherit graphical attributes that are shared by all members of the group.

To change the inherited attributes interactively, do not select the group itself in the interactive object browser of the MuPAD graphics tool (see Viewer, Browser, and Inspector: Interactive Manipulation (Symbolic Math Toolbox)). Underneath the group object, find 'defaults' branches for the objects in the group. Select the 'defaults' branch for the object type that you want to set attributes for.

A group can contain groups.

---

**Note** When working with groups of points, the more efficient approach is to use the specialized grouping construct `plot::PointList2d` instead of generic groups of points.

---

## Attributes

Attribute	Purpose	Default Value
Name	the name of a plot object (for browser and legend)	
Visible	visibility	TRUE

## Examples

### Example 1

Consider a group G1 consisting of two triangles inscribed in an ellipse. Form a new group G2 consisting of the group G1, the ellipse and its focal points. The entire figure given by the group G2 is rotated by an animated `plot::Rotate2d`:

```
G1 := plot::Group2d(
  plot::Polygon2d([[0, -1], [0, 1], [-2, 0]]),
  plot::Polygon2d([[0, -1], [0, 1], [ 2, 0]]),
  Closed = TRUE, Filled = TRUE, Color = RGB::Blue):
G2 := plot::Group2d(
  G1,
  plot::Ellipse2d(2, 1,[0, 0]),
  plot::PointList2d([[-sqrt(3), 0], [sqrt(3), 0]]),
  PointSize = 2*unit::mm,
  PointColor = RGB::Red,
  LineColor = RGB::Black):
plot(plot::Rotate2d(a, [0, 0], a = 0..2*PI, G2))
```

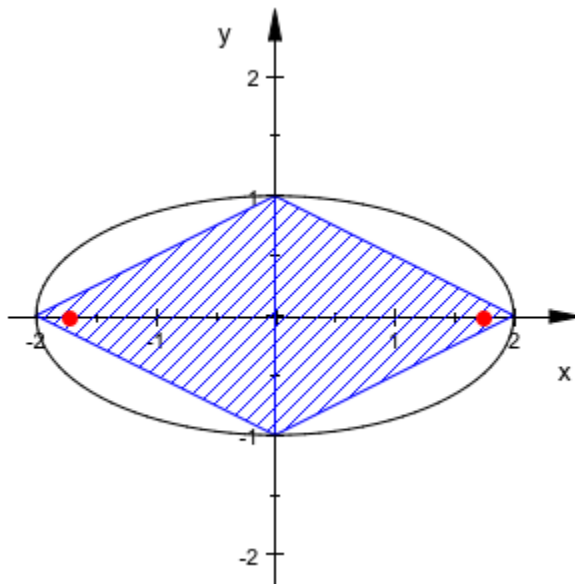

delete G1, G2:

## Parameters

`object2d1`, `object2d2`, ...

Graphical 2D objects

## See Also

### MuPAD Functions

`plot` | `plot::copy`

### MuPAD Graphical Primitives

`plot::Group3d` | `plot::PointList2d` | `plot::PointList3d`

## Topics

“Groups of Primitives” (Symbolic Math Toolbox)

## plot::Group3d

Groups of 3D objects

### Syntax

```
plot::Group3d(object3d1, object3d2, ..., <a = amin .. amax>, options)
```

### Description

`plot::Group3d` forms a group of any number of graphical 3D objects.

Grouping together a larger number of graphical objects and accessing the group as a whole simplifies their handling. In particular, the main purpose of a group is to inherit graphical attributes that are shared by all members of the group.

To change the inherited attributes interactively, do not select the group itself in the interactive object browser of the MuPAD graphics tool (see Viewer, Browser, and Inspector: Interactive Manipulation (Symbolic Math Toolbox)). Underneath the group object, find 'defaults' branches for the objects in the group. Select the 'defaults' branch for the object type that you want to set attributes for.

A group can contain groups.

---

**Note** When working with groups of points, the more efficient approach is to use the specialized grouping construct `plot::PointList3d` instead of generic groups of points.

---

### Attributes

Attribute	Purpose	Default Value
Name	the name of a plot object (for browser and legend)	
Visible	visibility	TRUE



## Examples

### Example 1

Plot two groups of bubbles. Some bubbles are not visible as they are inside larger bubbles:

```
G1 := plot::Group3d(plot::Sphere(1/n, [0, 0, n/2 + 1/n]
                    ) $ n = 1..10):
G2 := plot::Group3d(plot::Sphere(1/(3*n), [0, 0, n/2 + 1/n]
                    ) $ n = 2..10):
plot(G1, G2)
```

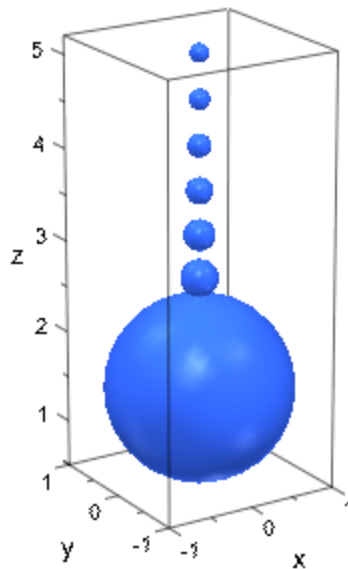

Increase transparency of all bubbles in the first group, but keep the bubbles in the second group opaque. Because the bubbles are grouped, it is easy to set different attribute values for the two groups:

```
G1::Color := RGB::SkyBlue.[0.25]:
G2::Color := RGB::Red:
plot(G1, G2)
```

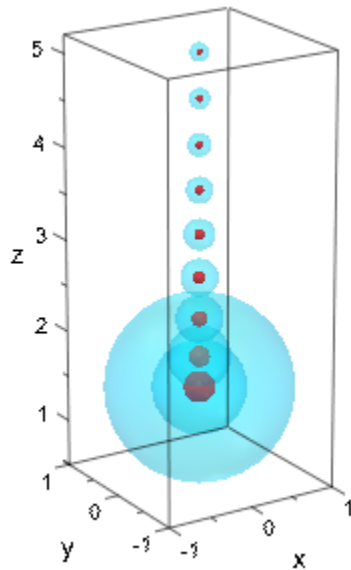

delete G1, G2:

## Parameters

`object3d1`, `object3d2`, ...

Graphical 3D objects

## See Also

### MuPAD Functions

`plot` | `plot::copy`

### MuPAD Graphical Primitives

`plot::Group2d` | `plot::PointList2d` | `plot::PointList3d`

## **Topics**

“Groups of Primitives” (Symbolic Math Toolbox)

## plot::Scene2d

2D scenes

### Syntax

```
plot::Scene2d(object2d1, object2d2, ..., <a = amin .. amax>, options)
```

### Description

`plot::Scene2d` is a container to display one or more coordinate systems containing graphical objects. Scene objects must be created when several graphical scenes are to be displayed simultaneously in a plot.

Usually, you do not need to create a scene object explicitly, because `plot(object1, object2, ...)` creates a default scene object implicitly to display the graphical objects in. You must create scene objects explicitly only when several scenes are to be displayed simultaneously in one plot.

The MuPAD graphics makes a clear division between 2D and 3D. Scene objects of type `plot::Scene2d` do not accept 3D objects and `plot::Scene3d` objects do not accept 2D objects. When several scenes are displayed simultaneously in a single plot, all scenes must be of the same dimension.

Strictly speaking, a 2D scene object is a container for coordinate systems of type `plot::CoordinateSystem2d`. However, you can ignore this technicality because a suitable default coordinate system is created internally, when graphical primitives are passed to `plot::Scene2d`.

Scene objects are always visible in the interactive object browser of the MuPAD graphics tool (see section Viewer, Browser, and Inspector: Interactive Manipulation (Symbolic Math Toolbox) of this document). Each scene contains one or more coordinate systems as its children. When the scene object is selected, it provides access to a variety of attributes that are associated with scenes. The scene attributes let you:

- Set annotations (Header, Footer) and control the Legend.

- Set layout parameters such as height and width if the canvas attribute `Layout` is set to `Absolute` or `Relative`.
- Set various style parameters, such as `BackgroundColor`.

A complete listing of the attributes associated with a 2D scene is given below. Follow the links to the help pages of the attributes to find more detailed information.

Apart from these attributes of the scene object, also attributes for the coordinate system and the graphical objects inside the scene can be specified when generating a scene object. These attribute values are inherited to the coordinate system and the graphical objects as new default values.

A plot can contain more than one graphical scene. In this case, create separate scene objects and pass them to a `plot` command or insert them into an object of type `plot::Canvas`. For details on the layout of scenes inside the drawing area ("canvas"), see the help page of the canvas attribute `Layout`. See "Example 1" on page 24-1086 (Symbolic Math Toolbox).

## Attributes

Attribute	Purpose	Default Value
<code>BackgroundColor</code>	background color	<code>RGB::White</code>
<code>BackgroundTransparent</code>	plot a scene on a transparent background	<code>FALSE</code>
<code>BorderColor</code>	color of frame/border around canvas and scenes	<code>RGB::Grey50</code>
<code>BorderWidth</code>	width of frame/border around canvas and scenes	<code>0</code>
<code>Bottom</code>	distance of bottom of scene to bottom of canvas	<code>0</code>
<code>BottomMargin</code>	bottom margin width	<code>1</code>
<code>Footer</code>	footer text	
<code>FooterFont</code>	font of footers (scene and canvas)	<code>[" sans-serif ", 12]</code>

Attribute	Purpose	Default Value
FooterAlignment	alignment of footer of canvas and scenes	Center
Header	header text	
HeaderFont	font of headers (scene and canvas)	[" sans-serif ", 12]
HeaderAlignment	alignment of header of canvas and scenes	Center
Height	heights of canvas/scenes	80
Left	distance of left of scene to left of canvas	0
LeftMargin	left margin width	1
LegendFont	font of legend entries	[" sans-serif ", 8]
LegendVisible	switch legend on/off	FALSE
LegendPlacement	legend above or below	Bottom
LegendAlignment	legend at left, center, or right	Center
Margin	margins around canvas and scenes	1
Name	the name of a plot object (for browser and legend)	
RightMargin	right margin width	1
TopMargin	top margin width	1
Width	widths of canvas/scenes	120

## Examples

### Example 1

Scene objects must be created explicitly only when you want to display several scenes simultaneously in one plot. The following call uses the automatic layout on page 24-1653 of several scenes in a canvas:

```

S1 := plot::Scene2d(plot::Function2d(sin(x), x = 0..2*PI),
                    Header = "the sine function"):
S2 := plot::Scene2d(plot::Function2d(cos(x), x = 0..2*PI),
                    Header = "the cosine function"):
S3 := plot::Scene2d(plot::Function2d(tan(x), x = 0..PI),
                    Header = "the tan function"):
S4 := plot::Scene2d(plot::Function2d(cot(x), x = 0..PI),
                    Header = "the cot function"):
plot(S1, S2, S3, S4, BorderWidth = 0.5*unit::mm)

```

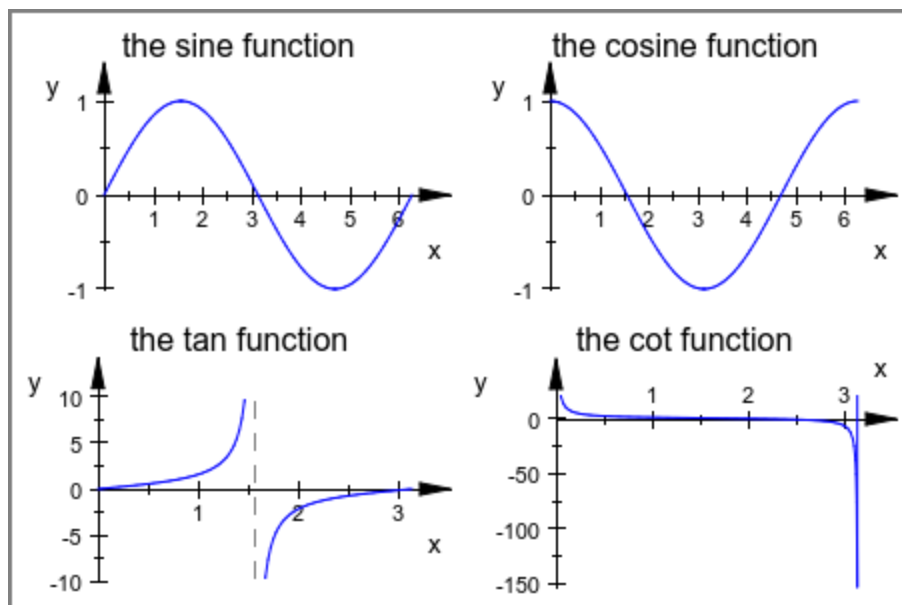

Use the canvas attribute `Layout = Relative` to position 3 of these scenes in the canvas. The size of the scenes is set with the attributes `Width` and `Height`, specifying multiples of the canvas' width and height. The bottom left corner of each scene is positioned with the scene attributes `Bottom` and `Left`:

```

S1::Width := 0.475: S1::Height := 0.42:
S2::Width := 0.475: S2::Height := 0.42:
S3::Width := 0.475: S3::Height := 0.42:
S1::Bottom := 0.46: S1::Left := 0.02:
S2::Bottom := 0.02: S2::Left := 0.02:
S3::Bottom := 0.26: S3::Left := 0.51:
S3::HeaderFont := ["Times New Roman", Italic, 12]:

```

```

plot(S1, S2, S3, Layout = Relative,
     BorderWidth = 0.5*unit::mm,
     plot::Scene2d::BorderWidth = 0.2*unit::mm,
     Header = "trigonometric functions",
     HeaderFont = ["Times New Roman", Bold, 18]):

```

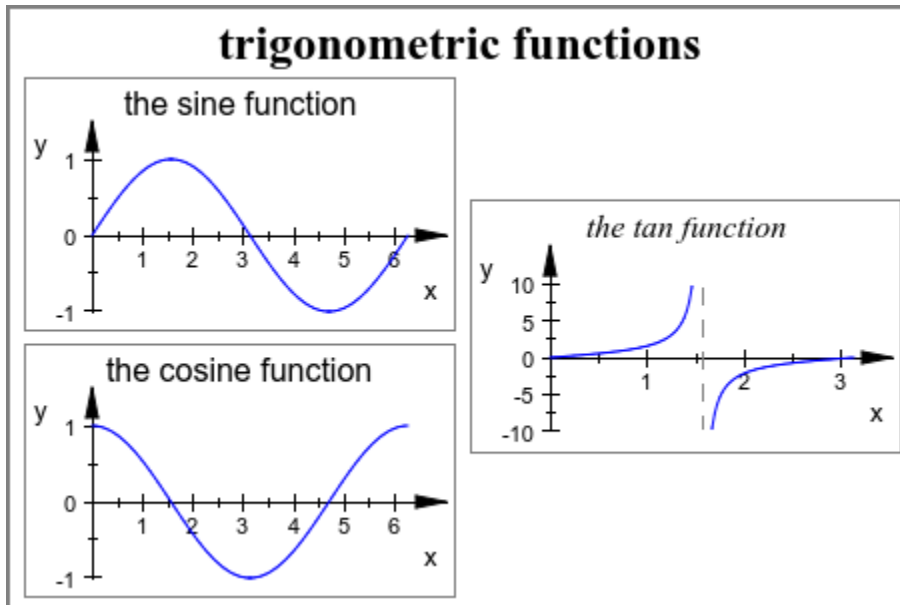

```
delete S1, S2, S3, S4:
```

## Parameters

**object2d<sub>1</sub>, object2d<sub>2</sub>, ...**

2D coordinate systems on page 24-1058 or graphical 2D objects

## See Also

**MuPAD Functions**

plot | plot::copy



**MuPAD Graphical Primitives**

plot::Canvas | plot::CoordinateSystem2d | plot::CoordinateSystem3d |  
plot::Scene3d

## plot::Scene3d

3D scenes

### Syntax

```
plot::Scene3d(object3d1, object3d2, ..., <a = amin .. amax>, options)
```

### Description

`plot::Scene3d` is a container to display one or more coordinate systems containing graphical objects. Scene objects must be created when several graphical scenes are to be displayed simultaneously in a plot.

Usually, you do not need to create a scene object explicitly, because `plot(object1, object2, ...)` creates a default scene object implicitly to display the graphical objects in. You must create scene objects explicitly only when several scenes are to be displayed simultaneously in one plot.

The MuPAD graphics makes a clear division between 2D and 3D. Scene objects of type `plot::Scene2d` do not accept 3D objects and `plot::Scene3d` objects do not accept 2D objects. When several scenes are displayed simultaneously in a single plot, all scenes must be of the same dimension.

Strictly speaking, a 3D scene object is a container for coordinate systems of type `plot::CoordinateSystem3d`. However, you can ignore this technicality because a suitable default coordinate system is created internally, when graphical primitives are passed to `plot::Scene3d`.

Scene objects are always visible in the interactive object browser of the MuPAD graphics tool (see section [Viewer, Browser, and Inspector: Interactive Manipulation \(Symbolic Math Toolbox\)](#) of this document). Each scene contains one or more coordinate systems as its children. When the scene object is selected, it provides access to a variety of attributes that are associated with scenes. The scene attributes let you:

- Set annotations (Header, Footer) and control the Legend.

- Set layout parameters such as height and width if the canvas attribute `Layout` is set to `Absolute` or `Relative`.
- Set a direction for the automatic camera in 3D by using `CameraDirection`.
- Set various style parameters, such as `BackgroundColor`.

A complete listing of the attributes associated with a 3D scene is given below. Follow the links to the help pages of the attributes to find more detailed information.

Apart from these attributes of the scene object, also attributes for the coordinate system and the graphical objects inside the scene can be specified when generating a scene object. These attribute values are inherited to the coordinate system and the graphical objects as new default values.

A plot can contain more than one graphical scene. In this case, create separate scene objects explicitly and pass them to a `plot` command or insert them into an object of type `plot::Canvas`. For details on the layout of scenes inside the drawing area (“canvas”), see the help page of the canvas attribute `Layout`.

## Attributes

Attribute	Purpose	Default Value
<code>BackgroundColor</code>	background color	<code>RGB::White</code>
<code>BackgroundColor2</code>	second background color for color blends	<code>RGB::Grey75</code>
<code>BackgroundStyle</code>	color blends in the background	<code>Flat</code>
<code>BackgroundTransparent</code>	plot a scene on a transparent background	<code>FALSE</code>
<code>BorderColor</code>	color of frame/border around canvas and scenes	<code>RGB::Grey50</code>
<code>BorderWidth</code>	width of frame/border around canvas and scenes	<code>0</code>
<code>Bottom</code>	distance of bottom of scene to bottom of canvas	<code>0</code>
<code>BottomMargin</code>	bottom margin width	<code>1</code>

<b>Attribute</b>	<b>Purpose</b>	<b>Default Value</b>
CameraDirection	the direction of the automatic camera	
CameraDirectionX	the direction of the automatic camera, x-component	
CameraDirectionY	the direction of the automatic camera, y-component	
CameraDirectionZ	the direction of the automatic camera, z-component	
Footer	footer text	
FooterFont	font of footers (scene and canvas)	[" sans-serif ", 12]
FooterAlignment	alignment of footer of canvas and scenes	Center
Header	header text	
HeaderFont	font of headers (scene and canvas)	[" sans-serif ", 12]
HeaderAlignment	alignment of header of canvas and scenes	Center
Height	heights of canvas/scenes	80
Left	distance of left of scene to left of canvas	0
LeftMargin	left margin width	1
LegendFont	font of legend entries	[" sans-serif ", 8]
LegendVisible	switch legend on/off	FALSE
LegendPlacement	legend above or below	Bottom
LegendAlignment	legend at left, center, or right	Center
Lighting	light schemes for 3D graphics	Automatic

Attribute	Purpose	Default Value
Margin	margins around canvas and scenes	1
Name	the name of a plot object (for browser and legend)	
RightMargin	right margin width	1
TopMargin	top margin width	1
Width	widths of canvas/scenes	120
YXRatio	scaling ratio between y and x axes	1
ZXRatio	scaling ratio between z and x axes	2/3

## Examples

### Example 1

Conic sections are the curves that you get when intersecting a cone and a plane. The first scene displays a plane and a rotating cone. The second scene displays the corresponding conic section:

```
c := plot::Cone(1, [-sin(a), 0, -cos(a)], [sin(a), 0, cos(a)],
               a = 0..2*PI):
s := plot::Surface([x, y, 0], x = -1..1, y = -1..1):
S1 := plot::Scene3d(c, s):
S2 := plot::Scene3d(c, ViewingBoxZRange = -0.01 .. 0.01):
plot(S1, S2, Layout = Horizontal)
```

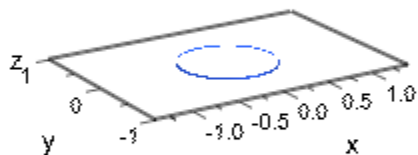
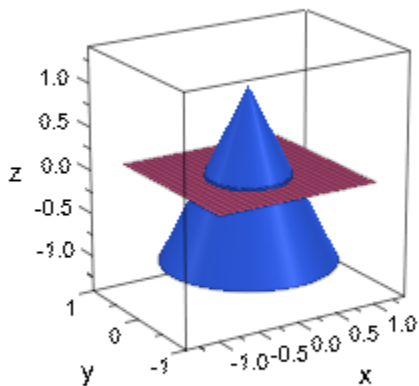

delete c, s, S1, S2:

## Parameters

`object3d1`, `object3d2`, ...

3D coordinate systems on page 24-1067 or graphical 3D objects

## See Also

### MuPAD Functions

`plot` | `plot::copy`

### MuPAD Graphical Primitives

`plot::Canvas` | `plot::CoordinateSystem2d` | `plot::CoordinateSystem3d` |  
`plot::Scene2d`

# plot::ClippingBox

Clipping of 3D objects

## Syntax

```
plot::ClippingBox(x_min .. x_max, y_min .. y_max, z_min .. z_max, <a = a_min .. a_max>, options)
```

## Description

A `plot::ClippingBox` defines a cubic box with edges parallel to the coordinate axes. When a clipping box is inserted in a 3D scene, only the parts of the graphical objects in the scene are visible that lie inside the coordinate range defined by the clipping box.

Inserting a `plot::ClippingBox` into a 3D scene has a similar effect as specifying a viewing box for the scene by the attribute `ViewingBox`.

However, the specified viewing box fills the entire drawing region of the plot, whereas a `plot::ClippingBox` preserves the space in the drawing region that the invisible parts would fill if no clipping box was used.

Moreover, in contrast to `plot::ClippingBox`, the visibility range defined by the `ViewingBox` cannot be animated.

In fact, the main purpose of `plot::ClippingBox` is to provide an animated version of the `ViewingBox`.

Size and location of the `ViewingBox` remain unaffected by the presence of a clipping box. Also coordinate axes are not clipped.

Only one single `plot::ClippingBox` should be used inside a 3D scene.

## Attributes

Attribute	Purpose	Default Value
Frames	the number of frames in an animation	50
Name	the name of a plot object (for browser and legend)	
ParameterEnd	end value of the animation parameter	
ParameterName	name of the animation parameter	
ParameterBegin	initial value of the animation parameter	
ParameterRange	range of the animation parameter	
TimeEnd	end time of the animation	10.0
TimeBegin	start time of the animation	0.0
TimeRange	the real time span of an animation	0.0 .. 10.0
Visible	visibility	TRUE
XMax	final value of parameter "x"	
XMin	initial value of parameter "x"	
XRange	range of parameter "x"	
YMax	final value of parameter "y"	
YMin	initial value of parameter "y"	
YRange	range of parameter "y"	
ZMax	final value of parameter "z"	
ZMin	initial value of parameter "z"	
ZRange	range of parameter "z"	



## Examples

### Example 1

We plot a full sphere yet rendering only a part of it visible. This is done by passing a suitable `plot::ClippingBox` to the `plot` command. Note that the viewing box remains unaffected:

```
plot(plot::Sphere(1, [0, 0, 0]),
      plot::ClippingBox(-1 + a .. 1 - a,
                        -1 + a .. 1 - a,
                        -1 .. 1, a = 0..1))
```

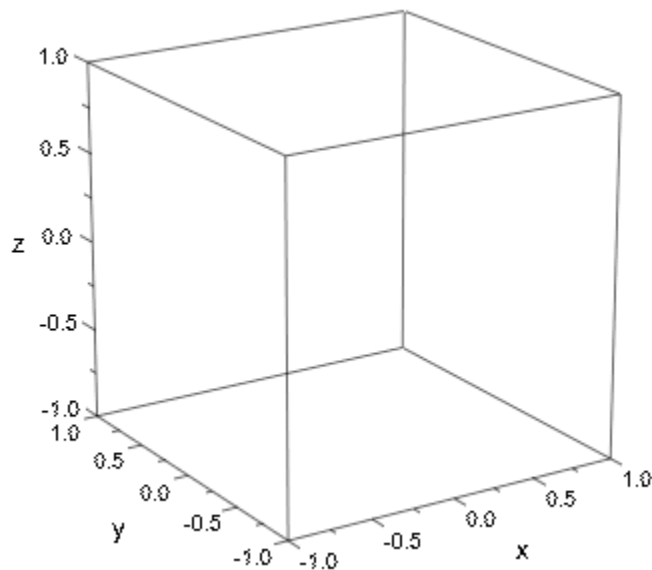

### Example 2

We plot a Klein bottle. By chopping off the upper parts, one can have a look inside:

```
KleinBottle := plot::Tube([6*cos(u)*(sin(u)-1), 0, 14*sin(u)],
                          4 - 2*cos(u), u = -PI..PI):
C := plot::ClippingBox(-15..15, -10..10, -20.. a,
```

```
plot(KleinBottle, C, Axes = None):  
    a = 15 .. -20):
```

```
delete KleinBottle, C:
```

## Parameters

**$x_{\min}$ ,  $x_{\max}$**

The borders of the visible range of the x coordinate: numerical real values or arithmetical expressions (Symbolic Math Toolbox) of the animation parameter **a**.

$x_{\min}$ ,  $x_{\max}$  are equivalent to the attributes XMin, XMax.

**$y_{\min}$ ,  $y_{\max}$**

The borders of the visible range of the y coordinate: numerical real values or arithmetical expressions (Symbolic Math Toolbox) of the animation parameter **a**.

$y_{\min}$ ,  $y_{\max}$  are equivalent to the attributes YMin, YMax.

**$z_{\min}$ ,  $z_{\max}$** 

The borders of the visible range of the  $z$  coordinate: numerical real values or arithmetical expressions (Symbolic Math Toolbox) of the animation parameter  $a$ .

$z_{\min}$ ,  $z_{\max}$  are equivalent to the attributes `ZMin`, `ZMax`.

 **$a$** 

Animation parameter, specified as  $a = a_{\min} \dots a_{\max}$ , where  $a_{\min}$  is the initial parameter value, and  $a_{\max}$  is the final parameter value.

## See Also

**MuPAD Functions**

`plot` | `plot::copy`

**MuPAD Graphical Primitives**

`plot::CoordinateSystem3d`

## plot::Reflect2d

Reflection about a 2D point or a line

### Syntax

```
plot::Reflect2d([x1, y1], <[x2, y2>, obj1, obj2, ..., <a = amin .. amax>, options)
```

### Description

`plot::Reflect2d([x1, y1], object)` reflects a 2D object about the point (x<sub>1</sub>, y<sub>1</sub>).

`plot::Reflect2d([x1, y1], [x2, y2], object)` reflects a 2D object about the line through the points (x<sub>1</sub>, y<sub>1</sub>) and (x<sub>2</sub>, y<sub>2</sub>).

Reflections in 2D are transformation objects on page 24-1134 that mirror their contents about a straight line. In the degenerate case where both points on the line coincide or if only one point is specified, they reflect about a point.

Like all transformation objects, reflections can contain any number of objects of the appropriate dimension. Plotting the reflection object renders the reflections of all graphical objects inside.

Reflections can be animated. If the contained objects are animated, too, the animations will run simultaneously.

Animated reflection objects are rather “cheap” concerning computing and storing costs. For more complex graphical objects, it is more efficient to use an animated reflection object than to redefine the object for each frame.

### Attributes

Attribute	Purpose	Default Value
AffectViewingBox	influence of objects on the ViewingBox of a scene	TRUE

<b>Attribute</b>	<b>Purpose</b>	<b>Default Value</b>
Frames	the number of frames in an animation	50
From	starting point of arrows and lines	
FromX	starting point of arrows and lines, x-coordinate	
FromY	starting point of arrows and lines, y-coordinate	
Name	the name of a plot object (for browser and legend)	
ParameterEnd	end value of the animation parameter	
ParameterName	name of the animation parameter	
ParameterBegin	initial value of the animation parameter	
ParameterRange	range of the animation parameter	
TimeEnd	end time of the animation	10.0
TimeBegin	start time of the animation	0.0
TimeRange	the real time span of an animation	0.0 .. 10.0
To	end point of arrows and lines	
ToX	end point of arrows and lines, x-coordinate	
ToY	end point of arrows and lines, y-coordinate	

## Examples

### Example 1

Plot the reflection of a function graph about the origin:

```
plot(plot::Reflect2d([0, 0],  
                    plot::Function2d(x^2, x=-2..2)))
```

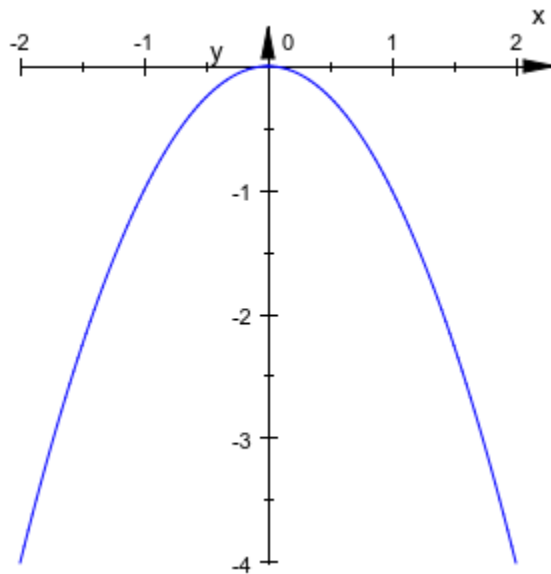

Reflecting a function about the main diagonal (the line through the origin and the point (1, 1)) shows the (multivalued) inverse function:

```
plot(plot::Reflect2d([0, 0], [1, 1],  
                    plot::Function2d(x^2, x=-2..2)))
```

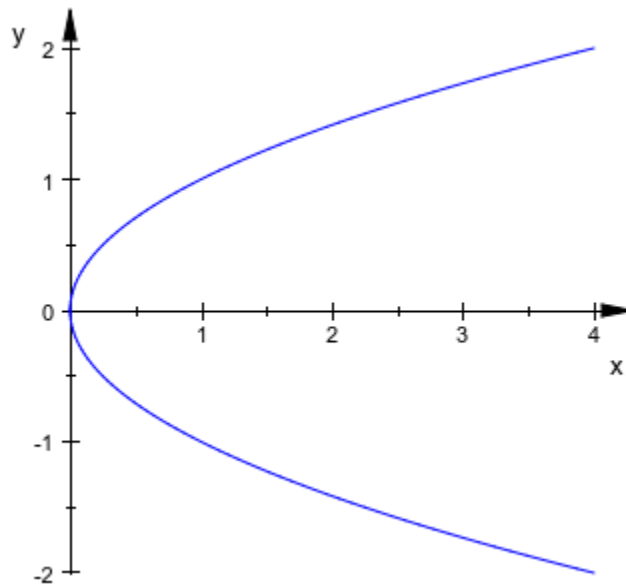

To display both an object and its mirror image, assign the object to some variable and plot both:

```
f := plot::Function2d(x^2, x=-2..2, LineWidth = 0.5):  
plot(f, plot::Reflect2d([0, 0], [1, 1], f))
```

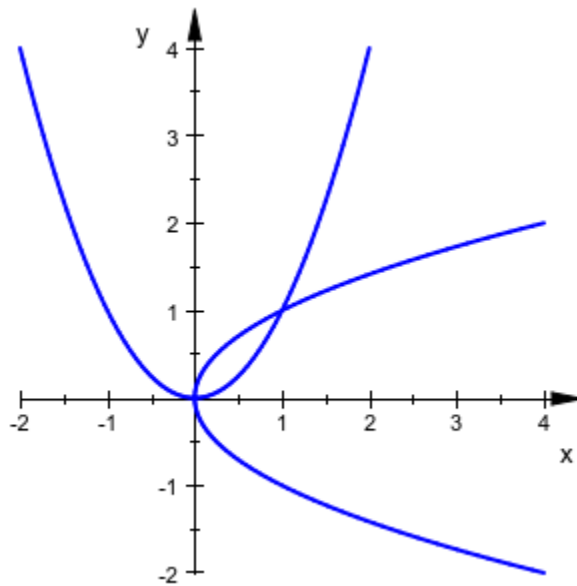

The following command shows two more useful variations. First, use `plot::Line2d` to display the line of reflection. Then, use `plot::modify` to change the line color of the mirrored function graph:

```
g := plot::Line2d([0, 0], [1, 1],
                  Color = RGB::Red,
                  LineStyle = Dashed,
                  Extension = Infinite):
f1 := plot::Reflect2d([0, 0], [1, 1],
                     plot::modify(f, LineColor = RGB::Green)):
plot(f, g, f1)
```



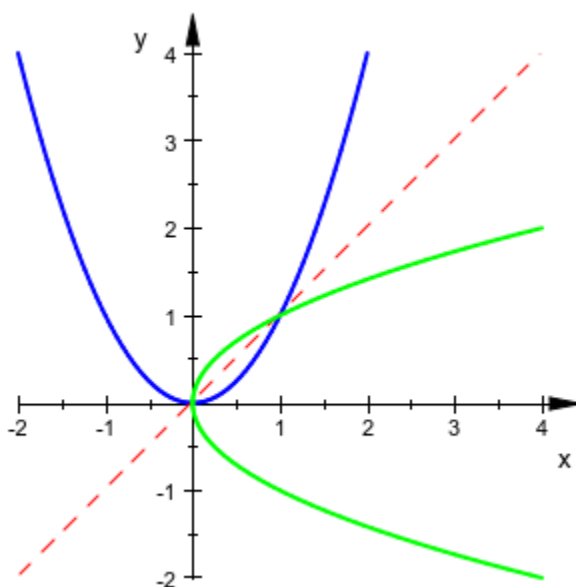

## Parameters

**$x_1, y_1, x_2, y_2$**

The coordinates of two points on a line: real numerical values or arithmetical expressions (Symbolic Math Toolbox) of the animation parameter  $a$ .

$x_1, y_1, x_2, y_2$  are equivalent to the attributes From, To, FromX, FromY, ToX, ToY.

**obj1, obj2, ...**

Plot objects

**a**

Animation parameter, specified as  $a = a_{\min} \dots a_{\max}$ , where  $a_{\min}$  is the initial parameter value, and  $a_{\max}$  is the final parameter value.

## See Also

### **MuPAD Functions**

`plot` | `plot::copy`

### **MuPAD Graphical Primitives**

`plot::Line2d` | `plot::Plane` | `plot::Reflect3d` | `plot::Transform2d` |  
`plot::Transform3d`

# plot::Reflect3d

Reflection about a 3D point or a plane

## Syntax

```
plot::Reflect3d([x, y, z], <[nx, ny, nz]>, obj1, obj2, ..., <a = amin .. amax>, options)
```

## Description

`plot::Reflect3d([x, y, z], object)` reflects a 3D object about the point (x, y, z).

`plot::Reflect3d([x, y, z], [nx, ny, nz], object)` reflects a 3D object about the plane through the point (x, y, z) with normal (n<sub>x</sub>, n<sub>y</sub>, n<sub>z</sub>).

Reflections in 3D are transformation objects on page 24-1134 that mirror their contents about a plane. In the degenerate case where the normal vector is given as [0, 0, 0] or if only one point is specified, they reflect about a point.

Like all transformation objects, reflections can contain any number of objects of the appropriate dimension. Plotting the reflection object renders the reflections of all graphical objects inside.

Reflections can be animated. If the contained objects are animated, too, the animations will run simultaneously.

Animated reflection objects are rather “cheap” concerning computing and storing costs. For more complex graphical objects, it is more efficient to use an animated reflection object than to redefine the object for each frame.

## Attributes

Attribute	Purpose	Default Value
AffectViewingBox	influence of objects on the ViewingBox of a scene	TRUE
Frames	the number of frames in an animation	50
Name	the name of a plot object (for browser and legend)	
Normal	normal vector of circles and discs, etc. in 3D	[0, 0, 1]
NormalX	normal vector of circles and discs, etc. in 3D, x-component	0
NormalY	normal vector of circles and discs, etc. in 3D, y-component	0
NormalZ	normal vector of circles and discs, etc. in 3D, z-component	1
ParameterEnd	end value of the animation parameter	
ParameterName	name of the animation parameter	
ParameterBegin	initial value of the animation parameter	
ParameterRange	range of the animation parameter	
Position	positions of cameras, lights, and text objects	[0, 0, 0]
PositionX	x-positions of cameras, lights, and text objects	0
PositionY	y-positions of cameras, lights, and text objects	0

Attribute	Purpose	Default Value
PositionZ	z-positions of cameras, lights, and text objects	0
TimeEnd	end time of the animation	10.0
TimeBegin	start time of the animation	0.0
TimeRange	the real time span of an animation	0.0 .. 10.0

## Examples

### Example 1

Plot a 3D function graph and its reflection about the point (0, 0, 2):

```
f := plot::Function3d(sin(cos(x) - cos(y)), x = 0..PI, y = -2..5):
p := plot::Point3d([0, 0, 2], PointSize=2):
plot(f, plot::Reflect3d([0, 0, 2], f), p,
     CameraDirection=[30, -50, 20])
```

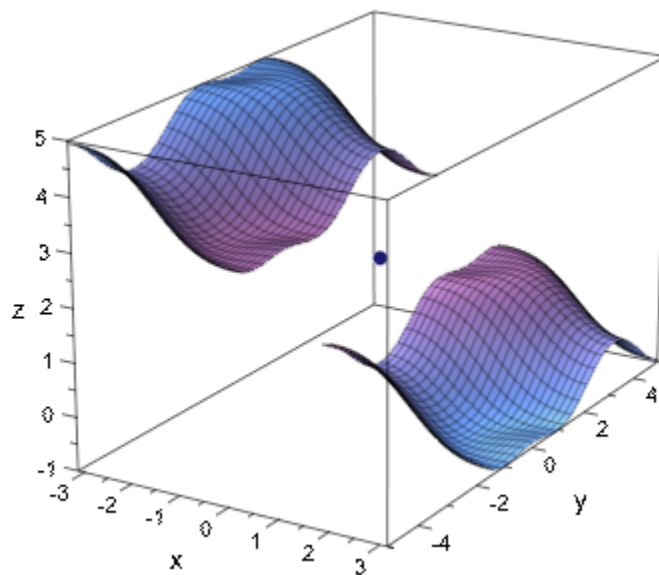

Plot the same function graph and its reflection at a plane through the point  $(0, 0, 2)$  with an animated normal vector:

```
pl := plot::Plane([0, 0, 2], [a, 0, 1-a], a=0..1, Color=RGB::Green.[0.5]):  
plot(f, plot::Reflect3d([0, 0, 2], [a, 0, 1-a], a=0..1, f), p, pl,  
      CameraDirection=[30, -50, 20])
```

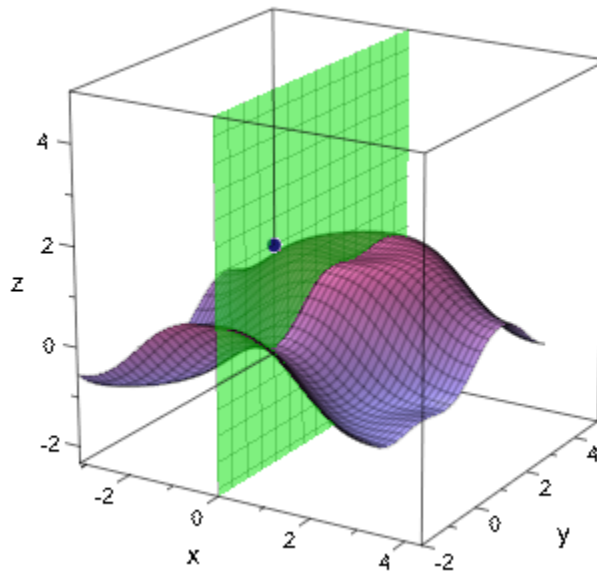

## Parameters

### **x, y, z**

The coordinates of the mirror point or a point on the mirror plane, respectively: real numerical values or arithmetical expressions (Symbolic Math Toolbox) of the animation parameter  $a$ .

$x$ ,  $y$ ,  $z$  are equivalent to the attributes `Position`, `PositionX`, `PositionY`, `PositionZ`.

### **$n_x$ , $n_y$ , $n_z$**

The coordinates of the normal of the mirror plane: real numerical values or arithmetical expressions (Symbolic Math Toolbox) of the animation parameter  $a$ .

$n_x$ ,  $n_y$ ,  $n_z$  are equivalent to the attributes `Normal`, `NormalX`, `NormalY`, `NormalZ`.

### **obj1, obj2, ...**

Plot objects

**a**

Animation parameter, specified as  $a = a_{\min} \dots a_{\max}$ , where  $a_{\min}$  is the initial parameter value, and  $a_{\max}$  is the final parameter value.

## See Also

**MuPAD Functions**

`plot` | `plot::copy`

**MuPAD Graphical Primitives**

`plot::Line2d` | `plot::Plane` | `plot::Reflect2d` | `plot::Transform2d` |  
`plot::Transform3d`



# plot::Rotate2d

Rotations of 2D objects

## Syntax

```
plot::Rotate2d(angle, <[cx, cy]>, obj1, <obj2, ...>, <a = amin .. amax>, options)
```

## Description

`plot::Rotate2d(angle, [cx, cy], object)` rotates a 2D object counterclockwise by the given angle around the rotation center [c<sub>x</sub>, c<sub>y</sub>]. To rotate clock wise, use negative angles.

Rotate objects can rotate several graphical objects simultaneously. Plotting the rotate object renders all graphical objects inside.

Rotated objects have a tendency to overestimate their `ViewingBox`. See the help page of `ViewingBox`. In such cases, specify a suitable `ViewingBox` explicitly.

Transformation objects can be used inside rotate objects. If they are animated, the animations run simultaneously.

Animated rotate objects are rather “cheap” concerning computing and storing costs. For more complex graphical objects, it is more efficient to use an animated rotate object than to redefine the object for each frame.

The function `op` allows to extract the graphical objects inside a rotate object.

## Attributes

Attribute	Purpose	Default Value
<code>AffectViewingBox</code>	influence of objects on the <code>ViewingBox</code> of a scene	TRUE

Attribute	Purpose	Default Value
Angle	rotation angle	0
Center	center of objects, rotation center	[0, 0]
CenterX	center of objects, rotation center, x-component	0
CenterY	center of objects, rotation center, y-component	0
Frames	the number of frames in an animation	50
Name	the name of a plot object (for browser and legend)	
ParameterEnd	end value of the animation parameter	
ParameterName	name of the animation parameter	
ParameterBegin	initial value of the animation parameter	
ParameterRange	range of the animation parameter	
TimeEnd	end time of the animation	10.0
TimeBegin	start time of the animation	0.0
TimeRange	the real time span of an animation	0.0 .. 10.0

## Examples

### Example 1

Ellipses of type `plot::Ellipse2d` have symmetry axes parallel to the coordinate axes. You can use `plot::Rotate2d` to obtain ellipses with other orientations:

```
e0 := plot::Ellipse2d(3, 1, [0, 0]):
e1 := plot::Rotate2d(PI/4, [0, 0], e0):
```

```
e2 := plot::Rotate2d(-PI/4, [0, 0], e0):
plot(e0, e1, e2):
```

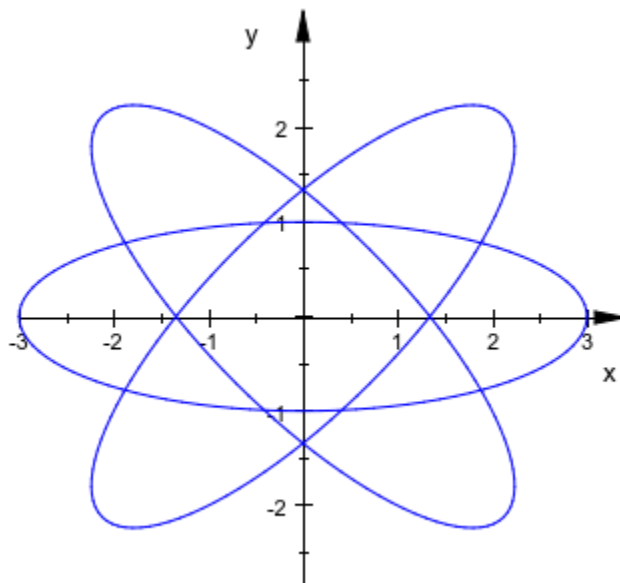

```
delete e0, e1, e2
```

## Example 2

Plot several copies of a function plot, rotated by different angles:

```
f := plot::Function2d(sin(x^3)/(x^2+1), x = -5..5, Mesh = 300):
plot(plot::Rotate2d(f, Angle = PI/11*a) $ a = 0..10):
```

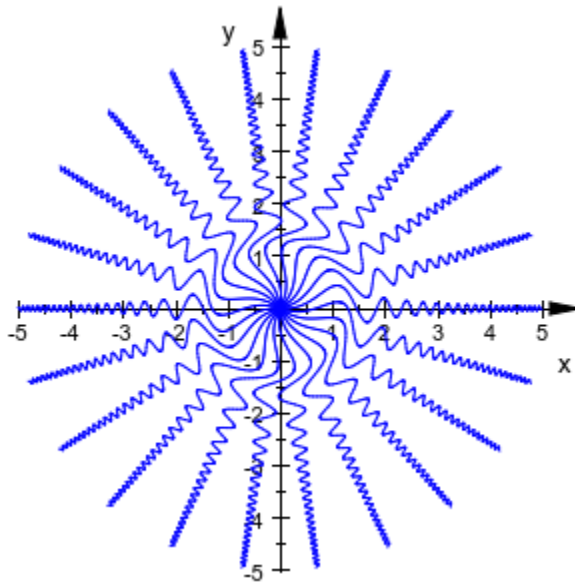

delete f

### Example 3

Plot turning cogs. Each animated rotate object rotates a curve and a line simultaneously:

```

r1 := 2: x1 := -r1: y1:= 0:
r2 := 1: x2 :=  r2: y2:= 0:
dr := 0.2:
cog1 := plot::Curve2d([x1 + (r1 + dr*cos(36*u))*cos(u),
                      y1 + (r1 + dr*cos(36*u))*sin(u)],
                      u = 0..2*PI, Mesh = 360):
cog2 := plot::Curve2d([x2 + (r2 - dr*cos(18*u))*cos(u),
                      y2 + (r2 - dr*cos(18*u))*sin(u)],
                      u = 0..2*PI, Mesh = 360):
line1 := plot::Line2d([x1, y1], [x1 + r1 + dr, y1],
                      Color = RGB::Red):
line2 := plot::Line2d([x2, y2], [x2 - r2 + dr, y2],
                      Color = RGB::Red):
Cog1 := plot::Rotate2d(-a, [x1, y1], cog1, line1,
                      a = 0..2*PI, Frames = 180):
Cog2 := plot::Rotate2d(2*a, [x2, y2], cog2, line2,

```

```

a = 0..2*PI, Frames = 180):
plot(Cog1, Cog2, Scaling = Constrained):

```

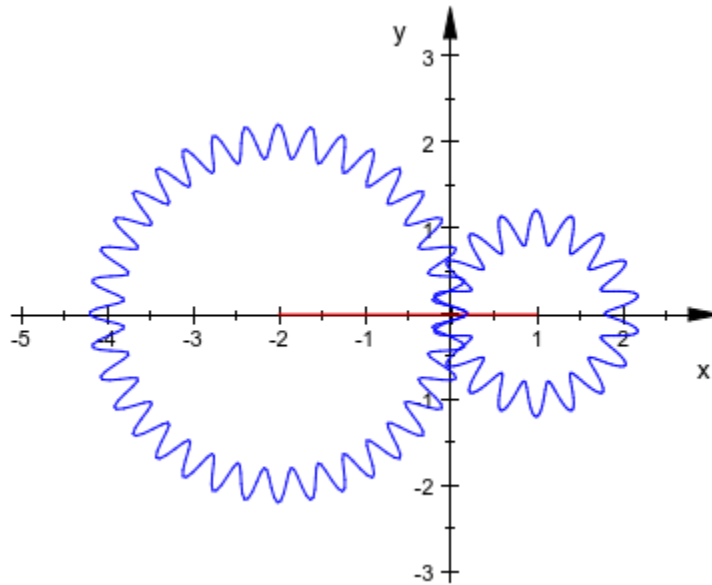

```

delete r1, x1, y1, r2, x2, y2, dr, cog1, cog2,
line1, line2, Cog1, Cog2:

```

## Example 4

Use an animated rotation inside another animated rotation:

```

L1 := plot::Line2d([0, 0], [0, 1]):
L2 := plot::Rotate2d(a, [0, 1], a = 0..2*PI,
plot::Line2d([0, 1], [1, 1])):
plot(plot::Rotate2d(a, [0, 0], L1, L2, a = 0..PI/2)):

```

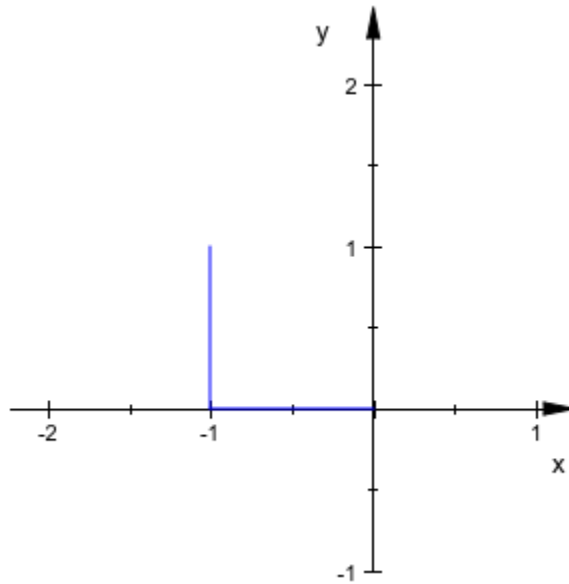

delete L1, L2:

## Parameters

### angle

The rotation angle in radians: a numerical real value or an arithmetical expression (Symbolic Math Toolbox) of the animation parameter  $a$ .

angle is equivalent to the attribute Angle.

### $c_x$ , $c_y$

The components of the rotation center: numerical real values or arithmetical expressions of the animation parameter  $a$ . If no rotation center is specified, the center  $[0, 0]$  is used.

$c_x$ ,  $c_y$  are equivalent to the attributes Center, CenterX, CenterY.

**obj<sub>1</sub>, obj<sub>2</sub>, ...**

Arbitrary plot objects of the appropriate dimension

**a**

Animation parameter, specified as  $a = a_{\min}..a_{\max}$ , where  $a_{\min}$  is the initial parameter value, and  $a_{\max}$  is the final parameter value.

## See Also

### MuPAD Functions

plot | plot::copy

### MuPAD Graphical Primitives

plot::Rotate3d | plot::Scale2d | plot::Scale3d | plot::Transform2d |  
plot::Transform3d | plot::Translate2d | plot::Translate3d

## plot::Rotate3d

Rotations of 3D objects

### Syntax

```
plot::Rotate3d(angle, <[cx, cy, cz], [dx, dy, dz]>, obj1, <obj2, ...>, <a = amin .. amax>, op
```

### Description

`plot::Rotate3d(angle, [cx, cy, cz], [dx, dy, dz], object)` rotates a 3D object by the given angle around the rotation axis defined by the point [c<sub>x</sub>, c<sub>y</sub>, c<sub>z</sub>] and the direction [d<sub>x</sub>, d<sub>y</sub>, d<sub>z</sub>].

The rotation is implemented following the “right hand rule”: Stretch the thumb of your right hand and bend the fingers. When the thumb points into the direction of the rotation axis, your finger tips indicate the direction of the rotation. Use negative angles to rotate in the opposite direction.

Rotate objects can rotate several graphical objects simultaneously. Plotting the rotate object renders all graphical objects inside.

Rotated objects have a tendency to overestimate their `ViewingBox`. See the help page of `ViewingBox`. In such cases, specify a suitable `ViewingBox` explicitly.

Transformation objects can be used inside rotate objects. If they are animated, the animations run simultaneously.

Animated rotate objects are rather “cheap” concerning computing and storing costs. For more complex graphical objects, it is more efficient to use an animated rotate object than to redefine the object for each frame.

The function `op` allows to extract the graphical objects inside a rotate object.



## Attributes

Attribute	Purpose	Default Value
AffectViewingBox	influence of objects on the ViewingBox of a scene	TRUE
Angle	rotation angle	0
Axis	rotation axis	[0, 0, 1]
AxisX	x-component of rotation axis	0
AxisY	y-component of rotation axis	0
AxisZ	z-component of rotation axis	1
Center	center of objects, rotation center	[0, 0, 0]
CenterX	center of objects, rotation center, x-component	0
CenterY	center of objects, rotation center, y-component	0
CenterZ	center of objects, rotation center, z-component	0
Frames	the number of frames in an animation	50
Name	the name of a plot object (for browser and legend)	
ParameterEnd	end value of the animation parameter	
ParameterName	name of the animation parameter	
ParameterBegin	initial value of the animation parameter	
ParameterRange	range of the animation parameter	
TimeEnd	end time of the animation	10.0
TimeBegin	start time of the animation	0.0

Attribute	Purpose	Default Value
TimeRange	the real time span of an animation	0.0 .. 10.0

## Examples

### Example 1

3D boxes with arbitrary orientation can be generated via `plot::Rotate3d`. Use several animated rotation objects:

```

b0 := plot::Box(-3..3, -2..2, -1..1):
b1 := plot::Rotate3d(a, [0, 0, 0], [0, 0, 1], b0,
    a = 0..PI/2, TimeRange = 0..3):
b2 := plot::Rotate3d(a, [0, 0, 0], [0, 1, 0], b1,
    a = 0..PI/2, TimeRange = 3..6):
b3 := plot::Rotate3d(a, [0, 0, 0], [1, 0, 0], b2,
    a = 0..PI/2, TimeRange = 6..9):
plot(b0, b3):

```

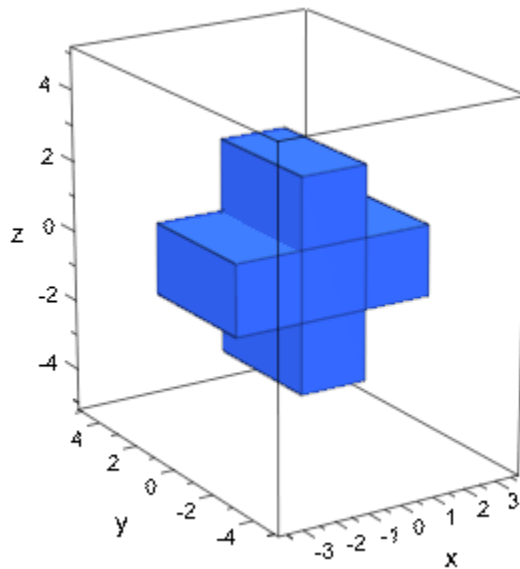

delete b0, b1, b2, b3

## Parameters

### angle

The rotation angle in radians: a numerical real value or an arithmetical expression (Symbolic Math Toolbox) of the animation parameter  $a$ .

angle is equivalent to the attribute Angle.

### $c_x$ , $c_y$ , $c_z$

The components of the rotation center: numerical real values or arithmetical expressions of the animation parameter  $a$ . If no rotation center is specified, the center  $[0, 0, 0]$  is used.

$c_x$ ,  $c_y$ ,  $c_z$  are equivalent to the attributes Center, CenterX, CenterY, CenterZ.

### $d_x$ , $d_y$ , $d_z$

The components of the direction of the rotations axis: numerical real values or arithmetical expressions of the animation parameter  $a$ . If no direction is specified, the direction  $[0, 0, 1]$  is used.

$d_x$ ,  $d_y$ ,  $d_z$  are equivalent to the attributes Axis, AxisX, AxisY, AxisZ.

### obj<sub>1</sub>, obj<sub>2</sub>, ...

Arbitrary plot objects of the appropriate dimension

### a

Animation parameter, specified as  $a = a_{\min} \cdot a_{\max}$ , where  $a_{\min}$  is the initial parameter value, and  $a_{\max}$  is the final parameter value.

## See Also

### MuPAD Functions

plot | plot::copy

**MuPAD Graphical Primitives**

`plot::Rotate2d | plot::Scale2d | plot::Scale3d | plot::Transform2d |  
plot::Transform3d | plot::Translate2d | plot::Translate3d`

# plot::Scale2d

Scaling of 2D objects

## Syntax

```
plot::Scale2d([sx, sy], obj1, <obj2, ...>, <a = amin .. amax>, options)
```

## Description

`plot::Scale2d([sx, sy], objects)` applies the scaling transformation  $x \rightarrow Ax$  with the diagonal matrix  $A = \text{diag}(s_x, s_y)$  to 2D objects.

Scale objects can scale several graphical objects simultaneously. Plotting the scale object renders all graphical objects inside.

Transformation objects can be used inside scale objects. If they are animated, the animations run simultaneously.

Animated scale objects are rather “cheap” concerning computing and storing costs. For more complex graphical objects, it is more efficient to use an animated scale object than to redefine the object for each frame.

The function `op` allows to extract the graphical objects inside a scale object.

## Attributes

Attribute	Purpose	Default Value
AffectViewingBox	influence of objects on the ViewingBox of a scene	TRUE
Frames	the number of frames in an animation	50

Attribute	Purpose	Default Value
Name	the name of a plot object (for browser and legend)	
ParameterEnd	end value of the animation parameter	
ParameterName	name of the animation parameter	
ParameterBegin	initial value of the animation parameter	
ParameterRange	range of the animation parameter	
Scale	scaling factors	[1, 1]
ScaleX	scaling factor in x-direction	1
ScaleY	scaling factor in y-direction	1
TimeEnd	end time of the animation	10.0
TimeBegin	start time of the animation	0.0
TimeRange	the real time span of an animation	0.0 .. 10.0

## Examples

### Example 1

A scaling transformation turns a circle into an ellipse:

```
plot(plot::Scale2d([1 + 3*a, 1 + a],  
                 plot::Circle2d(1),  
                 a = 0..1))
```

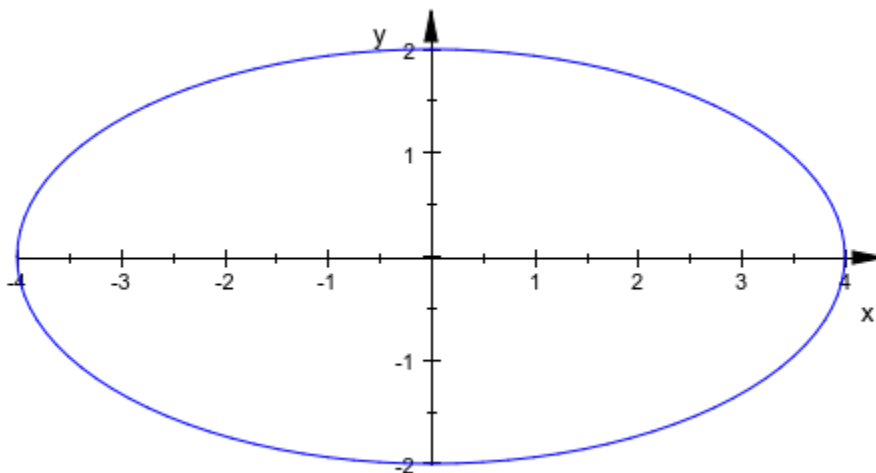

## Parameters

**$s_x$ ,  $s_y$**

The scaling factors: numerical real values or arithmetical expressions (Symbolic Math Toolbox) of the animation parameter  $a$ .

$s_x$ ,  $s_y$  are equivalent to the attributes `Scale`, `ScaleX`, `ScaleY`.

**$obj_1$ ,  $obj_2$ , ...**

Arbitrary plot objects of the appropriate dimension

**$a$**

Animation parameter, specified as  $a = a_{\min} \dots a_{\max}$ , where  $a_{\min}$  is the initial parameter value, and  $a_{\max}$  is the final parameter value.

## See Also

### **MuPAD Functions**

`plot` | `plot::copy`

### **MuPAD Graphical Primitives**

`plot::Rotate2d` | `plot::Rotate3d` | `plot::Scale3d` | `plot::Transform2d` |  
`plot::Transform3d` | `plot::Translate2d` | `plot::Translate3d`



# plot::Scale3d

Scaling of 3D objects

## Syntax

```
plot::Scale3d([sx, sy, sz], obj1, <obj2, ...>, <a = amin .. amax>, options)
```

## Description

`plot::Scale3d([sx, sy, sz], objects)` applies the scaling transformation  $x \rightarrow Ax$  with the diagonal matrix  $A = \text{diag}(s_x, s_y, s_z)$  to 3D objects.

Scale objects can scale several graphical objects simultaneously. Plotting the scale object renders all graphical objects inside.

Transformation objects can be used inside scale objects. If they are animated, the animations run simultaneously.

Animated scale objects are rather “cheap” concerning computing and storing costs. For more complex graphical objects, it is more efficient to use an animated scale object than to redefine the object for each frame.

The function `op` allows to extract the graphical objects inside a scale object.

## Attributes

Attribute	Purpose	Default Value
AffectViewingBox	influence of objects on the ViewingBox of a scene	TRUE
Frames	the number of frames in an animation	50

Attribute	Purpose	Default Value
Name	the name of a plot object (for browser and legend)	
ParameterEnd	end value of the animation parameter	
ParameterName	name of the animation parameter	
ParameterBegin	initial value of the animation parameter	
ParameterRange	range of the animation parameter	
Scale	scaling factors	[1, 1, 1]
ScaleX	scaling factor in x-direction	1
ScaleY	scaling factor in y-direction	1
ScaleZ	scaling factor in z-direction	1
TimeEnd	end time of the animation	10.0
TimeBegin	start time of the animation	0.0
TimeRange	the real time span of an animation	0.0 .. 10.0

## Examples

### Example 1

A scaling transformation turns a sphere into an ellipsoid:

```
plot(plot::Scale3d([1 + 3*a, 1 + 2*a, 1 + a],  
                  plot::Sphere(1, [0, 0, 0]),  
                  a = 0..1))
```

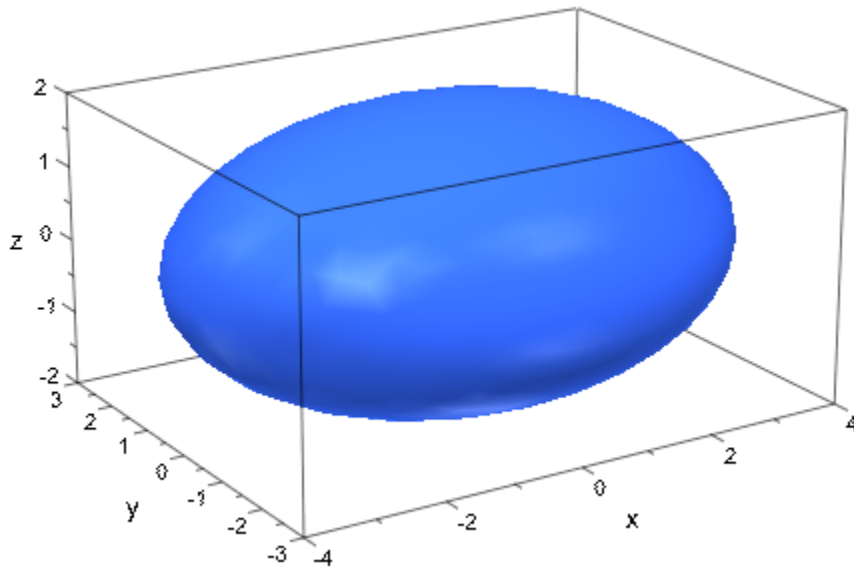

Plot a (southern) hemisphere and two scaled copies:

```
A0 := plot::Spherical([1, u, v], u = 0..2*PI, v = PI/2 .. PI):  
A1 := plot::Scale3d([0.5, 0.4, 0.5], A0):  
A2 := plot::Scale3d([0.2, 0.3, 0.2], A0):  
plot(A0, A1, A2, CameraDirection = [-1, -2, 2.5]):
```

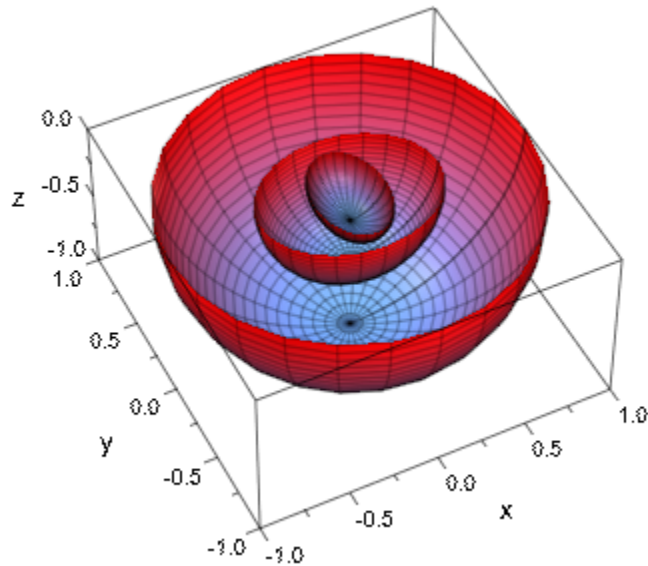

delete A0, A1, A2:

## Parameters

**$s_x, s_y, s_z$**

The scaling factors: numerical real values or arithmetical expressions (Symbolic Math Toolbox) of the animation parameter  $a$ .

$s_x, s_y, s_z$  are equivalent to the attributes Scale, ScaleX, ScaleY, ScaleZ.

**$obj_1, obj_2, \dots$**

Arbitrary plot objects of the appropriate dimension

**$a$**

Animation parameter, specified as  $a = a_{min} \dots a_{max}$ , where  $a_{min}$  is the initial parameter value, and  $a_{max}$  is the final parameter value.

## See Also

### **MuPAD Functions**

plot | plot::copy

### **MuPAD Graphical Primitives**

plot::Rotate2d | plot::Rotate3d | plot::Scale2d | plot::Transform2d |  
plot::Transform3d | plot::Translate2d | plot::Translate3d

## plot::Transform2d

Affine linear transformation of 2D objects

### Syntax

```
plot::Transform2d(<b2d>, A2d, obj1, <obj2, ...>, <a = amin .. amax>, options)
```

### Description

`plot::Transform2d(b, A, objects)` with a vector  $b$  and a matrix  $A$  applies the affine linear transformation  $x \rightarrow Ax + b$  to 2D objects.

The transformation matrix  $A$  can be specified by a list of lists, with the sublists representing the rows.

```
[[A1, 1, A1, 2, ...], [A2, 1, A2, 2, ...], ...]
```

A plain list  $[A_{1, 1}, A_{1, 2}, A_{2, 1}, A_{2, 2}]$  represents the matrix row by row.

Transform objects can transform several graphical objects simultaneously. Plotting the transform object renders all graphical objects inside.

Transformed objects have a tendency to overestimate their `ViewingBox`. In such cases, specify a suitable `ViewingBox` explicitly.

Transformation objects can be used inside transformation objects. If they are animated, the animations run simultaneously.

Animated transform objects are rather “cheap” concerning computing and storing costs. For more complex graphical objects, it is more efficient to use an animated transform object than to redefine the object for each frame.

The function `op` allows to extract the graphical objects inside a transformation object.

## Attributes

Attribute	Purpose	Default Value
AffectViewingBox	influence of objects on the ViewingBox of a scene	TRUE
Frames	the number of frames in an animation	50
Matrix2d	transformation matrices	[1, 0, 0, 1]
Name	the name of a plot object (for browser and legend)	
ParameterEnd	end value of the animation parameter	
ParameterName	name of the animation parameter	
ParameterBegin	initial value of the animation parameter	
ParameterRange	range of the animation parameter	
Shift	shift vector	[0, 0]
ShiftX	shift vector	0
ShiftY	shift vector	0
TimeEnd	end time of the animation	10.0
TimeBegin	start time of the animation	0.0
TimeRange	the real time span of an animation	0.0 .. 10.0

## Examples

### Example 1

Visualize a linear transformation  $x \rightarrow Ax$  without shift:

```

x1 := plot::Arrow2d([0, 0], [1/3, 1], Color = RGB::Red):
x2 := plot::Arrow2d([0, 0], [1, 1], Color = RGB::Green):
x3 := plot::Arrow2d([0, 0], [1, 1/3], Color = RGB::Blue):
A := matrix([[1, -2], [-2, 1]]):
plot(plot::Scene2d(x1, x2, x3),
      plot::Scene2d(plot::Transform2d(A, x1, x2, x3)),
      Scaling = Constrained, Layout = Horizontal):

```

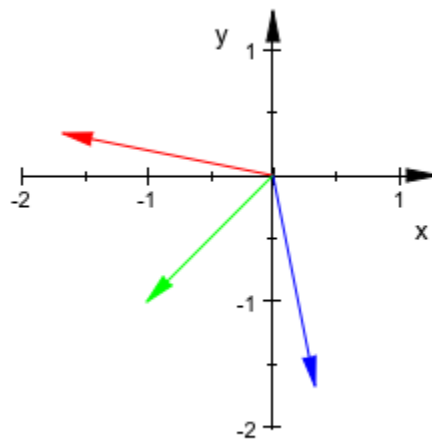
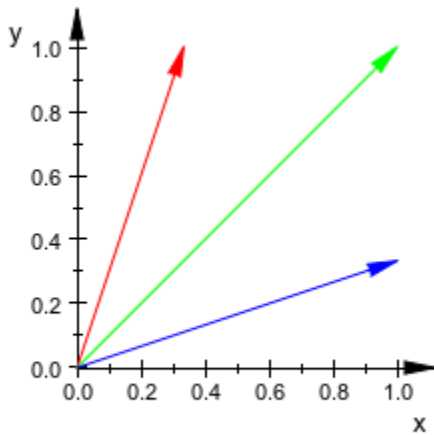

delete x1, x2, x3, A:

## Parameters

$\mathbf{b}_{2d}$

The 2D shift vector: a list with 2 entries. Also vectors generated by `matrix` and arrays on page 7-2 are accepted. The entries must be numerical values or arithmetical expressions (Symbolic Math Toolbox) of the animation parameter `a`.

$\mathbf{b}_{2d}$  is equivalent to the attribute `Shift`.



**A<sub>2d</sub>**

The 2D transformation matrix: a  $2 \times 2$  matrix, a  $2 \times 2$  array, a list of 2 lists, or a plain list with 4 entries. The entries must be numerical values or arithmetical expressions (Symbolic Math Toolbox) of the animation parameter  $a$ .

$A_{2d}$  is equivalent to the attribute `Matrix2d`.

**obj1, obj2, ...**

Plot objects

**a**

Animation parameter, specified as  $a = a_{\min} \dots a_{\max}$ , where  $a_{\min}$  is the initial parameter value, and  $a_{\max}$  is the final parameter value.

## See Also

**MuPAD Functions**

`plot` | `plot::copy`

**MuPAD Graphical Primitives**

`plot::Rotate2d` | `plot::Rotate3d` | `plot::Scale2d` | `plot::Scale3d` |  
`plot::Transform3d` | `plot::Translate2d` | `plot::Translate3d`

## plot::Transform3d

Affine linear transformation of 3D objects

### Syntax

```
plot::Transform3d(<b3d>, A3d, obj1, <obj2, ...>, <a = amin .. amax>, options)
```

### Description

`plot::Transform3d(b, A, objects)` with a vector  $b$  and a matrix  $A$  applies the affine linear transformation  $x \rightarrow Ax + b$  to 3D objects.

The transformation matrix  $A$  may be specified by a list of lists, with the sublists representing the rows:

```
[[A1, 1, A1, 2, ...], [A2, 1, A2, 2, ...], ...]
```

A plain list  $[A_{1, 1}, A_{1, 2}, \dots, A_{3, 2}, A_{3, 3}]$  represents the matrix row by row.

Transform objects can transform several graphical objects simultaneously. Plotting the transform object renders all graphical objects inside.

Transformed objects have a tendency to overestimate their `ViewingBox`. In such cases, specify a suitable `ViewingBox` explicitly.

Transformation objects can be used inside transformation objects. If they are animated, the animations run simultaneously.

Animated transform objects are rather “cheap” concerning computing and storing costs. For more complex graphical objects, it is more efficient to use an animated transform object than to redefine the object for each frame.

The function `op` allows to extract the graphical objects inside a transformation object.

## Attributes

Attribute	Purpose	Default Value
AffectViewingBox	influence of objects on the ViewingBox of a scene	TRUE
Frames	the number of frames in an animation	50
Matrix3d	transformation matrices	[1, 0, 0, 0, 1, 0, 0, 0, 1]
Name	the name of a plot object (for browser and legend)	
ParameterEnd	end value of the animation parameter	
ParameterName	name of the animation parameter	
ParameterBegin	initial value of the animation parameter	
ParameterRange	range of the animation parameter	
Shift	shift vector	[0, 0, 0]
ShiftX	shift vector	0
ShiftY	shift vector	0
ShiftZ	shift vector	0
TimeEnd	end time of the animation	10.0
TimeBegin	start time of the animation	0.0
TimeRange	the real time span of an animation	0.0 .. 10.0

## Examples

### Example 1

For some applications, it is very popular to plot a function in 3D together with a projection of its contour lines onto the lower or upper bounding plane. MuPAD has no direct option for this, but with `plot::Transform3d`, it is possible to achieve the same effect. Suppose that you have the function under consideration in a `plot::Function3d` object:

```
f := plot::Function3d(sin(x*y)+cos(x^2-y),
                      x=-3..3, y=-3..3, Submesh=[1,1]):
```

To plot contour lines at all, use the attribute `ZContours`. To avoid changing `f`, create a modified *copy* using `plot::modify`:

```
plot(plot::modify(f, ZContours = [Automatic, 10]))
```

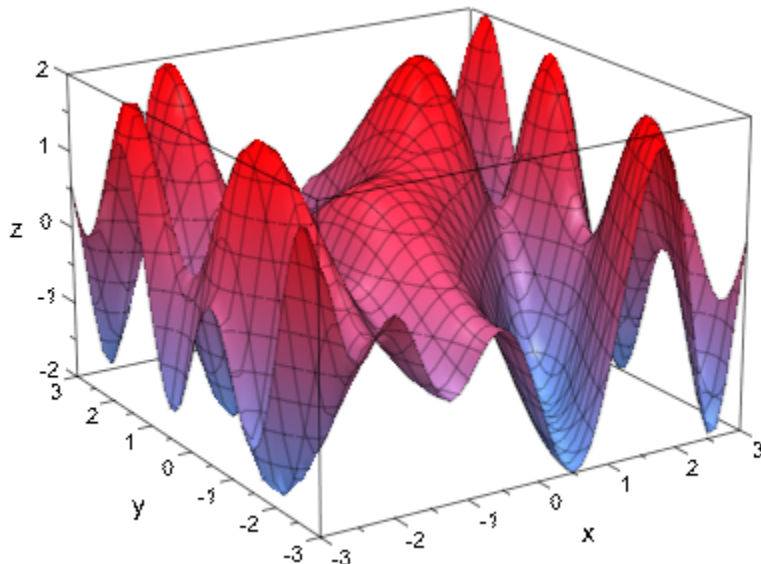

To only get contour lines, change a few more parameters: switch off the surface and the parameter lines. Then, add height coloring to the lines and use `plot::Transform3d` to

*project* them onto the plane  $z = -2.5$ . Finally, plot these lines together with the original function:

```
plot(f,  
      plot::Transform3d([0, 0, -2.5], // shift vector  
                        [1, 0, 0, // transformation matrix  
                          0, 1, 0,  
                          0, 0, 0],  
      plot::modify(f,  
                   Filled = FALSE,  
                   XLinesVisible = FALSE, YLinesVisible = FALSE,  
                   ZContours = [Automatic, 10],  
                   LineColorFunction = // height coloring  
                   ((x, y, z) -> [(z+2)/4, 0, (2-z)/4])))
```

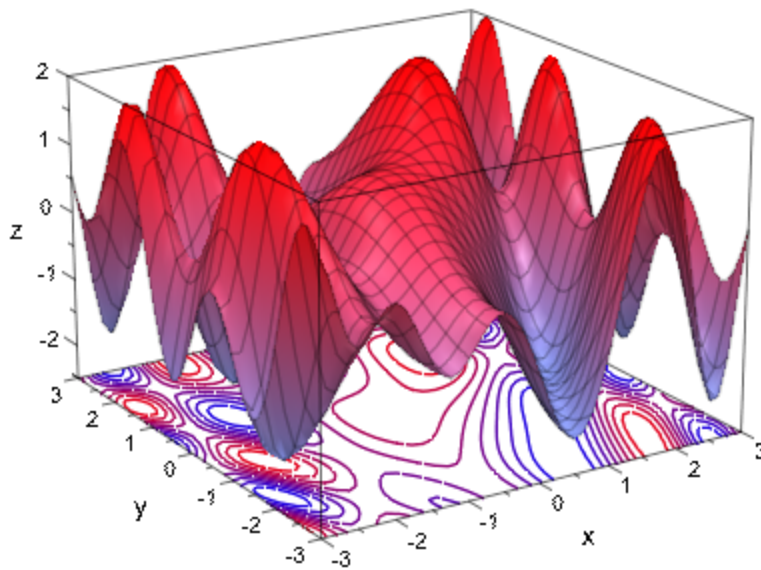

## Parameters

**$b_{3d}$**

The 3D shift vector: a list with 3 entries. Also vectors generated by `matrix` or arrays on page 7-2 are accepted. The entries must be numerical values or arithmetical expressions (Symbolic Math Toolbox) of the animation parameter `a`.

$b_{3d}$  is equivalent to the attribute `Shift`.

**$A_{3d}$**

The 3D transformation matrix: a  $3 \times 3$  matrix, a  $3 \times 3$  array, a list of 3 lists, or a plain list with 9 entries. The entries must be numerical values or arithmetical expressions (Symbolic Math Toolbox) of the animation parameter `a`.

$A_{3d}$  is equivalent to the attribute `Matrix3d`.

**`obj1, obj2, ...`**

Plot objects

**`a`**

Animation parameter, specified as `a = amin .. amax`, where `amin` is the initial parameter value, and `amax` is the final parameter value.

## See Also

### MuPAD Functions

`plot` | `plot::copy`

### MuPAD Graphical Primitives

`plot::Rotate2d` | `plot::Rotate3d` | `plot::Scale2d` | `plot::Scale3d` |  
`plot::Transform2d` | `plot::Translate2d` | `plot::Translate3d`

# plot::Translate2d

Translation of 2D objects

## Syntax

```
plot::Translate2d([dx, dy], obj1, <obj2, ...>, <a = amin .. amax>, options)
```

## Description

`plot::Translate2d([dx, dy], object)` shifts a 2D object by  $d_x$  units along the  $x$ -axis and  $d_y$  units along the  $y$ -axis.

`plot::Translate2d` can translate several graphical objects simultaneously. Plotting the translate object renders all graphical objects inside.

Transformation objects can be used inside translation objects. If they are animated, the animations run simultaneously.

Animated translate objects are rather “cheap” concerning computing and storing costs. For more complex graphical objects, it is more efficient to use an animated translate object than to redefine the object for each frame.

The function `op` allows to extract the graphical objects inside a translate object.

## Attributes

Attribute	Purpose	Default Value
AffectViewingBox	influence of objects on the ViewingBox of a scene	TRUE
Frames	the number of frames in an animation	50
Name	the name of a plot object (for browser and legend)	

Attribute	Purpose	Default Value
ParameterEnd	end value of the animation parameter	
ParameterName	name of the animation parameter	
ParameterBegin	initial value of the animation parameter	
ParameterRange	range of the animation parameter	
Shift	shift vector	[0, 0]
ShiftX	shift vector	0
ShiftY	shift vector	0
TimeEnd	end time of the animation	10.0
TimeBegin	start time of the animation	0.0
TimeRange	the real time span of an animation	0.0 .. 10.0

## Examples

### Example 1

Use an animated translation object to shift a vector to the tip of another vector:

```
A1 := plot::Arrow2d([0, 0], [2, 1], Color = RGB::Red):
A2 := plot::Arrow2d([0, 0], [2, 3], Color = RGB::Green):
plot(A1, plot::Translate2d([2*a, a], A2, a = 0..1,
    TimeRange = 0..4),
    plot::Arrow2d([0, 0], [4, 4], Color = RGB::Blue,
    VisibleFromTo = 4..6),
    Header = "how to add 2 vectors"):
```



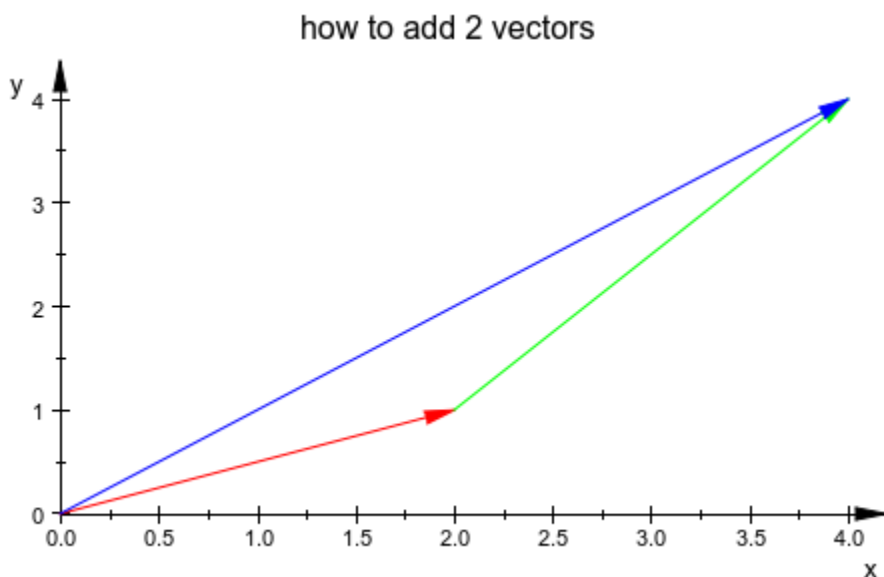

delete A1, A2:

## Example 2

Note that `plot::Translate2d` does not actually change the objects translated, so you can use the same object in different places in the same plot. For example, use the following approach to construct the Sierpinski carpet, a flat version of the Menger sponge.

The Sierpinski carpet is a fractal with the general shape of a square and the property that the following operation maps it onto itself: Take eight copies, scale them by  $\frac{1}{3}$ , and arrange them in a square with the middle left unfilled. Now, this can be directly written in MuPAD code:

```
Carpet := proc(iter)
  local square;
begin
  if iter <= 1 then
    return(plot::Polygon2d([[0,0], [0,1], [1,1], [1,0]],
      Closed, Filled, FillPattern = Solid,
```

```
        FillColor = [0.2234, 0.4563, 0.4568],
        LinesVisible, LineColor = RGB::White,
        Scaling = Constrained, Axes = None));
else
    square := plot::Scale2d([1/3, 1/3], Carpet(iter-1));
    return(plot::Group2d(
        plot::Translate2d([ 0, 0], square),
        plot::Translate2d([ 0, 1/3], square),
        plot::Translate2d([ 0, 2/3], square),
        plot::Translate2d([1/3, 0], square),
        // plot::Translate2d([1/3, 1/3], square),
        plot::Translate2d([1/3, 2/3], square),
        plot::Translate2d([2/3, 0], square),
        plot::Translate2d([2/3, 1/3], square),
        plot::Translate2d([2/3, 2/3], square)));
    end_if;
end_proc;
plot(Carpet(3))
```

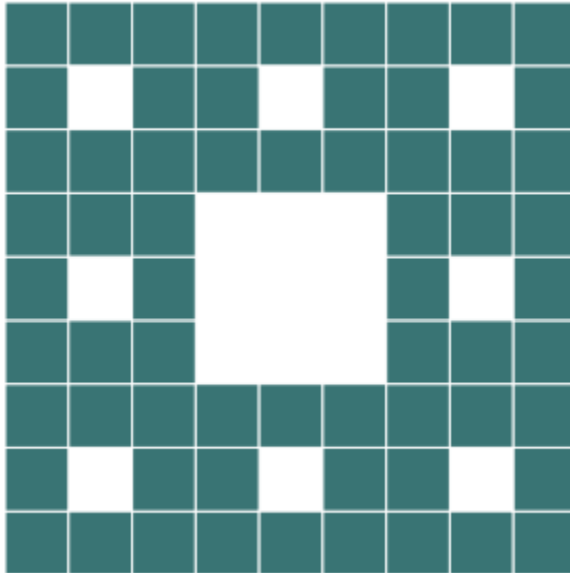

## Parameters

**$d_x$ ,  $d_y$**

The components of the shift vector: numerical real values or arithmetical expressions (Symbolic Math Toolbox) of the animation parameter  $a$ .

$d_x$ ,  $d_y$  are equivalent to the attribute `Shift`.

**$obj_1$ ,  $obj_2$ , ...**

Arbitrary plot objects of the appropriate dimension

**$a$**

Animation parameter, specified as  $a = a_{\min} \cdot a_{\max}$ , where  $a_{\min}$  is the initial parameter value, and  $a_{\max}$  is the final parameter value.

## See Also

### MuPAD Functions

`plot` | `plot::copy`

### MuPAD Graphical Primitives

`plot::Rotate2d` | `plot::Rotate3d` | `plot::Scale2d` | `plot::Scale3d` |  
`plot::Transform2d` | `plot::Transform3d` | `plot::Translate3d`

## plot::Translate3d

Translation of 3D objects

### Syntax

```
plot::Translate3d([dx, dy, dz], obj1, <obj2, ...>, <a = amin .. amax>, options)
```

### Description

`plot::Translate3d([dx, dy, dz], object)` shifts a 3D object.

`plot::Translate3d` can translate several graphical objects simultaneously. Plotting the translate object renders all graphical objects inside.

Transformation objects can be used inside translation objects. If they are animated, the animations run simultaneously.

Animated translate objects are rather “cheap” concerning computing and storing costs. For more complex graphical objects, it is more efficient to use an animated translate object than to redefine the object for each frame.

The function `op` allows to extract the graphical objects inside a translate object.

### Attributes

Attribute	Purpose	Default Value
AffectViewingBox	influence of objects on the ViewingBox of a scene	TRUE
Frames	the number of frames in an animation	50
Name	the name of a plot object (for browser and legend)	

Attribute	Purpose	Default Value
ParameterEnd	end value of the animation parameter	
ParameterName	name of the animation parameter	
ParameterBegin	initial value of the animation parameter	
ParameterRange	range of the animation parameter	
Shift	shift vector	[0, 0, 0]
ShiftX	shift vector	0
ShiftY	shift vector	0
ShiftZ	shift vector	0
TimeEnd	end time of the animation	10.0
TimeBegin	start time of the animation	0.0
TimeRange	the real time span of an animation	0.0 .. 10.0

## Examples

### Example 1

Use an animated translation object to shift a vector to the tip of another vector:

```
A1 := plot::Arrow3d([0, 0, 0], [1, 1, 0], Color = RGB::Red):
A2 := plot::Arrow3d([0, 0, 0], [1, 1, 1], Color = RGB::Green):
plot(A1, plot::Translate3d([a, a, 0], A2, a = 0..1,
    TimeRange = 0..4),
    plot::Arrow3d([0, 0, 0], [2, 2, 1], Color = RGB::Blue,
    VisibleFromTo = 4..6),
    Header = "how to add 2 vectors in 3D",
    CameraDirection = [3, -2, 1]):
```

how to add 2 vectors in 3D

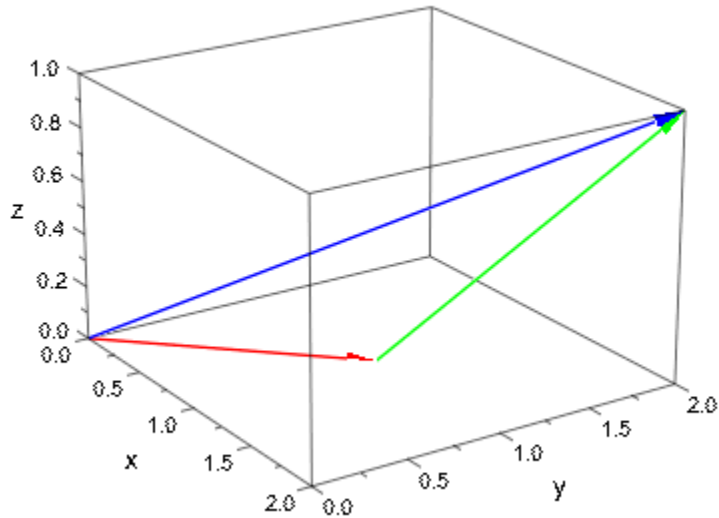

delete A1, A2:

## Parameters

$d_x, d_y, d_z$

The components of the shift vector: numerical real values or arithmetical expressions (Symbolic Math Toolbox) of the animation parameter  $a$ .

$d_x, d_y, d_z$  are equivalent to the attribute Shift.

$obj_1, obj_2, \dots$

Arbitrary plot objects of the appropriate dimension

$a$

Animation parameter, specified as  $a = a_{min} : a_{max}$ , where  $a_{min}$  is the initial parameter value, and  $a_{max}$  is the final parameter value.

## See Also

### **MuPAD Functions**

plot | plot::copy

### **MuPAD Graphical Primitives**

plot::Rotate2d | plot::Rotate3d | plot::Scale2d | plot::Scale3d |  
plot::Transform2d | plot::Transform3d | plot::Translate2d

## plot::AmbientLight

Ambient light

### Syntax

```
plot::AmbientLight(<intensity>, <a = amin .. amax>, options)
```

### Description

`plot::AmbientLight(intensity)` generates undirected ambient light of the given intensity.

Each 3D scene is illuminated by several light sources that are set automatically and cannot be controlled by the user. Cf. the help page of `Lighting`.

If special light effects are desired, the user can create alternative light sources of various types such as `plot::AmbientLight`, `plot::DistantLight`, `plot::PointLight`, and `plot::SpotLight`.

If at least one user defined light source is inserted into the scene (e.g., by simply passing the light objects as input parameters to the `plot` command), the automatic lights are switched off and the user defined lights are used to illuminate the scene.

While directed lights such as `plot::DistantLight` etc. create shading effects that add depth to the picture, a certain amount of undirected ambient light is usually needed.

`plot::AmbientLight(intensity)` creates ambient light whose intensity is given by the parameter `intensity`. When the intensity is 1, the ambient light dominates all other light sources.

By default, white light is created. Other colours can be chosen by the attribute `LightColor`.

It does not make sense to have more than one ambient light object in a scene.



## Attributes

Attribute	Purpose	Default Value
Frames	the number of frames in an animation	50
LightColor	the color of light	RGB::White
LightIntensity	intensity of light	1.0
Name	the name of a plot object (for browser and legend)	
ParameterEnd	end value of the animation parameter	
ParameterName	name of the animation parameter	
ParameterBegin	initial value of the animation parameter	
ParameterRange	range of the animation parameter	
TimeEnd	end time of the animation	10.0
TimeBegin	start time of the animation	0.0
TimeRange	the real time span of an animation	0.0 .. 10.0
Visible	visibility	TRUE

## Examples

### Example 1

We create a 3D function graph in flat white and use ambient white light to illuminate it:

```
f := plot::Function3d(sin(x + y) + cos(x - y),
                     x = -PI..PI, y = -PI..PI,
                     FillColorType = Flat,
                     Color = RGB::White):
```

```
ambientlight := plot::AmbientLight(0.7):  
plot(f, ambientlight):
```

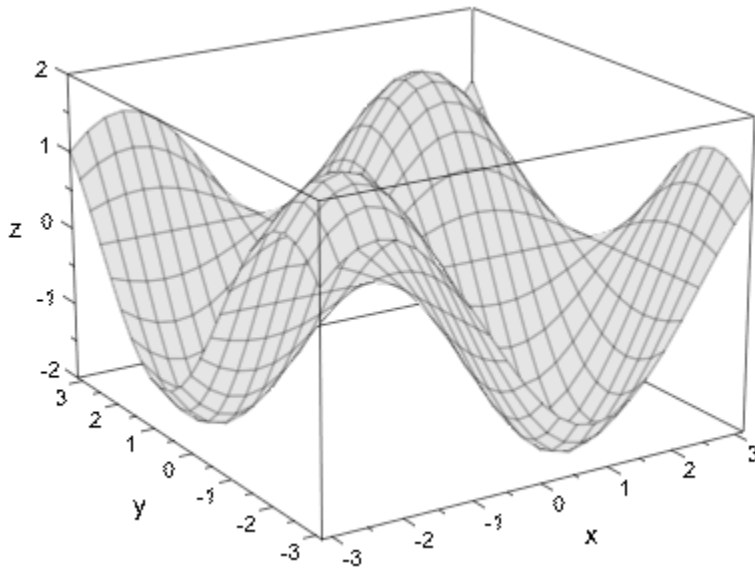

We create another ambient light with animated intensity:

```
ambientlight := plot::AmbientLight(a, a = 0..1):  
plot(f, ambientlight)
```

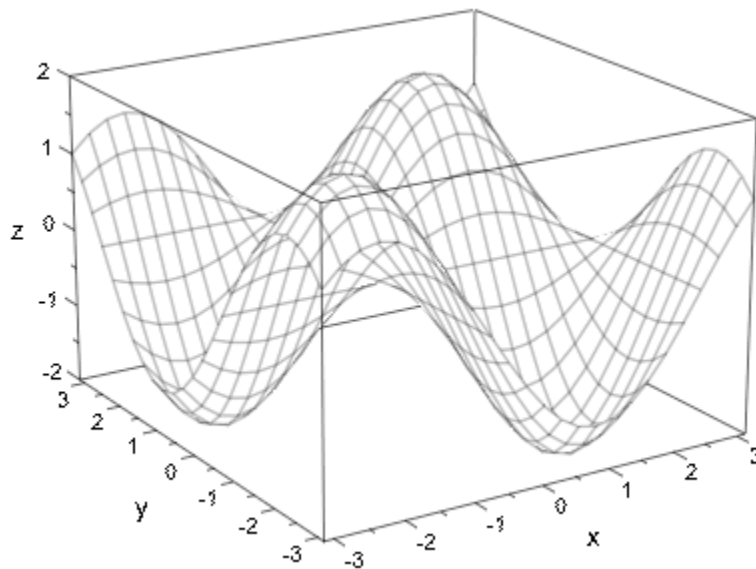

We add directed yellow light to the scene and study the mixture between the “sunlight” and an increasing amount of ambient light. When the ambient light is at full intensity, it dominates the directed light completely:

```
sunlight := plot::DistantLight([0, 0, 0], [5, 1, -3], 1,  
                               LightColor = RGB::Yellow):  
plot(f, ambientlight, sunlight)
```

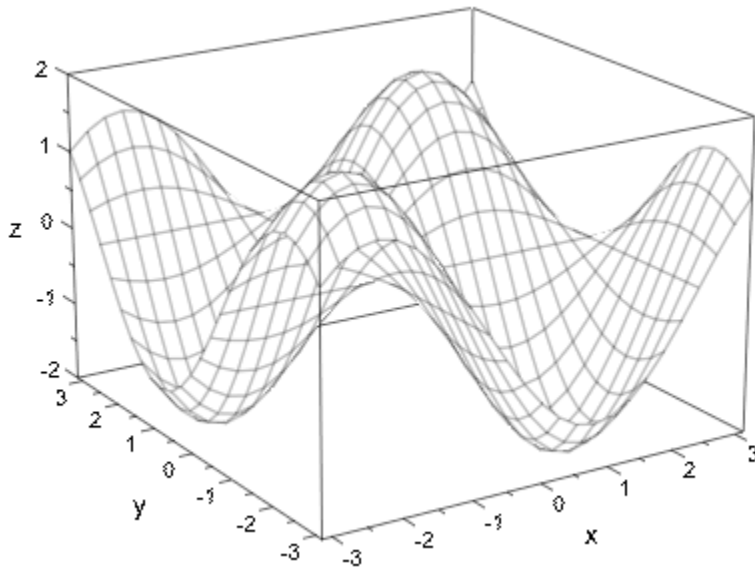

`delete f, ambientlight, sunlight:`

## Parameters

### **intensity**

The intensity of the light: a numerical value between 0 and 1 or an arithmetical expression (Symbolic Math Toolbox) of the animation parameter  $a$ .

`intensity` is equivalent to the attribute `LightIntensity`.

### **a**

Animation parameter, specified as  $a = a_{\min} \dots a_{\max}$ , where  $a_{\min}$  is the initial parameter value, and  $a_{\max}$  is the final parameter value.

## See Also

### **MuPAD Functions**

plot | plot::copy

### **MuPAD Graphical Primitives**

plot::DistantLight | plot::PointLight | plot::SpotLight

## plot::Camera

Camera

### Syntax

```
plot::Camera([px, py, pz], [fx, fy, fz], angle, <a = amin .. amax>, options)
```

### Description

`plot::Camera([px, py, pz], [fx, fy, fz], angle)` creates a camera at the position  $[p_x, p_y, p_z]$  pointing towards the focal point  $[f_x, f_y, f_z]$ . The opening angle of its lense is given by `angle`.

When creating a 3D scene, an “automatic camera” is used. Its location can be controlled by the attribute `CameraDirection`, but there are now further means of manipulating its parameters.

If the automatic camera does not suffice for your purposes, you may define your own camera by `plot::Camera`. Inserting such a camera object in your scene (for example, just by passing the camera as an argument to the `plot` command), the automatic camera is switched off and the new camera determines the view.

A camera of type `plot::Camera` allows to set all parameters determining the view and its perspective. Further, all parameters can be animated such that an animated “flight” through a 3D scene can be realized.

The first argument  $[p_x, p_y, p_z]$  in the call generating a camera is the `Position` of the camera in 3-space. The second argument  $[f_x, f_y, f_z]$  is the point the camera is aimed at (`FocalPoint`).

The optical axis is given by the vector `FocalPoint - Position`.

Together with the opening angle of the zoom lense (`ViewingAngle`), these parameters determine the view of the scene.

The `FocalPoint` vector can be replaced by any other point on the optical axes without changing the view. (`FocalPoint` and `Position` should not coincide, though.)

By default, the *z*-direction in 3-space corresponds to the vertical direction of the final picture. If this is not desired, the camera can be rotated around its optical axes using the attribute `UpVector`.

Depending on the distance of the camera to the graphical scene and the opening angle of the lense, the scene may fill only a small portion of the viewing area if the camera is too far away. If the camera is too close, only some parts of the scene may be visible

Just as for a real camera, you will have to move closer to or farther away from the scene to make it fill the drawing area as desired. Alternatively, you may keep the camera position fixed and use the zoom lense by choosing an appropriate `ViewingAngle`.

As in real life, you have to find appropriate parameters experimentally by looking at the picture and changing the parameters interactively.

Alternatively, you may define the camera with the attribute `OrthogonalProjection = TRUE`. This has the same effect as positioning the camera at a large distance from the scene using a powerful tele lense.

In this case, the camera ignores the `ViewingAngle` and the `Position` in 3-space. It is moved along the optical axis `FocalPoint - Position` to infinity and chooses an infinitesimal small viewing angle such that the scene fills the drawing area optimally.

Several cameras can be present simultaneously in a graphical scene. The first camera specified in the `plot` command determines the views.

One may switch between the cameras by clicking on the corresponding camera in the interactive “object browser” of the MuPAD graphics tool (see section `Viewer`, `Browser`, and `Inspector: Interactive Manipulation` (Symbolic Math Toolbox) of this document).

You may place your own light sources on page 24-1167 in the scene. When specifying the attribute `CameraCoordinates = TRUE` in the definition of the lights, they are attached to the camera and move automatically, when the camera is moved.

## Attributes

Attribute	Purpose	Default Value
<code>FocalPoint</code>	the focal point of a camera	

<b>Attribute</b>	<b>Purpose</b>	<b>Default Value</b>
FocalPointX	the focal point of a camera, x-coordinate	
FocalPointY	the focal point of a camera, y-coordinate	
FocalPointZ	the focal point of a camera, z-coordinate	
Frames	the number of frames in an animation	50
KeepUpVector	keep the UpVector constant when moving the camera?	TRUE
Name	the name of a plot object (for browser and legend)	
OrthogonalProjection	parallel projection without perspective distortion	FALSE
ParameterEnd	end value of the animation parameter	
ParameterName	name of the animation parameter	
ParameterBegin	initial value of the animation parameter	
ParameterRange	range of the animation parameter	
Position	positions of cameras, lights, and text objects	
PositionX	x-positions of cameras, lights, and text objects	
PositionY	y-positions of cameras, lights, and text objects	
PositionZ	z-positions of cameras, lights, and text objects	
TimeEnd	end time of the animation	10.0
TimeBegin	start time of the animation	0.0



Attribute	Purpose	Default Value
TimeRange	the real time span of an animation	0.0 .. 10.0
UpVector	“up direction” of a camera	[0.0, 0.0, 1.0]
UpVectorX	x-component of the “up vector” of the camera	0.0
UpVectorY	y-component of the “up vector” of the camera	0.0
UpVectorZ	z-component of the “up vector” of the camera	1.0
ViewingAngle	opening angle of the camera lense	
Visible	visibility	TRUE

## Examples

### Example 1

We use our own camera to view the 3D graph of a function:

```
f := plot::Function3d(sin(x) + y^3 + 2*exp(-3*x^2 - 20*y^2),
    x = -PI..PI, y = -1 .. 1,
    Submesh = [2, 2]):
camera := plot::Camera([-12, -4, 14], [0, 0, 0], PI/7):
plot(f, camera):
```

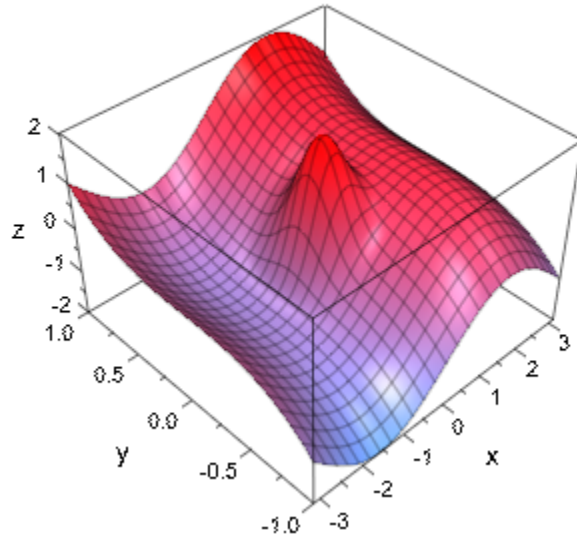

We move the camera to another position:

```
camera::Position := [7, -5, 6]:  
plot(f, camera):
```

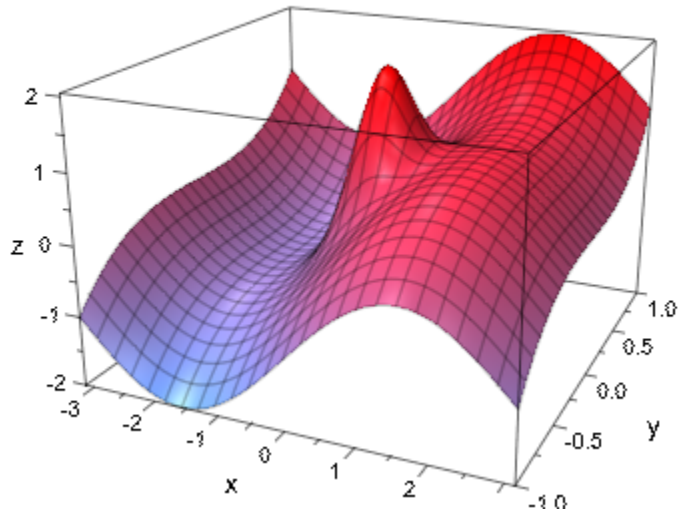

We turn the camera towards the central peak and zoom in by decreasing the opening angle of the zoom lens:

```
camera::FocalPoint := [0, 0, 1]:  
camera::ViewingAngle := PI/20:  
plot(f, camera):
```

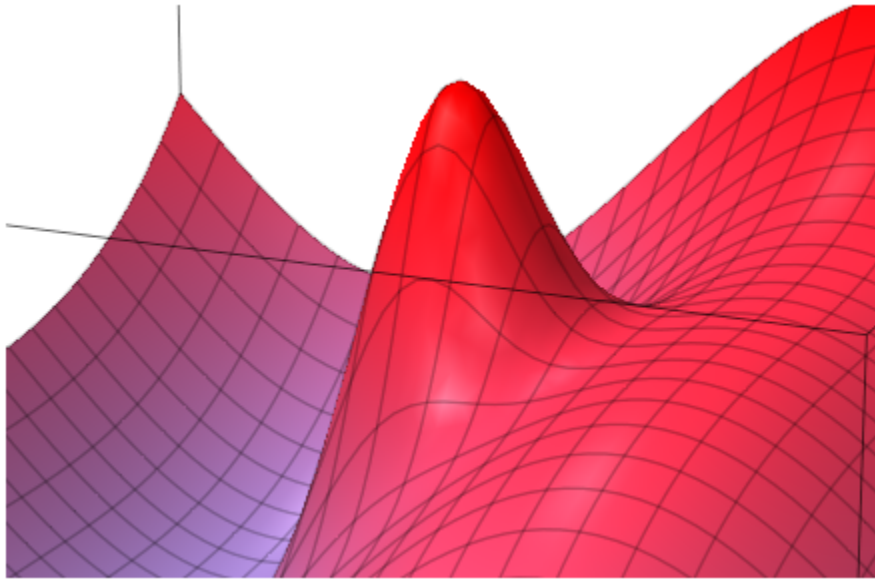

We create an animated camera and fly through the scene:

```
camera := plot::Camera([-15 + 3*a, 4 - a, 3 + (a - 4)^2],  
                       [0, 0, 1.5], PI/6, a = 0..8,  
                       Frames = 100, TimeRange = 0..20):  
plot(f, camera):
```

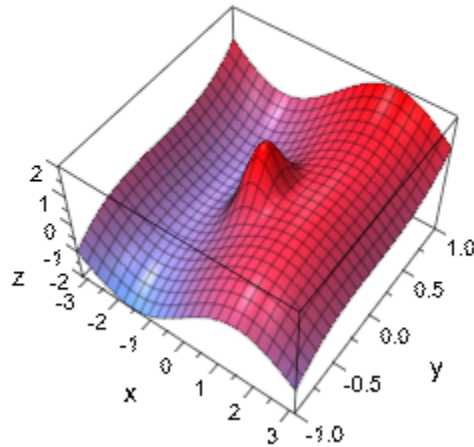

delete f, camera:

## Parameters

### $p_x, p_y, p_z$

Coordinates of the camera position: numerical real values or arithmetical expressions (Symbolic Math Toolbox) of the animation parameter  $a$ .

$p_x, p_y, p_z$  are equivalent to the attributes PositionX, PositionY, PositionZ.

### $f_x, f_y, f_z$

Coordinates of the the focal point: numerical real values or arithmetical expressions (Symbolic Math Toolbox) of the animation parameter  $a$ .

$f_x, f_y, f_z$  are equivalent to the attributes FocalPointX, FocalPointY, FocalPointZ.

**angle**

The opening angle of the lense in radians: a numerical real value or an arithmetical expression (Symbolic Math Toolbox) of the animation parameter `a` representing a value between 0 and  $\pi$ .

`angle` is equivalent to the attribute `ViewingAngle`.

**a**

Animation parameter, specified as `a = amin .. amax`, where `amin` is the initial parameter value, and `amax` is the final parameter value.

**See Also****MuPAD Functions**

`CameraCoordinates` | `CameraDirection` | `FocalPoint` | `KeepUpVector` | `OrthogonalProjection` | `Position` | `UpVector` | `ViewingAngle` | `plot` | `plot::copy`

**Topics**

“Cameras in 3D” (Symbolic Math Toolbox)

# plot::DistantLight

Directed distant light (“sunlight”)

## Syntax

```
plot::DistantLight([px, py, pz], [tx, ty, tz], <intensity>, <a = amin .. amax>, options)
```

## Description

`plot::DistantLight([px, py, pz], [tx, ty, tz], intensity)` creates a distant light source emitting parallel light shining into the direction  $[t_x - p_x, t_y - p_y, t_z - p_z]$

Each 3D scene is illuminated by several light sources that are set automatically and cannot be controlled by the user. Cf. the help page of `Lighting`.

If special light effects are desired, the user can create alternative light sources of various types such as `plot::AmbientLight`, `plot::DistantLight`, `plot::PointLight`, and `plot::SpotLight`.

If at least one user defined light source is inserted into the scene (e.g., by simply passing the light objects as input parameters to the `plot` command), the automatic lights are switched off and the user defined lights are used to illuminate the scene.

---

**Note** The vector  $[p_x, p_y, p_z]$  does *not* represent the position of a distant light in space. The light source is infinitely far away.

---

When using  $[t_x, t_y, t_z] = [0, 0, 0]$ , you may think of  $[p_x, p_y, p_z]$  as the *direction* where the light source is located.

When using  $[p_x, p_y, p_z] = [0, 0, 0]$ , you may think of  $[t_x, t_y, t_z]$  as the *direction* into which the light is shining.

By default, white light is created. Other colors can be chosen by the attribute `LightColor`.

When using the attribute `CameraCoordinates = TRUE`, the light source is fixed to the camera. It moves automatically, when the camera is moved.

Directed light such as `plot::DistantLight` create shading effects that add depth to the picture. Usually, a certain amount of undirected ambient light of type `plot::AmbientLight` enhances the picture.

## Attributes

Attribute	Purpose	Default Value
<code>CameraCoordinates</code>	position of light sources relative to the camera?	FALSE
<code>Frames</code>	the number of frames in an animation	50
<code>LightColor</code>	the color of light	RGB::White
<code>LightIntensity</code>	intensity of light	1.0
<code>Name</code>	the name of a plot object (for browser and legend)	
<code>ParameterEnd</code>	end value of the animation parameter	
<code>ParameterName</code>	name of the animation parameter	
<code>ParameterBegin</code>	initial value of the animation parameter	
<code>ParameterRange</code>	range of the animation parameter	
<code>Position</code>	positions of cameras, lights, and text objects	
<code>PositionX</code>	x-positions of cameras, lights, and text objects	
<code>PositionY</code>	y-positions of cameras, lights, and text objects	



Attribute	Purpose	Default Value
PositionZ	z-positions of cameras, lights, and text objects	
Target	the target point of a light	
TargetX	the target point of a light, x component	
TargetY	the target point of a light, y component	
TargetZ	the target point of a light, z component	
TimeEnd	end time of the animation	10.0
TimeBegin	start time of the animation	0.0
TimeRange	the real time span of an animation	0.0 .. 10.0
Visible	visibility	TRUE

## Examples

### Example 1

We create a white sphere and use a single directed white light to illuminate it:

```
f := plot::Surface(
    [cos(u)*sin(v), sin(u)*sin(v), cos(v)],
    u = 0..2*PI, v = 0..PI,
    FillColorType = Flat,
    FillColorFunction = RGB::White,
    Scaling = Constrained):
sunlight1 := plot::DistantLight([1, -2, 3], [0, 0, 0], 1/2):
plot(f, sunlight1):
```

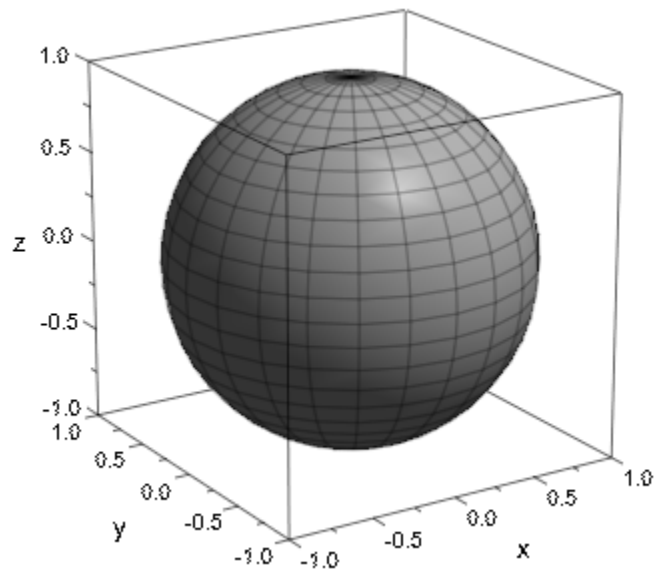

We create another distant light source shining from another direction, of yellow color and with animated intensity:

```
sunlight2 := plot::DistantLight([-2, 1, 3], [0, 0, 0], a,  
                                LightColor = RGB::Yellow,  
                                a = 0..1):  
plot(f, sunlight2)
```

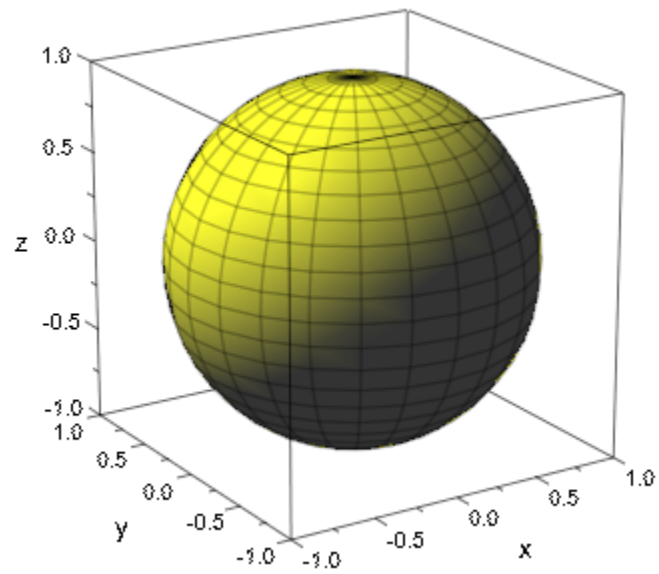

We use both lights simultaneously:

```
plot(f, sunlight1, sunlight2)
```

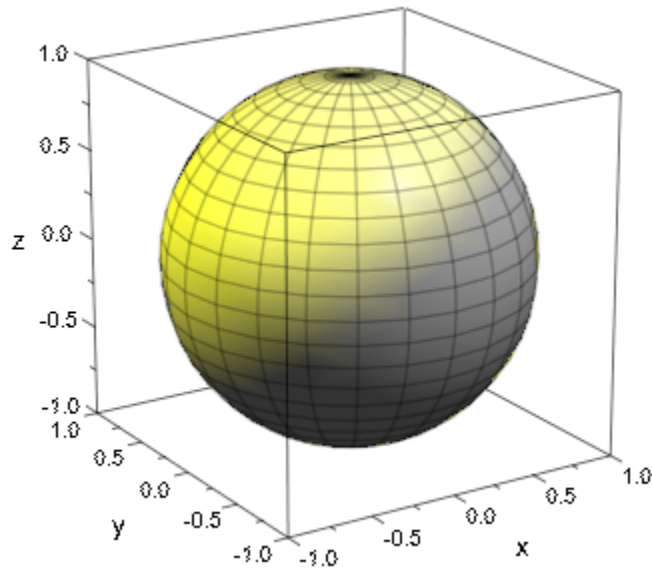

```
delete f, sunlight1, sunlight2:
```

## Parameters

### $p_x, p_y, p_z$

The coordinates of the sun's "position": numerical values or arithmetical expressions (Symbolic Math Toolbox) of the animation parameter  $a$ .

$p_x, p_y, p_z$  are equivalent to the attributes PositionX, PositionY, PositionZ.

### $t_x, t_y, t_z$

The coordinates of the point the light is shining to: numerical values or arithmetical expressions (Symbolic Math Toolbox) of the animation parameter  $a$ .

$t_x, t_y, t_z$  are equivalent to the attributes TargetX, TargetY, TargetZ.

**intensity**

The intensity of the light: a numerical value between 0 and 1 or an arithmetical expression (Symbolic Math Toolbox) of the animation parameter  $a$ .

`intensity` is equivalent to the attribute `LightIntensity`.

**a**

Animation parameter, specified as  $a = a_{\min} \dots a_{\max}$ , where  $a_{\min}$  is the initial parameter value, and  $a_{\max}$  is the final parameter value.

**See Also****MuPAD Functions**

`plot` | `plot::copy`

**MuPAD Graphical Primitives**

`plot::AmbientLight` | `plot::PointLight` | `plot::SpotLight`

## plot::PointLight

Point light

### Syntax

```
plot::PointLight([x, y, z], <intensity>, <a = amin .. amax>, options)
```

### Description

`plot::PointLight([x, y, z], intensity)` generates a point light at the position  $(x, y, z)$ .

Each 3D scene is illuminated by several light sources that are set automatically and cannot be controlled by the user. Cf. the help page of `Lighting`.

If special light effects are desired, the user can create alternative light sources of various types such as `plot::AmbientLight`, `plot::DistantLight`, `plot::PointLight`, and `plot::SpotLight`.

If at least one user defined light source is inserted into the scene (e.g., by simply passing the light objects as input parameters to the `plot` command), the automatic lights are switched off and the user defined lights are used to illuminate the scene.

`plot::PointLight([x, y, z], intensity)` creates a point light at the position  $(x, y, z)$ . It emits light into all directions.

Unlike in real life, the light flux of a point light does not decrease with the distance to the light source.

By default, white light is created. Other colors can be chosen by the attribute `LightColor`.

When using the attribute `CameraCoordinates = TRUE`, the light source is fixed to the camera. It moves automatically, when the camera is moved.

Light sources such as `plot::PointLight` create shading effects that add depth to the picture.

Usually, you will use point lights to highlight special details of the scene. For the illumination of the entire scene you will usually need additional undirected ambient light of type `plot::AmbientLight`, too.

Note that all light sources create a homogeneous lighting effect for a 3D triangle. Thus, realistic shading effects can only be achieved for surfaces with a sufficiently fine triangulation. For function graphs (`plot::Function3d`) and parametrized surfaces (`plot::Surface`), a fine triangulation is created by sufficiently high values of `XMesh`, `YMesh` or `UMesh`, `VMesh`, respectively.

## Attributes

Attribute	Purpose	Default Value
CameraCoordinates	position of light sources relative to the camera?	FALSE
Frames	the number of frames in an animation	50
LightColor	the color of light	RGB::White
LightIntensity	intensity of light	1.0
Name	the name of a plot object (for browser and legend)	
ParameterEnd	end value of the animation parameter	
ParameterName	name of the animation parameter	
ParameterBegin	initial value of the animation parameter	
ParameterRange	range of the animation parameter	
Position	positions of cameras, lights, and text objects	
PositionX	x-positions of cameras, lights, and text objects	

Attribute	Purpose	Default Value
PositionY	y-positions of cameras, lights, and text objects	
PositionZ	z-positions of cameras, lights, and text objects	
TimeEnd	end time of the animation	10.0
TimeBegin	start time of the animation	0.0
TimeRange	the real time span of an animation	0.0 .. 10.0
Visible	visibility	TRUE

## Examples

### Example 1

We create three blue surfaces and illuminate them by an animated point light. The position of the point light is indicated by a white point:

```
s1 := plot::Surface([1, y, z], y = 0..1, z = 0..1):
s2 := plot::Surface([x, 1, z], x = 0..1, z = 0..1):
s3 := plot::Surface([x, y, 0], x = 0..1, y = 0..1):
p := plot::Point3d([a, 0.9, 0.2], a = 0..1,
    PointSize = 2.0*unit::mm,
    PointColor = RGB::White):
light := plot::PointLight([a, 0.9, 0.2], 1, a = 0..1):
plot(s1, s2, s3, p, light, Axes = Frame,
    FillColor = RGB::Blue, FillColorType = Flat):
```



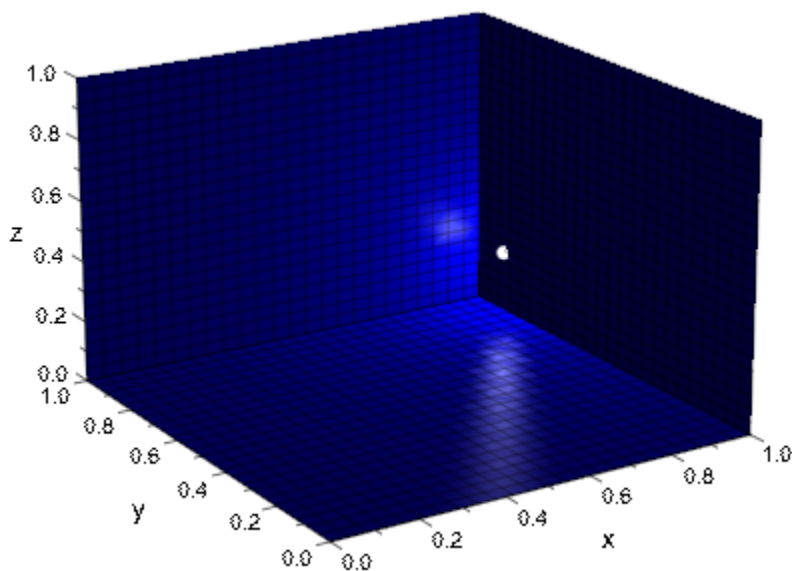

```
delete s1, s2, s3, p, light:
```

## Parameters

### **x, y, z**

The coordinates of the point light: numerical values or arithmetical expressions (Symbolic Math Toolbox) of the animation parameter *a*.

*x, y, z* are equivalent to the attributes `Position`, `PositionX`, `PositionY`, `PositionZ`.

### **intensity**

The intensity of the light: a numerical value between 0 and 1 or an arithmetical expression (Symbolic Math Toolbox) of the animation parameter *a*.

`intensity` is equivalent to the attribute `LightIntensity`.

**a**

Animation parameter, specified as  $a = a_{\min} .. a_{\max}$ , where  $a_{\min}$  is the initial parameter value, and  $a_{\max}$  is the final parameter value.

## See Also

### **MuPAD Functions**

`plot` | `plot::copy`

### **MuPAD Graphical Primitives**

`plot::AmbientLight` | `plot::DistantLight` | `plot::SpotLight`

# plot::SpotLight

Spot light

## Syntax

```
plot::SpotLight([px, py, pz], [tx, ty, tz], angle, <intensity>, <a = amin .. amax>, options)
```

## Description

`plot::SpotLight([px, py, pz], [tx, ty, tz], angle, intensity)` generates a spot light at the position p<sub>x</sub>, p<sub>y</sub>, p<sub>z</sub>, aimed at the point t<sub>x</sub>, t<sub>y</sub>, t<sub>z</sub>. The opening angle of the light cone is given by `angle`.

Each 3D scene is illuminated by several light sources that are set automatically and cannot be controlled by the user. Cf. the help page of `Lighting`.

If special light effects are desired, the user can create alternative light sources of various types such as `plot::AmbientLight`, `plot::DistantLight`, `plot::PointLight`, and `plot::SpotLight`.

If at least one user defined light source is inserted into the scene (e.g., by simply passing the light objects as input parameters to the `plot` command), the automatic lights are switched off and the user defined lights are used to illuminate the scene.

`plot::SpotLight([px, py, pz], [tx, ty, tz], angle)` creates a spot light source at the point [p<sub>x</sub>, p<sub>y</sub>, p<sub>z</sub>] emitting a light cone towards the point [t<sub>x</sub>, t<sub>y</sub>, t<sub>z</sub>]. In contrast to real life, the light flux of a spot light does not decrease with the distance to the light source.

By default, white light is created. Other colours can be chosen by the attribute `LightColor`.

When using the attribute `CameraCoordinates = TRUE`, the light source is fixed to the camera. It moves automatically, when the camera is moved.

Directed light such as `plot::SpotLight` create shading effects that add depth to the picture.

Usually, you will use spot lights to highlight special details of the scene. For the illumination of the entire scene you will usually need additional undirected ambient light of type `plot::AmbientLight`, too.

Note that all light sources create a homogeneous lighting effect for a 3D triangle. Thus, realistic shading effects can only be achieved for surfaces with a sufficiently fine triangulation. For function graphs (`plot::Function3d`) and parametrized surfaces (`plot::Surface`), a fine triangulation is created by sufficiently high values of `XMesh`, `YMesh` or `UMesh`, `VMesh`, respectively.

## Attributes

Attribute	Purpose	Default Value
CameraCoordinates	position of light sources relative to the camera?	FALSE
Frames	the number of frames in an animation	50
LightColor	the color of light	RGB::White
LightIntensity	intensity of light	1.0
Name	the name of a plot object (for browser and legend)	
ParameterEnd	end value of the animation parameter	
ParameterName	name of the animation parameter	
ParameterBegin	initial value of the animation parameter	
ParameterRange	range of the animation parameter	
Position	positions of cameras, lights, and text objects	
PositionX	x-positions of cameras, lights, and text objects	

Attribute	Purpose	Default Value
PositionY	y-positions of cameras, lights, and text objects	
PositionZ	z-positions of cameras, lights, and text objects	
SpotAngle	opening angle of the light cone of a spot light	
Target	the target point of a light	
TargetX	the target point of a light, x component	
TargetY	the target point of a light, y component	
TargetZ	the target point of a light, z component	
TimeEnd	end time of the animation	10.0
TimeBegin	start time of the animation	0.0
TimeRange	the real time span of an animation	0.0 .. 10.0
Visible	visibility	TRUE

## Examples

### Example 1

We create three white surfaces and illuminate them by two animated white spot lights and some ambient light. The spot lights are indicated by little cones:

```
s1 := plot::Surface([1, y, z], y = 0..1, z = 0..1):
s2 := plot::Surface([x, 1, z], x = 0..1, z = 0..1,
  Submesh = [2, 2]):
s3 := plot::Surface([x, y, 0], x = 0..1, y = 0..1,
  Submesh = [2, 2]):
ambientlight:= plot::AmbientLight(0.4):
spotlight1 := plot::SpotLight([1/3, a, 1/3], [1/3, 1, 1/3],
  PI/5, a = 0..0.8):
```

```
c1 := plot::Cone(0, [1/3, a, 1/3],  
               0.2*tan(PI/10), [1/3, a + 0.2, 1/3],  
               a = 0..0.8, Color = RGB::Orange.[0.5]):  
spotlight2 := plot::SpotLight([2/3, a, 2/3], [2/3, a, 0],  
                             PI/4, a = 0.15..0.95):  
c2 := plot::Cone(0, [2/3, a, 2/3],  
               0.2*tan(PI/8), [2/3, a, 2/3 - 0.2],  
               a = 0.15..0.95, Color = RGB::Orange.[0.5]):  
plot(s1, s2, s3, FillColor = RGB::White,  
     FillColorType = Flat,  
     ambientlight, c1, spotlight1,  
     c2, spotlight2, Axes = Frame):
```

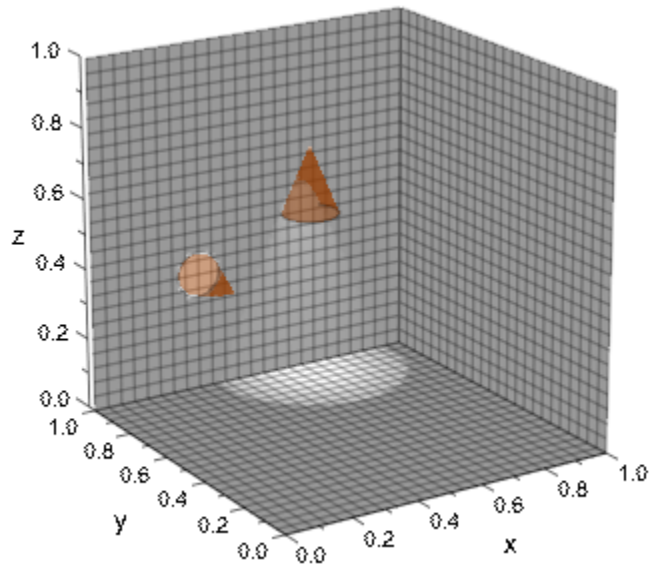

```
delete s1, s2, s3, c1, c2, ambientlight,  
       spotlight1, spotlight2:
```

## Parameters

### $p_x$ , $p_y$ , $p_z$

The coordinates of the position: numerical values or arithmetical expressions (Symbolic Math Toolbox) of the animation parameter  $a$ .

$p_x$ ,  $p_y$ ,  $p_z$  are equivalent to the attributes `Position`, `PositionX`, `PositionY`, `PositionZ`.

### $t_x$ , $t_y$ , $t_z$

The coordinates of the point the light is shining to: numerical values or arithmetical expressions (Symbolic Math Toolbox) of the animation parameter  $a$ .

$t_x$ ,  $t_y$ ,  $t_z$  are equivalent to the attributes `Target`, `TargetX`, `TargetY`, `TargetZ`.

### angle

The opening angle of the light cone in radians: a numerical value between 0 and  $\pi$  or an arithmetical expression (Symbolic Math Toolbox) of the animation parameter  $a$ .

angle is equivalent to the attribute `SpotAngle`.

### intensity

The intensity of the light: a numerical value between 0 and 1 or an arithmetical expression (Symbolic Math Toolbox) of the animation parameter  $a$ .

intensity is equivalent to the attribute `LightIntensity`.

### $a$

Animation parameter, specified as  $a = a_{\min} \dots a_{\max}$ , where  $a_{\min}$  is the initial parameter value, and  $a_{\max}$  is the final parameter value.

## See Also

### MuPAD Functions

plot | plot::copy

**MuPAD Graphical Primitives**

`plot::AmbientLight | plot::DistantLight | plot::PointLight`



# OutputFileOutputOptions

File name to plot into

## Value Summary

OutputFile, OutputOptions	Optional	See below
------------------------------	----------	-----------

## Description

The attribute `OutputFile` allows to specify a file name to direct the plot output into an external file instead of rendering the plot on the screen. The extension of the file name indicates the export format.

The available formats include `.xvz` and `.xvc` (the MuPAD proprietary XML format) as well as various standard bitmap formats such as `.bmp`, `.gif`, `.jpg` etc. and vector formats such as `.eps`, `.svg` etc. Animated MuPAD graphics can be exported to animated GIF files. On Windows systems, it also can be exported to `.avi` format.

Some of the export formats allow to specify certain parameters such as “resolution,” “quality” etc. Such parameters may be specified by the attribute `OutputOptions`.

MuPAD plots can be saved in “batch mode” by specifying the attribute `OutputFile = filename` in a plot call or in `plotfunc2d`, `plotfunc3d`. The file name must be a MuPAD string on page 7-53. For example:

```
plot(..graphical objects.., OutputFile = "mypicture.xvz");
```

(Here, the extension `.xvz` of the file name `"mypicture.xvz"` indicates that the MuPAD XML data are to be written).

If the MuPAD environment variable `WRITEPATH` does not have a value, the previous call creates the file in the directory where MuPAD is running. (On Windows and Macintosh systems, this is, by default, the directory where it is installed).

After setting `WRITEPATH` to the absolute path of a folder, the file is created in that folder. For example, after

```
WRITEPATH := "C:\\Documents":
```

the command

```
plot(..graphical objects.., OutputFile = "mypicture.xvz"):
```

stores the plot data in the file "C:\Documents\mypicture.xvz." Alternatively, the file name can be specified as an absolute pathname:

```
plot(..objects.., OutputFile = "C:\\Documents\\mypicture.xvz"):
```

If a MuPAD notebook was saved to a file, its location is available inside the notebook as the environment variable `NOTEBOOKPATH`. If you wish to save your plot in the same folder as the notebook, you may call

```
plot(..objects.., OutputFile = NOTEBOOKPATH."mypicture.xvz"):
```

The plot data can be stored in various formats indicated by the extension of the file name. In particular, there are the MuPAD proprietary XML formats. The file extension `.xvz` indicates that XML data are to be written and, finally, the file is to be compressed. Alternatively, the extension `.xvc` may be used to write the XML data without final compression (the resulting text file can be read with any text editor). Files in both formats can be inserted into a MuPAD notebook and freely manipulated.

Apart from saving files as XML data, MuPAD pictures can also be saved in a variety of standard bitmap formats such as `.bmp`, `.gif`, `.jpg` etc. Also `.svg` and `.eps` export is available. Just use an appropriate extension of the file name indicating the format.

---

**Note** Only XML files `.xvz` and `.xvc` retain the information necessary for interactive manipulation in a MuPAD notebook. All other formats are intended for exporting graphics to other programs.

---

If no file extension is specified in the file name, the default extension `.xvz` is used, i.e., XML data are written.

On Windows systems, animated MuPAD plots can be exported to `.avi` format. Cf. "Example 2" on page 24-1188 (Symbolic Math Toolbox).

In addition to `OutputFile`, there is the attribute `OutputOptions` to specify parameters for some of the export formats. The admissible value for this attribute is a list of equations:

OutputOptions = [<ReduceTo256Colors = b >, <DotsPerInch = n<sub>1</sub>>, <Quality = n<sub>2</sub>>, <JPEGMode = n<sub>3</sub>>, <EPSMode = n<sub>4</sub>>, <AVIMode = n<sub>5</sub>>, <WMFMode = n<sub>6</sub>>, <FramesPerSecond = n<sub>7</sub>>, <PlotAt = l<sub>1</sub>>]

Each entry of the list is optional. The parameters are

b	TRUE or FALSE. Has an effect for export to some raster formats only. With TRUE, only 256 different colors are stored in the raster file. The default value is FALSE.
n <sub>1</sub>	Positive integer setting the resolution in DPI (dots per inch). Has an effect for export to raster formats only. The default value depends on the hardware.
n <sub>2</sub>	One of the integers 1, 2, ..., 100. This integer represents a percentage value determining the quality of the export. Has an effect for JPG, 3D EPS, 3D WMF and AVI export only. The default value is 75.
n <sub>3</sub>	0, 1, or 2. Has an effect for JPG export only. The flag 0 represents the JPG mode 'Baseline Sequential', 1 represents 'Progressive', 2 represents 'Sequential Optimized'. The default value is 0.
n <sub>4</sub>	0 or 1. Has an effect for EPS export only. The flag 0 represents the EPS mode 'Painter's Algorithm', 1 represents 'BSP Tree Algorithm'. The default value is 0.
n <sub>5</sub>	0, 1 or 2. Has an effect for AVI export only. With 0, the 'Microsoft Video 1 Codec' is used. With 1, the 'Uncompressed Single Frame Codec' is used. With 2, the 'Radius Cinepak Codec' is used. The default value is 0.

$n_6$	0, 1 or 2. Has an effect for WMF export only. With 0, the 'Painter's Algorithm' is used. With 1, the 'BSP Tree Algorithm' is used. With 2, a 'embedded bitmap' is created. The default value is 0.
$n_7$	Positive integer setting the frames per second for the AVI to be generated. Has an effect for AVI and animated GIF export only. The default value is 15.
$\tau_1$	List of real values between TimeBegin and TimeEnd which determines the times at which pictures should be saved from an animation.

## Examples

### Example 1

The following commands save the plot in four different files in JPG, EPS, SVG, and BMP format, respectively:

```
f1 := plot::Function2d(sin(x), x = 0..PI, Color = RGB::Red):
f2 := plot::Function2d(cos(x), x = 0..PI, Color = RGB::Blue):
plot(f1, f2, OutputFile = "mypicture.jpg"):
plot(f1, f2, OutputFile = "mypicture.eps"):
plot(f1, f2, OutputFile = "mypicture.svg"):
plot(f1, f2, OutputFile = "mypicture.bmp"):
```

If no file extension is specified in the file name, the default extension .xvz is used, i.e., XML data are written. The following command creates the file mypicture.xvz:

```
plot(f1, f2, OutputFile = "mypicture"):
```

### Example 2

An animated MuPAD plot can be exported to .avi format:

```
plotfunc2d(sin(x - a), x = 0 .. 2*PI, a = 0 .. 5,
           OutputFile = "myanimation.avi"):
```

### Example 3

An animated MuPAD plot can be exported to several single images at given times:

```
plotfunc2d(sin(x - a), x = 0 .. 2*PI, a = 0 .. 5,  
           OutputFile = "someName.png",  
           OutputOptions=[PlotAt = [i $ i = 0..10 step 0.5]]):
```

### See Also

#### Topics

“Save in Batch Mode” (Symbolic Math Toolbox)

## **AffectViewingBox**

Influence of objects on the ViewingBox of a scene

### **Value Summary**

Inherited	FALSE, or TRUE
-----------	----------------

## Graphics Primitives

Objects	AffectViewingBox Default Values
plot::Arc2d, plot::Arc3d, plot::Arrow2d, plot::Arrow3d, plot::Bars2d, plot::Bars3d, plot::Box, plot::Boxplot, plot::Circle2d, plot::Circle3d, plot::Cone, plot::Conformal, plot::Curve2d, plot::Curve3d, plot::Cylinder, plot::Cylindrical, plot::Density, plot::Dodecahedron, plot::Ellipse2d, plot::Ellipse3d, plot::Ellipsoid, plot::Function2d, plot::Function3d, plot::Hatch, plot::Hexahedron, plot::Histogram2d, plot::Icosahedron, plot::Implicit2d, plot::Implicit3d, plot::Inequality, plot::Integral, plot::Iteration, plot::Line2d, plot::Line3d, plot::Listplot, plot::Lsys, plot::Matrixplot, plot::MuPADCube, plot::Octahedron, plot::Ode2d, plot::Ode3d, plot::Parallelogram2d, plot::Parallelogram3d, plot::Piechart2d, plot::Piechart3d, plot::Plane, plot::Point2d, plot::Point3d, plot::PointList2d, plot::PointList3d, plot::Polar, plot::Polygon2d, plot::Polygon3d, plot::Prism, plot::Pyramid, plot::QQplot, plot::Raster, plot::Rectangle, plot::Reflect2d, plot::Reflect3d, plot::Rootlocus, plot::Rotate2d, plot::Rotate3d, plot::Scale2d, plot::Scale3d, plot::Scatterplot, plot::Sequence,	TRUE

Objects	AffectViewingBox Default Values
plot::SparseMatrixplot, plot::Sphere, plot::Spherical, plot::Streamlines2d, plot::Sum, plot::Surface, plot::SurfaceSet, plot::SurfaceSTL, plot::Sweep, plot::Tetrahedron, plot::Text2d, plot::Text3d, plot::Transform2d, plot::Transform3d, plot::Translate2d, plot::Translate3d, plot::Tube, plot::Turtle, plot::VectorField2d, plot::VectorField3d, plot::Waterman, plot::XRotate, plot::ZRotate	

## Description

AffectViewingBox determines whether the ViewingBox of an object should be taken into account for the total ViewingBox of the graphical scene.

Usually, the visible area/volume of a graphical scene is automatically chosen as the smallest box containing all objects of the scene. Objects with AffectViewingBox = FALSE are ignored in the computation of this box.

## Examples

### Example 1

We plot the sine and the exponential function in one scene:

```
plot(plot::Function2d(sin(x), x = -PI..PI),
      plot::Function2d(exp(x), x = -PI..PI))
```



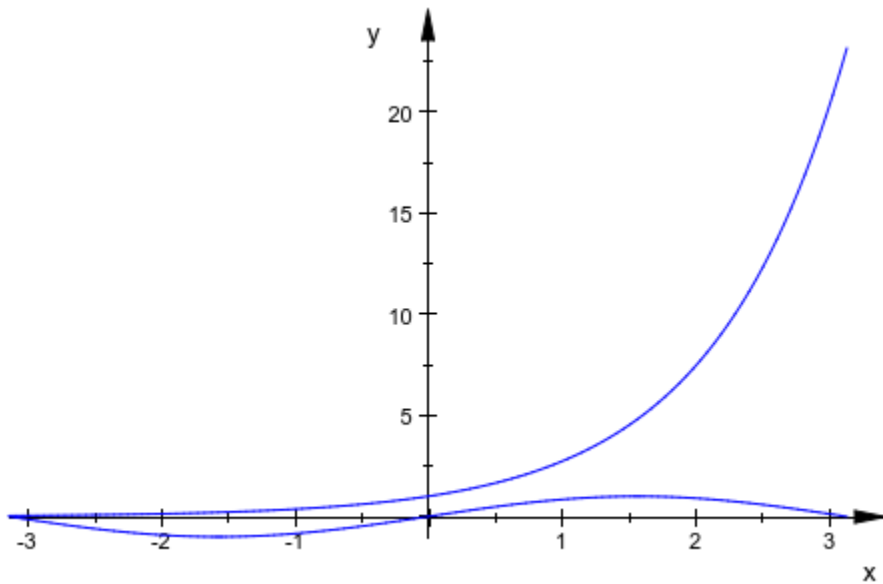

The exponential function dominates the sine. We set `AffectViewingBox = FALSE` for `exp`. Now, only the sine function determines the visible area and `exp` is only visible where it is in the `ViewingBox` of the sine function:

```
plot(plot::Function2d(sin(x), x = -PI..PI),  
      plot::Function2d(exp(x), x = -PI..PI,  
                        AffectViewingBox = FALSE))
```

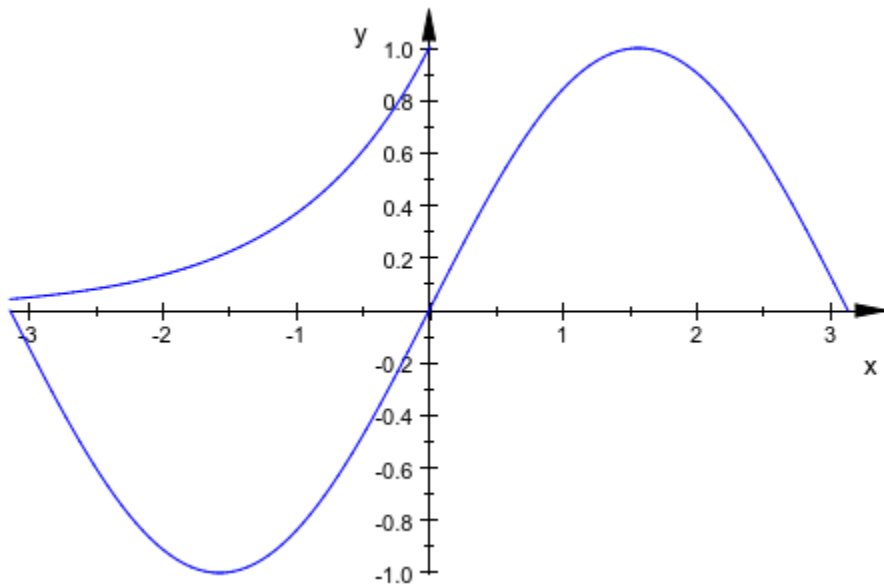

## See Also

**MuPAD Functions**  
ViewingBox

# Angle

Rotation angle

## Value Summary

Optional	MuPAD expression
----------	------------------

## Graphics Primitives

Objects	Angle Default Values
<code>plot::Arc2d</code> , <code>plot::Arc3d</code> , <code>plot::Prism</code> , <code>plot::Pyramid</code> , <code>plot::Rotate2d</code> , <code>plot::Rotate3d</code>	0

## Description

Angle determines the rotation angle in transformation objects of type `plot::Rotate2d` and `plot::Rotate3d`, respectively, and other graphical objects. The angle has to be specified in radians.

In 2D, the direction of the rotation is counter clock wise. Use negative angles to rotate clock wise.

In 3D, the rotation is implemented following the “right hand rule”: Stretch the thumb of your right hand and bend the fingers. When the thumb points into the direction of the rotation axis, your finger tips indicate the direction of the rotation. Use negative angles to rotate in the opposite direction.

## Examples

### Example 1

Rectangles of type `plot::Rectangle` are always parallel to the coordinate axes. To have one with a different orientation, we must rotate it:

```
r0 := plot::Rectangle(0..2, 1..3):  
r1 := plot::Rotate2d(r0, Center = [1, 2], Angle = PI/6)
```

```
plot::Rotate2d( $\frac{\pi}{6}$ , Center = [1, 2], plot::Rectangle(0..2, 1..3))
```

As you can see in the output above, the rotate object *contains* the rotated object and acts as a grouping construct. This means that we only need to plot `r1` to see the rotated object:

```
plot(r1)
```

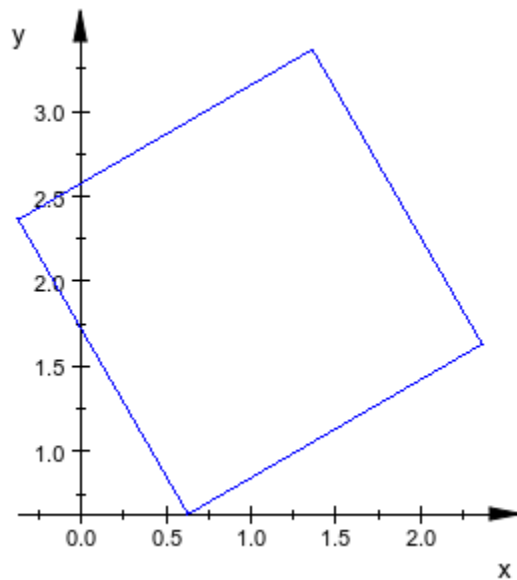

Plotting both `r0` and `r1` yields a plot showing the rotated rectangle together with the unrotated one:

```
plot(r0, r1)
```

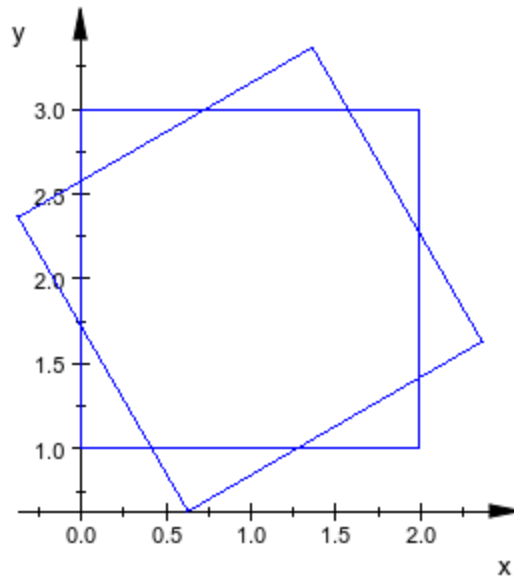

```
delete r0, r1:
```

## Example 2

Using `plot::Rotate2d`, we plot several copies of a function plot, rotated at different angles:

```
f := plot::Function2d(sin(x^3)/(x^2+1), x = -5..5, Mesh = 300):
plot(plot::Rotate2d(f, Angle = PI/11*a) $ a = 0..10):
```

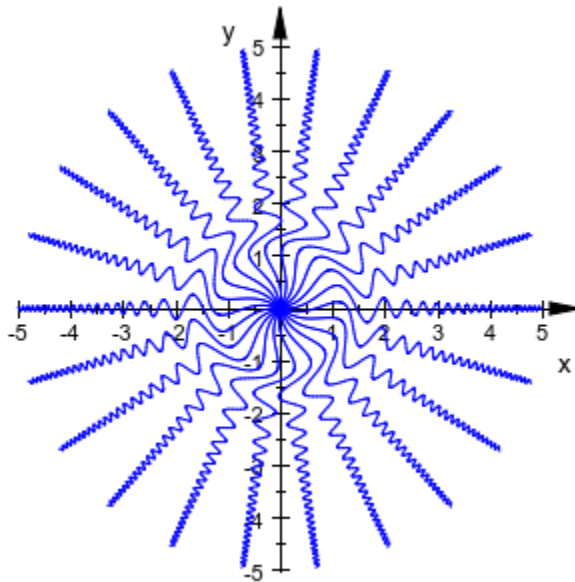

delete f:

### Example 3

The rotation angle can be animated. We use an animated `plot::Rotate2d` object to rotate a square around a center that moves along a circle around the origin:

```
p := plot::Point2d([cos(a), sin(a)], a = 0..2*PI,
                  Frames = 100):
r := plot::Rotate2d(plot::Rectangle(0..2, -1..1), Angle = a,
                  Center = [0, 0], a = 0..2*PI):
q := plot::Rotate2d(r, Angle = 4*a, Center = [cos(a), sin(a)],
                  a = 0..2*PI, Frames = 200):
plot(p, q)
```

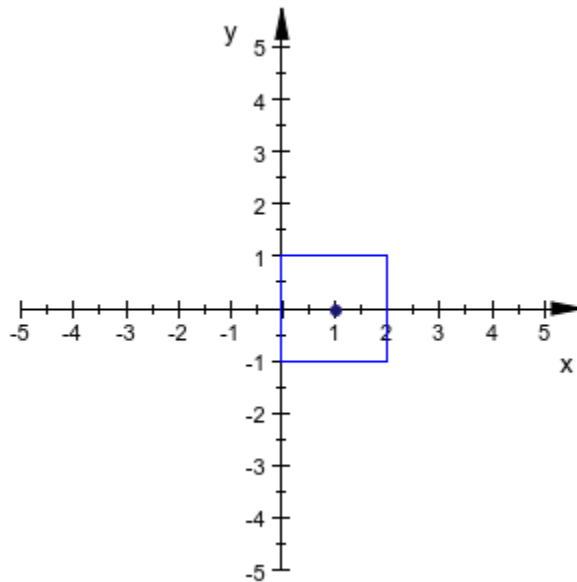

delete p, r, q:

### Example 4

This is the 3D analogue of “Example 1” on page 24-1196 (Symbolic Math Toolbox). Boxes of type `plot::Box` are always parallel to the coordinate axes. To have one with a different orientation, we must rotate it:

```
b0 := plot::Box(0..2, 1..3, 2..3):
b1 := plot::Rotate3d(b0, Center = [1, 2, 2.5],
                    Axis = [1, 1, 1], Angle = PI/5)
```

```
plot::Rotate3d( $\frac{\pi}{5}$ , Center = [1, 2, 2.5], Axis = [1, 1, 1], plot::Box(0..2, 1..3, 2..3))
```

```
plot(b0, b1)
```

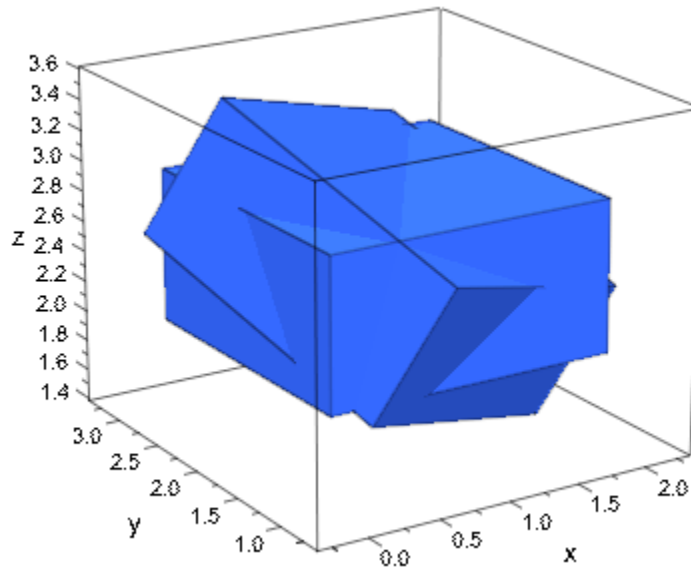

```
delete b0, b1:
```

### Example 5

Some graphic objects, e.g. `plot::Arc2d` and `plot::Pyramid`, also accept a rotation angle:

```
arc:= [3, 1], [0, 0], -PI/4..PI/4, Filled:  
plot(  
  plot::Arc2d(arc, Angle=0,      FillColor=RGB::Red),  
  plot::Arc2d(arc, Angle=1/2*PI, FillColor=RGB::Green),  
  plot::Arc2d(arc, Angle=PI,     FillColor=RGB::Yellow),  
  plot::Arc2d(arc, Angle=3/2*PI, FillColor=RGB::Blue)  
)
```



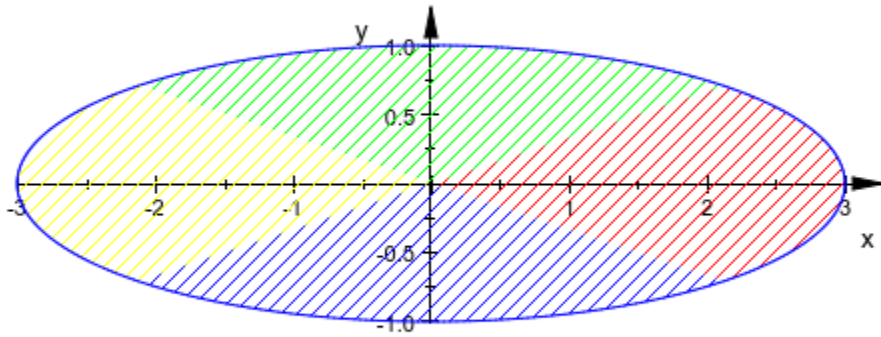

```
plot(plot::Pyramid(1/2, Angle=0),  
      plot::Pyramid(1/2, Angle=PI/4, FillColor2=RGB::Yellow))
```

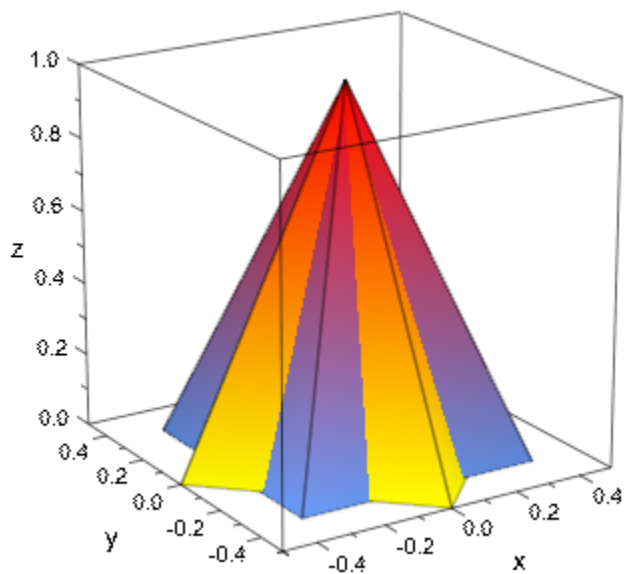

delete arc:

## See Also

**MuPAD Functions**  
Axis | Center

# AngleRangeAngleBeginAngleEnd

Angle range

## Value Summary

AngleRange	[AngleBegin .. AngleEnd]	Range on page 1-16 of arithmetical expressions
AngleBegin, AngleEnd	Optional	MuPAD expression

## Graphics Primitives

Objects	Default Values
plot::Tube, plot::XRotate, plot::ZRotate	AngleRange: 0 .. 2*PI AngleBegin: 0 AngleEnd: 2*PI
plot::Arc2d, plot::Arc3d	AngleRange: 0 .. PI/2 AngleBegin: 0 AngleEnd: PI/2

## Description

AngleRange, AngleBegin, AngleEnd define a range for the angle in circular arcs and surfaces of revolution.

For circular arcs of type plot::Arc2d, the attributes AngleBegin and AngleEnd define the starting point and the end point of the arc. The values are the usual polar angles measuring the angle to the positive x-axis in radians.

For surfaces of revolution of type `plot::XRotate` or `plot::ZRotate`, respectively, the attributes `AngleBegin` and `AngleEnd` define the starting point and the end point of the revolution.

For `plot::XRotate`, the values are the polar angles to the positive  $y$ -axis, specified in radians.

For `plot::ZRotate`, the values are the usual angles to the positive  $x$ -axis in radians, known from cylindrical coordinates.

Values for `AngleBegin` and `AngleEnd` may depend on the animation parameter and must evaluate to real numbers for any given time stamp.

`AngleRange` provides a shortcut for setting `AngleBegin` and `AngleEnd`. The attribute `AngleRange = a_1..a_2` is equivalent to `AngleBegin = a_1, AngleEnd = a_2`.

## Examples

### Example 1

We define a semi-circle as a circular arc with a range of the polar angle from 0 to 180 degrees (i.e.,  $\pi$  in radians):

```
arc := plot::Arc2d(1, 0 .. PI):  
plot(arc)
```

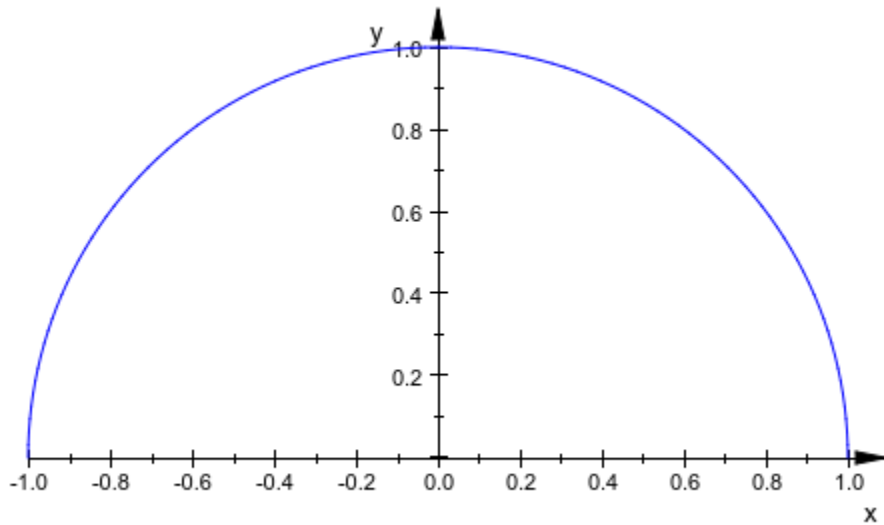

The range is stored as the attribute `AngleRange` in the object and can be accessed and changed:

```
arc::AngleBegin, arc::AngleEnd, arc::AngleRange
```

```
0,  $\pi$ ,  $0.. \pi$ 
```

```
arc::AngleRange := PI/2 .. 2*PI:  
plot(arc)
```

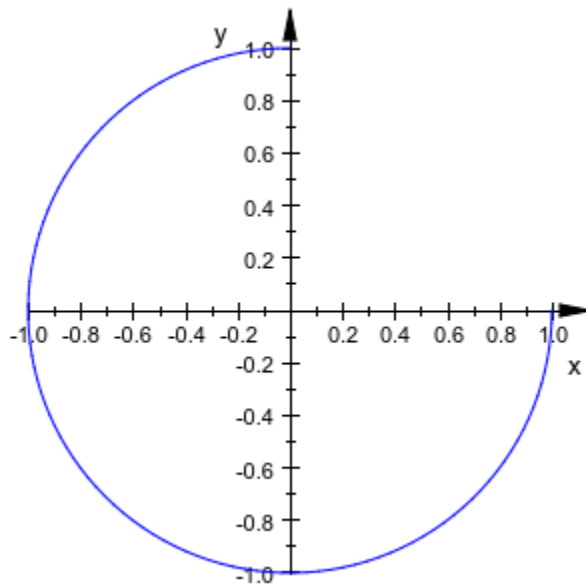

delete arc:

## Example 2

We leave gaps in the following surfaces of revolution by restricting the revolution angle:

```
plot(plot::XRotate(sin(x), x = 0 .. PI/2,  
      AngleRange = -0.8*PI .. 0.8*PI)):
```

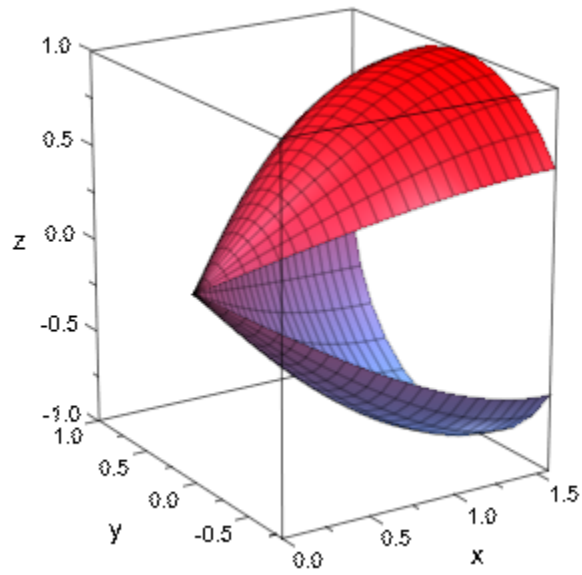

```
plot(plot::ZRotate(sin(x), x = 0 .. PI/2,  
  AngleRange = 0.3*PI .. 2*PI)):
```

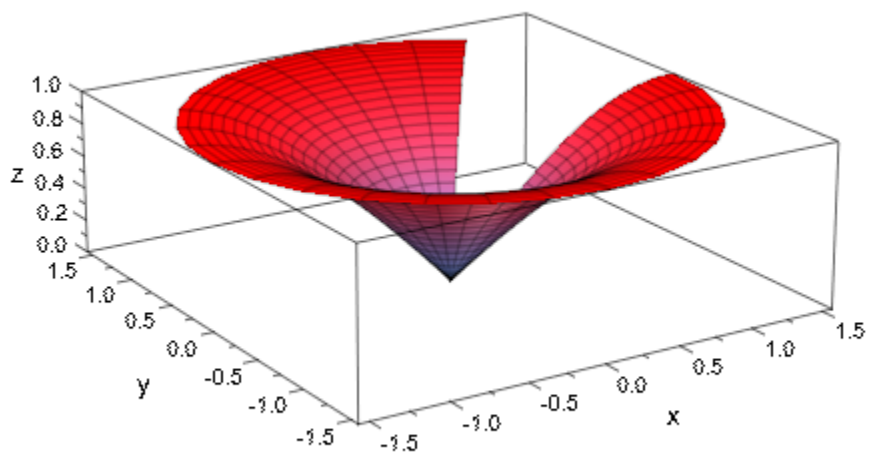



## Area

Area of a histogram plot

### Value Summary

Optional	Non-negative real number
----------	--------------------------

### Graphics Primitives

Objects	Area Default Values
<code>plot::Histogram2d</code>	0

### Description

Area determines whether bars of a histogram plot are scaled with respect to their heights or with respect to their areas, and by how much.

By default, the bars of a histogram plot use a height that is equal to the absolute number of data points in the corresponding cell. Using `Area`, the user can change this behavior to make the *areas* of the bars proportional to this number.

### Examples

#### Example 1

For any distribution with a continuous quantile, we can define, using `stats::equiprobableCells`, a list of  $n$  cells where each cell is “hit” with the same probability,  $\frac{1}{n}$ . By the law of large numbers, we expect the number of elements in each cell to be approximating  $\frac{N}{n}$  for large values of  $N$ , the number of samples:

```
X := stats::normalRandom(10, 1):
cells := stats::equiprobableCells(40,
    stats::normalQuantile(10, 1)):

N := 1000:
data := [X() $ i = 1..N]:
plot(plot::Histogram2d(data, Cells = cells))
```

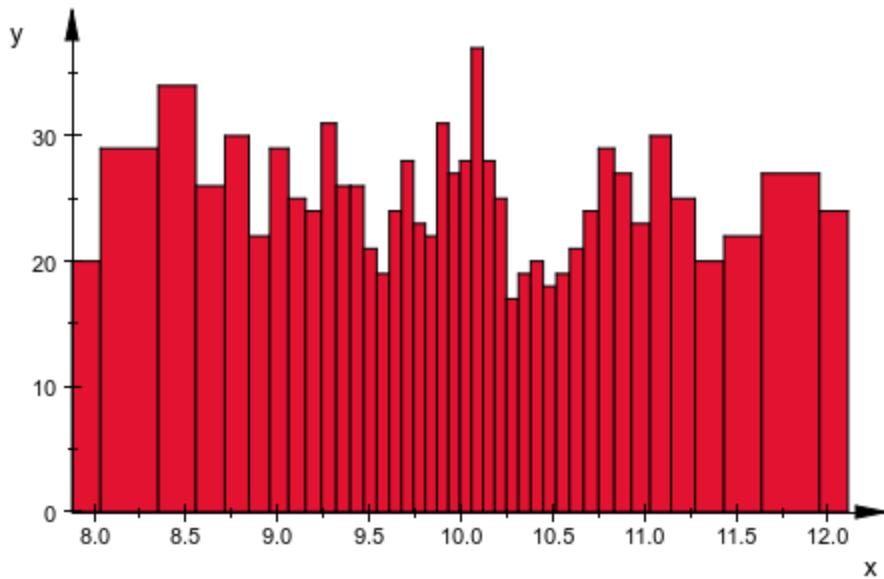

```
N := 10000:
data := [X() $ i = 1..N]:
plot(plot::Histogram2d(data, Cells = cells))
```

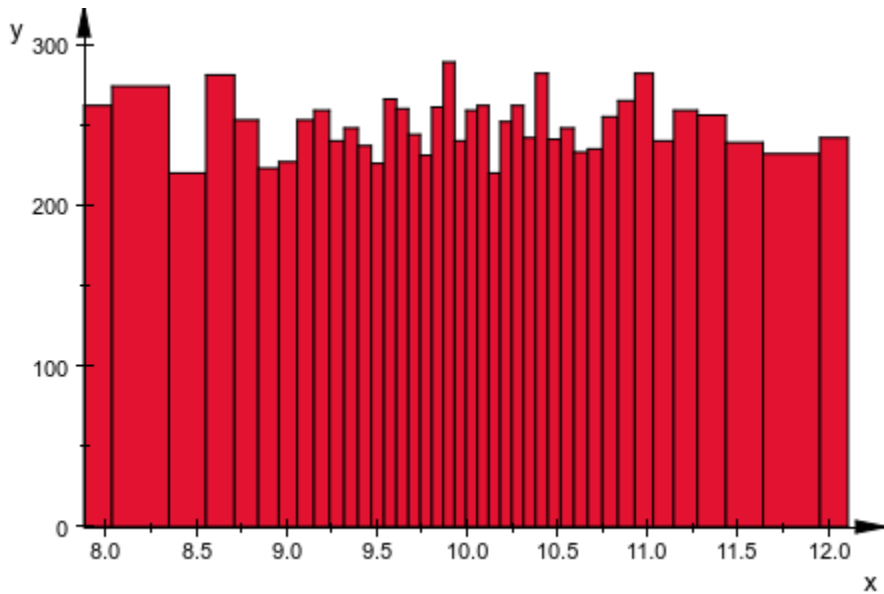

On the other hand, if we want to display a histogram as an approximation to the probability distribution, we want not the height, but rather the area of the rectangles to correspond to our measurements. Moreover, the sum of all areas should be 1, so we set `Area` to this value:

```
plot(plot::Histogram2d(data, Cells = cells, Area = 1))
```

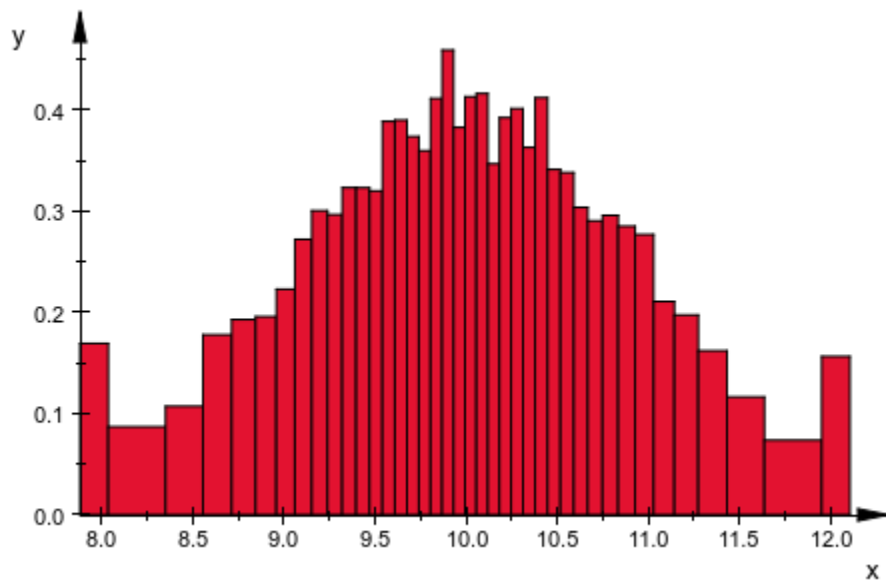

```
plot(plot::Histogram2d(data, Cells = cells, Area = 1),  
      plot::Function2d(stats::normalPDF(10,1)(x), x = 7..13,  
                        Color = RGB::Black, LineWidth = 0.5))
```

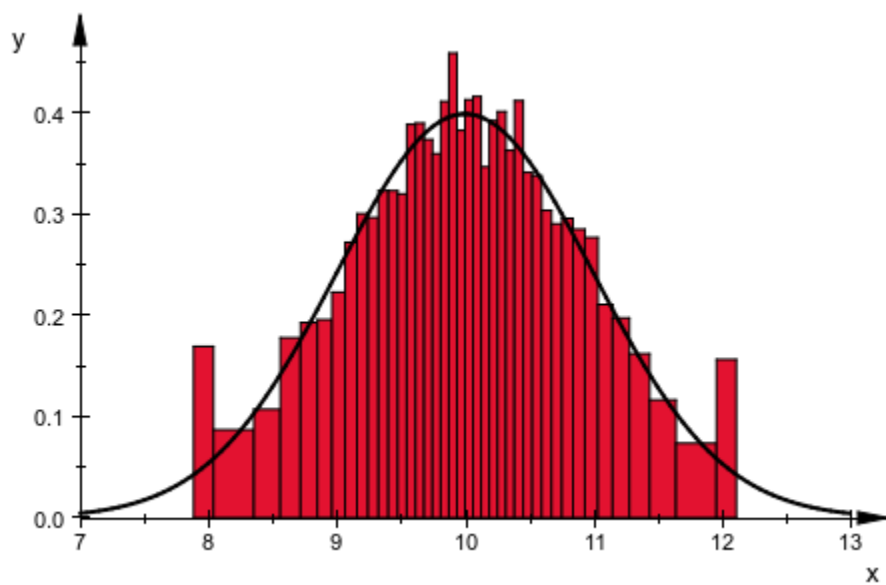

## See Also

**MuPAD Functions**  
Cells

## Averaged

Mode for computing quantile lines in box plots

## Value Summary

Optional	TRUE or FALSE
----------	---------------

## Graphics Primitives

Objects	Averaged Default Values
<code>plot::Boxplot</code>	TRUE

## Description

Statistical box plots indicate the 25%/50%/75% quantiles of data samples by horizontal lines. With the default `Averaged = TRUE`, the quantile lines are computed using `stats::empiricalQuantile` using the option `Averaged`.

A plot of type `plot::Boxplot` serves for visualizing and comparing statistical data samples. The plot reduces the data to few simple descriptive parameters.

A typical notched box looks like this:

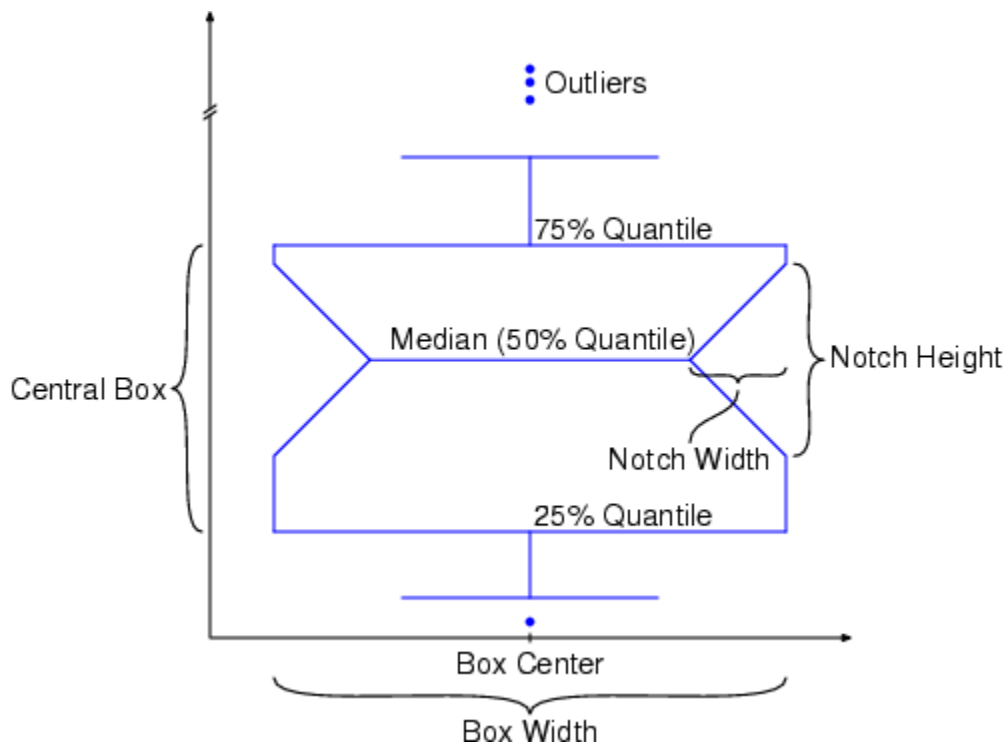

The location of the 25%/50%/75% quantile lines are computed internally via `stats::empiricalQuantile`. When using `Averaged = TRUE` in the box plot, the quantile function is called with the option `Averaged` (see the help page of `stats::empiricalQuantile` for details).

## Examples

### Example 1

By default, the quantile lines of the boxes are computed with the option `Averaged`. When using `Averaged = FALSE`, the quantiles are computed without this option:

```
r := random(0..10):
SEED := 123:
data := [r() $ k = 1..250]:
```

```
plot(  
  plot::Boxplot(data, Averaged = TRUE, BoxCenters = 0.5,  
                Color = RGB::Blue, Notched),  
  plot::Boxplot(data, Averaged = FALSE, BoxCenters = 1.5,  
                Color = RGB::Red, Notched)  
):
```

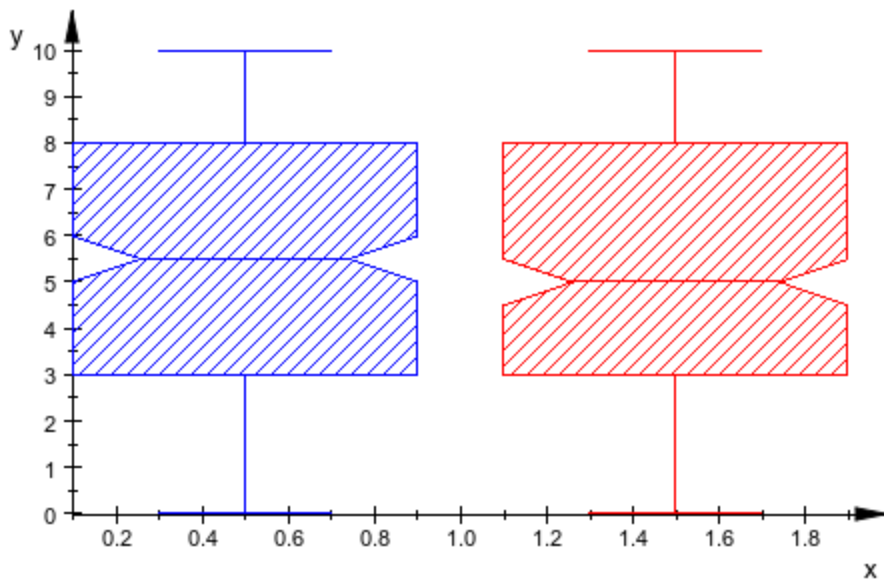

```
delete r, SEED, data:
```

## See Also

### MuPAD Functions

BoxCenters | BoxWidths | DrawMode | Notched



# AxisAxisXAxisYAxisZ

Rotation axis

## Value Summary

Axis	Library wrapper for “[AxisX, AxisY, AxisZ]” (3D)	List of 2 or 3 expressions, depending on the dimension
AxisX, AxisY, AxisZ	Optional	MuPAD expression

## Graphics Primitives

Objects	Default Values
plot::Rotate3d	Axis: [0, 0, 1] AxisX, AxisY: 0 AxisZ: 1

## Description

Axis is a vector determining the direction of the rotation axis in rotation objects of type plot::Rotate3d. It is given by a list of 3 components.

AxisX etc. refer to the  $x$ ,  $y$ ,  $z$  components of this vector.

A rotation in 3D is determined by a line around which is rotated. The line is given by a point on the line (the Center) and a direction vector (the Axis). The rotation angle is given by the attribute Angle.

The length of the Axis vector is of no relevance. However, it should not be zero.

The rotation is implemented following the “right hand rule”: Stretch the thumb of your right hand and bend the fingers. When the thumb points into the direction of the rotation

axis, your finger tips indicate the direction of the rotation. Use negative angles to rotate in the opposite direction or replace the Axis vector by its negative.

## Examples

### Example 1

A cone is first rotated around the x-axis. The rotated cone is then rotated around the z-axis:

```
c0 := plot::Cone(1, [0, 0, 1], [0, 0, 2]):
c1 := plot::Rotate3d(c0, Center = [0, 0, 0],
                    Axis = [1, 0, 0], Angle = PI/2):
c2 := plot::Rotate3d(c1, Center = [0, 0, 0],
                    Axis = [0, 0, 1], Angle = PI/2):
plot(plot::Scene3d(c0, Axes = Origin,
                  ViewingBox = [-2..2, -2..2, -2..2]),
     plot::Scene3d(c1, Axes = Origin,
                  ViewingBox = [-2..2, -2..2, -2..2]),
     plot::Scene3d(c2, Axes = Origin,
                  ViewingBox = [-2..2, -2..2, -2..2]),
     TicksNumber = None,
     Width = 120*unit::mm, Height = 40*unit::mm,
     Layout = Horizontal):
```

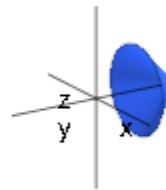
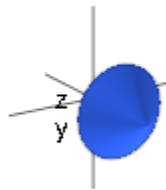
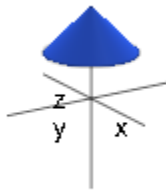

```
delete c0, c1, c2:
```

## Example 2

We illustrate the “right hand rule”. A small box `b0` is rotated. The rotated copies `b1`, `b2`, `b3` are plotted together with the original box:

```

center := [1, 4, 1]:
axis := [0, 0, 1]:
b0 := plot::Box(0.9..1.1, 2.9 .. 3.1, 0.9 .. 1.1):
b1 := plot::Rotate3d(b0, Center = center, Axis = axis,
                    Angle = PI/8):
b2 := plot::Rotate3d(b1, Center = center, Axis = axis,
                    Angle = PI/8):
b3 := plot::Rotate3d(b2, Center = center, Axis = axis,
                    Angle = PI/8):
centerplusaxis := [center[i] + axis[i] $ i = 1..3]:
plot(b0, b1, b2, b3,
     plot::Arrow3d([0, 0, 0], center, Color = RGB::Black,
                  Title = "Center",
                  TitlePosition = [0.1, 2, 0.5]),
     plot::Arrow3d(center, centerplusaxis,
                  Title = "Axis", Color = RGB::Red,
                  TitlePosition = [0.7, 4, 1.5]),
     plot::Circle3d(1, center, axis),
     plot::Rotate3d(plot::Arrow3d([0, 4, 1], [0, 3.9, 1],
                                 Color = RGB::Blue),
                   Axis = axis, Center = center,
                   Angle = 0.43*PI + a*2*PI/3) $ a = 1..3,
     Axes = Origin
):

```

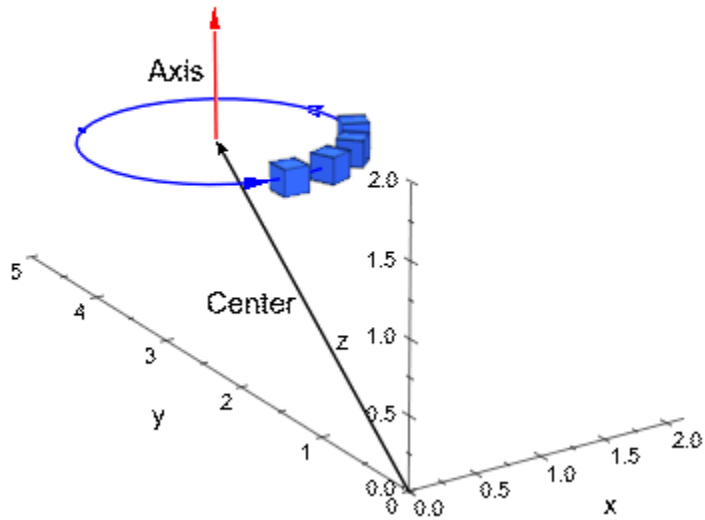

delete center, axis, b0, b1, b2, b3, centerplusaxis:

## See Also

**MuPAD Functions**  
Angle | Center

# BaseTopBaseXTopXBaseYTopYBaseZTopZ

Base center of cones, cylinders, pyramids and prisms

## Value Summary

Base	Library wrapper for “[BaseX, BaseY]” (2D), “[BaseX, BaseY, BaseZ]” (3D)	List of 2 or 3 expressions, depending on the dimension
Top	Library wrapper for “[TopX, TopY]” (2D), “[TopX, TopY, TopZ]” (3D)	List of 2 or 3 expressions, depending on the dimension
BaseX, BaseY, BaseZ, TopX, TopY, TopZ	Mandatory	MuPAD expression

## Graphics Primitives

Objects	Default Values
plot::Cone, plot::Cylinder, plot::Prism, plot::Pyramid	Base: [0, 0, 0] Top: [0, 0, 1] BaseX, TopX, BaseY, TopY, BaseZ: 0 TopZ: 1

## Description

Base is a vector determining the position of the base center of cones/conical frustums, cylinders, pyramids/frustums of pyramids and prisms. It is given by a list or vector of 3 components.

BaseX etc. refer to the  $x$ ,  $y$ ,  $z$  components of this vector.

Top is a vector determining the position of the top center of cones/conical frustums, cylinders, pyramids/frustums of pyramids and prisms. For a cone, this is the tip. The vector is given by a list or vector of 3 components.

TopX etc. refer to the  $x$ ,  $y$ ,  $z$  components of this vector.

The values of these attributes can be animated.

## Examples

### Example 1

We define a cone:

```
c := plot::Cone(1, [0, 0, 0], [0, 0, 1]):  
plot(c)
```

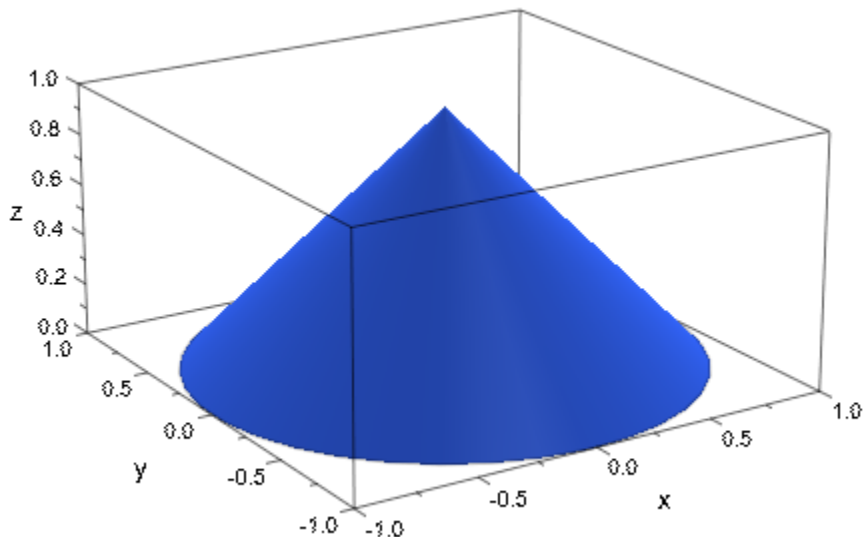

The second and third argument are the base center and the top center, respectively. Internally, they are stored as the attributes `Bottom` and `Top`. We can access the object's attributes and change them:

```
c::Base, c::Top
```

```
[0, 0, 0], [0, 0, 1]
```

```
c::Top := [0, 1, 1]:  
plot(c):
```

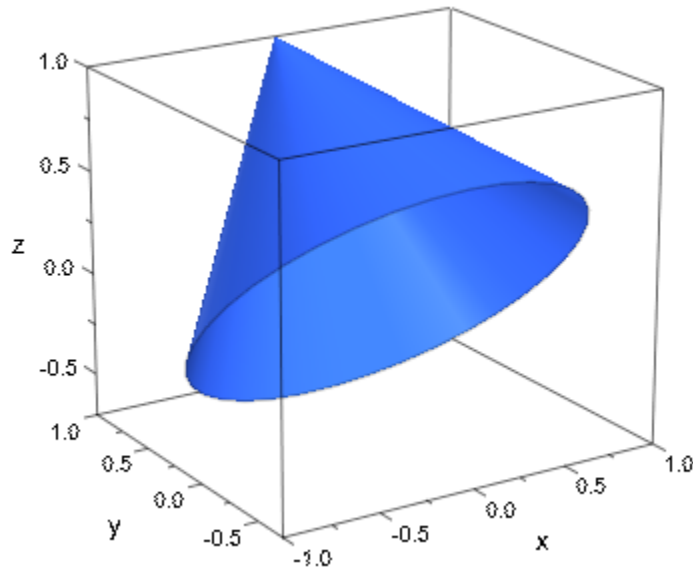

```
delete c:
```

## Example 2

The values of Bottom and Top can be animated:

```
plot(plot::Cylinder(3, [2, 2, 2], [2, 2, a], a = 7..12)):
```

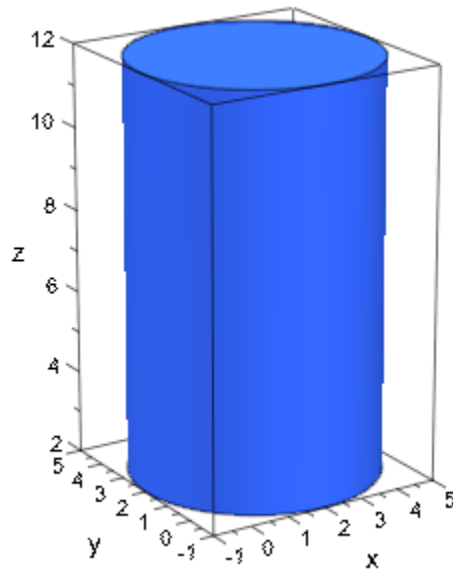

## See Also

**MuPAD Functions**  
BaseRadius | TopRadius



# BaseRadiusTopRadius

Base and top radius of cones/conical frustums and pyramids/frustums of pyramids

## Value Summary

BaseRadius, TopRadius	Mandatory	MuPAD expression
-----------------------	-----------	------------------

## Graphics Primitives

Objects	Default Values
plot::Cone, plot::Pyramid	BaseRadius: 1 TopRadius: 0

## Description

**BaseRadius** defines the radius of the base of a cone or the radius of the circumcircle of the regular base of a pyramid. **TopRadius** defines the radius  $r$  of the top of a conical frustum and the radius of the circumcircle of the top of a frustum of pyramid. With the default  $r = 0$ , a cone or pyramid, respectively, is created. You get a frustum for  $r > 0$ .

The values of these attributes can be animated.

## Examples

### Example 1

We draw two cones forming an hour glass:

```
c := plot::Cone(3, [2, 2, 2], [2, 2, 6]):
d := plot::Cone(3, [2, 2, 10], [2, 2, 6]):
plot(c, d)
```

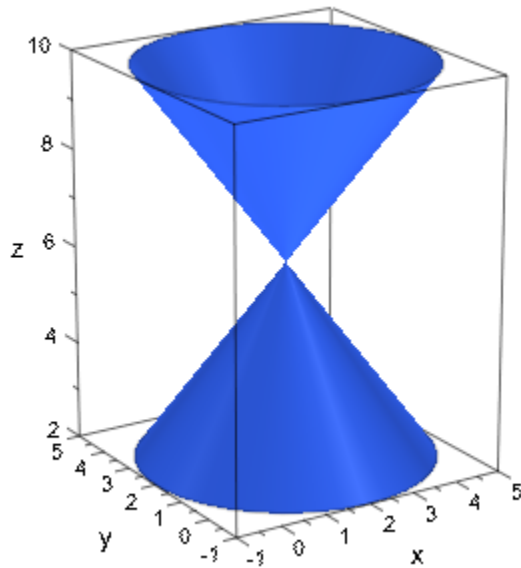

The first argument is the base radius of the cone. Internally, it is stored as the attribute `BaseRadius`. We can access the objects' attributes and change them:

```
c::BaseRadius, d::TopRadius
```

```
3, 0
```

```
c::BaseRadius := 0: c::TopRadius := 3:  
d::BaseRadius := 0: d::TopRadius := 3:  
plot(c, d):
```

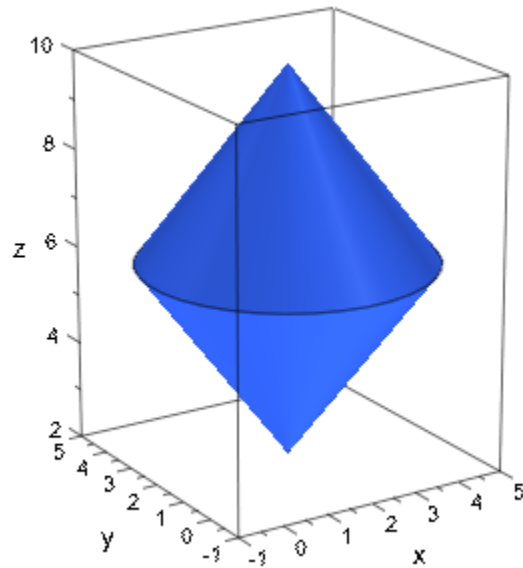

delete c, d:

## Example 2

The values of BaseRadius and TopRadius can be animated:

```
plot(plot::Cone(a, [0, 0, 0], 1 - a, [0, 0, 1], a = 0..1)):
```

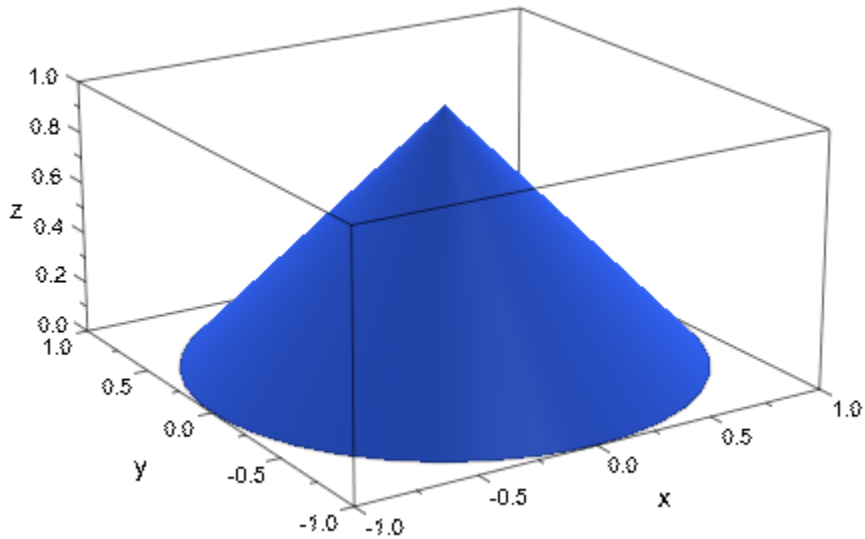

### Example 3

For a pyramid and a frustum of pyramid, the attributes `BaseRadius` and `TopRadius` determine the radius of the circumcircle of its regular base and top:

```
plot(plot::Prism(1,Edges=5), plot::Circle3d(1)):
```

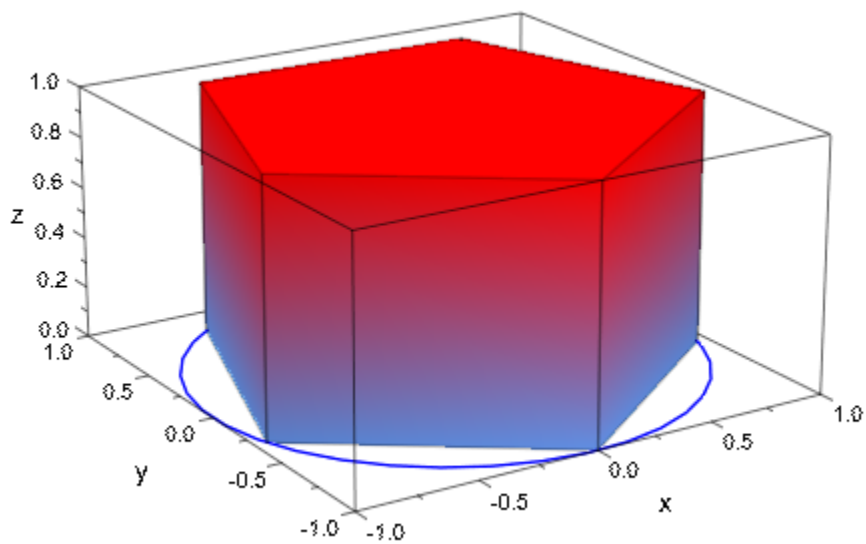

## See Also

### MuPAD Functions

Base | Top

## Cells

Classes of histogram plots

### Value Summary

Mandatory	List of arithmetical expressions
-----------	----------------------------------

### Graphics Primitives

Objects	Cells Default Values
<code>plot::Histogram2d</code>	[7]

### Description

`Cells` determines the number and position of the classes used in a histogram on page 24-358.

`Cells` accepts either a single positive integer (or, equivalently, a list of one positive integer) or a list of cells given as ranges on page 1-16 or lists of two elements.

A single integer  $n$  in the specification `Cells = n` or `Cells = [n]` is interpreted as “subdivide the range of data into  $n$  cells of equal size.”

The number  $n$  can be animated. In this case,  $n$  may be a symbolic expression of the animation parameter.

The cells may be specified directly as in `Cells = [[a1, b1], [a2, b2], ...]` or `Cells = [a_1..b_1, a_2..b_2, Symbol::dots]`.

---

**Note** The  $i$ -th cell is the semi-open interval  $(a_i, b_i]$ , i.e., a datum  $x$  is tallied into the  $i$ -th cell if  $a_i < x \leq b_i$  is satisfied.

---

The cell boundaries must satisfy  $a_1 < b_1 \leq a_2 < b_2 \leq a_3 < \dots$ . In most applications,  $b_1 = a_2$ ,  $b_2 = a_3$  etc. is appropriate.

If giving cells directly, the leftmost border may be - infinity and the rightmost border may be infinity. These rectangles will then be adjusted according to the average widths of the other rectangles for display purposes.

With the attribute `CellsClosed = Left`, the cells `[a_1..b_1, a_2..b_2, Symbol::dots]` are interpreted as the semi-open intervals  $[a_i, b_i)$ .

## Examples

### Example 1

We create a sample of 1000 data points and plot a histogram of them:

```
X := stats::fRandom(100, 10):
data := [X() $ i = 1..1000]:
plot(plot::Histogram2d(data))
```

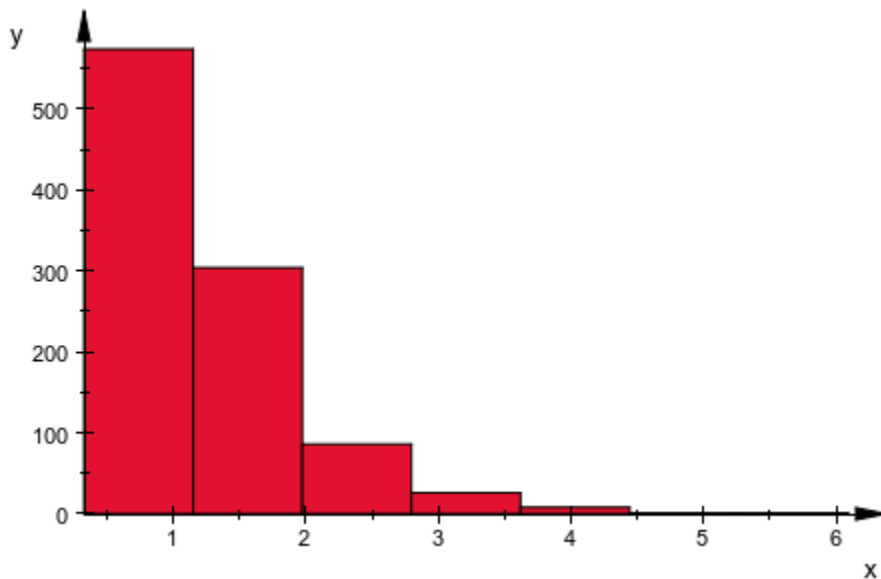

The shape of the distribution becomes much better visible when we increase the number of cells:

```
plot(plot::Histogram2d(data, Cells = 40))
```

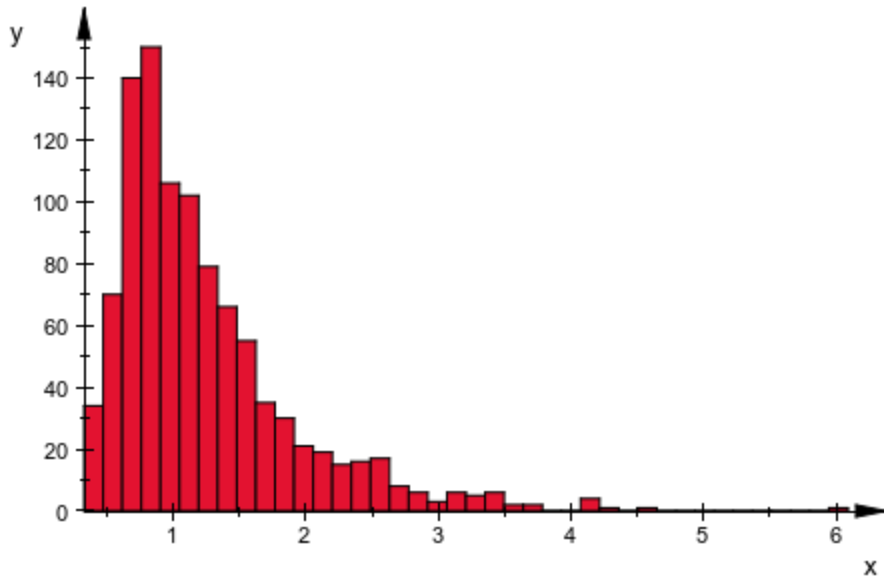

```
plot(plot::Histogram2d(data, Cells = [40], Area = 1),  
      plot::Function2d(stats::fPDF(100,10)(x), x = 0 .. 5,  
                        Color = RGB::Black))
```



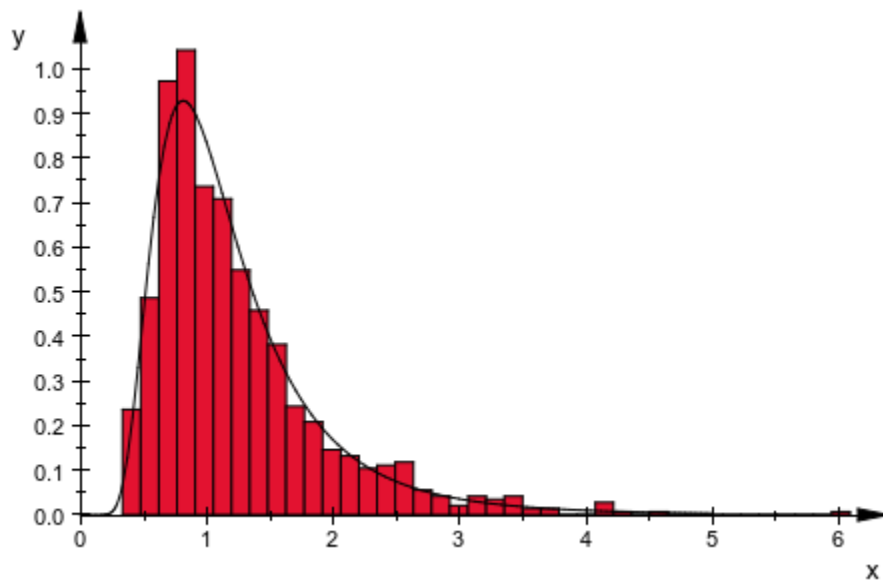

With cells of different widths, setting `Area` to a positive value is highly recommended, to still have the histogram follow the probability distribution:

```
cells := stats::equiprobableCells(50,  
    stats::fQuantile(100, 10))  
plot(plot::Histogram2d(data, Cells = cells)):
```

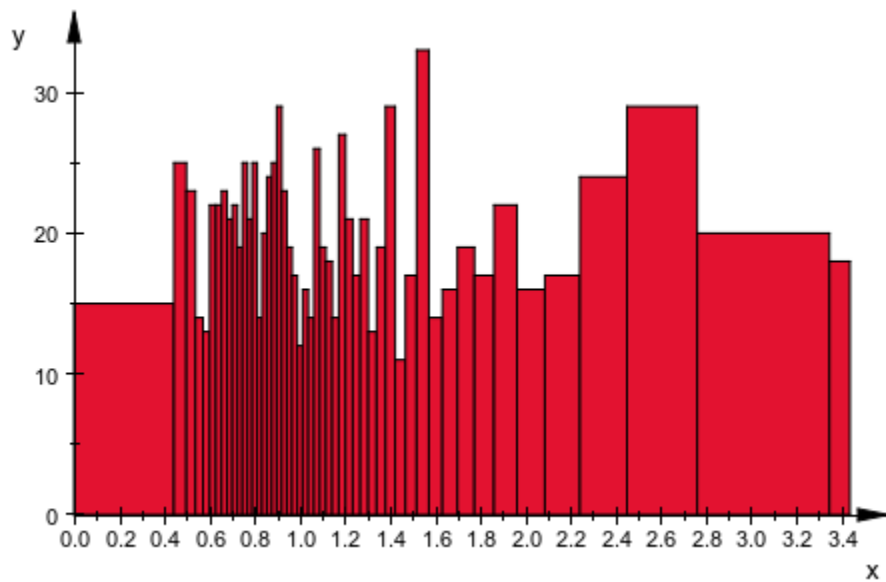

```
plot(plot::Histogram2d(data, Cells = cells, Area = 1),  
      plot::Function2d(stats::fPDF(100, 10)(x), x = 0 .. 5,  
                        Color = RGB::Black))
```

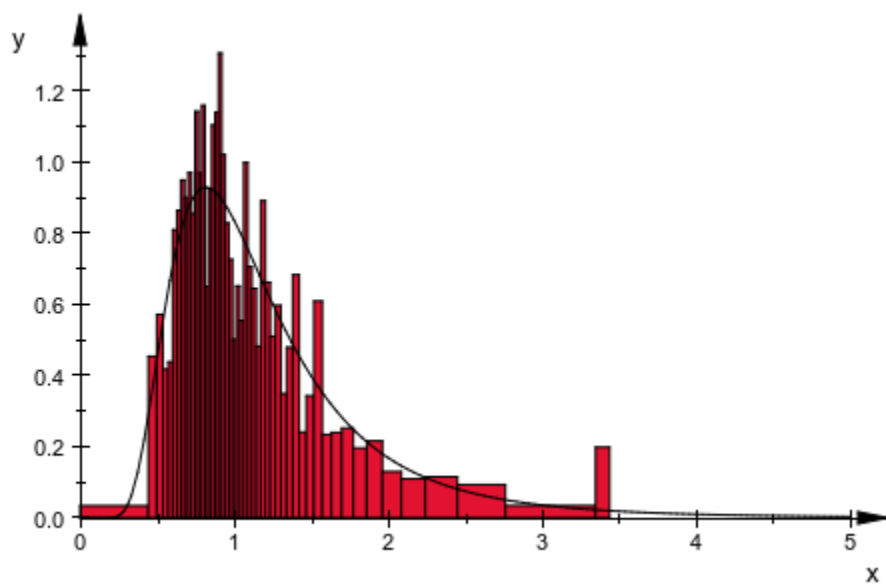

## See Also

**MuPAD Functions**  
Area | CellsClosed

## CellsClosedClassesClosed

Interpretation of the classes in histogram plots

### Value Summary

CellsClosed	Optional	Left, or Right
ClassesClosed	[[CellsClosed]]	See below

### Graphics Primitives

Objects	Default Values
plot::Histogram2d	CellsClosed, ClassesClosed: Right

### Description

CellsClosed determines whether the classes used in a histogram on page 24-358 are interpreted as semi-open intervals that are closed at the left or the right boundary.

The graphical primitive plot::Histogram2d on page 24-358 tallies numerical data into cells (“classes”) that are defined by the attribute Cells = [a\_1 .. b\_1, a\_2 .. b\_2, dots]. By default, these classes are interpreted as a collection of semi-open intervals

$(a_i, b_i]$  that are closed at the right boundary. A data item  $x$  is tallied into the  $i$ -th cell if it satisfies  $a_i < x \leq b_i$ . With the option CellsClosed = Left or the equivalent

ClassesClosed = Left the classes are interpreted as the semi-open intervals  $[a_i, b_i)$  that are closed at the left boundary.

## Examples

### Example 1

We create a sample of 15 data points:

```
data := [1, 2, 2, 3, 3, 3, 4, 4, 4, 4, 5, 5, 5, 5, 5]:
```

These data are to be tallied into the following cells (classes):

```
cells := [0 .. 1, 1 .. 2, 2 .. 3, 3 .. 4, 4 .. 5, 5 .. 6]:
```

With the default setting `CellsClosed = Right`, the 6 classes are the intervals  $(0, 1]$ ,  $(1, 2]$ ,  $(2, 3]$  etc. The interval  $(0, 1]$  contains one of the data items, the interval  $(1, 2]$  contains two, etc.:

```
plot(plot::Histogram2d(data, Cells = cells))
```

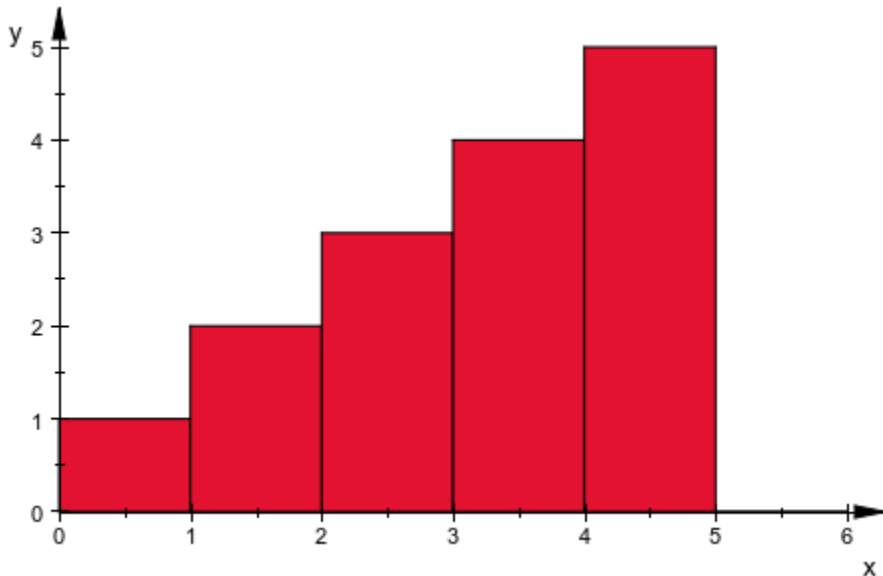

Using `CellsClosed = Left`, the 6 classes are interpreted as the intervals  $[0, 1)$ ,  $[1, 2)$ ,  $[2, 3)$  etc. Now, the first class  $[0, 1)$  contains none of the data items, the second class  $[1, 2)$  contains one item, etc.:

```
plot(plot::Histogram2d(data, Cells = cells, CellsClosed = Left))
```

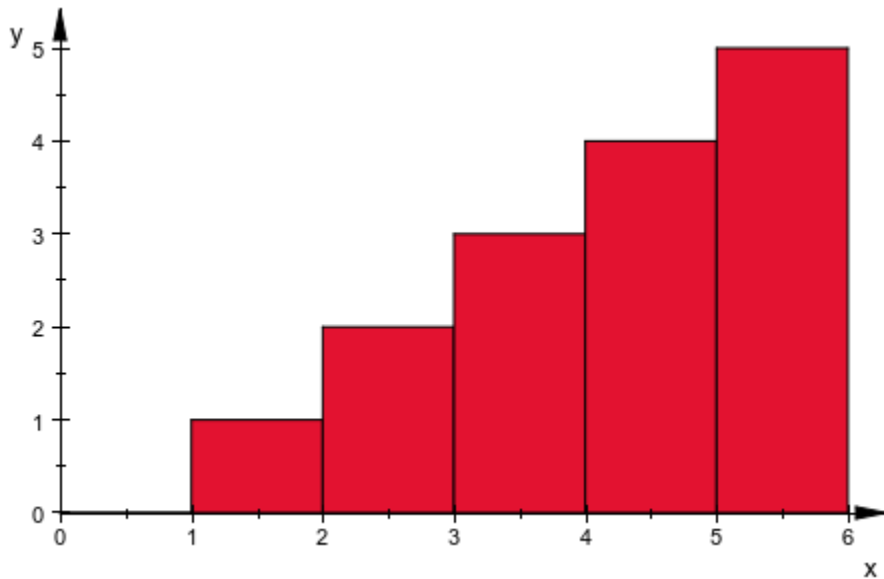

```
delete data, cells:
```

## See Also

### MuPAD Functions

Area | Cells

# CenterCenterXCenterYCenterZ

Center of objects, rotation center

## Value Summary

Center	Library wrapper for "[CenterX, CenterY]" (2D), "[CenterX, CenterY, CenterZ]" (3D)	List of 2 or 3 expressions, depending on the dimension
CenterX, CenterY, CenterZ	Mandatory	MuPAD expression

## Graphics Primitives

Objects	Default Values
plot::Arc3d, plot::Circle3d, plot::Dodecahedron, plot::Ellipse3d, plot::Ellipsoid, plot::Hexahedron, plot::Icosahedron, plot::MuPADCube, plot::Octahedron, plot::Parallelogram3d, plot::Piechart3d, plot::Rotate3d, plot::Sphere, plot::Tetrahedron, plot::Waterman	Center: [0, 0, 0]  CenterX, CenterY, CenterZ: 0
plot::Arc2d, plot::Circle2d, plot::Ellipse2d, plot::Parallelogram2d, plot::Piechart2d, plot::Rotate2d	Center: [0, 0]  CenterX, CenterY: 0

## Description

The vector `Center` determines the center of various objects such as circles, spheres, pie charts etc. In rotation objects, it refers to the center of rotation.

Depending on the dimension of the object, it is given by a list or vector of 2 or 3 components.

`CenterX` etc. refer to the  $x$ ,  $y$ ,  $z$  components of this vector.

`Center`, `CenterX` etc. also denotes the rotation center in rotation objects of type `plot::Rotate2d` or `plot::Rotate3d`.

The values of these attributes can be animated.

## Examples

### Example 1

We create circles around the origin:

```
c1 := plot::Circle2d(1, [0, 0]):  
c2 := plot::Circle2d(2, [0, 0]):
```

The second argument in `plot::Circle2d` is the center. Internally, it is stored as the attribute `Center` and can be changed by assigning a new value:

```
c1::Center := [1, 0]:  
c2::Center := [-1, 1]:  
plot(c1, c2):
```



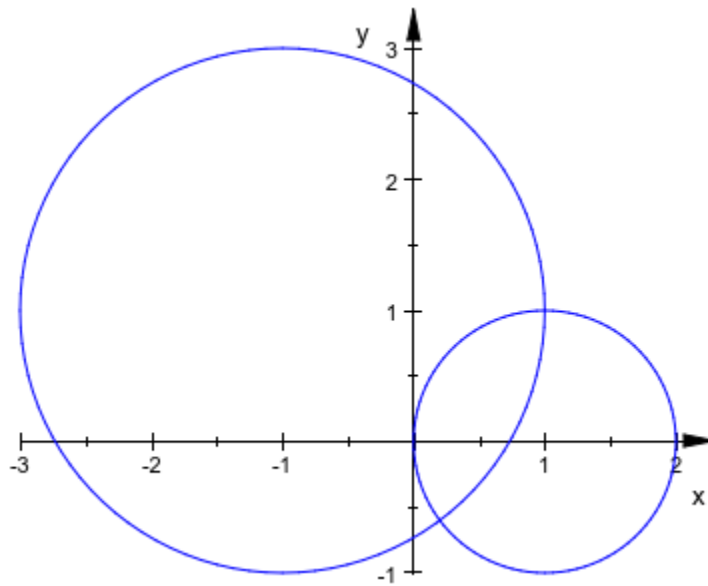

```
delete c1, c2:
```

## Example 2

We create an ellipse with an animated center. A copy of it is rotated around this center:

```
e1 := plot::Ellipse2d(1, 3, Center = [a, a], a = 0..5):  
e2 := plot::Rotate2d(e1, Angle = a*PI/2,  
                    Center = e1::Center, a = 0..5):  
plot(e1, e2)
```

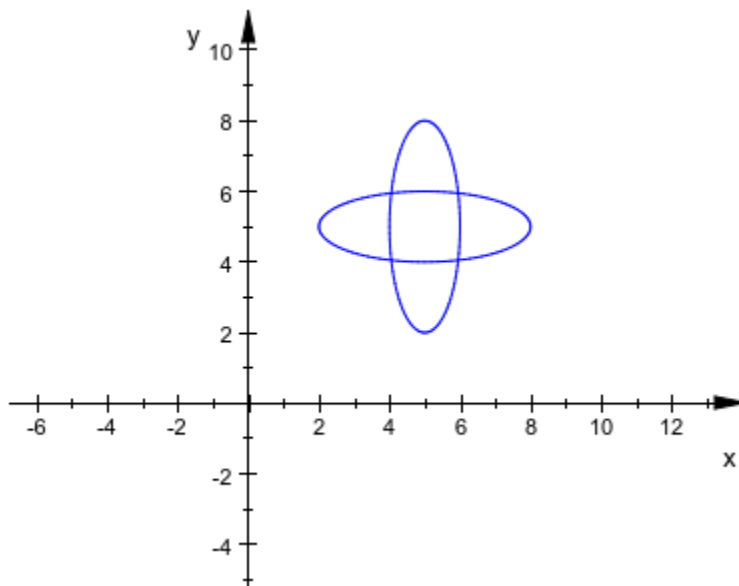

```
delete e1, e2:
```

### Example 3

We create a sphere of radius 2 and change the default center  $[0, 0, 0]$  to  $[1, 2, 3]$ :

```
s := plot::Sphere(2):  
s::Center := [1, 2, 3]:  
plot(s)
```

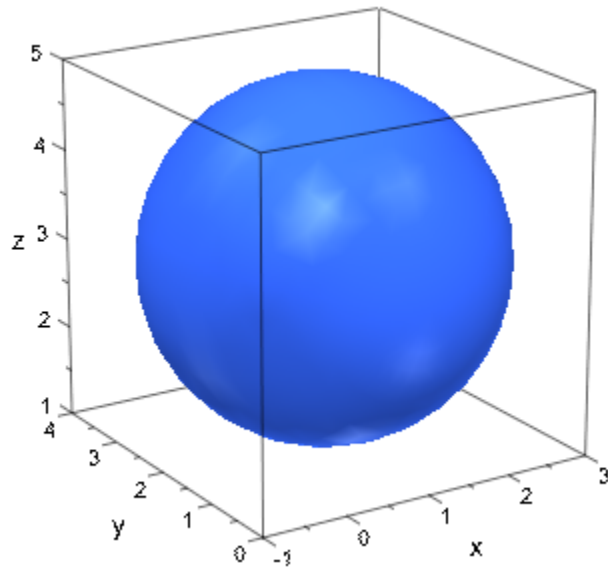

delete s:

## See Also

**MuPAD Functions**  
Radius | SemiAxes

## Closed

Open or closed polygons

### Value Summary

Inherited	FALSE, or TRUE
-----------	----------------

### Graphics Primitives

Objects	Closed Default Values
<code>plot::Arc2d</code> , <code>plot::Arc3d</code> , <code>plot::Polygon2d</code> , <code>plot::Polygon3d</code>	FALSE

### Description

Closed switches between open and closed polygons.

Closed determines whether objects of type `plot::Polygon2d` and `plot::Polygon3d` are drawn as “real” polygons (i.e., closed) or as broken lines (open polygons).

Open polygons can be filled, too. The filled area is exactly the same as if the polygon were closed.

### Examples

#### Example 1

By default, polygons are not closed automatically:

```
p := plot::Polygon2d([[1, 2], [3, 4], [5, -6]]):  
plot(p)
```

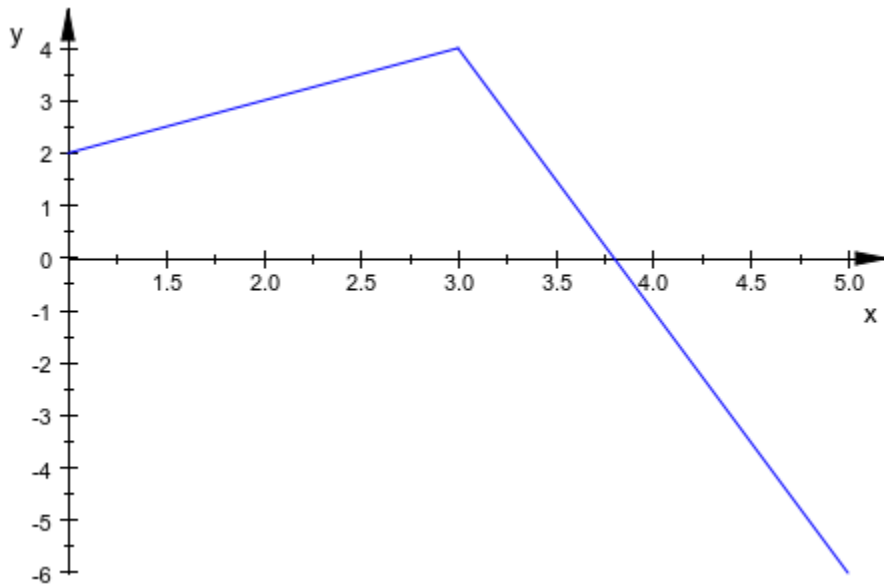

```
p := plot::Polygon2d([[1, 2], [3, 4], [5, -6]], Closed = TRUE):  
plot(p)
```

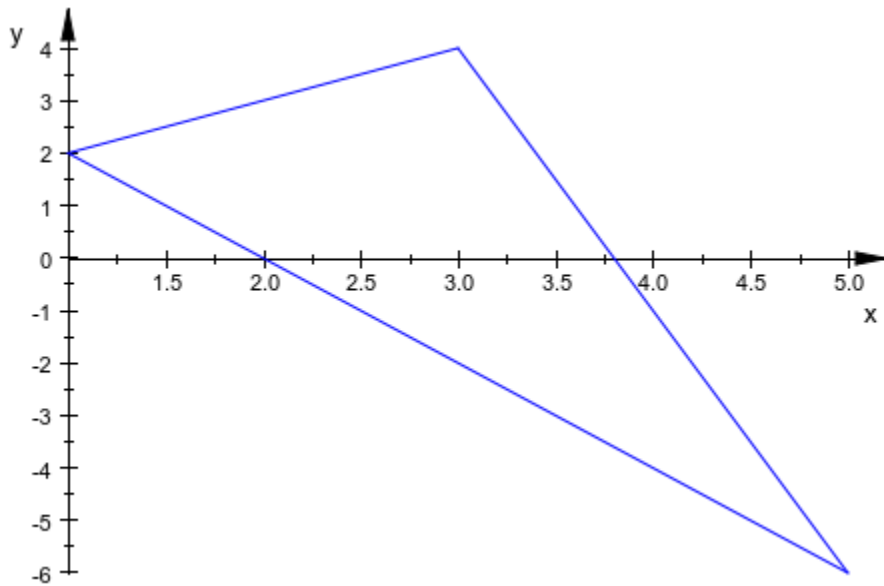

Note that Filled and Closed are independent:

```
p::Closed := FALSE:  
p::Filled := TRUE:  
plot(p)
```

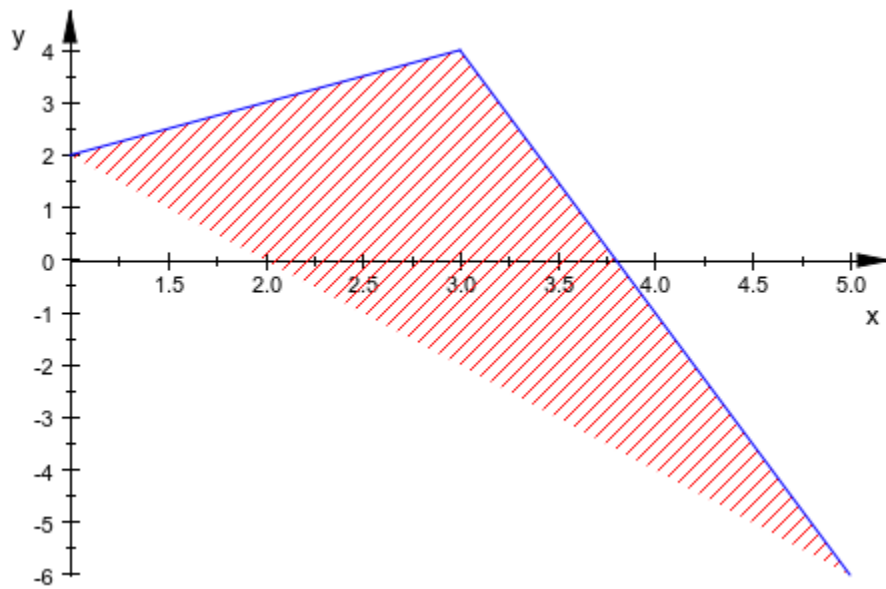

delete p:

## See Also

**MuPAD Functions**  
Filled

## ColorData

Color values of a raster plot

### Value Summary

Mandatory	List of arithmetical expressions
-----------	----------------------------------

### Graphics Primitives

Objects	ColorData Default Values
<code>plot::Raster</code>	

### Description

`ColorData` is a nested list of RGB (Symbolic Math Toolbox) color values visualized by a `plot::Raster` object.

The internal representation of the `ColorData` entry of a `plot::Raster` object is a list of lists of color values. Also a matrix or a 2-dimensional array of color values can be assigned to this entry: they are converted to a list of lists.

### Examples

#### Example 1

We create a raster plot object:

```
colordata := [[RGB::Red,   RGB::Green, RGB::Blue ],  
              [RGB::Black, RGB::Cyan,  RGB::White]]:  
r := plot::Raster(colordata, x = 0..3, y = 0..2):  
plot(r):
```



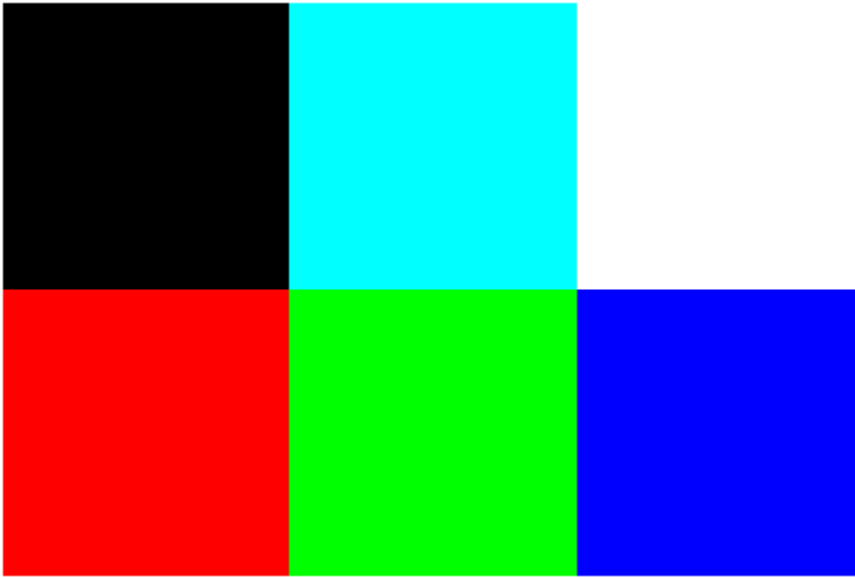

The color data of the raster object can be accessed via the ColorData slot:

```
colordata := r::ColorData
```

```
[[[1.0, 0.0, 0.0], [0.0, 1.0, 0.0], [0.0, 0.0, 1.0]], [[0.0, 0.0, 0.0], [0.0, 1.0, 1.0],
[1.0, 1.0, 1.0]]]
```

The list of list of color values is turned into an array. After changing one entry, the new colors are written back into the raster object:

```
colordata := array(1..2, 1..3, colordata):
colordata[2, 3] := RGB::Magenta:
colordata
```

```
( [1.0, 0.0, 0.0] [0.0, 1.0, 0.0] [0.0, 0.0, 1.0]
  [0.0, 0.0, 0.0] [0.0, 1.0, 1.0] [1.0, 0.0, 1.0] )
```

```
r::ColorData := colordata:
plot(r)
```

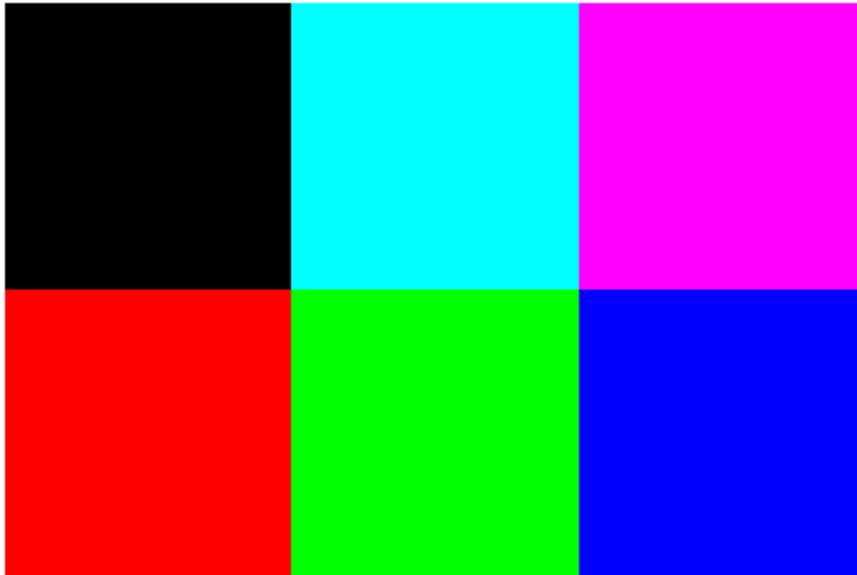

Although the color values were assigned as an array, they are internally stored as a list of lists:

```
r::ColorData
```

```
[[[1.0, 0.0, 0.0], [0.0, 1.0, 0.0], [0.0, 0.0, 1.0]], [[0.0, 0.0, 0.0], [0.0, 1.0, 1.0],  
[1.0, 0.0, 1.0]]]
```

```
delete colordata, r:
```

# CommandList

Turtle movement commands

## Value Summary

Mandatory	List of arithmetical expressions
-----------	----------------------------------

## Graphics Primitives

Objects	CommandList Default Values
<code>plot::Turtle</code>	<code>[]</code>

## Description

`CommandList` stores the command sequence of a `plot::Turtle`. See the documentation of `plot::Turtle` for admissible commands and examples.

## Contours

Contours of an implicit function

### Value Summary

Mandatory	List of arithmetical expressions
-----------	----------------------------------

### Graphics Primitives

Objects	Contours Default Values
<code>plot::Implicit2d</code> , <code>plot::Implicit3d</code>	[0]

### Description

With `Contours`, you can set the contour(s) of an implicit function.

By default, `plot::Implicit2d` and `plot::Implicit3d` plot the set

$f^{-1}(0) = \{x \mid f(x) = 0\}$ . Using `Contours`, you can instead plot the set  $f^{-1}(c)$  for any real  $c$  or for a sequence of such values.

### Examples

#### Example 1

The following command plots a series of cuts through a sphere:

```
plot(plot::Implicit2d(x^2 + y^2, x = -1..1, y = -1..1,  
    Contours = [0, 0.25^2, 0.5^2,  
    0.75^2, 1.0])):
```

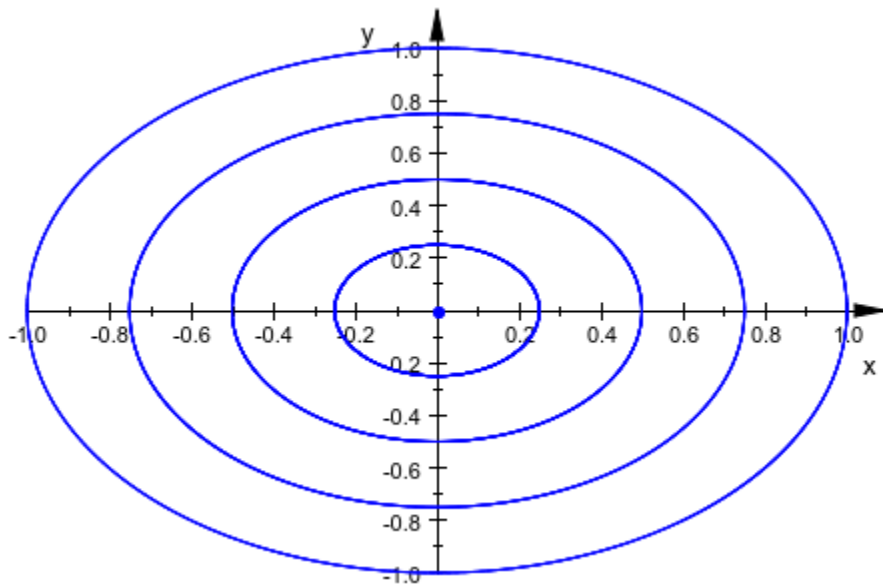

## Example 2

Being an expression attribute, `Contours` can be animated:

```
plot(plot::Implicit2d(x^2-y^2, x = -1..1, y = -1..1,  
  Contours = [1/2*cos(a)], a = 0..2*PI)):
```

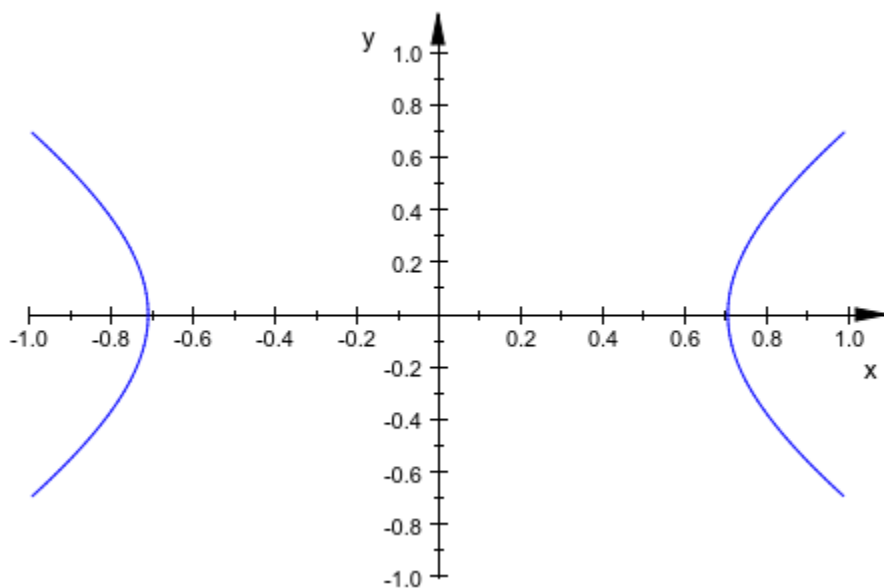

### Example 3

The contour currently plotted is passed to the color functions and can be used to distinguish them visually:

```
plot(  
  plot::Implicit3d(x^y - y*z, x = 1..4, y = 1..4, z = -2..2,  
    Contours = [$0..5],  
    FillColorFunction = ((x,y,z,dx,dy,dz,c) ->  
      RGB::ColorList[round(c)+1]))  
)
```

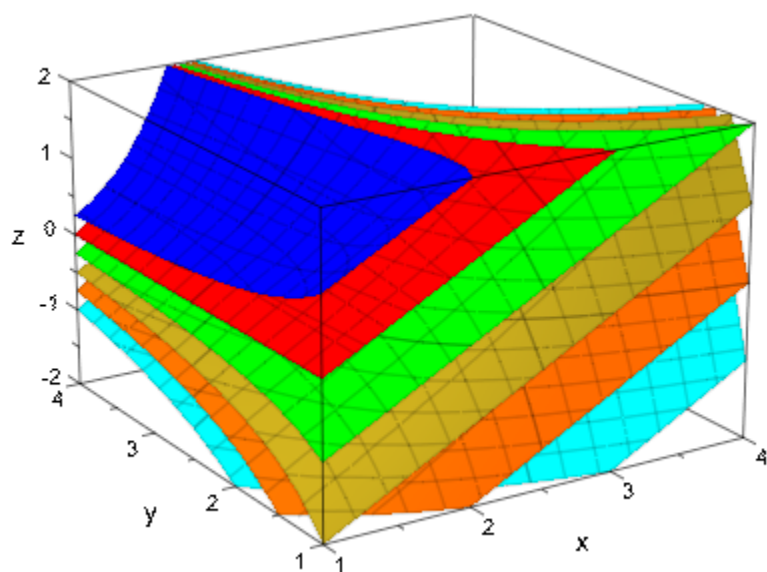

## CoordinateType

Linear versus logarithmic plots in 2D

### Value Summary

Inherited	See below
-----------	-----------

### Graphics Primitives

Objects	CoordinateType Default Values
plot::CoordinateSystem2d	LinLin

### Description

CoordinateType allows to switch between linear and logarithmic 2D plots.

By default, a linear (Cartesian) scaling of all coordinate axes is used in 2D. This corresponds to `CoordinateType = LinLin`. Logarithmic plots are created by choosing a `CoordinateType` different from `LinLin`.

In 2D, the following coordinate types are available:

- **LinLin**: Straight lines given by  $y = c_1 x + c_2$  are rendered as straight lines on the screen.
- **LinLog**: Linear coordinates are plotted along the horizontal axis, logarithmic coordinates along the vertical axis. The curves  $y = e^{c_1 x + c_2}$  are rendered as straight lines on the screen.
- **LogLin**: Logarithmic coordinates are plotted along the horizontal axis, linear coordinates along the vertical axis. The curves  $y = c_1 \ln(x) + c_2$  are rendered as straight lines on the screen.
- **LogLog**: Logarithmic coordinates are plotted along both axes. The curves  $y = c_1 x^{c_2}$  are rendered as straight lines on the screen.



The objects to be plotted must have strictly positive coordinate values in “logarithmic directions”.

## Examples

### Example 1

We consider an exponential function:

```
plot(plot::Function2d(5*exp(x/4), x = -10 .. 100),  
      CoordinateType = LinLin):
```

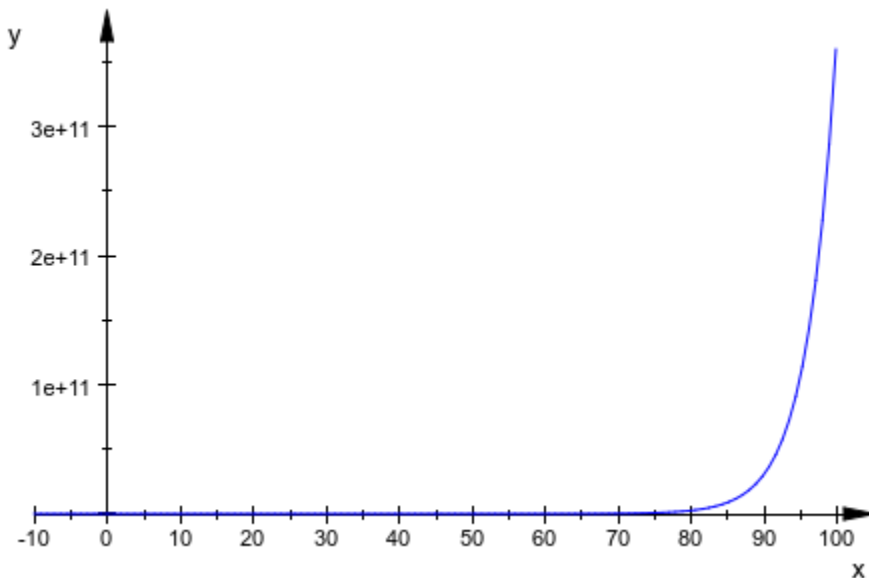

In a singly logarithmic plot, the graph is a straight line:

```
plot(plot::Function2d(5*exp(x/4), x = 0 .. 100),  
      CoordinateType = LinLog):
```

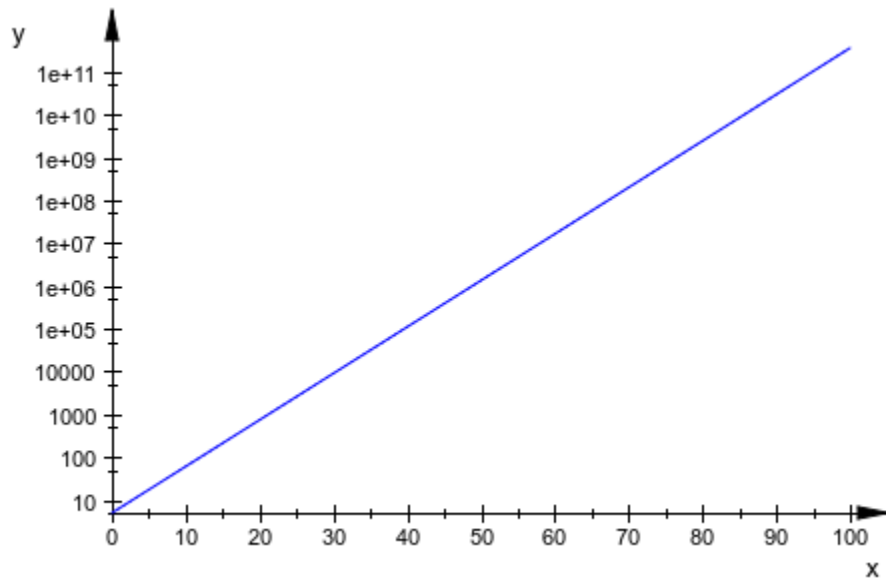

## Example 2

We render the function  $y = \sqrt{x} + x^2$  in a log-log plot:

```
plot(plot::Function2d(sqrt(x) + x^2, x = 10^(-3) .. 10^3),  
      CoordinateType = LogLog):
```

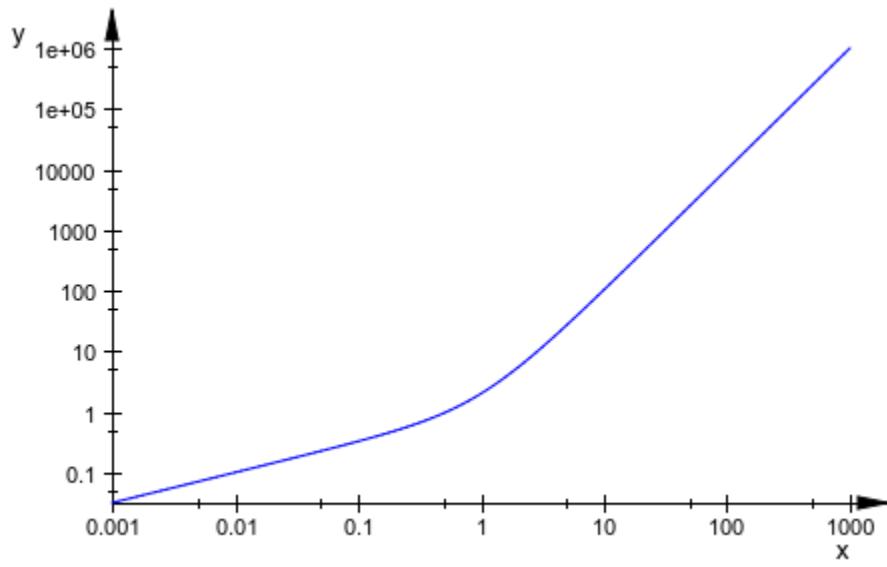

## Data

The (statistical) data to plot

## Value Summary

Mandatory	List of arithmetical expressions
-----------	----------------------------------

## Graphics Primitives

Objects	Data Default Values
plot::Bars2d, plot::Bars3d, plot::Boxplot, plot::Histogram2d, plot::Listplot, plot::Matrixplot, plot::QQplot, plot::Scatterplot, plot::SparseMatrixplot	
plot::Piechart2d, plot::Piechart3d	[1]

## Description

Data is used internally to store the statistical data displayed, for example, in a pie-chart diagram. While it is possible to manipulate this data (as shown in “Example 2” on page 24-1261 (Symbolic Math Toolbox)), Data is mostly seen as a storage space irrelevant to the user.

For speed and clarity, Data will be displayed in the object inspector (Symbolic Math Toolbox) only if the amount of data is small. This may cause problems when using the “recalculate” feature. In such a case, the remedy is to assign on page 1-257 the plot object in question to an identifier on page 7-29 before plotting.

## Examples

### Example 1

All object types listed above store the data given in Data:

```
X := stats::normalRandom(0, 1):  
h := plot::Histogram2d([X() $ i = 1..30])
```

```
plot::Histogram2d(...)
```

```
h::Data
```

```
[-0.5297400457, -0.5694234147, -0.5161446272, -1.090814471, ..., -0.3119111074,  
0.1868437371, -0.7818045527]
```

### Example 2

It is possible to change the data in an object using Data:

```
p := plot::Piechart2d([1, 2, 3, 4]):  
plot(p)
```

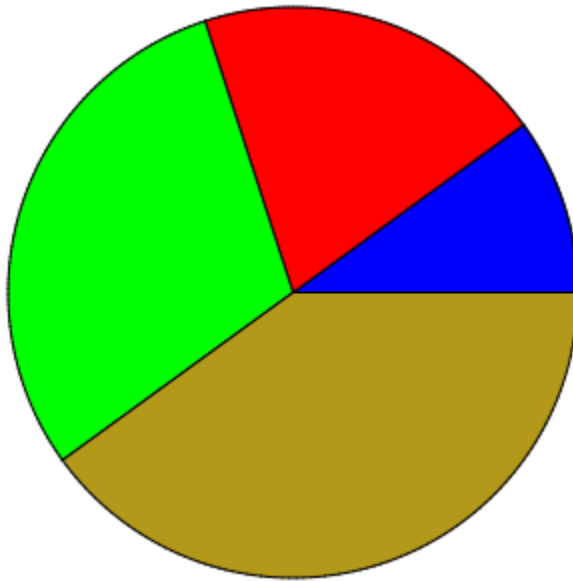

```
p::Data := [1, 1, 3, 2, 3]:  
plot(p)
```

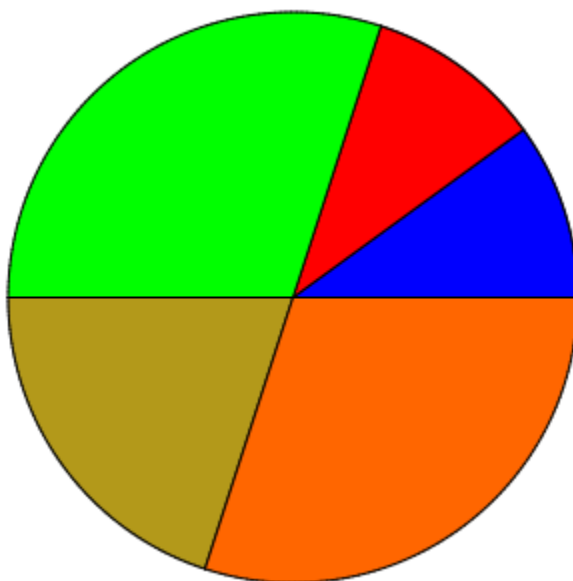

## See Also

**MuPAD Functions**  
Cells

## DensityDataDensityFunction

Density values for a density plot

### Value Summary

DensityData, DensityFunction	Optional	List of arithmetical expressions
---------------------------------	----------	-------------------------------------

### Graphics Primitives

Objects	Default Values
plot::Density	

### Description

DensityData is a nested list of “density values” visualized by a plot::Density object.

DensityFunction is a symbolic expression or a procedure defining the “density values” of a plot::Density object.

Density objects of type plot::Density can be defined either by discrete density data or by a density function. In the first case, the object has the slot DensityData. In the latter case, the function describing the densities is stored in the slot DensityFunction.

The internal representation of the DensityData entry of a plot::Density object is a list of lists of density values. Also a matrix or a 2-dimensional array of density values can be assigned to this entry: they are converted to a list of lists.

The DensityFunction of a density object can be a symbolic expression, a procedure or a piecewise object.

Assigning a value to the DensityData entry deletes an existing DensityFunction entry and vice versa.



## Examples

### Example 1

We create a density plot object defined by a density function:

```
d := plot::Density(sin(x^2 + y^2), x = -2..2, y = -2..2):  
plot(d, Scaling = Constrained):
```

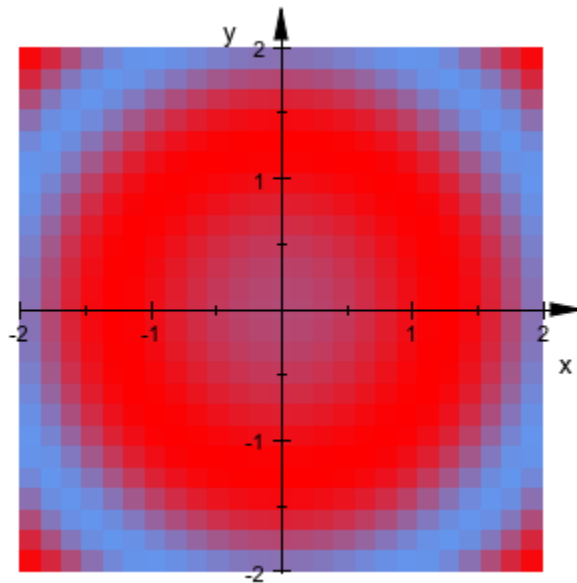

The density function of this object can be accessed via the DensityFunction slot:

```
d::DensityFunction
```

$$\sin(x^2 + y^2)$$

We change the density function by assigning a new value to the DensityFunction slot:

```
d::DensityFunction := exp(-(x^2 + y^2)/2):  
plot(d, Scaling = Constrained)
```

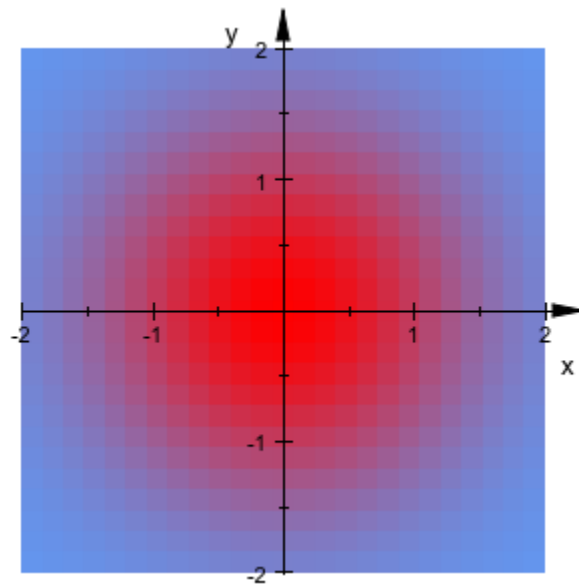

```
delete d:
```

## Example 2

We create a density plot object defined by discrete density data:

```
densitydata := [[0.1, 0.2, 0.3],  
                [0.4, 0.5, 0.6]]:  
d := plot::Density(densitydata, x = 0..3, y = 0..2):  
plot(d):
```

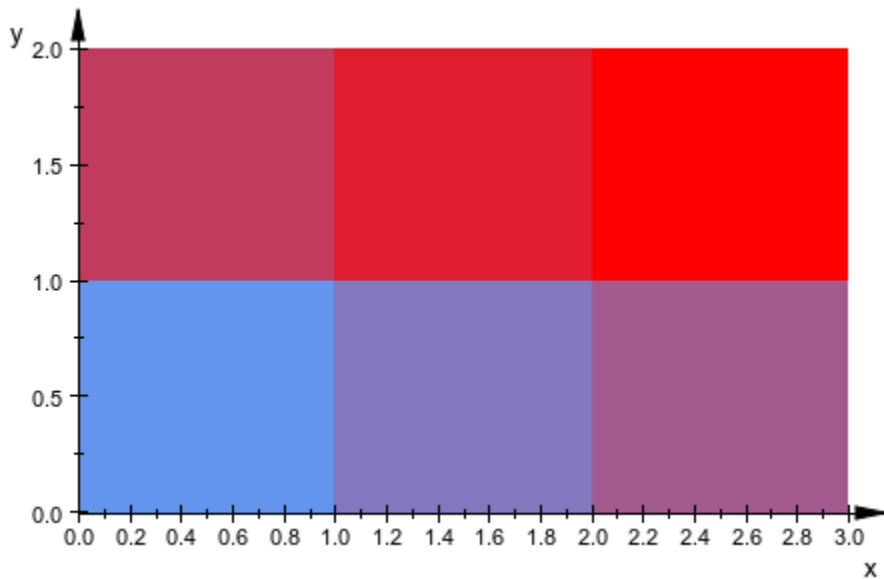

The density data of the density object can be accessed via the DensityData slot:

```
densitydata := d::DensityData
```

```
[[0.1, 0.2, 0.3], [0.4, 0.5, 0.6]]
```

The list of list of density values is turned into a matrix. After changing one entry, the new density values are written back into the density object:

```
densitydata := matrix(densitydata):
densitydata[2, 3] := 0.2:
densitydata
```

```
( 0.1 0.2 0.3 )
( 0.4 0.5 0.2 )
```

```
d::DensityData := densitydata:
plot(d)
```

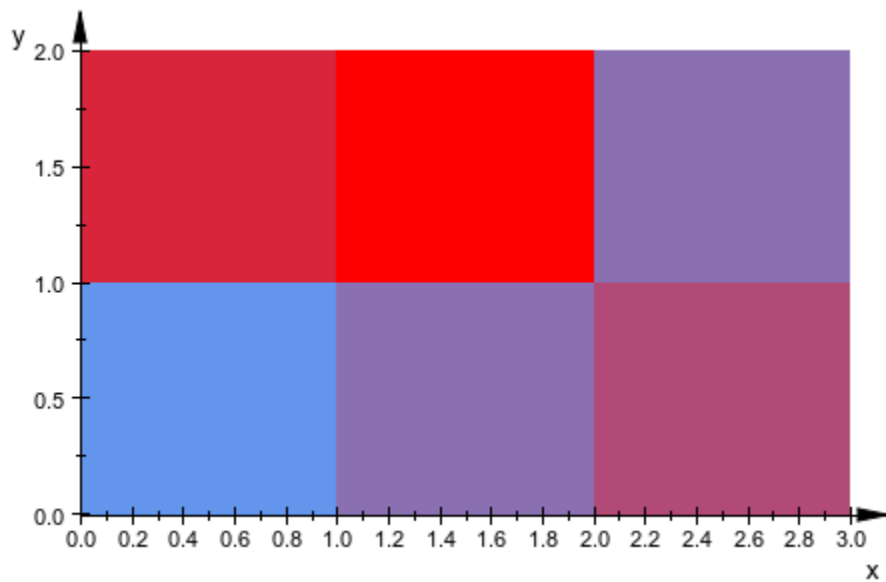

Although the density values were assigned as a matrix, they are internally stored as a list of lists:

```
d::DensityData
```

```
[[0.1, 0.2, 0.3], [0.4, 0.5, 0.2]]
```

```
delete densitydata, d:
```

# Edges

Number of Edges

## Value Summary

Mandatory	MuPAD expression
-----------	------------------

## Graphics Primitives

Objects	Edges Default Values
plot::Pyramid	4
plot::Prism	3

## Description

Edges determines the number of edges for the regular base plane of a prism or pyramid. Edges is a positive integer number.

## Examples

### Example 1

The default values for the attribute Edges are:

```
plot::Prism();
plot::Pyramid();
```

```
plot::Prism(1, [0, 0, 0], [0, 0, 1], Edges = 3)
```

```
plot::Pyramid(1, [0, 0, 0], 0, [0, 0, 1], Edges = 4)
```

## Example 2

The attribute Edges can be animated:

```
plot(plot::Pyramid(Edges=a, a=3..13)):
```

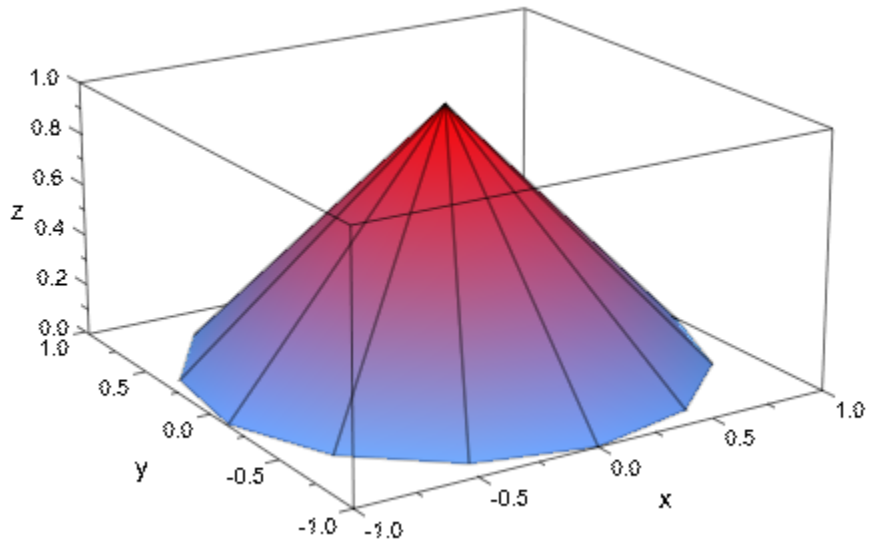

# Extension

Line extensions

## Value Summary

Inherited	Finite, Infinite, or SemiInfinite
-----------	-----------------------------------

## Graphics Primitives

Objects	Extension Default Values
<code>plot::Line2d</code> , <code>plot::Line3d</code>	Finite

## Description

Extension allows to extent a line segment to an infinite ray or an infinite line.

Lines of type `plot::Line2d` and `plot::Line3d` are defined by specifying two points through which the line passes. For example: `plot::Line2d([x1, y1], [x2, y2])`. The first point `[x1, y1]` corresponds to the attribute `From`, the second point `[x2, y2]` corresponds to the attribute `To`.

With `Extension = Finite`, a line segment from `From` to `To` is drawn.

With `Extension = SemiInfinite`, an infinite ray is drawn starting at `From` passing through `To`. The ray extends to the border of the `ViewingBox`.

With `Extension = Infinite`, an infinite line is drawn passing through `From` and `To`. The line extends in both directions to the border of the `ViewingBox`.

## Examples

### Example 1

We plot two lines with the default value `Extension = Finite`:

```
plot(plot::Line2d([0, 0], [1, 1], Color = RGB::Blue),  
      plot::Line2d([1, 0], [2, 1], Color = RGB::Red),  
      ViewingBox = [-1..3, -1..3])
```

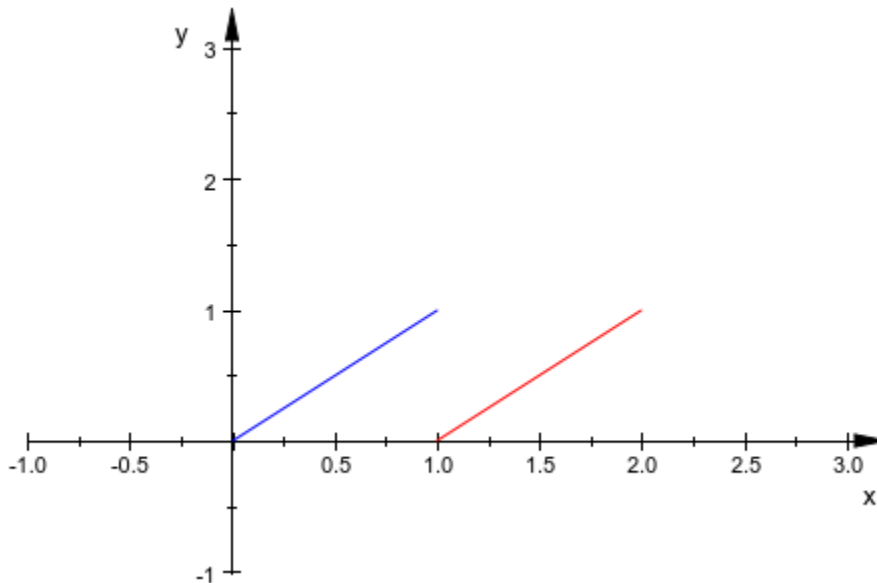

Now, with `Extension = SemiInfinite`, the blue line becomes a ray extending to the `ViewingBox` in one direction:

```
plot(plot::Line2d([0, 0], [1, 1], Color = RGB::Blue,  
                  Extension = SemiInfinite),  
      plot::Line2d([1, 0], [2, 1], Color = RGB::Red),  
      ViewingBox = [-1..3, -1..3])
```



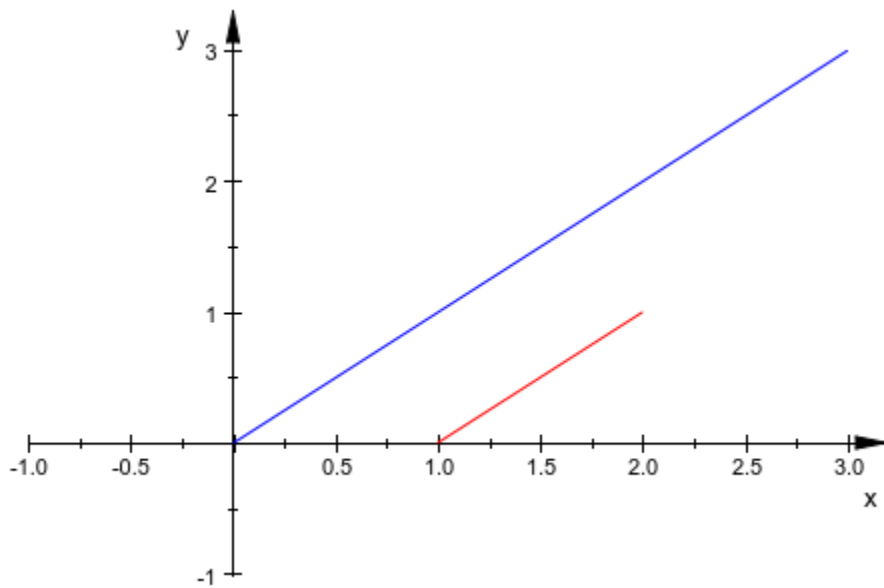

With `Extension = Infinite`, the blue line extends to the `ViewingBox` in both directions:

```
plot(plot::Line2d([0, 0], [1, 1], Color = RGB::Blue,  
                 Extension = Infinite),  
      plot::Line2d([1, 0], [2, 1], Color = RGB::Red),  
      ViewingBox = [-1..3, -1..3])
```

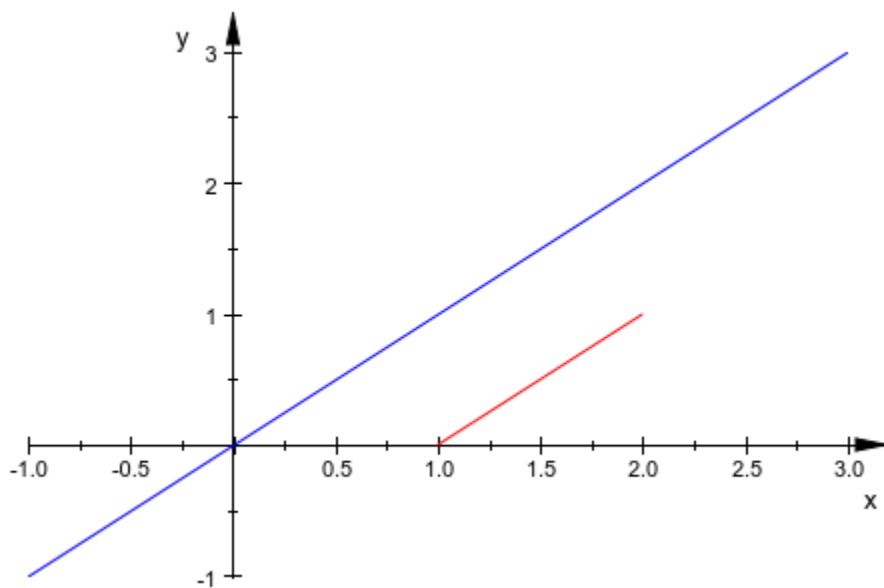

## Example 2

Here we define a finite line segment and use `plot::modify` to create an extended copy. It is drawn as an infinite dashed line:

```
line := plot::Line2d([0, 0], [1, 1]):  
plot(plot::modify(line, Extension = Infinite,  
                 LineStyle = Dashed),  
      line, ViewingBox = [-1..2, -1..2]):
```

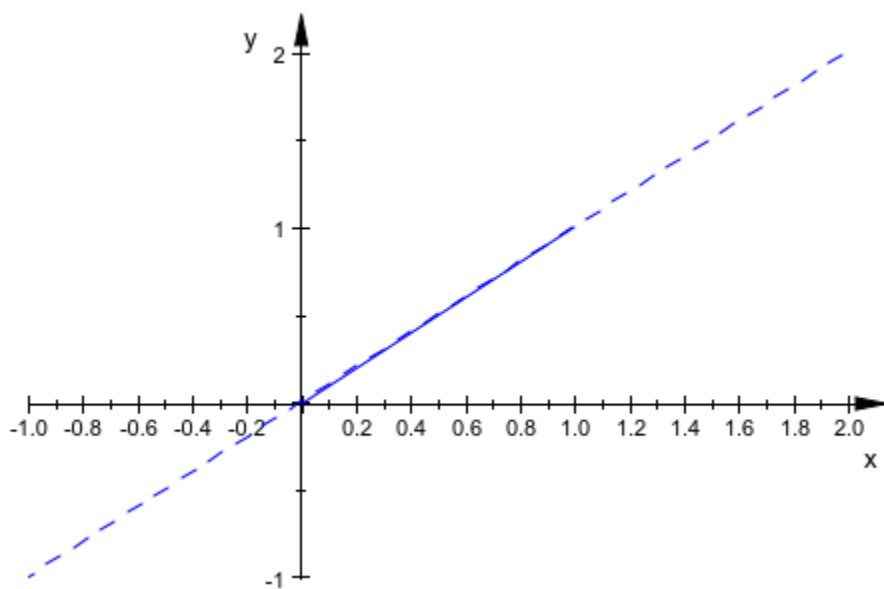

delete line:

## See Also

### MuPAD Functions

AffectViewingBox | From | To

## FromToFromXFromYFromZToXToYToZ

Starting point of arrows and lines

### Value Summary

From	Library wrapper for “[FromX, FromY]” (2D), “[FromX, FromY, FromZ]” (3D)	List of 2 or 3 expressions, depending on the dimension
To	Library wrapper for “[ToX, ToY]” (2D), “[ToX, ToY, ToZ]” (3D)	List of 2 or 3 expressions, depending on the dimension
FromX, FromY, FromZ, ToX, ToY, ToZ	Mandatory	MuPAD expression

### Graphics Primitives

Objects	Default Values
plot::Arrow2d, plot::Line2d	From: [0, 0] To: [1, 0] FromX, FromY, ToY: 0 ToX: 1
plot::Arrow3d, plot::Line3d	From: [0, 0, 0] To: [1, 0, 0] FromX, FromY, FromZ, ToY, ToZ: 0 ToX: 1
plot::Reflect2d	

## Description

The vectors `From` and `To` determine the starting point and the end point, respectively, of arrows and lines.

`From` is a vector determining the position of the starting point of arrows and lines. Depending on the dimension, it is given by a list or vector of 2 or 3 components.

`FromX` etc. refer to the  $x$ ,  $y$ ,  $z$  components of this vector.

`To` is a vector determining the position of the end point of arrows and lines. Depending on the dimension, it is given by a list or vector of 2 or 3 components.

`To` etc. refer to the  $x$ ,  $y$ ,  $z$  components of this vector.

The values of these attributes can be animated.

## Examples

### Example 1

We define an arrow:

```
p := plot::Arrow2d([0, 0], [1, 2]):  
plot(p):
```

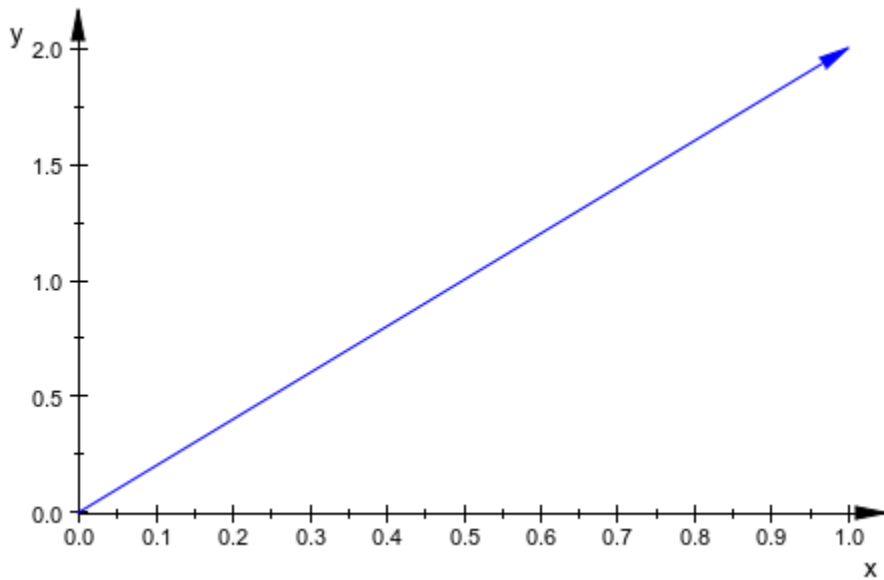

The arguments are the starting point and the end point of the arrow. Internally, they are stored as the attributes `From` and `To`. We can access the object's attributes and change them:

```
p::From, p::To
```

```
[0, 0], [1, 2]
```

```
p::From := [1, 0]:  
p::To := [0, 1]:  
plot(p):
```

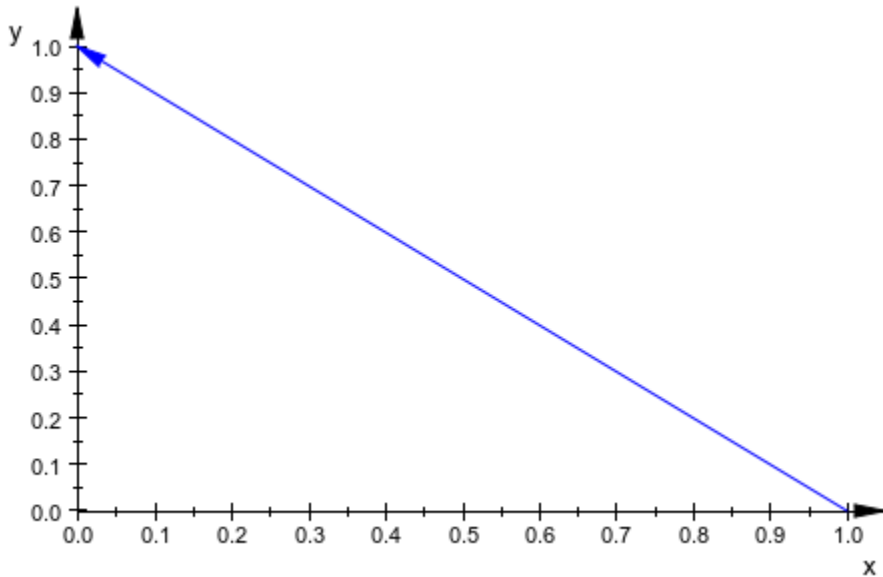

delete p:

## Example 2

The values of From and To can be animated. Here is a simple clock:

```
plot(plot::Circle2d(1, [0, 0], Color = RGB::Black),
      plot::Line2d([0.9*cos(a*PI/6), 0.9*sin(a*PI/6)],
                  [1.0*cos(a*PI/6), 1.0*sin(a*PI/6)],
                  Color = RGB::Black, LineWidth = 0.8*unit::mm)
      $ a = 0 .. 11,
      plot::Line2d([0.95*cos(a*PI/30), 0.95*sin(a*PI/30)],
                  [1.0*cos(a*PI/30), 1.0*sin(a*PI/30)],
                  Color = RGB::Black, LineWidth = 0.5*unit::mm)
      $ a = 0 .. 59,
      plot::Arrow2d([0, 0], [0.85*sin(12*a), 0.85*cos(12*a)],
                   a = 0 .. 2*PI, LineWidth = 2*unit::mm),
      plot::Arrow2d([0, 0], [0.6*sin(a), 0.6*cos(a)],
                   a = 0 .. 2*PI, LineWidth = 3*unit::mm),
      Axes = None, Frames = 600, TimeRange = 0..120):
```

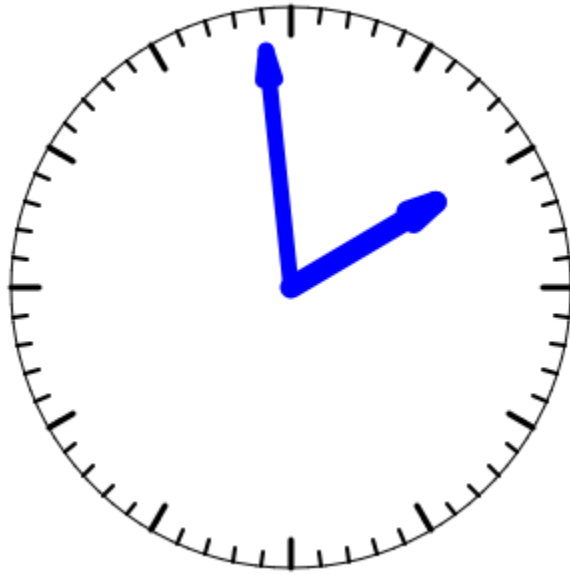



# FunctionXFunctionYFunctionZFunction

Function expression or procedure

## Value Summary

Function, XFunction, YFunction, ZFunction	Mandatory	MuPAD expression
---	-----------	------------------

## Graphics Primitives

Objects	Default Values
plot::Conformal, plot::Curve2d, plot::Curve3d, plot::Cylindrical, plot::Function2d, plot::Function3d, plot::Implicit2d, plot::Implicit3d, plot::Iteration, plot::Ode2d, plot::Ode3d, plot::Polar, plot::Sequence, plot::Spherical, plot::Streamlines2d, plot::Sum, plot::Surface, plot::Tube, plot::VectorField2d, plot::VectorField3d, plot::XRotate, plot::ZRotate	

## Description

Function, XFunction, YFunction, ZFunction correspond to function expressions or procedures in various plot objects given by a mathematical function.

The attribute Function is used for graphs of functions in 2D and 3D, implicit plots, conformal plots etc. which are characterized by a single function.

The attributes `XFunction` etc. refer to the parametrization of the  $x$ ,  $y$  or  $z$ -coordinate of parametrized curves and surfaces. In vector field plots they correspond to the components of the vector field.

When defining a graphical primitive such as a function plot, the mathematical expression defining the function is passed directly to the plot routine generating this object. E.g., one calls `plot::Function2d(x*sin(x), x = -5 .. 5)` to define the graph of  $f(x) = x \sin(x)$ . Internally, the attribute `Function = x*sin(x)` is associated with the graphical object.

Wherever function expressions are expected, also piecewise objects or MuPAD procedures on page 1-1654 can be used. E.g., the calls `plot::Function2d(sin(x), x = 0..PI)` and `plot::Function2d(x -> sin(x), x = 0..PI)` are equivalent and associate the attributes `Function = sin(x)` or `Function = x -> sin(x)`, respectively, with the plot objects.

## Examples

### Example 1

We define an object of type `plot::Function2d` representing the graph of  $f(x) = x \sin(x)$ :

```
f := plot::Function2d(x*sin(x), x = -4 .. 4):  
plot(f)
```

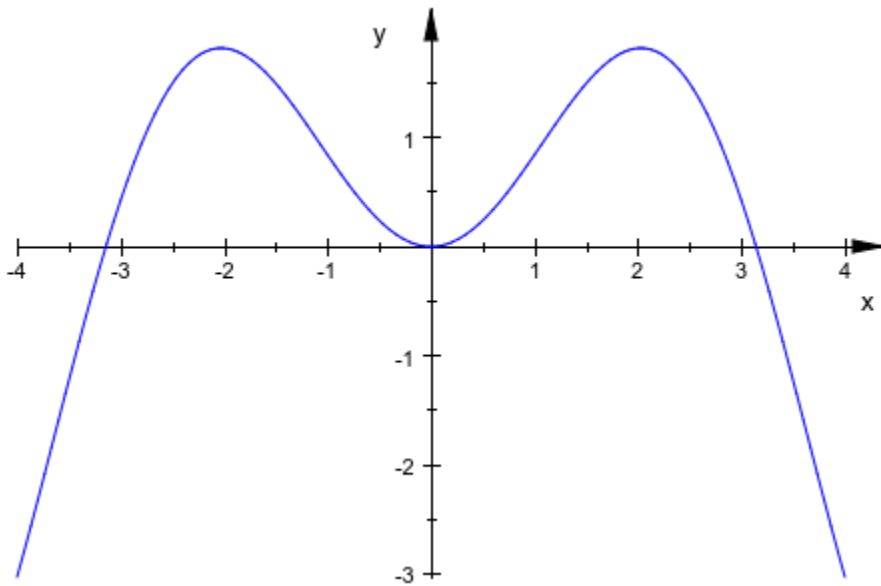

Internally, the expression defining the function is turned into the attribute `Function = x*sin(x)`. It is accessible via a corresponding slot of the object:

```
f::Function
```

```
x sin(x)
```

One can change the object by reassigning a new value to this attribute:

```
f::Function := 1/x:  
plot(f):
```

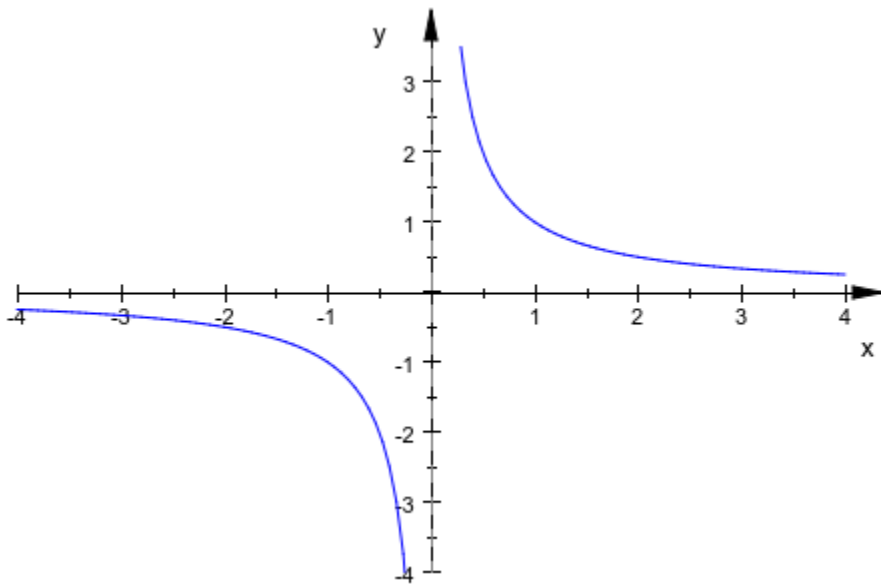

```
delete f:
```

## Example 2

For implicit plots as produced by `plot::Implicit2d` and `plot::Implicit3d`, the attribute `Function` refers to the function whose zero set is to be plotted:

```
p := plot::Implicit2d(y*sin(x) - x*cos(y), x=-5..5, y=-5..5):
```

Internally, the expression defining the function is turned into the attribute `Function = y*sin(x) - x*cos(y)`. It is accessible via a corresponding `slot` of the object:

```
p::Function
```

```
y sin(x) - x cos(y)
```

```
delete p:
```

### Example 3

For parametrized curves and surfaces, the attributes XFunction, YFunction etc. correspond to the parametrization of the coordinates  $x$ ,  $y$  etc:

```
c2 := plot::Curve2d([u*cos(u), u*sin(u)], u = 0..5*PI):
c2::XFunction, c2::YFunction
```

$$u \cos(u), u \sin(u)$$

```
c3 := plot::Curve3d([u*cos(u), u*sin(u), u^2], u = 0..5*PI):
c3::XFunction, c3::YFunction, c3::ZFunction
```

$$u \cos(u), u \sin(u), u^2$$

```
s := plot::Surface([u*cos(v), u*sin(v), u^2*sin(2*v)],
                  u = 0..1, v = 0..2*PI):
s::XFunction, s::YFunction, s::ZFunction
```

$$u \cos(v), u \sin(v), u^2 \sin(2 v)$$

```
delete c2, c3, s:
```

### Example 4

Wherever a function expression is expected, also a `piecewise` object or a procedure can be used:

```
f1 := piecewise([x < 0, 0], [x >= 0, x]):
f2 := proc(x) begin
    if x < 0 then
        1
    else 1 - x^2/2
    end_if;
end_proc:
F1 := plot::Function2d(f1, x = -1..PI/2):
F2 := plot::Function2d(f2, x = -1..PI/2):
F1::Function, F2::Function
```

$$\begin{cases} 0 & \text{if } x < 0 \\ x & \text{if } 0 \leq x \end{cases}, \text{ proc f2(x) ... end}$$

```
plot(F1, F2)
```

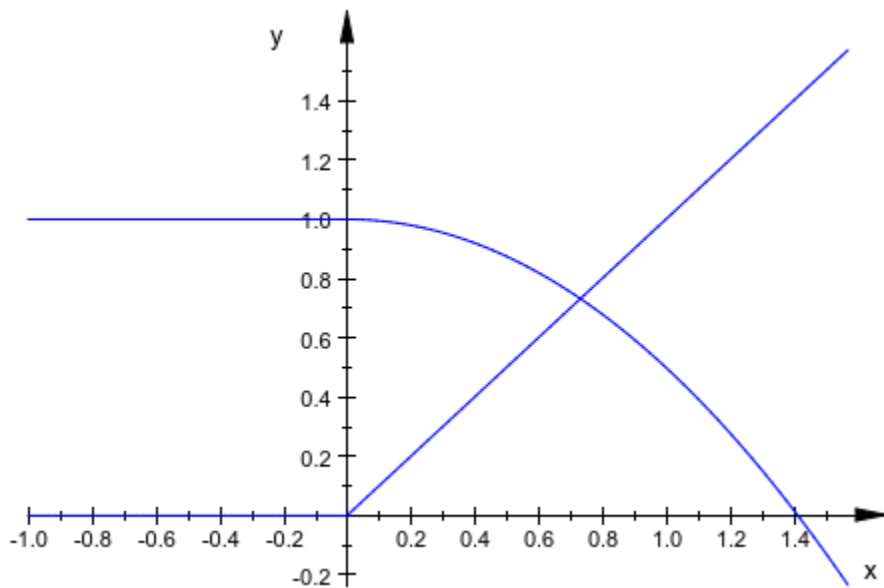

```
delete f1, f2, F1, F2:
```

## See Also

**MuPAD Functions**  
Function1 | Function2

# Function1Function2Baseline

First function/curve delimiting hatch

## Value Summary

Baseline, Function1, Function2	Mandatory	Text string
--------------------------------	-----------	-------------

## Graphics Primitives

Objects	Default Values
plot::Hatch, plot::Integral	

## Description

Function1 and Function2 refer to the functions that define the borders of a hatched 2D region of type plot::Hatch.

Baseline is the y value of a straight horizontal border line of a hatch.

Function1, Function2 are very technical attributes that a user will hardly ever use.

If  $f_1$ ,  $f_2$  are function objects of type plot::Function2d, the hatch object  $h := \text{plot::Hatch}(f_1, f_2)$  stores references to the objects  $f_1$ ,  $f_2$  as the slots  $h::\text{Function1}$ ,  $h::\text{Function2}$ . These are text references (i.e., strings) by which the function objects  $f_1$ ,  $f_2$  can be identified, but not the function objects themselves.

Function1 points to a function object of type plot::Function2d or a curve object of type plot::Curve2d.

Function1 is usually set implicitly by plot::Hatch to the Name attribute of its first argument.

When `Function1` refers to a curve of type `plot::Curve2d`, `Function2` and `Baseline` are ignored.

`Function2` is the (optional) second border function of a hatch. In the plot, the hatched area is bounded by the two functions referred to by `Function1` and `Function2`.

If `Function2` is given, `Function1` must refer to a function graph of type `plot::Function2d`, too.

`Function2` is usually set implicitly by `plot::Hatch` to the `Name` attribute of its second argument.

`Baseline` is an alternative second delimiter of a hatch. It defines a horizontal border line of the hatch with a `y`-value given by `Baseline`. The `Baseline` expression may be animated.

## Examples

### Example 1

We hatch the area between the functions  $\sqrt{x}$  and  $x^2$ :

```
f1 := plot::Function2d(sqrt(x), x = 0..2, Color = RGB::Black):  
f2 := plot::Function2d(x^2, x = 0..2, Color = RGB::Blue):  
h := plot::Hatch(f1, f2):  
plot(f1, f2, h)
```



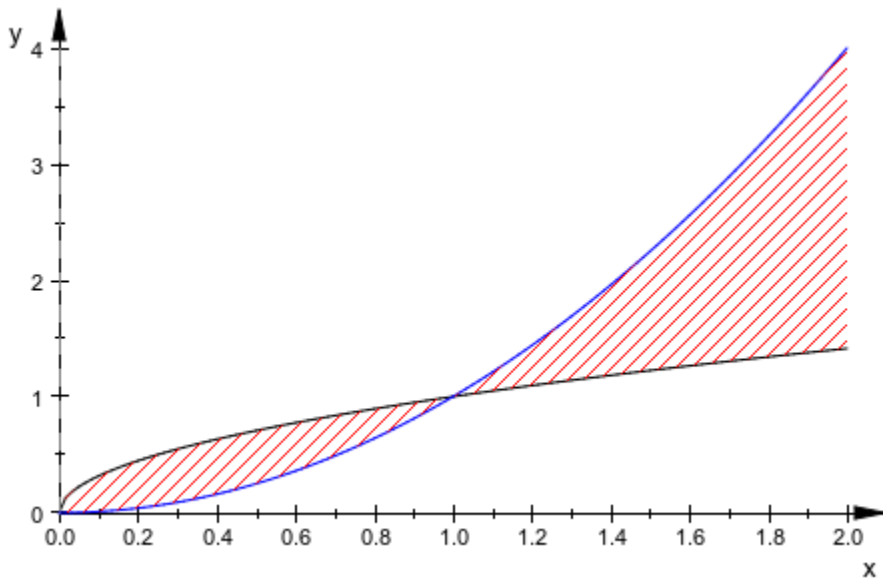

The references to the border functions are stored as strings in the hatch object h:

```
h::Function1, h::Function2
```

```
"Function2d(LineColor = [0.0, 0.0, 0.0], XMin = 0, XMax = 2, XName = x, Function = x^(1/2)\
), XAxisTitle = "x")", "Function2d(LineColor = [0.0, 0.0, 1.0], XMin = 0, XMax = 2, XName =\
x, Function = x^2, XAxisTitle = "x")"
```

Baseline serves as an alternative for the special case of a constant border function. The Baseline value can be animated:

```
h := plot::Hatch(f1, sqrt(2)*a, a = 0 .. 1):
h::Baseline
```

$$\sqrt{2} a$$

```
plot(f1, h)
```

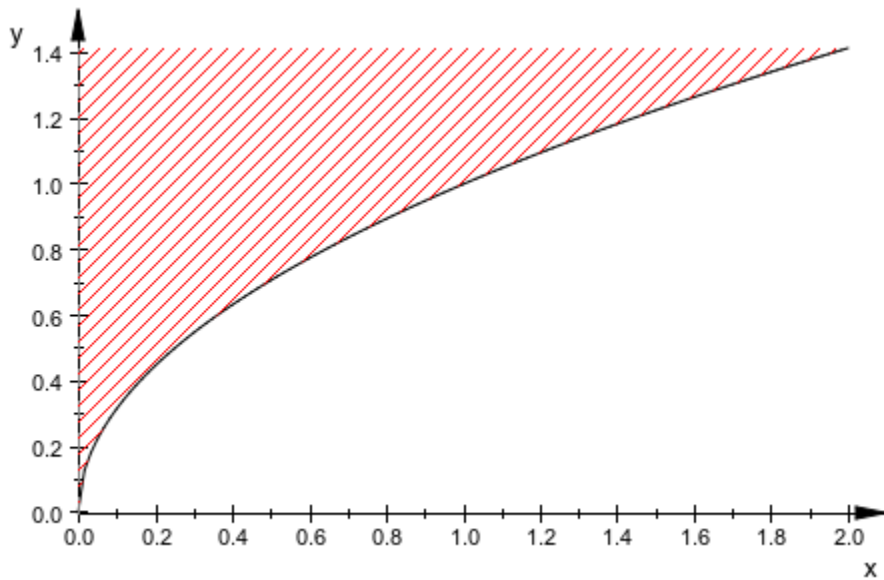

A (closed) curve of type `plot::Curve2d` may be used as the boundary of the hatch:

```
f1 := plot::Curve2d([sin(2*x), cos(3*x)], x = 0..2*PI,  
                   Color = RGB::Black):  
h := plot::Hatch(f1):  
h::Function1
```

```
"Curve2d(LineColor = [0.0, 0.0, 0.0], UMin = 0, UMax = 2*PI, UName = x, XFunction = sin(\  
2*x), YFunction = cos(3*x))"
```

```
plot(f1, h)
```

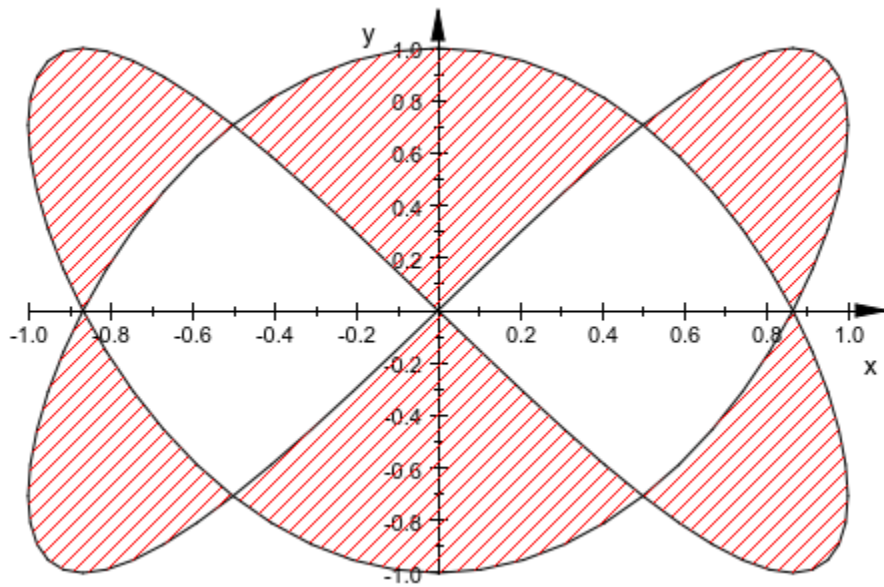

delete f1, f2, h, c:

## See Also

### MuPAD Functions

Name

## InitialConditionsTimeMesh

Initial conditions of the ODE

### Value Summary

InitialConditions, TimeMesh	Mandatory	List of arithmetical expressions
--------------------------------	-----------	-------------------------------------

### Graphics Primitives

Objects	Default Values
plot::Ode2d, plot::Ode3d	

### Description

InitialConditions = [ $y_1(t_0)$ ,  $y_2(t_0)$ , ...] sets the initial conditions for the initial value problem

$$\frac{\partial}{\partial t} \begin{pmatrix} y_1(t) \\ y_2(t) \\ \vdots \\ \vdots \end{pmatrix} = \begin{pmatrix} f_1(t, y_1(t), y_2(t), \dots) \\ f_2(t, y_1(t), y_2(t), \dots) \\ \vdots \\ \vdots \end{pmatrix} .$$

TimeMesh = [ $t_0$ ,  $t_1$ ,  $t_2$ , ...] sets the values of the independent variable  $t$  (the “time”) of the ODE at which graphical points of the solution curve are plotted. The first entry  $t_0$  is the initial time for which initial conditions are set by InitialConditions.

Internally, plot::Ode2d and plot::Ode3d call the routine numeric::odesolve for solving the given ODE numerically.

The list of initial conditions set by `InitialConditions` is forwarded to `numeric::odesolve`. See the corresponding help page on page 19-196 for further details.

## Examples

### Example 1

We solve the initial value problem  $y'(t) = -y(t)$ ,  $y(0) = 1$  numerically:

```
f := (t, Y) -> [-Y[1]]:  
Y0 := [1]:  
timemesh:= [0, 0.2, 0.5, 1, 1.5, 2, 3, 5]:  
plot(plot::Ode2d(f, InitialConditions = Y0,  
                TimeMesh = timemesh))
```

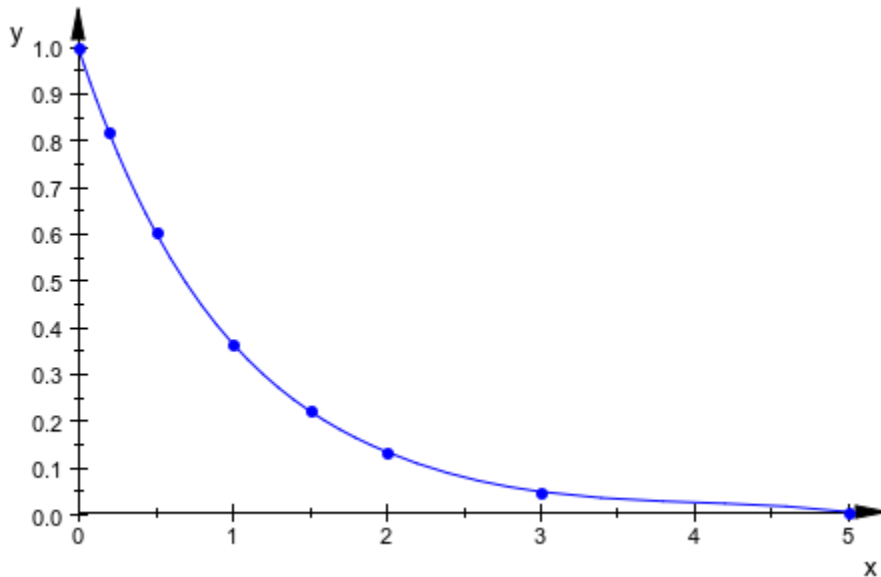

```
delete f, Y0, timemesh:
```

## See Also

### **MuPAD Functions**

[AbsoluteError](#) | [ODEMethod](#) | [Projectors](#) | [RelativeError](#) | [Stepsize](#)

# IntMethod

Method for integral approximation

## Value Summary

Optional	Exact, RiemannLeft, RiemannRight, RiemannLower, RiemannUpper, RiemannMiddle, RiemannLowerAbs, RiemannUpperAbs, Simpson, or Trapezoid
----------	--

## Graphics Primitives

Objects	IntMethod Default Values
plot::Integral	Exact

## Description

IntMethod determines the method of the visualization of plot::Integral objects.

Following methods are implemented:

- Exact
  - the area between x-axis and function graph is colored
- RiemannLower
  - display boxes between x-axis and function graph using the smallest value of the function in each subinterval
- RiemannLowerAbs
  - display boxes between x-axis and function graph using the smallest absolute value of the function in each subinterval

- RiemannUpper  
display boxes between x-axis and function graph using the greatest value of the function in each subinterval
- RiemannUpperAbs  
display boxes between x-axis and function graph using the greatest absolute value of the function in each subinterval
- RiemannLeft  
display boxes between x-axis and function graph using the function value of the left border in each subinterval
- RiemannMiddle  
display boxes between x-axis and function graph using the function value of the middle in each subinterval
- RiemannRight  
display boxes between x-axis and function graph using the function value of the right border in each subinterval
- Trapezoid  
display an approximation of the integral using the Trapezoidal rule
- Simpson  
interpolate the graph of the function using Simpsons rule

## Examples

### Example 1

The following example shows all implemented methods:

```
f := plot::Function2d(x*(x-3)*(x+4), Color = RGB::Black):  
plot(plot::Scene2d(plot::Integral(f, 7, IntMethod = method,  
                                Color = [frandom() $ i=1..3],  
                                ShowInfo = [IntMethod, Integral,  
                                Error, Position = [-5,90]]), f)
```



```

$ method in [RiemannLower, RiemannLowerAbs, Trapezoid,
             RiemannUpper, RiemannUpperAbs, Simpson,
             RiemannLeft, RiemannRight, RiemannMiddle],
Columns = 3, TextFont = [8], Width = 200, Height = 180)

```

RiemannLower: -53.35  
Integral: 83.33  
Error: 136.69 y

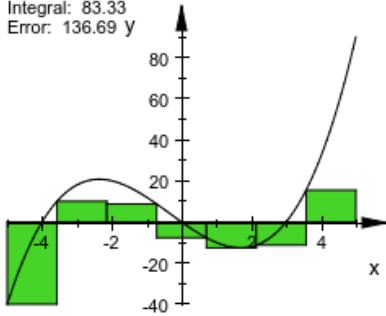

RiemannLowerAbs: 37.90  
Integral: 83.33  
Error: 45.43 y

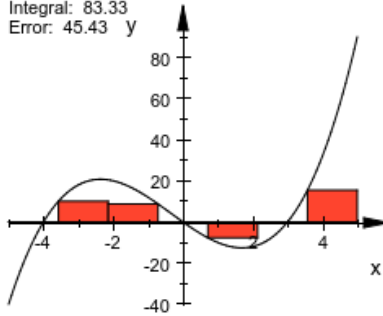

Trapezoid: 86.73  
Integral: 83.33  
Error: 3.40 y

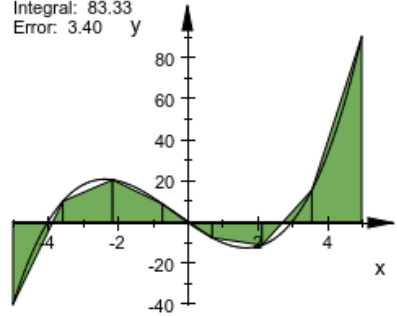

RiemannUpper: 225.35  
Integral: 83.33  
Error: 142.01 y

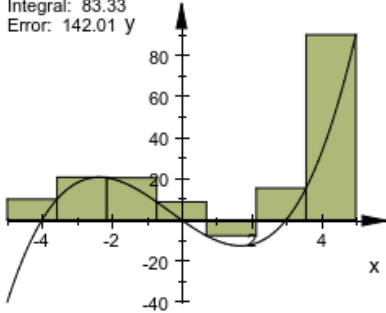

RiemannUpperAbs: 134.09  
Integral: 83.33  
Error: 50.76 y

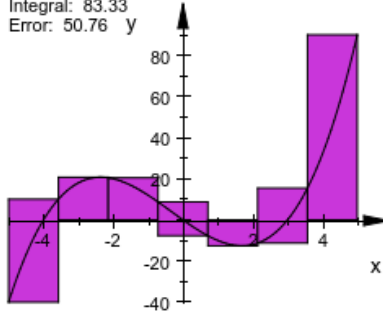

Simpson: 83.33  
Integral: 83.33  
Error: 0.00 y

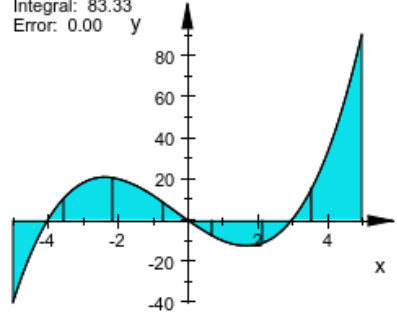

RiemannLeft: -6.12  
Integral: 83.33  
Error: 89.46 y

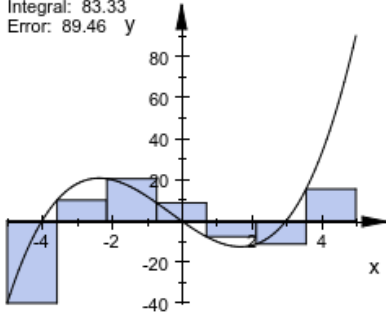

RiemannRight: 179.59  
Integral: 83.33  
Error: 96.26 y

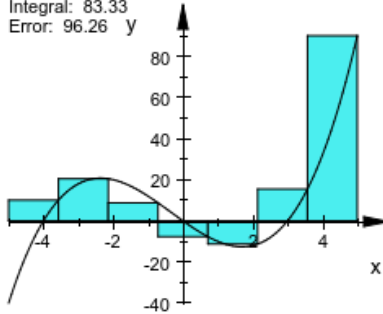

RiemannMiddle: 81.63  
Integral: 83.33  
Error: 1.70 y

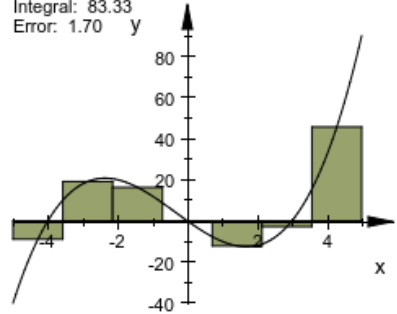

## GenerationsRotationAngleIterationRules StartRuleStepLengthTurtleRules

Number of iterations of L-system rules

### Value Summary

Generations, IterationRules, RotationAngle, StartRule, StepLength, TurtleRules	Optional	MuPAD expression
--	----------	------------------

### Graphics Primitives

Objects	Default Values
<code>plot::Lsys</code>	Generations: 5 StepLength: 1.0

### Description

Generations, RotationAngle, IterationRules, StartRule, StepLength, and TurtleRules define a Lindenmayer system. The attribute meanings and examples of their use can be found in the documentation of `plot::Lsys`.

# Ground

Base value

## Value Summary

Optional	MuPAD expression
----------	------------------

## Graphics Primitives

Objects	Ground Default Values
<code>plot::Bars3d</code> , <code>plot::Sweep</code>	0

## Description

In bar charts, the attribute `Ground = g` determines the vertical coordinate value of one end of the bars. Data values  $m > g$  are displayed as bars stretching in the vertical direction from the lower end  $g$  up to the upper end  $m$ . Data values  $m < g$  are displayed as bars stretching in the vertical direction from the upper end  $g$  down to the lower end  $m$ .

In sweep surfaces of type `plot::Sweep`, a parametrized space curve  $(x(u), y(u), z(u))$  is projected to the  $x$ - $y$ -plane with constant  $z = g$ , where  $g$  is set by the `Ground` attribute.

The parameter  $g$  has to be a numerical real value or an expression of the animation parameter.

If the attribute `Ground = g` is not specified, the default value  $g = 0$  is used.

## Examples

### Example 1

We plot the same data with different `Ground` values:

```
A := matrix::random(5, 5, frandom):
plot(plot::Scene3d(plot::Bars3d(A, Ground = 0,
                               Color = RGB::Grey)),
      plot::Scene3d(plot::Bars3d(A, Ground = 0.5,
                               Color = RGB::Grey)),
      Layout = Horizontal):
```

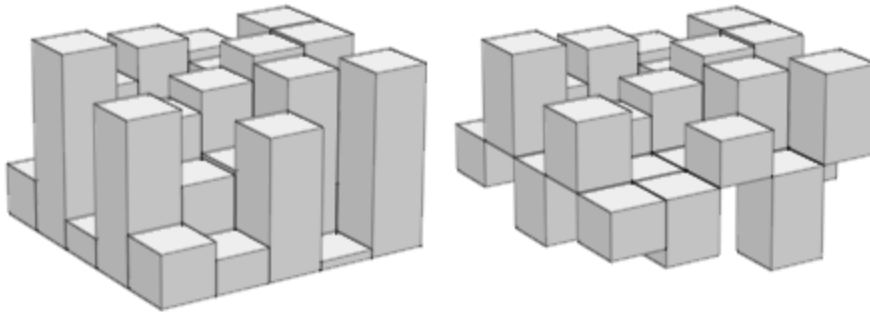

In the next call, the ground level is animated. Note that in animations one must specify ranges for the  $x$  and  $y$  coordinates. We include a transparent plane visualizing the ground level:

```
plot(plot::Bars3d(A, x = 0 .. 1, y = 0 .. 1, a = 0 .. PI,
                  Color = RGB::Grey,
                  Gap = [0.5, 0.5],
                  Ground = sin(a)),
      plot::Surface([x, y, sin(a) + 0.001],
                    x = 0 .. 1, y = 0 .. 1, a = 0 .. PI,
                    Mesh = [2, 2], Color = RGB::Blue.[0.5])
):
```

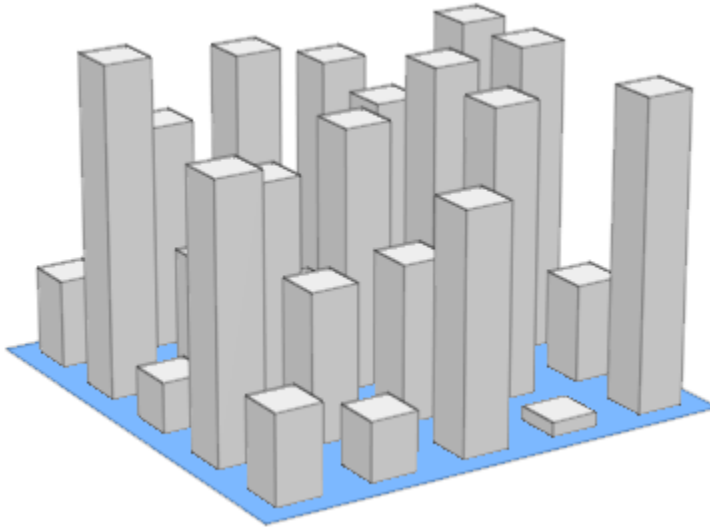

delete A:

## Example 2

We use different Ground values to project a space curve to the x-y-plane:

```
plot(plot::Scene3d(plot::Sweep([u, 1-u, sin(2*PI*u)], u = 0..1,
    Ground = 1), Header = "Ground = 1"),
    plot::Scene3d(plot::Sweep([u, 1-u, sin(2*PI*u)], u = 0..1,
    Ground = 0.5), Header = "Ground = 0.5"),
    plot::Scene3d(plot::Sweep([u, 1-u, sin(2*PI*u)], u = 0..1,
    Ground = 0), Header = "Ground = 0"),
    plot::Scene3d(plot::Sweep([u, 1-u, sin(2*PI*u)], u = 0..1,
    Ground = -1), Header = "Ground = -1"),
    plot::Scene3d::BorderWidth = 0.5*unit::mm,
    Layout = Tabular, Rows = 2)
```

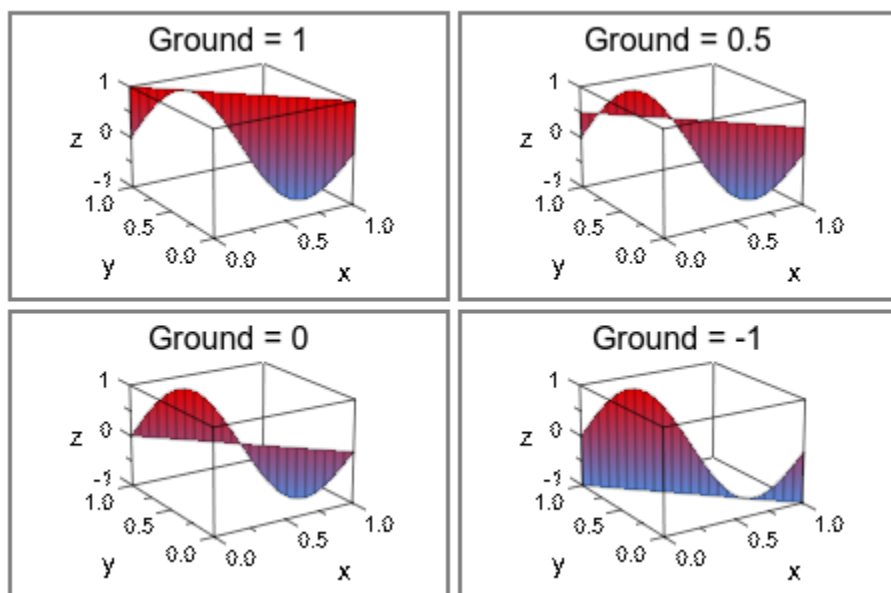

# HeightsMoves

Heights of pieces in pie charts

## Value Summary

Heights, Moves	Optional	List of arithmetical expressions
----------------	----------	----------------------------------

## Graphics Primitives

Objects	Default Values
<code>plot::Piechart3d</code>	Heights: [0.3] Moves: [0]
<code>plot::Piechart2d</code>	Moves: [0]

## Description

Heights, Moves determine the heights and displacements of the single pieces in a pie chart.

Heights determines the heights of the pieces in a `plot::Piechart3d`. If no height value is given for a piece, 0.3 is used. The given values have to be real numbers or expressions of the animation parameter.

Moves determines the movements of pieces away from the pie chart center. If no move value is given for a piece, 0 is used. The given values have to be non-negative real numbers or expressions of the animation parameter. The values are fractions of the Radius of the pie chart. A value of 1 means a full pie chart radius, 0.5 half the radius of the pie chart etc.

Heights, Moves accept its input in two formats:

- The values can be given as a flat list of values with entries of the type specified above. The first list entry will be used for the first piece etc. If the list contains less values than the data set of the pie chart, the last value is repeated. Superfluous entries are ignored.
- The values can be given as a list of equations with positive integers on the left hand side and values - as specified above - on the right hand side. The integers are interpreted as indices of the pieces.

## Examples

### Example 1

We move the third piece of the following pie chart away from the center by half the radius of the pie chart:

```
plot(plot::Piechart2d([1, 2, 1, 3],  
                      Moves = [3 = 0.5]))
```

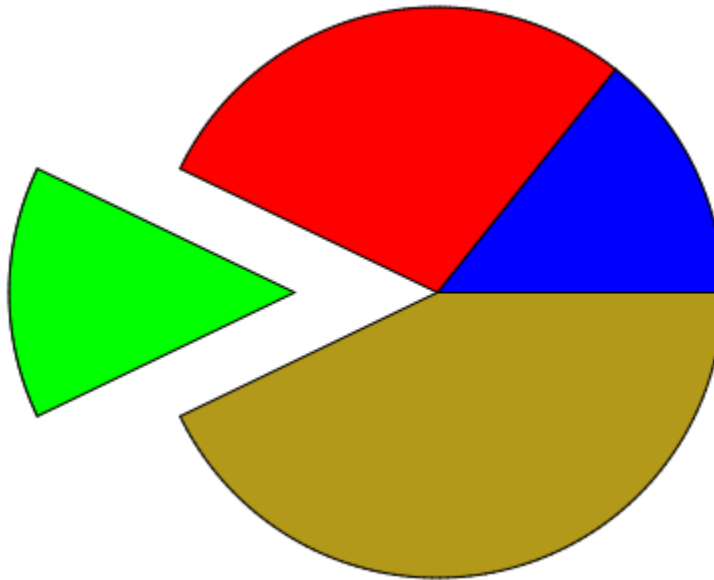

The pieces are moved away from the center by different amounts:



```
plot(plot::Piechart2d([1, 2, 1, 3],  
                      Moves = [0, 0.5, 0.2, 0.1]))
```

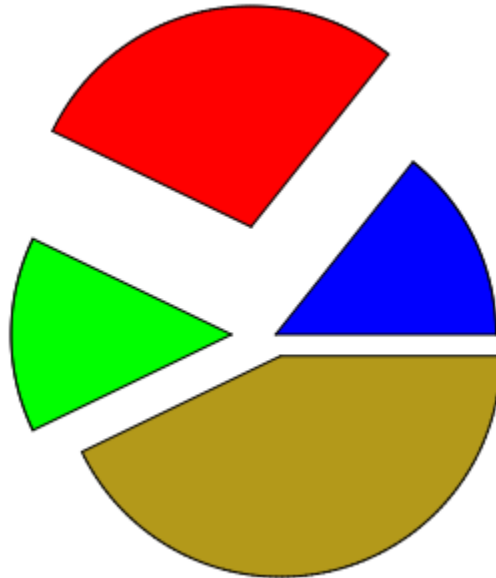

## Example 2

We plot an analogous 3D pie chart:

```
plot(plot::Piechart3d([1, 2, 1, 3],  
                      Moves = [3 = 0.5]))
```

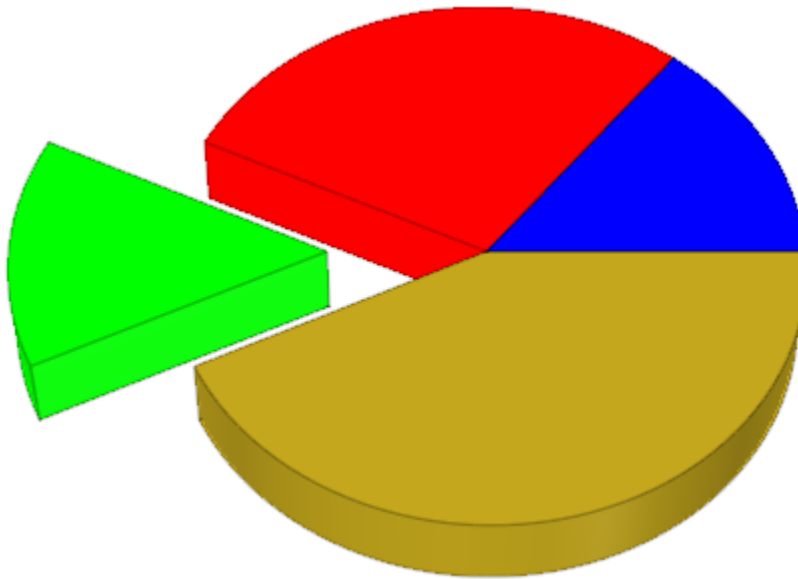

The pieces are moved away from the center by different amounts:

```
plot(plot::Piechart3d([1, 2, 1, 3],  
                      Moves = [0, 0.5, 0.2, 0.1]))
```

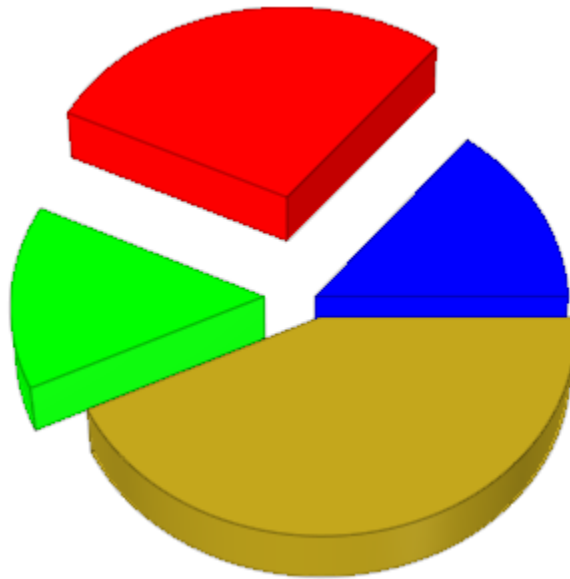

In 3D, the pieces of a pie chart can have different heights:

```
plot(plot::Piechart3d([1, 2, 1, 3],  
                      Heights = [0.4, 0.5, 0.2, 0.1]))
```

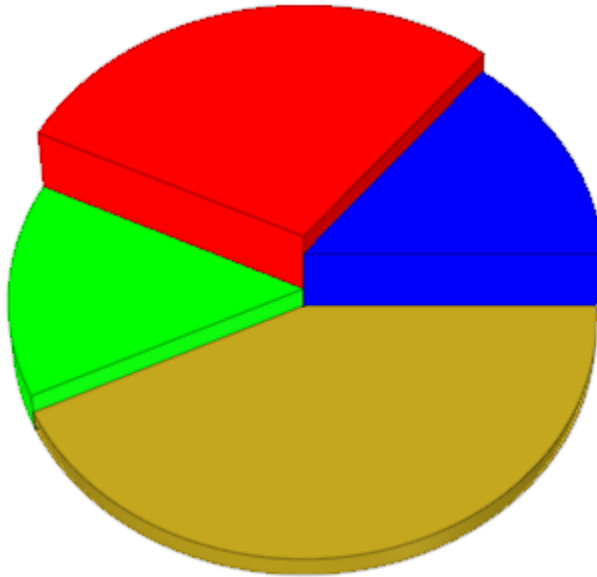

### Example 3

Here is a `plot::Piechart3d` with animated Heights, Moves, and Radius:

```
plot(plot::Piechart3d([4, 3, 2, 1],  
    Radius = 3 + sin(a),  
    Heights = [cos(a)^2, cos(2*a)^2,  
              cos(3*a)^2, cos(4*a)^2],  
    Moves = [0.3*sin(a)^2], a = 0..PI):
```



## See Also

**MuPAD Functions**  
Data | Radius

## Inequalities

Inequalities displayed in inequality plots

### Value Summary

Mandatory	List of arithmetical expressions
-----------	----------------------------------

### Graphics Primitives

Objects	Inequalities Default Values
<code>plot::Inequality</code>	

### Description

`Inequalities` is the attribute used by `plot::Inequality` to store the inequalities to plot.

`plot::Inequality` is used to plot the areas where one or more inequalities are fulfilled. `Inequalities` is the internal attribute where the inequalities are stored. Most users will never access this attribute directly; it exists for technical reasons only.

# InputFile

Input file for import functions

## Value Summary

Mandatory	Text string
-----------	-------------

## Graphics Primitives

Objects	InputFile Default Values
plot::SurfaceSTL	

## Description

InputFile specifies the name of the input file for import functions.

InputFile can either be an absolute pathname or a pathname relative to the current working directory or one of the directories specified by the MuPAD variable READPATH.

Note that some MuPAD functions do not react to the MuPAD variable READPATH. In this case it might be necessary to specify InputFile as an absolute pathname.

Note that the current working directory of a MuPAD session may depend on how and from where MuPAD has been started. Be careful when making assumptions about this.

See plot::SurfaceSTL for examples.

## See Also

**MuPAD Functions**  
OutputFile

## IterationsStartingPoint

Number of iterations in plot::Iteration

### Value Summary

Iterations, StartingPoint	Optional	MuPAD expression
---------------------------	----------	------------------

### Graphics Primitives

Objects	Default Values
plot::Iteration	Iterations: 10

### Description

Iterations and StartingPoints are special attributes for iteration objects of type plot::Iteration. StartingPoint sets the starting point, Iterations sets the number of iteration steps.

The call `it := plot::Iteration(f, x_0, n, x = `x_{min}`..`x_{max}`)` yields a visualization of the iteration  $x_i = f(x_{i-1})$  of the starting point  $x_0$  with  $i = 1, \dots, n$ . The values  $x_0$  and  $n$  are stored as the attributes `StartingPoint = x_0` and `Iterations = n` in the iteration object `it`. The values can be accessed and changed as the slots `it::StartingPoint` and `it::Iterations`, respectively.

These attributes can be animated.

### Examples

#### Example 1

We define and plot an iteration object:



```
f := plot::Function2d(exp(-2*x), x = 0..1):
g := plot::Function2d(x, x = 0..1):
it := plot::Iteration(exp(-2*x), 0.2, 5, x = 0..1):
plot(f, g, it)
```

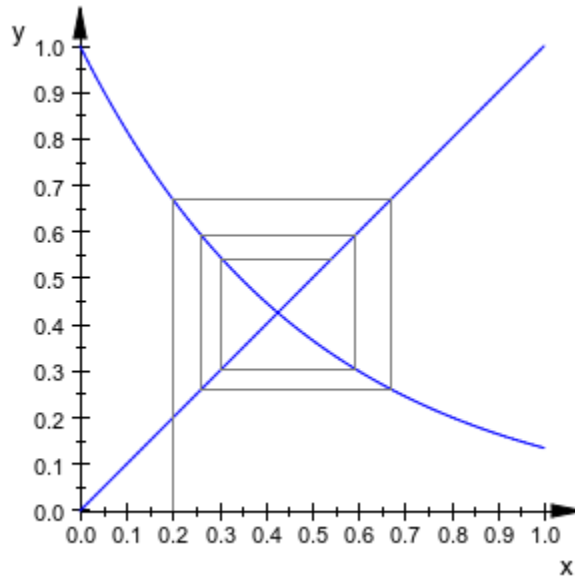

The starting point  $x_0 = 0.2$  and the number of iteration steps 5 are stored inside the iteration object:

```
it::StartingPoint, it::Iterations
```

0.2, 5

We change these values:

```
it::StartingPoint := 0.1:
it::Iterations := 30:
plot(f, g, it)
```

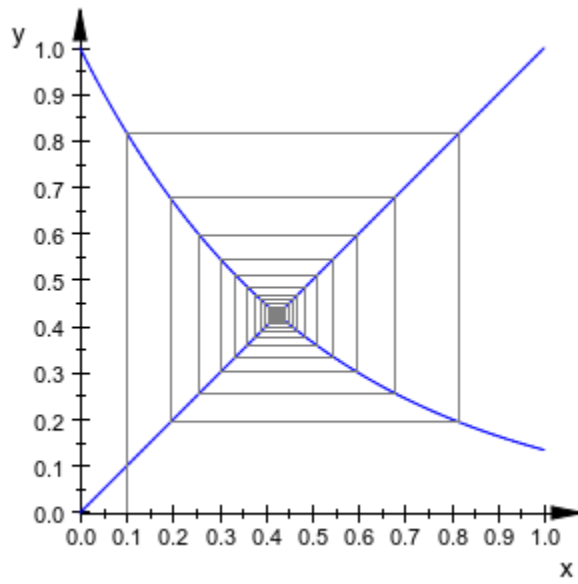

delete f, g, it:

# LineColorFunctionFillColorFunction

Functional line coloring

## Value Summary

FillColorFunction, LineColorFunction	Optional	Color function (see below)
---	----------	----------------------------

## Graphics Primitives

Objects	Default Values
plot::Conformal, plot::Curve2d, plot::Curve3d, plot::Cylindrical, plot::Density, plot::Dodecahedron, plot::Function2d, plot::Function3d, plot::Hexahedron, plot::Icosahedron, plot::Implicit2d, plot::Implicit3d, plot::Integral, plot::Listplot, plot::Matrixplot, plot::Octahedron, plot::Polar, plot::Polygon2d, plot::Polygon3d, plot::Prism, plot::Pyramid, plot::Rootlocus, plot::Sequence, plot::Spherical, plot::Streamlines2d, plot::Sum, plot::Surface, plot::SurfaceSet, plot::SurfaceSTL, plot::Sweep, plot::Tetrahedron, plot::Tube, plot::VectorField2d, plot::VectorField3d, plot::Waterman, plot::XRotate, plot::ZRotate	

## Description

These options accept functions that define the color of a plot at arbitrary points.

Using `FillColorType` and `LineColorType`, the user can control the color of many graphical objects. The setting providing the most detailed (and most complicated) control is `Functional`. In this case, a *color function* must be provided using one of `LineColorFunction`, `FillColorFunction`.

A color function can be a list of three or four expressions.

If three expressions are given, they specify RGB colors. If four expressions are given, they specify RGBA colors. See the introduction (Symbolic Math Toolbox) for more details on color specifications.

The expressions may contain the identifiers bound in the corresponding object. For example, in a `plot::Function2d(sin(x), x=0..PI)`, the color function may refer to `x`. More formally, the expressions may contain the identifiers found in the attributes `XName`, `YName`, `ZName`, `UName`, `VName`, and `ParameterName` of the plot object they are found in.

All of these expressions must, for values in the given ranges, evaluate to real numbers in the range `0..1`. Real values outside this range do not yield errors, they are simply clipped.

See also “Example 1” on page 24-1318 (Symbolic Math Toolbox).

Alternatively, a color function can be a procedure or function environment.

A procedure on page 1-1654 (or a function environment on page 1-846) used as a color function must return lists of three or four real numbers in the range `0..1`. Real values outside this range are clipped. (If this function ever returns a list of four numbers, it must always do so.) A list of three numbers is interpreted as an RGB color, while a list of four values is interpreted as an RGBA color. See the introduction (Symbolic Math Toolbox) for more details on color specifications.

The number and meaning of arguments a color function is called with depends on the object type. Informally, we have:

Type (abbreviated)	Parameters
Conformal( $f(z)$ )	$z, \text{Re}(f(z)), \text{Im}(f(z)), \text{flag}$ (with flag = 1 or flag = 2)
Curve2d( $x(u), y(u)$ )	$u, x(u), y(u)$
Curve3d( $x(u), y(u), z(u)$ )	$u, x(u), y(u), z(u)$
Cylindrical( $r(u, v), \text{phi}(u, v), z(u, v)$ )	$u, v, r(u, v), \text{phi}(u, v), z(u, v), x(u), y(u), z(u)$
Density( $f(x, y)$ )	$x, y, f(x, y)$
plot::Dodecahedron	See below.
Function2d( $f(x)$ )	$x, f(x)$
Function3d( $f(x, y)$ )	$x, y, f(x, y)$
plot::Hexahedron	See below.
Icosahedron	See below.
Implicit2d( $f(x, y), \text{Contours}=[c]$ )	$x, y, D([1], f)(x, y), D([2], f)(x, y), c$
Implicit3d( $f(x, y, z), \text{Contours}=[c]$ )	$x, y, z, D([1], f)(x, y, z), D([2], f)(x, y, z), D([3], f)(x, y, z), c$
Matrixplot	$x, y, z$
Octahedron	See below.
Polar( $[r(t), \text{phi}(t)]$ )	$t, r(t), \text{phi}(t), x(t), y(t)$
Polygon2d( $[... , [x_i, y_i], ...]$ )	$x_i, y_i, i$
Polygon3d( $[... , [x_i, y_i, z_i], ...]$ )	$x_i, y_i, z_i, i$
Rootlocus( $p(z, u)$ )	$u, \text{Re}(z), \text{Im}(z)$
Spherical( $r(u, v), \text{phi}(u, v), \text{thet}(u, v)$ )	$u, v, r(u, v), \text{phi}(u, v), \text{thet}(u, v), x, y, z$
Streamlines2d( $v(x, y), w(x, y)$ )	$x, y, v(x, y), w(x, y), t, l, n$
Surface( $x(u, v), y(u, v), z(u, v)$ )	$u, v, x(u, v), y(u, v), z(u, v)$
SurfaceSTL	See below.
SurfaceSet	See below.
Tetrahedron	See below.
Tube	See below.

Type (abbreviated)	Parameters
VectorField2d( $v(x,y), w(x,y)$ )	$x, y, v(x,y), w(x,y)$
XRotate( $f(x)$ )	$x, \text{phi}, x, y(x, \text{phi}), z(x, \text{phi})$
ZRotate( $f(t)$ )	$t, \text{phi}, x(t, \text{phi}), y(t, \text{phi}), f(t)$ (= $z(t, \text{phi})$ )

Additionally, for animated (Symbolic Math Toolbox) objects, the current value of the animation parameter is provided.

Dodecahedron, Hexahedron, Icosahedron, SurfaceSTL, SurfaceSet, and Tetrahedron are built from triangles; the color functions are called once for each vertex of these triangles and are passed the number of the triangle (an integer count starting at 1), the coordinates of the vertex and the animation parameter, if that is used.

For `plot::Tube`, the color functions are given the coordinates of the currently visited point on the central curve, followed by the coordinates of the point on the surface, followed by the animation parameter, if any. (That makes seven arguments altogether.)

The examples below show different usage environments of color functions for some of the object types listed above.

## Examples

### Example 1

By default, most 3D-objects in MuPAD get “height coloring”:

```
plot(plot::Function3d(sin(x)*y^3))
```

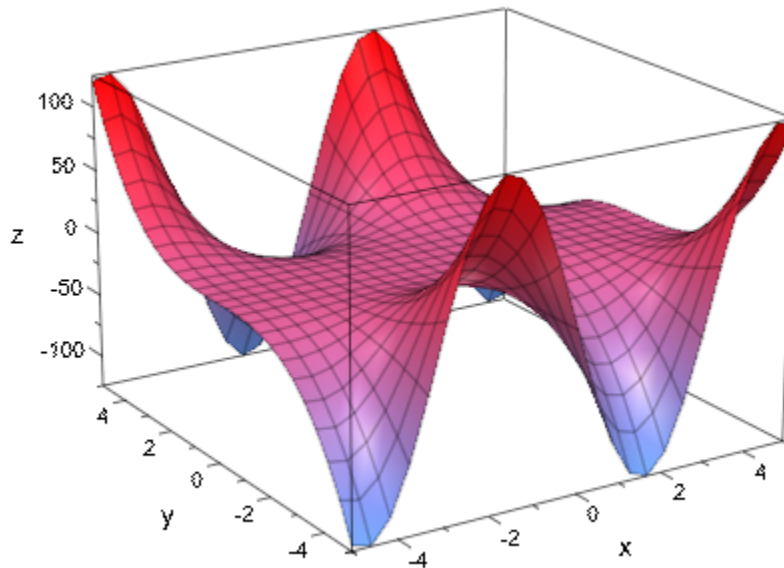

To change the direction of this color, you can use `FillColorFunction`:

```
xmin := -5:
xmax := 5:
color := zip(RGB::Red, RGB::CornflowerBlue,
             (a, b) -> (x-xmin)/(xmax-xmin)*a
                       +(xmax-x)/(xmax-xmin)*b)
```

```
[0.0607807 x + 0.6960965, 0.2921535 - 0.0584307 x, 0.4646975 - 0.0929395 x]
```

```
plot(plot::Function3d(sin(x)*y^3,
                      FillColorFunction = color))
```

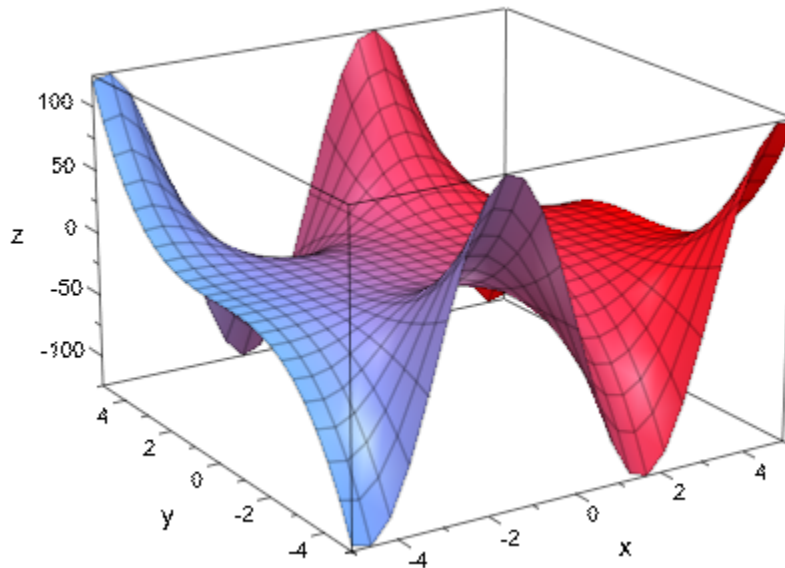

## Example 2

Animated color functions can be combined with static objects:

```
plot(  
  plot::Curve2d([sin(3*x), sin(4*x + 1)], x = 0..2*PI,  
    LineColorFunction = ((u, x, y, a) ->  
      [(u-a)/5, (u-a)/5, 1]),  
    a = -5..6)  
)
```



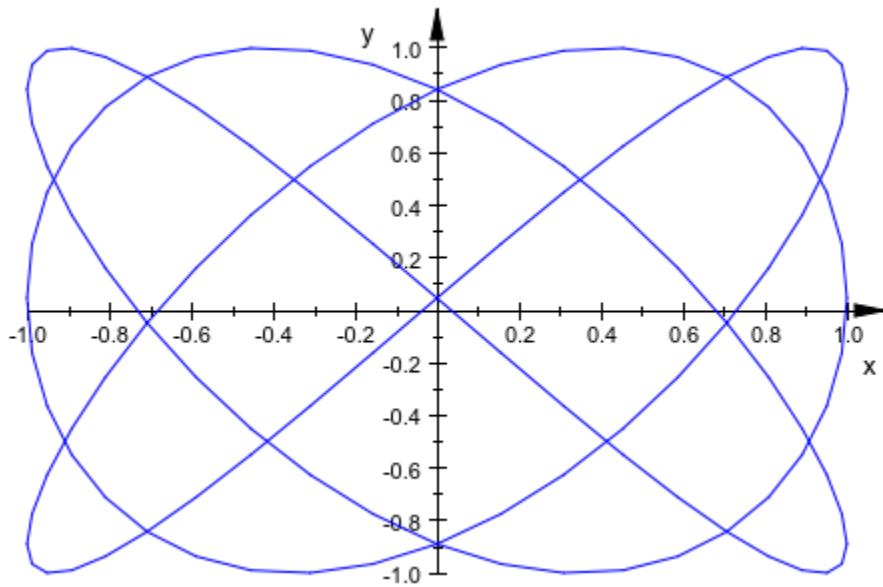

```
cf := (i, x, y, z, a) -> [RGB::Red,  
                          RGB::Green,  
                          RGB::Blue][(floor(a*i)  
                                     mod 3) + 1]:  
plot(plot::Icosahedron(FillColorFunction = cf,  
                      a = 0..9))
```

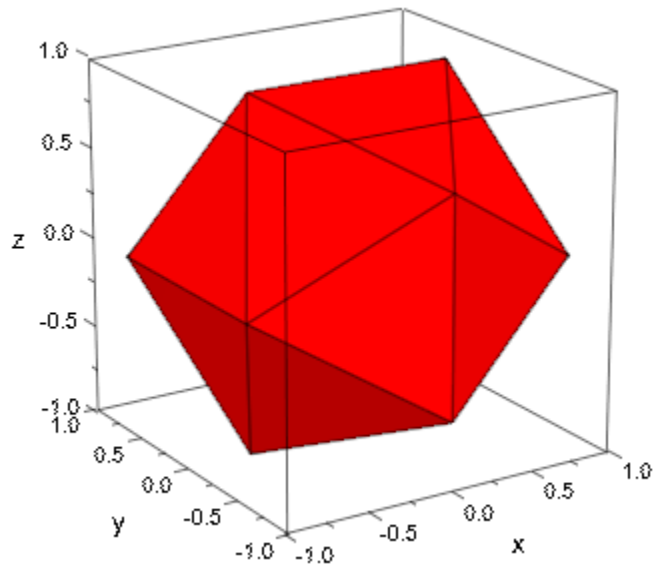

### Example 3

A color function should generate values in RGB (Symbolic Math Toolbox) color space. Since a `plot::Box` does not allow a `FillColorFunction`, we use six (trivial) `Surface` objects to show the outside of this color space:

```
rgb := (u, v, x, y, z) -> [x, y, z]:
plot(plot::Surface(formula, u = 0..1, v = 0..1,
    FillColorFunction = rgb)
    $ formula in [[0, u, v], [1, u, v],
    [u, 0, v], [u, 1, v],
    [u, v, 0], [u, v, 1]],
    plot::Box(0..1, 0..1, 0..1, Filled = FALSE,
    LineColor = RGB::Black.[0.25]),
    Scaling = Constrained, Axes = None,
    ULinesVisible = FALSE, VLinesVisible = FALSE,
    Lighting = None, CameraDirection = [4, 7, 3])
```

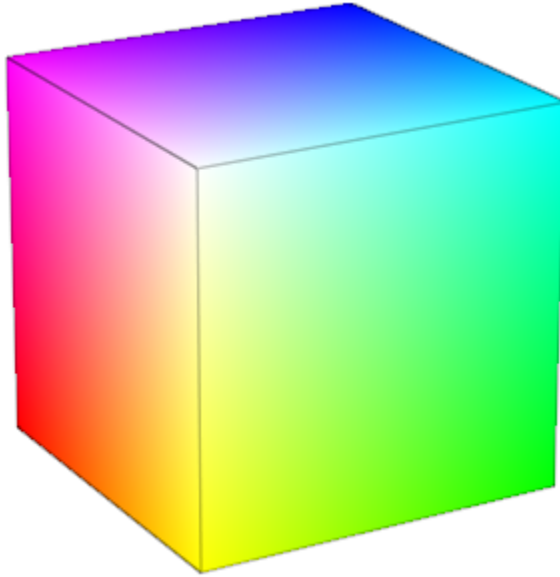

RGB colors are a very technical way of defining a color. The HSV color space is more popular with designers, since there the “hue” (i.e., the perceived color type) is not a combination of three numbers but rather one of the numbers making up a color:

```
hsv := (u, v, r, phi, z) -> RGB::fromHSV([180/PI*phi, r, z]):
plot(plot::Cylindrical([z, phi, z], z = 0..1, phi = 0..2*PI,
    FillColorFunction = hsv),
    plot::Cylindrical([r, phi, 1], r = 0..1, phi = 0..2*PI,
    FillColorFunction = hsv),
    plot::Circle3d(1, [0, 0, 1], [0, 0, 1],
    Color = RGB::Black.[0.25]),
    ZXRatio = 1.5, Scaling = Unconstrained,
    Axes = None, Lighting = None,
    ULinesVisible = FALSE, VLinesVisible = FALSE,
    CameraDirection = [-17, -12, 3])
```

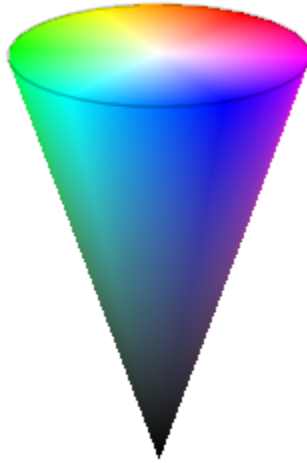

### Example 4

HSV color space is especially suitable for quick coloring of cylindrical, on page 24-247 polar, on page 24-618 or spherical on page 24-755 plots, due to its circular nature:

```
hsv := (u, v, r, phi, thet) ->
  RGB::fromHSV([180/PI*(phi+(thet+2)^3/PI^2),
    3/4+sin(u)/4, 1]):
plot(plot::Spherical([1, u, v], u = 0..2*PI, v = 0..PI,
  FillColorFunction = hsv))
```

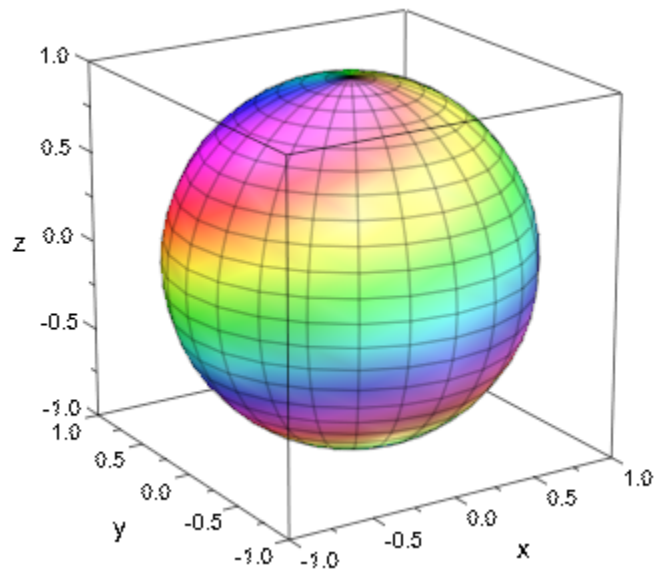

There are other examples, where the cyclic nature comes in handy, too:

```
hsv := (x, y, z) -> RGB::fromHSV([150*z, 1, 1]):  
plot(plot::Function3d(sin(x*y)*(x-y), x = -3..3, y = -3..3,  
    Submesh = [2, 2], FillColorFunction = hsv))
```

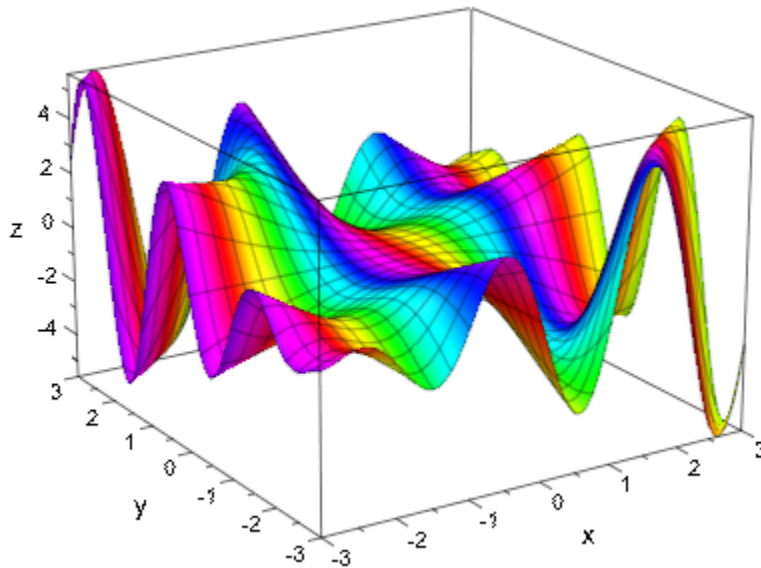

The following example takes a long time to compute. Reducing the values set for Mesh results in a shorter computation, while higher values lead to an image with finer details:

```

c := 0.377+0.2*I;
julia := proc(x, y)
    local i, z;
    begin
        i := 0;
        z := float(x + I*y);
        while i < 1000 and abs(z) < 4 do
            z := z^2 + c;
            i := i + 1;
        end_while;
        i;
    end_proc;
Jcol := (x, y, i) -> if i >= 1000 then
    RGB::Black
else
    RGB::fromHSV([i, 1, 3/4+i/2000])
end;
plot(plot::Density(julia, x = 0..0.5, y=0.25..0.75,

```

```
FillColorFunction = Jcol,
Mesh = [100,75]))
```

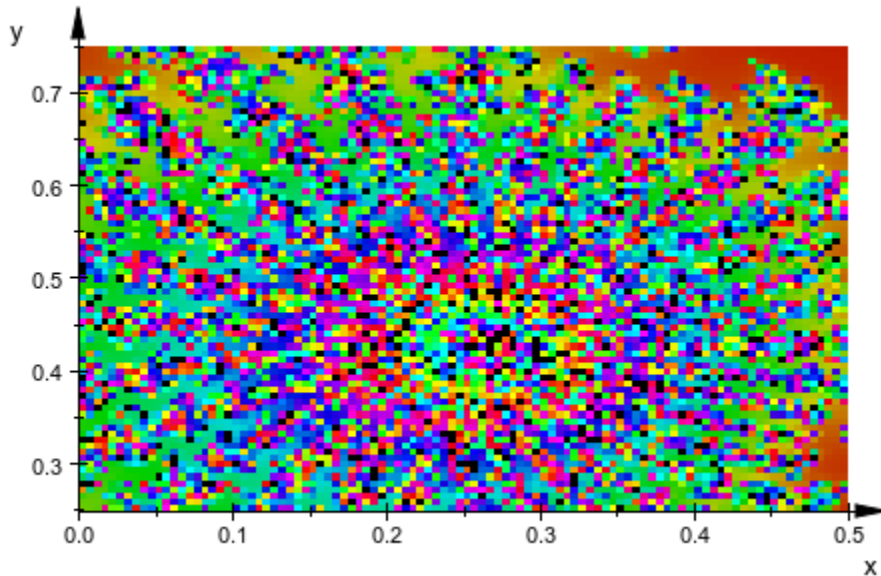

## Example 5

Another way of getting a smooth color transition is to use a periodic function in between, for example trigonometric ones (note the  $(1+\sin(a))/2$ : we need values between 0 and 1):

```
plot(
  plot::Polar([r*surd(r, 3), r], r = -4*PI..4*PI,
    AdaptiveMesh = 2,
    LineColorFunction = [(sin(r) + 1)/2,
                        (cos(r/2) + 1)/2,
                        1/3],
    LineWidth = 1*unit::mm)
)
```

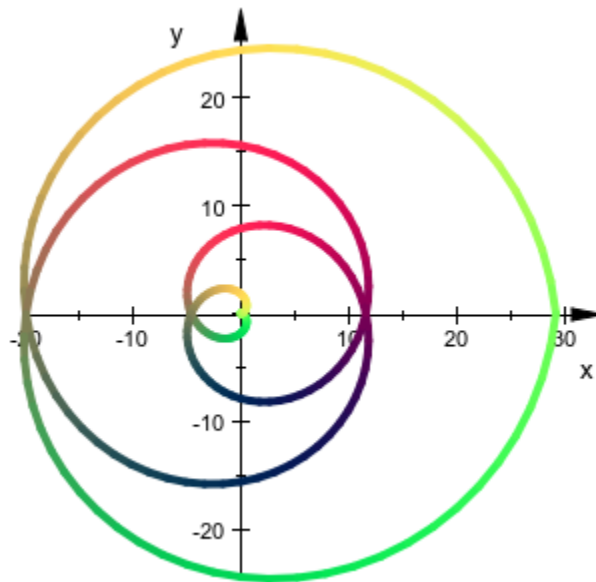

This also applies for cyclic colors in terms of time:

```
plot(plot::Function3d(sin(x)+sin(y), x = -5..5, y = -5..5,  
    FillColorFunction = [(x+5)/10, (y+5)/10,  
        abs(x+y+5*cos(a))/15,  
        (1+cos(x+y^2-a))/2],  
    a = 0..2*PI),  
    CameraDirection = [-1, -3, 3],  
    Scaling = Constrained)
```



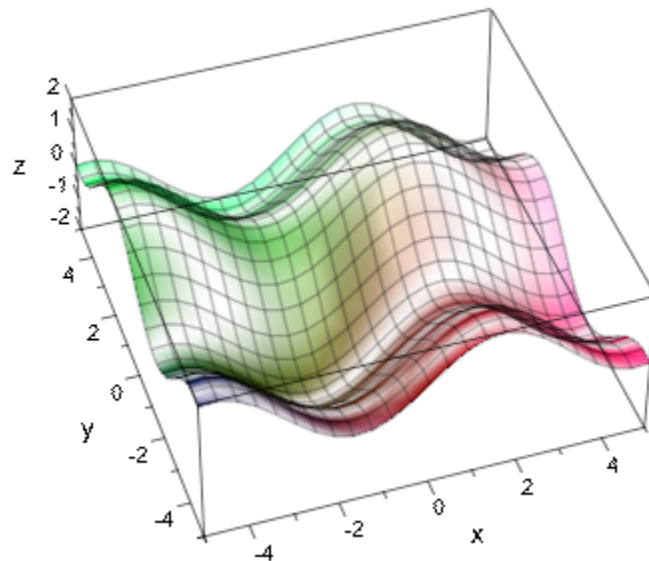

## Algorithms

Animation is handled by the general framework, not the individual objects. Therefore, the framework also supplies the animation parameter to the color functions.

## See Also

### MuPAD Functions

[FillColor](#) | [FillColorType](#) | [LineColor](#) | [LineColorType](#)

## Matrix2dMatrix3d

Transformation matrices

### Value Summary

Matrix2d, Matrix3d	Optional	List of four real-valued expressions
--------------------	----------	--------------------------------------

### Description

Matrix2d, Matrix3d represent the transformation matrices of transformation objects.

The general transformation objects `plot::Transform2d` and `plot::Transform3d` allow to apply the affine-linear transformation  $x \rightarrow Ax + b$  to 2D and 3D objects, respectively. Depending on the dimension, the transformation matrix  $A$  can be accessed and changed via the attributes `Matrix2d`, `Matrix3d`, of the transformation object. The shift vector  $b$  can be accessed and changed via the attribute `Shift`.

When setting the matrix attribute, matrices, arrays, lists of lists, and plain lists are accepted. Internally, however, the matrix data are always stored as a plain list

$$[A_{1,1}, A_{1,2}, A_{2,1}, A_{2,2}]$$

in 2D or

$$[A_{1,1}, A_{1,2}, \dots, A_{3,2}, A_{3,3}]$$

in 3D, respectively, representing the matrix row by row. When reading the matrix by a slot access, this plain list is returned.

The entries of `Matrix2d`, `Matrix3d` can be animated.

## Examples

### Example 1

We apply a linear transformation to an arrow:

```
A := matrix([[1, -1], [1, 1]]):
g := plot::Transform2d(A, plot::Arrow2d([0, 0], [0, 1])):
plot(g)
```

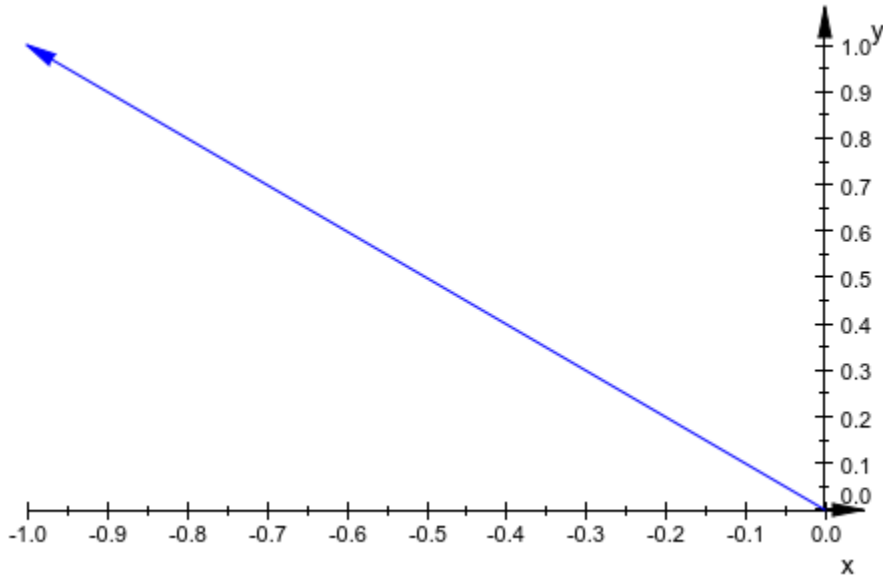

The `Matrix2d` corresponding to the transformation is stored as a plain list in the corresponding slot of `g`:

```
g::Matrix2d
```

```
[1.0, -1.0, 1.0, 1.0]
```

```
delete f, g:
```

## **See Also**

**MuPAD Functions**

Scale | Shift

# MeshListMeshListTypeMeshListNormals

Triangulation data

## Value Summary

MeshList	Mandatory	List of arithmetical expressions
MeshListType	Optional	ColorQuads, Quads, QuadStrip, Triangles, TriangleFan, or TriangleStrip
MeshListNormals	Optional	BeforeFacets, BeforePoints, BehindFacets, BehindPoints, or None

## Graphics Primitives

Objects	Default Values
plot::SurfaceSet	MeshListType: Triangles MeshListNormals: None

## Description

MeshList is a list of data defining the triangulation of a 3D surface of type plot::SurfaceSet.

MeshListType specifies how the data in the list MeshList are to be interpreted.

MeshListNormals specifies which of the data in the list MeshList are to be interpreted as normals.

MeshList contains coordinates of points (and optional normals) of either triangles or quads which define a mesh of a 3D surface. The points must be given homogenous: If a normal is given, it must be given for all points or facets, respectively. The attribute MeshListType specifies how these points are to be interpreted for plotting the surface.

The attribute `MeshListNormals` specifies whether the list contains normal vectors and at which positions they are located.

About normals and facet orientation: The facets (triangles or quads) define the surface of a 3D object. As such, each facet is part of the boundary between the interior and the exterior of the object. The orientation of the facets (which way is "out" and which way is "in") is specified redundantly in two ways which should be consistent: First, the direction of the normal is outward. Second, which is most commonly used now-a-day, the facet vertices are listed in counter-clockwise order when looking at the object from the outside (right-hand rule). Normals must be given as unit vectors.

`MeshList` must not contain color values. Use the color functions `LineColorFunction` and `FillColorFunction` instead.

`MeshListType` specifies how the points in `MeshList` are to be interpreted. Supported mesh list types are:

Value	Info	Description
Triangles	Set of separate triangles	Each tuple of three points define one new triangle.
TriangleFan	Triangle fan	The first triangle is defined by the first three points. The next triangles are defined by the first point, the previous point and the current point.
TriangleStrip	Triangle strip	The first triangle is defined by the first three points. The next triangles are defined by the two previous points and the current point.
Quads	Set of separate quads	Each tuple of four points define one new quad.
QuadStrip	Strip of quads	The first quad is defined by the first four points. The next quads are defined by the two previous points and the next two points.

`MeshListNormals` specifies whether `MeshList` contains normal vectors and at which positions they are located. Valid options are:

Value	Description
None	No normals are specified.

Value	Description
BeforePoints	A normal is given before each point.
BehindPoints	A normal is given behind each point.
BeforeFacets	A normal is given before each triangle or quad, respectively. This option is only valid for MeshListType = Triangles and MeshListType = Quads.
BehindFacets	A normal is given behind each triangle or quad, respectively. This option is only valid for MeshListType = Triangles and MeshListType = Quads.

## Examples

### Example 1

We create a triangle set with normals in front of each triangle and plot this object, a tetrahedron, afterwards:

```
meshList:= [
  0.0 ,  0.0 , -1.0 ,
 -1.5 , -1.5 ,  1.4 ,  0.0,  1.7,  1.4,  1.5, -1.5,  1.4,
  0.0 ,  0.88,  0.47,
 -1.5 , -1.5 ,  1.4 ,  1.5, -1.5,  1.4,  0.0,  0.0, -1.4,
 -0.88, -0.41,  0.25,
  1.5 , -1.5 ,  1.4 ,  0.0,  1.7,  1.4,  0.0,  0.0, -1.4,
  0.88, -0.41,  0.25,
  0.0 ,  1.7 ,  1.4 , -1.5, -1.5,  1.4,  0.0,  0.0, -1.4
]:
plot(plot::SurfaceSet(meshList,
  MeshListType = Triangles,
  MeshListNormals = BeforeFacets)):
```

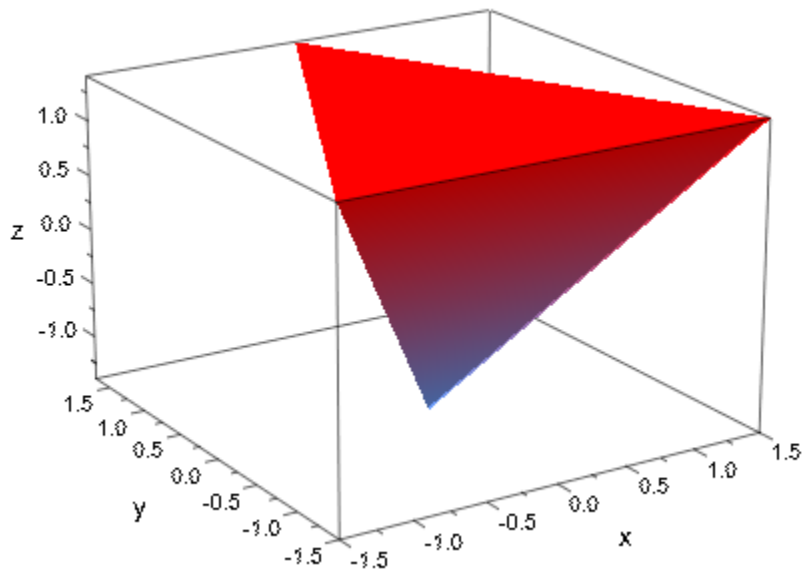

`delete meshList:`

## Example 2

See `plot::SurfaceSet` for further examples.

## See Also

**MuPAD Functions**

`OutputFile` | `UseNormals`



## Name

Name of an object

## Value Summary

Optional	Text string
----------	-------------

## Graphics Primitives

Objects	Name Default Values
plot::AmbientLight, plot::Arc2d, plot::Arc3d, plot::Arrow2d, plot::Arrow3d, plot::Bars2d, plot::Bars3d, plot::Box, plot::Boxplot, plot::Camera, plot::Canvas, plot::Circle2d, plot::Circle3d, plot::ClippingBox, plot::Cone, plot::Conformal, plot::CoordinateSystem2d, plot::CoordinateSystem3d, plot::Curve2d, plot::Curve3d, plot::Cylinder, plot::Cylindrical, plot::Density, plot::DistantLight, plot::Dodecahedron, plot::Ellipse2d, plot::Ellipse3d, plot::Ellipsoid, plot::Function2d, plot::Function3d, plot::Group2d, plot::Group3d, plot::Hatch, plot::Hexahedron, plot::Histogram2d, plot::Icosahedron, plot::Implicit2d, plot::Implicit3d, plot::Inequality, plot::Integral, plot::Iteration, plot::Line2d, plot::Line3d, plot::Listplot, plot::Lsys, plot::Matrixplot, plot::MuPADCube, plot::Octahedron, plot::Ode2d, plot::Ode3d, plot::Parallelogram2d, plot::Parallelogram3d, plot::Piechart2d, plot::Piechart3d, plot::Plane, plot::Point2d, plot::Point3d, plot::PointLight, plot::PointList2d, plot::PointList3d, plot::Polar, plot::Polygon2d, plot::Polygon3d,	

Objects	Name Default Values
plot::Prism, plot::Pyramid, plot::QQplot, plot::Raster, plot::Rectangle, plot::Reflect2d, plot::Reflect3d, plot::Rootlocus, plot::Rotate2d, plot::Rotate3d, plot::Scale2d, plot::Scale3d, plot::Scatterplot, plot::Scene2d, plot::Scene3d, plot::Sequence, plot::SparseMatrixplot, plot::Sphere, plot::Spherical, plot::SpotLight, plot::Streamlines2d, plot::Sum, plot::Surface, plot::SurfaceSet, plot::SurfaceSTL, plot::Sweep, plot::Tetrahedron, plot::Text2d, plot::Text3d, plot::Transform2d, plot::Transform3d, plot::Translate2d, plot::Translate3d, plot::Tube, plot::Turtle, plot::VectorField2d, plot::VectorField3d, plot::Waterman, plot::XRotate, plot::ZRotate	

## Description

The attribute `Name` sets the name of a graphical object. The object is displayed by this name in the legend and the interactive object browser of the graphics tool.

Giving a name to a graphical object has no significance whatsoever for the graphical appearance of the object. The main purpose of the name is to make it easier to identify the object in the interactive “object browser” of the MuPAD graphics tool (see section Viewer, Browser, and Inspector: Interactive Manipulation (Symbolic Math Toolbox) of this document).

If no name is specified, the type of the object is displayed in the object browser.

If the legend is “switched on” by setting `LegendVisible` to `TRUE`, the name slot of an object is used (if it exists), unless the object has a specific `LegendText`.

`Name` has a special technical semantics for objects of type `plot::Hatch`. The bounding functions or curves of the hatch are referenced via their name slot. If the bounding function or curve has no name slot, it is set implicitly by `plot::Hatch` to the output of `expr2text` of the function/curve. Cf. “Example 2” on page 24-1341 (Symbolic Math Toolbox)Example 2.

## Examples

### Example 1

The first two of the following function objects are given the names `Sin` and `Cos`, respectively. Generate the graphics and doubleclick on the plot. The two function objects are visible under their names in the object browser. The third function is just labeled as a 'Function2d' object. Also the legend uses this labeling:

```
plot(plot::Function2d(sin(x), x = -PI..PI, Name = "Sin",
                      Color = RGB::Red),
      plot::Function2d(cos(x), x = -PI..PI, Name = "Cos",
                      Color = RGB::Green),
      plot::Function2d(x/PI, x = -PI..PI, Color = RGB::Blue),
      LegendVisible = TRUE)
```

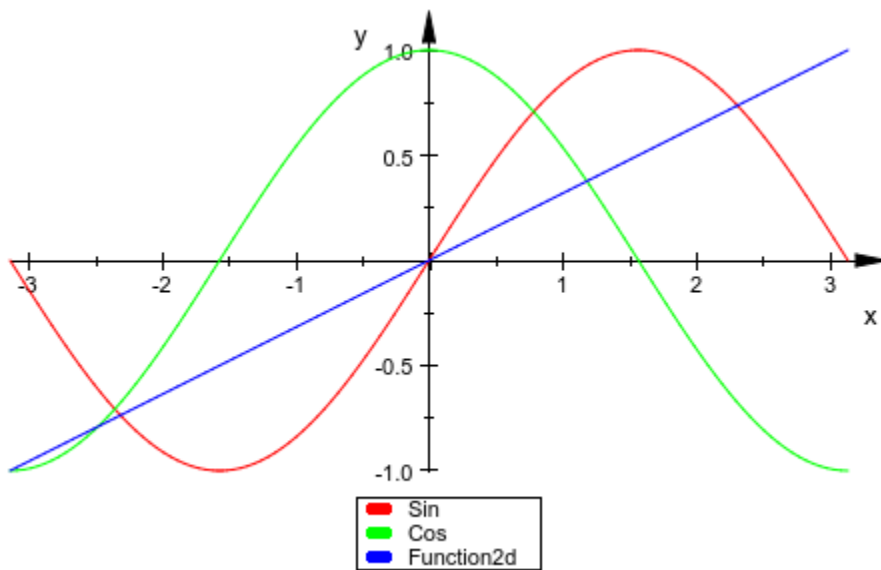

## Example 2

By default, an object does not have a Name entry:

```
f := plot::Function2d(cos(x), x=0..PI):
f::Name
```

FAIL

When creating a `plot::Hatch` object, the Name slot is set implicitly for the border function(s):

```
h := plot::Hatch(f):
h::Name
```

```
"Function2d(XMin = 0, XMax = PI, XName = x, Function = cos(x), XAxisTitle = "x")"
```

We plot the hatch with its bounding function:

```
plot(h, f)
```

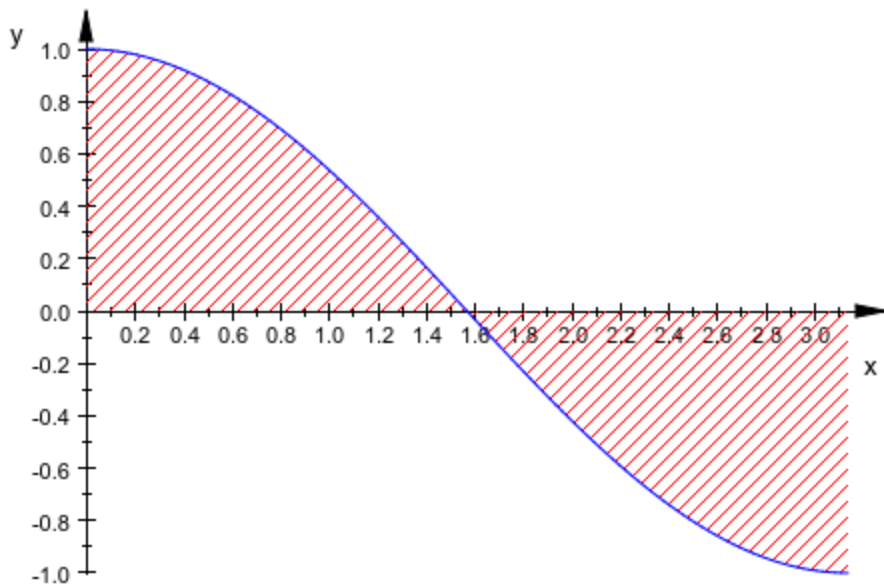

Doubleclick on the graphics and observe the way the objects are labeled in the object inspector.

```
delete f, h:
```

## See Also

### MuPAD Functions

Function1 | Function2 | LegendText | Title

## Nodes

Number of subintervals or list of x-values for subintervals

## Value Summary

Optional	List of arithmetical expressions
----------	----------------------------------

## Graphics Primitives

Objects	Nodes Default Values
<code>plot::Integral</code>	[10]

## Description

Nodes is a positive number of subintervals for numeric approximation of integrals. The given interval for approximation is divided into the given number of subintervals, all of the same width.

Otherwise, Nodes can be a list of x-values for dividing the given interval. The interval is divided into subintervals at the given x-values.

When a number is given for Nodes, the number can be given as a list with this one number, too.

When a list with x-values is given, the left and right border of the whole (approximation) interval can be omitted. In this case, the number of subintervals is the number of given x-values plus one.

Nodes outside the approximation interval are ignored. Duplicate values are ignored.

The nodes need not be ordered.

## Examples

### Example 1

Nodes determines the number of rectangles for Riemann sums:

```
f := plot::Function2d(x*(x+4)*(x-4)):
plot(plot::Integral(f, Nodes = 25, IntMethod = RiemannLower), f)
```

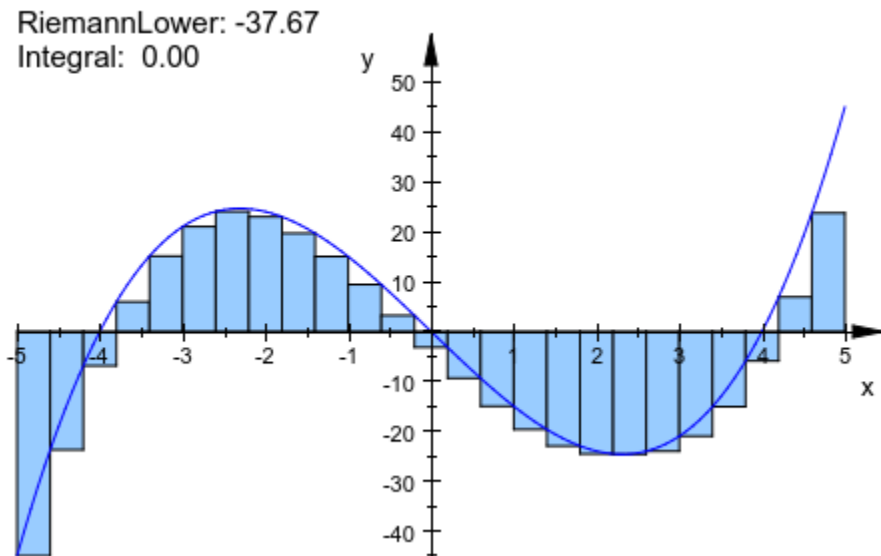

Increasing of Nodes decreases the error of the approximation:

```
plot(plot::Integral(f, Nodes = 125, IntMethod = RiemannLower), f)
```



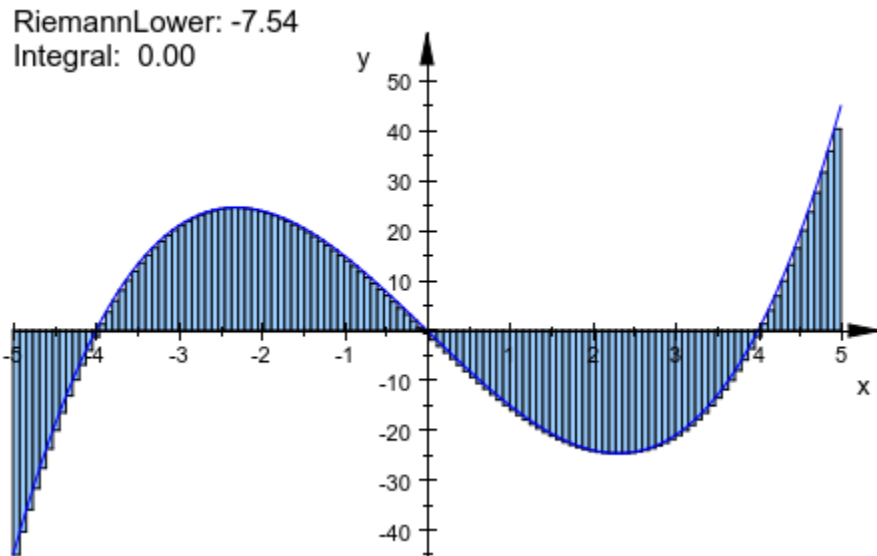

delete f:

## Example 2

We request a specific division into subintervals:

```
f := plot::Function2d(sin(x), x = -2*PI..2*PI):
plot(
  plot::Integral(f, Nodes = [i*PI/2 $ i = -4..4],
    IntMethod = Trapezoid),
  f)
```

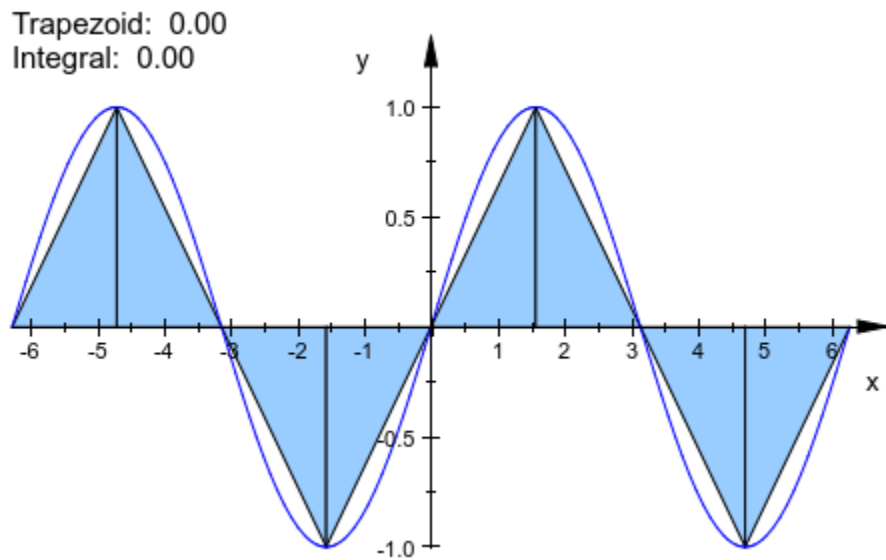

The subintervals do not need to be of equal width:

```
f := plot::Function2d(sin(x), x = 0..PI):  
plot(  
  plot::Integral(f, [PI/3, PI/2, 2*PI/3],  
    IntMethod = Trapezoid),  
  f)
```

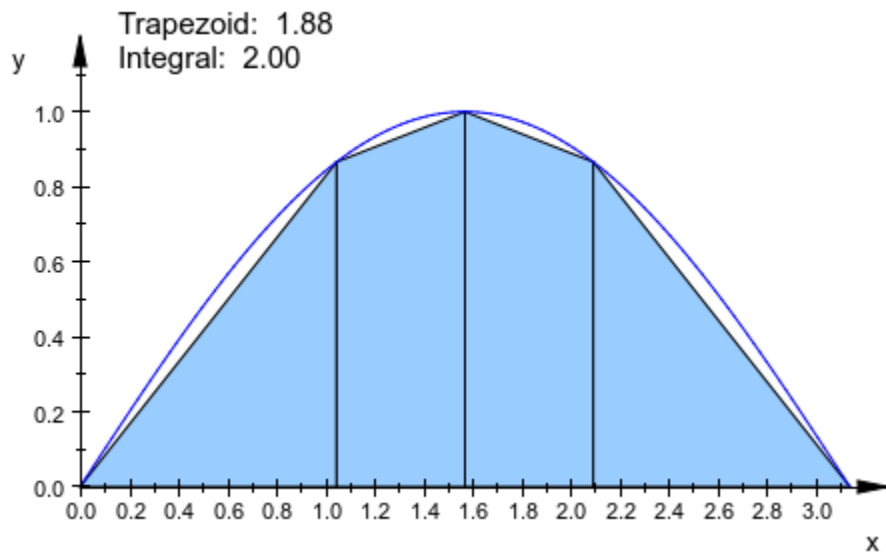

delete f:

## See Also

**MuPAD Functions**  
IntMethod

## NormalNormalXNormalYNormalZ

Normal vector of circles and discs, etc. in 3D

### Value Summary

Normal	Library wrapper for “[NormalX, NormalY]” (2D), “[NormalX, NormalY, NormalZ]” (3D)	List of 2 or 3 expressions, depending on the dimension
NormalX, NormalY, NormalZ	Mandatory	MuPAD expression

### Graphics Primitives

Objects	Default Values
plot::Prism, plot::Pyramid	Normal: [0, 0, 0] NormalX, NormalY, NormalZ: 0
plot::Arc3d, plot::Circle3d, plot::Ellipse3d, plot::Plane, plot::Reflect3d	Normal: [0, 0, 1] NormalX, NormalY: 0 NormalZ: 1

### Description

Normal determines the normal vector of the plane of the 3D circle, prism or pyramid. It is given by a list or vector of 3 components.

NormalX etc. refer to the  $x$ ,  $y$ ,  $z$  components of this vector.

The values of these attributes can be animated.

With `Filled = TRUE`, a circle becomes a disc.

## Examples

### Example 1

We create a circle around the origin lying in the x-y plane:

```
c := plot::Circle3d(1, [0, 0, 0], [0, 0, 1])
```

```
plot::Circle3d(1, [0, 0, 0], [0, 0, 1])
```

The second argument in `plot::Circle3d` is the center, the third argument is the normal. Internally, these vectors are stored as the attributes `Center` and `Normal` and can be changed by assigning a new value:

```
c::Normal := [-0.5, 0.5, 1]:  
plot(c):
```

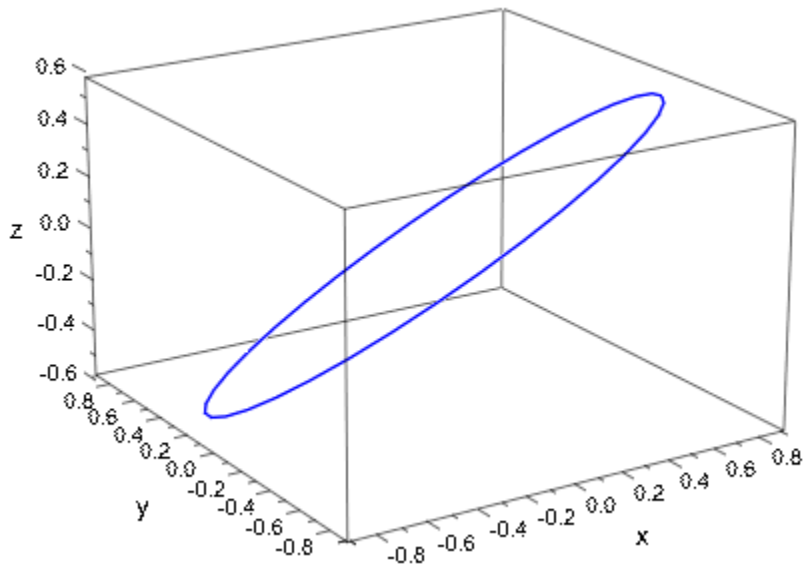

```
delete c:
```

## Example 2

Normal can be animated:

```
plot(plot::Circle3d(1, [0, 0, 0], [cos(a), sin(a), 0],  
                   a = 0 .. 2*PI, Filled = TRUE),  
      Axes = Origin):
```

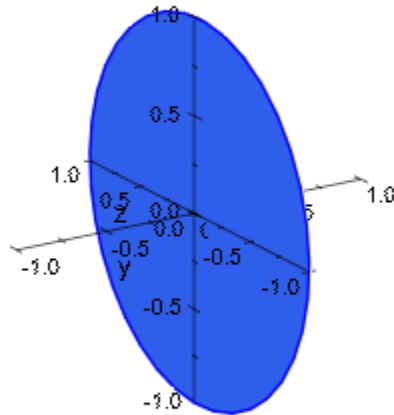

## Example 3

Normal can be used to create crooked prisms, pyramids and frustums of pyramids. If this attribute is set to  $[0, 0, 0]$ , the axis between Base and Top is used as normal vector:

```
plot(plot::Scene3d(plot::Pyramid(2, [0,0,0], 1, [0,4,4], Normal=[0,0,0])),  
      plot::Scene3d(plot::Pyramid(2, [0,0,0], 1, [0,4,4], Normal=[0,0,1]))):
```

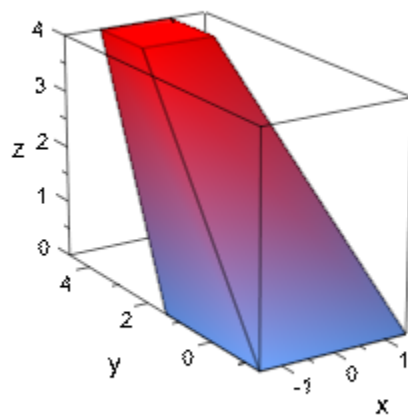
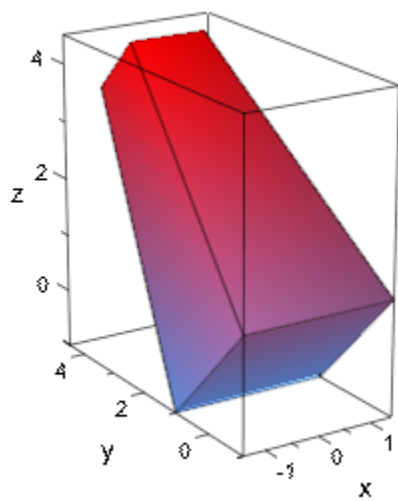

# ParameterNameParameterBeginParameterEndParameterRange

Name of the animation parameter

## Value Summary

ParameterBegin, ParameterEnd, ParameterName	Optional	MuPAD expression
ParameterRange	[ParameterBegin .. ParameterEnd]	Range on page 1-16 of arithmetical expressions

## Description

Typically, animations are triggered by passing an equation of the form  $a = a_{\min} \dots a_{\max}$  in the definition of an object.

This is equivalent to passing the attributes  $\text{ParameterName} = a$ ,  $\text{ParameterBegin} = a_{\min}$ , and  $\text{ParameterEnd} = a_{\max}$  in the definition of the object.

The attribute  $\text{ParameterRange} = a_{\min} \dots a_{\max}$  is equivalent to setting both  $\text{ParameterBegin} = a_{\min}$  and  $\text{ParameterEnd} = a_{\max}$ .

Animations are defined object by object, not frame by frame.

In most cases, the user will define animations by passing an equation of the form  $a = a_{\min} \dots a_{\max}$  in the definition of an object. Any equation of this form that is not essential for the definition of a static version of the object is interpreted as an animation parameter and an animation range.

Passing such an equation is equivalent to setting the three attributes

$\text{ParameterName} = a$ ,  $\text{ParameterBegin} = a_{\min}$ ,  $\text{ParameterEnd} = a_{\max}$ .



The attribute `ParameterRange = `a_{min}` .. `a_{max}`` serves as a short cut for setting both `ParameterBegin = amin` and `ParameterEnd = amax`.

The values `amin` and `amax` are the parameter values at the beginning and the end of the real time range in which an object is animated. This time range is set by the attributes `TimeBegin` and `TimeEnd`, respectively.

The parameter range ``a_{min}` .. `a_{max}`` is mapped linearly to this time interval.

The name of the animation parameter may be an identifier on page 7-29 or an indexed identifier on page 1-1017. This parameter is a 'global variable' that may be present in other quantities or attributes defining the object.

The definition of an object may involve procedures rather than symbolic expressions. E.g., a 2D function plot may be defined by `plot::Function2d(f, x = x_0..x_1)`, where `f` is a procedure accepting one numerical argument `x` from the plot range between `x0` and `x1`.

In an animated version `plot::Function2d(f, x = x_0..x_1, a = `a_{min}` .. `a_{max}`)`, the function `f` will be called with two arguments `x` and `a`. Thus, `f` may be defined as a function accepting two parameters `x`, `a` or as a function with one parameter `x`, using the animation parameter `a` as a global variable.

Each animated object has its own animation parameter and range ``a_{min}` .. `a_{max}``. It is not necessary that several animated objects in a scene use the same parameter name. It is not used to synchronize the animations.

The synchronization is determined uniquely by the linear correspondence between the animation range ``a_{min}` .. `a_{max}`` and the real time span of the animation set by the attributes `TimeBegin` and `TimeEnd` of the object.

## Examples

### Example 1

The definition of a static 2D function plot involves the specification of one range (for the `x` variable):

```
plot(plot::Function2d(sin(x), x = 0 .. 2*PI))
```

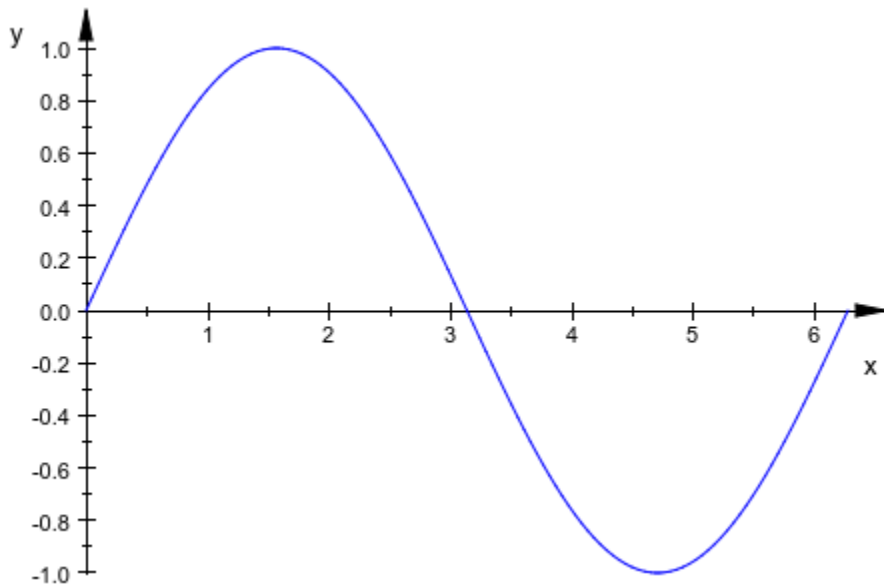

When a “surplus equation”  $a = \text{`a}_{\min}\text{` .. `a}_{\max}\text{`}$  is passed, this is interpreted as a call to animate the function. The animation parameter may turn up in the expression defining the function:

```
plot(plot::Function2d(sin(x + a), x = a .. 2*PI, a = 0..PI))
```

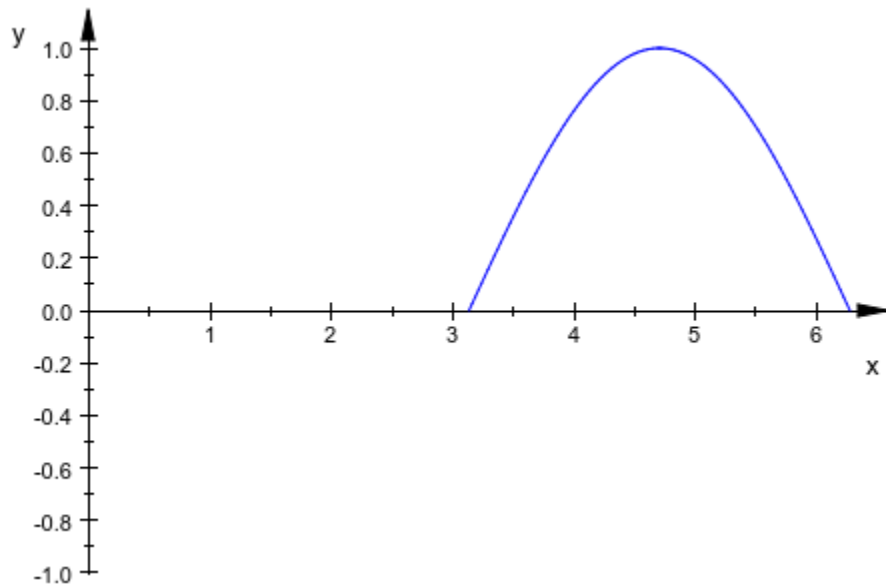

A static function plot in 3D requires two ranges (for the x and the y variable):

```
plot(plot::Function3d(sin(x)*sin(y), x = 0 .. PI, y = 0..PI))
```

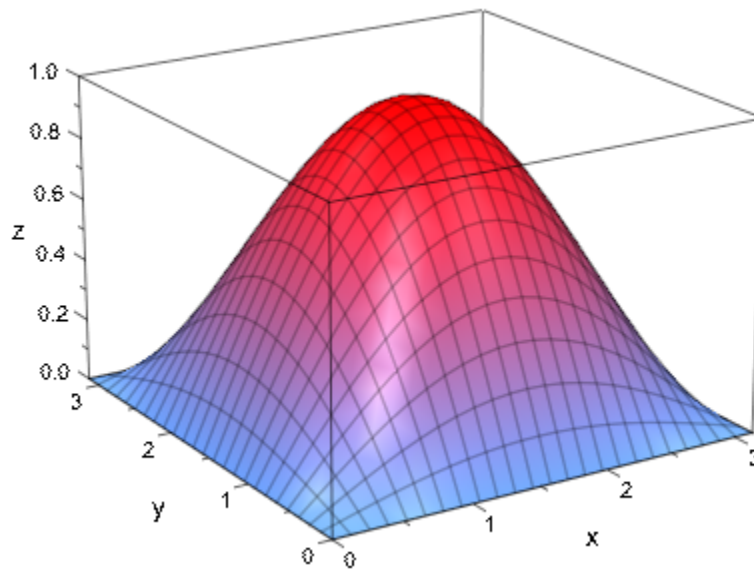

Now, a third equation  $a = `a_{\min}` .. `a_{\max}`$  triggers an animation:

```
plot(plot::Function3d(sin(x + a)*sin(y - a), x = 0 .. PI,  
y = 0..PI, a = 0..PI))
```

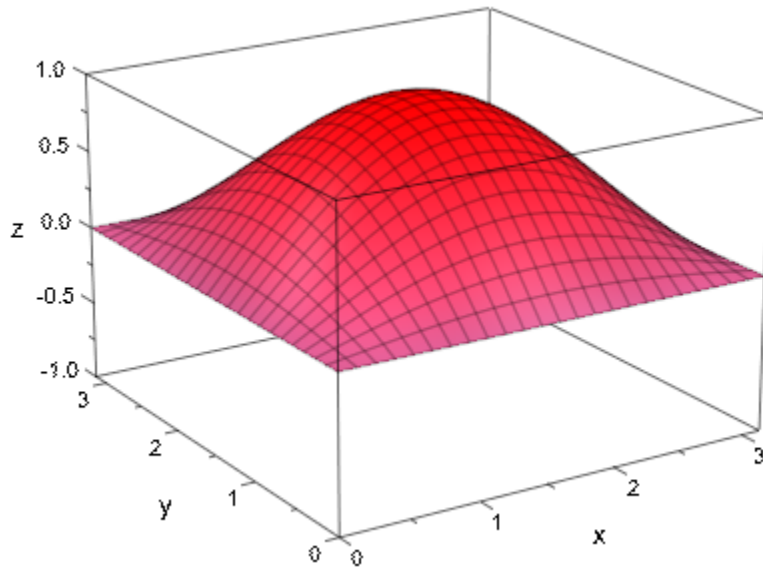

## Example 2

We define an animated 2D function plot:

```
f := plot::Function2d(x^3 + a*x, x = -1..1, a = 0..2):  
plot(f):
```

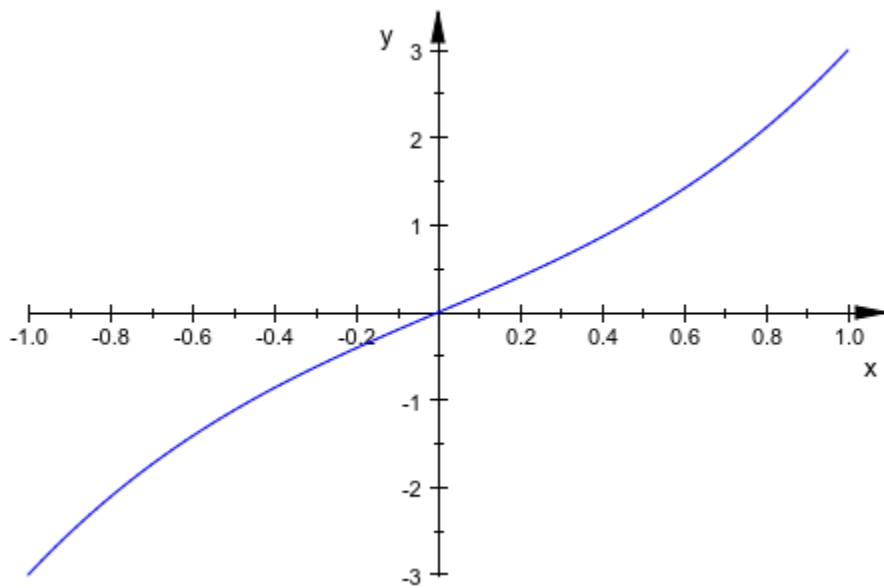

We swap the role of the independent variable  $x$  and the animation parameter  $a$ :

```
[f::XName, f::ParameterName] := [f::ParameterName, f::XName]:  
[f::XRange, f::ParameterRange] :=  
    [f::ParameterRange, f::XRange]:
```

The function now is drawn as a function of  $a$  for various values of the “time”  $x$ :

```
plot(f)
```

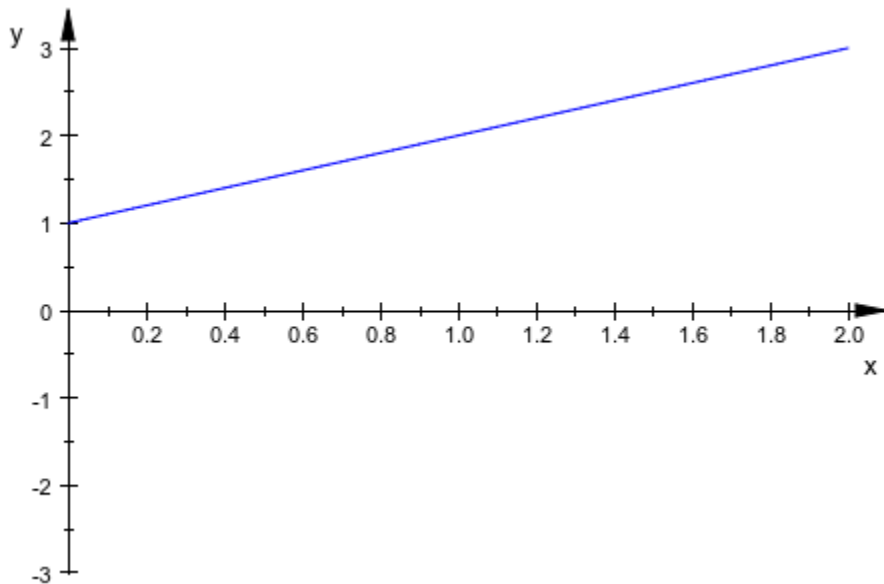

delete f:

### Example 3

We demonstrate the use of procedures in the definition of animated functions.

We wish to plot the eigenvalues of a matrix that depends on two parameters  $x$  and  $a$ . The eigenvalues are computed numerically in the procedure `eigenvals`. This procedure uses option `remember`, because it is called thrice with the same arguments by the procedures  $f_1$ ,  $f_2$ ,  $f_3$  that produce the smallest, the middle, and the largest eigenvalue, respectively, as functions of the parameters  $x$  and  $a$ :

```
eigenvals :=
  proc(x, a)
    option remember;
    local A;
  begin
    A:= matrix([[1, a, x ],
               [a, 2, a*x],
               [x, a*x, 3 ]]):
    sort(numeric::eigenvalues(A)):
```

```
end_proc:
f1:= (x, a) -> eigenvals(x, a)[1]:
f2:= (x, a) -> eigenvals(x, a)[2]:
f3:= (x, a) -> eigenvals(x, a)[3]:

plot(plot::Function2d(f1, x = -2..2, a = 0..2,
    Color = RGB::Red),
    plot::Function2d(f2, x = -2..2, a = 0..2,
    Color = RGB::Green),
    plot::Function2d(f3, x = -2..2, a = 0..2,
    Color = RGB::Blue)):
```

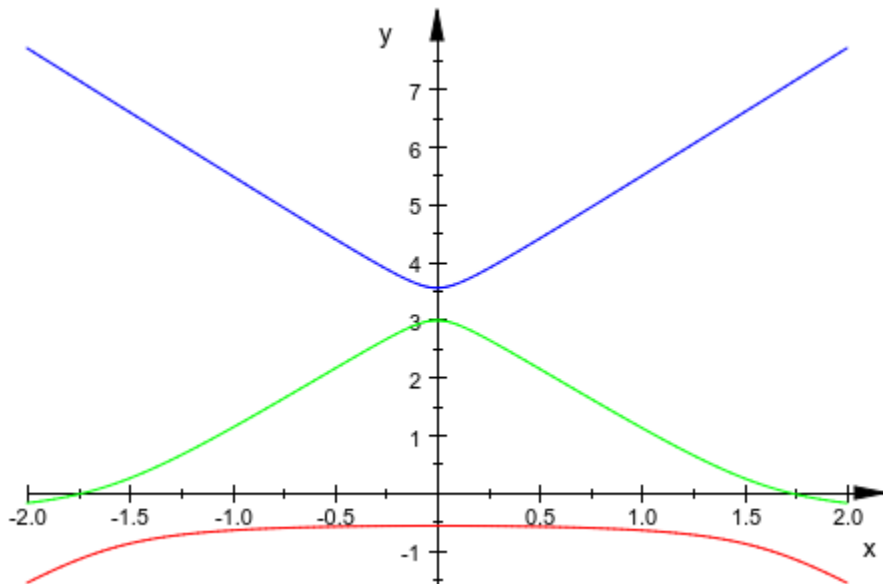

```
delete eigenvals, f1, f2, f3:
```

## See Also

### MuPAD Functions

Frames | TimeBegin | TimeEnd | TimeRange | VisibleAfter | VisibleAfterEnd | VisibleBefore | VisibleBeforeBegin | VisibleFromTo



## **Topics**

“The Number of Frames and the Time Range” (Symbolic Math Toolbox)

## Points2dPoints3d

List of 2D points

### Value Summary

Points2d, Points3d	Mandatory	List of 2D points
--------------------	-----------	-------------------

### Graphics Primitives

Objects	Default Values
plot::PointList2d, plot::PointList3d, plot::Polygon2d, plot::Polygon3d	

### Description

Points2d is the list of 2D points in objects of type plot::PointList2d and plot::Polygon2d, respectively.

Points3d is the list of 3D points in objects of type plot::PointList3d and plot::Polygon3d, respectively.

One usually defines such an object *p*, say, via

```
p := plot::PointList2d([[x1, y1], [x2, y2], ...]) or
```

```
p := plot::Polygon2d([[x1, y1], [x2, y2], ...]), respectively.
```

Internally, the points are stored as the attribute

```
Points2d = [[x1, y1], [x2, y2], ...]
```

and can be accessed via the slot call `p::Points2d`. Assigning a new list to `p::Points2d` changes the object *p* accordingly.

The corresponding statements hold for 3D point lists and polygons.

The points in the list `Points2d` may consist of lists with 2 elements (the  $x$  and  $y$  coordinates) or of lists with 3 elements (the  $x$  and  $y$  coordinates and the RGB (Symbolic Math Toolbox) color of the point).

The points in the list `Points3d` may consist of lists with 3 elements (the  $x$ ,  $y$ , and  $z$  coordinates) or of lists with 4 elements (the  $x$ ,  $y$ ,  $z$  coordinates and the RGB/RGBa (Symbolic Math Toolbox) color of the point).

If you specify the color of one point, you must specify the colors of all other points in the list. See “Example 2” on page 24-1365 (Symbolic Math Toolbox).

The points in the lists `Points2d` and `Points3d` can be animated.

## Examples

### Example 1

We define a 2D polygon with 5 points:

```
p := plot::Polygon2d([[0, 0], [1, 1], [1, 2], [2, 2], [2, 1]]):  
plot(p):
```

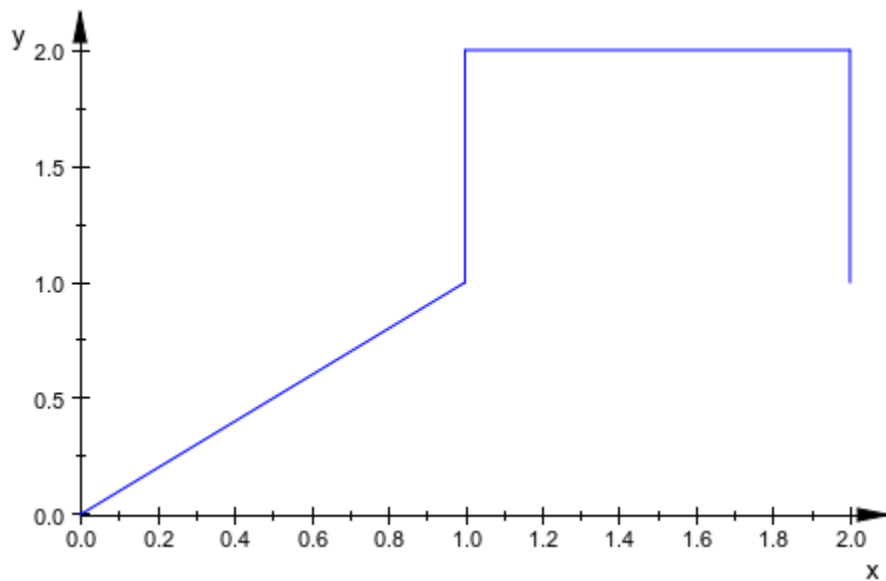

The points in the polygon can be accessed as the `Points2d` attribute:

```
pts := p::Points2d
```

```
[[0, 0], [1, 1], [1, 2], [2, 2], [2, 1]]
```

We change the polygon by assigning a new point list:

```
p::Points2d := [pts[1], pts[5], pts[2], pts[4], pts[3]]:  
plot(p):
```

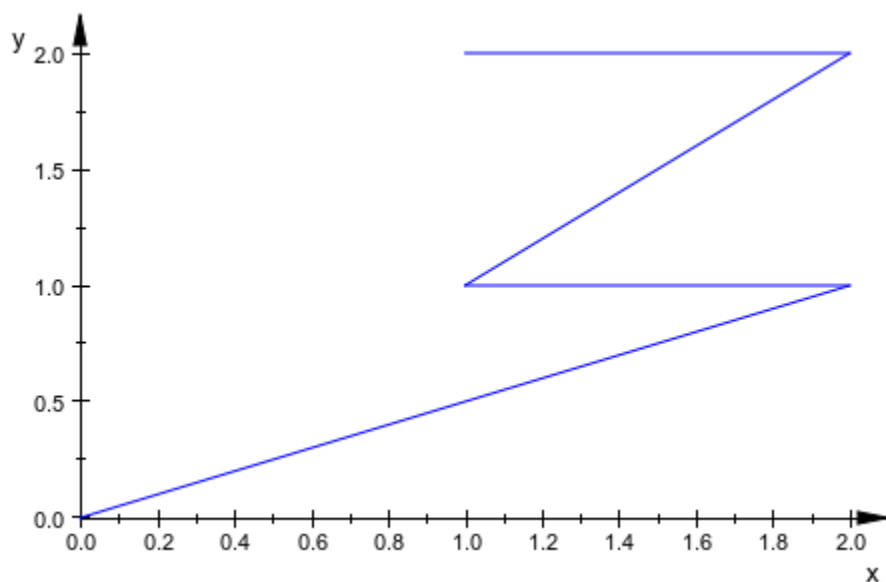

```
delete p, pts:
```

## Example 2

Points2d and Points3d allow you to specify the colors of the points. For example, the following list contains two points. The `plot` function uses the default color for both points on the plot:

```
Coords := [[3, 4], [5, 5]];
plotCoords := plot::PointList2d(Coords):
plot(plotCoords, PointSize = 5)
```

```
[[3, 4], [5, 5]]
```

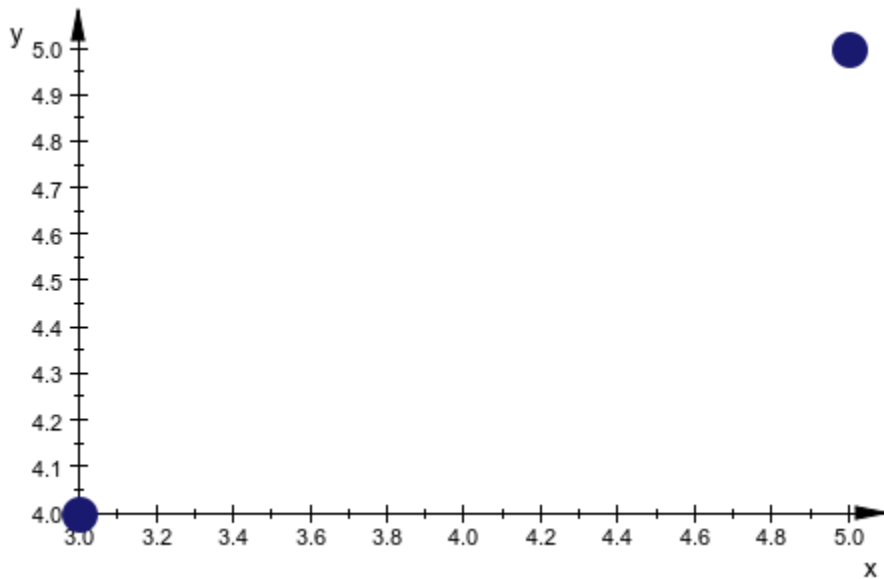

To access and modify the list of points, use `Points2d`. For example, include the color of each point in the list:

```
plotCoords::Points2d := [[3, 4, RGB::Red], [5, 5, RGB::Green]]
```

```
[[[3, 4, [1.0, 0.0, 0.0]], [5, 5, [0.0, 1.0, 0.0]]]
```

Now the first point appears in red, and the second point appears in green:

```
plot(plotCoords, PointSize = 5)
```

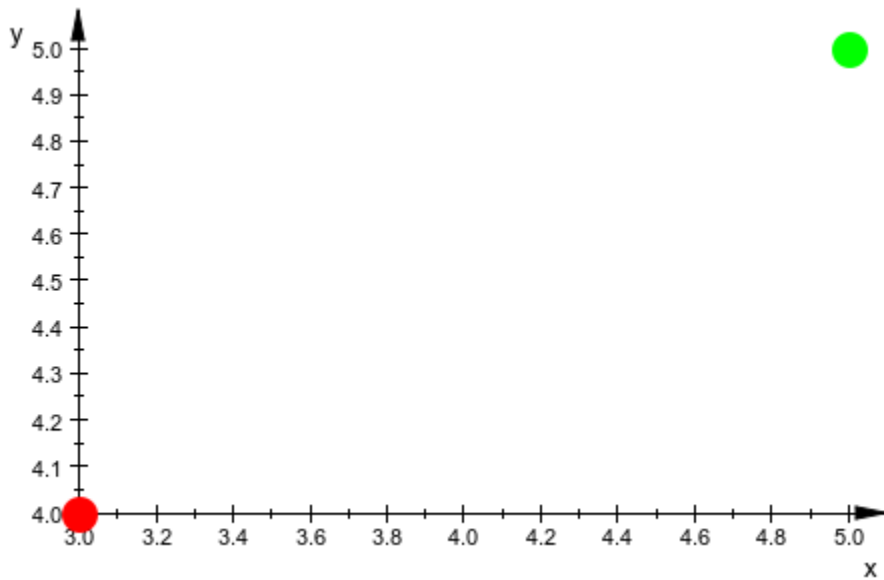

If you specify the color of one point, you must also specify the colors of all other points in the list:

```
plotCoords::Points2d := [[3, 4, RGB::Red], [5, 5]]
```

Error: Attribute 'Points2d' in the 'PointList2d' object must be a list of lists of two

## Position PositionX PositionY PositionZ

Positions of cameras, lights, and text objects

### Value Summary

Position	Library wrapper for “[PositionX, PositionY]” (2D), “[PositionX, PositionY, PositionZ]” (3D)	List of 2 or 3 expressions, depending on the dimension
PositionX, PositionY, PositionZ	Mandatory	MuPAD expression

### Graphics Primitives

Objects	Default Values
plot::Camera, plot::DistantLight, plot::PointLight, plot::SpotLight, plot::Text2d, plot::Text3d	
plot::Point2d	Position: [0, 0] PositionX, PositionY: 0
plot::Plane, plot::Point3d, plot::Reflect3d	Position: [0, 0, 0] PositionX, PositionY, PositionZ: 0

### Description

Position determines the positions of cameras, lights, and text objects.

PositionX etc. refer to the single coordinate values of the position.



The attribute `Position` refers to the location of a camera on page 24-1158 taking pictures of a 3D scene. Its a value is a list or vector of coordinates.

Also the position of light sources illuminating the 3D scene is set by `Position`.

Further, `Position` determines the coordinates where text objects are to be placed.

These attributes can be animated. Animating a camera position one can realize a flight through a 3D scene.

By default, the position of lights is given in model coordinates that have nothing to do with the camera that is used to view the scene.

The attribute `CameraCoordinates` also allows to position a light relative to the camera. In particular, the light moves automatically, when the camera is moved.

## Examples

### Example 1

We define a 3D scene consisting of a function, a distant light, and a camera. The light shines from the direction of the camera:

```
f := plot::Function3d(sin(x^2 - y^2), x = -2..2, y = -2..2,
                      Color = RGB::White):
light := plot::DistantLight([3, 4, 5], [0, 0, 0], 0.75,
                            Color = RGB::Yellow):
camera := plot::Camera([3, 4, 5], [0, 0, 0], 0.25*PI):
plot(f, light, camera)
```

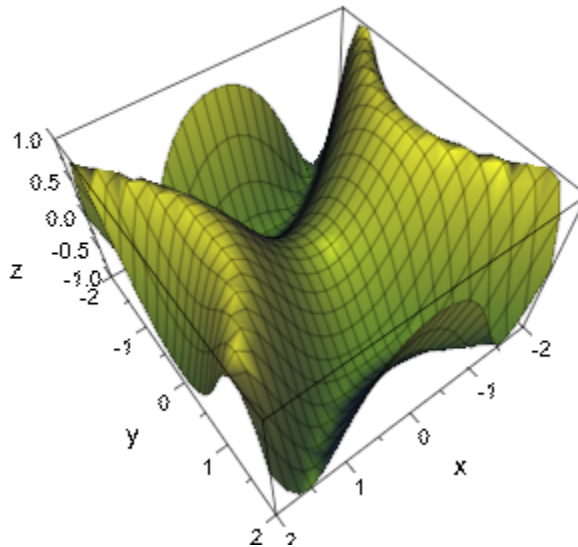

We animate the camera position but keep the light position fixed:

```
camera::Position := [3*sqrt(2)*cos(a + PI/4),  
                    4*sqrt(2)*sin(a + PI/4),  
                    5*(0.7 + 0.3*cos(2*a))]:  
camera::ParameterName := a:  
camera::ParameterRange := 0..2*PI:  
plot(f, light, camera)
```

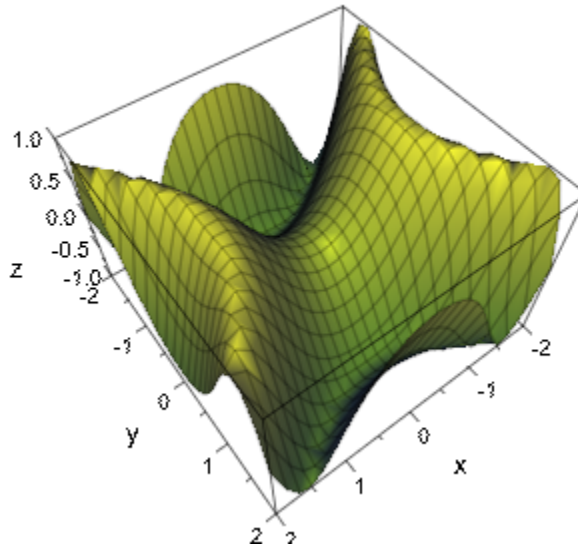

Using the same objects, we fix the camera and animate the light position:

```
camera::Position := [3, 4, 5]:
camera::Frames := 1:
light::Position := [3*sqrt(2)*cos(a + PI/4),
                   4*sqrt(2)*sin(a + PI/4),
                   5]:
light::ParameterName := a:
light::ParameterRange := 0..2*PI:
plot(f, light, camera)
```

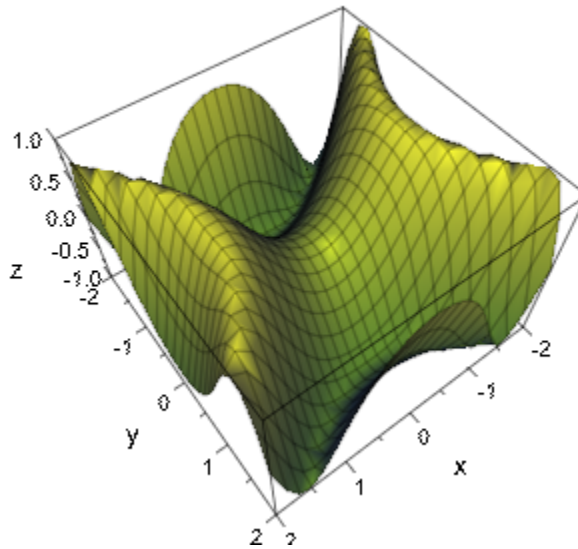

delete f, light, camera:

## See Also

### MuPAD Functions

CameraCoordinates | CameraDirection | FocalPoint | SpotAngle | Target | ViewingAngle

# Radius

Radius of circles, spheres etc.

## Value Summary

Mandatory	MuPAD expression
-----------	------------------

## Graphics Primitives

Objects	Radius Default Values
<code>plot::Circle2d</code> , <code>plot::Circle3d</code> , <code>plot::Cylinder</code> , <code>plot::Dodecahedron</code> , <code>plot::Hexahedron</code> , <code>plot::Icosahedron</code> , <code>plot::MuPADCube</code> , <code>plot::Octahedron</code> , <code>plot::Piechart2d</code> , <code>plot::Piechart3d</code> , <code>plot::Prism</code> , <code>plot::Sphere</code> , <code>plot::Tetrahedron</code>	1
<code>plot::Waterman</code>	

## Description

Radius defines the radius of circles (`plot::Circle2d` and `plot::Circle3d`, respectively), spheres (`plot::Sphere`), cylinders (`plot::Cylinder`), circumcircles of regular bases of prisms (`plot::Prism`) and pie charts (`plot::Piechart2d` and `plot::Piechart3d`, respectively). Also polyhedra such as `plot::Dodecahedron` use this attribute to set their size.

## Examples

### Example 1

We generate a sphere around the origin with radius 2:

```
s := plot::Sphere(2, [0, 0, 0])
```

```
plot::Sphere(2, [0, 0, 0])
```

The first argument in `plot::Sphere` is the radius, the second argument is the center. Internally, these values are stored as the attributes `Radius` and `Center`, respectively. We can access the objects' attributes and change them:

```
s::Radius, s::Center
```

```
2, [0, 0, 0]
```

```
s2 := plot::copy(s):  
s2::Center := [4, 0, 0]:  
s2::Radius := 1:  
plot(s, s2):
```

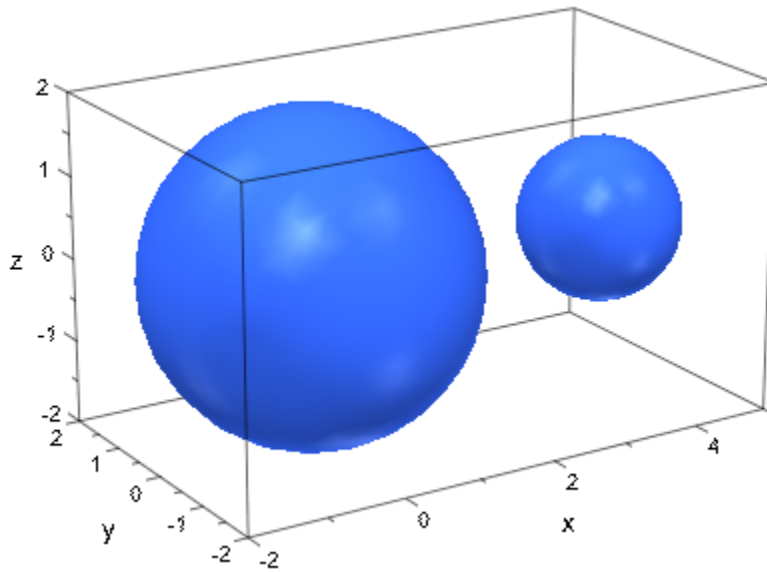

```
delete s, s2:
```

## Example 2

The attribute `Radius` can be animated:

```
plot(plot::Sphere(a, [0, 0, 0], a = 1..2)):
```

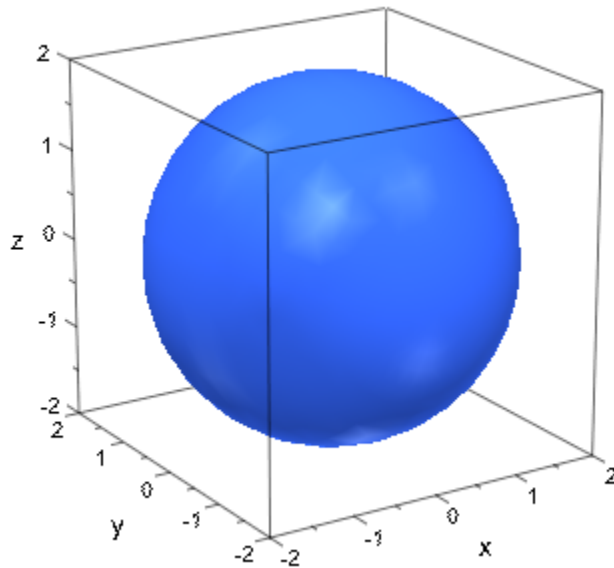

### Example 3

For a prism, the attribute `Radius` determines the radius of the circumcircle of its regular bases:

```
plot(plot::Prism(1,Edges=5), plot::Circle3d(1)):
```



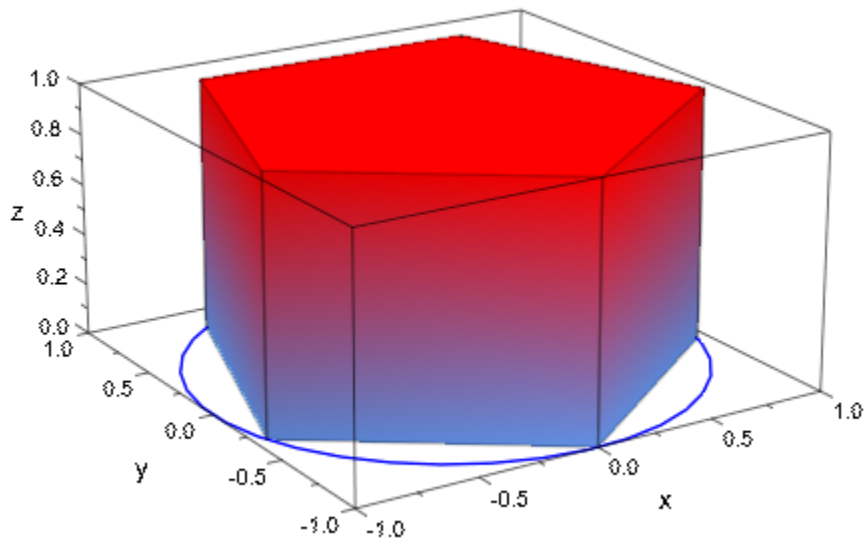

## See Also

### MuPAD Functions

[Base](#) | [Center](#) | [Normal](#) | [SemiAxes](#) | [Top](#)

## RadiusFunction

Radius of a tube plot

### Value Summary

Mandatory	Arithmetical expression (Symbolic Math Toolbox) or function
-----------	---

### Graphics Primitives

Objects	RadiusFunction Default Values
<code>plot::Tube</code>	1/10

### Description

`RadiusFunction` is the internal name of the radius function in `plot::Tube`.

With `RadiusFunction = r(t)`, `plot::Tube` will draw (part of) a circle of radius  $r(t)$  at the point  $(x(t), y(t), z(t))$  around the central curve.

Usually, a user will have no need to access `RadiusFunction` directly, since it is set by `plot::Tube` directly.

### Examples

#### Example 1

By default, `plot::Tube` uses a constant radius of  $\frac{1}{10}$ :

```
t := plot::Tube([sin(3*x), sin(2*x), sin(x)], x = 0..2*PI):  
plot(t)
```

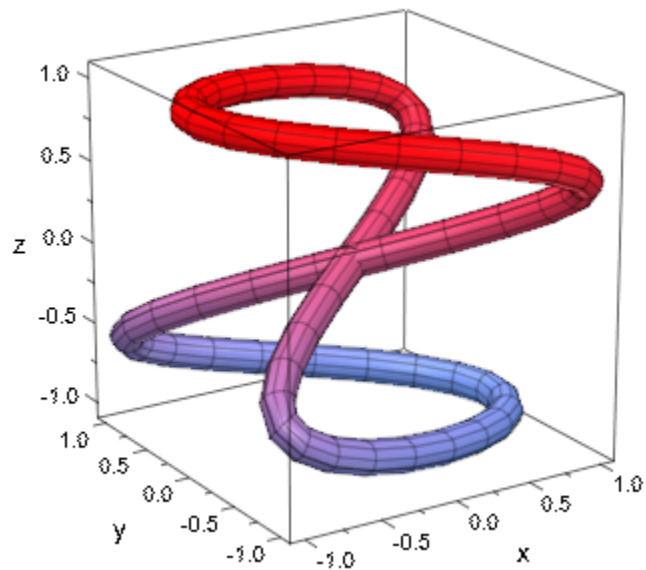

To change this default, either set some other radius when creating the tube plot (see the documentation of `plot::Tube` for this) or set `RadiusFunction`:

```
t::RadiusFunction := (1+sin(3*x))/2)/10:  
plot(t)
```

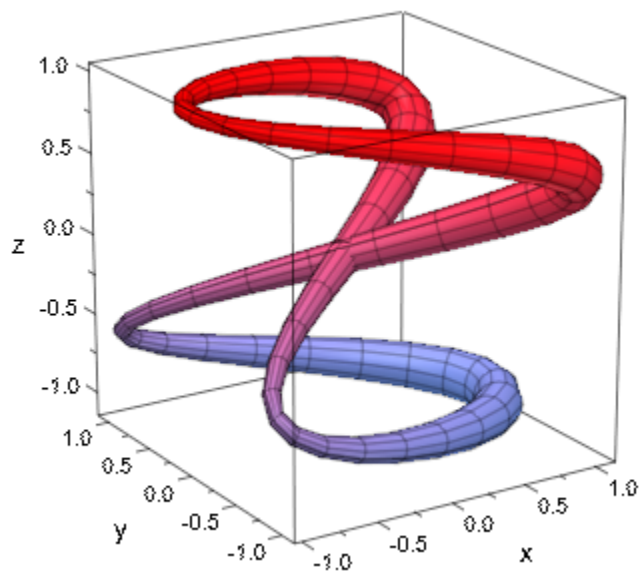

# RationalExpression

Rational expression in a rootlocus plot

## Value Summary

Mandatory	MuPAD expression
-----------	------------------

## Graphics Primitives

Objects	RationalExpression Default Values
plot::Rootlocus	

## Description

RationalExpression is the internal name of the expression whose roots are depicted by plot::Rootlocus.

A rootlocus plot depicts the roots of a rational function  $p(z, u)$  in the complex plane, depending on a parameter  $u$ . The expression  $p(z, u)$  is stored as the attribute RationalExpression in the rootlocus object.

Usually, a user will have no need to access the attribute RationalExpression, since it is set by plot::Rootlocus directly.

## Examples

### Example 1

We define a rootlocus plot:

```
r:= plot::Rootlocus(z^2 - 2*u*z + 0.81, u = -1..1):
plot(r)
```

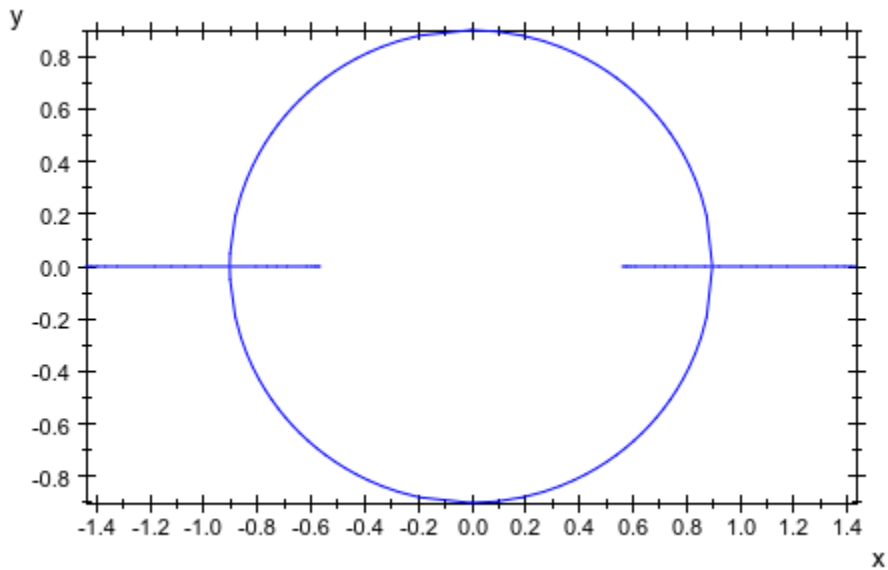

The function  $z^2 - 2uz + 0.81$  is stored as the attribute `r::RationalExpression` in the object `r`:

```
r::RationalExpression
```

$$z^2 - 2uz + 0.81$$

We can redefine this attribute:

```
r::RationalExpression:= z^3 - 2*u*z + 0.81:  
plot(r)
```

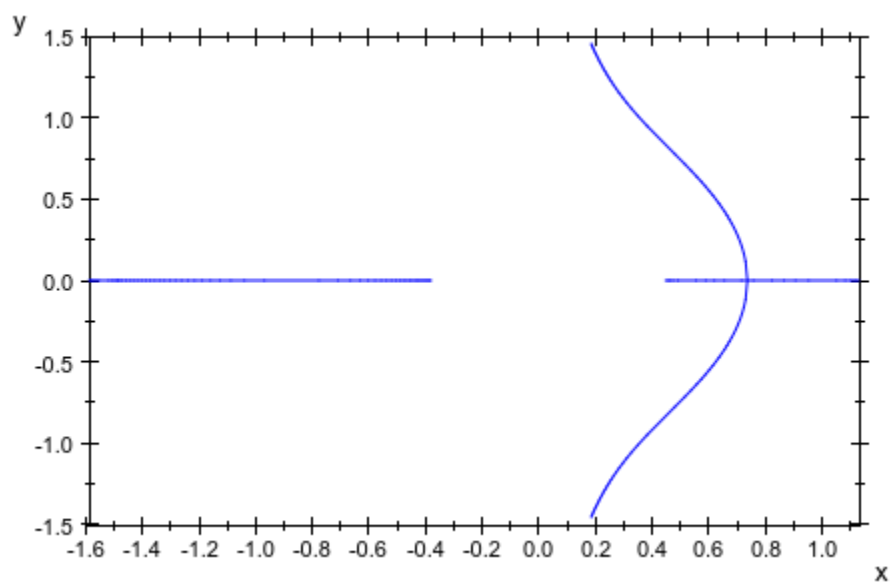

## ScaleScaleXScaleYScaleZ

Scaling factors

### Value Summary

Scale	Library wrapper for “[ScaleX, ScaleY]” (2D), “[ScaleX, ScaleY, ScaleZ]” (3D)	List of 2 or 3 expressions, depending on the dimension
ScaleX, ScaleY, ScaleZ	Optional	MuPAD expression

### Graphics Primitives

Objects	Default Values
plot::Scale2d	Scale: [1, 1] ScaleX, ScaleY: 1
plot::Scale3d	Scale: [1, 1, 1] ScaleX, ScaleY, ScaleZ: 1

### Description

Scale defines the scaling factors used by plot::Scale2d and plot::Scale3d.

ScaleX etc. correspond to the factors in the single coordinate directions.

The scaling objects plot::Scale2d and plot::Scale3d apply the scaling transformation  $x \rightarrow Ax$  with the matrix  $A = \text{diag}(s_x, s_y)$  in 2D and  $A = \text{diag}(s_x, s_y, s_z)$  in 3D, respectively.

Scale is the list  $[s_x, s_y]$  resp.  $[s_x, s_y, s_z]$  of the scaling factors. The attributes ScaleX etc. correspond to  $s_x$  etc.



These attributes can be animated.

## Examples

### Example 1

We start with a 2D circle:

```
c := plot::Circle2d(3, [3, 3]):
```

We apply a scaling transformation:

```
S := plot::Scale2d([2, 3], c):  
plot(c, S):
```

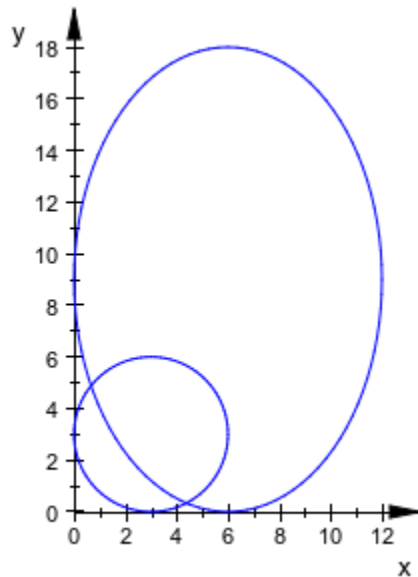

The scaling factors are stored as the Scale attribute in the scaling object S:

```
S::Scale, S::ScaleX, S::ScaleY
```

```
[2, 3], 2, 3
```

We change the scaling factors:

```
S::Scale := [-2, -3]:  
plot(c, S):
```

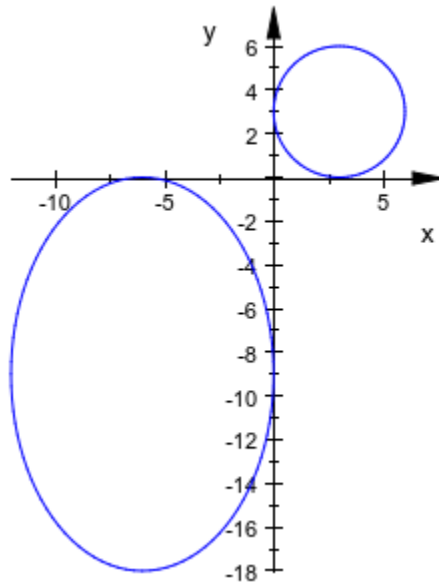

```
delete c, S:
```

## See Also

### MuPAD Functions

[Matrix2d](#) | [Matrix3d](#) | [Shift](#)

# SemiAxesSemiAxisXSemiAxisYSemiAxisZ

Semi axes of ellipses and ellipsoids

## Value Summary

SemiAxes	Library wrapper for "[SemiAxisX, SemiAxisY]" (2D), "[SemiAxisX, SemiAxisY, SemiAxisZ]" (3D)	List of two or three real-valued expressions
SemiAxisX, SemiAxisY, SemiAxisZ	Mandatory	MuPAD expression

## Graphics Primitives

Objects	Default Values
plot::Ellipsoid	SemiAxes: [1, 2, 3] SemiAxisX: 1 SemiAxisY: 2 SemiAxisZ: 3
plot::Ellipse2d	SemiAxes: [2, 1] SemiAxisX: 2 SemiAxisY: 1
plot::Ellipse3d	SemiAxisX: 2 SemiAxisY: 1

Objects	Default Values
<code>plot::Arc2d</code>	<code>SemiAxes: [1, 1]</code> <code>SemiAxisX, SemiAxisY: 1</code>
<code>plot::Arc3d</code>	<code>SemiAxisX, SemiAxisY: 1</code>

## Description

`SemiAxes` determines the lengths of the semi axes of ellipses in 2D and ellipsoids in 3D.

`SemiAxes = [rx, ry]` sets the lengths  $r_x, r_y$  of the semi axes of an ellipse in 2D.

`SemiAxes = [rx, ry, rz]` sets the lengths  $r_x, r_y, r_z$  of the semi axes of an ellipsoid in 3D.

`SemiAxisX = rx, SemiAxisY = ry, SemiAxisZ = rz` refer to the semi axis in the  $x, y,$  and  $z$  direction, respectively.

The values of these attributes can be animated.

## Examples

### Example 1

We create an ellipse around the origin with semi axes 1 and 2:

```
e := plot::Ellipse2d(1, 2, [0, 0]):
```

The first two arguments in `plot::Ellipse2d` are the semi axes. Internally, they are stored as the attributes `SemiAxisX` and `SemiAxisY` and can be changed by assigning new values:

```
e::SemiAxisX, e::SemiAxisY, e::SemiAxes  
  
1, 2, [1, 2]
```

```
e::SemiAxes := [3, 2]:  
plot(e):
```

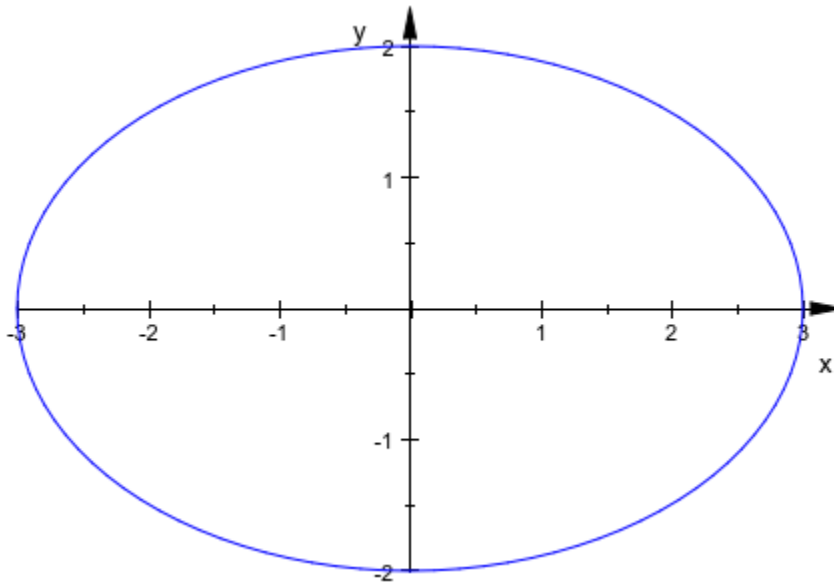

```
delete e:
```

## Example 2

SemiAxes can be animated:

```
plot(plot::Ellipse2d(a, 3 - a, [3, 3], a = 1..2)):
```

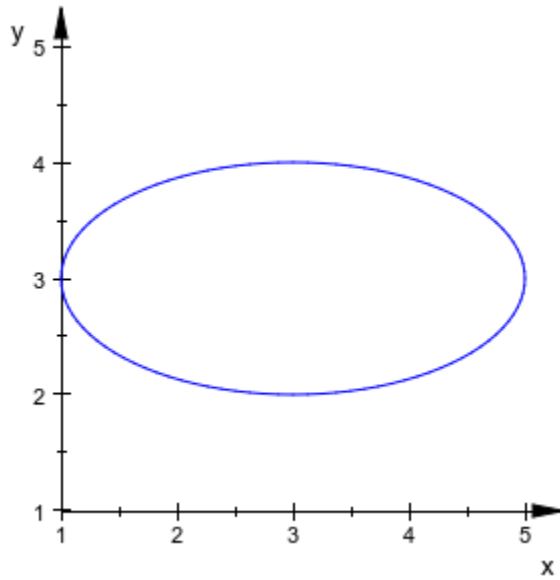

## See Also

**MuPAD Functions**  
Radius

# ShiftShiftXShiftYShiftZ

Shift vector

## Value Summary

Shift	Library wrapper for “[ShiftX, ShiftY]” (2D), “[ShiftX, ShiftY, ShiftZ]” (3D)	List of 2 or 3 expressions, depending on the dimension
ShiftX, ShiftY, ShiftZ	Optional	MuPAD expression

## Description

Shift is the shift vector in transformation objects. ShiftX etc. refer to the single components of this vector.

The general transformation objects `plot::Transform2d` and `plot::Transform3d` allow to apply the affine-linear transformation  $x \rightarrow Ax + b$  to 2D and 3D objects, respectively. The shift vector  $b$  can be accessed and changed via the attribute `Shift`.

Special transformation objects such as `plot::Translate2d`, `plot::Translate3d` correspond to special matrices  $A$  and shifts  $b$ . They also allow to access and change the shift vector by the attribute `Shift`.

When setting the `Shift` attribute, matrices, arrays, and lists with 2 or 3 elements are accepted. Internally, however, the shift data are always stored as the list  $[b_1, b_2]$  in 2D or  $[b_1, b_2, b_3]$  in 3D, respectively. When reading the vector by a slot access, this list is returned.

The entries of `Shift` can be animated.

## Examples

### Example 1

We move an arrow along the y-axis:

```
T := plot::Translate2d([0, a], a = 0..5,  
                      plot::Arrow2d([0, 0], [1, 1])):  
plot(T)
```

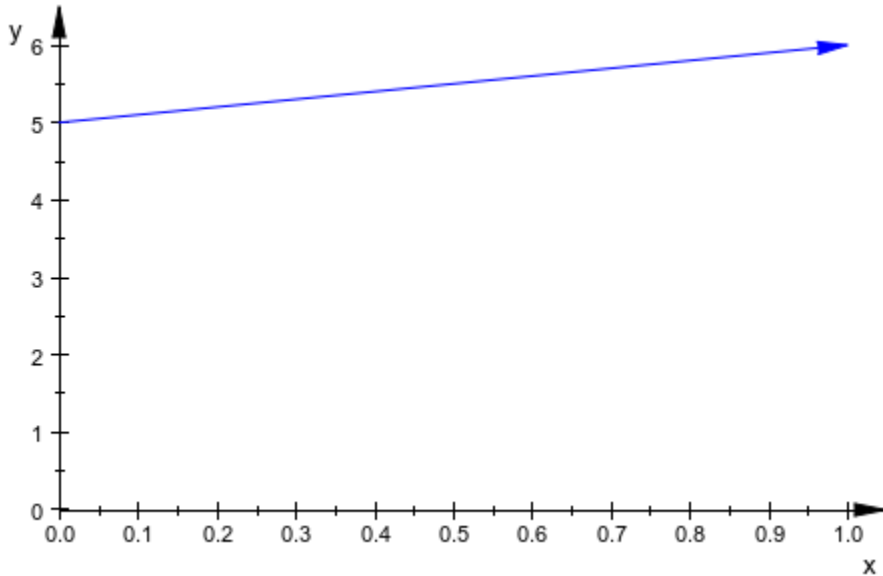

The Shift vector is the first argument in the call above. It is stored in the corresponding slot of the translation object T:

```
T::Shift
```

```
[0, a]
```

We change the shift vector:



```
T::Shift := [a, 0]:  
plot(T)
```

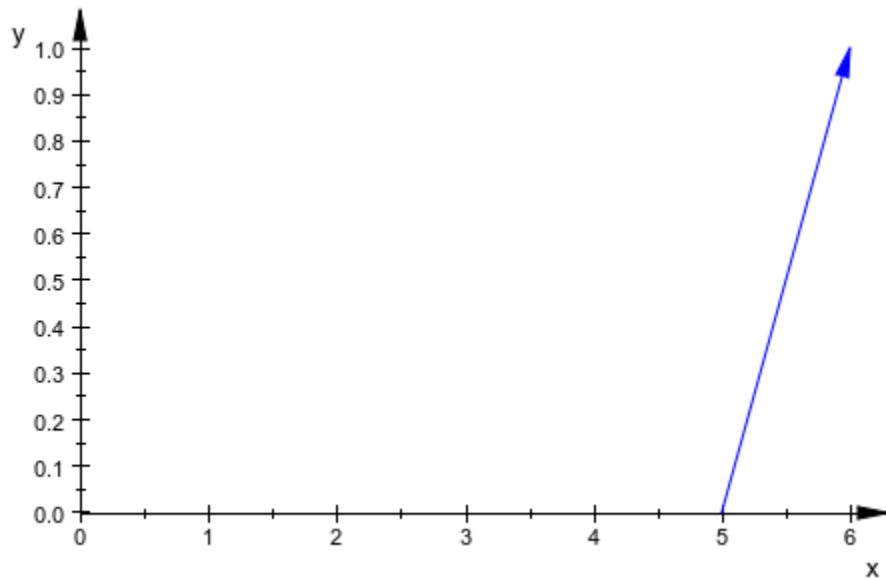

```
delete T:
```

## See Also

### MuPAD Functions

[Matrix2d](#) | [Matrix3d](#) | [Scale](#)

## Size

Size of a point list

## Value Summary

Optional	MuPAD expression
----------	------------------

## Graphics Primitives

Objects	Size Default Values
<code>plot::QQplot</code>	

## Description

Size represents the number of plot points in a `plot::QQplot`.

A `plot::QQplot` accepts two data lists, displaying a set of plot points with coordinate values given by quantile values of the data. By default, the number of plot points is chosen as the minimum of the sizes of the two data lists. In principle, however, the number of plot points can be chosen independently of the data sizes. With `Size = n`, the number of plot points of the QQ plot can be set to any positive integer value  $n$ .

The value of `Size` can be animated.

## Examples

### Example 1

We create a QQ plot:

```
data1 := [stats::normalRandom(0, 1)() $ k = 1..100]:  
data2 := [stats::normalRandom(0, 1)() $ k = 1..200]:
```

```
qq := plot::QQplot(data1, data2):  
plot(qq)
```

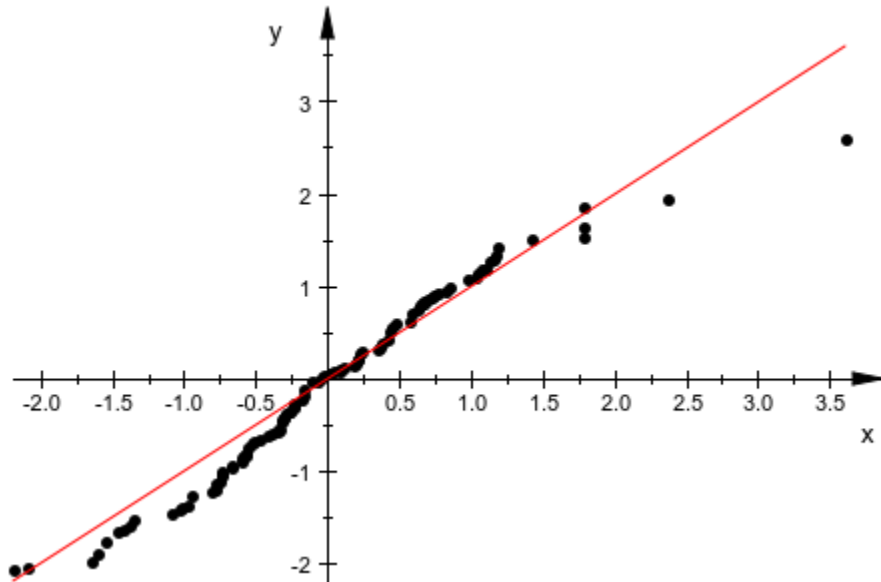

By default, the minimum of the data sizes is chosen as the number of plot points in the plot (i.e., `Size = 100` in this case). We reduce the number of plot points by setting the value of `Size` explicitly:

```
qq::Size := 30:  
plot(qq)
```

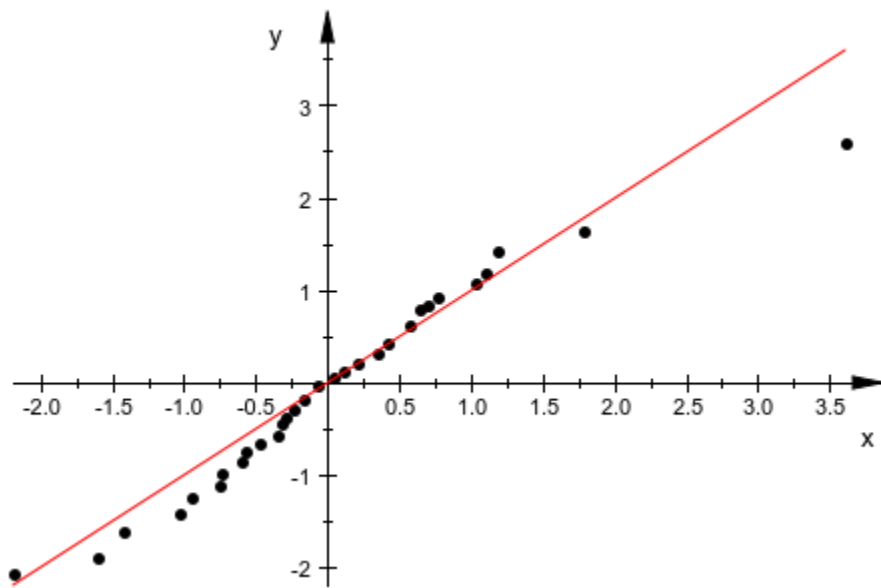

The number of plot points can also be specified directly by passing the attribute `Size = n`. In the following graphics, this value is animated:

```
plot(plot::QQplot(data1, data2, Size = n, n = 10..200));
```

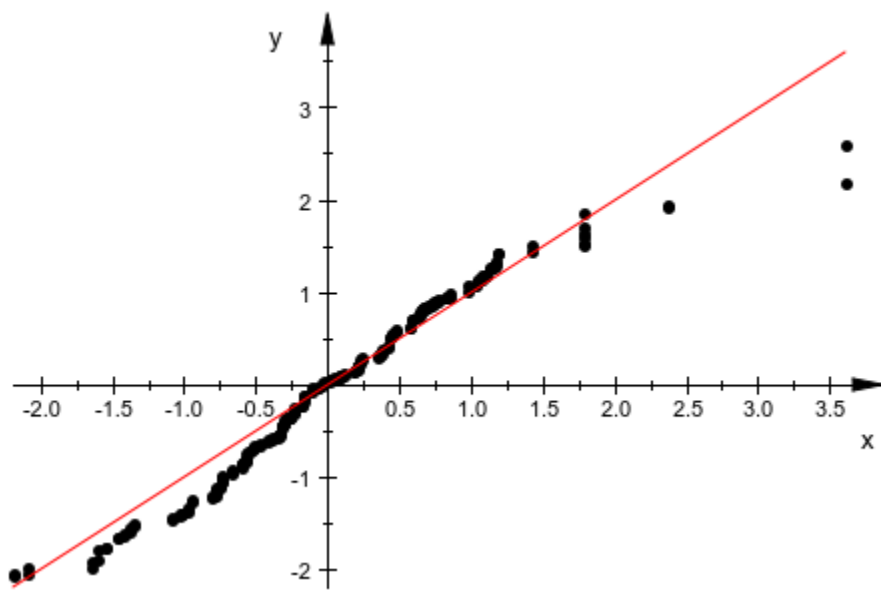

```
delete data1, data2, qq:
```

# Tangent1Tangent1XTangent1YTangent1ZTangent2Tangent2XTangent2YTangent2Z

First vector spanning parallelograms

## Value Summary

Tangent1	Library wrapper for “[Tangent1X, Tangent1Y]” (2D), “[Tangent1X, Tangent1Y, Tangent1Z]” (3D)	List of 2 or 3 expressions, depending on the dimension
Tangent1X, Tangent1Y, Tangent1Z, Tangent2X, Tangent2Y, Tangent2Z	Mandatory	MuPAD expression
Tangent2	Library wrapper for “[Tangent2X, Tangent2Y]” (2D), “[Tangent2X, Tangent2Y, Tangent2Z]” (3D)	List of 2 or 3 expressions, depending on the dimension

## Graphics Primitives

Objects	Default Values
plot::Parallelogram3d	Tangent1: [0, 1, 0]  Tangent1X, Tangent1Z, Tangent2Y, Tangent2Z: 0  Tangent1Y, Tangent2X: 1  Tangent2: [1, 0, 0]

Objects	Default Values
<code>plot::Parallelogram2d</code>	Tangent1: [0, 1] Tangent1X, Tangent2Y: 0 Tangent1Y, Tangent2X: 1 Tangent2: [1, 0]

## Description

Tangent1 and Tangent2 determine the vectors spanning the parallelograms created by `plot::Parallelogram2d` and `plot::Parallelogram3d`.

Parallelograms created by `plot::Parallelogram2d` and `plot::Parallelogram3d` are specified by a vector defining the Center and two vectors Tangent1 and Tangent2 which span the plane of the parallelogram. The lengths of the “tangent” vectors are half the side lengths of the parallelogram:

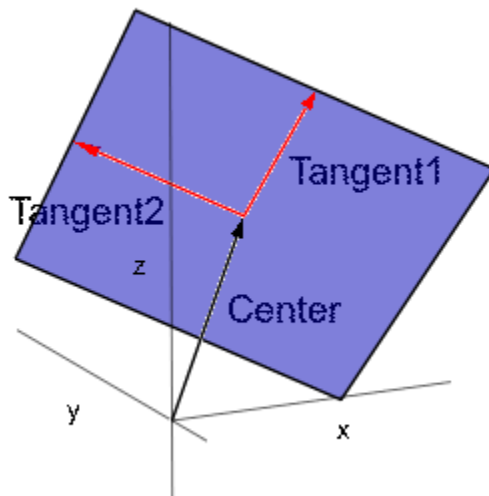

Depending on the dimension, the vectors `Tangent1`, `Tangent2` are given by lists or vectors of two or three components.

The attributes `Tangent1X` etc. represent the  $x$ ,  $y$ ,  $z$  coordinates of these vectors.

The values of these attributes can be animated.

## Examples

### Example 1

The “tangent vectors” of a parallelogram are accessible via the slots `Tangent1` and `Tangent2`:

```
p := plot::Parallelogram3d([1, 1, 1], [0, 1, 0], [0, 0, 1],
                          Color = RGB::Blue):
p::Tangent1, p::Tangent2
```

```
[0, 1, 0], [0, 0, 1]
```

```
plot(p,
      plot::Arrow3d([1, 1, 1], [1, 2, 1], Color = RGB::Red),
      plot::Arrow3d([1, 1, 1], [1, 1, 2], Color = RGB::Red),
      Axes = Origin, Scaling = Constrained):
```



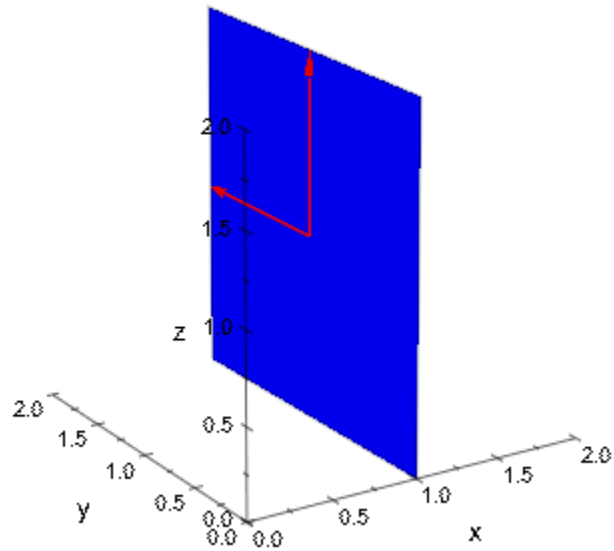

We change the “tangent vectors”:

```
p::Tangent1 := [1, 0, 0]: p::Tangent2 := [1, 1, 0]:  
plot(p,  
  plot::Arrow3d([1, 1, 1], [2, 1, 1], Color = RGB::Red),  
  plot::Arrow3d([1, 1, 1], [2, 2, 1], Color = RGB::Red),  
  Axes = Origin, Scaling = Constrained):
```

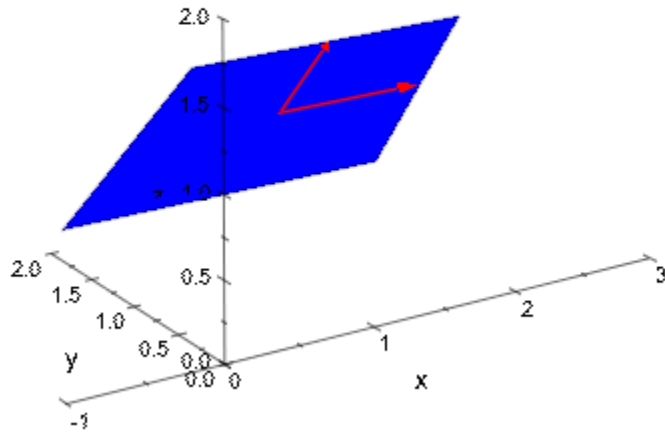

delete p:

## See Also

**MuPAD Functions**  
Center

## Text

Text of a text object

## Value Summary

Mandatory	String on page 7-53 or function
-----------	---------------------------------

## Graphics Primitives

Objects	Text Default Values
<code>plot::Text2d</code> , <code>plot::Text3d</code>	

## Description

The attribute `Text` represents the text of a text object. It may be a text string or a function generating a text string at runtime.

The `Text` attribute represents the text in text objects of type `plot::Text2d` and `plot::Text3d`. When creating a text object such as

```
t := plot::Text2d("hello world", [0, 0]),
```

the text is the first argument. Internally, it is stored as the attribute `Text = "hello world"` and can be accessed and changed via a slot call `t::Text`.

In most cases, the text is given as a string.

---

**Note** Note that this string has to be quoted when changing it in the “property inspector” of the interactive graphics tool (see section Viewer, Browser, and Inspector: Interactive Manipulation (Symbolic Math Toolbox) of this document). If the string contains white space and the quotes are removed, the recalculation following the change will produce a syntax error!

---

A text given by a fixed string cannot be animated. Use a procedure to create animated texts.

The attribute `Text` can be a procedure that is called at runtime with the animation parameter as the only input parameter. The return value is used as the text of the text object in the corresponding frame of the animation. If the result is not a string, `expr2text` is applied to the return value.

## Examples

### Example 1

Usually, a text is given by a string:

```
t := plot::Text2d("hello world", [1, 1], TextFont = [24]):  
plot(t)
```

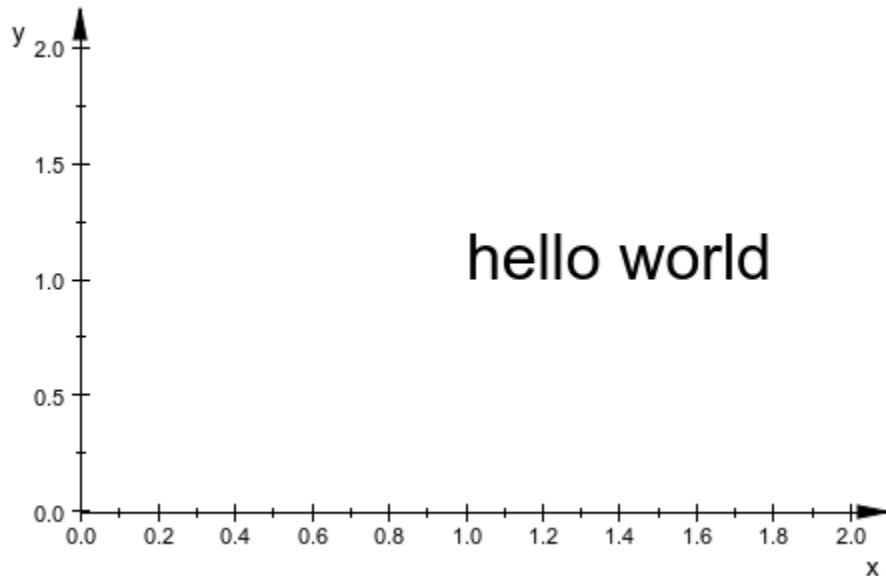

We access and change the text:

```
t::Text
```

"hello world"

```
t::Text := "HELLO WORLD":  
plot(t)
```

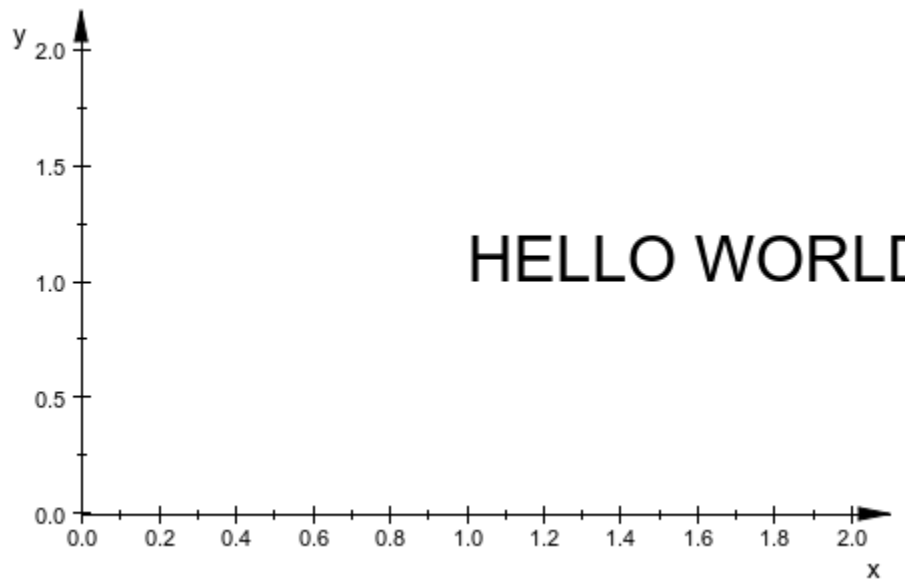

The same message in 3D:

```
plot(plot::Text3d("HELLO WORLD", [1, 1, 1],  
                  TextFont = [24]))
```

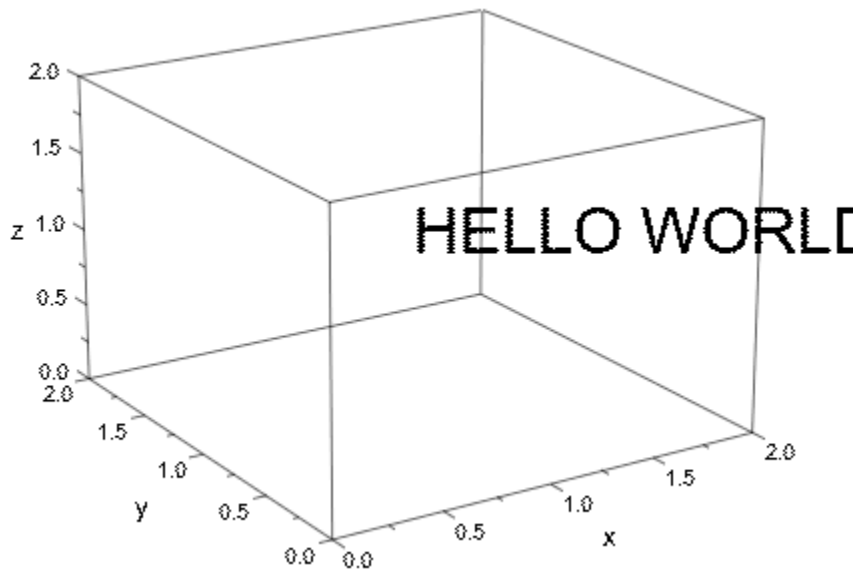

`delete t:`

## Example 2

The text of a text object can be animated if the text string is provided by a procedure. We use `stringlib::formatf` to format the animation parameter that is passed to the procedure as a floating-point number for each frame of the animation:

```
plot(plot::Rectangle(-1..1, -1..1),
      plot::Text2d(a -> stringlib::formatf(a, 2, 5)." sec",
              [0, 0], a = 0..20,
              TextFont = [60],
              HorizontalAlignment = Center,
              VerticalAlignment = Center),
      Axes = Frame, Frames = 201, TimeRange = 0..20)
```

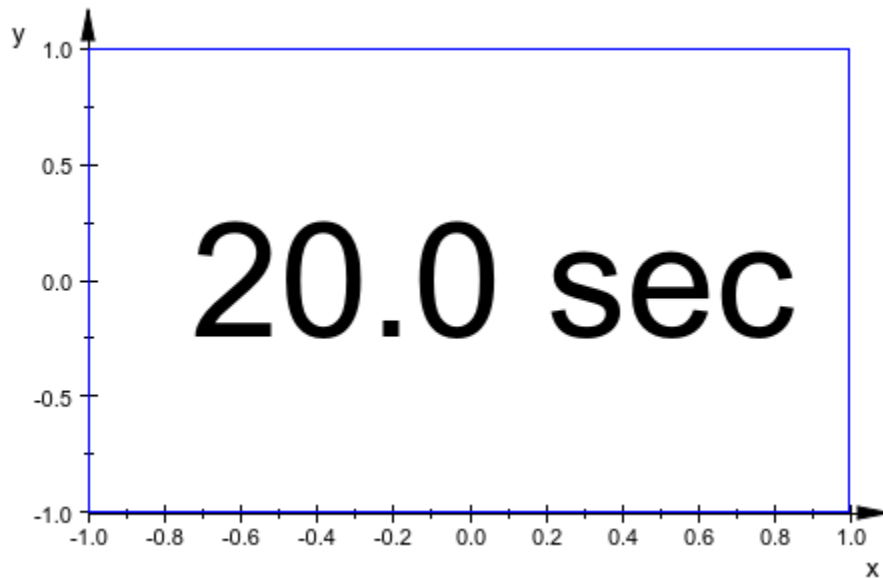

Here is the corresponding example in 3D:

```
plot(plot::Text3d(a -> stringlib::formatf(a, 2, 5)." sec",  
              [0, 0, 0], a = 0..20,  
              TextFont = [60],  
              HorizontalAlignment = Center,  
              VerticalAlignment = Center),  
      Axes = Frame, Frames = 201, TimeRange = 0..20)
```

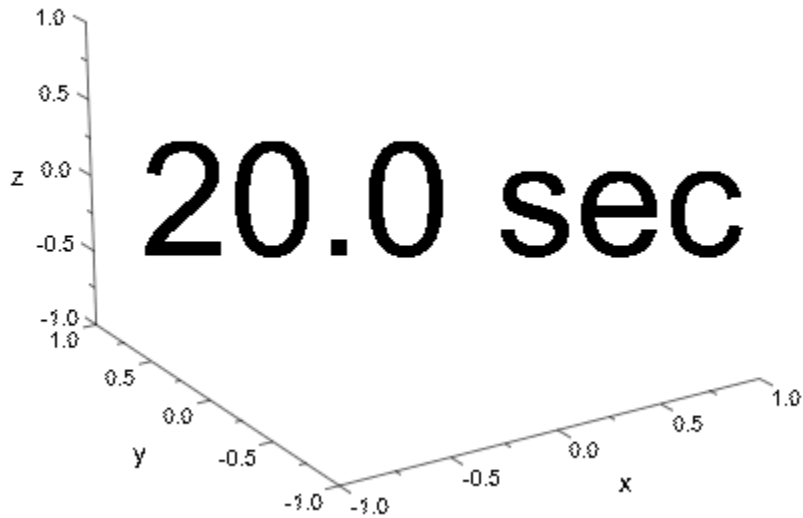

## See Also

### MuPAD Functions

[Billboarding](#) | [HorizontalAlignment](#) | [TextFont](#) | [VerticalAlignment](#) | [stringlib::formatf](#)



# TextOrientation

Orientation of a 3D text

## Value Summary

Optional	List of six real-valued expressions
----------	-------------------------------------

## Graphics Primitives

Objects	TextOrientation Default Values
<code>plot::Text3d</code>	<code>[1, 0, 0, 0, 0, 1]</code>

## Description

`TextOrientation` defines the orientation of a text object of type `plot::Text3d`. Its orientation in 3 space is given by 2 directions. There is the “writing direction” from the first character of the text to the last. The direction from the bottom of the characters to their top shall be referred to as the “up direction”.

Together with the anchor point of the text (the attribute `Position` of a `plot::Text3d` object), these two directions define a 2 dimensional plane in 3D. You may regard this plane as the sheet onto which the text is written.

The value of `TextOrientation` has to be a list of 6 numerical values or expressions of the animation parameter. The first 3 components of this list define the “writing direction”, the last 3 components the “up direction”.

The length of these two vectors is irrelevant, only their directions matter. The lengths should not be zero, though.

Further, the “up direction” should be orthogonal to the “writing direction”. If this is not the case, the “up direction” is automatically replaced by the vector orthogonal to the “writing direction” that lies in the plane given by the original directions.

“Writing direction” and “up direction” should not be parallel.

---

**Note** `TextOrientation` only has an effect in conjunction with the attribute `Billboarding = FALSE`.

---

`TextOrientation` can be animated.

The effect of `TextOrientation` is independent of the `HorizontalAlignment` and `VerticalAlignment` of the text relative to its anchor point (`Position`).

While `TextOrientation` is used for orienting 3D texts, `TextRotation` is used for rotating a 2D text of type `plot::Text2d`.

## Examples

### Example 1

The “writing direction” of the text object `text1` is rotated around an axis parallel to the  $z$ -axis. The “up direction” of its characters is the  $z$  direction.

The “writing direction” of the text object `text2` is parallel to the  $x$  axis. The animated “up direction” is rotated around an axis pointing into the  $x$  direction:

```
p1 := plot::Point3d([1, 2, 3], PointSize = 3*unit::mm):
text1 := plot::Text3d("Hello world!", [1, 2, 3],
    TextOrientation = [cos(a), sin(a), 0, 0, 0, 1],
    a = 0..2*PI, TextFont = [24],
    Billboarding = FALSE):
p2 := plot::Point3d([3, 6, 9], PointSize = 3*unit::mm):
text2 := plot::Text3d("MuPAD", [3, 6, 9],
    TextOrientation = [1, 0, 0, 0, sin(a), cos(a)],
    a = 0..2*PI, TextFont = [24],
    Billboarding = FALSE):
plot(p1, text1, p2, text2)
```

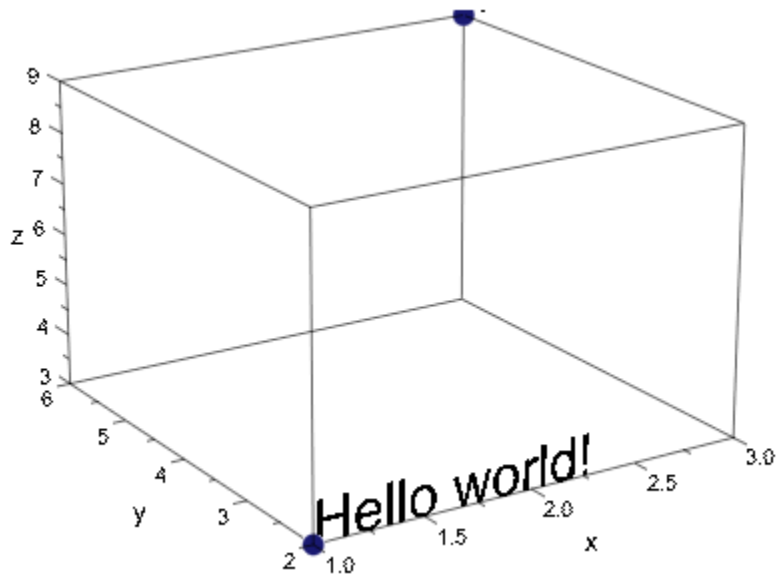

When Billboarding is set to TRUE, TextOrientation does not have any effect:

```
text1::Billboarding := TRUE:  
text2::Billboarding := TRUE:  
plot(p1, text1, p2, text2)
```

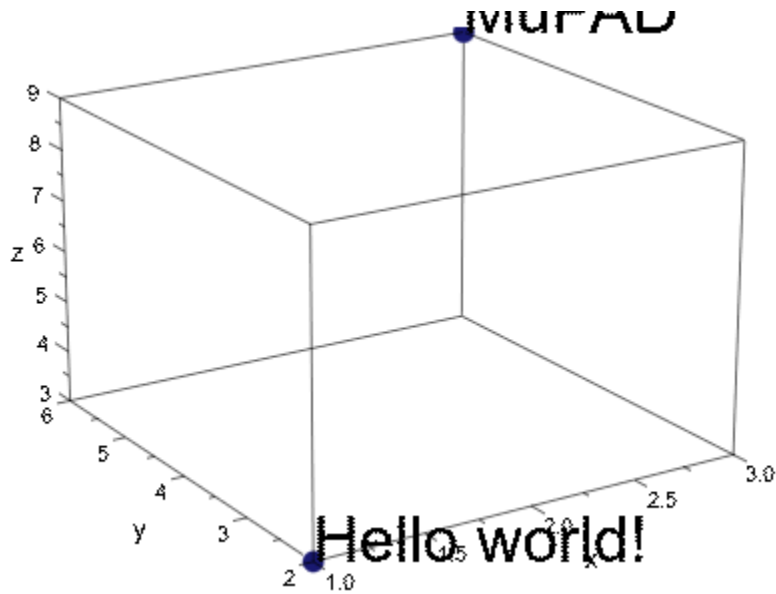

```
delete p1, text1, p2, text2:
```

## See Also

**MuPAD Functions**  
TextRotation

# TextRotation

Rotation of a 2D text

## Value Summary

Optional	Real-valued expression (interpreted in radians)
----------	---

## Graphics Primitives

Objects	TextRotation Default Values
<code>plot::Integral</code> , <code>plot::Text2d</code>	0

## Description

`TextRotation` sets the rotation angle of a 2D text object relative to the horizontal axis.

`TextRotation` rotates a text object of type `plot::Text2d` around its anchor point (the attribute `Position` of a `plot::Text2d` object). Note that a `plot::Text2d` allows different alignments (`HorizontalAlignment`, `VerticalAlignment`) relative to this point.

The rotation angle in `TextRotation = angle` has to be entered in radians. If positive, the rotation is counterclockwise.

The rotation of the text refers to 'rotation on the screen'. It is invariant w.r.t. rescaling of the canvas, aspect ratio etc.

While `TextRotation` is used for rotating 2D texts, `TextOrientation` is used for rotating a 3D text of type `plot::Text3d`.

`TextRotation` can be animated.

## Examples

### Example 1

We draw a rectangle and a rotating text inside:

```
r := plot::Rectangle(0..4, 0..4):  
p := plot::Point2d([2, 2], PointSize = 3*unit::mm):  
text := plot::Text2d("Hello world!", [2, 2],  
    HorizontalAlignment = Center,  
    TextRotation = a, a = 0..2*PI,  
    TextFont = [24]):  
plot(r, p, text):
```

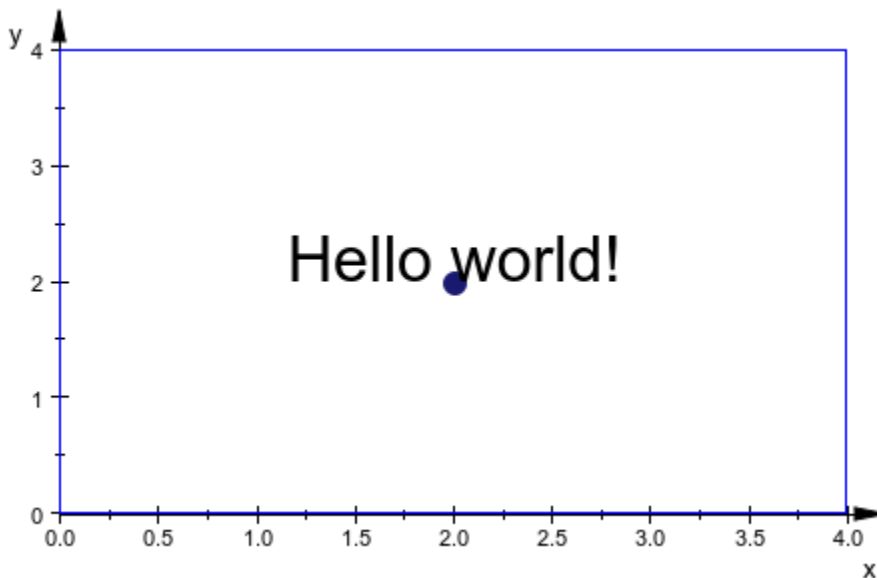

We change the alignment of the text w.r.t. its anchor point [2, 2]:

```
text:: HorizontalAlignment := Left:  
text:: VerticalAlignment := Top:  
plot(r, p, text):
```

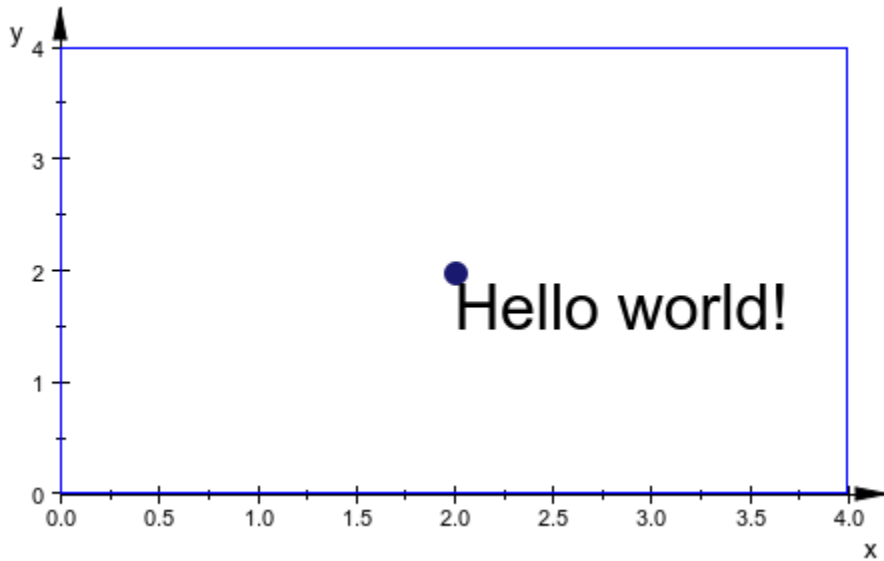

```
text:: HorizontalAlignment := Center:  
text:: VerticalAlignment := Center:  
plot(r, p, text):
```

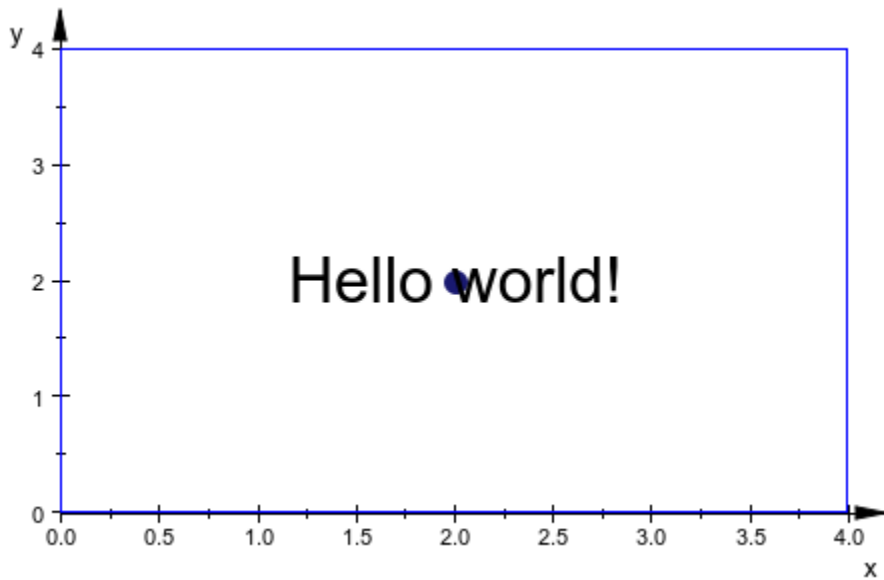

delete r, p, text:

## See Also

**MuPAD Functions**  
TextOrientation



# UName URange UMin UMax VName VRange VMin VMax XName XRange XMin XMax YName YRange YMin YMax ZName ZRange ZMin ZMax

Names and values ranges of parameters

## Value Summary

UMax, UMin, UName, VMax, VMin, VName, XMax, XMin, XName, YMax, YMin, YName, ZMax, ZMin, ZName	Mandatory	MuPAD expression
URange	[UMin .. UMax]	Range on page 1-16 of arithmetical expressions
VRange	[VMin .. VMax]	Range on page 1-16 of arithmetical expressions
XRange	[XMin .. XMax]	Range on page 1-16 of arithmetical expressions
YRange	[YMin .. YMax]	Range on page 1-16 of arithmetical expressions
ZRange	[ZMin .. ZMax]	Range on page 1-16 of arithmetical expressions

## Graphics Primitives

Objects	Default Values
plot::Curve2d, plot::Curve3d, plot::Function2d, plot::XRotate	URange, XRange: -5 .. 5 UMin, XMin: -5 UMax, XMax: 5

Objects	Default Values
<p>plot::Bars3d, plot::ClippingBox,  plot::Conformal, plot::Cylindrical,  plot::Density, plot::Implicit2d,  plot::Implicit3d, plot::Inequality,  plot::Iteration, plot::Listplot,  plot::Matrixplot, plot::Polar,  plot::Raster, plot::Rootlocus,  plot::Sequence,  plot::SparseMatrixplot,  plot::Spherical,  plot::Streamlines2d, plot::Sum,  plot::Surface, plot::Sweep,  plot::Tube, plot::VectorField2d,  plot::VectorField3d</p>	
<p>plot::ZRotate</p>	<p>XRange: 0 .. 5  XMin: 0  XMax: 5</p>
<p>plot::Function3d</p>	<p>XRange, YRange: -5 .. 5  XMin, YMin: -5  XMax, YMax: 5</p>
<p>plot::Box</p>	<p>XRange, YRange, ZRange: -1 .. 1  XMin, YMin, ZMin: -1  XMax, YMax, ZMax: 1</p>
<p>plot::Rectangle</p>	<p>XRange, YRange: -1 .. 1  XMin, YMin: -1  XMax, YMax: 1</p>

Objects	Default Values
<code>plot::Hatch</code>	<code>XRange: -infinity .. infinity</code> <code>XMin: -infinity</code> <code>XMax: infinity</code>

## Description

`UName`, `VName`, `XName`, `YName`, `ZName` specify the names of parameters defining parametrized objects such as functions, curves and surfaces.

`UMin`, `UMax`, `VMin`, `VMax`, `XMin`, `XMax`, `YMin`, `YMax`, `ZMin`, `ZMax` specify the minimal and maximal values of the range of the parameters.

`URange`, `VRange`, `XRange`, `YRange`, `ZRange` serve as shortcuts for setting `UMin`, `UMax` etc.

In most cases, the user has no need for using these attributes explicitly, because parameter ranges are set implicitly during creation of plot objects. For example, the definition

```
f := plot::Function2d(sin(x), x = 0 .. 2*PI)
```

sets the attribute values `XName = x`, `XMin = 0`, `XMax = 2*PI` automatically for the function object `f`. In fact, you can define `f` by the equivalent call

```
f := plot::Function2d(sin(x), XName = x, XMin = 0, XMax = 2*PI).
```

In the interactive object browser of the MuPAD graphics tool (see section [Viewer, Browser, and Inspector: Interactive Manipulation \(Symbolic Math Toolbox\)](#) of this document), you will not see a specification such as `x = 0 .. 2*PI`, but you find separate entries for `XName`, `XMin`, `XMax`.

The use of 'X', 'Y', 'Z' as opposed to 'U', 'V' depends on the type of the object.

Functions of type `plot::Function2d` refer to the independent variable ("the parameter") as `XName`.

Functions of type `plot::Function3d` refer to the two independent variables as `XName`, `YName`.

Parametrized curve of type `plot::Curve2d` or `plot::Curve3d` refer to the curve parameter as `UName`.

Parametrized surfaces of type `plot::Surface`, `plot::XRotate` etc. refer to the two surface parameters as `UName`, `VName`.

Various other plot objects of type `plot::Implicit2d`, `plot::VectorField2d` etc. also use the attributes `XName` etc. Here, the ranges from `XMin` to `XMax` etc. denote the coordinate range in which the objects are placed.

After a definition such as `f := plot::Function2d(sin(x), x = 0 .. 2*PI)`, the parameter and its range can be accessed as the slots `f::XName`, `f::XMin`, `f::XMax`.

The slot `f::XRange` yields the range `0 .. 2*PI` consisting of the values of `XMin` and `XMax`. Setting the attribute `XRange` is a short cut for setting `XMin` and `XMax` simultaneously. For example, setting `f::XRange := -PI .. PI` is equivalent to setting `f::XMin := -PI` and `f::XMax := PI`.

Of course, the analogous statements hold for `YRange`, `ZRange`, `URange`, `VRange`, too.

## Examples

### Example 1

We define a function object:

```
f1 := plot::Function2d(sin(x), x = 0.. 2*PI)
```

```
plot::Function2d(sin(x), x = 0.. 2 π)
```

This is equivalent to:

```
f2 := plot::Function2d(sin(x), XName = x, XMin = 0, XMax = 2*PI)
```

```
plot::Function2d(sin(x), x = 0.. 2 π)
```

The objects `f1` and `f2` have the same entries for the parameter `x`:

```
f1::XName = f1::XMin .. f1::XMax, f2::XName = f2::XRange
```

$$x = 0..2 \pi, x = 0..2 \pi$$

Changing the x range via XRange is equivalent to changing XMin and XMax separately:

```
f1::XRange := -PI..PI:
f2::XMin := -PI:
f2::XMax := PI:
f1, f2
```

```
plot::Function2d(sin(x), x = -π..π), plot::Function2d(sin(x), x = -π..π)
```

```
delete f1, f2:
```

## See Also

### MuPAD Functions

AngleBegin | AngleEnd | AngleRange | ParameterBegin | ParameterEnd |  
 ParameterName | ParameterRange | TimeBegin | TimeEnd | TimeRange

# ViewingBoxViewingBoxXMinViewingBoxXMax ViewingBoxXRangeViewingBoxYMinViewingB oxYMaxViewingBoxYRangeViewingBoxZMinVi ewingBoxZMaxViewingBoxZRange

Visible coordinate range

## Value Summary

ViewingBox	Library wrapper for “[ViewingBoxXMin .. ViewingBoxXMax, ViewingBoxYMin .. ViewingBoxYMax]” (2D), “[ViewingBoxXMin .. ViewingBoxXMax, ViewingBoxYMin .. ViewingBoxYMax, ViewingBoxZMin .. ViewingBoxZMax]” (3D)	See below
ViewingBoxXMax, ViewingBoxXMin, ViewingBoxYMax, ViewingBoxYMin, ViewingBoxZMax, ViewingBoxZMin	Optional	MuPAD expression
ViewingBoxXRange	[ViewingBoxXMin .. ViewingBoxXMax]	See below
ViewingBoxYRange	[ViewingBoxYMin .. ViewingBoxYMax]	See below
ViewingBoxZRange	[ViewingBoxZMin .. ViewingBoxZMax]	See below

## Graphics Primitives

Objects	Default Values
plot::CoordinateSystem2d	ViewingBox: [Automatic .. Automatic, Automatic .. Automatic]  ViewingBoxXMin, ViewingBoxXMax, ViewingBoxYMin, ViewingBoxYMax: Automatic  ViewingBoxXRange, ViewingBoxYRange: Automatic .. Automatic
plot::CoordinateSystem3d	ViewingBox: [Automatic .. Automatic, Automatic .. Automatic, Automatic .. Automatic]  ViewingBoxXMin, ViewingBoxXMax, ViewingBoxYMin, ViewingBoxYMax, ViewingBoxZMin, ViewingBoxZMax: Automatic  ViewingBoxXRange, ViewingBoxYRange, ViewingBoxZRange: Automatic .. Automatic

## Description

The ViewingBox attributes set the coordinate range that is visible in a plot.

ViewingBoxXMin =  $x_{\min}$ , ViewingBoxXMax =  $x_{\max}$ , equivalent to ViewingBoxXRange =  $x_{\min} \dots x_{\max}$ , restricts the visibility to  $x$  values between  $x_{\min}$  and  $x_{\max}$ . ViewingBoxYMin etc. work analogously.

Setting ViewingBox = [ $x_{\min} \dots x_{\max}$ ,  $y_{\min} \dots y_{\max}$ ] in 2D and ViewingBox = [ $x_{\min} \dots x_{\max}$ ,  $y_{\min} \dots y_{\max}$ ,  $z_{\min} \dots z_{\max}$ ] in 3D

respectively, serves as a short cut for setting the single entries ViewingBoxXMin etc.

The `ViewingBox` of a plot is computed automatically by default. It is chosen as the smallest box containing all graphical objects in the coordinate system.

The values  $x_{\min}$  etc. of the `ViewingBox` attributes must be real numerical expressions or the special flag `Automatic`. With `Automatic`, the system chooses appropriate values automatically.

When plotting a function or a curve with singularities, a heuristics is used to set a “reasonable” restricted viewing box for the plot. This heuristics sometimes fails to produce a pleasing picture. We recommended to request an explicit `ViewingBox` in such a case.

When using `plot::Rotate2d` or `plot::Rotate3d`, the `ViewingBox` may be larger than necessary. Its size is computed by rotating the common viewing box of all objects in the rotation object. See “Example 4” on page 24-1432 (Symbolic Math Toolbox).

The `ViewingBox` of an animation is automatically chosen as the union of all viewing boxes of the frames of the animation.

The `ViewingBox` itself cannot be animated. However, the object `plot::ClippingBox` may be used to implement animated visibility regions.

## Examples

### Example 1

In the following plot, the horizontal axis is placed at the minimal y-value produced by the function:

```
f := plot::Function2d(exp(-x^2), x = -1.7 .. 1.7):  
plot(f)
```



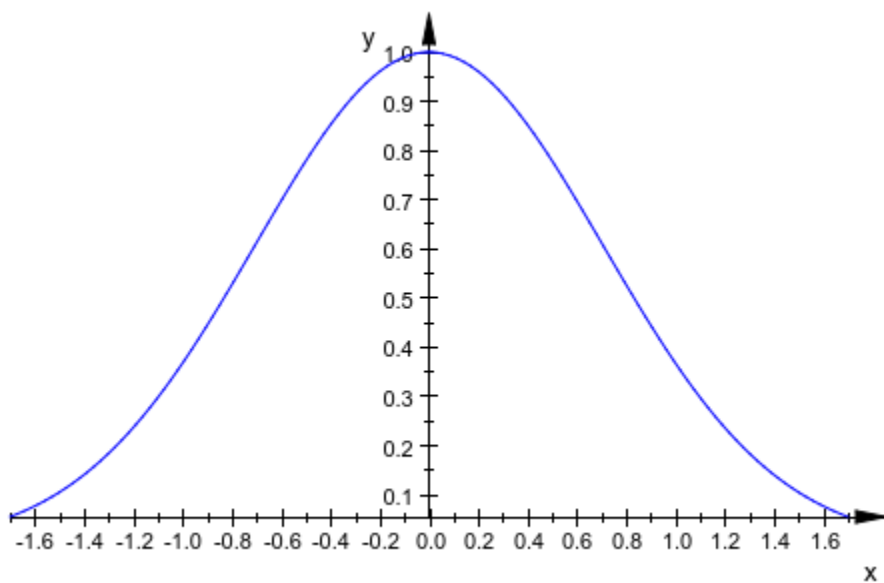

We wish to make the  $x$ -axis appear at  $y = 0$ . To this end, we request the  $y$  range to start with  $y = 0$  and use `Automatic` to let MuPAD find the maximal  $y$ -value automatically:

```
plot(f, ViewingBoxYRange = 0..Automatic)
```

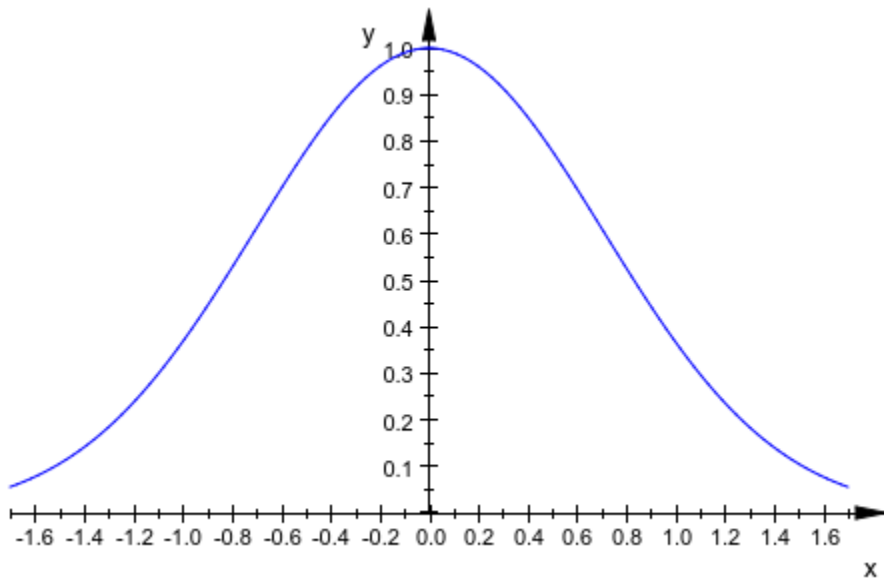

The previous command is equivalent to:

```
plot(f, ViewingBoxYMin = 0)
```

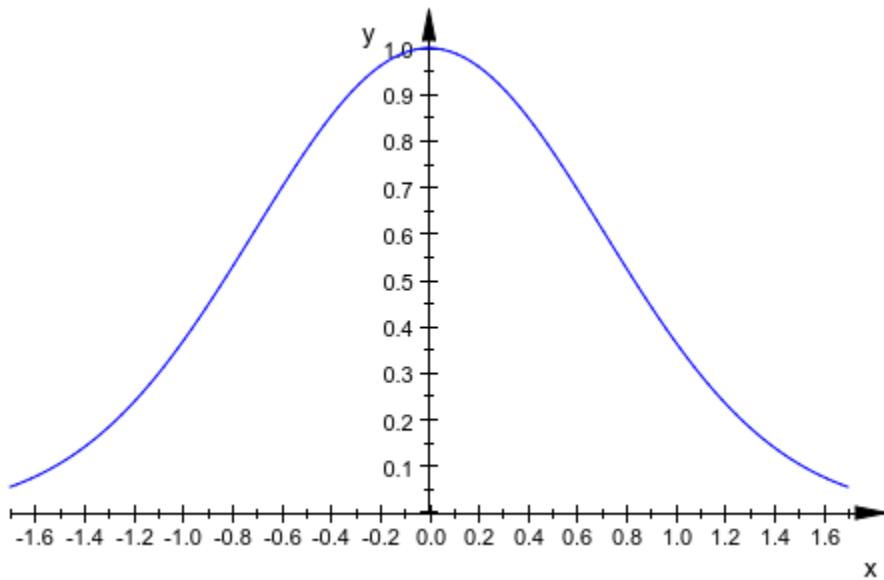

delete f:

## Example 2

Here is a 3D plot of a singular function:

```
f := plot::Function3d((sin(x) + cos(y))/(x^2 + y^2),  
                      x = -PI..PI, y = -PI..PI):  
plot(f)
```

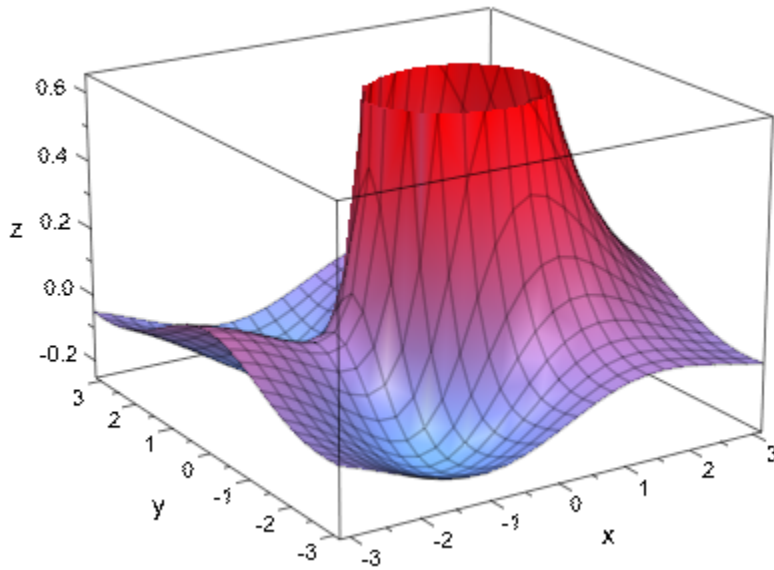

We specify the upper  $z$  value of the visible volume:

```
plot(f, ViewingBoxZRange = Automatic..3)
```

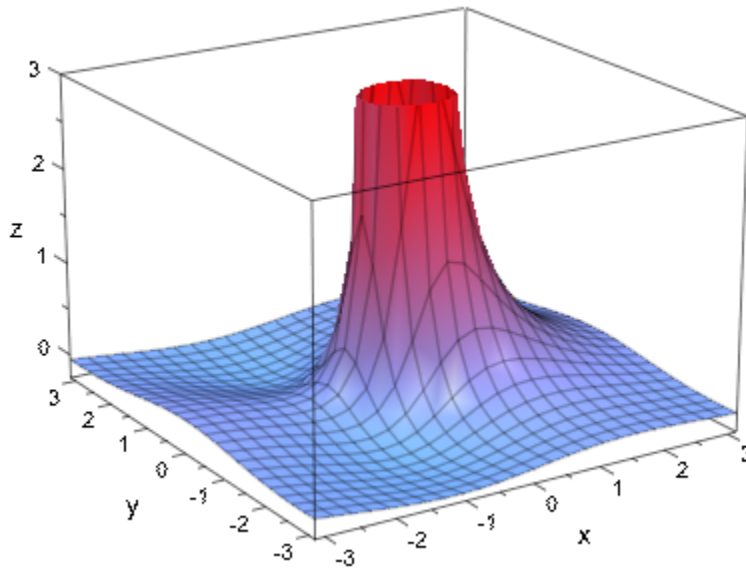

delete f:

### Example 3

Usually, a plot uses the whole drawing area:

```
f := plot::Function2d(ln(x), x = 0..2):  
plot(f)
```

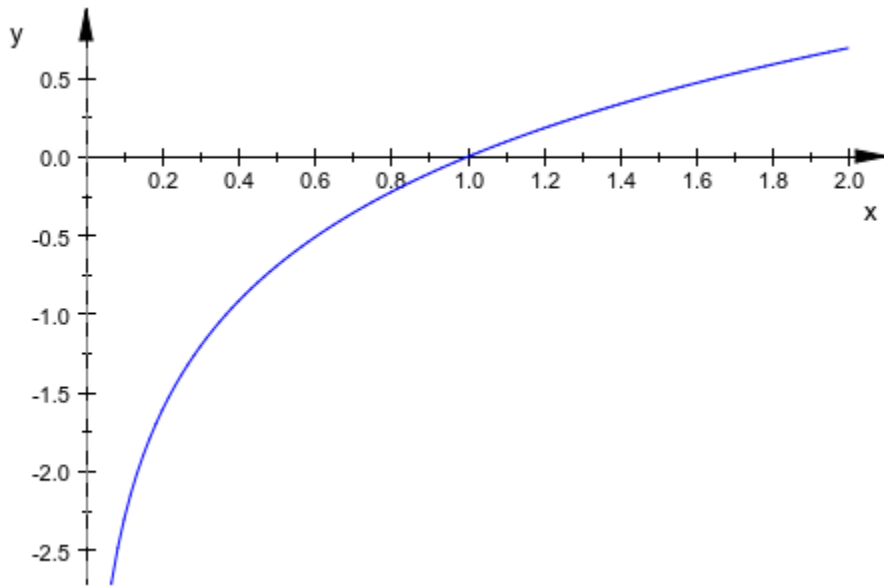

We extend the viewing box in x direction to make it symmetric w.r.t. x:

```
plot(f, ViewingBoxXRange = -2..2)
```

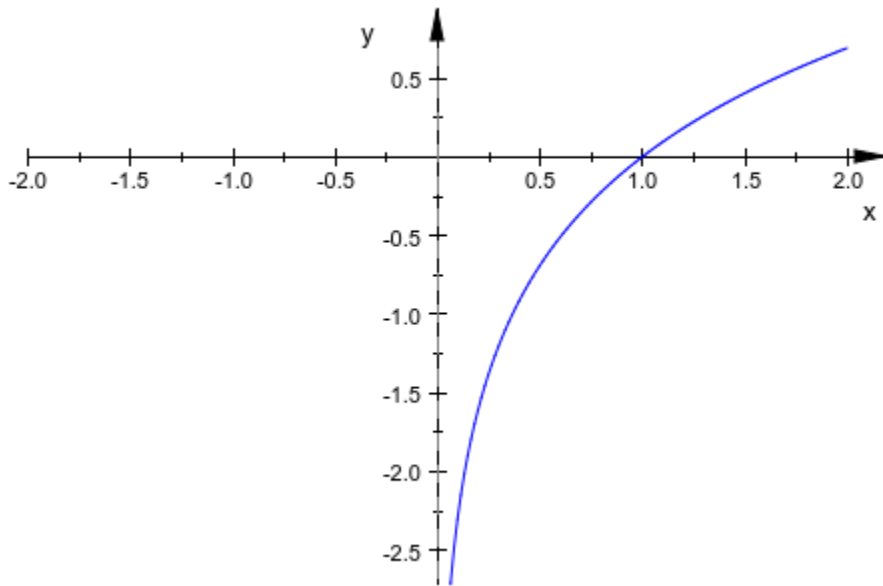

We specify the viewing box both in  $x$  and  $y$  direction:

```
plot(f, ViewingBox = [-2..2, -2..2])
```

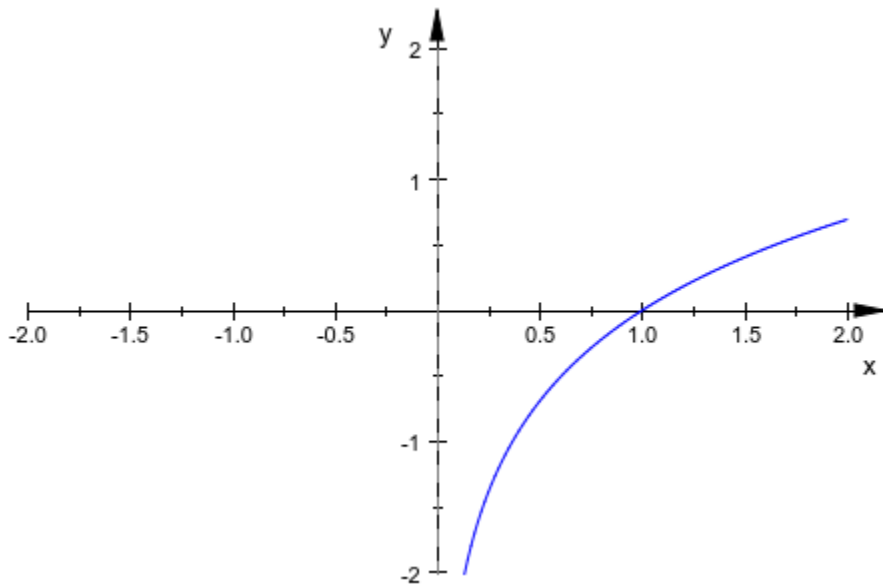

delete f:

### Example 4

The following viewing box is larger than expected:

```
c := plot::Ellipse2d(1, 0.5, [0, 0]):  
r := plot::Rotate2d(c, PI/3):  
plot(r)
```



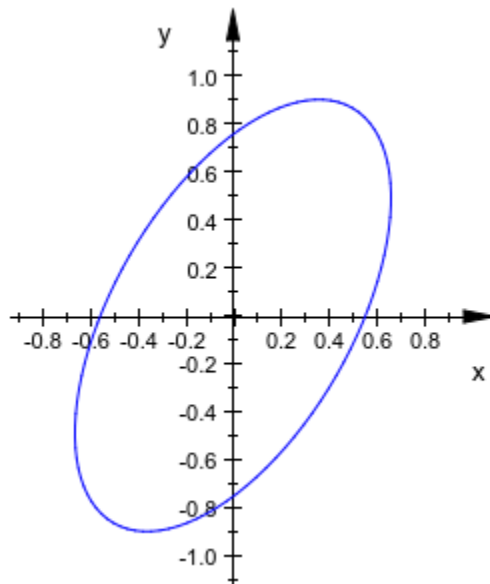

The reason is how the viewing box of the rotation is computed. The blue rectangle is the viewing box of the ellipse. The rotated viewing box is the black rectangle. The viewing box of the rotation is the smallest rectangle containing the rotated viewing box of the ellipse (the dashed black rectangle):

```
rect1 := plot::Rectangle(-1..1, -0.5..0.5, Color = RGB::Black):
rect2 := plot::modify(rect1, Color = RGB::Blue):
r := plot::Rotate2d(c, rect1, a, a = 0..PI/2):
X := cos(a) + 0.5*sin(a):
Y := 0.5*cos(a) + sin(a):
rect3 := plot::Rectangle(-X..X, -Y..Y, a = 0..PI/2,
    Color = RGB::Black,
    LineStyle = Dashed):
plot(r, rect2, rect3)
```

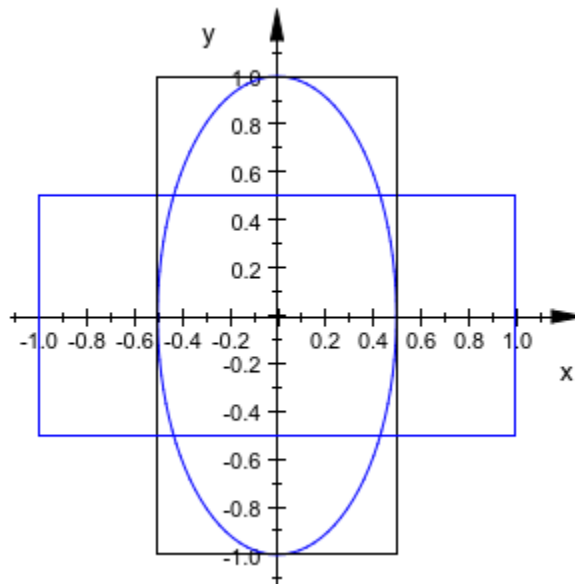

```
delete c, r, rect1, rect2, rect3, X, Y:
```

### Example 5

The x-range from  $-\pi$  to  $\pi$  is generated by *all* frames of the following animation and does not change from frame to frame:

```
plot(plot::Function2d(sin(x), x = -PI + a .. a, a = 0 .. PI)):
```

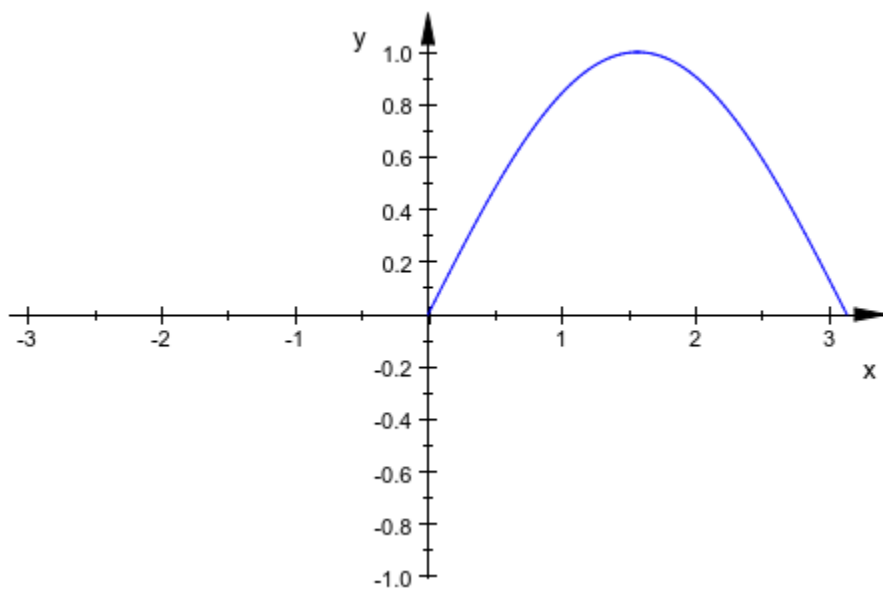

## See Also

### MuPAD Functions

`AffectViewingBox`

### MuPAD Graphical Primitives

`plot::ClippingBox`

# Visible

Visibility

## Value Summary

Optional	FALSE, or TRUE
----------	----------------

## Graphics Primitives

Objects	Visible Default Values
plot::AmbientLight, plot::Arc2d, plot::Arc3d, plot::Arrow2d, plot::Arrow3d, plot::Bars2d, plot::Bars3d, plot::Box, plot::Boxplot, plot::Camera, plot::Circle2d, plot::Circle3d, plot::ClippingBox, plot::Cone, plot::Conformal, plot::Curve2d, plot::Curve3d, plot::Cylinder, plot::Cylindrical, plot::Density, plot::DistantLight, plot::Dodecahedron, plot::Ellipse2d, plot::Ellipse3d, plot::Ellipsoid, plot::Function2d, plot::Function3d, plot::Group2d, plot::Group3d, plot::Hatch, plot::Hexahedron, plot::Histogram2d, plot::Icosahedron, plot::Implicit2d, plot::Implicit3d, plot::Inequality, plot::Integral, plot::Iteration, plot::Line2d, plot::Line3d, plot::Listplot, plot::Lsys, plot::Matrixplot, plot::MuPADCube, plot::Octahedron, plot::Ode2d, plot::Ode3d, plot::Parallelogram2d, plot::Parallelogram3d, plot::Piechart2d, plot::Piechart3d, plot::Plane, plot::Point2d, plot::Point3d, plot::PointLight, plot::PointList2d, plot::PointList3d, plot::Polar, plot::Polygon2d, plot::Polygon3d, plot::Prism, plot::Pyramid, plot::QQplot, plot::Raster,	TRUE

Objects	Visible Default Values
plot::Rectangle, plot::Rootlocus, plot::Scatterplot, plot::Sequence, plot::SparseMatrixplot, plot::Sphere, plot::Spherical, plot::SpotLight, plot::Streamlines2d, plot::Sum, plot::Surface, plot::SurfaceSet, plot::SurfaceSTL, plot::Sweep, plot::Tetrahedron, plot::Text2d, plot::Text3d, plot::Tube, plot::Turtle, plot::VectorField2d, plot::VectorField3d, plot::Waterman, plot::XRotate, plot::ZRotate	

## Description

`Visible = FALSE` makes an object invisible.

All graphical objects react to the attribute `Visible`. With `Visible = FALSE`, an object is made invisible. This attribute can be set in the property inspector of the interactive viewer (see section [Viewer, Browser, and Inspector: Interactive Manipulation \(Symbolic Math Toolbox\)](#) in this document) to make a selected object disappear without needing to change and re-execute the plot call.

Invisible objects do influence the viewing box on page 24-1422 of their coordinate systems.

`Visible` cannot be animated. However, the attributes `VisibleBefore`, `VisibleBeforeBegin`, `VisibleAfter`, and `VisibleAfterEnd` serve for some form of animated visibility. See section [Frame by Frame Animations \(Symbolic Math Toolbox\)](#) in this document for further details and examples.

## Examples

### Example 1

Consider the following scene:

```
plot(plot::Function2d(sin(x), x = -2..2),  
      plot::Point2d([1, 2], PointSize = 5*unit::mm))
```

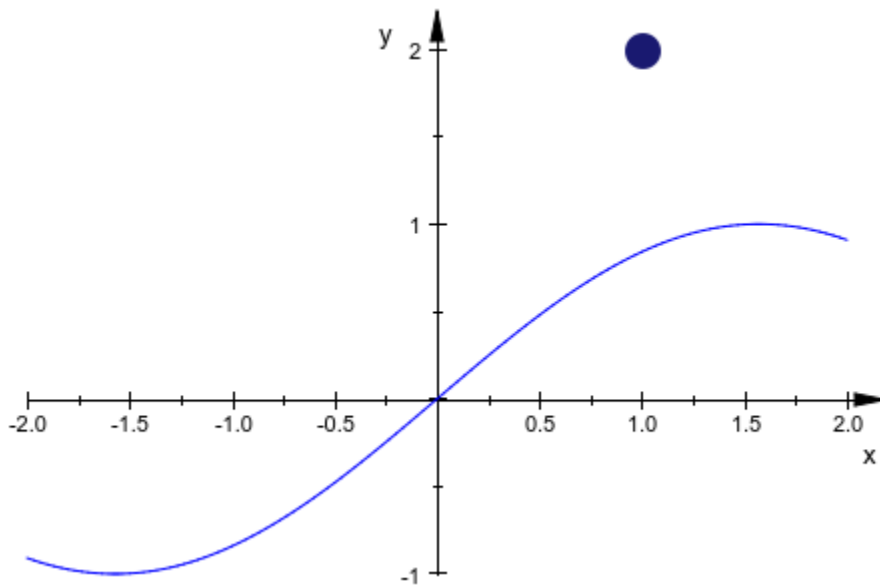

Obviously, the point influences the visible region of the coordinates. This region is not affected by making the point invisible:

```
plot(plot::Function2d(sin(x), x=-2..2),  
      plot::Point2d([1, 2], PointSize = 5*unit::mm,  
                    Visible = FALSE))
```

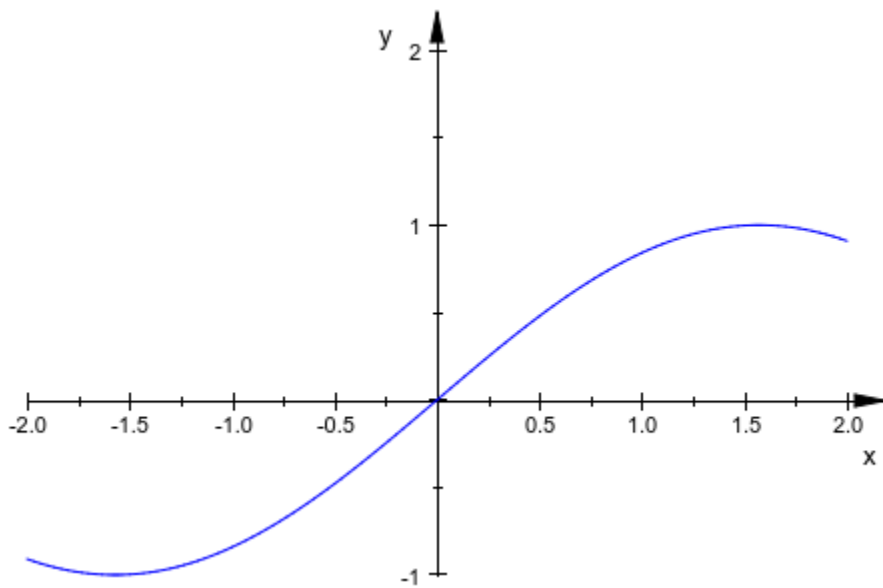

## See Also

### MuPAD Functions

[VisibleAfter](#) | [VisibleAfterEnd](#) | [VisibleBefore](#) | [VisibleBeforeBegin](#)



# XFunction1YFunction1ZFunction1XFunction2YFunction2ZFunction2

Parametrization of the curves in sweep surfaces

## Value Summary

XFunction1, XFunction2, YFunction1, YFunction2, ZFunction1, ZFunction2	Mandatory	Arithmetical expression (Symbolic Math Toolbox) or function
--	-----------	---

## Graphics Primitives

Objects	Default Values
plot::Sweep	

## Description

XFunction1 etc. are the parametrization functions of the curves delimiting a surface of type plot::Sweep.

In most cases, the user passes parametrizations  $[x_1(u), y_1(u), z_1(u)]$  and  $[x_2(u), y_2(u), z_2(u)]$  as expressions of a curve parameter  $u$  directly to plot::Sweep. Internally, these expressions are stored as the attributes XFunction1 =  $x_1(u)$ , ..., ZFunction2 =  $z_2(u)$  in the sweep object. They can be accessed and changed via the corresponding slots "XFunction1" etc. of the sweep object.

The attributes XFunction1 etc. can also be defined by procedures on page 1-1654 instead of symbolic expressions.

## Examples

### Example 1

Typically, the user sets the parametrization of the bounding curves directly by passing lists of corresponding expressions to `plot::Sweep`. Here, `XFunction1 = u`, `YFunction1 = 1 - u2`, `ZFunction1 = u3`, `XFunction2 = u`, `YFunction2 = 1 - u2`, `ZFunction2 = 0`:

```
s := plot::Sweep([u, 1 - u^2, u^3], [u, 1 - u^2, 0], u = 0..1)
```

```
plot::Sweep([u, 1 - u^2, u^3], [u, 1 - u^2, 0], u = 0..1)
```

```
plot(s):
```

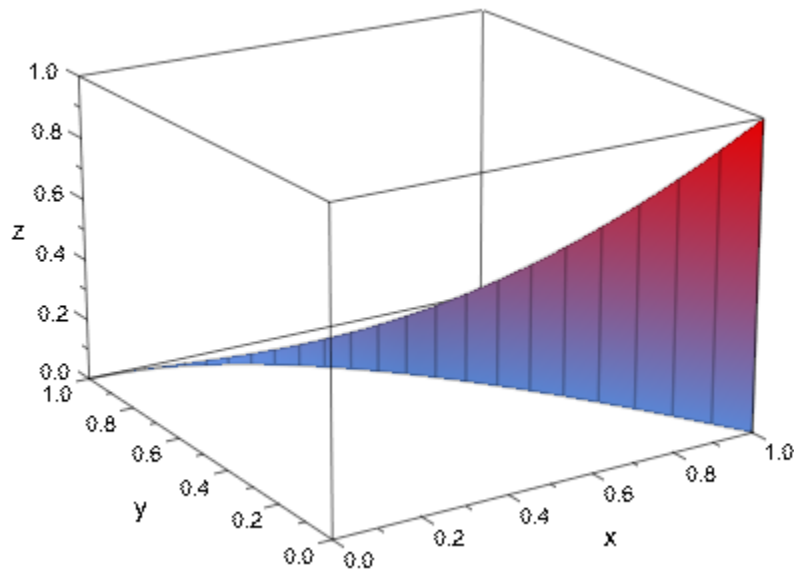

```
s::XFunction1, s::YFunction1, s::ZFunction1
```

```
u, 1 - u^2, u^3
```

```
s::XFunction2, s::YFunction2, s::ZFunction2
```

```
u, 1 - u2, 0
```

We change the z-component of the “target curve”:

```
s::ZFunction2 := s::ZFunction1 / 2:  
s
```

```
plot::Sweep([u, 1 - u2, u3], [u, 1 - u2, u3/2], u = 0..1)
```

```
plot(s)
```

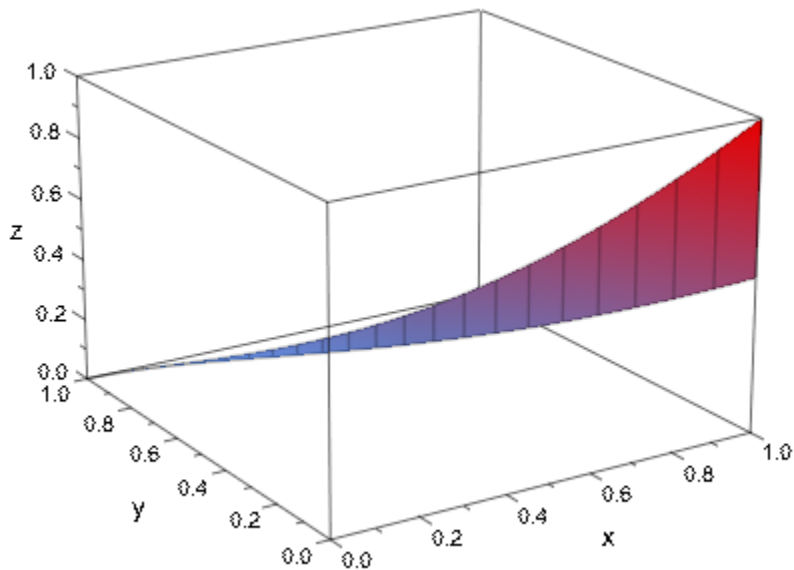

Instead of expressions, the attributes XFunction1 etc. can be defined by procedures on page 1-1654:

```
s::ZFunction2 := u -> u:  
s
```

```
plot::Sweep([u, 1-u2, u3], [u, 1-u2, u → u], u = 0..1)
```

```
plot(s)
```

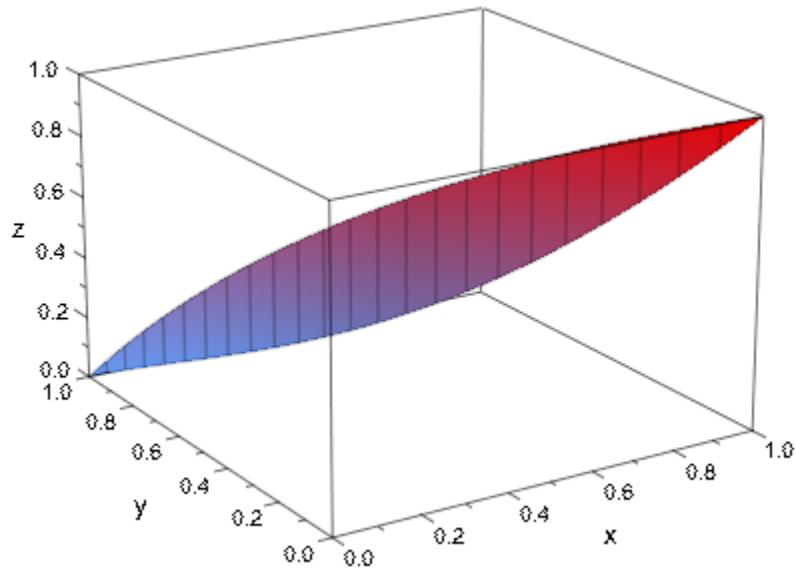

```
delete s:
```

## Axes

Type of the coordinate axes

### Value Summary

Inherited	Automatic, Boxed, Frame, None, or Origin
-----------	--

### Graphics Primitives

Objects	Axes Default Values
<code>plot::CoordinateSystem2d</code>	Automatic
<code>plot::CoordinateSystem3d</code>	Boxed

### Description

Axes determines the type of the coordinate axes.

The following types of coordinate axes are available:

- **Automatic:** The axes are displayed as a coordinate cross. The cross point is not taken from the attribute `AxesOrigin`, but is chosen automatically.
- **Origin:** The axes are displayed as a coordinate cross. The cross point is set by the attribute `AxesOrigin`. If `AxesOrigin` is not set, the origin of the coordinate system is used as the default cross point. If the `AxesOrigin` is not inside the “viewing box” of the scene, parts of the axes may not be visible (cf. “Example 4” on page 24-1451 (Symbolic Math Toolbox)).
- **Boxed:** The axes are displayed as a box around the graphical scene. It corresponds to the “viewing box” of the scene and may be set explicitly by the attribute `ViewingBox`.
- **Frame:** As with `Axes = Boxed`, the edges of the “viewing box” are used. However, only the labeled edges are displayed.

- **None:** No coordinate axes are displayed.

As an alternative to `Axes = None`, you may also “switch the axes off” by setting `AxesVisible = FALSE` in the `plot` command or via the interactive object inspector (see `Viewer`, `Browser`, and `Inspector: Interactive Manipulation (Symbolic Math Toolbox)` in this document).

Single coordinate axes can also be “switched off” separately via `XAxisVisible = FALSE` etc.

## Examples

### Example 1

We demonstrate the axes styles in 2D:

```
b1 := plot::Rectangle(0..1, 0..1, Color = RGB::Red):
b2 := plot::Rectangle(3..4, 3..4, Color = RGB::Blue):
plot(plot::Scene2d(b1, b2, Axes = None),
      plot::Scene2d(b1, b2, Axes = Boxed),
      plot::Scene2d(b1, b2, Axes = Frame),
      plot::Scene2d(b1, b2, Axes = Automatic),
      plot::Scene2d(b1, b2, Axes = Origin),
      plot::Scene2d(b1, b2, Axes = Origin,
                    AxesOrigin = [2, 2]),
      plot::Scene2d::BorderWidth = 0.5*unit::mm,
      Rows = 2):
```

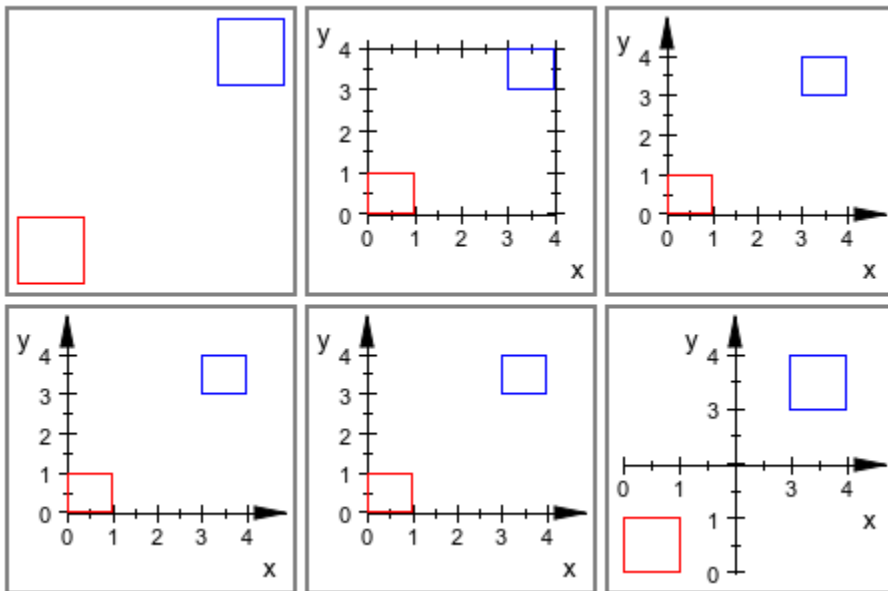

delete b1, b2:

## Example 2

We demonstrate the axes styles in 3D:

```

b1 := plot::Box(0..1, 0..1, 0..1, Color = RGB::Red):
b2 := plot::Box(3..4, 3..4, 3..4, Color = RGB::Blue):
plot(plot::Scene3d(b1, b2, Axes = None),
      plot::Scene3d(b1, b2, Axes = Boxed),
      plot::Scene3d(b1, b2, Axes = Frame),
      plot::Scene3d(b1, b2, Axes = Automatic),
      plot::Scene3d(b1, b2, Axes = Origin),
      plot::Scene3d(b1, b2, Axes = Origin,
                    AxesOrigin = [2, 2, 2]),
      plot::Scene3d::BorderWidth = 0.5*unit::mm,
      Rows = 2):

```

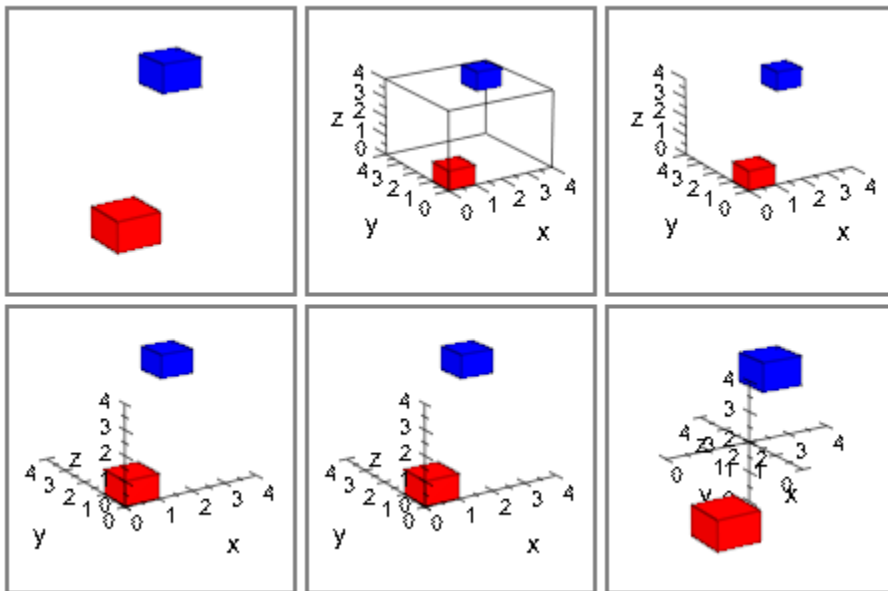

delete b1, b2:

### Example 3

Here is a hyperboloid with various axes:

```
f1 := plot::Function3d(sqrt(0.2 + x^2 + y^2),
                        x = -1..2, y = -1..2):
f2 := plot::Function3d(-sqrt(0.2 + x^2 + y^2),
                        x = -1..2, y = -1..2):
plot(f1, f2):
```



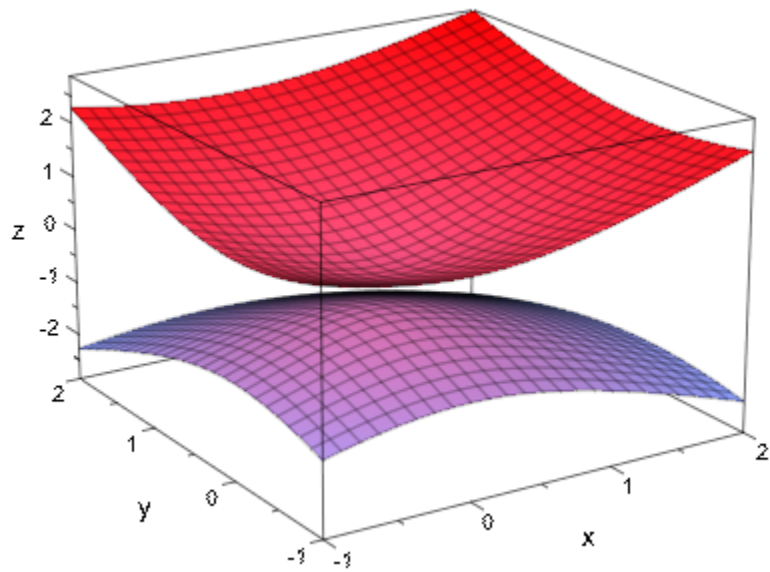

```
plot(f1, f2, Axes = Origin,  
     AxesOrigin = [-1, -1, 0]):
```

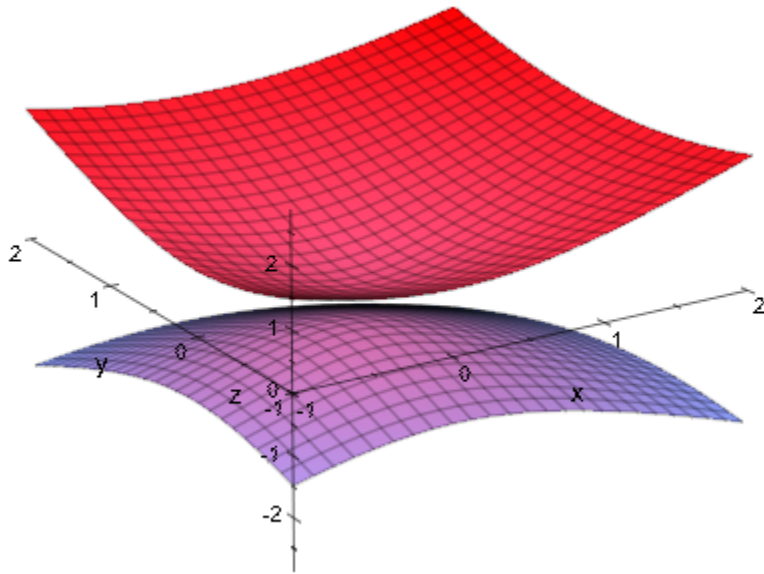

```
plot(f1, f2, Axes = Frame):
```

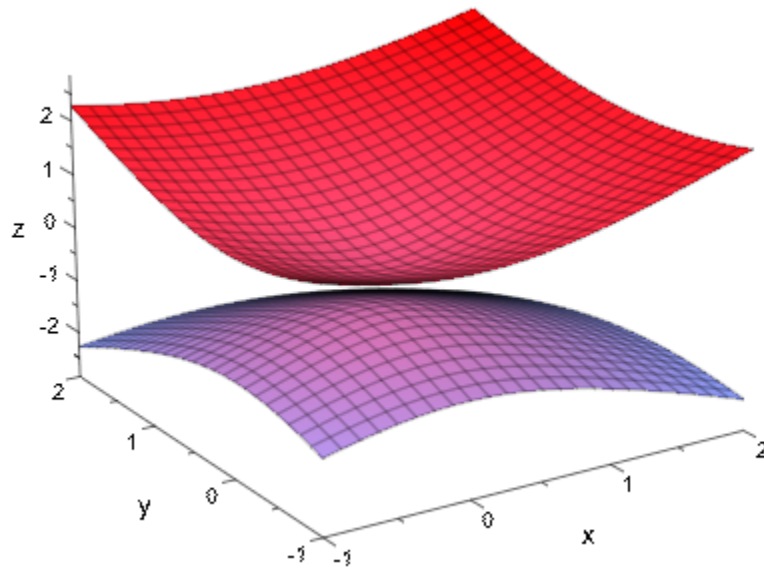

```
delete f1, f2:
```

### Example 4

We draw a portion of the normal distribution density:

```
F := plot::Function2d(stats::normalPDF(0, 1)(x),  
                      x = -2.5 .. 2.5):  
plot(F)
```

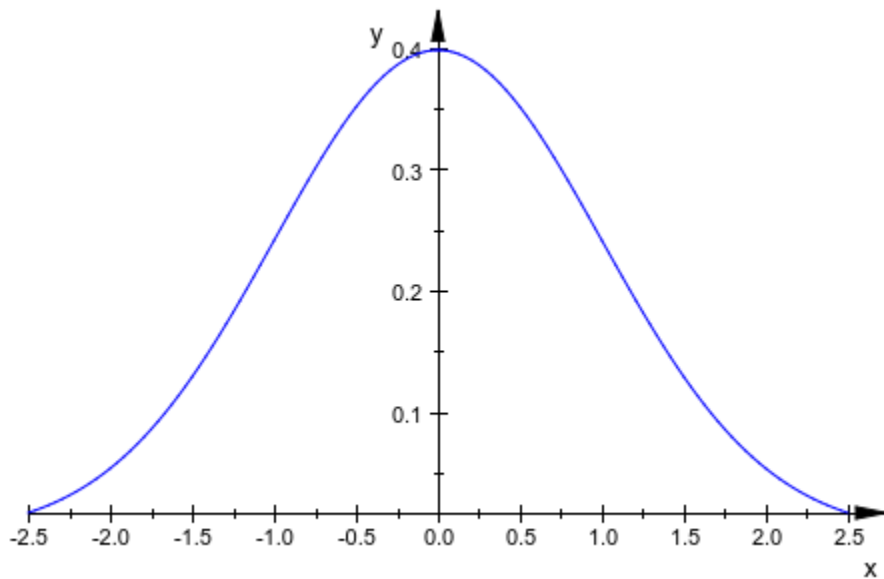

Note that with the default setting `Axes = Automatic`, the x-axis does not pass through the origin but is shifted along the y-axis to fit into the viewing box of the scene.

With `Axes = Origin`, the x-axis passes through the origin, but is outside the viewing box:

```
plot(F, Axes = Origin)
```

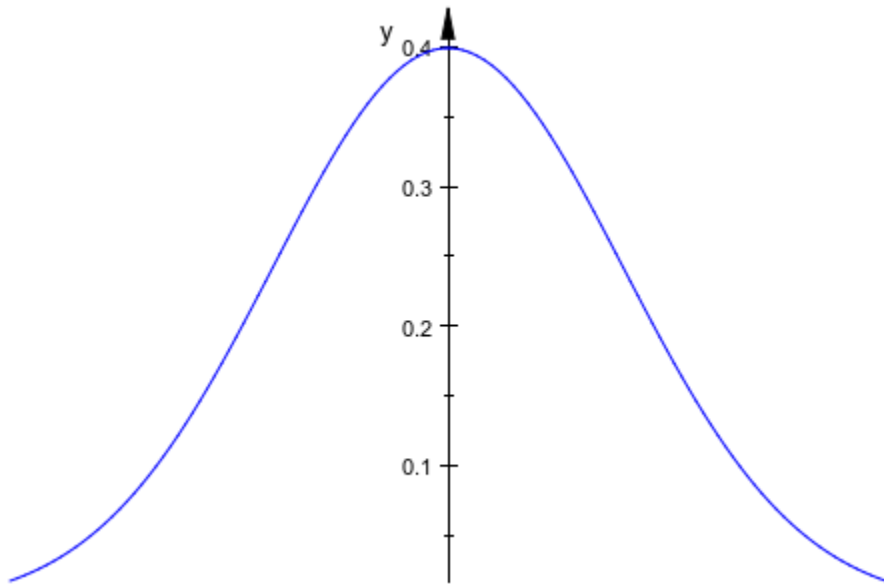

We extend the viewing box in the y direction:

```
plot(F, Axes = Origin, ViewingBoxYRange = 0 .. Automatic):
```

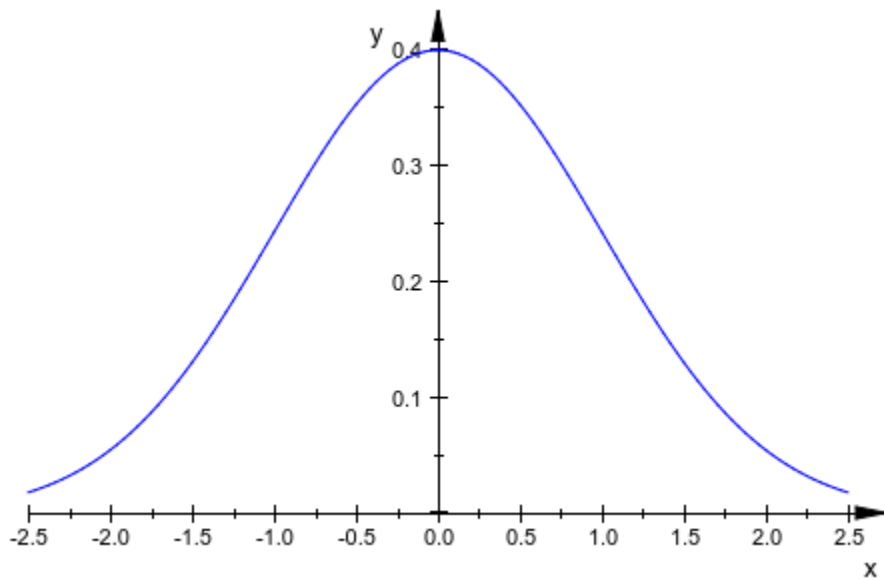

delete F:

## See Also

### MuPAD Functions

[AxesInFront](#) | [AxesLineColor](#) | [AxesLineWidth](#) | [AxesOrigin](#) | [AxesTips](#) | [AxesTitleAlignment](#) | [AxesTitleFont](#) | [AxesTitles](#) | [AxesVisible](#) | [YAxisTitleOrientation](#)

## AxesInFront

Coordinate axes in front of or behind graphical objects?

### Value Summary

Inherited	FALSE, or TRUE
-----------	----------------

### Graphics Primitives

Objects	AxesInFront Default Values
plot::CoordinateSystem2d	FALSE

### Description

AxesInFront = TRUE versus AxesInFront = FALSE places 2D axes in front of or behind the graphical objects in the scene.

By default, the coordinate axes are plotted behind the graphical objects in a scene. Consequently, the objects may cover the axes. If only line objects and points are present in a 2D scene, this is desirable in most cases.

However, if there are filled areas such as filled polygons in the scene, the view to the axes, tick marks, and tick labels may be totally blocked. In such a situation, you may want to draw the axes in front of the objects to guarantee visibility of the axes.

Although the default setting is AxesInFront = FALSE, some objects which create filled areas send AxesInFront = TRUE as a “hint” (see the section Primitives Requesting Special Scene Attributes: “Hints” (Symbolic Math Toolbox) of this documentation).

This attribute is available only in 2D.

## Examples

### Example 1

It is usually desirable to let line objects and points cover the axes:

```
p1 := plot::Point2d(0, 0.62, PointSize = 3*unit::mm,
                   Color = RGB::Green):
p2 := plot::Point2d(0, 0.93, PointSize = 3*unit::mm,
                   Color = RGB::Green):
f1 := plot::Function2d(x^5*heaviside(x), x = -1 .. 1,
                      Color = RGB::Blue):
f2 := plot::Function2d(x^2, x = -1 .. 1, Color = RGB::Red):
plot(plot::Scene2d(p1, p2, f1, f2, AxesInFront = FALSE),
     plot::Scene2d(p1, p2, f1, f2, AxesInFront = TRUE)):
```

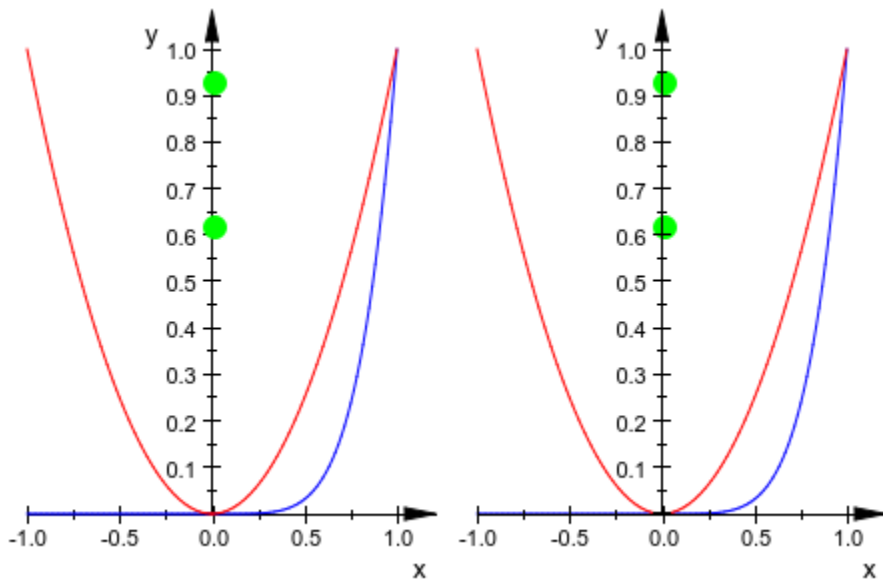

However, you probably want to have the axes visible in front of the following density plot:

```
d := plot::Density(exp(-x^2 - y^2), x = -1..1, y = -1 .. 1,
                  FillColor = RGB::White):
plot(plot::Scene2d(d, AxesInFront = FALSE),
```



```
plot::Scene2d(d, AxesInFront = TRUE),  
Layout = Horizontal):
```

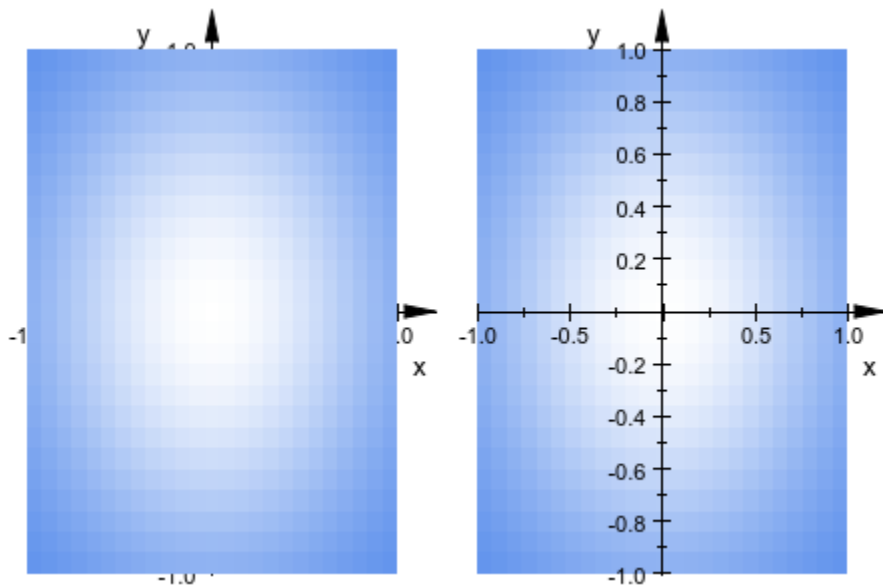

Note that density objects of type `plot::Density` automatically send the “hint” (Symbolic Math Toolbox) `AxesInFront = TRUE`, so there is no need to set this attribute explicitly:

```
plot(d):
```

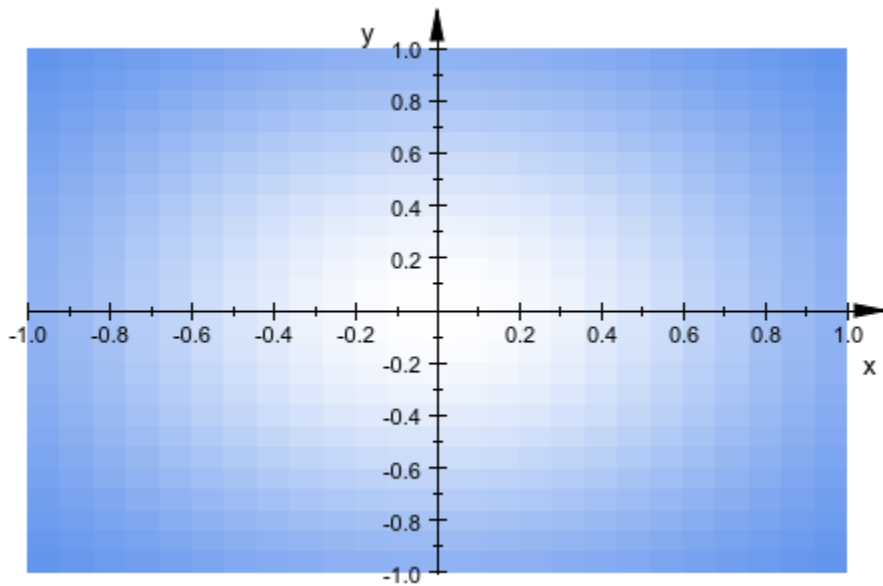

```
delete p1, p2, f1, f2, d;
```

## See Also

### MuPAD Functions

[Axes](#) | [AxesLineColor](#) | [AxesLineWidth](#) | [AxesOrigin](#) | [AxesTips](#) | [AxesTitleAlignment](#) | [AxesTitleFont](#) | [AxesTitles](#) | [AxesVisible](#) | [YAxisTitleOrientation](#)

# AxesLineColor

Color of the coordinate axes

## Value Summary

Inherited	Color
-----------	-------

## Graphics Primitives

Objects	AxesLineColor Default Values
plot::CoordinateSystem2d, plot::CoordinateSystem3d	RGB::Black

## Description

AxesLineColor sets the RGB color (Symbolic Math Toolbox) for the coordinate axes and the tick marks.

The color of the axes titles and the tick labels are *not* set by AxesLineColor. Choose an appropriate color for the corresponding fonts (Symbolic Math Toolbox) via the attributes AxesTitleFont and TicksLabelFont.

## Examples

### Example 1

The black axes are not appropriate for the following density graphics on page 24-265:

```
d := plot::Density(exp(-x^2 - y^2), x = -1..1, y = -1 ..1,
                   FillColor = RGB::Black);
plot(d)
```

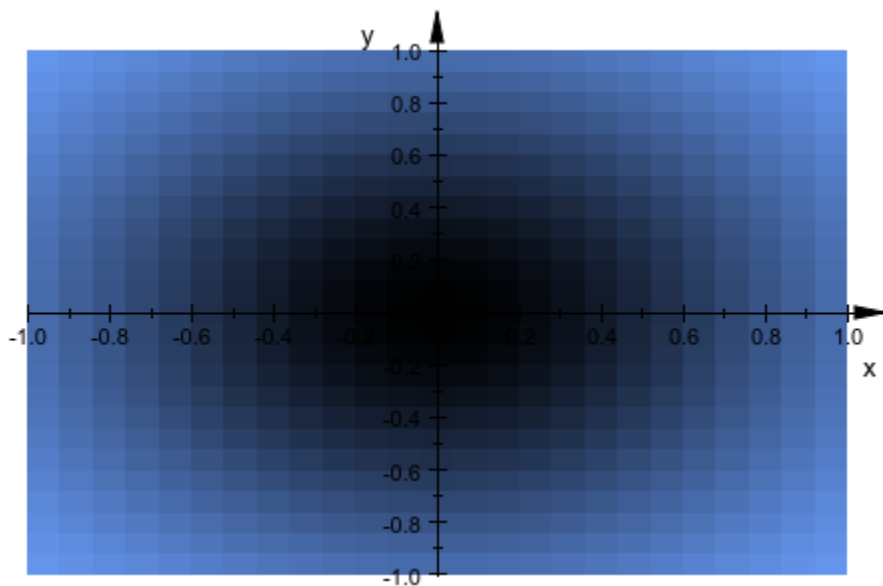

We change the axes color to `white` via `AxisLineColor`. The titles and the tick labels along the axes do not turn white, automatically, so we choose white font (Symbolic Math Toolbox) colors as well:

```
plot(d,  
     AxesLineColor = RGB::White,  
     AxesTitleFont = [RGB::White],  
     TicksLabelFont = [RGB::White],  
     plot::Scene2d::BackgroundColor = RGB::Black)
```

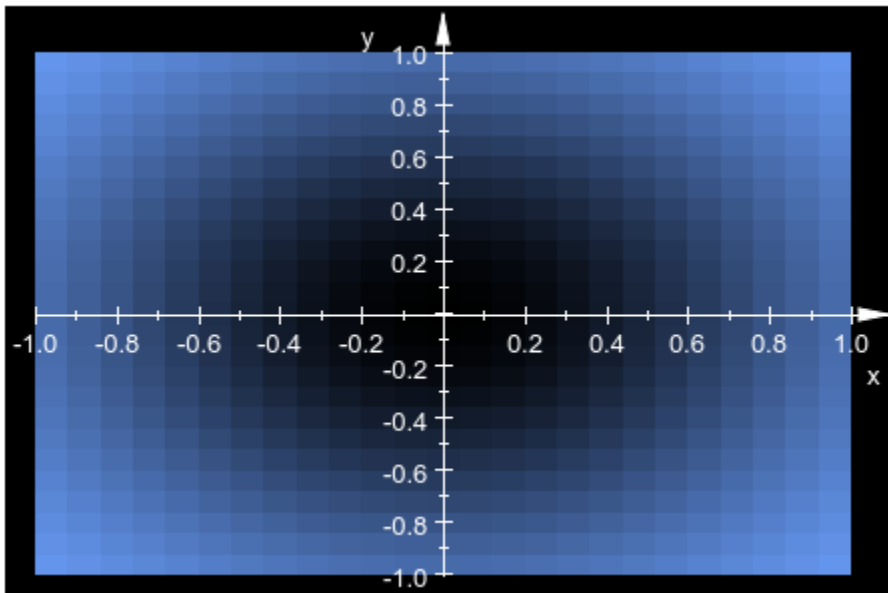

delete d:

## Example 2

We display the axes as a blue box:

```
plot(plot::Sphere(1, [0, 0, 0]), AxesLineColor = RGB::Blue):
```

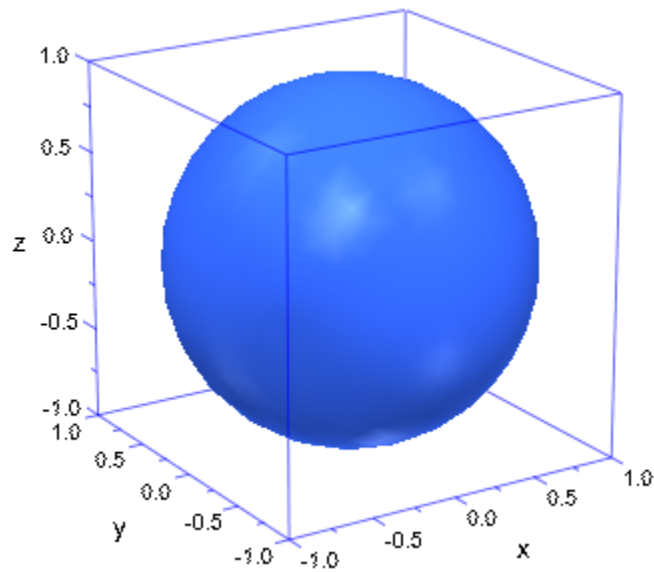

## See Also

### MuPAD Functions

[Axes](#) | [AxesInFront](#) | [AxesLineWidth](#) | [AxesOrigin](#) | [AxesTips](#) | [AxesTitleAlignment](#) | [AxesTitleFont](#) | [AxesTitles](#) | [AxesVisible](#) | [YAxisTitleOrientation](#)

# AxesLineWidth

Width of the coordinate axes

## Value Summary

Inherited	Positive output size
-----------	----------------------

## Graphics Primitives

Objects	AxesLineWidth Default Values
plot::CoordinateSystem2d, plot::CoordinateSystem3d	0.18

## Description

AxesLineWidth sets the width for the coordinate axes, the ticks, and the AxesTips. The value should be specified as an absolute physical length including a length unit on page 1-2196 such as AxesLineWidth = 0.5\*unit::mm. Numbers without a physical unit give the size in mm.

The length of the ticks is not affected by AxesLineWidth and can be set separately via TicksLength.

Note that the graphics cannot always react to small changes of the line width because of the discretization into pixels.

## Examples

### Example 1

We create a graticule with “thick” wiring. Note that LineWidth refers to the circles, whereas AxesLineWidth relates to the coordinate axes:

```
plot(plot::Circle2d(1, [0, 0]),  
      TicksDistance = 0.2, TicksLength = 5*unit::mm,  
      LineWidth = 0.5*unit::mm, AxesLineWidth = 1*unit::mm):
```

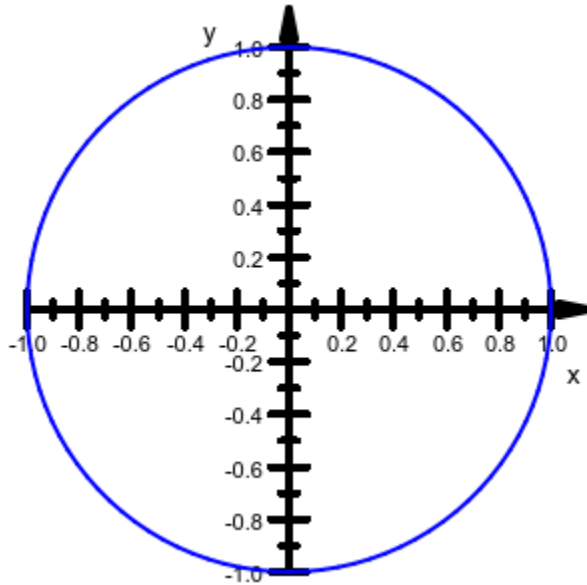

## See Also

### MuPAD Functions

[Axes](#) | [AxesInFront](#) | [AxesLineColor](#) | [AxesOrigin](#) | [AxesTips](#) |  
[AxesTitleAlignment](#) | [AxesTitleFont](#) | [AxesTitles](#) | [AxesVisible](#) |  
[TicksLength](#) | [YAxisTitleOrientation](#)



# AxesOriginAxesOriginXAxesOriginYAxesOriginZ

Crosspoint of the coordinate axes

## Value Summary

AxesOrigin	Library wrapper for “[AxesOriginX, AxesOriginY]” (2D), “[AxesOriginX, AxesOriginY, AxesOriginZ]” (3D)	See below
AxesOriginX, AxesOriginY, AxesOriginZ	Optional	MuPAD expression

## Graphics Primitives

Objects	Default Values
plot::CoordinateSystem2d	AxesOrigin: [0, 0] AxesOriginX, AxesOriginY: 0
plot::CoordinateSystem3d	AxesOrigin: [0, 0, 0] AxesOriginX, AxesOriginY, AxesOriginZ: 0

## Description

AxesOrigin determines the crosspoint of the coordinate axes.

These attributes only have an effect with `Axes = Origin`. The coordinate axes are displayed as a cross.

The vector `AxesOrigin` determines the point where the coordinate axes cross. Depending on the dimension of the scene, it is given by a list of 2 or 3 components.

`AxesOriginX` etc. refer to the  $x$ ,  $y$ ,  $z$  components of this point.

---

**Note** If the crosspoint of the axes is not inside the “viewing box” of the scene, parts of the axes may not be visible.

---

The viewing box may be set explicitly via the attribute `ViewingBox`. With `Axes = Automatic`, the point given by `AxesOrigin` is ignored; the crosspoint of the axes is chosen automatically inside the viewing box.

## Examples

### Example 1

We plot two spheres representing a planet with a moon. The coordinate axes cross at their common center of gravity:

```
m1 := 1: x1 := 0:
x2 := 1: m2 := 0.2:
earth := plot::Sphere(0.1, [x1, 0, 0],
                      FillColor = RGB::SkyBlue):
moon := plot::Sphere(0.03, [x2, 0, 0],
                     FillColor = RGB::Grey):
plot(earth, moon, Axes = Origin,
     YTicksNumber = None, ZTicksNumber = None,
     AxesOrigin = [(m1*x1 + m2*x2)/(m1 + m2), 0, 0],
     ViewingBox = [-0.2 .. 1.1, -0.2..0.2, -0.2..0.2]):
```

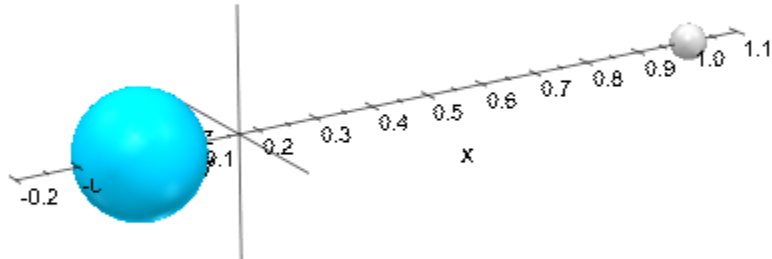

```
delete m1, m2, x1, x2, earth, moon:
```

## See Also

### MuPAD Functions

[Axes](#) | [AxesInFront](#) | [AxesLineColor](#) | [AxesLineWidth](#) | [AxesTips](#) | [AxesTitleAlignment](#) | [AxesTitleFont](#) | [AxesTitles](#) | [AxesVisible](#) | [YAxisTitleOrientation](#)

## AxesTips

Arrow tips at the coordinate axes?

### Value Summary

Inherited	FALSE, or TRUE
-----------	----------------

### Graphics Primitives

Objects	AxesTips Default Values
<code>plot::CoordinateSystem2d</code>	TRUE
<code>plot::CoordinateSystem3d</code>	FALSE

### Description

With `AxesTips = TRUE`, the coordinate axes are drawn with arrow tips.

This attribute only has an effect with `Axes = Automatic` or `Axes = Origin`. In both cases the coordinate axes are displayed as a cross.

With `AxesTips = TRUE`, little arrows are drawn on the end of the coordinate axes pointing into the positive direction.

The size of the arrow tips that are displayed as lines is controlled by `AxesLineWidth`.

`AxesTips = FALSE` suppresses any coordinate axes tips.

## Examples

### Example 1

In order to emphasize on AxesTips, we plot empty scenes. The tick marks are “switched off” via `TicksNumber = None`:

```
S1 := plot::Scene2d(AxesTips = FALSE):  
S2 := plot::Scene2d(AxesTips = TRUE):  
plot(S1, S2, TicksNumber = None, Layout = Horizontal):
```

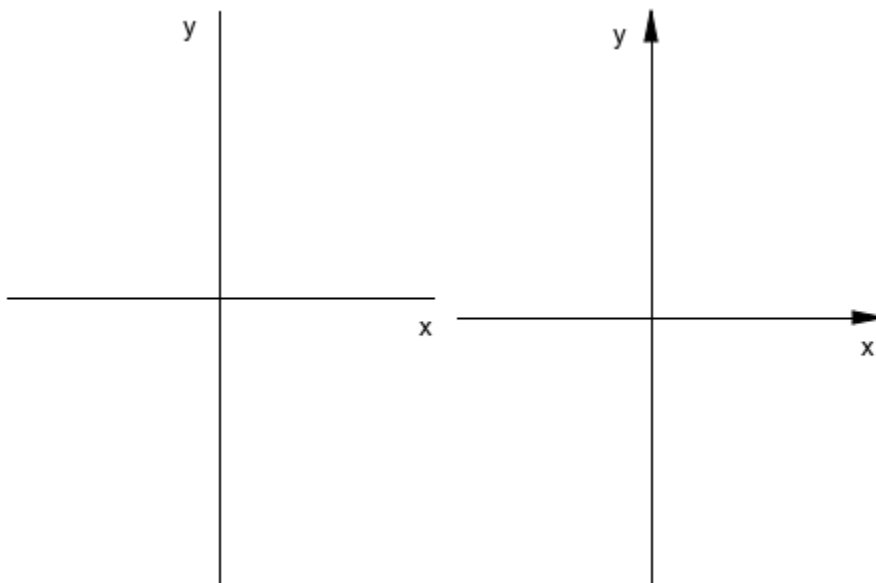

```
S1 := plot::Scene3d(AxesTips = FALSE):  
S2 := plot::Scene3d(AxesTips = TRUE):  
plot(S1, S2, Axes = Origin, TicksNumber = None,  
      Layout = Horizontal):
```

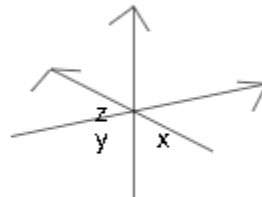
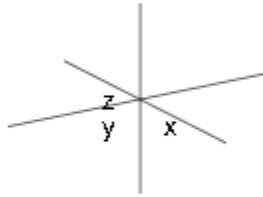

## See Also

### MuPAD Functions

[Axes](#) | [AxesInFront](#) | [AxesLineColor](#) | [AxesLineWidth](#) | [AxesOrigin](#) | [AxesTitleAlignment](#) | [AxesTitleFont](#) | [AxesTitles](#) | [AxesVisible](#) | [TipAngle](#) | [TipLength](#) | [TubeDiameter](#) | [YAxisTitleOrientation](#)

# AxesTitleAlignmentXAxisTitleAlignmentYAxisTitleAlignmentZAxisTitleAlignment

Alignment of axes titles

## Value Summary

AxesTitleAlignment	Library wrapper for “{XAxisTitleAlignment, YAxisTitleAlignment}” (2D), “{XAxisTitleAlignment, YAxisTitleAlignment, ZAxisTitleAlignment}” (3D)	See below
XAxisTitleAlignment, YAxisTitleAlignment, ZAxisTitleAlignment	Inherited	Begin, Center, or End

## Graphics Primitives

Objects	Default Values
plot::CoordinateSystem2d	AxesTitleAlignment, XAxisTitleAlignment, YAxisTitleAlignment: End
plot::CoordinateSystem3d	AxesTitleAlignment, XAxisTitleAlignment, YAxisTitleAlignment, ZAxisTitleAlignment: Center

## Description

AxesTitleAlignment governs the alignment of axes titles along the coordinate axes.

With `AxisTitleAlignment = End`, titles for all coordinate axes are displayed at that end of the axes with higher coordinate values.

With `AxisTitleAlignment = Begin`, titles are displayed at that end of the axes with lower coordinate values.

With `AxisTitleAlignment = Center`, titles are centered along the axes.

`XAxisTitleAlignment` etc. allow to set the title alignments separately for each single axis.

## Examples

### Example 1

We plot the Coulomb potential of a charged particle:

```
F := plot::Function2d(-1/r, r = 0..1,
    ViewingBoxYRange = -10..0):
S1 := plot::Scene2d(F, AxesTitles = ["distance", "potential"],
    XAxisTitleAlignment = Center,
    YAxisTitleAlignment = Begin):
S2 := plot::Scene2d(F, AxesTitles = ["distance", "potential"],
    XAxisTitleAlignment = Begin,
    YAxisTitleAlignment = End):
S3 := plot::Scene2d(F, AxesTitles = ["distance", "potential"],
    XAxisTitleAlignment = Begin,
    YAxisTitleAlignment = Begin):
plot(S1, S2, S3, Layout = Horizontal,
    Width = 120*unit::mm, Height = 50*unit::mm):
```



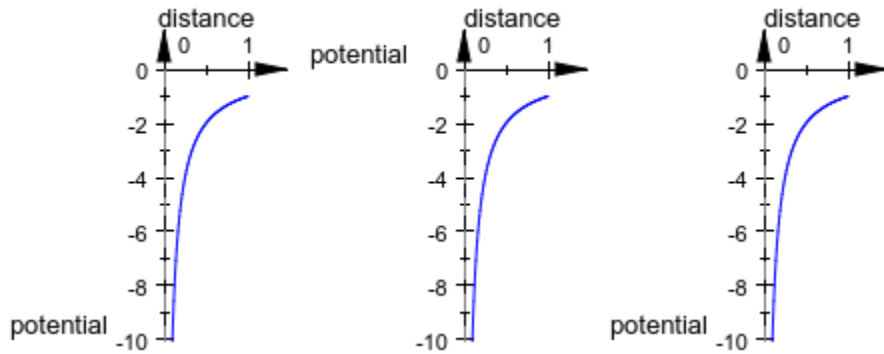

delete F, S1, S2, S3:

## Example 2

We use the 3D analogue of the previous example to demonstrate the alignment of axes titles in 3D: :

```
F := plot::Function3d(-1/sqrt(x^2 + y^2), x = -1..1, y = -1..1,
    ViewingBoxZRange = -10 .. 0):
S1 := plot::Scene3d(F, AxesTitles = ["x", "y", "potential"],
    XAxisTitleAlignment = Begin,
    YAxisTitleAlignment = Center,
    ZAxisTitleAlignment = End):
S2 := plot::Scene3d(F, AxesTitles = ["x", "y", "potential"],
    XAxisTitleAlignment = Center,
    YAxisTitleAlignment = End,
    ZAxisTitleAlignment = Begin):
plot(S1, S2, Layout = Vertical,
    Width = 80*unit::mm, Height = 120*unit::mm):
```

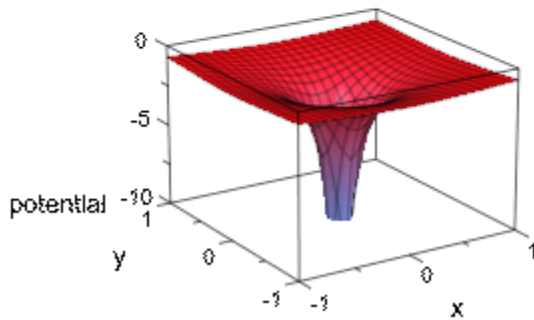
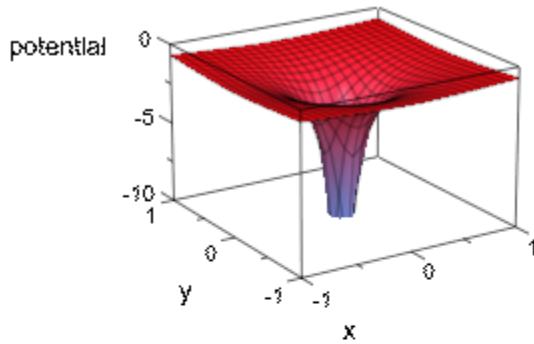

delete F, S1, S2:

## See Also

### MuPAD Functions

[Axes](#) | [AxesInFront](#) | [AxesLineColor](#) | [AxesLineWidth](#) | [AxesOrigin](#) | [AxesTips](#) | [AxesTitleFont](#) | [AxesTitles](#) | [AxesVisible](#) | [YAxisTitleOrientation](#)

# AxesTitlesXAxisTitleYAxisTitleZAxisTitle

Titles for the coordinate axes

## Value Summary

AxesTitles	Library wrapper for "[XAxisTitle, YAxisTitle]" (2D), "[XAxisTitle, YAxisTitle, ZAxisTitle]" (3D)	See below
XAxisTitle, YAxisTitle, ZAxisTitle	Optional	Text string

## Graphics Primitives

Objects	Default Values
plot::CoordinateSystem2d	AxesTitles: [" x ", " y "] XAxisTitle: " x " YAxisTitle: " y "
plot::CoordinateSystem3d	AxesTitles: [" x ", " y ", " z "] XAxisTitle: " x " YAxisTitle: " y " ZAxisTitle: " z "

## Description

`AxesTitles` sets the titles attached to the coordinate axes.

Depending on the dimension of the coordinate system, the value of the attribute `AxisTitles` must be a list with two or three strings on page 7-53.

Per default, the coordinate axes titles are ["x", "y"] in 2D and ["x", "y", "z"] in 3D regardless of the names of involved parameters. Cf. "Example 1" on page 24-1476 (Symbolic Math Toolbox).

Using `AxesTitles`, axes titles can be edited as desired.

With `XAxisTitle` etc., the titles can be edited separately for the different coordinate directions.

Set empty strings `AxesTitles = ["", ""]` in 2D or `AxesTitles = ["", "", ""]` in 3D, respectively, if no axes titles shall be displayed.

Some objects in the MuPAD `plot` library override the default setting via the "hint mechanism" (see the section Primitives Requesting Special Scene Attributes: "Hints" (Symbolic Math Toolbox) in this document). Whenever such an object is plotted in a scene, the axes titles chosen by the object are used. A complete list of these objects is given further up on this help page.

You can still override these titles via `AxesTitles` etc.

The attribute `AxisTitleAlignment` can be used to change the default alignment of the titles along the axes.

The attribute `YAxisTitleOrientation` can be used in 2D to rotate the title of the vertical axis.

## Examples

### Example 1

We set appropriate axes titles for a damped vibration given by a plot of the "amplitude over time":

```
F := plot::Function2d(exp(-t)*cos(PI*t), t = 0 .. 4):  
plot(F, AxesTitles = ["time", "amplitude"]):
```

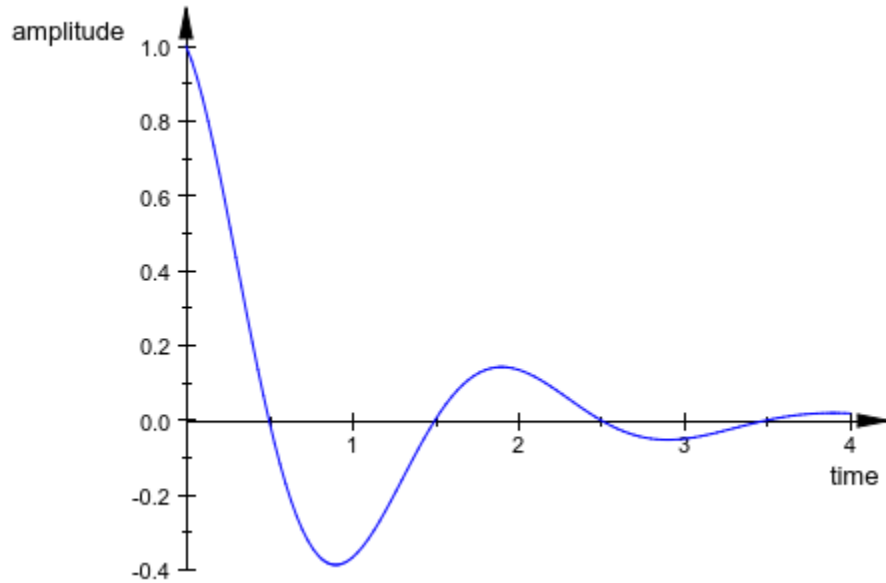

It might be desirable to use the attribute `YAxisTitleOrientation` to twist the title for the vertical axis:

```
plot(F, AxesTitles = ["time", "amplitude"],  
      YAxisTitleOrientation = Vertical):
```

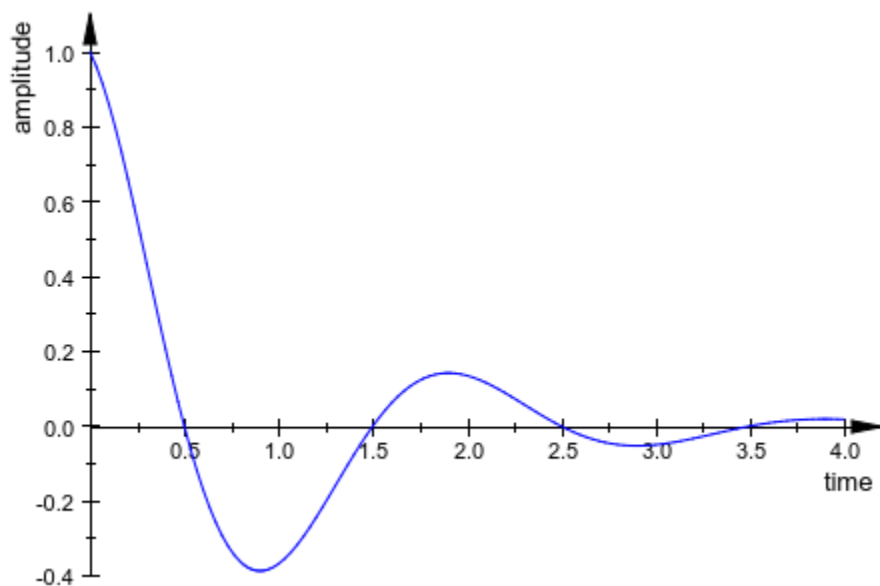

## See Also

### MuPAD Functions

[Axes](#) | [AxesInFront](#) | [AxesLineColor](#) | [AxesLineWidth](#) | [AxesOrigin](#) | [AxesTips](#) | [AxesTitleAlignment](#) | [AxesTitleFont](#) | [AxesVisible](#) | [YAxisTitleOrientation](#)

# AxesVisibleXAxisVisibleYAxisVisibleZAxisVisible

Display coordinate axes?

## Value Summary

AxesVisible	Library wrapper for “{XAxisVisible, YAxisVisible}” (2D), “{XAxisVisible, YAxisVisible, ZAxisVisible}” (3D)	TRUE, FALSE, or list of 2 or 3 of these, depending on the dimension
XAxisVisible, YAxisVisible, ZAxisVisible	Inherited	FALSE, or TRUE

## Graphics Primitives

Objects	Default Values
plot::CoordinateSystem2d	AxesVisible, XAxisVisible, YAxisVisible: TRUE
plot::CoordinateSystem3d	AxesVisible, XAxisVisible, YAxisVisible, ZAxisVisible: TRUE

## Description

With AxesVisible = TRUE versus AxesVisible = FALSE all coordinate axes are “switched on” or “off”.

With XAxisVisible etc., the coordinate axes in the different coordinate directions can be switched on and off, separately.

With `Axes = Box`, the coordinate axes are displayed as a box about the scene. With `XAxisVisible = FALSE` etc., the four edges of this box parallel to the respective axis are suppressed.

Alternatively to `AxesVisible = FALSE`, you may switch the axes off by setting `Axes = None`, too.

## Examples

### Example 1

In the following illustration, you probably do not want any axes:

```
plot(  
  plot::Arrow2d([1.5, 1], [2.5, 3],  
                Title = "a", TitlePosition = [2.05, 1.9],  
                LineStyle = Dashed, Color = RGB::Red),  
  plot::Arrow2d([1, 2], [2.5, 3],  
                Title = "b", TitlePosition = [1.6, 2.5],  
                LineStyle = Dashed, Color = RGB::Blue),  
  plot::Arrow2d([0, 0], [1, 2], Color = RGB::Red,  
                Title = "a", TitlePosition = [0.4, 1.0]),  
  plot::Arrow2d([0, 0], [1.5, 1], Color = RGB::Blue,  
                Title = "b", TitlePosition = [0.8, 0.3]),  
  plot::Arrow2d([0, 0], [2.5, 3], Color = RGB::Black,  
                Title = "a + b", TitlePosition = [1.35, 1.3]),  
  AxesVisible = FALSE, TitleFont = [14],  
  TipLength = 5.0*unit::mm, LineWidth = 1.0*unit::mm,  
  HeaderFont = [20], Header = "how to add two vectors"  
)
```



## how to add two vectors

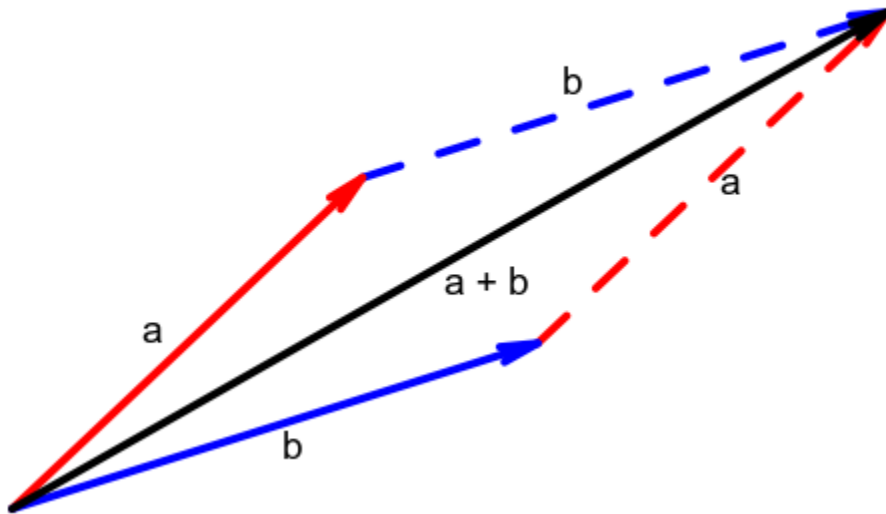

### Example 2

Using the default axes style `Axes = Box` in 3D, we suppress all parts of the axes box in the x direction:

```
plot(plot::Sphere(1, [0, 0, 0]), XAxisVisible = FALSE):
```

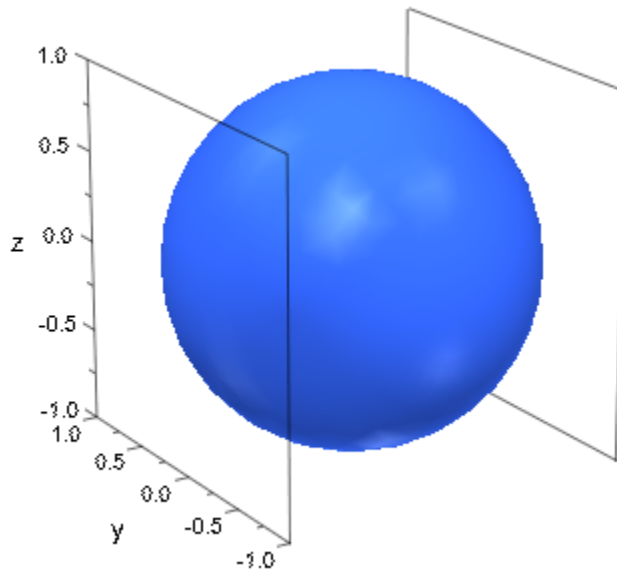

## See Also

### MuPAD Functions

[Axes](#) | [AxesInFront](#) | [AxesLineColor](#) | [AxesLineWidth](#) | [AxesOrigin](#) | [AxesTips](#) | [AxesTitleAlignment](#) | [AxesTitleFont](#) | [AxesTitles](#) | [YAxisTitleOrientation](#)

# YAxisTitleOrientation

Orientation of the vertical axis title in 2D

## Value Summary

Inherited	Horizontal, or Vertical
-----------	-------------------------

## Graphics Primitives

Objects	YAxisTitleOrientation Default Values
<code>plot::CoordinateSystem2d</code>	Horizontal

## Description

`YAxisTitleOrientation` determines whether the title of the vertical axis in 2D is plotted horizontally or vertically.

If the title of the vertical axis on page 24-1475 in 2D is long, it uses up a lot of horizontal space when rendered from left to right with `YAxisTitleOrientation = Horizontal`. This space may be taken away from the drawing region for the graphical objects. In such a case it might be desirable to use `YAxisTitleOrientation = Vertical` to let the title be rendered from bottom to top instead, parallel to the vertical axis.

This attribute is ignored in 3D.

## Examples

### Example 1

We plot the density of the normal distribution function:

```
f := plot::Function2d(stats::normalPDF(0, 1)(x), x = -3 .. 3):  
plot(f, Axes = Automatic,  
     AxesTitles = ["x", "normal distribution"],  
     YAxisTitleOrientation = Horizontal):
```

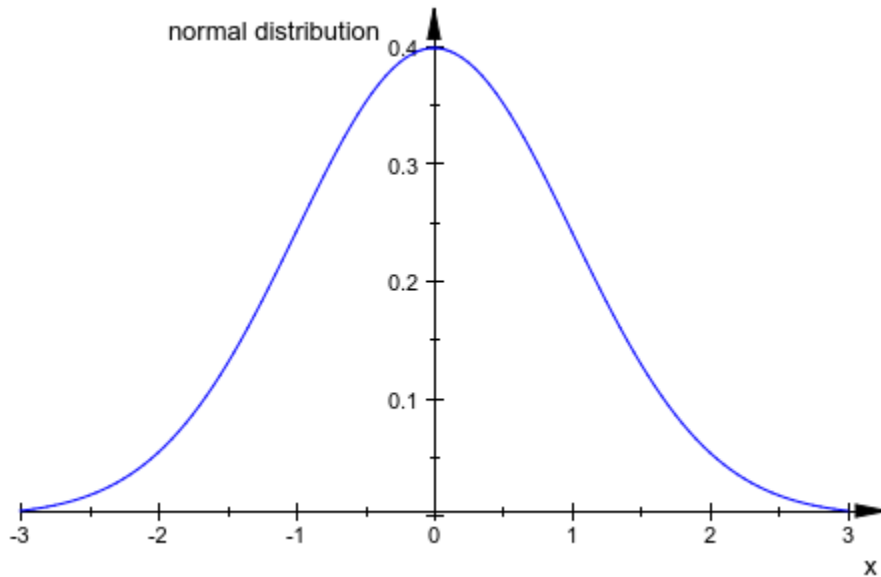

There is plenty of room to draw the long title "normal distribution", because the vertical axis is placed in the middle of the plot. In the next plot, however, the vertical axis is flushed left and a lot of space is "wasted" for the axis title:

```
plot(f, Axes = Frame,  
     AxesTitles = ["x", "normal distribution"],  
     YAxisTitleOrientation = Horizontal):
```

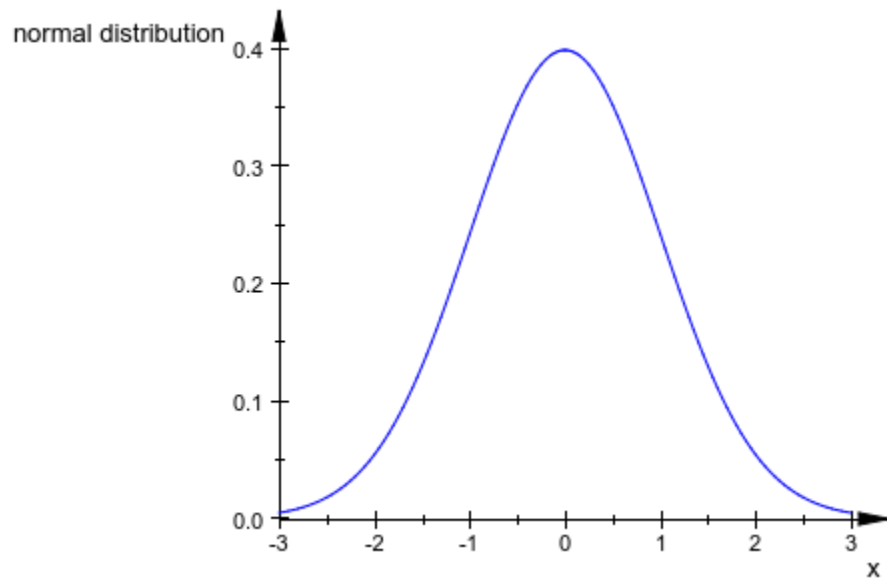

You make better use of the drawing area by plotting the title of the vertical axis parallel to this axis:

```
plot(f, Axes = Frame,  
     AxesTitles = ["x", "normal distribution"],  
     YAxisTitleOrientation = Vertical):
```

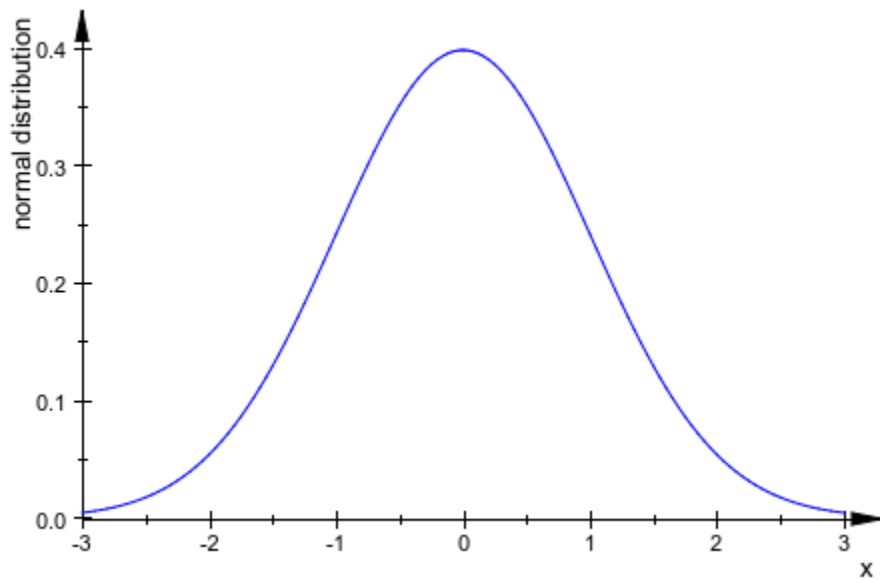

delete f:

## See Also

### MuPAD Functions

[Axes](#) | [AxesInFront](#) | [AxesLineColor](#) | [AxesLineWidth](#) | [AxesOrigin](#) | [AxesTips](#) | [AxesTitleAlignment](#) | [AxesTitles](#) | [AxesVisible](#) | [YAxisTitleOrientation](#)

# TicksAnchorXTicksAnchorYTicksAnchorZTicksAnchor

User defined start of axes tick marks

## Value Summary

TicksAnchor	Library wrapper for “{XTicksAnchor, YTicksAnchor}” (2D), “{XTicksAnchor, YTicksAnchor, ZTicksAnchor}” (3D)	MuPAD expression
XTicksAnchor, YTicksAnchor, ZTicksAnchor	Optional	MuPAD expression

## Graphics Primitives

Objects	Default Values
plot::CoordinateSystem2d	TicksAnchor, XTicksAnchor, YTicksAnchor: 0
plot::CoordinateSystem3d	TicksAnchor, XTicksAnchor, YTicksAnchor, ZTicksAnchor: 0

## Description

With  $TicksAnchor = t_0$ ,  $TicksDistance = d$ , the automatic ticks along the coordinate axes are switched off and replaced by equidistant ticks with distance  $d$  at the positions  $t_j = t_0 + jd, j \in \mathbb{Z}$ .

With  $TicksAnchor = t_0$ ,  $TicksDistance = d$ , these ticks are used for all coordinate axes.

With  $X\text{TicksAnchor} = t_0$ ,  $X\text{TicksDistance} = d$  etc., these ticks may be defined separately for each single coordinate axis.

When executing a plot command, per default a “reasonable” placing for tick marks on coordinate axes is automatically computed. Through this process tick marks may not come to lie on desired positions. The attributes `TicksAnchor` and `TicksDistance` allow to generate an alternative mesh of equidistant tick marks.

---

**Note** The attributes `TicksAnchor`, `XTicksAnchor` etc. only have an effect when a positive distance  $d > 0$  between major ticks marks is set explicitly via `TicksDistance = d`, `XTicksDistance = d` etc.

---

The ticks set by `TicksAnchor` and `TicksDistance` are “major” tick marks bearing labels. Depending on the value of `TicksBetween`, there may be additional “minor” ticks without labels between each pair of major tick marks.

Additional tick marks at specific positions can be inserted with `TicksAt`.

## Examples

### Example 1

For the following plot of the sine function, the tick marks along the x-axis are chosen to match the period:

```
plot(plot::Function2d(sin(x), x = 0..4*PI),  
      XTicksAnchor = 0, XTicksDistance = PI):
```



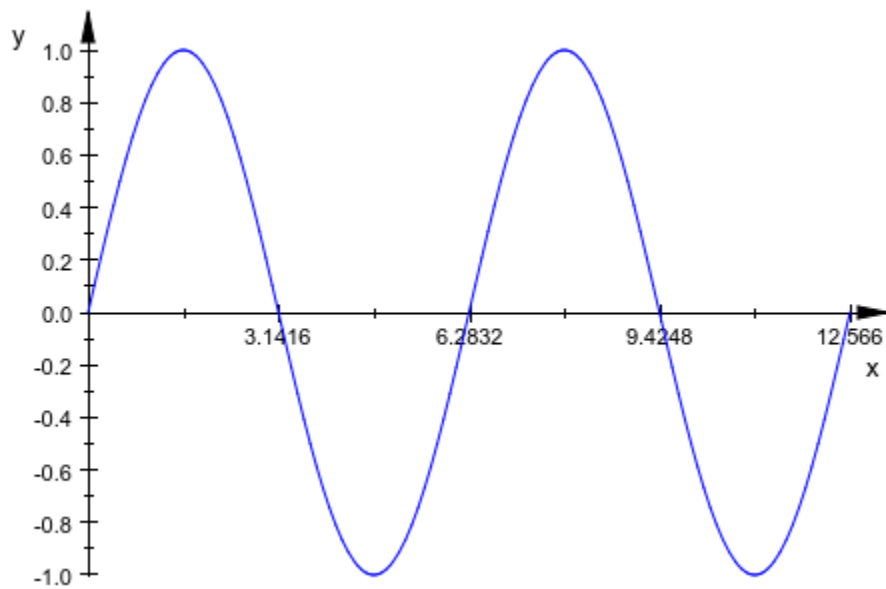

The ticks along the y-axis are re-defined with a distance of 0.2:

```
plot(plot::Function2d(sin(x), x = 0..4*PI),  
      XTicksAnchor = 0, XTicksDistance = PI,  
      YTicksAnchor = 0, YTicksDistance = 0.2):
```

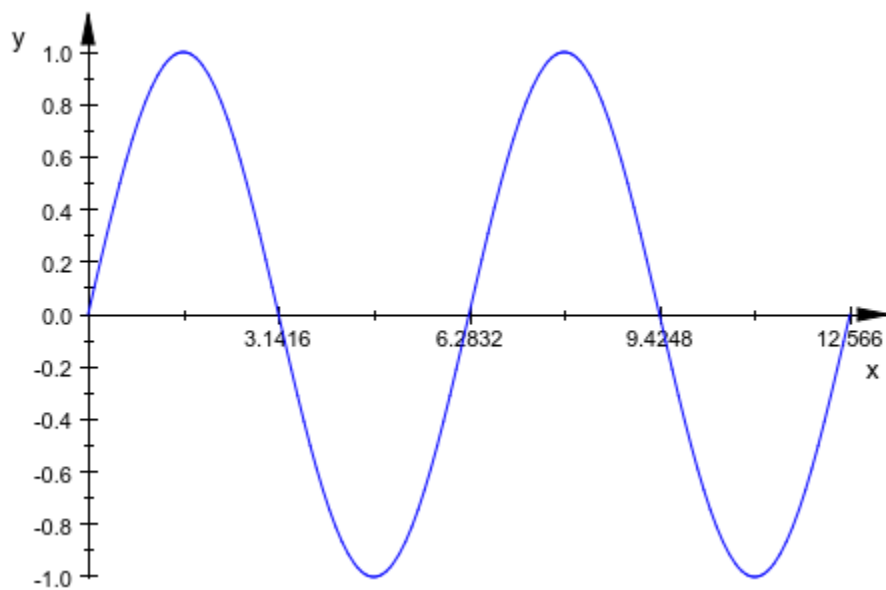

We increase the number of “minor” ticks along the x-axis:

```
plot(plot::Function2d(sin(x), x = 0..4*PI),  
      XTicksAnchor = 0, XTicksDistance = PI,  
      XTicksBetween = 4,  
      YTicksAnchor = 0, YTicksDistance = 0.2):
```

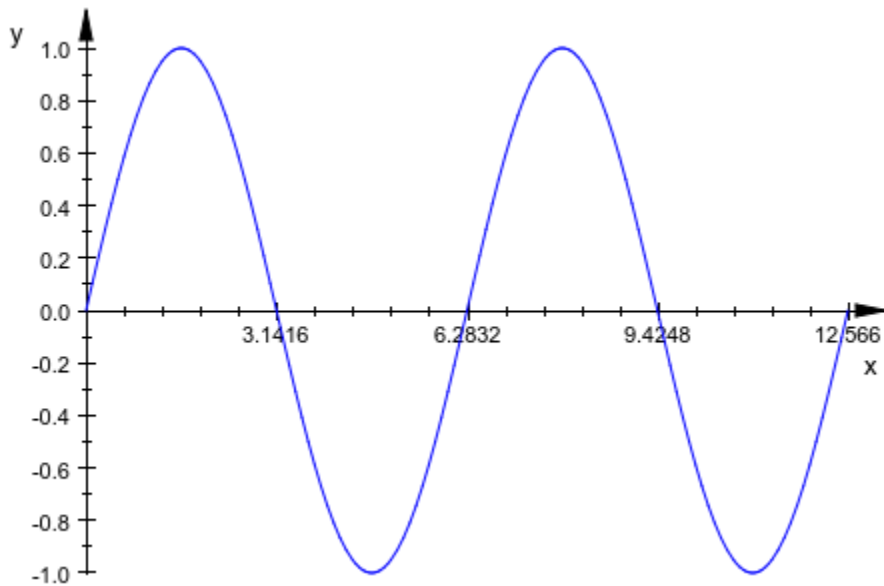

## Example 2

We plot the two-dimensional normal distribution centered around the mean  $(m_1, m_2) = (3.2, 4.9)$ . This point is used as the anchor for the tick marks along the x-axis and the y-axis, respectively. Ticks are positioned at distances that are integer multiples of the standard deviations  $(s_1, s_2) = (0.8, 1.2)$ :

```
m1:= 3.2: s1 := 0.8:
m2:= 4.9: s2 := 1.1:
plot(plot::Function3d( stats::normalPDF(m1, s1^2)(x)
                      *stats::normalPDF(m2, s2^2)(y),
                      x = 0 .. 10, y = 0 .. 10,
                      Submesh = [3, 3]),
     TicksBetween = 0,
     XTicksAnchor = m1, XTicksDistance = s1,
     YTicksAnchor = m2, YTicksDistance = s2,
     XTicksLabelStyle = Vertical,
     YTicksLabelStyle = Diagonal,
     GridVisible = TRUE):
```

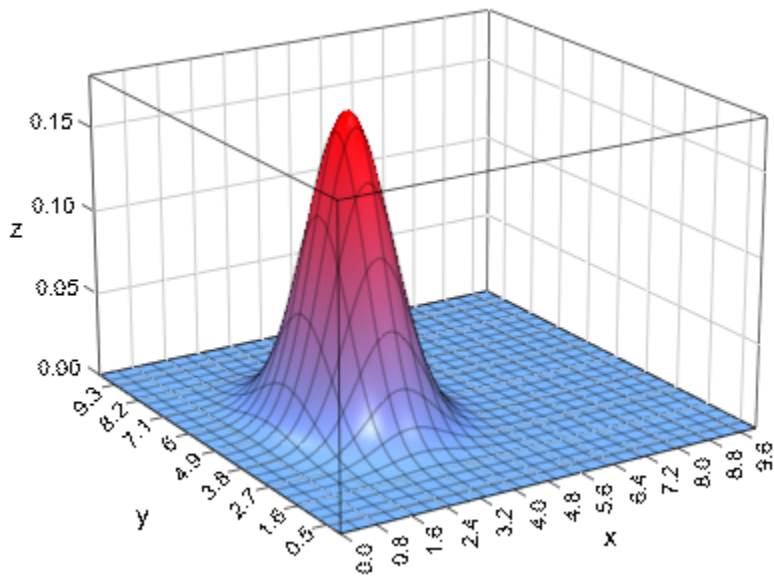

`delete m1, s1, m2, s2:`

## See Also

### MuPAD Functions

[TicksAt](#) | [TicksBetween](#) | [TicksDistance](#) | [TicksLabelFont](#) | [TicksLabelStyle](#) | [TicksLabelsVisible](#) | [TicksLength](#) | [TicksNumber](#) | [TicksVisible](#)

# TicksAtXTicksAtYTicksAtZTicksAt

Special axes tick marks

## Value Summary

TicksAt	Library wrapper for “[XTicksAt, YTicksAt]” (2D), “[XTicksAt, YTicksAt, ZTicksAt]” (3D)	See below
XTicksAt, YTicksAt, ZTicksAt	Optional	See below

## Graphics Primitives

Objects	Default Values
plot::CoordinateSystem2d, plot::CoordinateSystem3d	

## Description

`XTicksAt = [x1, x2, ...]` allows to set additional tick marks on the x-axis at the positions  $x_1, x_2$  etc. With `XTicksAt = [x1 = L1, x2 = L2, ...]`, the special tick marks at the positions  $x_1, x_2$  etc. are labeled with the strings  $L_1, L_2$  etc.

`YTicksAt, ZTicksAt` work analogously for the other coordinate directions.

`TicksAt = [[x1, x2, ...], [y1, y2, ...]]` in 2D and `TicksAt = [[x1, x2, ...], [y1, y2, ...], [z1, z2, ...]]` in 3D serve as shortcuts for setting `XTicksAt, YTicksAt` etc.

Per default, equidistant tick marks along the coordinate axes are chosen automatically.

With `XTicksAt = [x1, x2, ...]`, *additional* tick marks are inserted along the x-axis at arbitrary positions  $x_1$ ,  $x_2$  etc. These values must be numbers or exact numerical expressions such as `PI` (Symbolic Math Toolbox) or `sqrt(2)` that can be converted to floating-point numbers via `float`.

The special ticks set by `XTicksAt` are labeled automatically by floating-point numbers approximating  $x_1$ ,  $x_2$  etc.

Special labels for these ticks may be requested by replacing the coordinate values  $x_1$ ,  $x_2$  etc. by equations  $x_1 = L_1$ ,  $x_2 = L_2$  etc., where  $L_1$ ,  $L_2$  etc. are strings on page 7-53 to be used as the labels. Note that MuPAD strings have to be enclosed by the string delimiters ". For example, `XTicksAt = [3.14 = "pi"]` adds a single tick at the position  $x = 3.14$  with the label `pi`. Cf. "Example 1" on page 24-1494 (Symbolic Math Toolbox).

With `YTicksAt = [y1, y2, ...]` or `YTicksAt = [y1 = L1, y2 = L2, ...]` etc., special ticks can be inserted along the y-axis.

In 3D, `ZTicksAt` allows to insert special ticks along the z-axis.

If no automatic tick marks are desired, set `TicksNumber = None` or `XTicksNumber = None` etc. to switch them off on all coordinate axes or on single coordinate axes, respectively.

Use `TicksAt`, `XTicksAt` etc. to set alternative tick marks.

## Examples

### Example 1

We plot the cosine function. The automatic tick marks along the x-axis are suppressed via `XTicksNumber = None`. Points of special interest such as the extrema and the zeroes of the function are set as special tick marks:

```
plot(plot::Function2d(cos(x), x = -PI..PI),  
      XTicksNumber = None,  
      XTicksAt = [-PI = "-π", -PI/2 = "-π/2",  
                 0 = "0", PI/2 = "π/2", PI = "π"])
```

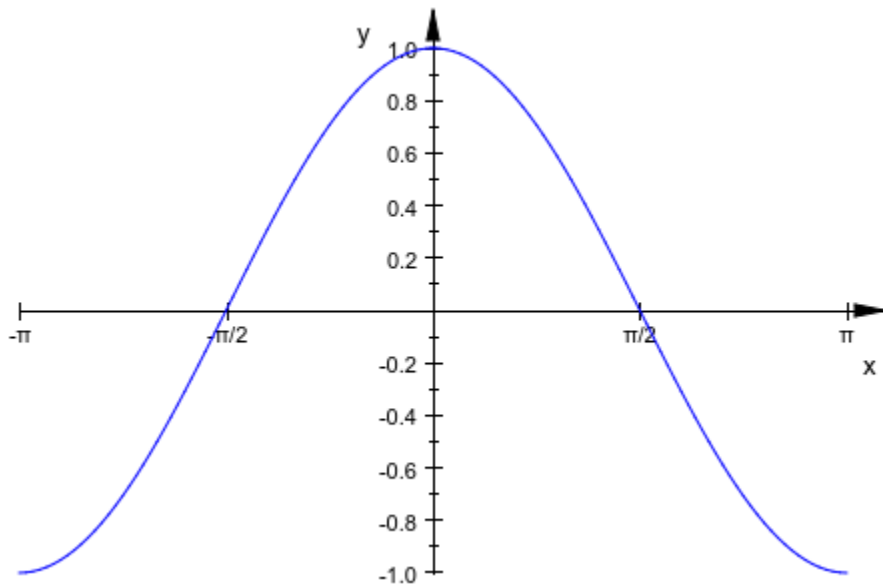

We improve the labeling of the tick marks by specifying the font (Symbolic Math Toolbox) . This font allows to typeset Greek characters such as  $\pi$  better:

```
plot(plot::Function2d(cos(x), x = -PI..PI),  
      XTicksNumber = None, TicksLabelFont = ["Times New Roman"],  
      XTicksAt = [-PI = "- $\pi$ ", -PI/2 = "- $\pi/2$ ",  
                  0 = "0", PI/2 = " $\pi/2$ ", PI = " $\pi$ "])
```

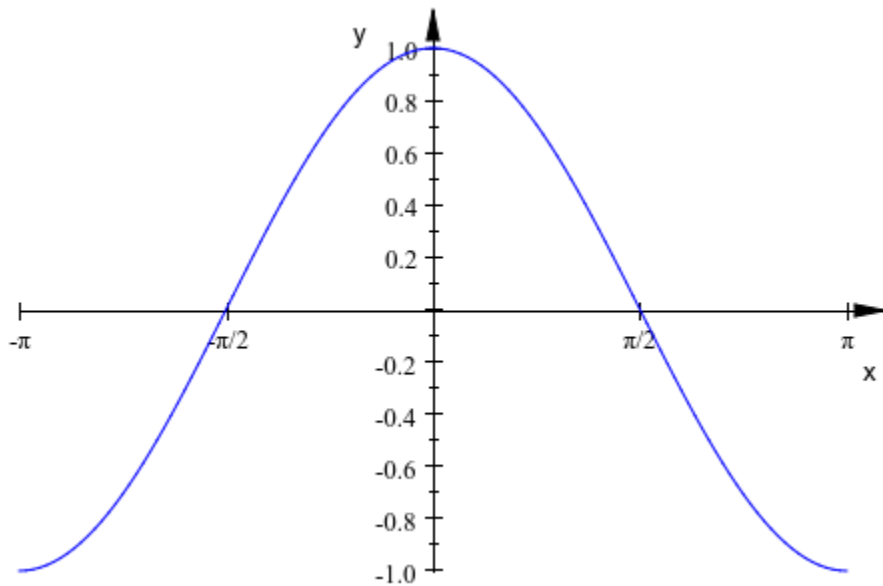

## Example 2

The Newton iteration  $x_{i+1} = x_i - \frac{f(x_i)}{f'(x_i)}$  finds successive approximations to a zero of a function  $f(x)$ . We switch the automatic ticks along the x-axis off via `XTicksNumber = None` and display some elements of the Newton sequence as tick marks:

```
f := x -> x^4/10 - 2:
x[0] := 4.12:
for i from 0 to 3 do
    x[i + 1] := x[i] - f(x[i])/f'(x[i]);
end_for:
plot(plot::Function2d(f(X), X = 1..4.5),
      plot::Line2d([x[i], f(x[i])], [x[i+1], 0],
                   Color = RGB::Black) $ i = 0..3,
      plot::Line2d([x[i], 0], [x[i], f(x[i])],
                   Color = RGB::Black,
                   LineStyle = Dashed) $ i = 0..4,
      XTicksNumber = None, XTicksAt = [x[i] $ i = 0..3])
```



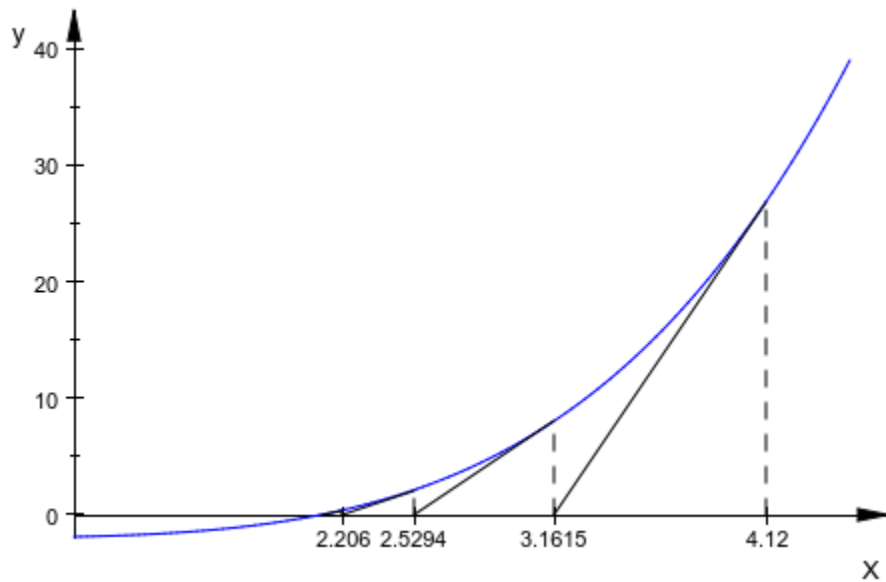

delete f, x, i:

## See Also

### MuPAD Functions

TicksAnchor | TicksBetween | TicksDistance | TicksLabelFont |  
TicksLabelStyle | TicksLabelsVisible | TicksLength | TicksNumber |  
TicksVisible

# TicksBetweenXTicksBetweenYTicksBetweenZTicksBetween

Number of minor (unlabeled) axes tick marks between major (labeled) axes tick marks

## Value Summary

TicksBetween	Library wrapper for “{XTicksBetween, YTicksBetween}” (2D), “{XTicksBetween, YTicksBetween, ZTicksBetween}” (3D)	Non-negative integer
XTicksBetween, YTicksBetween, ZTicksBetween	Inherited	Non-negative integer

## Graphics Primitives

Objects	Default Values
plot::CoordinateSystem2d	TicksBetween, XTicksBetween, YTicksBetween: 1
plot::CoordinateSystem3d	TicksBetween, XTicksBetween, YTicksBetween, ZTicksBetween: 1

## Description

The tick marks along the coordinate axes consist of “major” tick marks bearing labels and of “minor” tick marks without labels.

TicksBetween sets the number of minor ticks between each pair of major ticks for all coordinate axes.

With `XTicksBetween` etc., the number of minor ticks may be set separately for each single coordinate axis.

Per default between every two major tick marks one minor tick mark is rendered. Via `TicksBetween` this number can be increased or set to zero. In contrast to major tick marks, minor tick marks are never labelled.

Minor tick marks are rendered always with half the length of the major tick marks. Cf. `TicksLength`.

## Examples

### Example 1

We request few “major” tick marks in the x direction and place 9 “minor” tick marks between each pair. The ticks in y direction are chosen automatically:

```
plot(plot::Curve2d([u*cos(u*PI), u*sin(u*PI)], u = 0..2),  
      XTicksNumber = Low, XTicksBetween = 9)
```

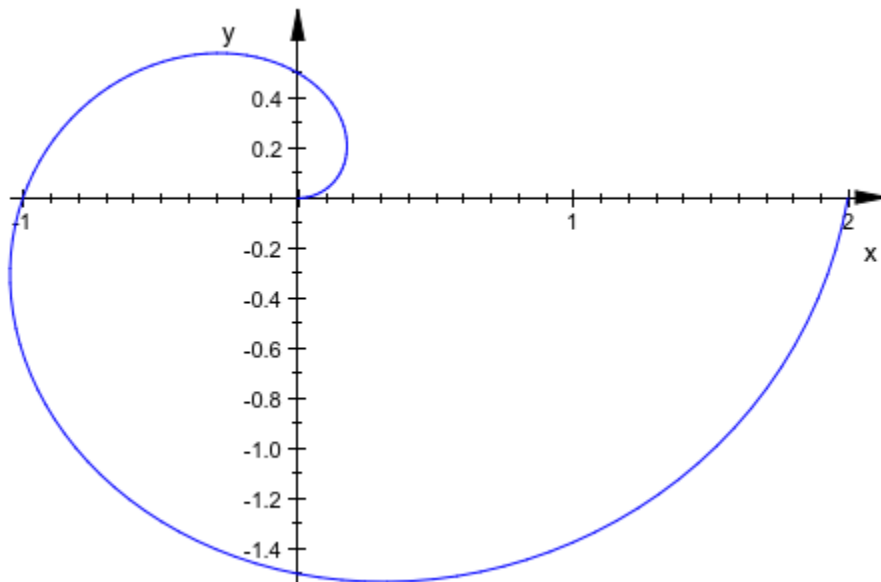

## Example 2

We request few “major” tick marks in all directions. In the horizontal directions, we place 4 “minor” tick marks between each pair. The ticks in  $z$  direction consist of the labeled ticks only:

```
plot(plot::Function3d(exp(-x^2 - y^2), x = -3..3, y = -3..3,  
                      Submesh = [2, 2]),  
      TicksNumber = Low, XTicksBetween = 4, YTicksBetween = 4,  
      ZTicksBetween = 0, GridVisible = TRUE)
```

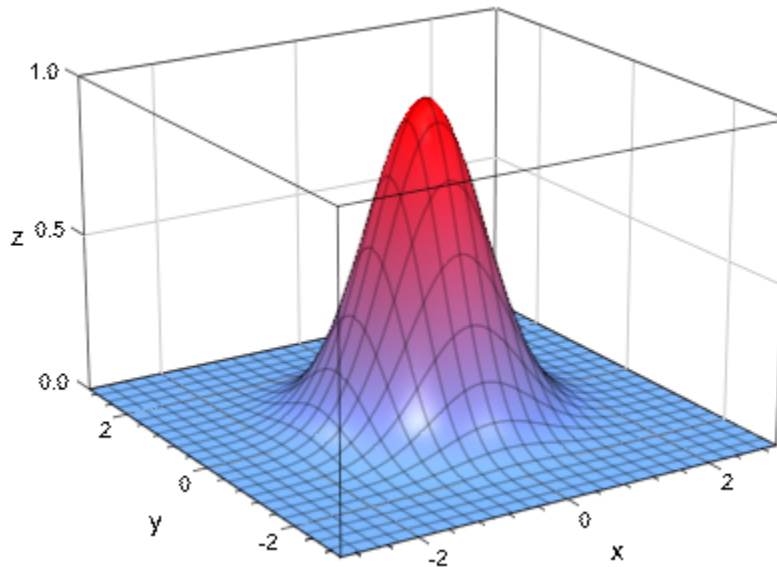

## See Also

### MuPAD Functions

[TicksAnchor](#) | [TicksAt](#) | [TicksDistance](#) | [TicksLabelFont](#) | [TicksLabelStyle](#) | [TicksLabelsVisible](#) | [TicksLength](#) | [TicksNumber](#) | [TicksVisible](#)

# TicksDistanceXTicksDistanceYTicksDistanceZTicksDistance

User defined axes tick mark distance

## Value Summary

TicksDistance	Library wrapper for “{XTicksDistance, YTicksDistance}” (2D), “{XTicksDistance, YTicksDistance, ZTicksDistance}” (3D)	MuPAD expression
XTicksDistance, YTicksDistance, ZTicksDistance	Optional	MuPAD expression

## Graphics Primitives

Objects	Default Values
plot::CoordinateSystem2d	TicksDistance, XTicksDistance, YTicksDistance: 0
plot::CoordinateSystem3d	TicksDistance, XTicksDistance, YTicksDistance, ZTicksDistance: 0

## Description

With  $\text{TicksAnchor} = t_0$ ,  $\text{TicksDistance} = d$ , the automatic ticks along the coordinate axes are switched off and replaced by equidistant ticks with distance  $d$  at the positions  $t_j = t_0 + jd, j \in \mathbb{Z}$ .

With  $\text{TicksAnchor} = t_0$ ,  $\text{TicksDistance} = d$ , these ticks are used for all coordinate axes.

With `XTicksAnchor = t0`, `XTicksDistance = d` etc., these ticks may be defined separately for each single coordinate axis.

When executing a plot command, per default a “reasonable” placing for tick marks on coordinate axes is automatically computed. Through this process tick marks may not come to lie on desired positions. The attributes `TicksAnchor` and `TicksDistance` allow to generate an alternative mesh of equidistant tick marks.

---

**Note** The attributes `TicksAnchor`, `XTicksAnchor` etc. only have an effect when a positive distance  $d > 0$  between major ticks marks is set explicitly via `TicksDistance = d`, `XTicksDistance = d` etc.

---

The ticks set by `TicksAnchor` and `TicksDistance` are “major” tick marks bearing labels. Depending on the value of `TicksBetween`, there may be additional “minor” ticks without labels between each pair of major tick marks.

Additional tick marks at specific positions can be inserted with `TicksAt`.

## Examples

### Example 1

For the following plot of the sine function, the tick marks along the x-axis are chosen to match the period:

```
plot(plot::Function2d(sin(x), x = 0..4*PI),  
      XTicksAnchor = 0, XTicksDistance = PI):
```

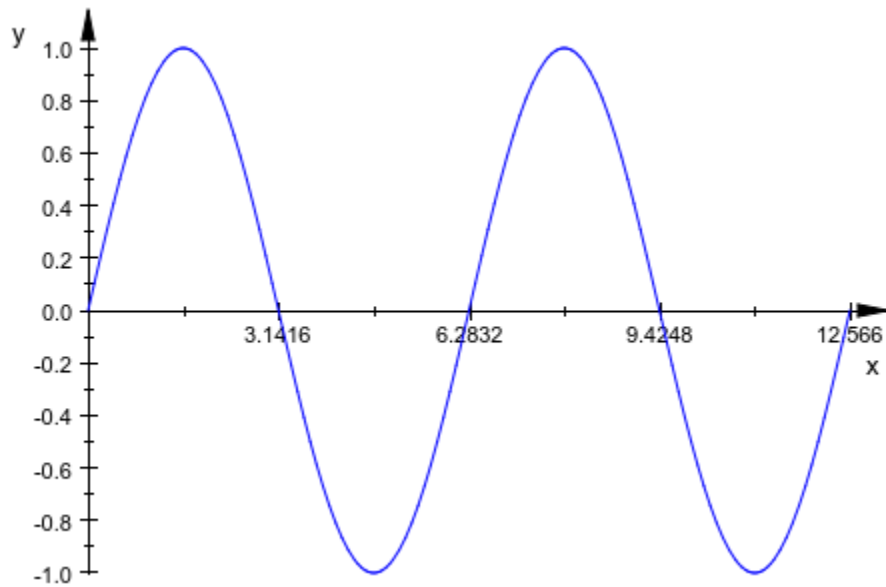

The ticks along the y-axis are re-defined with a distance of 0.2:

```
plot(plot::Function2d(sin(x), x = 0..4*PI),  
      XTicksAnchor = 0, XTicksDistance = PI,  
      YTicksAnchor = 0, YTicksDistance = 0.2):
```

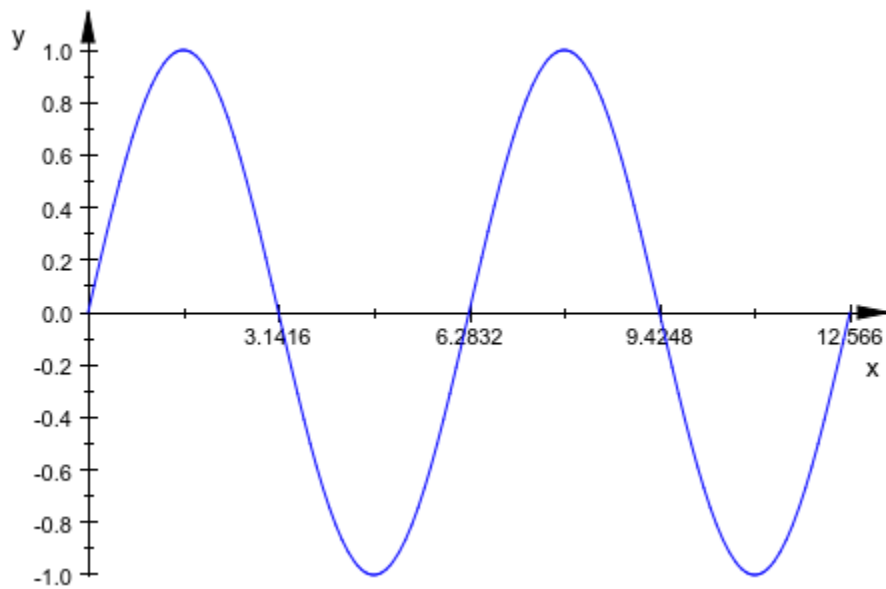

We increase the number of “minor” ticks along the x-axis:

```
plot(plot::Function2d(sin(x), x = 0..4*PI),  
      XTicksAnchor = 0, XTicksDistance = PI,  
      XTicksBetween = 4,  
      YTicksAnchor = 0, YTicksDistance = 0.2):
```



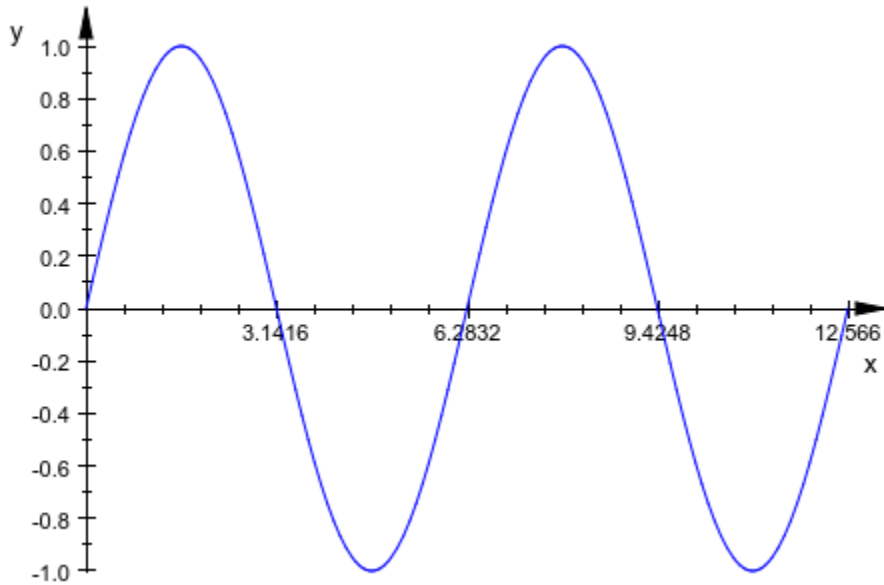

## Example 2

We plot a hyperbolic spiral about the point (1.07, 1.07) which is not included in the automatic tick marks. We increase the number of ticks along the vertical axis and position the ticks relative to this point. Note that the tick marks along the horizontal axis miss the center of the spiral:

```
plot(plot::Point2d(1.07, 1.07),
      plot::Curve2d([1.07 - cos(t)/t, 1.07 + sin(t)/t],
                    t = 2*PI..50*PI, Submesh = 20),
      YTicksDistance = 0.025, YTicksAnchor = 1.07)
```

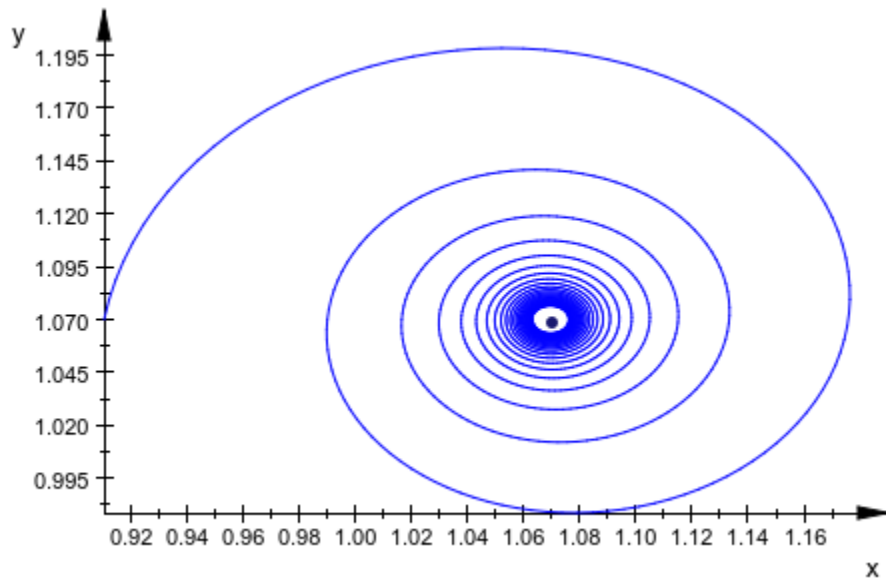

### Example 3

We plot the two-dimensional normal distribution centered around the mean  $(m_1, m_2) = (3.2, 4.9)$ . This point is used as the anchor for the tick marks along the  $x$ -axis and the  $y$ -axis, respectively. Ticks are positioned at distances that are integer multiples of the standard deviations  $(s_1, s_2) = (0.8, 1.2)$ :

```
m1:= 3.2: s1 := 0.8:
m2:= 4.9: s2 := 1.2:
plot(plot::Function3d( stats::normalPDF(m1, s1^2)(x)
                      *stats::normalPDF(m2, s2^2)(y),
                      x = 0 .. 10, y = 0 .. 10,
                      Submesh = [3, 3]),
      XTicksAnchor = m1, XTicksDistance = s1,
      YTicksAnchor = m2, YTicksDistance = s2,
      TicksBetween = 0, GridVisible = TRUE):
```

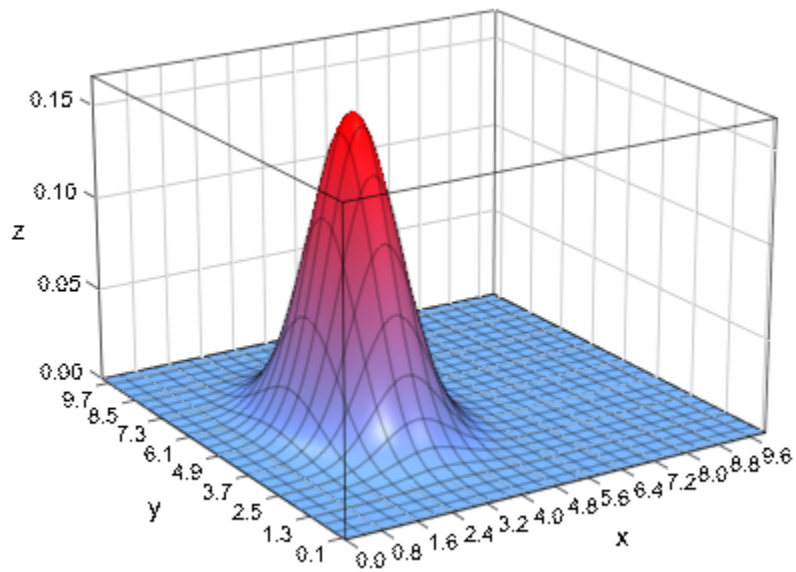

```
delete m1, s1, m2, s2:
```

## See Also

### MuPAD Functions

TicksAnchor | TicksAt | TicksBetween | TicksLabelFont | TicksLabelStyle |  
TicksLabelsVisible | TicksLength | TicksNumber | TicksVisible

# TicksLabelStyleXTicksLabelStyleYTicksLabelStyleZTicksLabelStyle

Display style of axes tick labels

## Value Summary

TicksLabelStyle	Library wrapper for “{XTicksLabelStyle, YTicksLabelStyle}” (2D), “{XTicksLabelStyle, YTicksLabelStyle, ZTicksLabelStyle}” (3D)	See below
XTicksLabelStyle, YTicksLabelStyle, ZTicksLabelStyle	Inherited	Diagonal, Horizontal, Shifted, or Vertical

## Graphics Primitives

Objects	Default Values
plot::CoordinateSystem2d	TicksLabelStyle, XTicksLabelStyle, YTicksLabelStyle: Horizontal
plot::CoordinateSystem3d	TicksLabelStyle, XTicksLabelStyle, YTicksLabelStyle, ZTicksLabelStyle: Horizontal

## Description

TicksLabelStyle allows to modify the display style of the tick labels on all coordinate axes.

XTicksLabelStyle etc. allow to set the label styles separately for each single coordinate axis.

It may occur that tick labels overlap if too many tick marks along the coordinate axes are requested. The following styles for the tick labels are available to deal with this problem:

**Horizontal:** The labels are displayed in the usual horizontal reading order from left to right.

**Vertical:** The labels are tilted 90 degrees counter clockwise, i.e., they have to be read from bottom to top.

**Diagonal:** The labels are tilted 45 degrees counter clockwise.

**Shifted:** Each second label is shifted to avoid overlapping.

Note that also in 3D the orientation **Horizontal**, **Diagonal**, **Vertical** refers to the screen output irrespectively of the 3D orientation of the corresponding axis.

TicksLabelStyle sets the display style for the ticks labels along *all* coordinate axes.

With XTicksLabelStyle etc. the style may be set separately for each single axis.

Independently from TicksLabelStyle, the titles of the axes are rendered horizontally. In 2D, the attribute YAxisTitleOrientation is available to tilt the title of the vertical axis by 90 degrees.

## Examples

### Example 1

We demonstrate the styles for the ticks labels:

```
f := plot::Function2d(sin(x), x = 0 .. 2*PI):
S1 := plot::Scene2d(f, TicksLabelStyle = Horizontal):
S2 := plot::Scene2d(f, TicksLabelStyle = Vertical):
S3 := plot::Scene2d(f, TicksLabelStyle = Diagonal):
S4 := plot::Scene2d(f, TicksLabelStyle = Shifted):
plot(S1, S2, S3, S4, Height = 10*unit::cm,
      Width = 10*unit::cm):
```

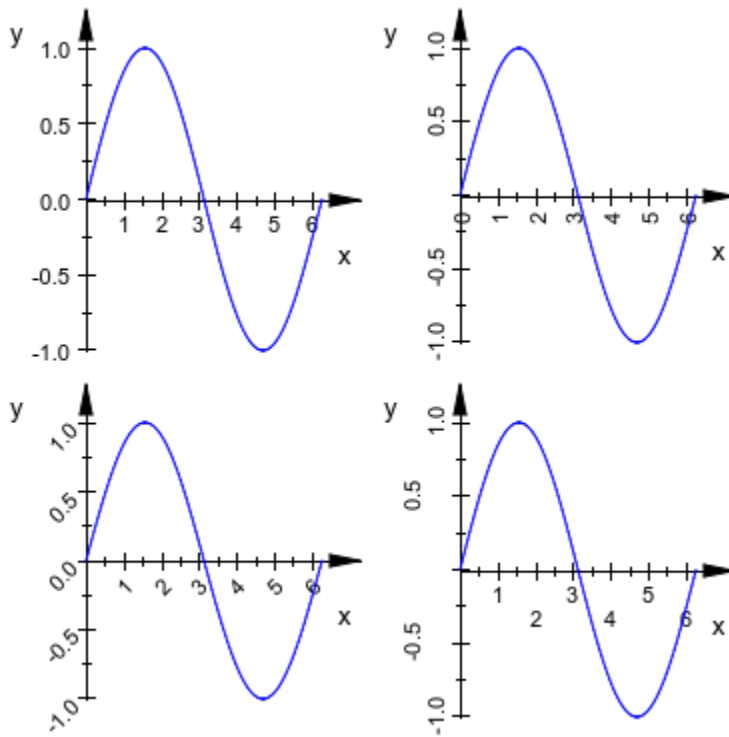

Here is a corresponding picture in 3D:

```
f := plot::Function3d(exp(-x^2 - y^2), x = -3..3,
                      y = -3..3, Submesh = [2, 2]):
S1 := plot::Scene3d(f, TicksLabelStyle = Horizontal):
S2 := plot::Scene3d(f, TicksLabelStyle = Vertical):
S3 := plot::Scene3d(f, TicksLabelStyle = Diagonal):
S4 := plot::Scene3d(f, TicksLabelStyle = Shifted):
plot(S1, S2, S3, S4, Height = 10*unit::cm,
     Width = 10*unit::cm):
```

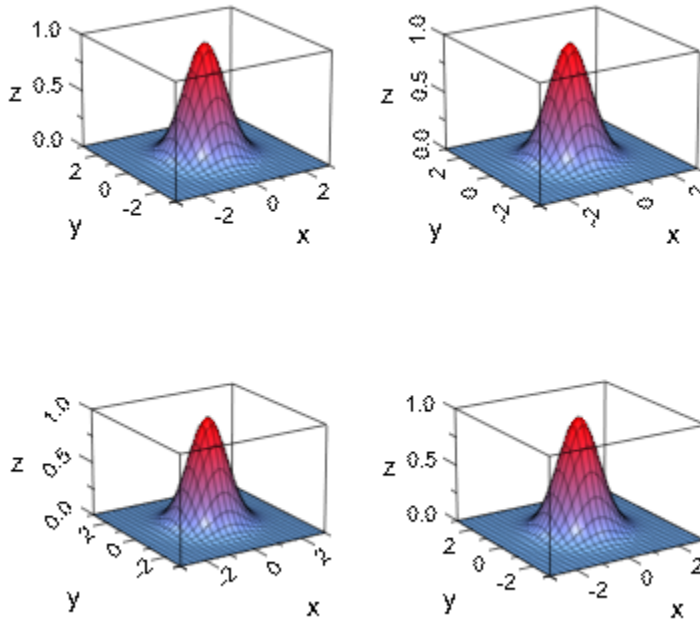

delete f, S1, S2, S3, S4:

## Example 2

The tick labels along the x-axis nearly collide in the following plot:

```
f := plot::Function2d(exp(30*x)*sin(x*100*PI),
                      x = 10.04 .. 10.05):
plot(f, GridVisible = TRUE, XTicksNumber = High):
```

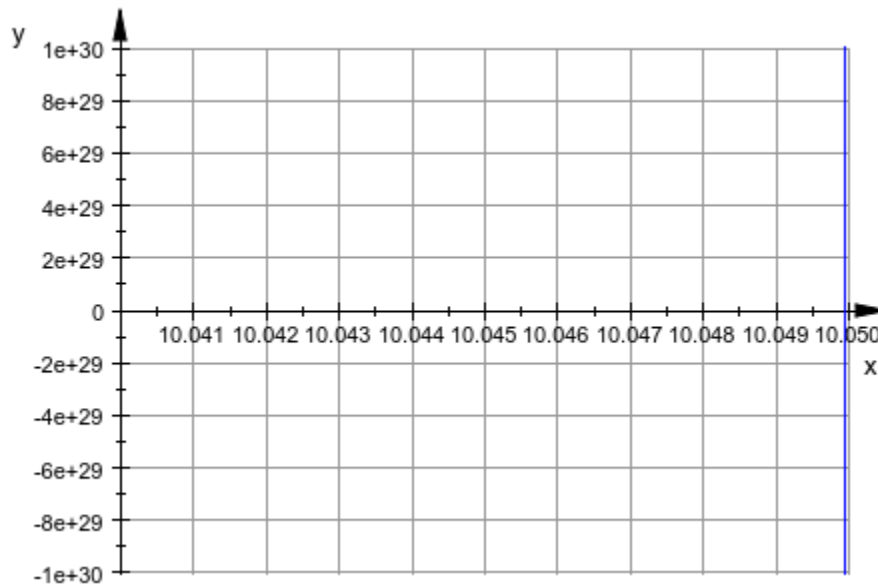

Tilting the labels yields a more tidy looking graphics:

```
plot(f, GridVisible = TRUE, XTicksNumber = High,  
     XTicksLabelStyle = Diagonal):
```



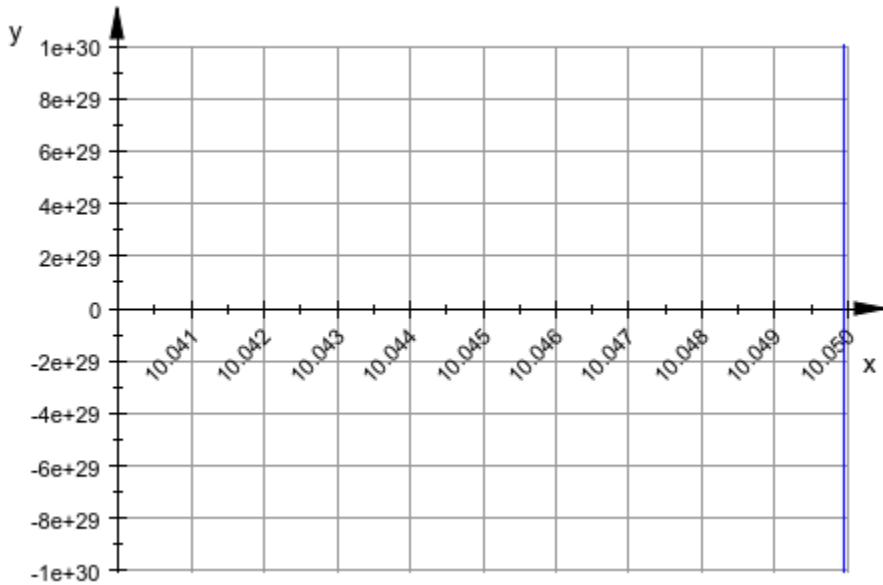

### Example 3

In the following graphics, there is not enough space to squeeze in the requested high number of ticks in the x and y direction:

```
plot(plot::Function3d(exp(-x^2 - y^2), x = -2..2, y = -2..2,
    Submesh = [2, 2]),
    TicksNumber = High,
    AxesTitles = ["North <--> South",
        "East <--> West",
        "Heaven <--> Earth"]):
```

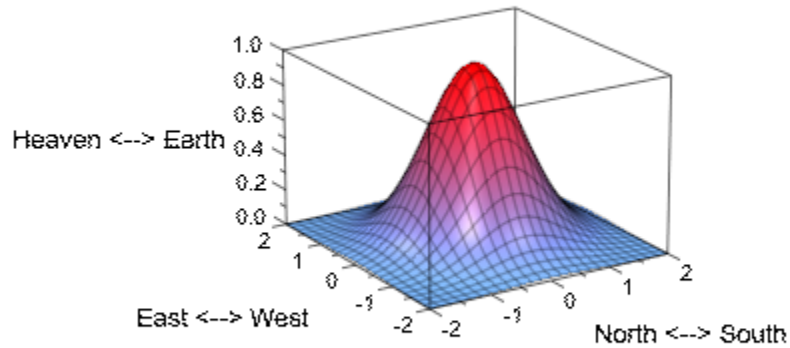

The tick labels fit with Vertical and Diagonal orientation:

```
plot(plot::Function3d(exp(-x^2 - y^2), x = -2..2, y = -2..2,  
    Submesh = [2, 2]),  
    TicksNumber = High,  
    XTicksLabelStyle = Vertical,  
    YTicksLabelStyle = Diagonal,  
    ZTicksLabelStyle = Horizontal,  
    AxesTitles = ["North <--> South",  
        "East <--> West",  
        "Heaven <--> Earth"]):
```

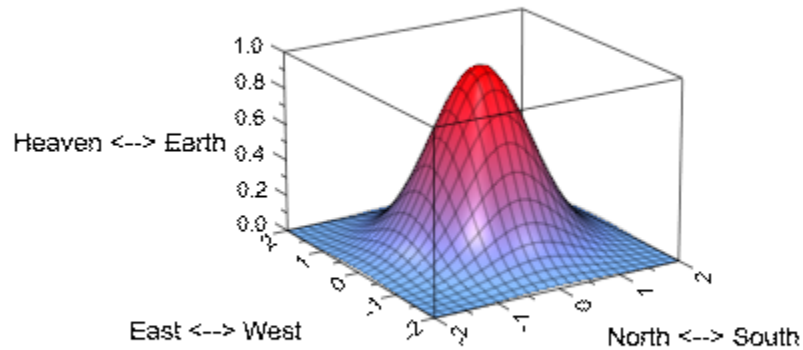

## See Also

### MuPAD Functions

[TicksAnchor](#) | [TicksAt](#) | [TicksBetween](#) | [TicksDistance](#) | [TicksLabelFont](#) | [TicksLabelsVisible](#) | [TicksLength](#) | [TicksNumber](#) | [TicksVisible](#)

## TicksLength

Length of axes tick marks

### Value Summary

Inherited	Positive output size
-----------	----------------------

### Graphics Primitives

Objects	TicksLength Default Values
plot::CoordinateSystem2d, plot::CoordinateSystem3d	2

### Description

The tick marks along the coordinate axes consist of “major” tick marks bearing labels and of “minor” tick marks without labels.

TicksLength sets the length for the major tick marks on all coordinate axes. The length of minor tick marks (cf. TicksBetween) is half of TicksLength .

The value should be specified as an absolute physical length including a length unit on page 1-2196 such as `TicksLength = 2.5*unit::mm`. Numbers without a physical unit give the length in mm.

TicksLength sets the length of automatic tick marks (cf. TicksNumber) as well of special tick marks set via TicksAt.

It is not possible to change the length of tick marks on any single axis alone.

## Examples

### Example 1

We plot the density of the standard normal distribution. Compared to the default length of 2 mm, the ticks length is increased by 50%:

```
plot(plot::Function2d(stats::normalPDF(0, 1)(x), x = -4..4),  
      TicksLength = 3*unit::mm):
```

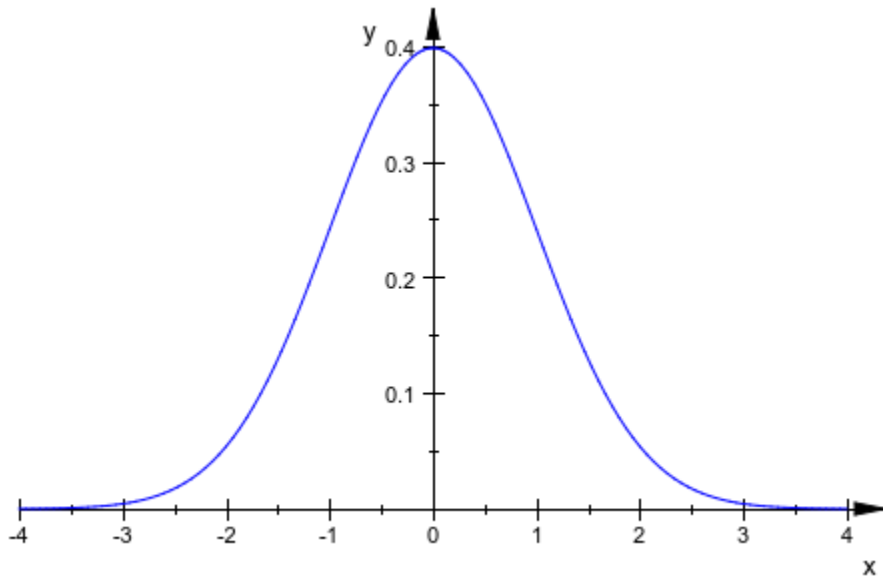

A corresponding plot in 3D:

```
plot(plot::Function3d(exp(-x^2 - y^2), x = -3..3, y = -3..3,  
                      Submesh = [2, 2]),  
      TicksLength = 3*unit::mm)
```

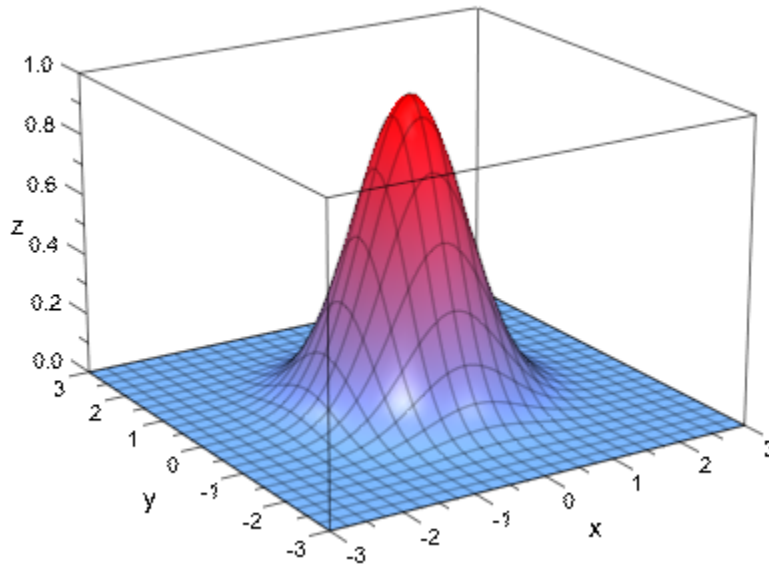

## Example 2

In the following plot of the sine function, we switch the automatic tick marks along the x-axis off via `XTicksNumber = None`. Some extra ticks are set via `XTicksAt`:

```
plot(plot::Function2d(sin(x), x = 0 .. PI),  
      XTicksAt = [0 = "0", PI/2 = "p/2", PI = "p"],  
      XTicksNumber = None, TicksLength = 4*unit::mm,  
      TicksLabelFont = ["Symbol"], YAxisVisible = FALSE)
```

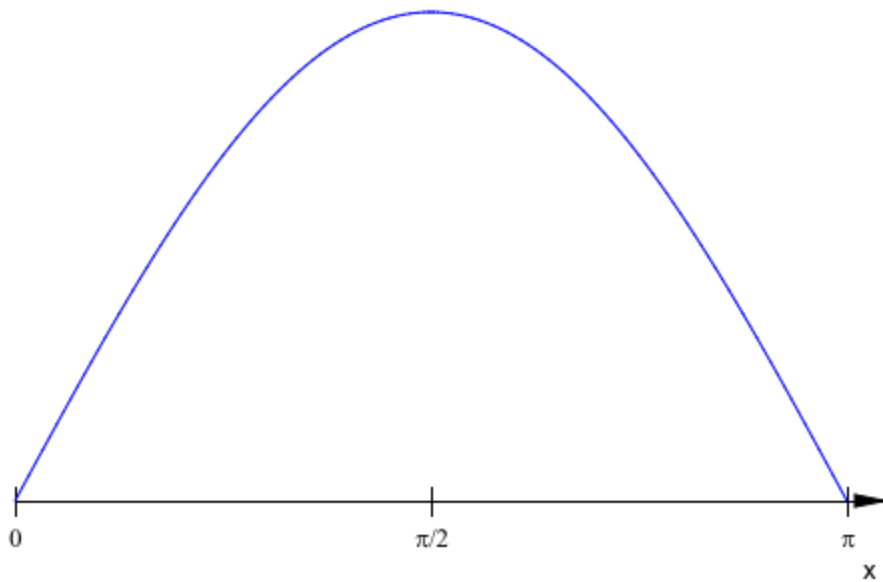

## See Also

### MuPAD Functions

[TicksAnchor](#) | [TicksAt](#) | [TicksBetween](#) | [TicksDistance](#) | [TicksLabelFont](#) | [TicksLabelStyle](#) | [TicksLabelsVisible](#) | [TicksNumber](#) | [TicksVisible](#)

## TicksNumber XTicksNumber YTicksNumber ZTicksNumber

Number of axes tick marks

### Value Summary

TicksNumber	Library wrapper for “{XTicksNumber, YTicksNumber}” (2D), “{XTicksNumber, YTicksNumber, ZTicksNumber}” (3D)	See below
XTicksNumber, YTicksNumber, ZTicksNumber	Inherited	High, Low, None, or Normal

### Graphics Primitives

Objects	Default Values
plot::CoordinateSystem2d	TicksNumber, XTicksNumber, YTicksNumber: Normal
plot::CoordinateSystem3d	TicksNumber, XTicksNumber, YTicksNumber, ZTicksNumber: Normal

### Description

TicksNumber directs the internal routine that chooses tick marks along coordinate axes to produce no, few, or many ticks.

With XTicksNumber etc., the number of tick marks can be controlled separately for each single axis.



The tick marks along the coordinate axes consist of “major” tick marks bearing labels and of “minor” tick marks without labels.

The attributes `TicksNumber`, `XTicksNumber` etc. only refer to the labeled “major” tick marks. The “minor” tick marks are governed by the attribute `TicksBetween`.

Automatically generated equidistant tick marks are displayed along the coordinate axes, unless the user specifies the ticks explicitly via the attributes `TicksAnchor` and `TicksDistance`.

`TicksNumber` provides a hint for the automatic computation process, how many tick marks are to be displayed. The possible values are `None`, `Low`, `Normal`, and `Many`.

With `XTicksNumber` etc., ticks numbers may be controlled separately for each single axis.

If equidistant tick marks are set explicitly via `TicksAnchor` and `TicksDistance`, the attributes `TicksNumber`, `XTicksNumber` etc. are ignored.

There is no influence on special tick marks set via `TicksAt`, `XTicksAt` etc. either.

With `TicksNumber = None`, `XTicksNumber = None` etc., no automatically generated tick marks are displayed.

Tick marks may also be suppressed via `TicksVisible = FALSE`, `XTicksVisible = FALSE` etc. However, in contrast to `TicksNumber = None`, `XTicksNumber = None` etc., this also suppresses equidistant tick marks set explicitly via `TicksAnchor`, `TicksDistance` as well as special tick marks set via `TicksAt`, `XTicksAt` etc.

## Examples

### Example 1

We demonstrate the effect of various `TicksNumber` values:

```
f := plot::Function2d(sinh(x), x = -5 .. 5):
S1 := plot::Scene2d(f, TicksNumber = None):
S2 := plot::Scene2d(f, TicksNumber = Low):
S3 := plot::Scene2d(f, TicksNumber = Normal):
S4 := plot::Scene2d(f, TicksNumber = High):
plot(S1, S2, S3, S4):
```

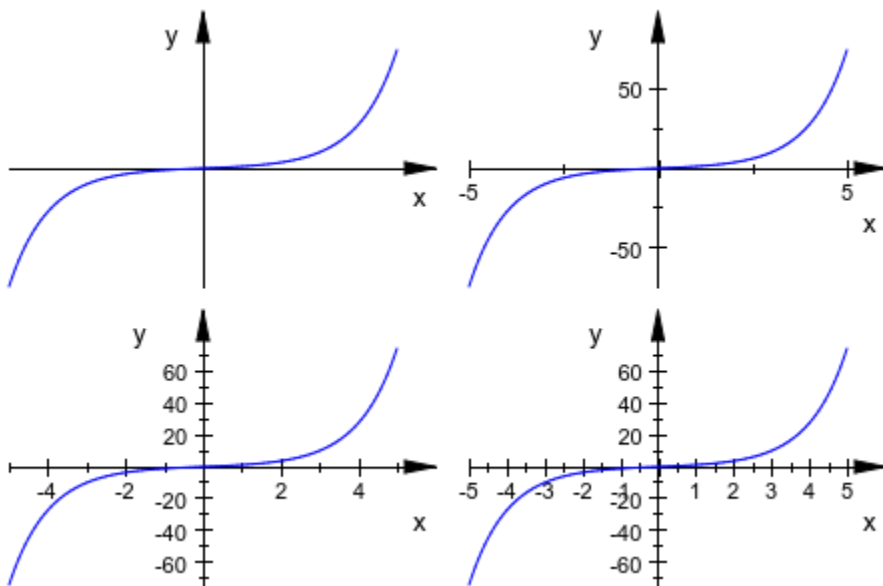

```
delete f, S1, S2, S3, S4:
```

## Example 2

We demonstrate the effect of various `TicksNumber` values in a 3D plot:

```
s := plot::Function3d(x^2 + y^2, x = -1..1, y = -2..2):
plot(s):
```

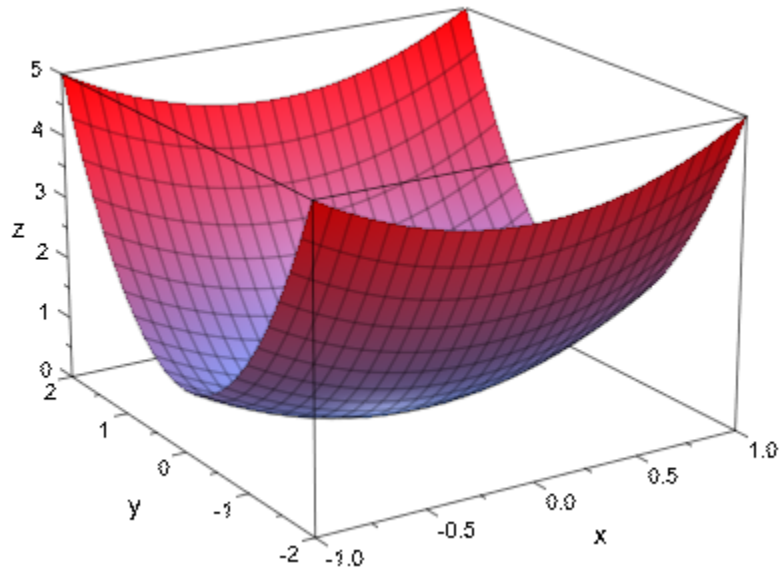

```
plot(s, XTicksNumber = High, YTicksNumber = Normal,  
      ZTicksNumber = Low):
```

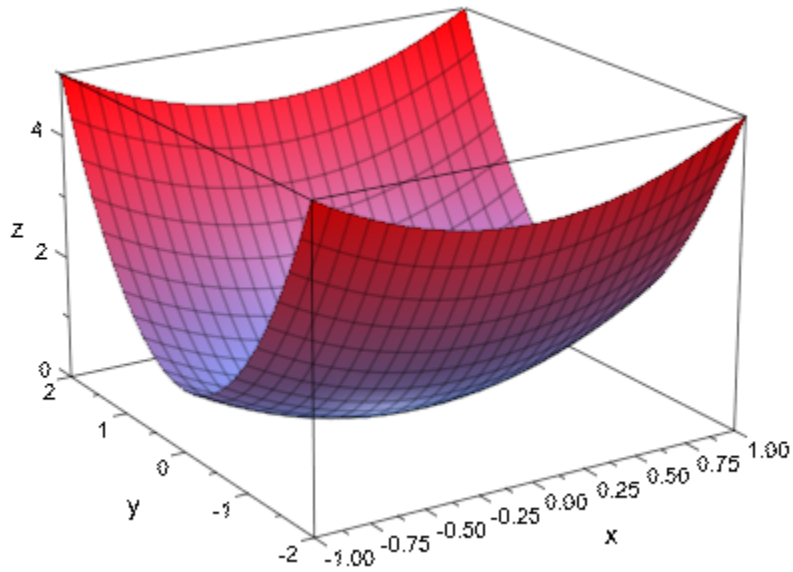

All tick marks are suppressed:

```
plot(s, TicksNumber = None)
```

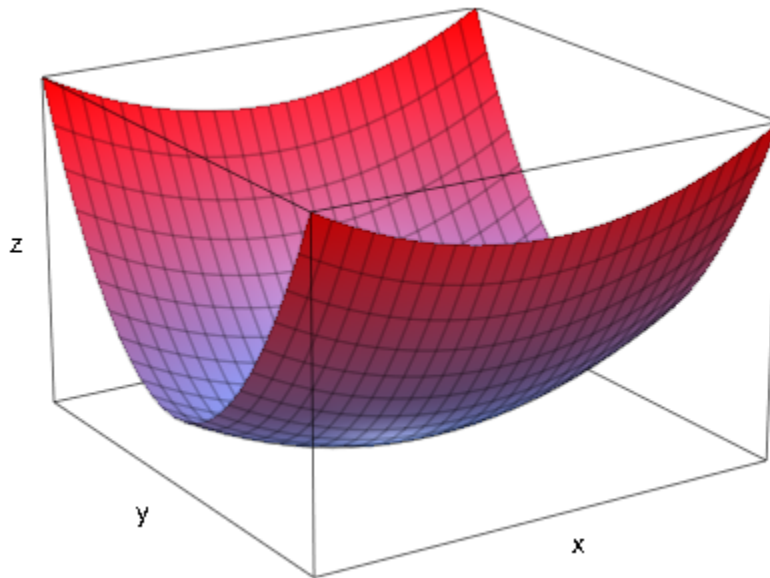

delete s:

## See Also

### MuPAD Functions

TicksAnchor | TicksAt | TicksBetween | TicksDistance | TicksLabelFont |  
TicksLabelStyle | TicksLabelsVisible | TicksLength | TicksVisible

## TicksVisible XTicksVisible YTicksVisible ZTicksVisible

Display axes tick marks?

### Value Summary

TicksVisible	Library wrapper for “{XTicksVisible, YTicksVisible}” (2D), “{XTicksVisible, YTicksVisible, ZTicksVisible}” (3D)	TRUE, FALSE, or list of 2 or 3 of these, depending on the dimension
XTicksVisible, YTicksVisible, ZTicksVisible	Inherited	FALSE, or TRUE

### Graphics Primitives

Objects	Default Values
plot::CoordinateSystem2d	TicksVisible, XTicksVisible, YTicksVisible: TRUE
plot::CoordinateSystem3d	TicksVisible, XTicksVisible, YTicksVisible, ZTicksVisible: TRUE

### Description

TicksVisible = TRUE versus TicksVisible = FALSE switches tick marks along all coordinate axes on or off.

With XTicksVisible = TRUE/FALSE etc., the tick marks can be switched on or off separately for each single axis.

With `TicksVisible = FALSE`, the tick marks along all coordinate axes are switched off. The labels of the tick marks, however, remain visible.

`TicksVisible` etc. refers to automatically generated tick marks (cf. `TicksNumber`), to equidistant tick marks that are requested explicitly via `TicksAnchor`, `TicksDistance` as well as to special tick marks set via `TicksAt`.

Ticks can also be suppressed via `TicksNumber = None`, `XTicksNumber = None` etc. In contrast to `TicksVisible = FALSE`, however, this affects only the automatically generated ticks and their labels. Ticks set by `TicksAnchor`, `TicksDistance`, `TicksAt` are not affected.

## Examples

### Example 1

Visualizing that the sine function is nearly linear near its zeroes, we suppress the automatic tick marks along the x-axis via `XTicksNumber = None`. Three special ticks are set via `XTicksAt`:

```
f := plot::Function2d(sin(x), x = 3.0 .. 3.3):  
plot(f, XTicksNumber = None, XTicksAt = [3.1, PI = "p", 3.2],  
      TicksLabelFont = ["Symbol"])
```

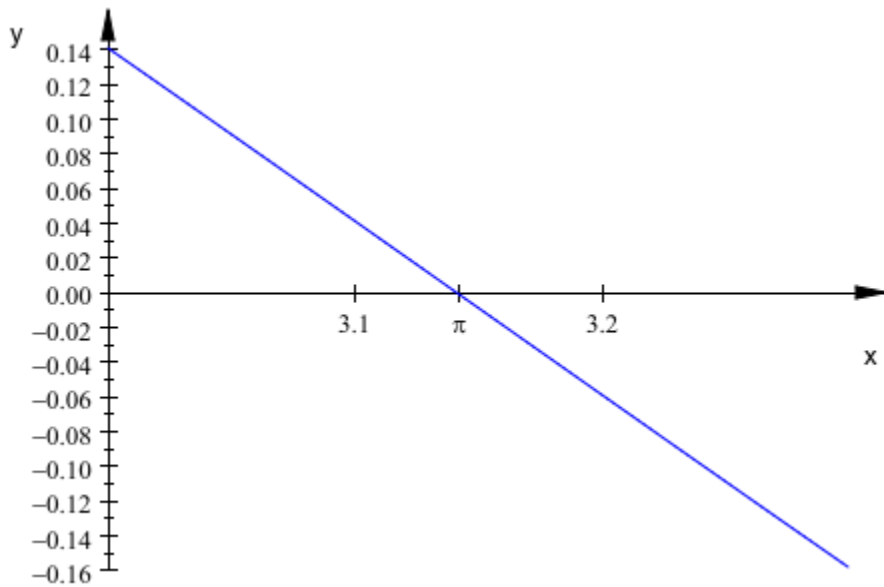

The tick marks along the x-axis are switched off:

```
plot(f, XTicksNumber = None, XTicksAt = [3.1, PI = "p", 3.2],  
     TicksLabelFont = ["Symbol"], XTicksVisible = FALSE)
```



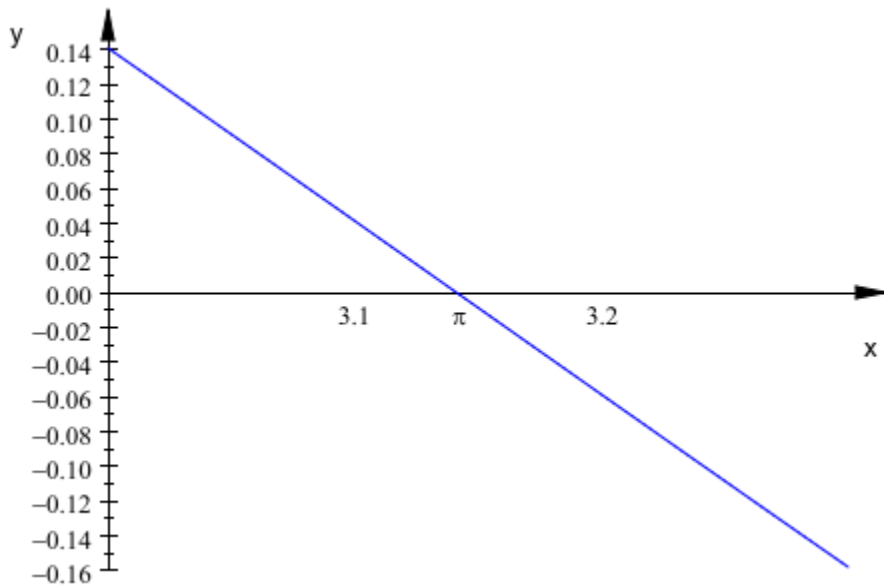

The labels of the ticks are switched off, too:

```
plot(f, XTicksNumber = None, XTicksAt = [3.1, PI = "p", 3.2],  
      TicksLabelFont = ["Symbol"], XTicksVisible = FALSE,  
      XTicksLabelsVisible = FALSE)
```

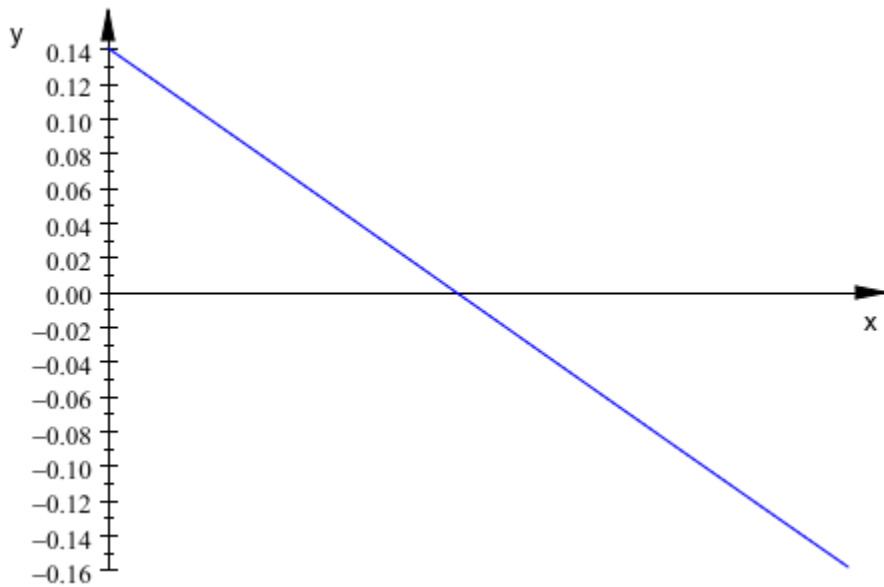

delete f:

## See Also

### MuPAD Functions

[TicksAnchor](#) | [TicksAt](#) | [TicksBetween](#) | [TicksDistance](#) | [TicksLabelFont](#) | [TicksLabelStyle](#) | [TicksLabelsVisible](#) | [TicksLength](#) | [TicksNumber](#)

# TicksLabelsVisibleXTicksLabelsVisibleY TicksLabelsVisibleZTicksLabelsVisible

Display axes tick labels?

## Value Summary

TicksLabelsVisible	Library wrapper for “{XTicksLabelsVisible, YTicksLabelsVisible}” (2D), “{XTicksLabelsVisible, YTicksLabelsVisible, ZTicksLabelsVisible}” (3D)	See below
XTicksLabelsVisible, YTicksLabelsVisible, ZTicksLabelsVisible	Inherited	FALSE, or TRUE

## Graphics Primitives

Objects	Default Values
plot::CoordinateSystem2d	TicksLabelsVisible, XTicksLabelsVisible, YTicksLabelsVisible: TRUE
plot::CoordinateSystem3d	TicksLabelsVisible, XTicksLabelsVisible, YTicksLabelsVisible, ZTicksLabelsVisible: TRUE

## Description

TicksLabelsVisible = TRUE versus TicksLabelsVisible = FALSE switches the labeling of the tick marks along all coordinate axes on or off.

With TicksLabelsVisible = FALSE, the labeling of the tick marks along all coordinate axes is switched off. The tick marks themselves, however, remain visible. They are switched off via TicksVisible = FALSE.

With XTicksLabelsVisible = TRUE/FALSE etc., the tick labeling can be switched on or off separately for each single axis.

TicksLabelsVisible, XTicksLabelsVisible etc. refer to automatically generated tick marks (cf. TicksNumber), to equidistant tick marks that are requested explicitly via TicksAnchor, TicksDistance as well as to special tick marks set via TicksAt.

Ticks can also be suppressed via TicksNumber = None, XTicksNumber = None etc. In contrast to TicksLabelsVisible = FALSE, however, this affects only the automatically generated ticks and their labels. Ticks set by TicksAnchor, TicksDistance, TicksAt are not affected.

## Examples

### Example 1

We approximate the cosine function by a fourth order polynomial (a Taylor polynomial around the expansion point 0). The automatic tick marks along the x-axis are suppressed via XTicksNumber = None. Some special tick marks including the zero of the cosine

function at  $x = \frac{\pi}{2}$  are inserted via XTicksAt:

```
f1 := plot::Function2d(cos(x), x = 0..2):
f2 := plot::Function2d(1 - x^2 + x^4/4!, x = 0..2,
                      LineColor = RGB::Blue):
plot(f1, f2, XTicksNumber = None,
     XTicksAt = [1, PI/2 = "p/2", 2],
     TicksLabelFont = ["Symbol"])
```

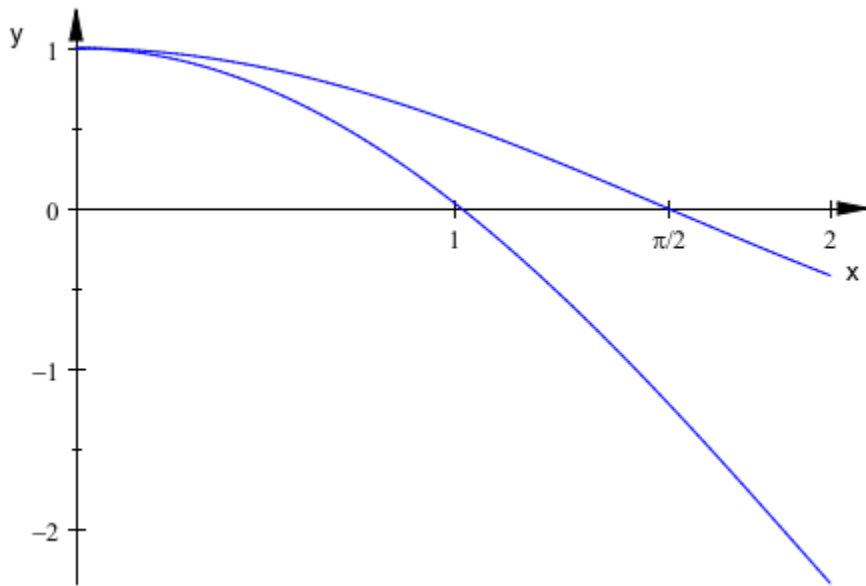

The labeling of the tick marks along the x-axis is switched off:

```
plot(f1, f2, XTicksNumber = None,  
     XTicksAt = [1, PI/2 = "p/2", 2],  
     TicksLabelFont = ["Symbol"],  
     XTicksLabelsVisible = FALSE)
```

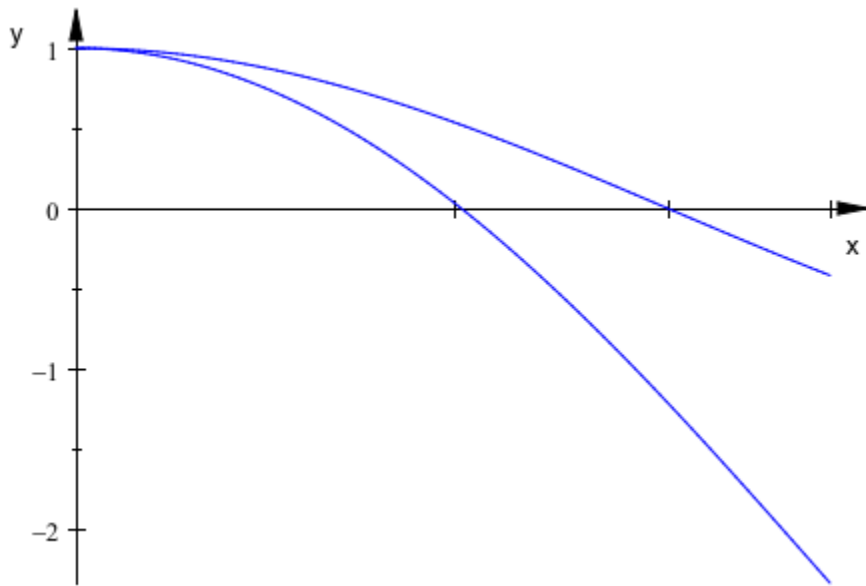

The ticks themselves are switched off, too:

```
plot(f1, f2, XTicksNumber = None,  
      XTicksAt = [1, PI/2 = "p/2", 2],  
      TicksLabelFont = ["Symbol"], XTicksLabelsVisible = FALSE,  
      XTicksVisible = FALSE)
```

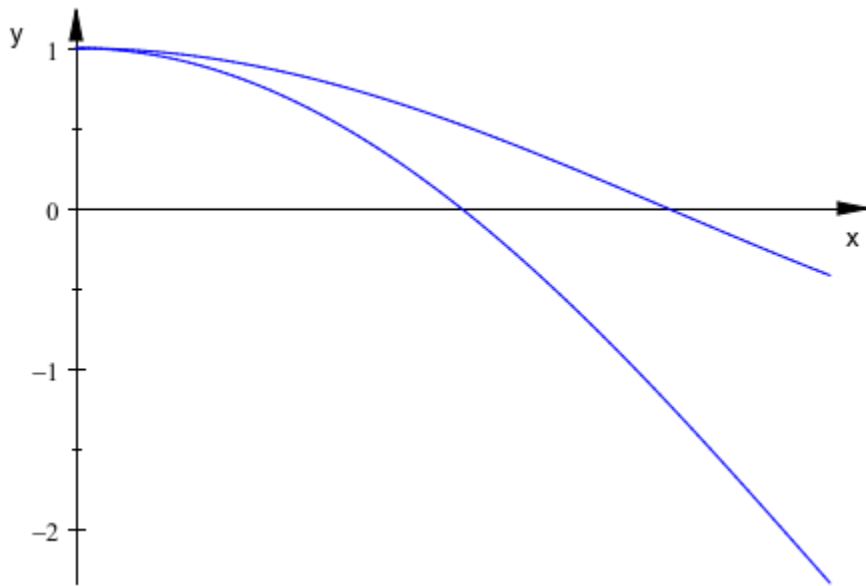

delete f1, f2:

## See Also

### MuPAD Functions

[TicksAnchor](#) | [TicksAt](#) | [TicksBetween](#) | [TicksDistance](#) | [TicksLabelFont](#) | [TicksLabelStyle](#) | [TicksLength](#) | [TicksNumber](#) | [TicksVisible](#)

## GridInFront

Coordinate grid in front of or behind graphical objects?

### Value Summary

Inherited	FALSE, or TRUE
-----------	----------------

### Graphics Primitives

Objects	GridInFront Default Values
plot::CoordinateSystem2d	FALSE

### Description

GridInFront = TRUE versus GridInFront = FALSE places 2D coordinate lines in front of or behind the graphical objects in the scene.

Setting GridVisible = TRUE, SubgridVisible = TRUE, one can display a coordinate grid extending the tick marks on the coordinate axes. See the help page of GridVisible for further information.

By default, the lines of the coordinate grid are plotted behind the graphical objects in a scene. Consequently, the objects may cover the coordinate grid. If only line objects and points are present in a 2D scene, this is desirable in most cases.

However, if there are filled areas such as filled polygons in the scene, the view to the coordinate grid may be totally blocked. In such a situation, you may want to draw the grid lines in front of the objects to guarantee visibility of the coordinate grid.

Although the default setting is GridInFront = FALSE, some objects which create filled areas send GridInFront = TRUE as a “hint” (see the section Primitives Requesting Special Scene Attributes: “Hints” (Symbolic Math Toolbox) of this documentation).

This attribute is available only in 2D.



## Examples

### Example 1

It is usually desirable to let line objects and points cover the coordinate grid:

```
p1 := plot::Point2d(0.5, 0.5, PointSize = 3*unit::mm,
                    Color = RGB::Green):
p2 := plot::Point2d(0.5, 1.0, PointSize = 3*unit::mm,
                    Color = RGB::Green):
f1 := plot::Function2d(cos(x*PI), x = -1 .. 1,
                      Color = RGB::Blue):
f2 := plot::Function2d(sin(x*PI), x = -1 .. 1, Color = RGB::Red):
plot(plot::Scene2d(p1, p2, f1, f2,
                  AxesInFront = FALSE, GridInFront = FALSE),
     plot::Scene2d(p1, p2, f1, f2,
                  AxesInFront = TRUE, GridInFront = TRUE),
     GridVisible = TRUE, SubgridVisible = TRUE):
```

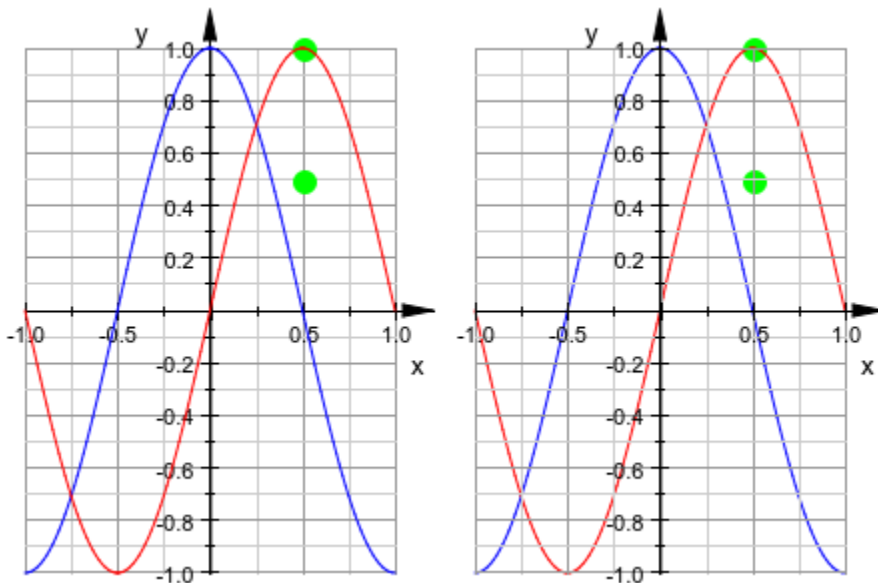

However, you probably want to have the coordinate grid visible in front of the following density plot:

```
d := plot::Density(exp(-x^2 - y^2), x = -1..1, y = -1..1,
                  FillColor = RGB::Blue);
plot(
  plot::Scene2d(d, AxesInFront = FALSE, GridInFront = FALSE),
  plot::Scene2d(d, AxesInFront = TRUE, GridInFront = TRUE),
  GridVisible = TRUE, SubgridVisible = TRUE,
  Layout = Horizontal
):
```

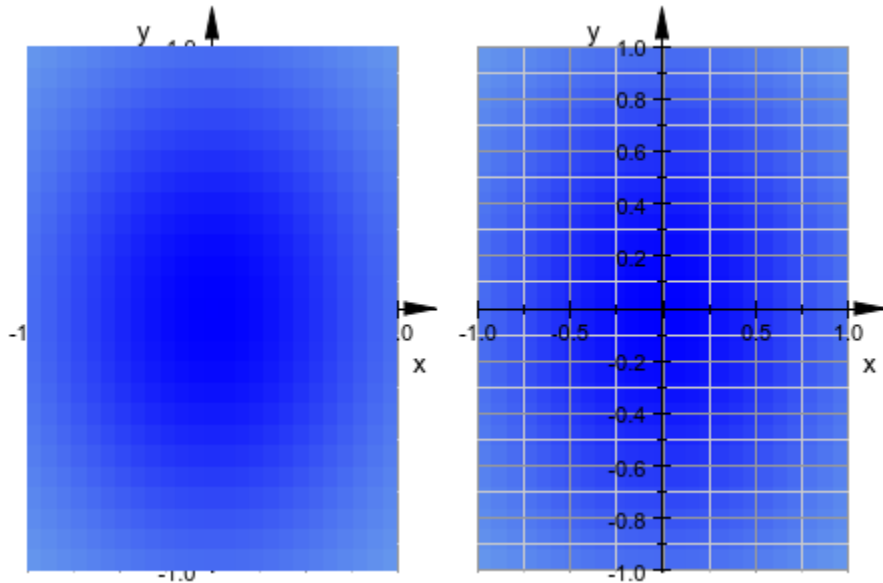

Note that density objects of type `plot::Density` automatically send the “hint” (Symbolic Math Toolbox) `GridInFront = TRUE`, so there is no need to set this attribute explicitly:

```
plot(d, GridVisible = TRUE, SubgridVisible = TRUE):
```

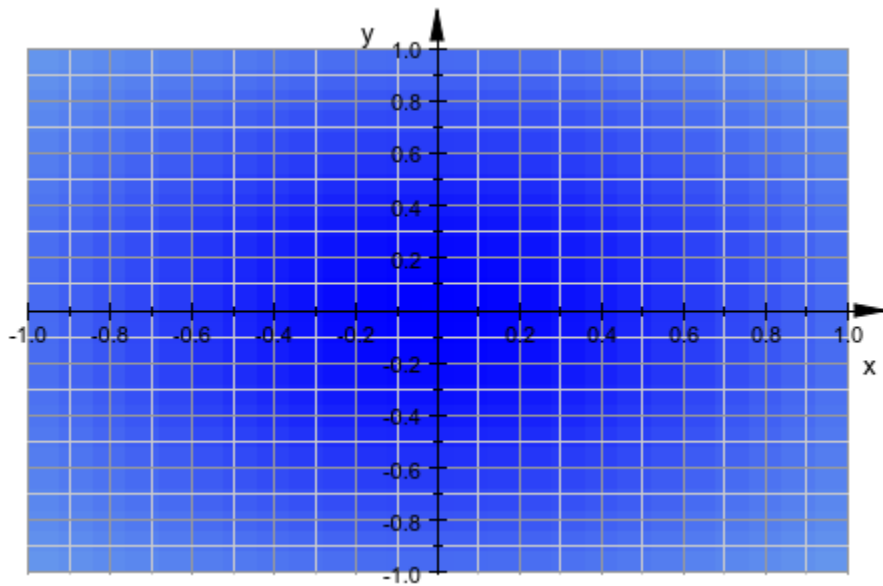

`delete p1, p2, f1, f2, d:`

## See Also

### MuPAD Functions

[GridLineColor](#) | [GridLineStyle](#) | [GridLineWidth](#) | [GridVisible](#)

## GridLineColorSubgridLineColor

Line color of the coordinate grid

### Value Summary

GridLineColor, SubgridLineColor	Inherited	Color
------------------------------------	-----------	-------

### Graphics Primitives

Objects	Default Values
plot::CoordinateSystem2d, plot::CoordinateSystem3d	GridLineColor: RGB::Grey60 SubgridLineColor: RGB::Grey80

### Description

GridLineColor, SubgridLineColor govern the color of coordinate grid and subgrid lines extending the tick marks on coordinate axes.

Setting GridVisible = TRUE, SubgridVisible = TRUE, one can display a coordinate grid extending the tick marks on the coordinate axes. See the help page of GridVisible for further information.

GridLineColor, SubgridLineColor set the RGB color (Symbolic Math Toolbox) for the coordinate grid and subgrid lines.

The color of the coordinate grid lines cannot be specified separately for the single coordinate directions.

## Examples

### Example 1

The usual grey lines of the coordinate grid are not appropriate for the following density graphics on page 24-265:

```
d := plot::Density(exp(-x^2 - y^2), x = -1..1, y = -1 ..1,
                   FillColor = RGB::White):
plot(d, TicksNumber = Normal, TicksBetween = 4,
     GridVisible = TRUE, SubgridVisible = TRUE)
```

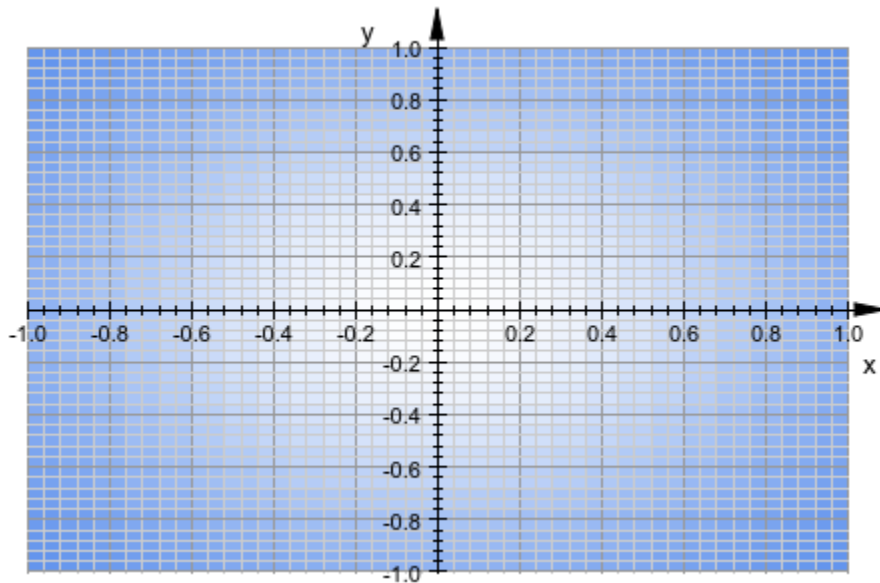

We change the grid color to a darker grey:

```
plot(d, TicksNumber = Normal, TicksBetween = 4,
     GridVisible = TRUE, SubgridVisible = TRUE,
     GridLineColor = RGB::SlateGreyDark,
     SubgridLineColor = RGB::SlateGreyDark,
     GridLineWidth = 0.5*unit::mm)
```

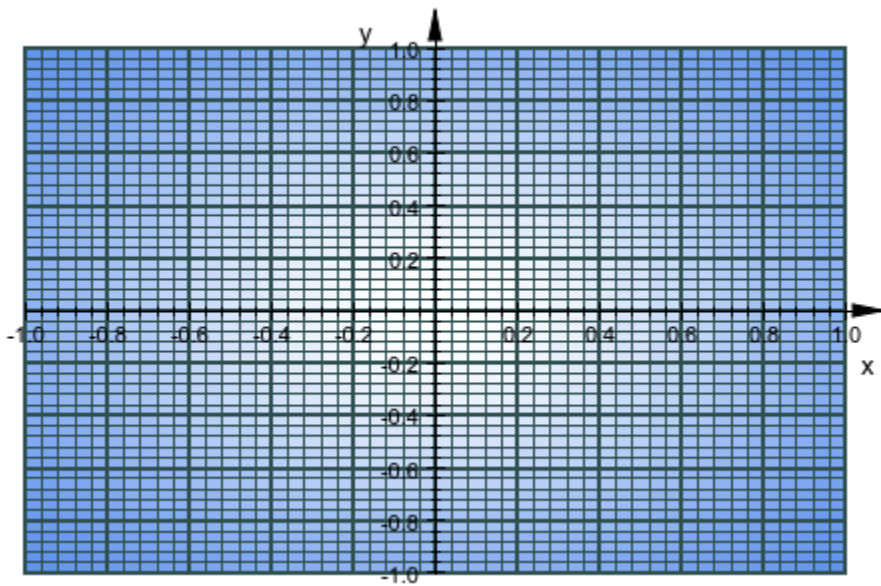

delete d:

## See Also

### MuPAD Functions

[GridInFront](#) | [GridLineStyle](#) | [GridLineWidth](#) | [GridVisible](#)

# GridLineStyleSubgridLineStyle

Line style of the coordinate grid

## Value Summary

GridLineStyle, SubgridLineStyle	Inherited	Dashed, Dotted, or Solid
------------------------------------	-----------	--------------------------

## Graphics Primitives

Objects	Default Values
plot::CoordinateSystem2d, plot::CoordinateSystem3d	GridLineStyle, SubgridLineStyle: Solid

## Description

GridLineStyle, SubgridLineStyle govern the style of the coordinate grid lines and subgrid lines extending the tick marks on coordinate axes.

Setting GridVisible = TRUE, SubgridVisible = TRUE, one can display a coordinate grid extending the tick marks on the coordinate axes. See the help page of GridVisible for further information.

Styles for coordinate grid and subgrid lines can be either Solid, Dashed, or Dotted.

The line style of the coordinate grid cannot be specified separately for the single coordinate directions.

## Examples

### Example 1

We use horizontal coordinate lines to visualize quantiles for the normal distribution:

```
plot(plot::Function2d(stats::normalCDF(0, 1)(x), x = -3..3),
      Axes = Frame, TicksBetween = 4,
      YGridVisible = TRUE, YSubgridVisible = TRUE,
      GridLineStyle = Solid, SubgridLineStyle = Dashed):
```

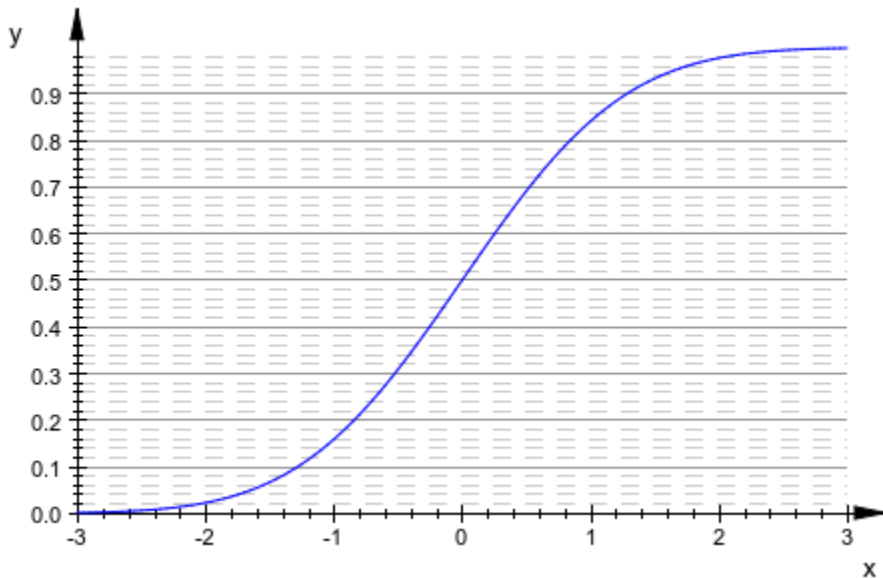

### Example 2

Here is an example of a function graph in 3D with different style settings for the coordinate grid and subgrid:

```
plot(plot::Function3d(sin(x*y), x = -2..2, y = -2..2),
      GridVisible = TRUE, SubgridVisible = TRUE,
      GridLineStyle = Dashed, SubgridLineStyle = Dotted):
```



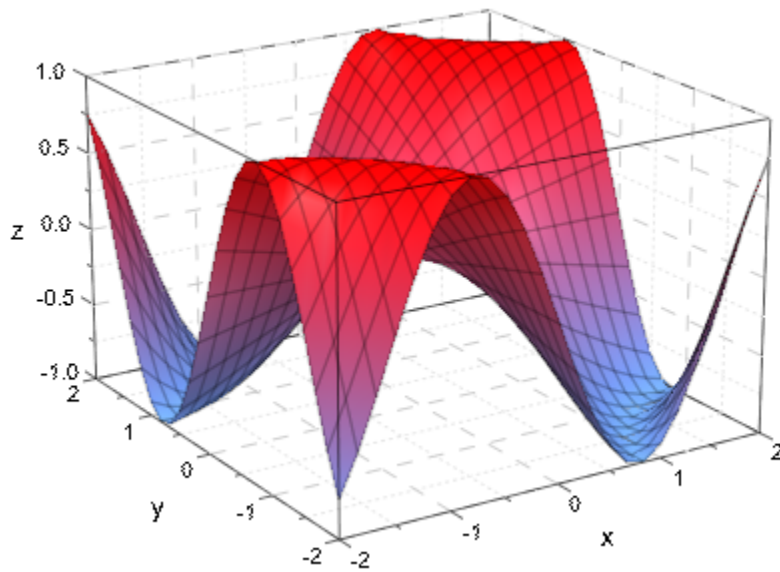

## See Also

### MuPAD Functions

[GridInFront](#) | [GridLineColor](#) | [GridLineWidth](#) | [GridVisible](#)

## GridLineWidthSubgridLineWidth

Width of coordinate grid lines

### Value Summary

GridLineWidth, SubgridLineWidth	Inherited	Positive output size
------------------------------------	-----------	----------------------

### Graphics Primitives

Objects	Default Values
plot::CoordinateSystem2d, plot::CoordinateSystem3d	GridLineWidth, SubgridLineWidth: 0.1

### Description

GridLineWidth, SubgridLineWidth govern the width of coordinate grid lines and subgrid lines extending the tick marks on coordinate axes.

Setting GridVisible = TRUE, SubgridVisible = TRUE, one can display a coordinate grid extending the tick marks on the coordinate axes. See the help page of GridVisible for further information.

GridLineWidth, SubgridLineWidth set the linewidth for the coordinate grid and the subgrid, respectively. The values should be specified as absolute physical lengths including a length unit on page 1-2196 such as GridLineWidth = 0.5\*unit::mm. Numbers without a physical unit give the size in mm.

GridLinesWidth and SubgridLinesWidth set a common line width for the grid lines in all coordinate directions.

XGridLinesWidth and XSubgridLinesWidth set the line width only for the grid lines extending the axes tick marks on the x-axis.

YGridLinesWidth etc. work correspondingly for the other coordinate directions.

Note that the graphics cannot always react to small changes of the line width because of the discretization into pixels.

## Examples

### Example 1

We use the coordinate lines to plot the sine function on “lined paper”. Because of the rather high number of subgrid lines set by `TicksBetween = 10`, we use extra fine lines for the subgrid:

```
plot(plot::Function2d(sin(x), x = 0 .. 2*PI),
      TicksNumber = Normal, TicksBetween = 10,
      GridVisible = TRUE, SubgridVisible = TRUE,
      GridLineWidth = 0.5*unit::mm,
      SubgridLineWidth = 0.1*unit::mm)
```

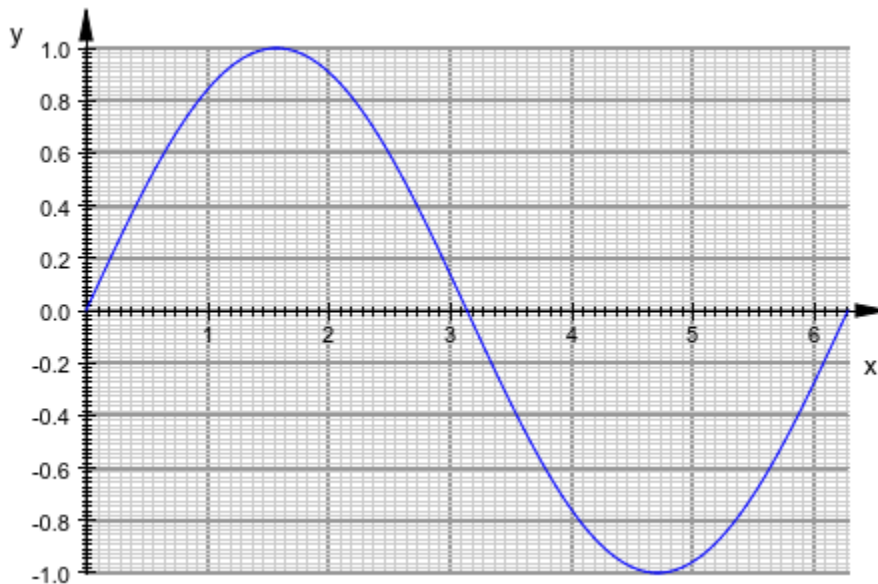

Here is a corresponding plot in 3D:

```
plot(plot::Function3d(cos(x*PI)*cos(y*PI), x = 0 .. 2,  
                      y = 0 .. 2),  
      TicksNumber = Low, TicksBetween = 9,  
      GridVisible = TRUE, SubgridVisible = TRUE,  
      GridLineWidth = 0.5*unit::mm,  
      SubgridLineWidth = 0.1*unit::mm)
```

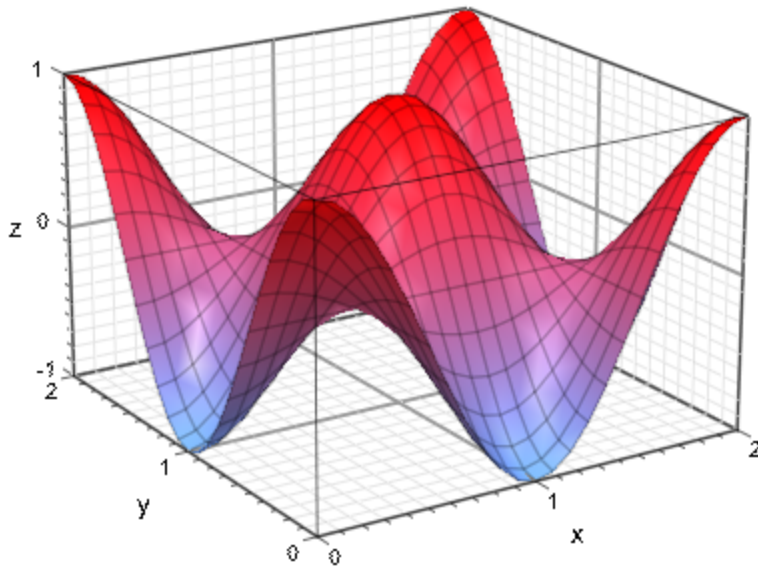

## See Also

### MuPAD Functions

[GridInFront](#) | [GridLineColor](#) | [GridLineStyle](#) | [GridVisible](#)

# GridVisibleSubgridVisibleXGridVisibleXSubgridVisibleYGridVisibleYSubgridVisibleZGridVisibleZSubgridVisible

Display a coordinate grid?

## Value Summary

GridVisible	Library wrapper for “{XGridVisible, YGridVisible}” (2D), “{XGridVisible, YGridVisible, ZGridVisible}” (3D)	See below
SubgridVisible	Library wrapper for “{XSubgridVisible, YSubgridVisible}” (2D), “{XSubgridVisible, YSubgridVisible, ZSubgridVisible}” (3D)	See below
XGridVisible, XSubgridVisible, YGridVisible, YSubgridVisible, ZGridVisible, ZSubgridVisible	Inherited	FALSE, or TRUE

## Graphics Primitives

Objects	Default Values
<code>plot::CoordinateSystem2d</code>	<code>GridVisible, SubgridVisible, XGridVisible, XSubgridVisible, YGridVisible, YSubgridVisible: FALSE</code>
<code>plot::CoordinateSystem3d</code>	<code>GridVisible, SubgridVisible, XGridVisible, XSubgridVisible, YGridVisible, YSubgridVisible, ZGridVisible, ZSubgridVisible: FALSE</code>

### Description

With `GridVisible = TRUE` versus `GridVisible = FALSE`, a coordinate grid extending the “major” axes tick marks is “switched on” or “off”.

With `SubgridVisible`, additional grid lines extending the “minor” axes tick marks are switched on or off.

With `XGridVisible`, `XSubgridVisible` etc., the coordinate lines can be switched on or off separately for each single coordinate direction.

The regular equidistant tick marks along the coordinate axes consist of “minor” tick marks without labels (cf. `TicksBetween`) between “major” tick marks bearing labels (cf. `TicksNumber`, `TicksAnchor`, `TicksDistance`).

Extending the major tick marks, one obtains a grid of coordinate lines. Likewise, extending the minor tick marks yields a refined subgrid of coordinate lines.

With `GridVisible = TRUE`, the coordinate grid extending the major tick marks is displayed. With `SubgridVisible = TRUE`, the refined subgrid is displayed.

With `XGridVisible = TRUE`, `XSubgridVisible = TRUE`, only the coordinate lines passing through the ticks along the x-axis are displayed. Likewise, `YGridVisible`, `YSubgridVisible`, `ZGridVisible`, `ZSubgridVisible` allow to display the coordinate lines passing through the ticks along the y and z-axis, respectively.

The coordinate grid is controlled by the ticks marks displayed along the coordinate axes.

Use `TicksNumber` to control the number of automatically generated major tick marks. Alternatively, use `TicksAnchor`, `TicksDistance` to specify the major tick marks explicitly.

Use `TicksBetween` to control the number of minor tick marks.

Non-regular tick marks added via `TicksAt` do not generate additional grid lines.

## Examples

### Example 1

We plot the graph of the sine function without grid lines:

```
plot(plot::Function2d(sin(x), x = 0..2*PI),  
      XTicksNumber = Normal, YTicksNumber = High)
```

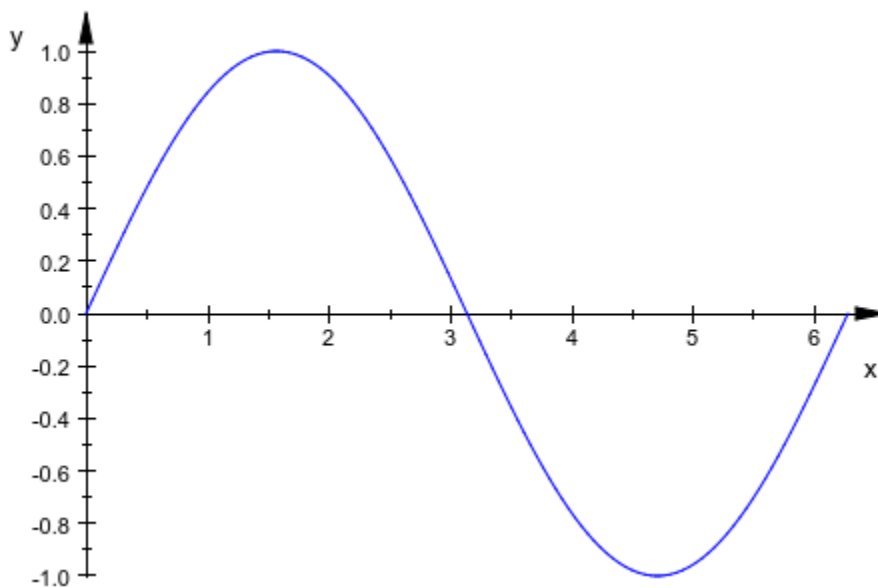

The grid lines are “switched on”:

```
plot(plot::Function2d(sin(x), x = 0..2*PI),  
      XTicksNumber = Normal, YTicksNumber = High,  
      GridVisible = TRUE):
```

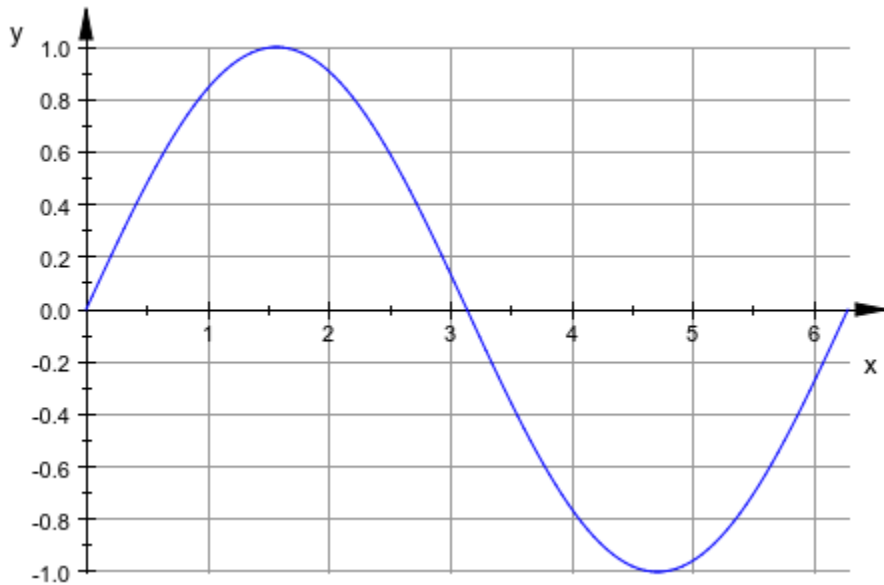

The subgrid lines are switched on as well:

```
plot(plot::Function2d(sin(x), x = 0..2*PI),  
      XTicksNumber = Normal, YTicksNumber = High,  
      GridVisible = TRUE, SubgridVisible = TRUE):
```



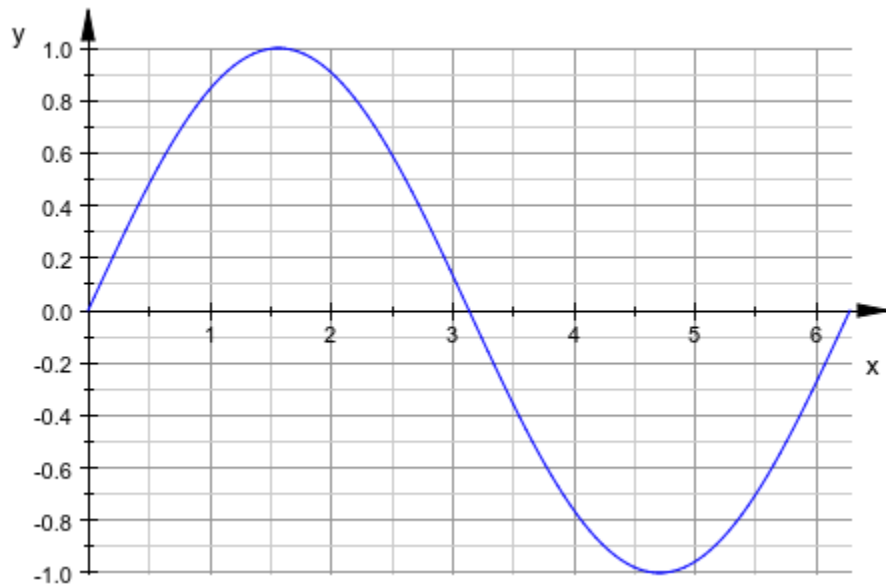

We refine the subgrid in the x-direction via XTicksBetween:

```
plot(plot::Function2d(sin(x), x = 0..2*PI),  
      XTicksNumber = Normal, XTicksBetween = 4,  
      YTicksNumber = High,  
      GridVisible = TRUE, SubgridVisible = TRUE):
```

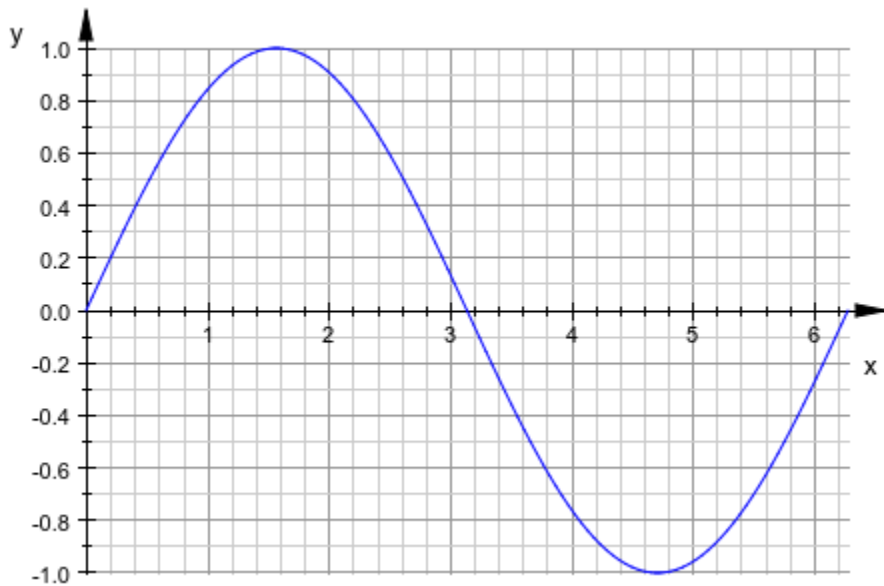

## Example 2

We consider the probability of at least  $k$  successes when performing 10 independent experiments each with a 50% chance of success. Consider for this the cumulative density of the binomial distribution given by `stats::binomialCDF`. Quantiles are visualized by introducing horizontal grid lines:

```
f := stats::binomialCDF(10, 0.5):  
plot(plot::Bars2d([f(k) $ k = 0..10]),  
      XTicksDistance = 1, XTicksBetween = 0,  
      XAxisVisible,  
      YTicksDistance = 0.1, YTicksBetween = 4,  
      YGridVisible, YSubgridVisible)
```

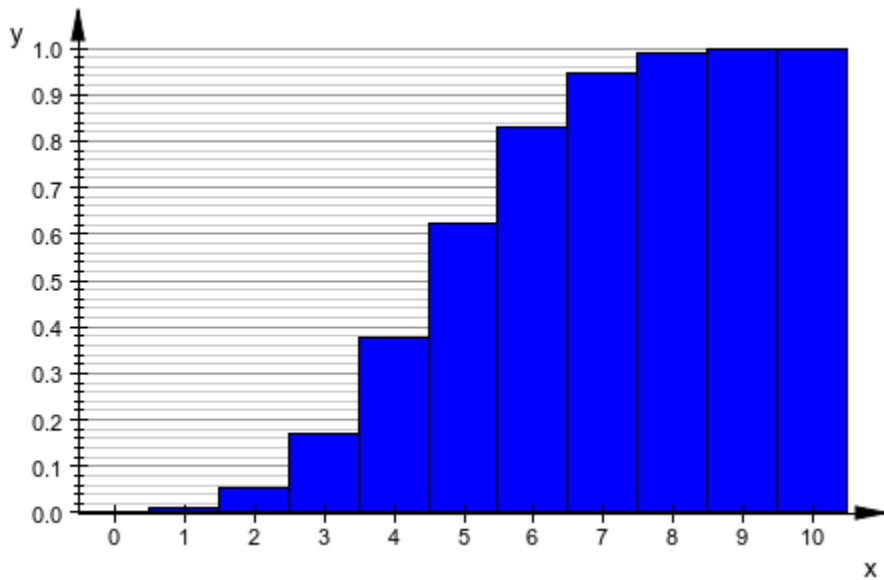

delete f:

### Example 3

Consider a curve in 3D with two of its projections to the coordinate planes. We render the coordinate grid visible:

```
c1 := plot::Curve3d([t, cos(t)/t, sin(t)], t = 1..10,  
                    LineColor = RGB::Red):  
c2 := plot::Curve3d([1, cos(t)/t, sin(t)], t = 1..10,  
                    LineColor = RGB::ForestGreen):  
c3 := plot::Curve3d([t, cos(t)/t, -1], t = 1..10,  
                    LineColor = RGB::Blue):  
plot(c1,c2, c3, TicksBetween = 4, GridVisible = TRUE,  
     SubgridVisible = TRUE)
```

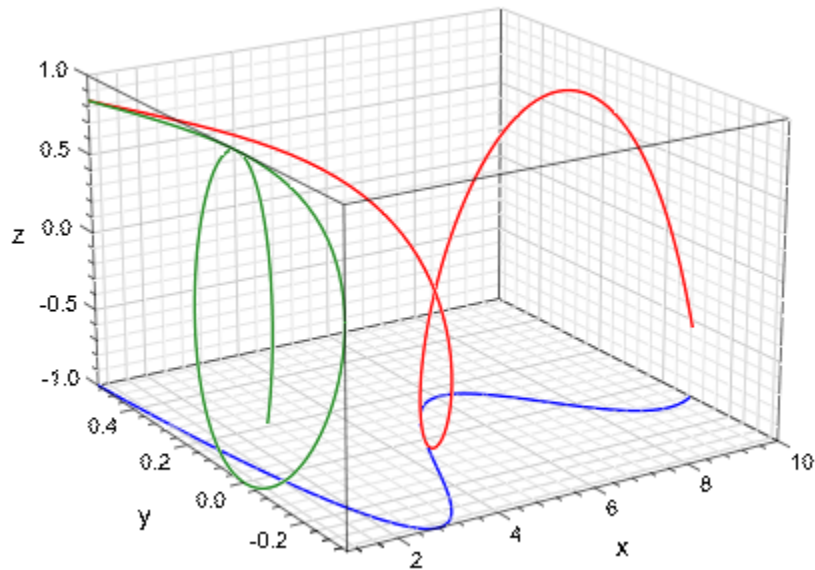

```
delete c1, c2, c3:
```

### Example 4

Because of the rather large number of grid lines in the following plot, we use extra fine lines to render the subgrid:

```
plot(plot::Function3d(cos(x*PI)*cos(y*PI), x = 0 .. 2,
                      y = 0 .. 2),
      TicksNumber = Low, TicksBetween = 9,
      GridVisible = TRUE, SubgridVisible = TRUE,
      GridLineWidth = 0.5*unit::mm,
      SubgridLineWidth = 0.1*unit::mm)
```

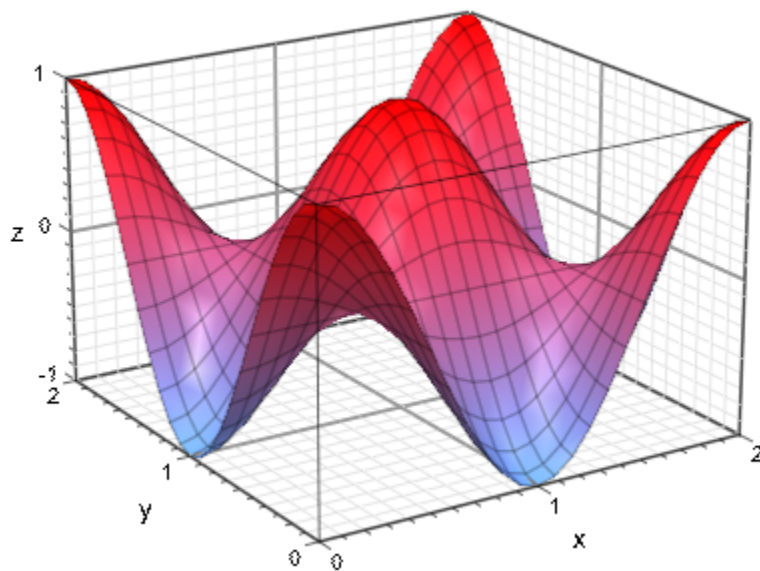

## See Also

### MuPAD Functions

[GridInFront](#) | [GridLineColor](#) | [GridLineStyle](#) | [GridLineWidth](#)

# AnimationStyle

Behaviour of the animation toolbar

## Value Summary

Inherited	BackAndForth, Loop, or RunOnce
-----------	--------------------------------

## Graphics Primitives

Objects	AnimationStyle Default Values
plot::Canvas	RunOnce

## Description

AnimationStyle determines how an animation is played in VCam once it is activated.

AnimationStyle determines what has to be done when an animation reaches the end of its playing time. With RunOnce the animation stops, with BackAndForth the animation reverts and runs through to the beginning and with Loop it jumps back to the beginning and runs on from there on.

AnimationStyle sets the initial value of the Animation Style menu in the animation toolbar according to its value.

## Examples

### Example 1

This example shows an animation which builds up a picture frame by frame and at the end of the animation time the complete picture is visible. For this kind of animation the value RunOnce is a good choice for AnimationStyle:

```

plot(plot::Line2d([a/36, 0], [sin(a/18*PI), cos(a/18*PI)],
  VisibleAfter = a/7.2,
  Color = [sin(a/18*PI), sin(a/18*PI), cos(a/18*PI)])
  $ a = -36..36,
  AnimationStyle = RunOnce)

```

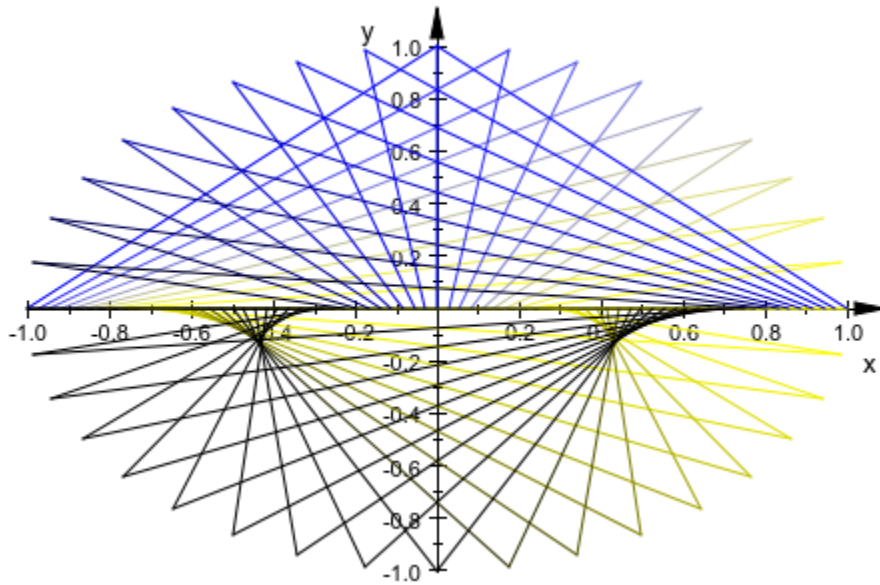

## Example 2

This example plays in an endless loop and the value `Loop` is chosen because first frame is the natural successor of the last frame of the animation:

```

plot(plot::Function2d(sin(a*x), x = -PI..PI, a = -PI..PI),
  AnimationStyle = Loop)

```

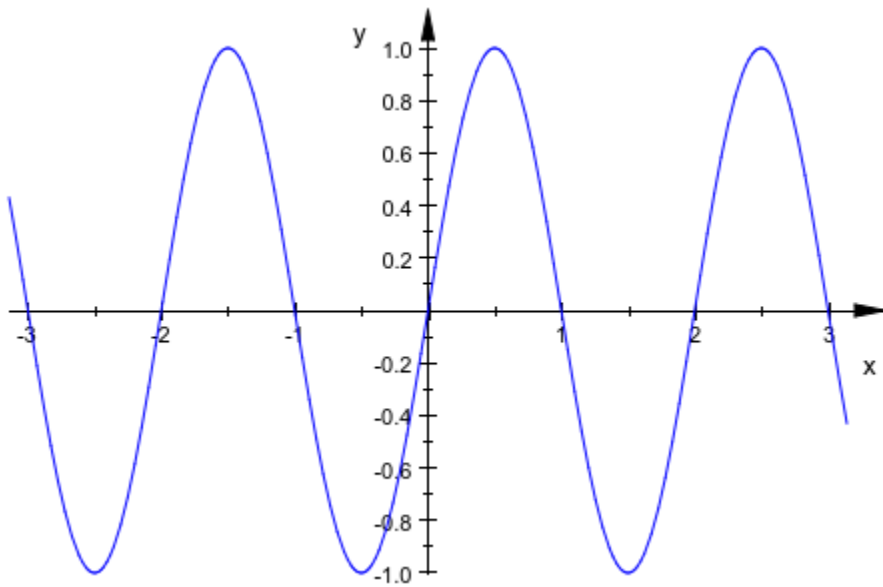

### Example 3

In this example the circle grows from radius 0 to radius 1. With `AnimationStyle = BackAndForth` the circle grows and shrinks in an endless loop:

```
plot(plot::Circle2d(a, a = 0..1),  
      AnimationStyle = BackAndForth)
```



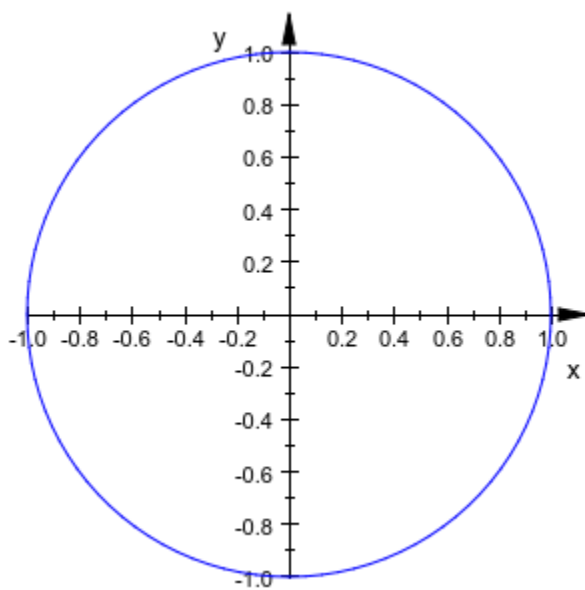

## See Also

**MuPAD Functions**  
InitialTime

## AutoPlay

Start animations automatically

### Value Summary

Optional	FALSE, or TRUE
----------	----------------

### Graphics Primitives

Objects	AutoPlay Default Values
<code>plot::Canvas</code>	TRUE

### Description

When plotting with `AutoPlay = TRUE`, animations will start automatically when the plot is activated. This is the default setting.

Animations created with `AutoPlay = FALSE` start when the corresponding button is pressed.

# Frames

Number of frames in an animation

## Value Summary

Inherited	Positive integer
-----------	------------------

## Description

Frames determines the number of frames in the animation of an object.

Frames =  $n$  with a positive integer  $n$  sets the number of frames for the animation of an object to  $n$ .

These frames are played during the real time period given by TimeBegin =  $t_0$  and TimeEnd =  $t_1$  (in seconds).

The resulting frame rate is  $n/(t_1 - t_0)$  (frames per second).

Increasing the number of frames does not mean that the animation lasts longer, because the renderer does not work with a fixed number of frames per second.

Keeping the play period from TimeBegin =  $t_0$  to TimeEnd =  $t_1$  fixed, an increased number of frames just produces a higher frame rate leading to a smoother animation.

Note that the human eye cannot distinguish between different frames if they change with a rate of more than 25 frames per second. Thus, the number of frames  $n$  for an animation should satisfy  $n < 25 (t_1 - t_0)$ .

With the default time range TimeBegin =  $t_0 = 0$ , TimeEnd =  $t_1 = 10$  (seconds), it does not make sense to specify Frames =  $n$  with  $n > 250$ . If a higher  $n$  is required to obtain a sufficient resolution of the animated object, one should increase the time for the animation by a sufficiently high value of TimeEnd.

Since the values of Frames, TimeBegin, TimeEnd may be set separately for different objects, it is possible to animate objects in a scene with different frame rates. Cf. "Example 2" on page 24-1564 (Symbolic Math Toolbox).

## Examples

### Example 1

We set the number of frames for the following animation to 40. The default animation range of 10 seconds is used. This results in a frame rate of 4 frames per second:

```
plot(plot::Function2d(sin(a*x), x = -PI..PI,  
      a = 1..2, Frames = 40)):
```

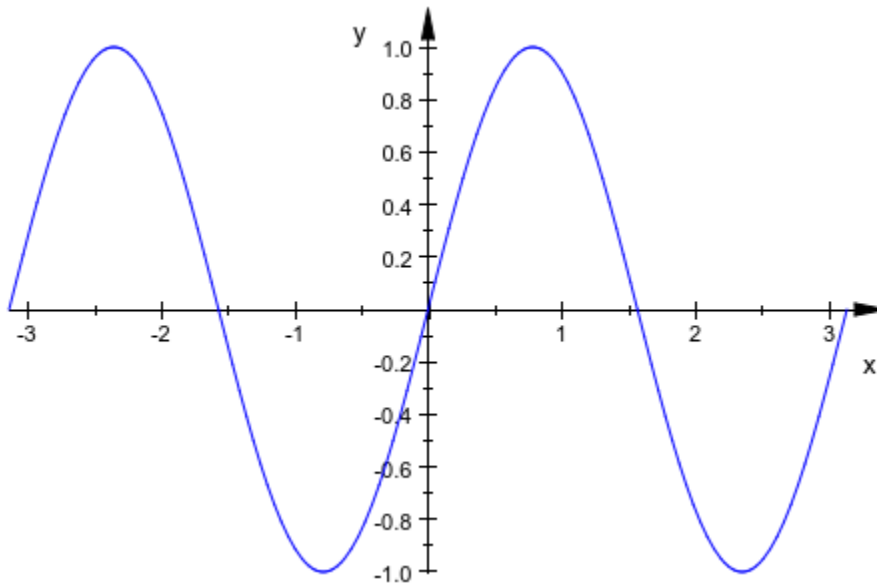

### Example 2

Here is an example of different frame rates in one plot. The default animation range of 10 seconds is used.

The red point is sampled with 30 frames in 10 seconds, the blue one with 100 frames in 10 seconds. The animation of the blue point is much smoother:

```
plot(plot::Function2d(sin(x), x = 0..PI,  
      Color = RGB::Black),
```

```
plot::Point2d([a , sin(a) + 0.07], a = 0 .. PI,  
              Color = RGB::Red, Frames = 30),  
plot::Point2d([a , sin(a) - 0.07], a = 0 .. PI,  
              Color = RGB::Blue, Frames = 100),  
PointSize = 4*unit::mm):
```

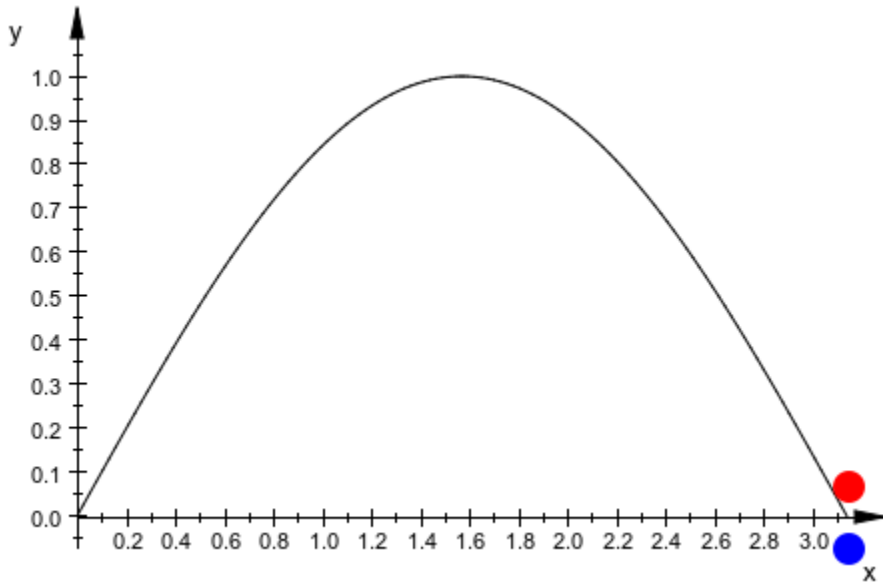

## See Also

### MuPAD Functions

ParameterBegin | ParameterEnd | ParameterName | ParameterRange | TimeBegin  
| TimeEnd | TimeRange | VisibleAfter | VisibleAfterEnd | VisibleBefore |  
VisibleBeforeBegin | VisibleFromTo

## Topics

“The Number of Frames and the Time Range” (Symbolic Math Toolbox)

## TimeBeginTimeEndTimeRangeInitialTime

Time of the animation

### Value Summary

InitialTime, TimeBegin, TimeEnd	Inherited	Real number
TimeRange	[TimeBegin .. TimeEnd]	Range on page 1-16 of arithmetical expressions

### Graphics Primitives

Objects	Default Values
plot::Canvas	

### Description

$\text{TimeBegin} = t_0$  defines the starting time  $t_0$  of the animation of an object.

$\text{TimeEnd} = t_1$  defines the time  $t_1$  for the end of the animation.

$\text{TimeRange} = t_0 \dots t_1$  is a short cut for setting both  $\text{TimeBegin} = t_0$  and  $\text{TimeEnd} = t_1$ .

$\text{InitialTime} = t_2$  defines the time  $t_2$  for the initial position of the animation slider.

Animations are defined object by object. Each animated object is animated for a certain time span specified by `TimeBegin` and `TimeEnd` setting the real start and end time in seconds.

The total real time span of an animated plot is the physical real time given by the minimum of the `TimeBegin` values of all animated objects in the plot to the maximum of the `TimeEnd` values of all the animated objects:

- When a plot containing animated objects is created, the real time clock is set to the minimum of the `TimeBegin` values of all animated objects in the plot. The real time clock is started when pushing the `play' button for animations in the graphical user interface.
- Before the real time reaches the `TimeBegin` value  $t_0$  of an animated object, this object is static in the state corresponding to the begin of its animation. Depending on the attribute `VisibleBeforeBegin`, it may be visible or invisible before  $t_0$ .
- During the time from  $t_0$  to  $t_1$ , the object changes from its original to its final state.
- After the real time reaches the `TimeEnd` value  $t_1$ , the object stays static in the state corresponding to the end of its animation. Depending on the attribute `VisibleAfterEnd`, it may stay visible or become invisible after  $t_1$ .
- The animation of the entire plot ends with the physical time given by the maximum of the `TimeEnd` values of all animated objects in the plot.

If all animated objects in a plot share the same values `TimeBegin =  $t_0$`  and `TimeEnd =  $t_1$` , the physical time span of the animation is  $t_1 - t_0$  (in seconds). During this time, all animated objects change from their initial to their final state.

Separate settings for `TimeBegin` and `TimeEnd` in different animated objects allow to synchronize the animations.

With the optional attribute `InitialTime` the initial position of the animation slider can be set to any time value  $t_2$  between  $t_0$  and  $t_1$ . If `InitialTime` is not set, the slider will be placed at the beginning of the animation.

The attributes `VisibleAfter`, `VisibleBefore`, and `VisibleFromTo` allow special “visibility animations” in which objects are visible for a limited time only.

---

**Note** The attributes `VisibleAfter`, `VisibleBefore`, and `VisibleFromTo` implicitly set values for `TimeBegin` and `TimeEnd` (and, therefore, also for `TimeRange`). Consequently, these attributes should not be used simultaneously in the definition of an animated object.

---

## Examples

### Example 1

By default, an animation plays for 10 seconds. Keeping the default value `TimeBegin = 0`, this time can be reduced to 5 seconds by setting `TimeEnd = 5`:

```
plot(plot::Function2d(sin(a*x), x= -PI .. PI, a = -PI..PI,  
      TimeEnd = 5)):
```

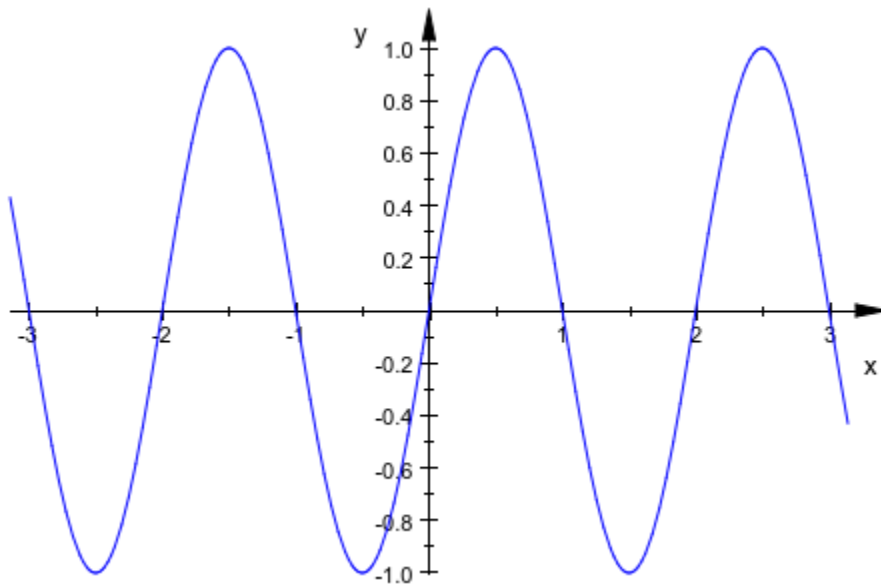

The total time of the animation is the difference between `TimeEnd` and `TimeBegin`. Hence, the following animation plays 5 seconds as well:

```
plot(plot::Function2d(sin(a*x), x = -PI..PI, a = -PI..PI,  
      TimeRange = 5..10)):
```



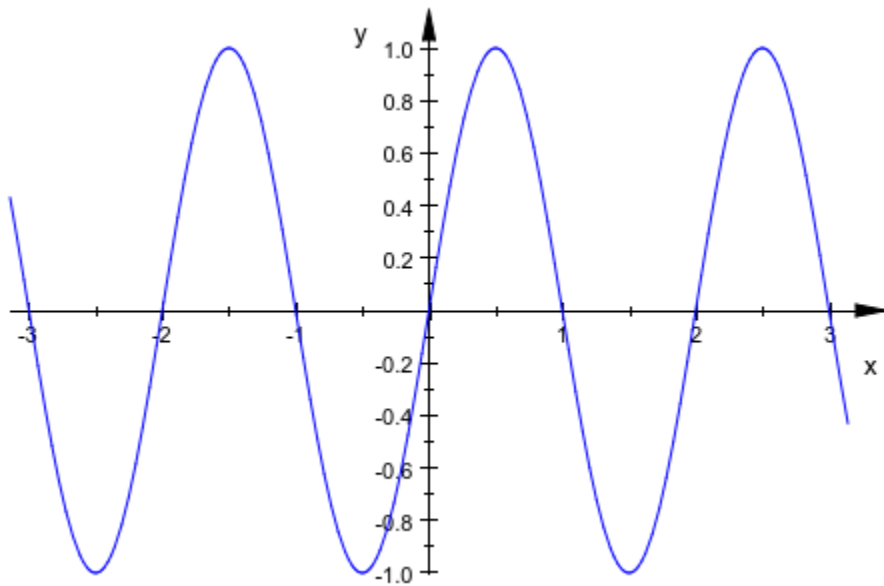

## Example 2

Using different time ranges allows to synchronize the animations of different objects. Here we plot two functions. The first function is animated from 0 to 5 (seconds) and then stays static in its final state. The second function stays static in its initial state for 5 seconds and is then animated in the range from 5 to 10 (seconds):

```
f1 := plot::Function2d(a*sin(x), x = -PI..PI, a = -1..1,
                      Color = RGB::Red, TimeRange = 0..5):
f2 := plot::Function2d(a*cos(x), x = -PI..PI, a = -1..1,
                      Color = RGB::Blue, TimeRange = 5..10):
plot(f1 ,f2):
```

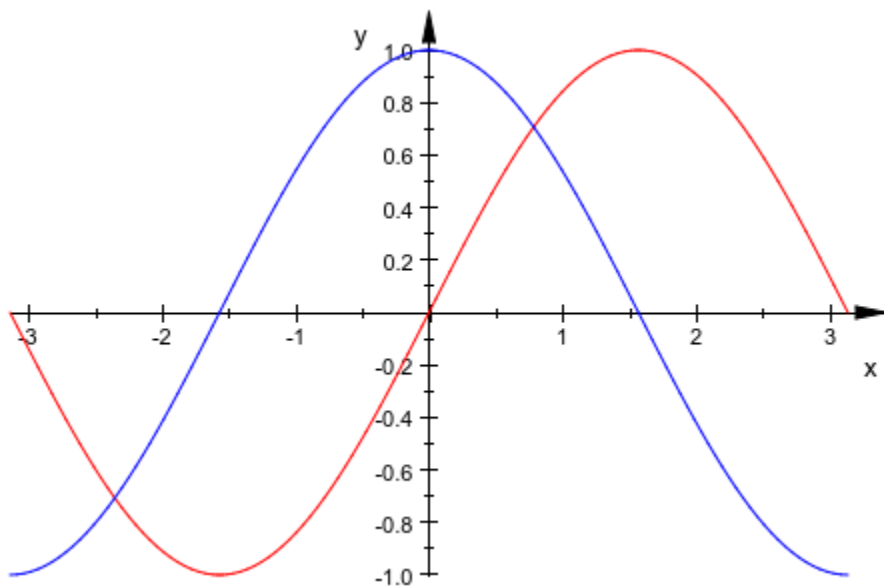

Both functions are visible outside the time range of their animations. We use the attributes `VisibleAfterEnd` and `VisibleBeforeBegin` to make them visible only during their animations:

```
f1::VisibleAfterEnd := FALSE:  
f2::VisibleBeforeBegin := FALSE:  
plot(f1, f2):
```

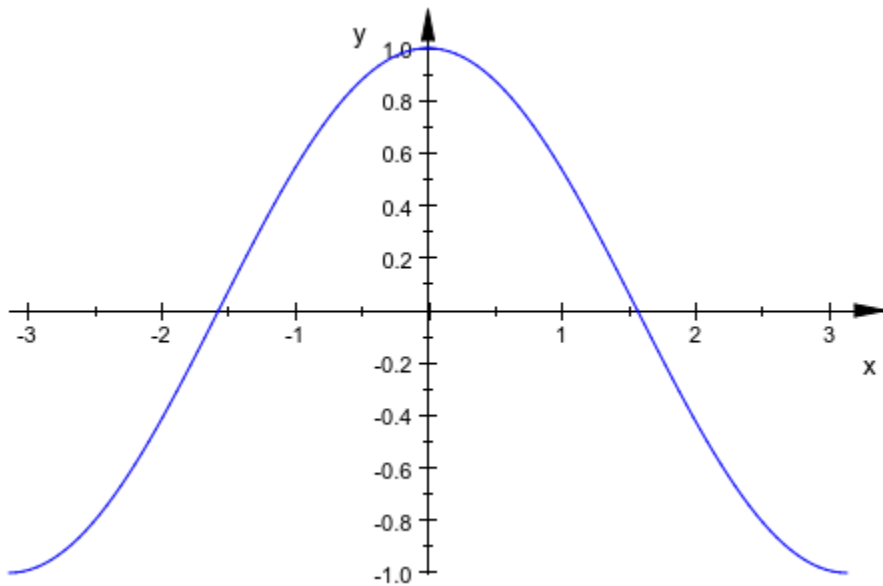

```
delete f1, f2:
```

### Example 3

The following animation uses the implicitly given TimeRange from 0 to 10 seconds, but the first image shown is at the time 5:

```
plot(plot::Function2d(a*sin(x), x = -PI..PI, a = -1..1),  
      InitialTime=5):
```

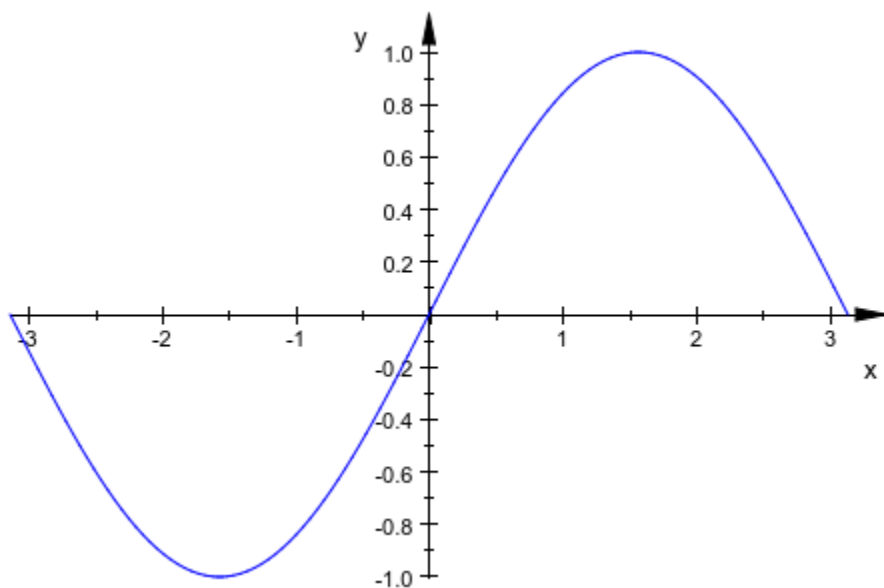

## See Also

### MuPAD Functions

[AnimationStyle](#) | [Frames](#) | [ParameterBegin](#) | [ParameterEnd](#) | [ParameterName](#) | [ParameterRange](#) | [VisibleAfter](#) | [VisibleAfterEnd](#) | [VisibleBefore](#) | [VisibleBeforeBegin](#) | [VisibleFromTo](#)

### Topics

“The Number of Frames and the Time Range” (Symbolic Math Toolbox)

“Advanced Animations: The Synchronization Model” (Symbolic Math Toolbox)

# VisibleAfterVisibleBeforeVisibleFromTo

Object visible at time value

## Value Summary

VisibleAfter, VisibleBefore, VisibleFromTo	Library wrapper for "TimeEnd, TimeBegin, VisibleAfterEnd, and VisibleBeforeBegin"	Non-negative real number
--	--	--------------------------

## Description

`VisibleAfter = t0` renders an object invisible until the real time  $t_0$  has elapsed in an animation. Then the object becomes visible.

`VisibleBefore = t1` renders an object visible until the time  $t_1$ . Then the object becomes invisible.

`VisibleFrom = t0 .. t1` renders an object invisible until the time  $t_0$ . Then the object becomes visible. After the time  $t_1$  it becomes invisible again.

`VisibleAfter`, `VisibleBefore`, `VisibleFromTo` allow to implement animated visibility of objects. This also includes otherwise static objects, which become animated objects when one of these attributes is used.

The attributes `VisibleBeforeBegin` and `VisibleAfterEnd` control the visibility of objects outside the time range of their animation set by `TimeBegin` and `TimeEnd`. See `TimeBegin`, `TimeEnd` for details.

`VisibleAfter`, `VisibleBefore`, `VisibleFromTo` provide short cuts for suitable settings of the attributes `TimeBegin`, `VisibleBeforeBegin`, `TimeEnd`, `VisibleAfterEnd` that produce the desired visibility effects.

`VisibleAfter = t0` is a short cut for setting the following attribute values:

`TimeBegin = t0`, `VisibleBeforeBegin = FALSE`,

`TimeEnd = t0, VisibleAfterEnd = TRUE.`

The resulting effect is that the corresponding object is invisible at the beginning of the animation. It becomes visible at the time  $t_0$ , staying visible until the end of the animation.

The time  $t_0$  has to be a real numerical value giving the real time in seconds.

`VisibleBefore = t1` is a short cut for setting the following attribute values:

`TimeBegin = t1, VisibleBeforeBegin = TRUE,`

`TimeEnd = t1, VisibleAfterEnd = FALSE.`

The resulting effect is that the corresponding object is visible at the beginning of the animation. At the time  $t_1$  it becomes invisible, staying invisible until the end of the animation.

The time  $t_1$  has to be a real numerical value giving the real time in seconds.

`VisibleFromTo = t0 .. t1` is a short cut for setting the following attribute values:

`TimeBegin = t0, VisibleBeforeBegin = FALSE,`

`TimeEnd = t1, VisibleAfterEnd = FALSE.`

The resulting effect is that the corresponding object is visible only from the time  $t_0$  until the time  $t_1$ .

---

**Note** The attributes `VisibleAfter = t0` and `VisibleBefore = t1` should not be combined to create visibility for the time range between  $t_0$  and  $t_1$ . (Conflicting values are set implicitly for `VisibleBeforeBegin` etc.) Use `VisibleFromTo = t0 .. t1` instead.

---

---

**Note** `VisibleAfter`, `VisibleBefore`, `VisibleFromTo` should not be combined with any of the the attributes `TimeBegin`, `TimeEnd`, `VisibleBeforeBegin` or `VisibleAfterEnd`, since implicit values for these attributes are set.

---

## Examples

### Example 1

The following animation consists of 100 pieces of the graph of the function  $x \sin(x)$ . At the times  $t = 0.1, 0.2$  etc., an additional piece of the function becomes visible until, finally, the whole graph is built up:

```
plot(plot::Function2d(x*sin(x), x = (i - 1)*PI/100 .. i*PI/100,
    VisibleAfter = i/10) $ i = 1..100)
```

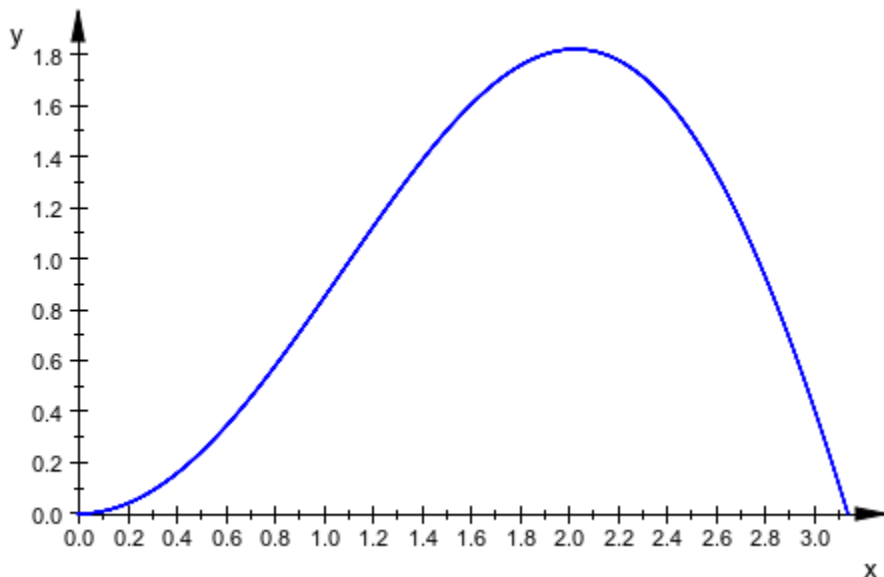

### Example 2

This example creates an animated “spider net”. It consists of several lines which appear one after the other at the times given by `VisibleAfter` until the full net is visible at the end of the animation:

```
SpiderNet :=
proc(move, move1, rc, gc, bc)
    local r, lines, x, y, x1, y1;
```

```
begin
  r := 1.0:
  lines := [FAIL $ 361]:
  for i from 0 to 360 do
    thet := float(i*PI/180);
    x      := r * cos(move  * thet);
    y      := r * sin(move  * thet);
    x1     := r * cos(move1 * thet);
    y1     := r * sin(move1 * thet);
    lines[i+1] :=
      plot::Line2d([x, y] , [x1, y1],
        Color = [abs(rc*sin(i*PI/360)),
          abs(gc*sin(i*PI/360 + PI/4)),
          abs(bc*sin(i*PI/360 + PI/2))],
        VisibleAfter = i/36
      );
  end_for:
  plot::Group2d(op(lines), Name = "SpiderNet",
    Axes = None, Scaling = Constrained)
end_proc:

plot(SpiderNet(3, 7, 0.9, 0.1, 0.5))
```

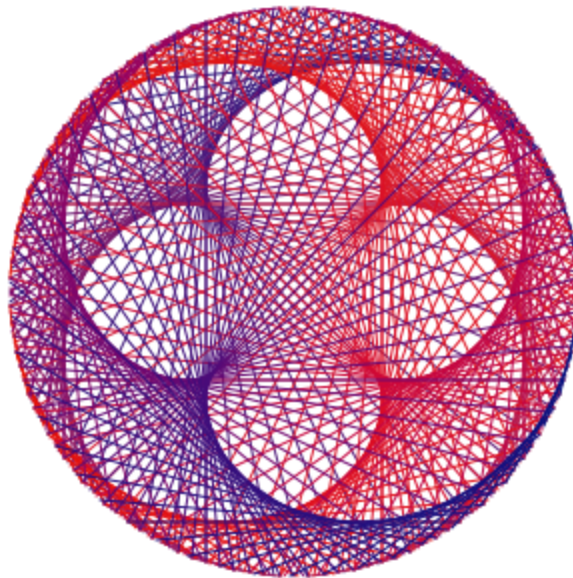



```
delete SpiderNet:
```

### Example 3

This example creates an animated “Maurer rose”. Here the animation starts with the full object. During the animation the lines disappear at the times given by `VisibleBefore`:

```
MaurerRose := proc(n, b, rc, gc, bc)
  local lines, i, thet, r, x, y, x1, y1;
begin
  r := 1.0;
  lines := [FAIL $ 361];
  b := float(b*PI/180);
  for i from 0 to 360 do
    thet := float(i*PI/180);
    x     := r * sin(n*thet)   * cos(thet);
    y     := r * sin(n*thet)   * sin(thet);
    x1    := r * sin(n*(thet+b))* cos(thet+b);
    y1    := r * sin(n*(thet+b))* sin(thet+b);
    lines[i+1] :=
      plot::Line2d([x, y], [x1, y1],
        Color = [abs(rc*sin(i*PI/360)),
          abs(gc*sin(i*PI/360 + PI/4)),
          abs(bc*sin(i*PI/360 + PI/2))],
        VisibleBefore = i/36
      );
  end_for;
  plot::Group2d(op(lines), Name = "MaurerRose",
    Axes = None, Scaling = Constrained);
end_proc;

plot(MaurerRose(4, 120, 0.1, 0.5, 0.9)):
```



```
delete MaurerRose:
```

## Example 4

This example creates an animated “Lissajous net”. It is built up from lines that have a life span of only 2 seconds each, set by `VisibleFromTo`:

```
LissajousNet := proc(r, a, b, R, A, B, rc, gc, bc)
  local lines, i, thet;
begin
  lines := [FAIL $ 361];
  for i from 0 to 360 do
    thet := float(i*PI/180);
    x     := r * cos(a*thet);
    y     := r * sin(b*thet);
    x1    := R * cos(A*thet);
    y1    := R * sin(B*thet);
    lines[i+1] :=
      plot::Line2d([x, y], [x1, y1],
        Color = [abs(rc*sin(i*PI/360)),
          abs(gc*sin(i*PI/360 + PI/4)),
          abs(bc*sin(i*PI/360 + PI/2))],
```

```

        VisibleFromTo = i/36 .. i/36 + 2
    );
end_for:
plot::Group2d(op(lines), Name = "LissajousNet",
              Axes = None, Scaling = Constrained):
end_proc:
plot(LissajousNet(2, 3, 4, 1, 6, 3, 0.7, 0.1, 0.99))

```



```
delete LissajousNet:
```

## Example 5

Here is a 3D example of an animation. A “spider net” is built up with lines that have a life span of 4 seconds each:

```

SpiderNet3d := proc(a, b, c, rc, gc, bc)
  local r, lines, i, x, x1, y, y1, thet, z1, z;
begin
  r := 1.0:
  lines := [FAIL $ 361]:
  for i from 0 to 360 do

```

```

thet := float(i*PI/180);
x     := r * cos(thet)*cos(thet);
y     := r * sin(thet)*cos(thet);
z     := r * sin(thet);
x1    := r * cos(a*thet)*cos(a*thet);
y1    := r * sin(b*thet)*cos(b*thet);
z1    := r * sin(c*thet);
lines[i+1] :=
  plot::Line3d([x,y,z],[x1,y1,z1],
    Color = [abs(rc*sin(i*PI/360)),
             abs(gc*sin(i*PI/360 + PI/4)),
             abs(bc*sin(i*PI/360 + PI/2))],
    VisibleFromTo = i/36 .. i/36 + 4
  );
end_for:
plot::Group3d(op(lines), Name = "SpiderNet3d"):
end_proc:

plot(SpiderNet3d(2, 1, 3, 0.99, 0.9, 0.1))

```

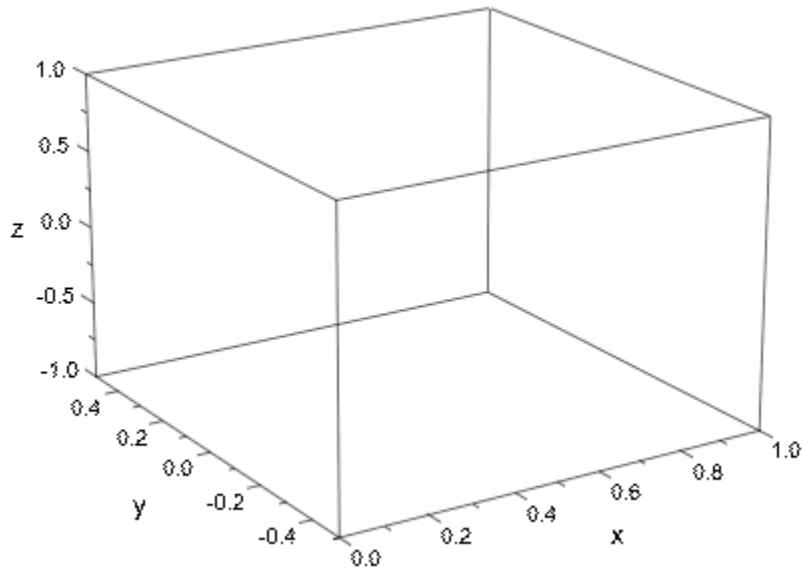

## Algorithms

The last examples on this page are taken from the mathPAD Online Edition (<http://www.mupad.com/mathpad/recreations.html>) written by Prof. Mirek Majewski. See there for details about the mathematics behind the examples above.

## See Also

### MuPAD Functions

Frames | ParameterBegin | ParameterEnd | ParameterName | ParameterRange | TimeBegin | TimeEnd | TimeRange | VisibleAfterEnd | VisibleBeforeBegin

## Topics

“Animations” (Symbolic Math Toolbox)

“Frame by Frame Animations” (Symbolic Math Toolbox)

## VisibleBeforeBeginVisibleAfterEnd

Object visible before or after its animation time starts?

### Value Summary

VisibleAfterEnd, VisibleBeforeBegin	Inherited	FALSE, or TRUE
--	-----------	----------------

### Description

`VisibleBeforeBegin`, `VisibleAfterEnd` determine the visibility of an object before the begin and after the end of its own animation time span, respectively.

Animations are defined object by object. Each animated object is animated for a certain time span specified by `TimeBegin` and `TimeEnd` setting the real start and end time in seconds.

The total real time span of an animated plot is the physical real time given by the minimum of the `TimeBegin` values of all animated objects in the plot to the maximum of the `TimeEnd` values of all the animated objects.

Thus, the time span of an animated plot may be larger than the time spans of the animations of individual objects.

With `VisibleBeforeBegin = TRUE`, an object is visible as a static object when the animation of the entire plot starts. Its state corresponds to the start of its own animation. It begins to change, when the starting time of its own animation set by `TimeBegin` is reached.

With `VisibleBeforeBegin = FALSE`, an object is invisible when the animation of the entire plot starts. It becomes visible when the starting time of its own animation is reached.

With `VisibleAfterEnd = TRUE`, an object stays visible in the final state of its animation after the end of its own animation time span set by `TimeEnd`.

With `VisibleAfterEnd = FALSE`, an object becomes invisible at the end of its own animation.

`VisibleBeforeBegin`, `VisibleAfterEnd` is useful only in plots consisting of several animated objects with different time spans of their animations.

Also consider the attributes `VisibleAfter`, `VisibleBefore`, and `VisibleFromTo` to animate the visibility of objects.

## Examples

### Example 1

In the first 5 seconds of the following animation, the sine function draws itself. Afterwards, a point wanders along the graph:

```
f := plot::Function2d(sin(x), x = -PI..a, a = -PI..PI,  
                      TimeRange = 0..5):  
p := plot::Point2d(a, sin(a), PointSize = 5*unit::mm,  
                  a = -PI..PI, TimeRange = 5..10):  
plot(f, p)
```

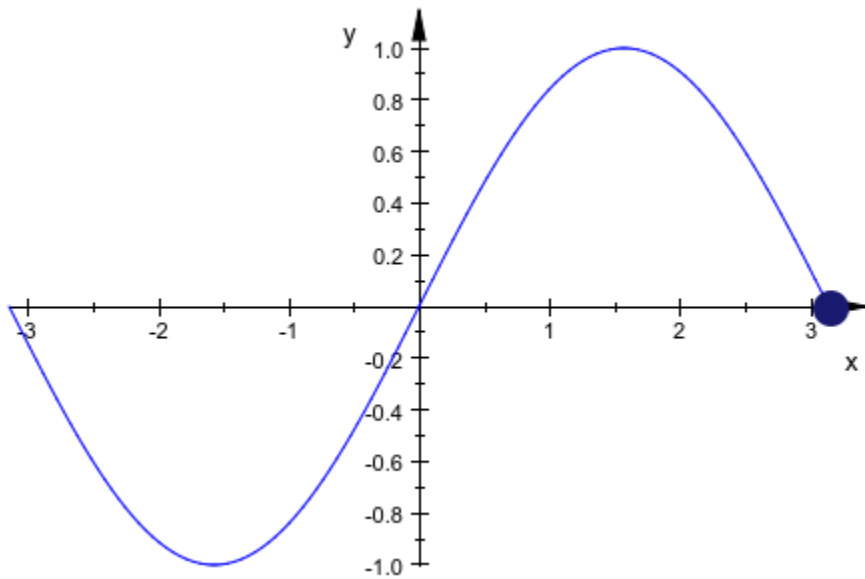

The point is visible for the first 5 seconds, too, because it used the default setting `VisibleBeforeBegin = TRUE`. With `VisibleBeforeBegin = FALSE`, the point is invisible at the start of the animation. It appears after 5 seconds, when its own animation begins:

```
p::VisibleBeforeBegin := FALSE:  
plot(f, p)
```



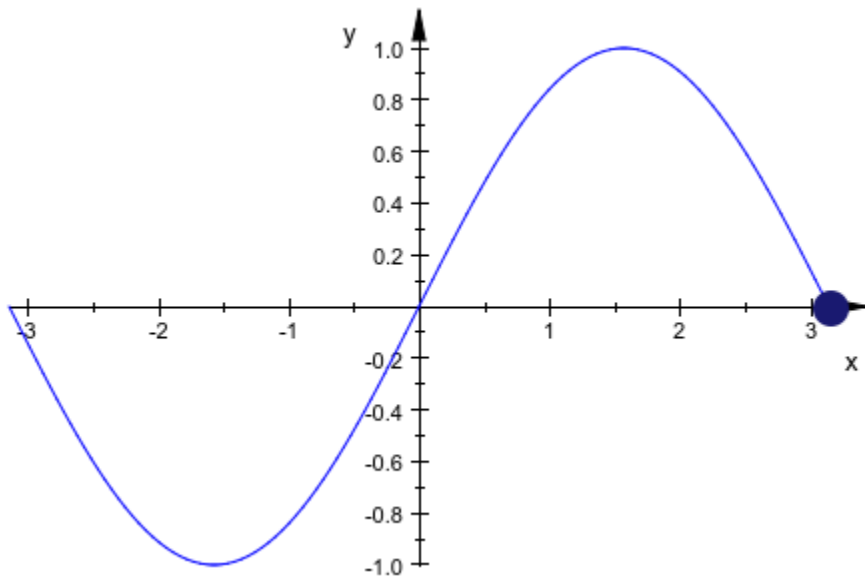

delete p, f:

## Example 2

The `plot::Polar` object in the following animation is only visible in its `TimeRange` from the 3rd to the 7th second:

```

Speaker :=
  plot::Polygon2d([[0.5, -1], [0.5, 1], [0, 0.3],
                 [-0.5, 0.3], [-0.5, -0.3], [0, -0.3],
                 [0.5, -1]], Color = RGB::Black, Filled):
Point := plot::Point2d([2, a], a = -2.5..2.5,
                       PointSize = 3*unit::mm):

plot(plot::Polar([1 + 0.1*(2 + sin(20*a))*cos(20*phi), phi],
                phi = -1..1, a = 0..3, TimeRange = 3..7,
                VisibleBeforeBegin = FALSE,
                VisibleAfterEnd = FALSE),
     Speaker, Point, Axes = None)

```

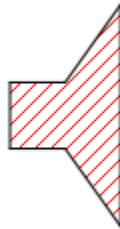

The previous command is equivalent to:

```
plot(plot::Polar([1 + 0.1*(2 + sin(20*a))*cos(20*phi), phi],  
        phi = -1..1, a = 0..3, VisibleFromTo = 3..7),  
      Speaker, Point, Axes = None)
```



```
delete Speaker, Point:
```

### Example 3

A circle is tumbling around in 3D. After 3 seconds, a growing sphere on page 24-742 becomes visible. From the 5th second through to the end of the animation, the sphere stays visible with the constant radius 5, while the circle moves further out:

```
plot(plot::Circle3d(4, [sin(a), cos(a), a],
  [sin(a), cos(a), a], a = 0..10,
  Frames = 100, TimeRange = 0..10,
  Filled = TRUE, FillColor = RGB::Blue),
  plot::Sphere(a, [0, 0, 0], Color=RGB::Red,
  a = 3..5, TimeRange = 3 .. 5, Frames = 20,
  VisibleBeforeBegin = FALSE)):
```

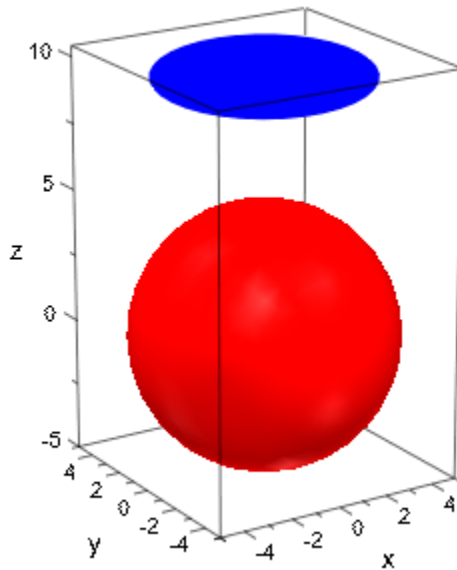

## See Also

### MuPAD Functions

Frames | ParameterBegin | ParameterEnd | ParameterName | ParameterRange |  
TimeBegin | TimeEnd | TimeRange | VisibleAfter | VisibleBefore |  
VisibleFromTo

# FooterHeader

Footer text

## Value Summary

Footer, Header	Optional	Text string
----------------	----------	-------------

## Graphics Primitives

Objects	Default Values
plot::Canvas, plot::Scene2d, plot::Scene3d	

## Description

Footer = "..." sets a text to be displayed at the bottom of a scene or canvas.

Header = "..." sets a text to be displayed at the top of a scene or canvas.

As described in the introduction, each plot consists of a canvas on page 24-1053 containing one or more scenes on page 24-1084. Using `Header` and `Footer`, you can set captions for both levels of nesting, above and/or below the contents.

To change the appearance of the captions, please use the attributes `FooterAlignment` and `HeaderAlignment` for positioning and `FooterFont` and `HeaderFont` to control fonts and sizes.

## Examples

### Example 1

The easiest way of setting a caption is to include a canvas-caption in a `plot` command:

```
plot(plot::Function2d(sin(x), x = 0..2*PI),  
      Footer = "the sine function"):
```

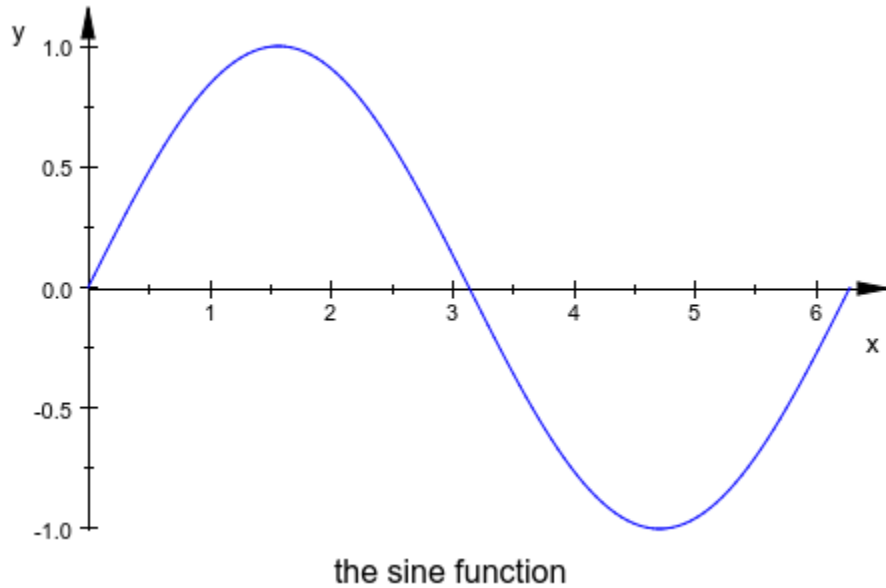

You can also set style controlling attributes in this context:

```
plot(plot::Function2d(sin(x), x = 0..2*PI),  
      Header = "the sine function",  
      HeaderFont = ["Monotype Corsiva", 17, RGB::Red],  
      HeaderAlignment = Left):
```

*the sine function*

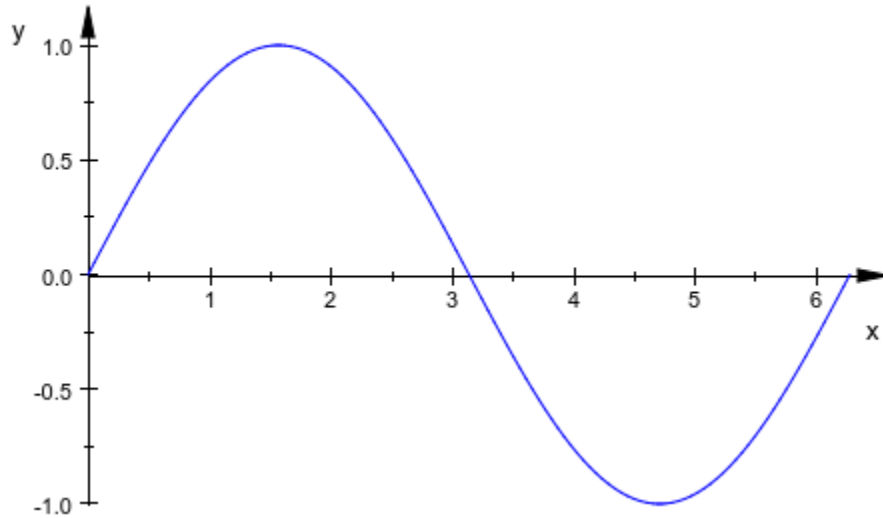

## Example 2

Advanced users may want to plot several scenes together. These can be given individual captions:

```
f1 := plot::Function3d(sin(x^2 + y^2)*(x^2 + y^2),  
                      x = -3..3, y = -3 ..3,  
                      AdaptiveMesh = 0):  
f2 := plot::modify(f1, AdaptiveMesh = 2):  
  
s1 := plot::Scene3d(f1, Footer = "AdaptiveMesh = 0"):  
s2 := plot::Scene3d(f2, Footer = "AdaptiveMesh = 2"):  
plot(s1, s2, Layout = Horizontal)
```

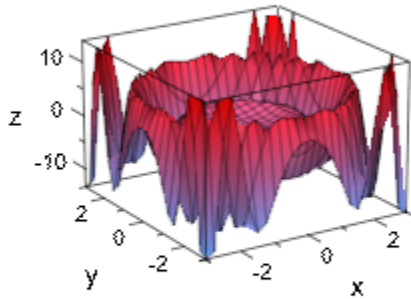

AdaptiveMesh = 0

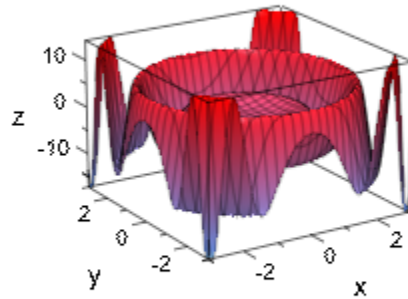

AdaptiveMesh = 2

## See Also

### MuPAD Functions

[FooterAlignment](#) | [FooterFont](#) | [HeaderAlignment](#) | [HeaderFont](#) | [Title](#)



# FooterAlignmentHeaderAlignment

Alignment of footer of canvas and scenes

## Value Summary

FooterAlignment, HeaderAlignment	Inherited	Center, Left, or Right
-------------------------------------	-----------	------------------------

## Graphics Primitives

Objects	Default Values
plot::Canvas, plot::Scene2d, plot::Scene3d	FooterAlignment, HeaderAlignment: Center

## Description

Using the attributes `Footer` and `Header`, a canvas or scene can be given a caption. `FooterAlignment` and `HeaderAlignment` control the horizontal alignment of these captions.

## Examples

### Example 1

Using the default placement, a footer is centered:

```
plot(plot::Point2d([1,1]), Footer="Point2d")
```

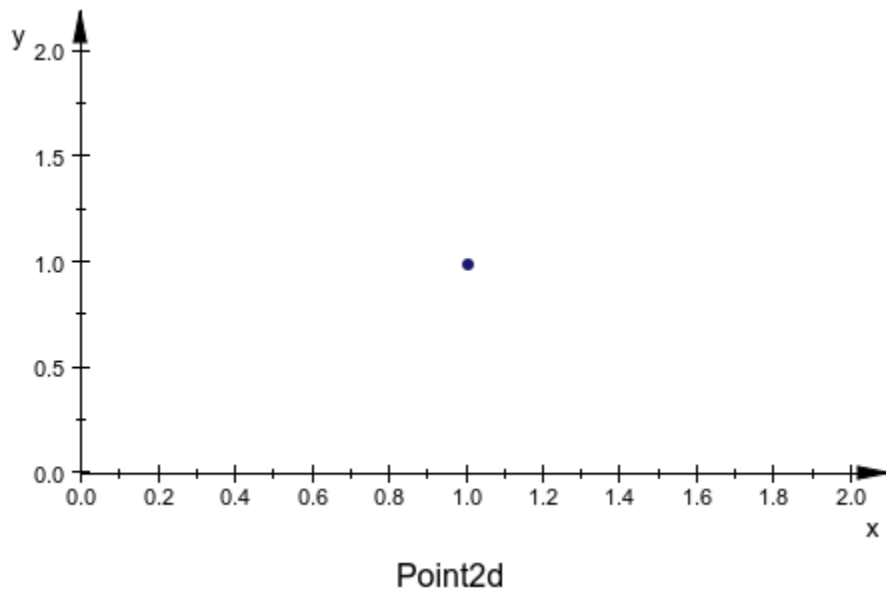

We may want to place the footer more to the right:

```
plot(plot::Point2d([1,1]), Footer="Point2d",  
      FooterAlignment = Right)
```

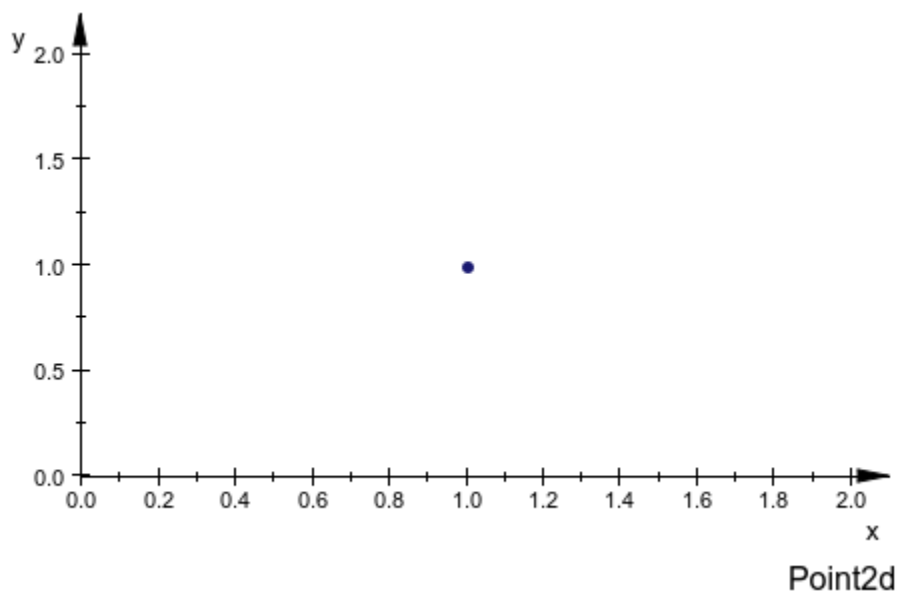

## See Also

### MuPAD Functions

[Footer](#) | [FooterFont](#) | [Header](#) | [HeaderFont](#) | [HorizontalAlignment](#) | [LegendAlignment](#) | [VerticalAlignment](#)

## HorizontalAlignmentTitleAlignmentVerticalAlignment

Horizontal alignment of text objects w.r.t. their coordinates

### Value Summary

HorizontalAlignment, TitleAlignment	Inherited	Center, Left, or Right
VerticalAlignment	Inherited	BaseLine, Bottom, Center, or Top

### Graphics Primitives

Objects	Default Values
plot::Text2d, plot::Text3d	HorizontalAlignment: Left TitleAlignment: Center VerticalAlignment: BaseLine
plot::Integral	HorizontalAlignment: Left TitleAlignment: Center VerticalAlignment: Bottom

### Description

TitleAlignment controls the interpretation of the TitlePosition of the titles of graphical objects.

HorizontalAlignment and VerticalAlignment control the interpretation of the coordinates of text objects.

Titles on page 24-1629 of graphical objects are placed at the position defined by `TitlePosition`. `TitleAlignment` determines whether the beginning, the center, or the end of the title text is aligned at this position. See “Example 1” on page 24-1597 (Symbolic Math Toolbox).

Text objects (i.e., objects of type `plot::Text2d` or `plot::Text3d`) carry, in their `Position` attribute, a position. `HorizontalAlignment` and `VerticalAlignment` together determine which point of the text this position refers to. For example, with `HorizontalAlignment = Left` and `VerticalAlignment = Bottom`, the given position is the lower left corner of the rendered text.

## Examples

### Example 1

We plot three points with title positions 0.1 above each point. The titles are aligned such that the beginning of the text (`Left`), the center of the text (`Center`), or the end of the text (`Right`) is at the `TitlePosition`:

```
plot(plot::Point2d(0, 0, Title = "Point 1",
                  TitlePosition = [0, 0.1],
                  TitleAlignment = Left),
      plot::Point2d(1, 1, Title = "Point 2",
                  TitlePosition = [1, 1.1],
                  TitleAlignment = Center),
      plot::Point2d(2, 2, Title = "Point 2",
                  TitlePosition = [2, 2.1],
                  TitleAlignment = Right),
      PointSize = 2.5*unit::mm)
```

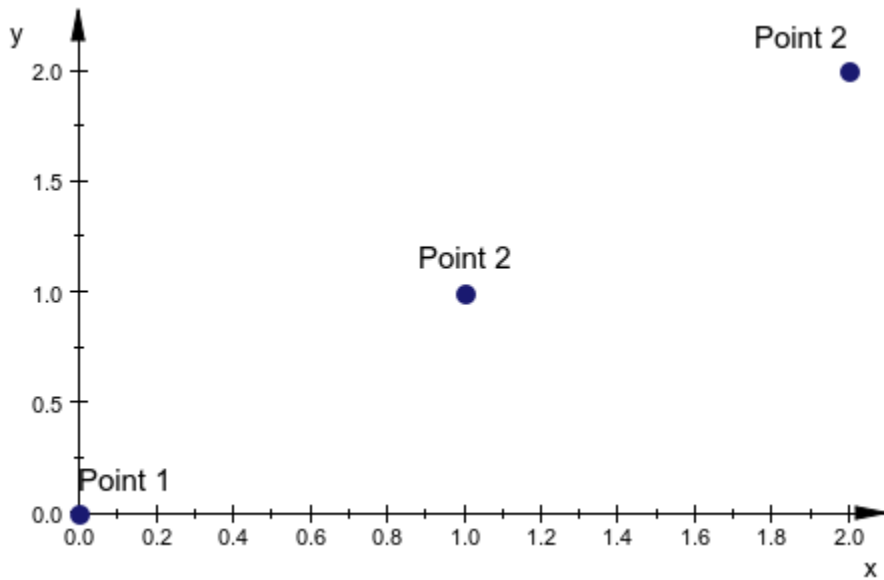

## Example 2

The following call generates a table showing all the combinations of `HorizontalAlignment` and `VerticalAlignment`:

```
Hor := [Left, Center, Right]:
Vert := [Top, BaseLine, Center, Bottom]:
plot((plot::Text2d(expr2text(Hor[i], Vert[j])), [i, j],
    HorizontalAlignment = Hor[i],
    VerticalAlignment = Vert[j]),
    plot::Point2d([i, j], Color = RGB::Black))
    $ i = 1..3 $ j = 1..4, Axes = None,
    TitleFont = [13], PointSize = 2.5*unit::mm)
```

● Left, Bottom

● Center, Bottom

● Right, Bottom

● Left, Center

● Center, Center

● Right, Center

● Left, BaseLine

● Center, BaseLine

● Right, BaseLine

● Left, Top

● Center, Top

● Right, Top

delete Hor, Vert:

## See Also

### MuPAD Functions

Position | Title | TitlePosition

## Legend

Makes a legend entry

## Value Summary

Library wrapper for "LegendText, LegendEntry, and LegendVisible"	See below
--	-----------

## Description

Legend makes a legend entry and activates the legend.

Legend is a library wrapper which sets a `LegendText` and simultaneously switches the legend on by setting `LegendEntry` and `LegendVisible` to `TRUE`.

## Examples

### Example 1

Legend is used to set a `LegendText` for the function and activate the legend. The line does not appear in the legend:

```
plot(plot::Function2d(cos(x), x = 0..2*PI, Legend = "cos(x)"),  
      plot::Line2d([0, 1], [4, cos(4)], Color = RGB::Black))
```



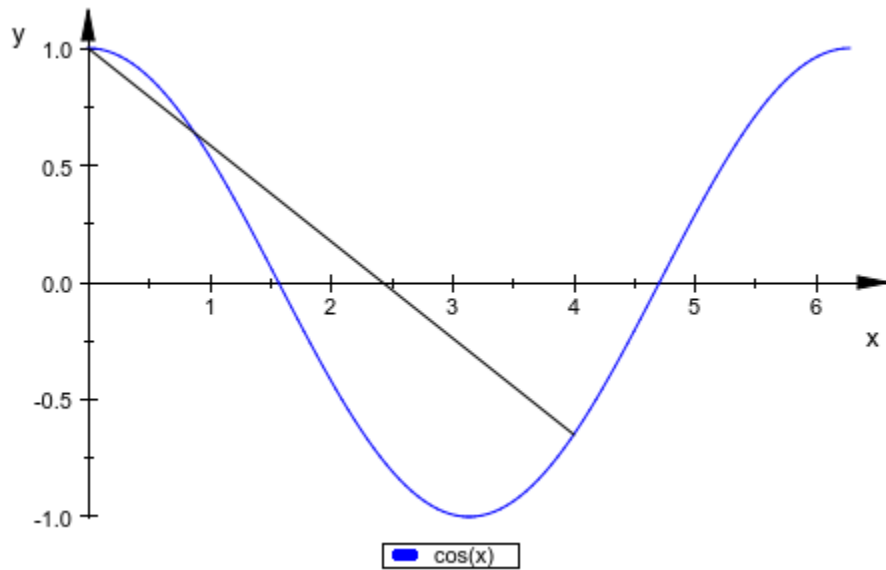

## See Also

### MuPAD Functions

[LegendAlignment](#) | [LegendEntry](#) | [LegendPlacement](#) | [LegendText](#) | [LegendVisible](#)

## Topics

“Legends” (Symbolic Math Toolbox)

## LegendEntry

Add this object to the legend?

### Value Summary

Inherited	FALSE, or TRUE
-----------	----------------

### Description

`LegendEntry` turns legend entries of individual objects on and off, if `LegendVisible` is `TRUE`.

---

**Note** `LegendEntry` is a technical internal attribute. You will most likely want to use the library interface attribute `Legend` in order to set legend entries.

---

If legends are active (i.e., `LegendVisible` is set to `TRUE`), `LegendEntry` controls which objects have entries in the legend. Only objects with `LegendEntry = TRUE` show up there.

As long as `LegendVisible` has its default value of `FALSE`, `LegendEntry` has no effect whatsoever.

### Examples

#### Example 1

By default, functions have `LegendEntry = TRUE`, while, e.g., lines do not:

```
plot(plot::Function2d(cos(x), x = 0..2*PI, Name = "cos(x)"),
      plot::Line2d([0, 1], [4, cos(4)], Name = "cos(0) .. cos(4)",
                   Color = RGB::Black),
      LegendVisible)
```

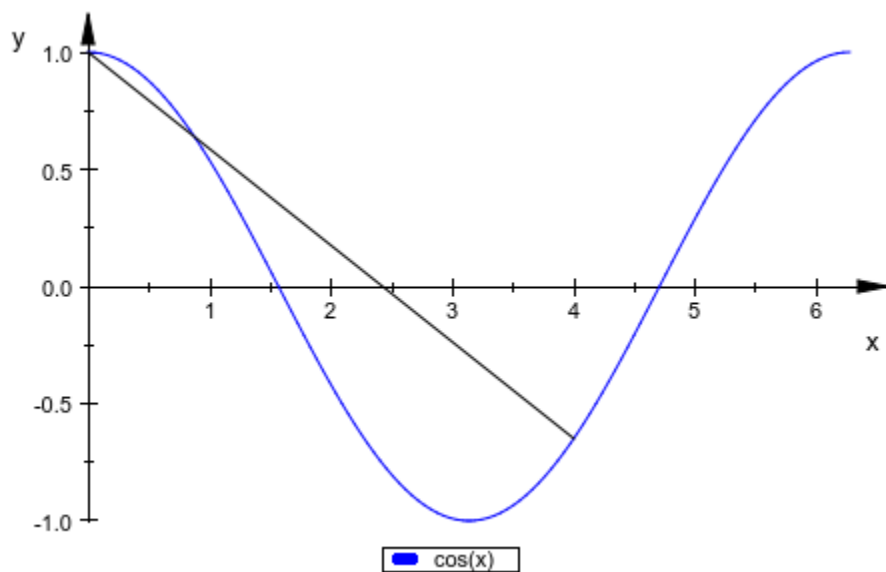

Use LegendEntry to turn on the legend entry for the line:

```
plot(plot::Function2d(cos(x), x = 0..2*PI, Name = "cos(x)"),  
      plot::Line2d([0, 1], [4, cos(4)], Name = "cos(0) .. cos(4)",  
                  Color = RGB::Black, LegendEntry = TRUE),  
      LegendVisible)
```

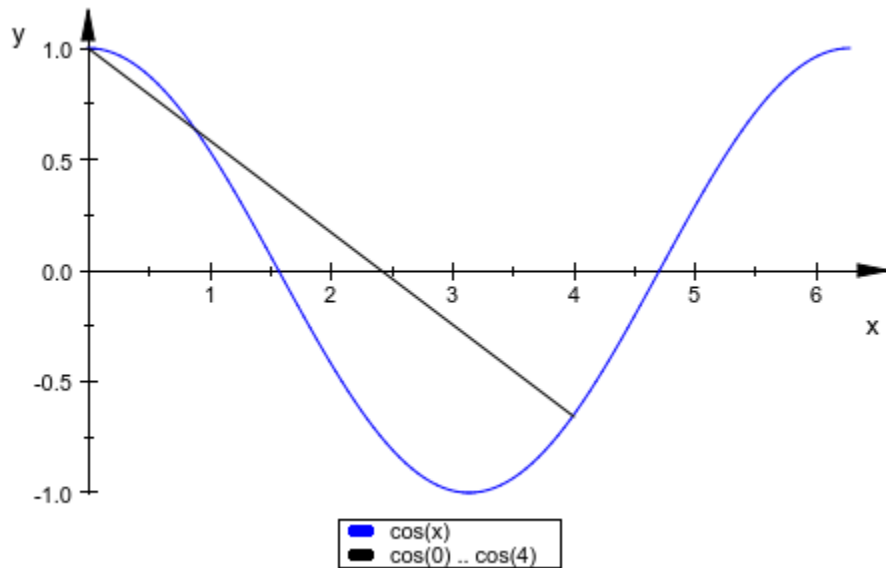

## See Also

### MuPAD Functions

[Legend](#) | [LegendAlignment](#) | [LegendPlacement](#) | [LegendText](#) | [LegendVisible](#)

### Topics

“Legends” (Symbolic Math Toolbox)

# LegendAlignmentLegendPlacementLegendVisible

Legend at left, center, or right

## Value Summary

LegendAlignment	Inherited	Center, Left, or Right
LegendPlacement	Inherited	Bottom, or Top
LegendVisible	Inherited	FALSE, or TRUE

## Graphics Primitives

Objects	Default Values
plot::Scene2d, plot::Scene3d	LegendAlignment: Center LegendPlacement: Bottom LegendVisible: FALSE

## Description

LegendVisible activates a legend identifying the individual objects in a plot.

LegendAlignment and LegendPlacement control the placement of this legend.

For complex plots with multiple objects, it is often helpful to include an explanation in form of a legend that states the connection from object color to object meaning.

The entry for “object meaning” is usually not provided automatically but must be given using LegendText. As an exception, plotfunc2d and plotfunc3d set the function terms as “meaning”. Cf. “Example 1” on page 24-1606 (Symbolic Math Toolbox).

Using `LegendPlacement`, the legend can be moved from below the plot to above it. `LegendAlignment` controls whether the legend is displayed flush left, flush right, or centered (which is the default).

## Examples

### Example 1

When plotting more than one object, `plotfunc2d` and `plotfunc3d` set `LegendVisible = TRUE`:

```
plotfunc2d(sin(x), cos(x))
```

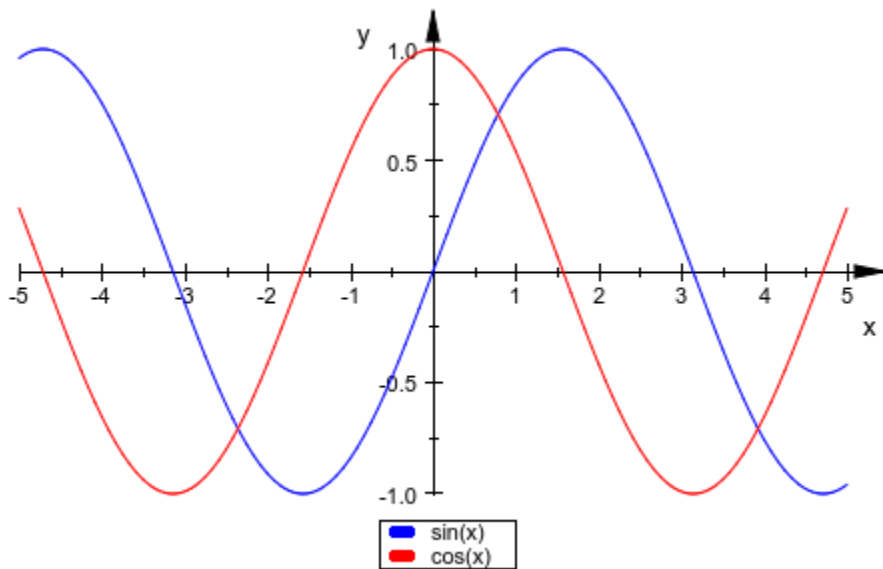

It is possible to explicitly switch this automatic legend off:

```
plotfunc2d(sin(x), cos(x), LegendVisible = FALSE)
```

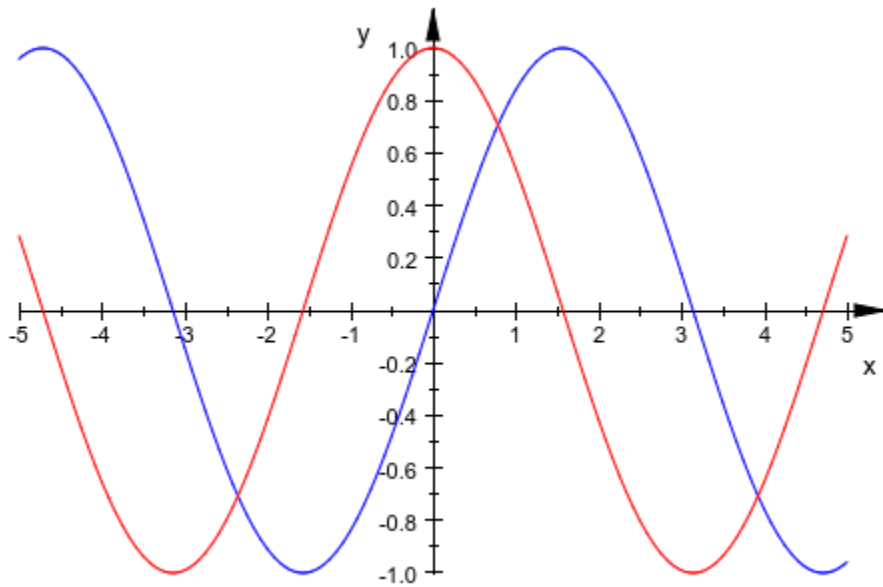

Using `LegendPlacement` and `LegendAlignment`, we place the legend in the upper right corner of the graphics:

```
plotfunc2d(sin(x), cos(x),  
           LegendPlacement = Top, LegendAlignment = Right)
```

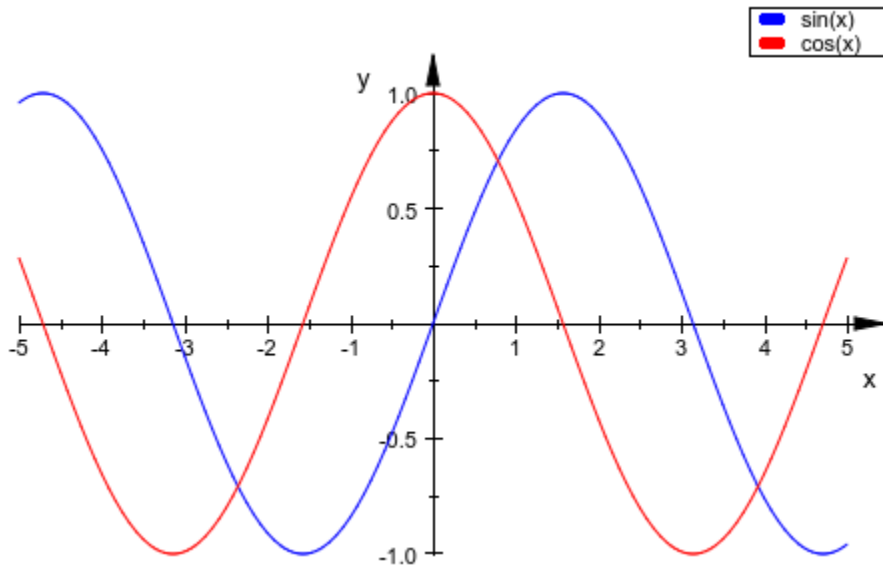

## Example 2

When plotting many objects with active legend entries, the legend is abbreviated: It will never take up more than half of the scene height and it will not contain more than 20 entries:

```
plotfunc2d(-i*x^3+i/10*x^2+x-i $ i = -15..15, x=-1..1)
```



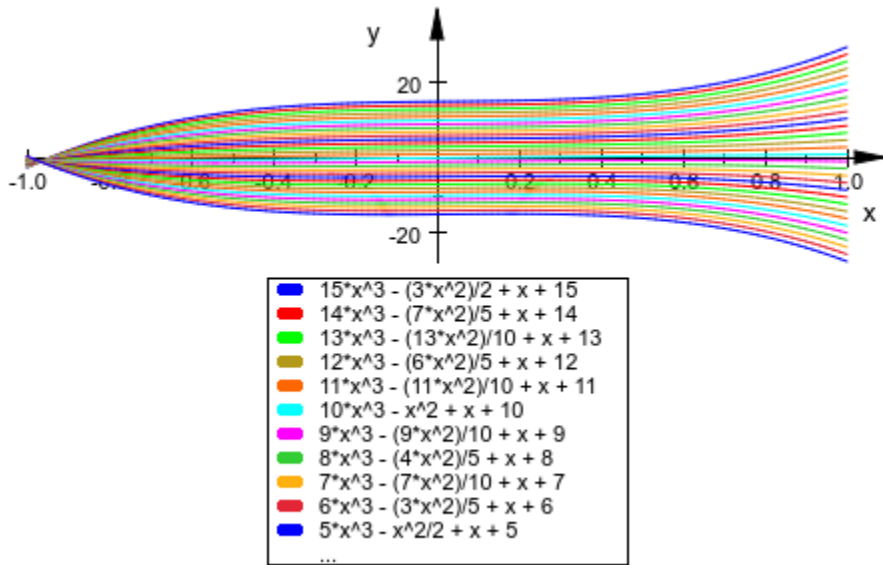

```
plotfunc2d(-i*x^3+i/10*x^2+x-i $ i = -15..15, x=-1..1,
           Height = 15*unit::cm)
```

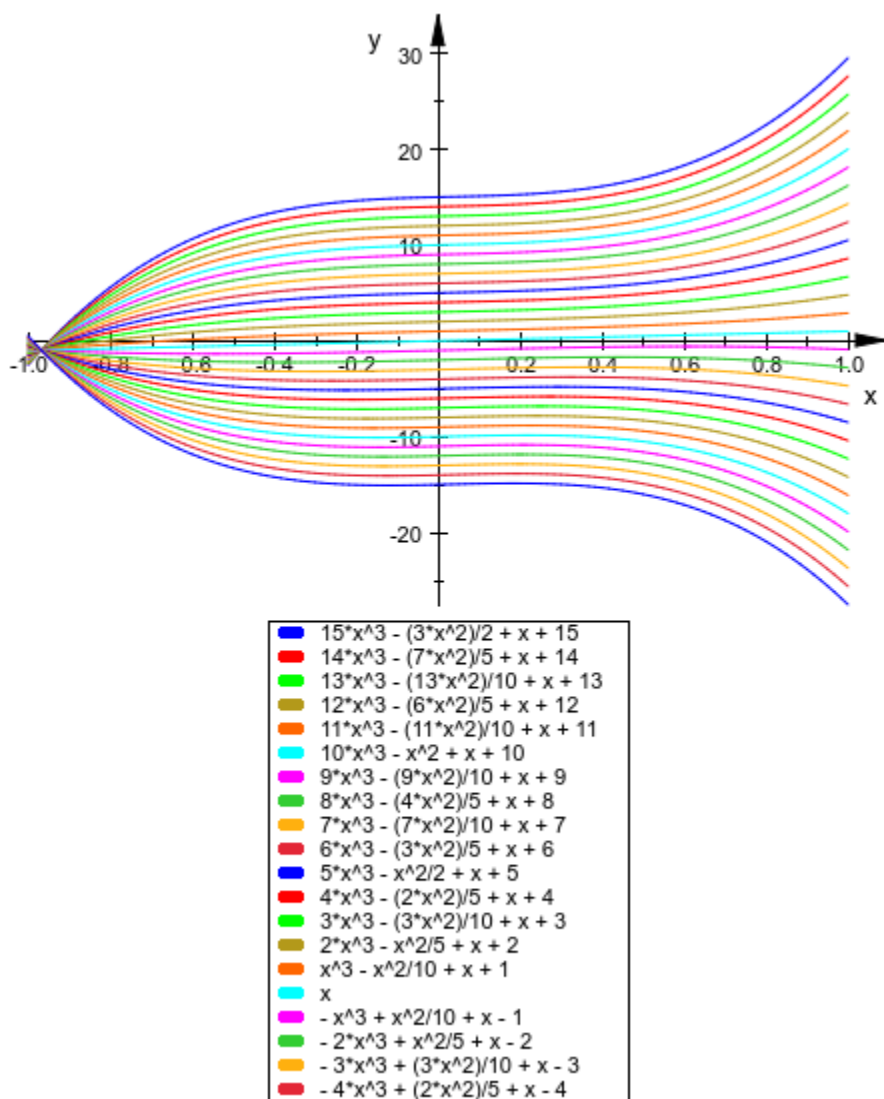

## See Also

### **MuPAD Functions**

[Legend](#) | [LegendFont](#) | [LegendText](#)

## LegendText

Short explanatory text for legend

### Value Summary

Optional	Text string
----------	-------------

### Description

LegendText sets the text for the legend entry of an object.

---

**Note** LegendText is a technical internal attribute. You will most likely want to use the library interface attribute **Legend** in order to set legend entries.

---

To have a legend entry, the object must have **Legend** set to TRUE and **LegendVisible** must be TRUE for the enclosing scene. Cf. “Example 1” on page 24-1612 (Symbolic Math Toolbox).

If **LegendText** is unset, but **Legend** and **LegendVisible** are TRUE, the legend entry is taken from the attribute **Name**. If that is unset, too, the name of the object type is displayed. Cf. “Example 2” on page 24-1614 (Symbolic Math Toolbox).

## Examples

### Example 1

We create a few objects with values for LegendText set:

```
f := plot::Function2d(sin(x), x = 0..PI,  
                      LegendText = "f(x)", Color = RGB::Red):  
g := plot::Function2d(cos(x), x = 0..PI,  
                      LegendText = "f'(x)", Color = RGB::Blue):
```

```
p := plot::Point2d([2, sin(2)], PointSize = 3*unit::mm,
  LegendText = "(2; f(2))", Color = RGB::Black):
```

Switching on the legend, we plot these objects:

```
plot(f, g, p, LegendVisible = TRUE)
```

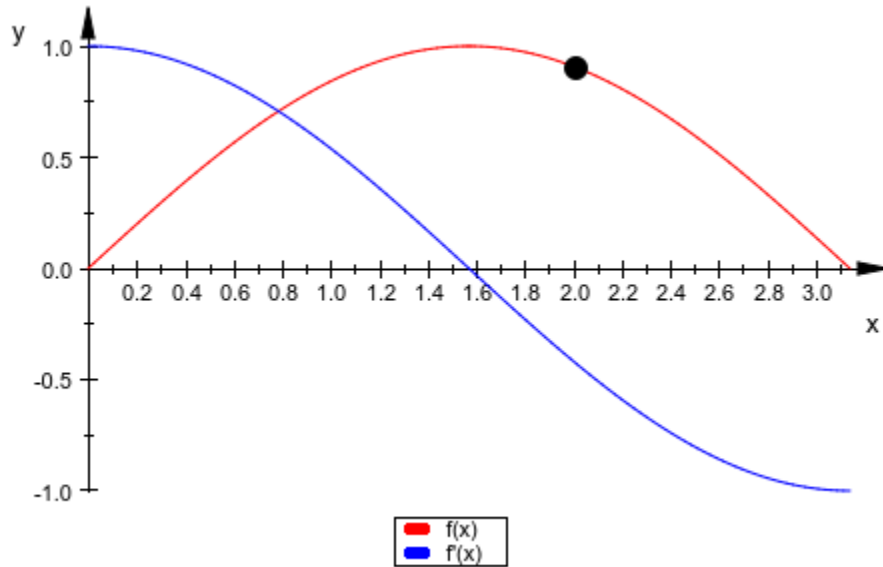

As we can see, only the function objects show up in the legend. If  $p$  is supposed to be shown there, too, we must explicitly set `LegendEntry` to `TRUE`:

```
p::LegendEntry := TRUE:
plot(f, g, p, LegendVisible = TRUE)
```

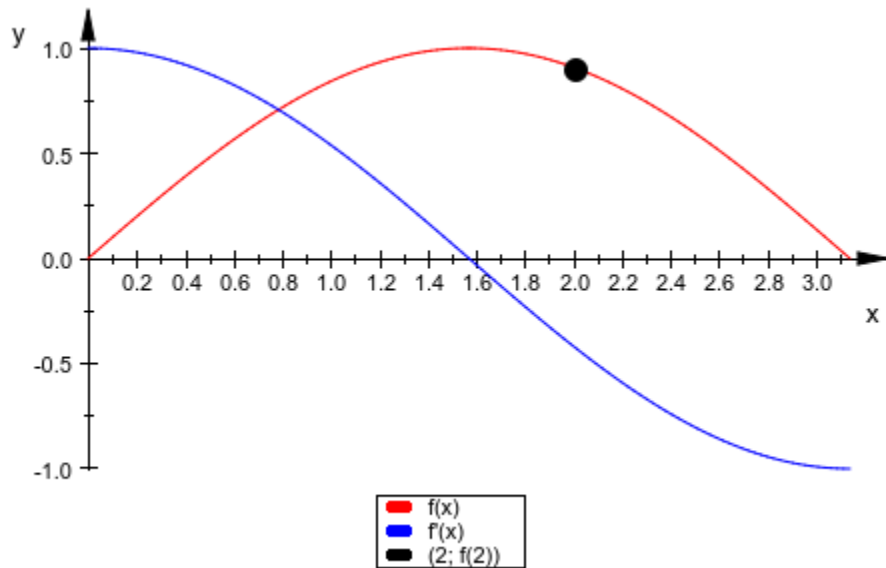

## Example 2

If an object has a legend entry, but `LegendText` is not set, the first fall-back is the `Name` attribute of the object:

```
plot(plot::Function3d(sin(x^2 + y^2), x = -2..2, y = -2..2,
  Color = RGB::Green, FillColorType = Flat,
  LegendText = "LegendText: sin",
  Name = "Name: sin"),
  plot::Function3d(cos(x + y), x = -2..2, y = -2..2,
  Color = RGB::Blue, FillColorType = Flat,
  Name = "Name: cos"),
  LegendVisible)
```

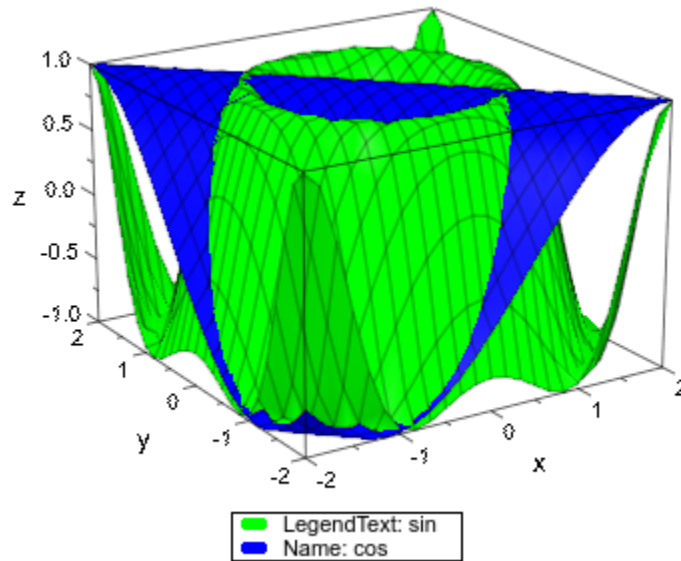

As a last resort, the name of the type of object is used:

```
plot(plot::Rectangle(0..1, 0..1),  
      plot::Point2d(frando(), frando()),  
      plot::Point2d(frando(), frando()),  
      plot::Point2d(frando(), frando()),  
      plot::Point2d(frando(), frando()),  
      plot::Point2d(frando(), frando()),  
      LegendEntry = TRUE, LegendVisible = TRUE)
```

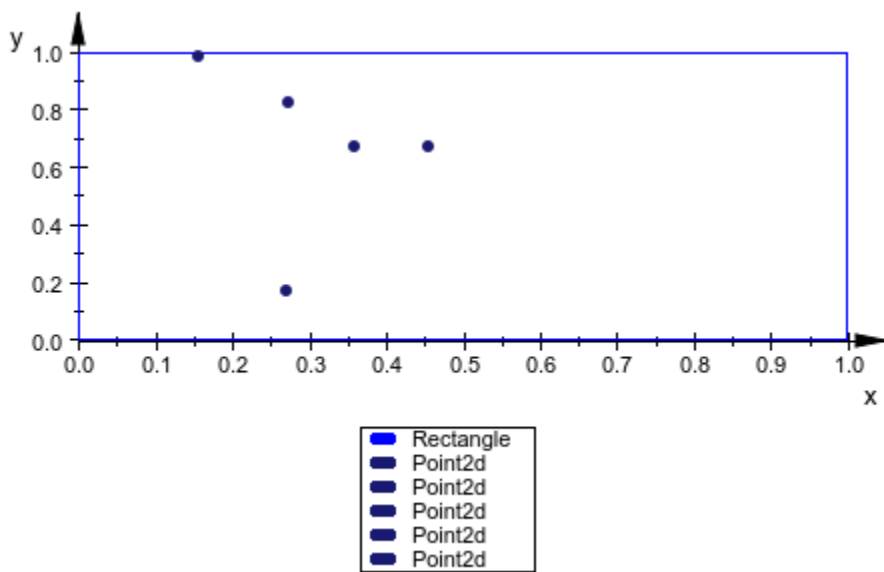

## See Also

### MuPAD Functions

Legend | LegendVisible | Name

### Topics

“Legends” (Symbolic Math Toolbox)



## ShowInfo

Information about integral approximation

### Value Summary

Optional	List of arithmetical expressions
----------	----------------------------------

### Graphics Primitives

Objects	ShowInfo Default Values
<code>plot::Integral</code>	<code>[2, IntMethod, Integral]</code>

### Description

ShowInfo defines the text information displayed by `plot::Integral`.

In `plot::Integral`, text information about the used approximation method on page 24-1295, the values of the approximation and the exact integral, the number of subintervals on page 24-1343 and the error of the approximation can be displayed within the approximation object.

The attribute is specified by `ShowInfo = [entry1, entry2, ...]` with a list of various entries. The user may specify the entries in arbitrary order.

If the list is empty, no text information is displayed.

Each entry in the list can be of one of the following types:

- an arbitrary string on page 7-53

In the text, this entry is appended to the current line. No white space or line break is prepended or appended. The string itself, however, may contain white space or a line break (given by `\n`).

- "" (empty string)

This inserts an empty line in the text.

- IntMethod

In the text, this creates a new line

```
name: float_value,
```

where `name` is the value of the attribute `IntMethod` and `float_value` is the numerical value of the integral approximation. This value is computed internally and inserted in the text, automatically.

- IntMethod = name

In the text, this creates a new line

```
name: float_value,
```

where `float_value` is the numerical value of the integral approximation.

If `name` is one of the flags `RiemannLower` etc. listed on the help page of the attribute `IntMethod`, this flag is displayed in the text.

Alternatively, `name` may be a string on page 7-53. When `name` is the empty string "", only the numerical approximation of the integral value is displayed.

- Integral

In the text, this creates a new line

```
Integral: float_value,
```

where `float_value` is a high precision float approximation of the exact integral value.

- Integral = string

In the text, this creates a new line

```
string: float_value,
```

where `string` is an arbitrary text string and `float_value` is a high precision float approximation of the exact integral value .

---

When `string` is the empty string "", only the high precision approximation `float_value` is displayed.

- Error

In the text, this creates a new line

```
Error: float_value,
```

where `float_value` is the absolute difference between the numerical value obtained by the chosen approximation method and a high precision float approximation of the exact integral value.

- Error = string

In the text, this creates a new line

```
string: float_value,
```

where `string` is an arbitrary text string and `float_value` is the absolute difference between the numerical value obtained by the chosen approximation method and a high precision float approximation of the exact integral value.

When `string` is the empty string "", only the absolute quadrature error `float_value` is displayed.

- Nodes

In the text, this creates a new line

```
Nodes: n,
```

where the integer `n` is the number of intervals used for the integral approximation.

- Nodes = string

In the text, this creates a new line

```
string: n,
```

where `string` is an arbitrary text string and the integer `n` is the number of intervals used for the integral approximation.

When `string` is the empty string "", only the integer `n` is displayed.

- `Position = [X, Y]`

This entry determines the position of the text information. X and Y are the coordinates of the anchor point of the text. The alignment of the text with respect to the anchor point can be chosen by the attributes `HorizontalAlignment` and `VerticalAlignment`.

- a positive integer `digits`

The integer `digits` determines the number of digits after the decimal point for all following float values.

Different float values can be displayed with a different number of digits by inserting several `digits` entries at appropriate positions in the list.

Without an explicit specification of `Position = [X, Y]`, the text is positioned automatically.

## Examples

### Example 1

By default, the approximation method, the value of approximation and the integral is displayed with 2 digits after the decimal point:

```
f := plot::Function2d(x^2, x = -5..5, Color = RGB::DarkGrey):  
plot(plot::Integral(f, IntMethod = RiemannLower), f)
```

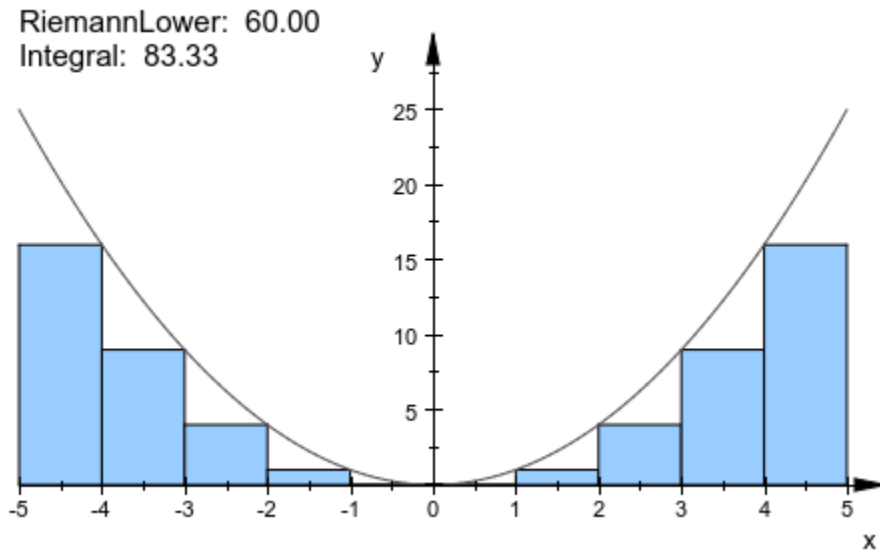

This call is equivalent to:

```
plot(plot::Integral(f, IntMethod = RiemannLower,
  ShowInfo = [2, IntMethod, Integral]), f):
```

The text can be changed:

```
plot(plot::Integral(f, IntMethod = RiemannLower,
  ShowInfo = [IntMethod = "value of the lower Riemann sum",
  Integral = "exact numerical value",
  Error = "difference"]), f)
```

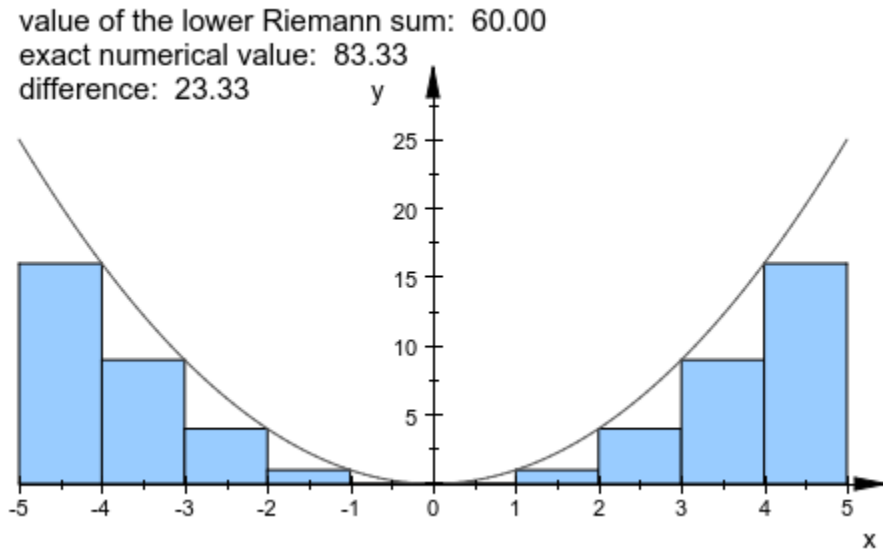

delete f:

## Example 2

The position can be specified explicitly. In this case, the entries to be displayed must be specified explicitly, too. The text attribute `VerticalAlignment` aligns the text object:

```
f := plot::Function2d(x^2, x = -5..5, Color = RGB::DarkGrey):
plot(plot::Integral(f, IntMethod = RiemannUpper, Color = RGB::Lime,
  ShowInfo = [IntMethod, Integral,
    Position = [-5, -1]],
  VerticalAlignment = Top),
  plot::Integral(f, IntMethod = RiemannLower, Color = RGB::Gold,
    ShowInfo = [IntMethod,
      Position = [0, -1]],
    VerticalAlignment = Top),
  f)
```

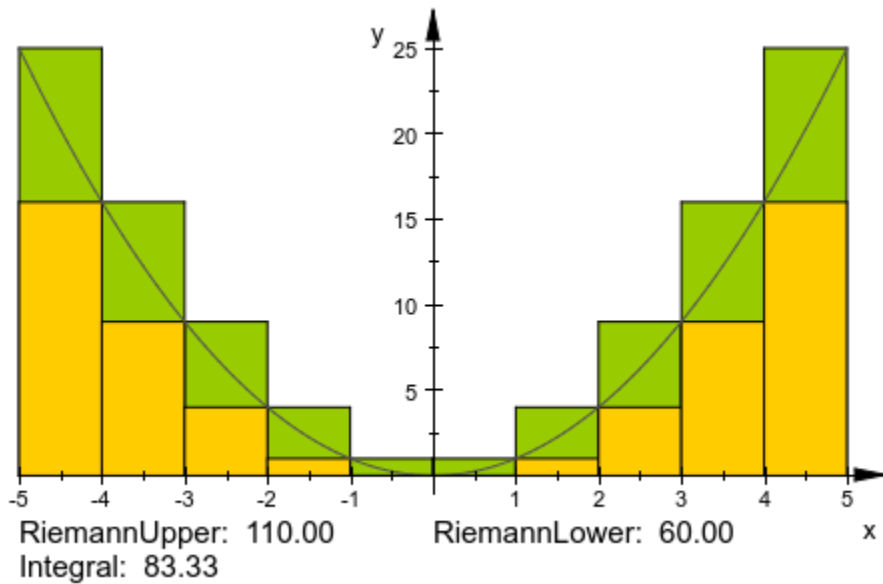

delete f:

### Example 3

The number of digits after the decimal point can be specified for each value. In the following example all values are displayed with four digits:

```
f := plot::Function2d(x^2*(x-4)*(x+2), x = -3..5,
                    Color = RGB::Black):
plot(plot::Integral(f, 4, IntMethod = Simpson,
                  LineColor = RGB::Red,
                  ShowInfo = [4, IntMethod, Integral, Error]),
     f)
```

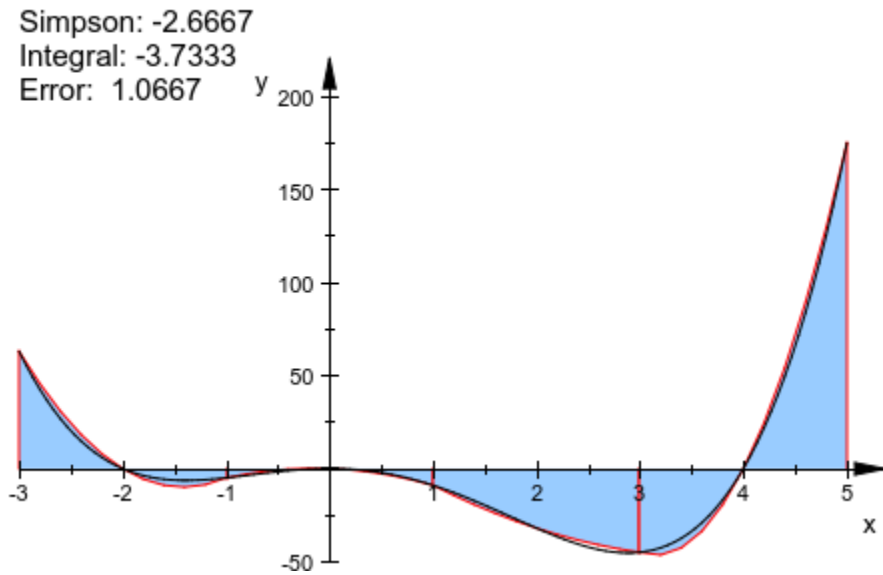

Only the error shall be displayed with four digits after the decimal point. All other values are shown with only one digit:

```
plot(plot::Integral(f, 4, IntMethod = Simpson, LineColor = RGB::Red,  
                ShowInfo = [1, IntMethod, Integral, 4, Error]),  
      f)
```



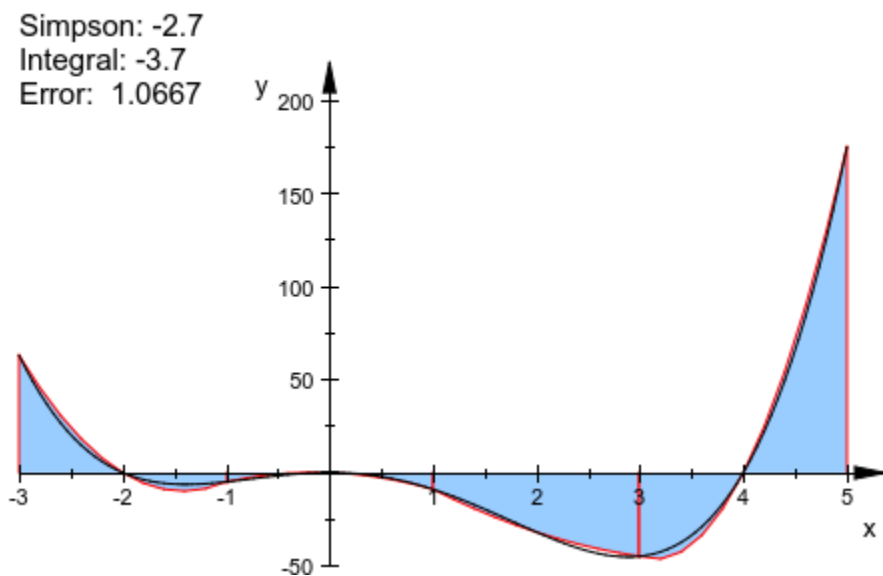

delete f:

#### Example 4

Two approximation objects shall be displayed in one plot. To prevent collision of the automatically positioned texts, we insert an empty line into the text of one of the objects to prevent collision of the automatically positioned texts:

```
f := plot::Function2d(x^2, x = -5..5, Color = RGB::DarkGrey):
plot(plot::Integral(f, IntMethod = RiemannUpper, Color = RGB::Rose,
  ShowInfo = [IntMethod, "", Integral]),
  plot::Integral(f, IntMethod = RiemannLower,
  ShowInfo = [IntMethod, Integral]),
  f)
```

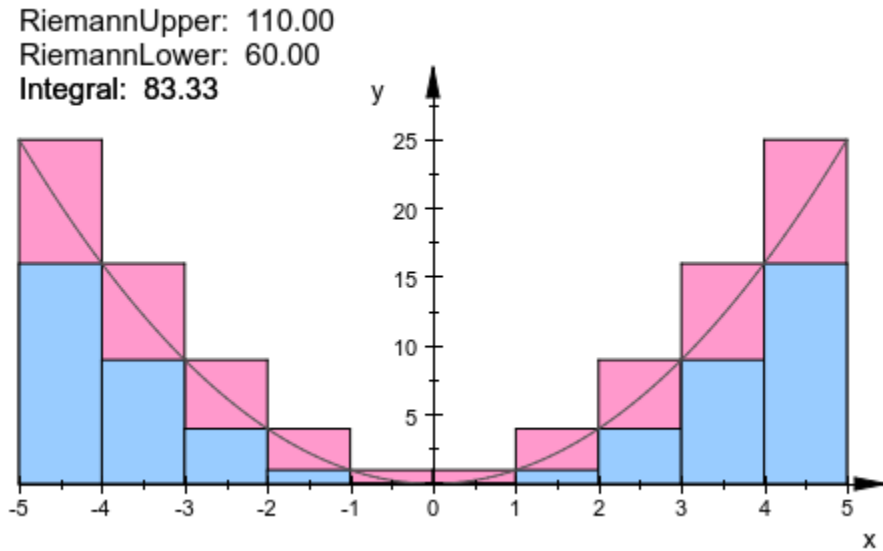

Alternatively, the position can be given explicitly:

```
f := plot::Function2d(x^2, x = -5..5, Color = RGB::DarkGrey):
plot(plot::Integral(f, IntMethod = RiemannUpper, Color = RGB::Lime,
  ShowInfo = [IntMethod, Integral,
    Position = [-5, -1]],
  VerticalAlignment = Top),
  plot::Integral(f, IntMethod = RiemannLower, Color = RGB::Gold,
  ShowInfo = [IntMethod,
    Position = [0, -1]],
  VerticalAlignment = Top),
  f)
```

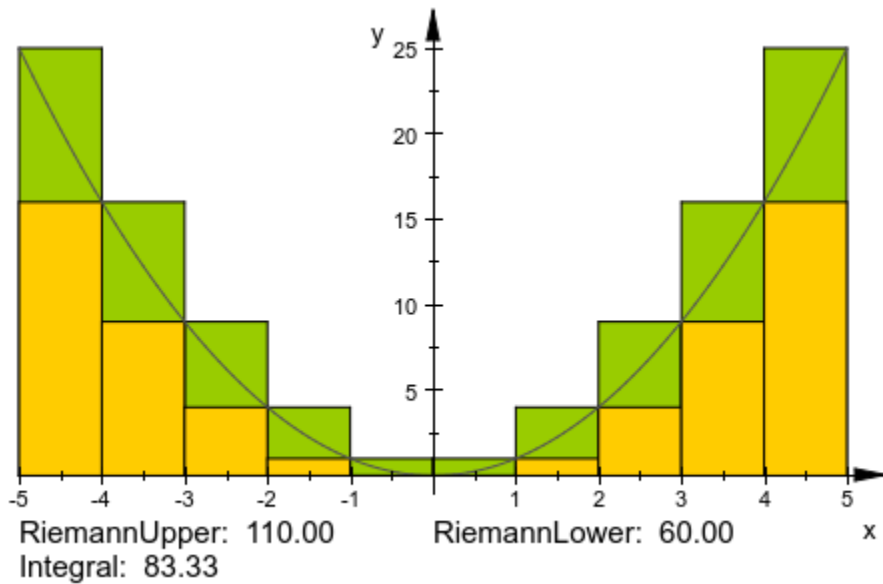

delete f:

## Example 5

The text may contain additional messages:

```
f := plot::Function2d(x^2, x = -5..5):
plot(plot::Integral(f, IntMethod = RiemannUpper,
  ShowInfo = ["Approximation value:", IntMethod = "",
    "\nUsed rectangles:", Nodes = ""],
  Color = RGB::Rose),
  f)
```

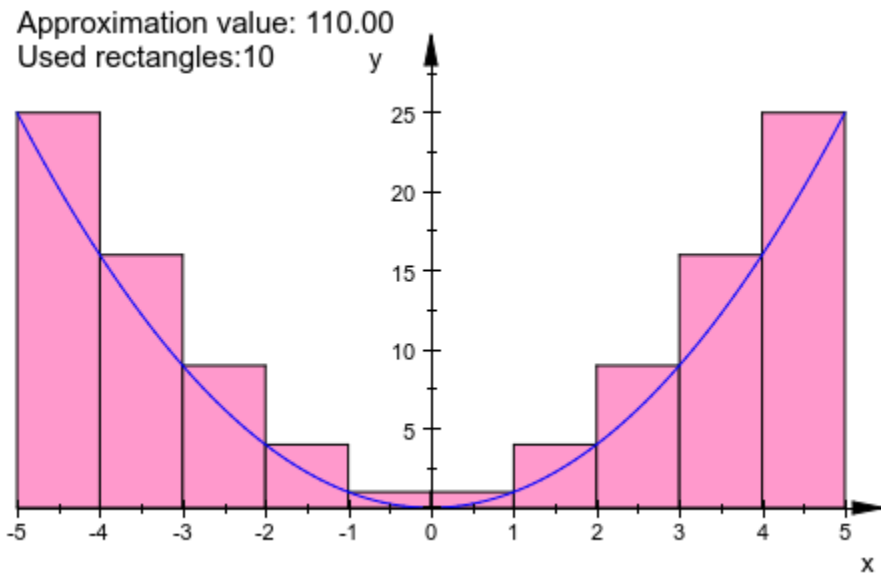

delete f:

## See Also

### MuPAD Functions

HorizontalAlignment | IntMethod | TextFont | TextRotation |  
VerticalAlignment

# TitleTitles

Object title

## Value Summary

Title, Titles	Optional	Text string
---------------	----------	-------------

## Graphics Primitives

Objects	Default Values
plot::Piechart2d, plot::Piechart3d	Titles: [" "]

## Description

Title sets the title of an object to be displayed in the graphics.

Titles is a list of titles for parts of an object, e.g., the pieces of a pie chart on page 24-562.

Using Title, any graphical object can be given a title that will be displayed at the position given by the TitlePosition attribute.

The Title can additionally be horizontally aligned at the TitlePosition via TitleAlignment.

The object attribute Visible also affects the object's title: Invisible objects do not show their titles.

Titles is used to set a number of titles for sub-objects, such as the bars of a bar plot or the segments of a pie chart. These do not react to TitlePosition.

Title and Titles cannot be animated. But note that TitlePosition can.

## Examples

### Example 1

The default positioning of a title relative to `TitlePosition` is to have the lower left corner of the title at this place:

```
plot(plot::Point2d(1, 1, Title = "Test",  
                  TitlePosition = [1, 1]))
```

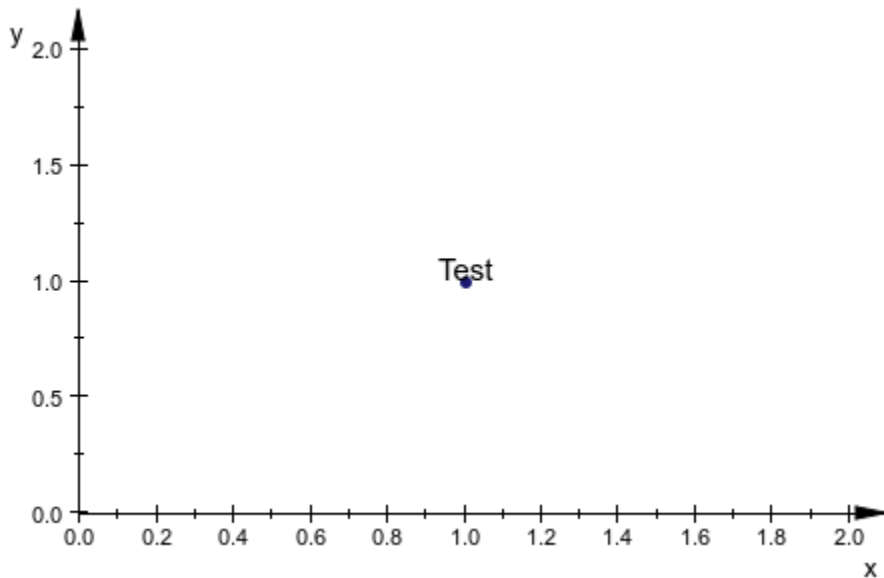

This position depends on the title alignment on page 24-1596:

```
plot(plot::Point2d(1, 1, Title = "Test",  
                  TitlePosition = [1, 1],  
                  TitleAlignment = Left))
```

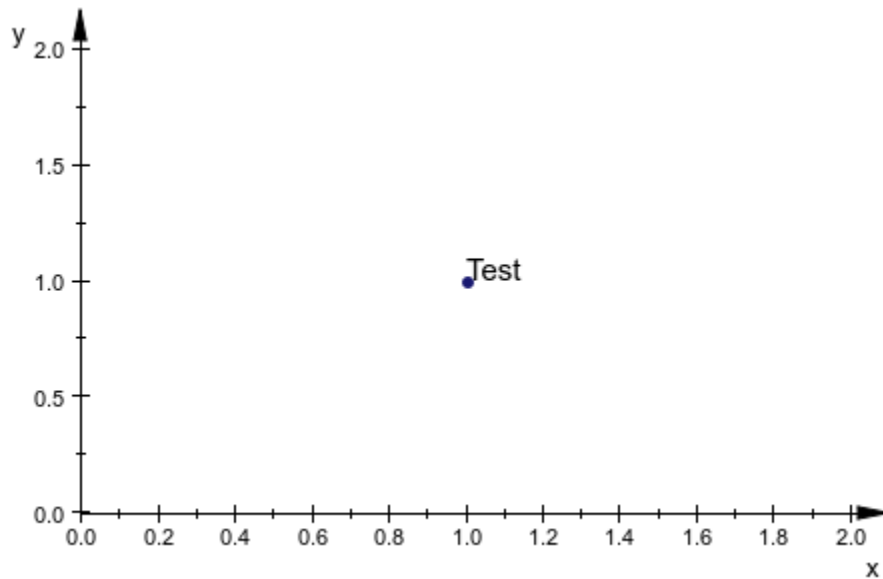

## Example 2

In 3D, titles have so-called “bill-boarding”: Instead of having a fixed orientation, they are always drawn in a readable orientation and their sizes are not affected by zooming and perspective scaling:

```
plot(plot::Point3d(1, 1, 1,  
                  Title = "Nr. 1",  
                  TitlePosition = [1, 1, 1]),  
      plot::Point3d(2, 20, 2,  
                  Title = "Nr. 2",  
                  TitlePosition = [2, 20, 2]),  
      plot::Point3d(10, 10, 10,  
                  Title = "Nr. 3",  
                  TitlePosition = [10, 10, 10]),  
      TitleFont = [30])
```

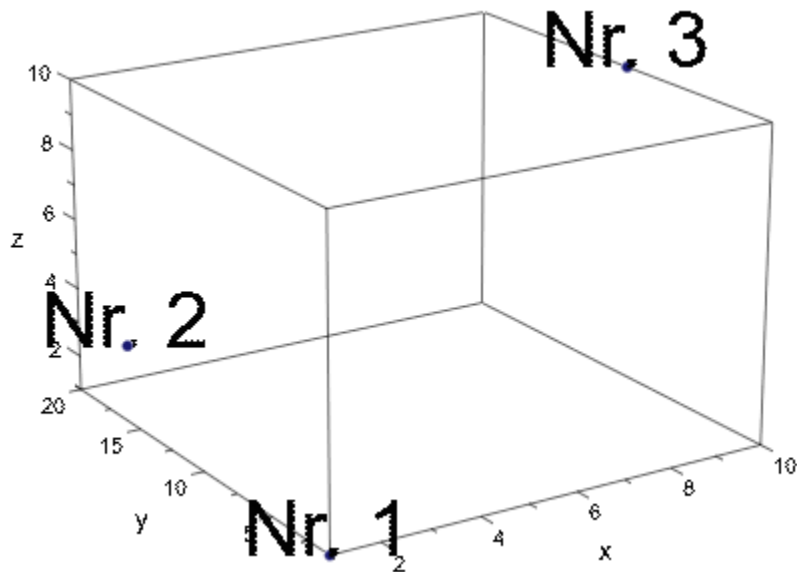

### Example 3

Titles of invisible objects are invisible themselves. This also applies to objects that are temporarily invisible:

```
plot(plot::Point2d(i, i,  
    Title = expr2text(i), TitlePosition = [i+1/10, i],  
    VisibleAfter = i) $ i = 1..5,  
    TimeRange = 0..5,  
    ViewingBox = [0..5, 0..5])
```



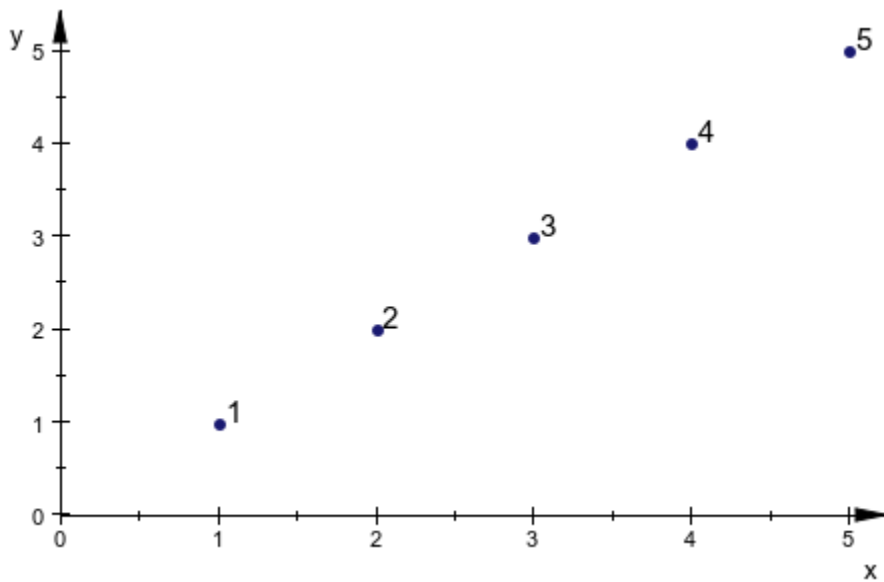

## Example 4

Use `Titles` to label individual parts of statistical plots such as pie charts:

```
plot(plot::Piechart2d([3267, 2629, 4970, 18094,  
                      4189, 1236, 4003, 297],  
      Titles = [ "<= 1900", "1901-1918",  
                "1919-1948", "1949-1978",  
                "1979-1986", "1987-1990",  
                "1991-2000", ">= 2001"])))
```

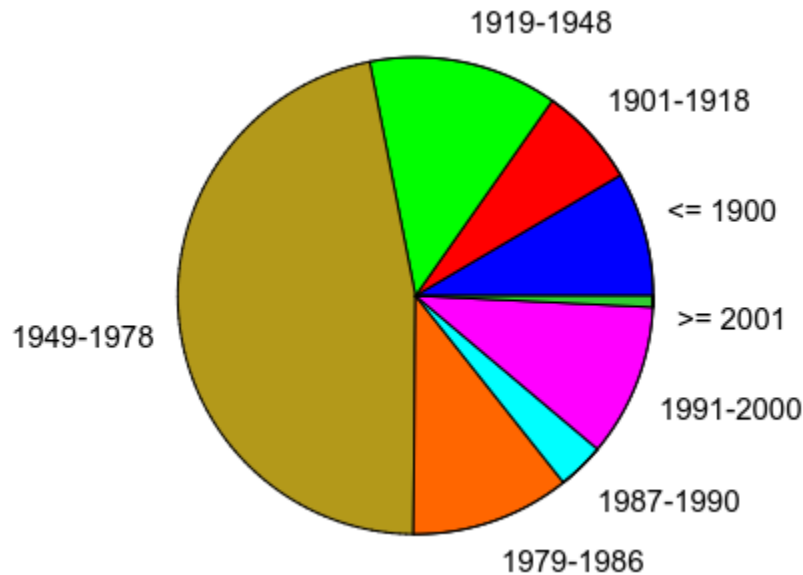

Note that pie charts with many pies are in general tricky to label nicely:

```
p := plot::Piechart3d([10601, 12330, 3388, 2593, 660, 1726,
6078, 1760, 7956, 18052, 4049, 1066,
4384, 2581, 2804, 2411],
Titles = ["Baden-Württemberg", "Bayern", "Berlin",
"Brandenburg", "Bremen",
"Hamburg", "Hessen",
"Mecklenburg-Vorpommern",
"Niedersachsen", "Nordrhein-Westfalen",
"Rheinland-Pfalz", "Saarland", "Sachsen",
"Sachsen-Anhalt", "Schleswig-Holstein",
"Thüringen"]):
plot(p, Header = "Einwohner 2001")
```

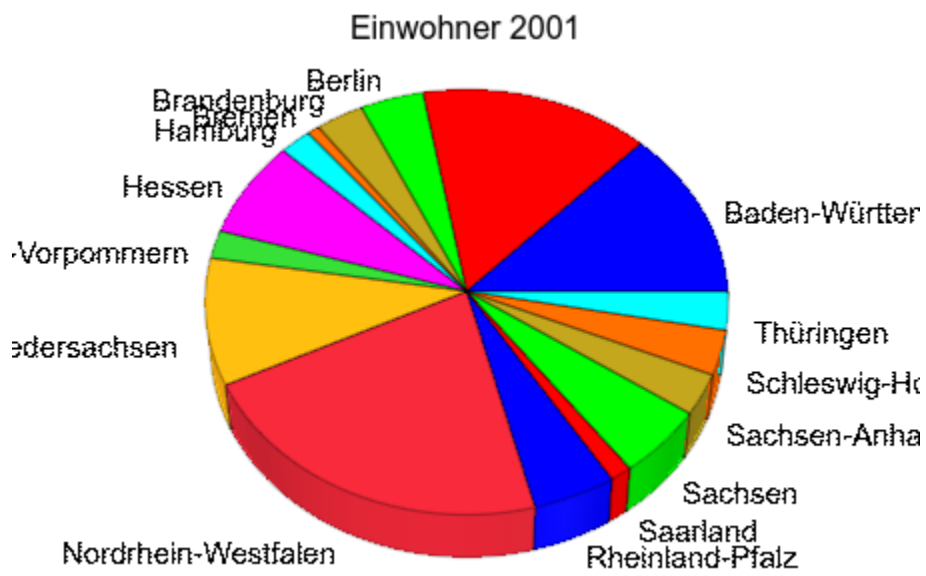

```
p::Moves := [0.3]:  
plot(p, Header = "Einwohner 2001")
```

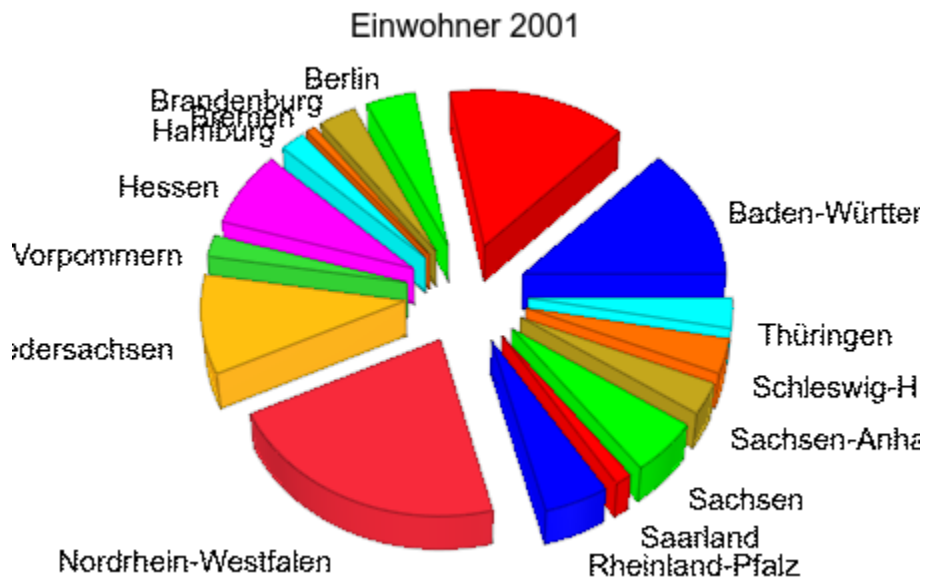

## See Also

### MuPAD Functions

TitleAlignment | TitleFont | TitlePosition

# TitlePositionTitlePositionXTitlePositionYTitlePositionZ

Position of object titles

## Value Summary

TitlePosition	Library wrapper for “[TitlePositionX, TitlePositionY]” (2D), “[TitlePositionX, TitlePositionY, TitlePositionZ]” (3D)	See below
TitlePositionX, TitlePositionY, TitlePositionZ	Optional	MuPAD expression

## Description

TitlePosition sets the position where the object title is displayed.

TitlePositionX, TitlePositionY, and TitlePositionZ refer to the individual components of TitlePosition.

An object can be given a title to be displayed in the graphic with the attribute Title. TitlePosition, TitlePositionX, TitlePositionY, TitlePositionZ determines the position of this title.

TitlePosition, TitlePositionX, TitlePositionY, TitlePositionZ determines the anchor point of the title, which is in 3D displayed in “bill-boarding mode,” which means that the text will always face the observer and will always be displayed in the same size, regardless of zooming or perspective. The alignment of the text w.r.t. the anchor point is further determined by the setting of TitleAlignment, cf. “Example 1” on page 24-1638 (Symbolic Math Toolbox).

MuPAD does not have automatic positioning of titles; to have a title properly positioned, `TitlePosition` must be set.

## Examples

### Example 1

We plot three points with titles attached to them, changing the alignment. For demonstration purposes, the title positions coincide with the points:

```
plot(plot::Point2d(0, 3, Title = "Left", TitlePosition = [0, 3],
                  TitleAlignment = Left),
      plot::Point2d(0, 2, Title = "Center", TitlePosition = [0, 2],
                  TitleAlignment = Center),
      plot::Point2d(0, 1, Title = "Right", TitlePosition = [0, 1],
                  TitleAlignment = Right),
      Axes = None, PointSize = 2.0*unit::mm,
      ViewingBox = [-1..1, 0..4])
```



## Example 2

A more realistic placement of titles is to separate them slightly from the points:

```
plot(plot::Polygon2d([[0, 0], [5, 0], [9/5, 12/5]], Closed),  
      plot::Point2d([0, 0], Title = "A",  
                    TitlePosition = [-0.2, -0.1]),  
      plot::Point2d([5, 0], Title = "B",  
                    TitlePosition = [5.2, -0.1]),  
      plot::Point2d([9/5, 12/5], Title = "C",  
                    TitlePosition = [2.0, 2.5]),  
      Axes = None, TitleFont = [15], LineColor = RGB::Black,  
      LineWidth = 0.5*unit::mm, PointSize = 3*unit::mm)
```

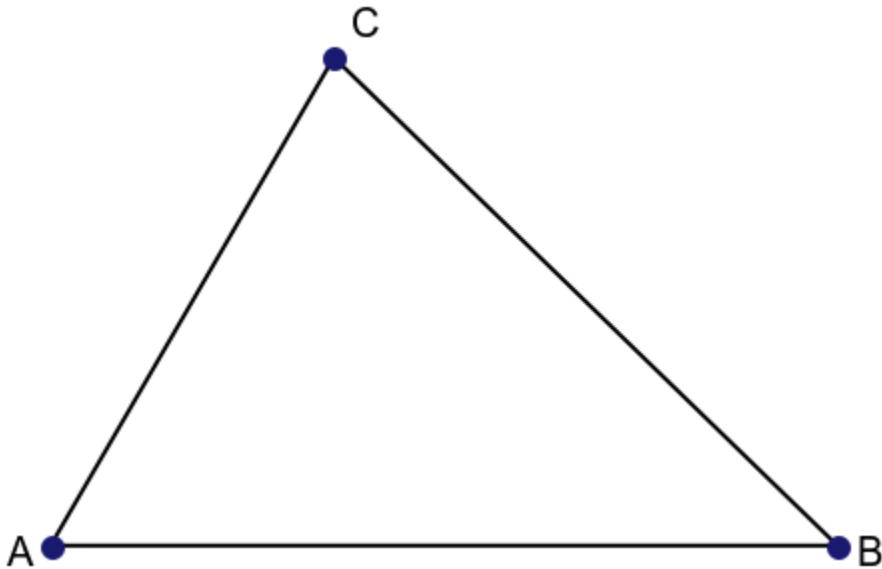

## See Also

### MuPAD Functions

[Title](#) | [TitleAlignment](#) | [TitleFont](#)

## BottomLeft

Positioning of a scene in a canvas

### Value Summary

Bottom, Left	Optional	See below
--------------	----------	-----------

### Graphics Primitives

Objects	Default Values
plot::Scene2d, plot::Scene3d	Bottom, Left: 0

### Description

With the canvas attribute `Layout` set to `Absolute` or `Relative`, scenes in the canvas can be scaled and positioned freely.

`Bottom = b` places the bottom side of a scene at a distance  $b$  above the bottom side of the canvas.

`Left = l` places the left hand side of a scene at a distance  $l$  to the right of the left hand side of the canvas.

The automatic layout schemes `Layout = Horizontal`, `Layout = Vertical`, and `Layout = Tabular` are available for a canvas that contains several scenes.

The canvas settings `Layout = Absolute` and `Layout = Relative` switch the automatic layout mode off and allow to position each scene freely via the attributes `Bottom` and `Left`, respectively. These attributes set the distances of the lower left corner of the scene to the bottom, respectively left hand side of the canvas. These values can be set separately for each scene.



---

**Note** Bottom and Left are only respected for plots with Layout = Absolute or Layout = Relative.

---

The following pictures illustrates the positioning of scenes in a canvas via the scene attributes Bottom and Left:

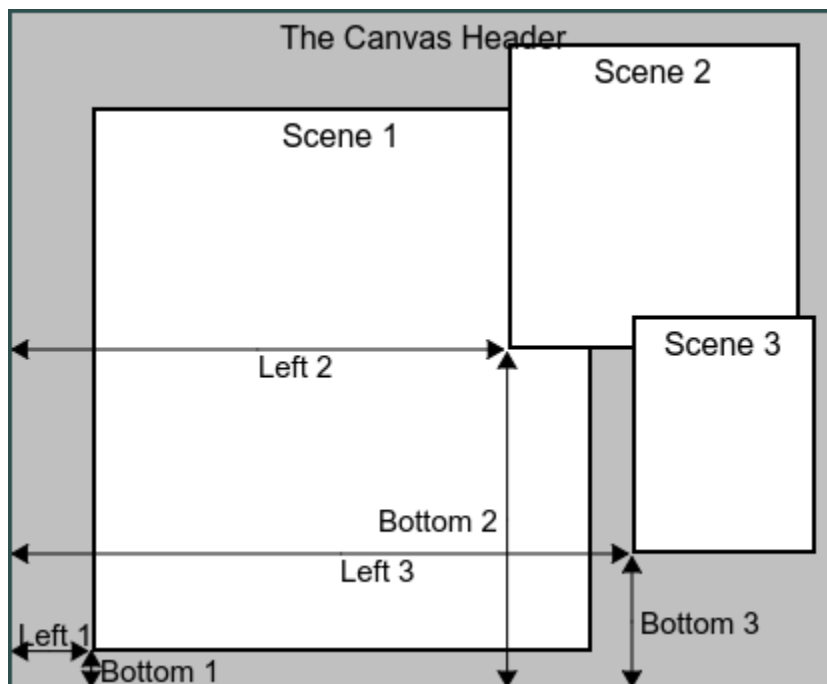

With Layout = Absolute, the distance of the lower left corner of the scene to the lower left corner of the canvas must be specified via physical lengths with a unit on page 1-2196, e.g., Bottom = 2\*unit::mm, Left = 0.1\*unit::inch. Missing units are assumed to be mm.

With Layout = Relative, the distance of the bottom side of the scene to the bottom side of the canvas must be specified as a fraction of the canvas height, i.e., as a number between 0 and 1. The distance of the left hand side of the scene to the left hand side of the canvas must be specified as a fraction of the canvas width, i.e., as a number between 0 and 1.

The lower left corner of a scene may be placed outside the canvas. The parts of a scene outside the canvas are clipped.

Overlapping scenes can be created. In such a situation it may be useful to create transparent scenes (without a background) via `BackgroundTransparent = TRUE`.

## Examples

### Example 1

We demonstrate the layout of the canvas with `Layout = Absolute`. The scene `S1` is positioned automatically in the canvas using the default values `Bottom = 0`, `Left = 0`. The smaller scenes `S2` and `S3` are positioned explicitly via `Bottom` and `Left`:

```
S1 := plot::Scene3d(plot::Sphere(1, [0, 0, 0],
                               Color = RGB::Red),
                   Width = 70*unit::mm, Height = 70*unit::mm,
                   BackgroundColor = RGB::Grey):
S2 := plot::Scene3d(plot::Box(-1..1, -1..1, -1..1,
                              Color = RGB::Green),
                   Width = 30*unit::mm, Height = 30*unit::mm,
                   Left = 60*unit::mm, Bottom = 3*unit::mm):
S3 := plot::Scene3d(plot::Cone(1, [0, 0, 0], [0, 0, 1],
                              Color = RGB::Blue),
                   Width = 30*unit::mm, Height = 30*unit::mm,
                   Left = 60*unit::mm, Bottom = 36*unit::mm):
plot(S1, S2, S3, Layout = Absolute,
     plot::Canvas::BorderWidth = 1.0*unit::mm,
     plot::Canvas::BorderColor = RGB::Black,
     plot::Canvas::Width = 92*unit::mm,
     plot::Canvas::Height = 72*unit::mm,
     plot::Scene3d::BorderWidth = 0.5*unit::mm,
     plot::Scene3d::BorderColor = RGB::Black):
```

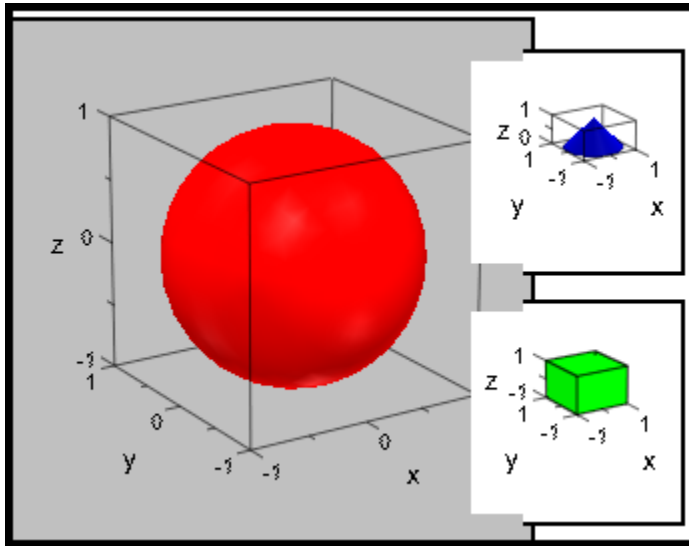

We make the background of the small scenes transparent and switch the axes off:

```
S2::BackgroundTransparent := TRUE:
S2::Axes := None:
S3::BackgroundTransparent := TRUE:
S3::Axes := None:
plot(S1, S2, S3, Layout = Absolute,
     plot::Canvas::BorderWidth = 1.0*unit::mm,
     plot::Canvas::BorderColor = RGB::Black,
     plot::Canvas::Width = 92*unit::mm,
     plot::Canvas::Height = 72*unit::mm,
     plot::Scene3d::BorderWidth = 0.5*unit::mm,
     plot::Scene3d::BorderColor = RGB::Black):
```

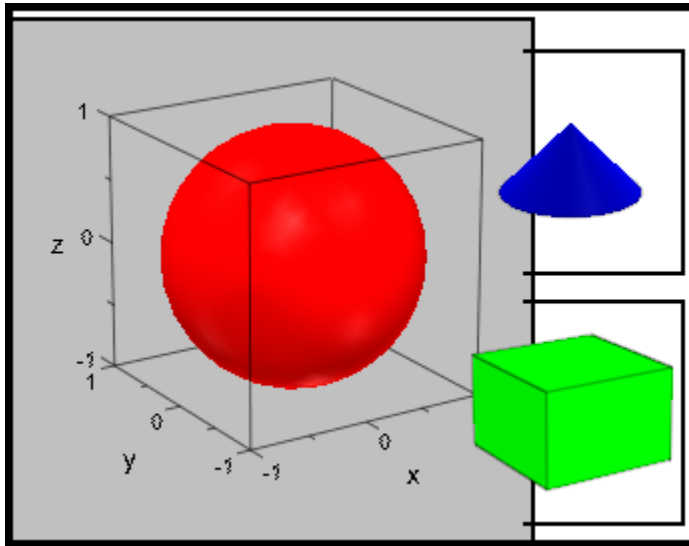

delete S1, S2, S3:

## Example 2

We demonstrate the layout of the canvas with `Layout = Relative`. Apart from the scene headers and the positioning via `Bottom` and `Left`, all scene attributes are set in the `plot` call via specifications such as `plot::Scene2d::Width` etc. This distinguishes the scene attributes from the canvas attributes `Width`, `BorderWidth` etc.

```
S1 := plot::Scene2d(plot::Function2d(sin(x), x = 0..2*PI),
                    Left = 0.02, Bottom = 0.46,
                    Header = "the sine function"):
S2 := plot::Scene2d(plot::Function2d(cos(x), x = 0..2*PI),
                    Left = 0.51, Bottom = 0.46,
                    Header = "the cosine function"):
S3 := plot::Scene2d(plot::Function2d(tan(x), x = 0..PI),
                    Left = 0.02, Bottom = 0.02,
                    Header = "the tan function"):
S4 := plot::Scene2d(plot::Function2d(cot(x), x = 0..PI),
                    Left = 0.51, Bottom = 0.02,
                    Header = "the cot function"):
plot(S1, S2, S3, S4, Layout = Relative,
     Width = 120*unit::mm, Height = 80*unit::mm,
```

```

BorderWidth = 0.5*unit::mm,
HeaderFont = ["Times New Roman", 18, Bold],
Header = "trigonometric functions",
plot::Scene2d::Width = 0.475,
plot::Scene2d::Height = 0.42,
plot::Scene2d::BorderWidth = 0.2*unit::mm,
plot::Scene2d::HeaderFont =
["Times New Roman", Italic, 12]):

```

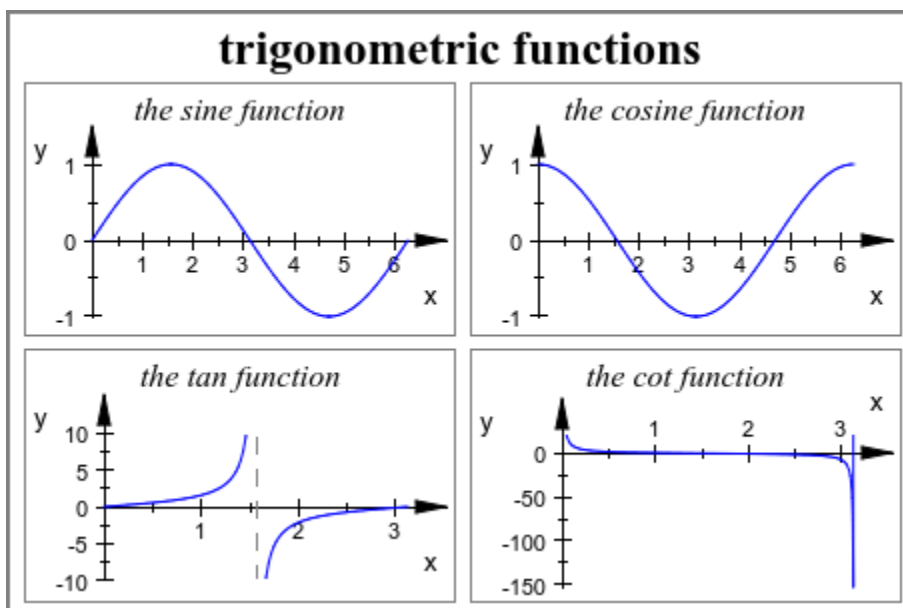

delete S1, S2, S3, S4:

## See Also

**MuPAD Functions**

Layout

## HeightWidth

Heights and widths of canvases and scenes

### Value Summary

Height, Width	Inherited	Positive output size
---------------	-----------	----------------------

### Graphics Primitives

Objects	Default Values
<code>plot::Canvas</code> , <code>plot::Scene2d</code> , <code>plot::Scene3d</code>	Height: 80 Width: 120

### Description

`Height = h` and `Width = w` set the size of the canvas or scene to the height `h` and the width `w`.

For the canvas, the width and the height should be specified as physical lengths with a unit, e.g., `Width = 120*unit::mm`, `Height = 4.72*unit::inch`. Numbers without a physical unit give the size in mm.

These values specify the (approximate) physical size of the canvas, with which the graphics appears on the screen. A printout of the MuPAD graphics will have this physical size precisely.

The following picture illustrates the layout of the canvas:

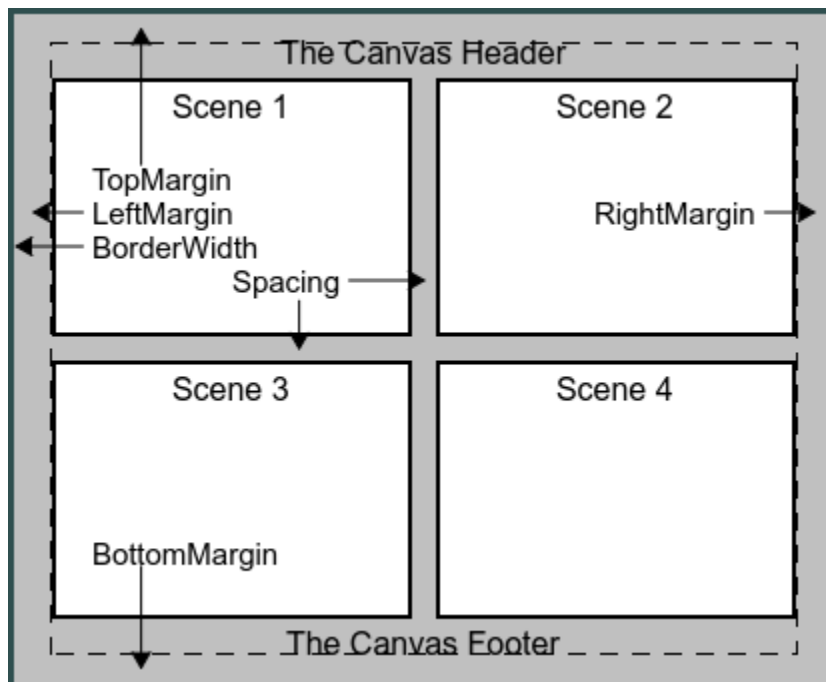

The width and height of the canvas include the margin set by `Margin` and the border set by `BorderWidth`.

When only one scene is displayed in the canvas, this scene fills the canvas, i.e., the scene size coincides with the canvas size. When the canvas contains several scenes, there are various layout schemes, set by the canvas attribute `Layout`, to arrange the scenes in the canvas. Two schemes allow to set the size of the scenes independently of the canvas size:

---

**Note** For scenes, the attributes `Width` and `Height` are only used when plotting with the canvas attribute `Layout` set to `Absolute` or `Relative`.

---

With `Layout = Absolute`, width and height of a scene must be specified as physical lengths with a unit on page 1-2196, e.g., `Height = 40*unit::mm`, `Width = 2.4*unit::inch` (missing units are assumed to be mm).

With `Layout = Relative`, width and height of a scene must be specified as fractions of the canvas width and height, i.e., as numbers between 0 and 1.

The lower left corner of a scene can be moved to any position via the attributes `Bottom` and `Left`.

The following picture illustrates the layout of a scene:

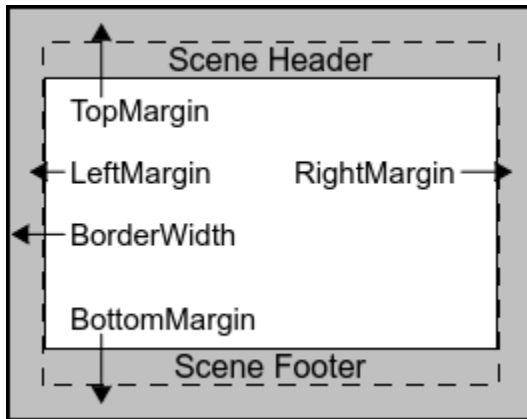

The width and height of the scene include the margin set by `Margin` and the border set by `BorderWidth`.

If a scene exceeds the canvas, the corresponding parts of the scene are clipped.

## Examples

### Example 1

The following calls produce plots of the physical sizes 8 × 4 cm and 11 × 7 cm, respectively.

```
f := plot::Function2d(sin(x), x = 0..2*PI):  
plot(f, Width = 80*unit::mm, Height = 4*unit::cm,  
      BorderWidth = 1.0*unit::mm):
```



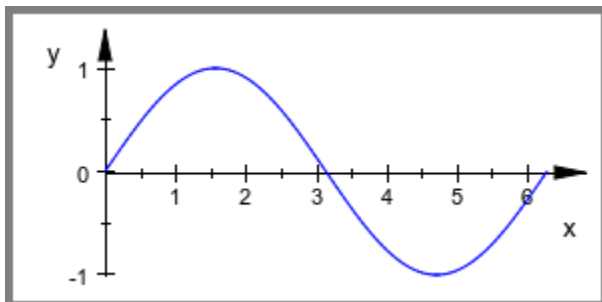

```
plot(f, Width = 110*unit::mm, Height = 7*unit::cm,
      BorderWidth = 1.0*unit::mm):
```

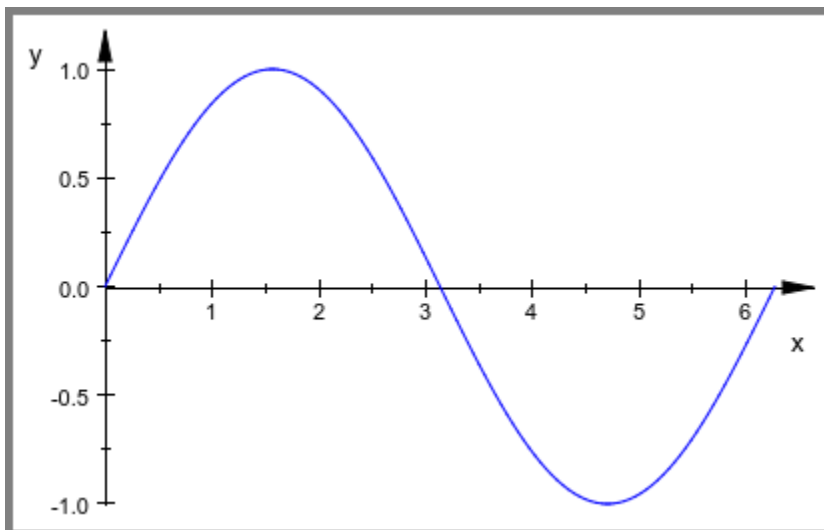

```
delete f:
```

## Example 2

In the following graphics, we place two scenes in one canvas:

```
f1 := plot::Function2d(sin(x), x = 0..2*PI):
f2 := plot::Function2d(cos(x), x = 0..2*PI):
S1 := plot::Scene2d(f1, BorderWidth = 0.5*unit::mm,
                   Height = 7*unit::cm, Width = 11*unit::cm):
```

```
S2 := plot::Scene2d(f2, BorderWidth = 0.5*unit::mm,
                    Height = 3*unit::cm, Width = 5*unit::cm):
plot(S1, S2, Layout = Horizontal, BorderWidth = 1.0*unit::mm,
     Height = 7*unit::cm, Width = 11*unit::cm):
```

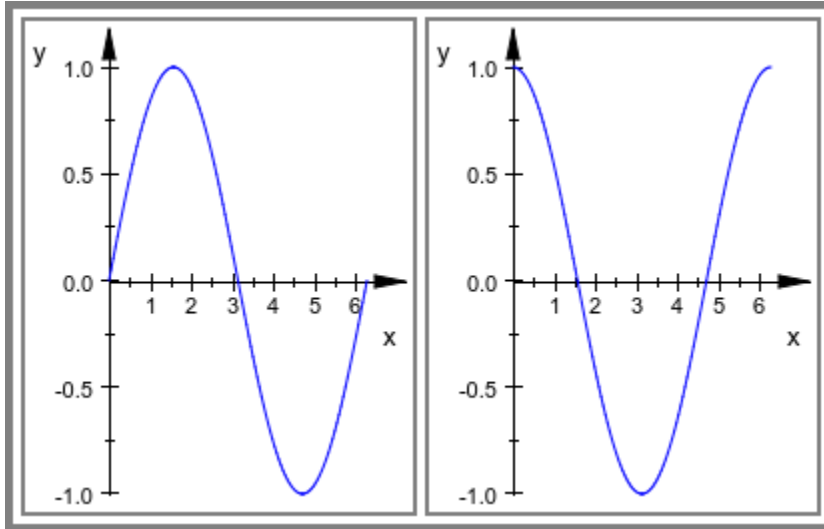

Note that with `Layout = Horizontal`, the size attributes of the scenes were ignored in the plot above. They affect the graphic when switching `Layout` to `Absolute`, either interactively in the inspector (Symbolic Math Toolbox) or directly in the plot call:

```
plot(S1, S2, Layout = Absolute, BorderWidth = 1.0*unit::mm,
     Height = 7*unit::cm, Width = 11*unit::cm):
```

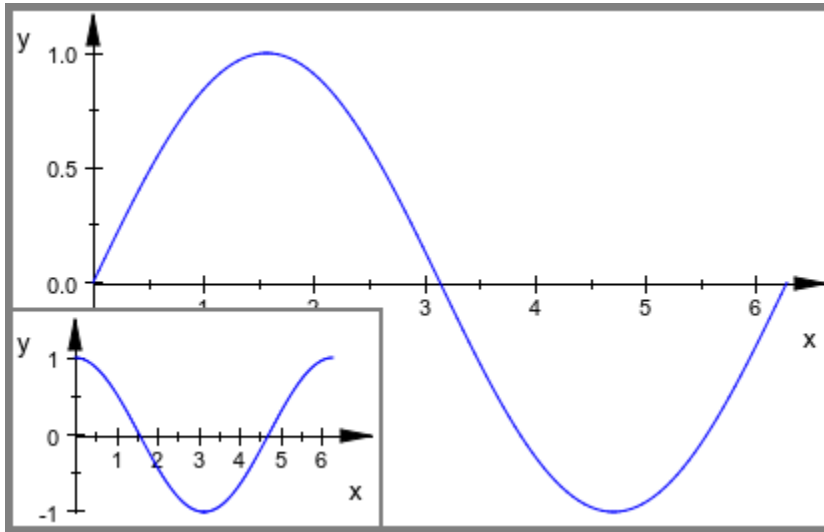

Note that we did not set the attributes `Bottom` and `Left` of the scenes, so the bottom left corners of the scenes are placed in the bottom left corner of the canvas.

We make the background of the scene `S2` transparent via `BackgroundTransparent = TRUE` and shift this scene via suitable values of `Bottom` and `Left`:

```
S2::BackgroundTransparent := TRUE:
S2::Bottom := 3.7*unit::cm:
S2::Left := 5.4*unit::cm:
plot(S1, S2, Layout = Absolute, BorderWidth = 1.0*unit::mm,
      Height = 7*unit::cm, Width = 11*unit::cm):
```

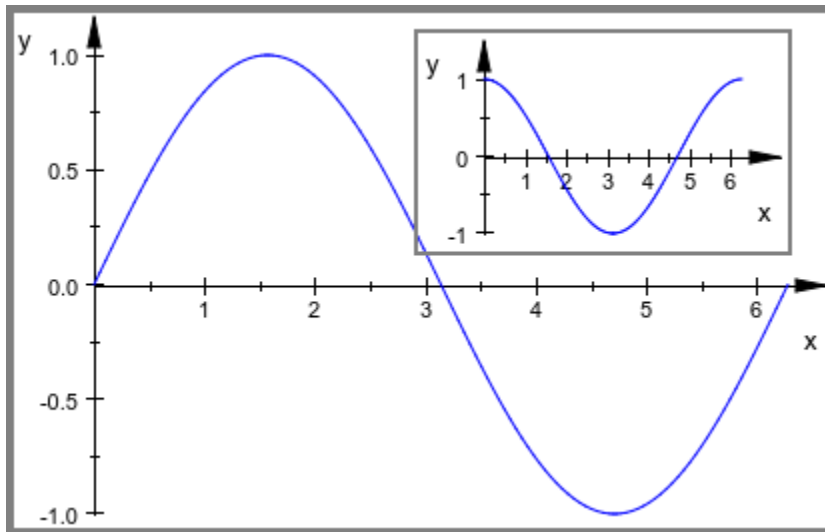

delete f1, f2, S1, S2:

## See Also

### MuPAD Functions

BorderWidth | Bottom | Layout | Left | Margin

# LayoutRowsColumns

Arrangement/layout of several scenes in a canvas

## Value Summary

Layout	Optional	Absolute, Horizontal, Relative, Tabular, or Vertical
Columns, Rows	Optional	Positive integer

## Graphics Primitives

Objects	Default Values
plot::Canvas	Layout: Tabular Rows, Columns: 0

## Description

Layout determines the arrangement of several scenes in a canvas.

Rows determines the number of scene rows in a tabular arrangement of several scenes.

Columns determines the number of scene columns in a tabular arrangement of several scenes.

If a canvas contains more than one scene, the `Layout` attribute determines how the scenes are arranged in the canvas:

- With the default setting `Layout = Tabular`, a sequence of scenes in a canvas is arranged like a table with several columns and rows. The number of columns or rows may be chosen via the attributes `Columns` or `Rows`, respectively. If none of these attributes is given, the tabular layout scheme chooses some suitable values, automatically.

The scenes are filled into the table according to standard western reading order, filling the upper row from left to right, then proceeding to the next row etc:

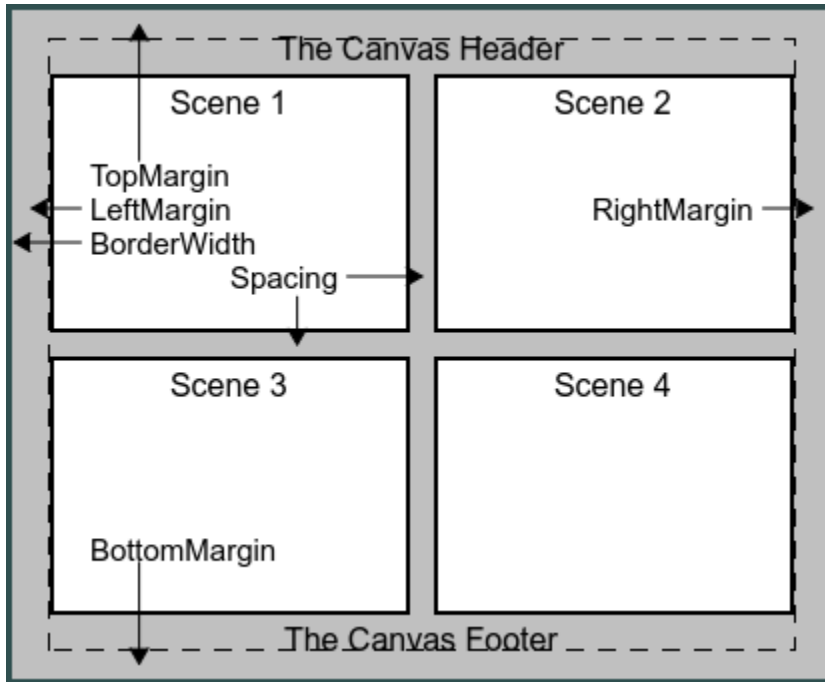

- `Layout = Horizontal` is a shortcut for `Layout = Tabular, Rows = 1`. The scenes are placed side by side in a single row.

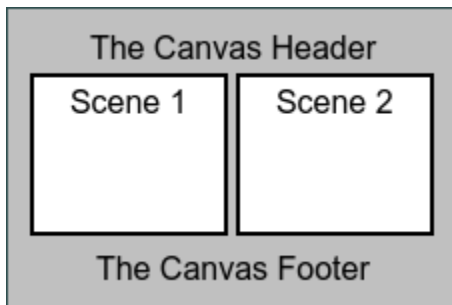

- `Layout = Vertical` is a shortcut for `Layout = Tabular, Columns = 1`. The scenes are placed below each other in a single column.

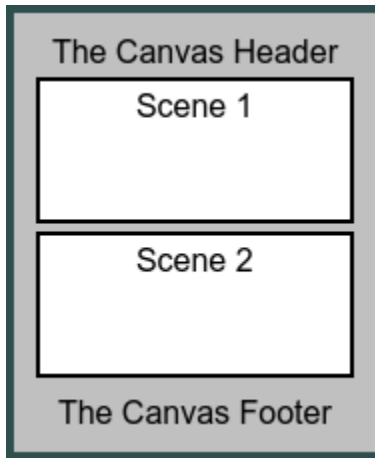

The settings `Layout = Absolute` and `Layout = Relative` switch the automatic layout mode off and allow to position each scene via the scene attributes `Left` and `Bottom`. These attributes determine the position of the lower left corner of the scene and can be set separately for each scene.

- With `Layout = Absolute`, the values for the lower left corner of the scene as well as its width and height must be specified as absolute physical lengths such as `Left = 3.0*unit::mm`, `Bottom = 4.5*unit::mm`, `Width = 10*unit::cm`, `Height = 4*unit::inch`.
- With `Layout = Relative`, these values must be specified as fractions of the canvas height and width. E.g.,

`Layout = Relative,`

`Left = 0.3, Bottom = 0.2, Width = 0.5, Height = 0.5`

is equivalent to

`Layout = Absolute,`

`Left = 0.3*canvaswidth, Bottom = 0.2*canvasheight,`

`Width = 0.5*canvaswidth, Height = 0.5*canvasheight,`

where `canvaswidth` and `canvasheight` are the physical width and height of the canvas.

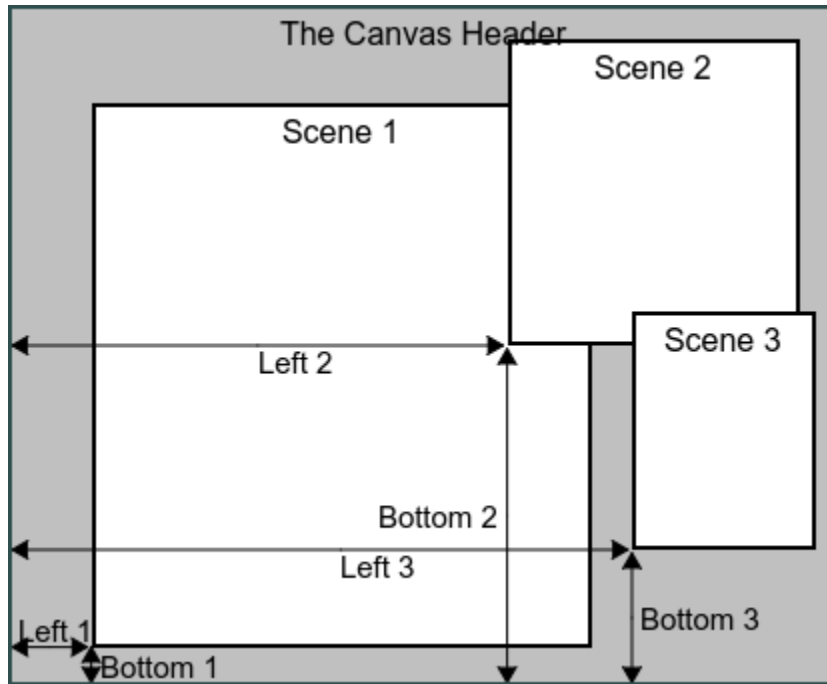

With `Layout = Absolute` and `Layout = Relative` overlapping scenes can be created. In such a situation it may be useful to create transparent scenes (without a background) via `BackgroundTransparent = TRUE`.

## Examples

### Example 1

We define four scenes:

```
S1 := plot::Scene3d(plot::Sphere(1, [0, 0, 0],
                                Color = RGB::Red),
                   BorderWidth = 0.2*unit::mm,
                   BorderColor = RGB::Black):
S2 := plot::Scene3d(plot::Box(-1..1, -1..1, -1..1,
                              Color = RGB::Green),
                   BorderWidth = 0.2*unit::mm,
```



```

        BorderColor = RGB::Black):
S3 := plot::Scene3d(plot::Cone(1, [0, 0, -1], [0, 0, 1],
        Color = RGB::Blue),
        BorderWidth = 0.2*unit::mm,
        BorderColor = RGB::Black):
S4 := plot::Scene3d(plot::Cone(1, [0, 0, 1], [0, 0, -1],
        Color = RGB::Orange),
        BorderWidth = 0.2*unit::mm,
        BorderColor = RGB::Black):

```

These scenes are positioned in the canvas in various ways:

```

plot(S1, S2, S3, S4, Layout = Tabular,
     Height = 80*unit::mm, Width = 80*unit::mm):

```

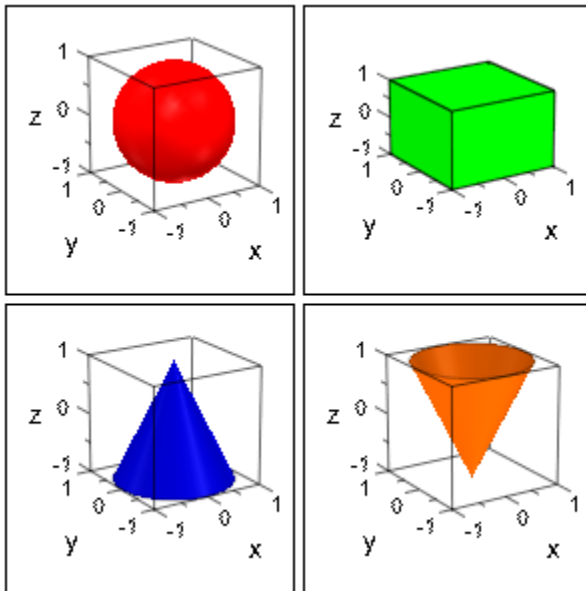

```

plot(S1, S2, Layout = Horizontal,
     Height = 40*unit::mm, Width = 80*unit::mm):

```

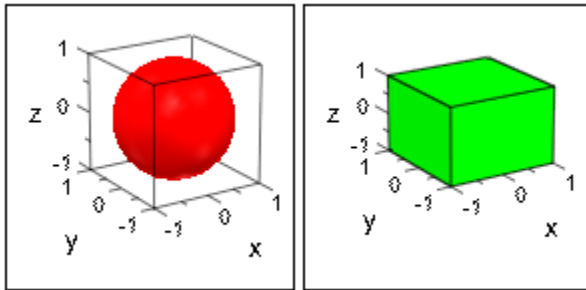

```
plot(S1, S2, Layout = Vertical,
     Height = 80*unit::mm, Width = 40*unit::mm):
```

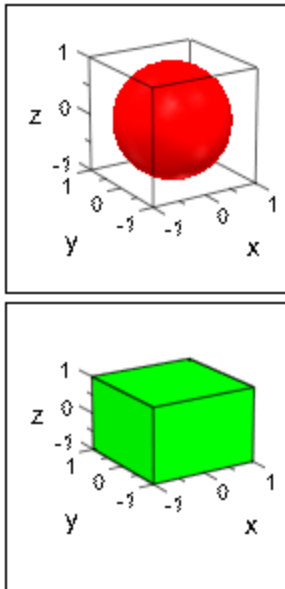

For explicit placement of the scenes, we set values for the Left, Bottom, Width, and Height attributes of the scenes:

```
S1::Left := 0:           S1::Bottom := 15*unit::mm:
S1::Width := 60*unit::mm: S1::Height:= 60*unit::mm:
S2::Left := 60*unit::mm: S2::Bottom := 0*unit::mm:
S2::Width := 40*unit::mm: S2::Height:= 30*unit::mm:
S3::Left := 60*unit::mm: S3::Bottom := 30*unit::mm:
```

```
S3::Width := 40*unit::mm: S3::Height:= 30*unit::mm:
S4::Left := 60*unit::mm: S4::Bottom := 60*unit::mm:
S4::Width := 40*unit::mm: S4::Height:= 30*unit::mm:
```

We use `Layout = Absolute`:

```
plot(S1, S2, S3, S4, Layout = Absolute,
     BorderWidth = 0.5*unit::mm, BorderColor = RGB::Black,
     BackgroundColor = RGB::LightGrey,
     Height = 90*unit::mm, Width = 100*unit::mm):
```

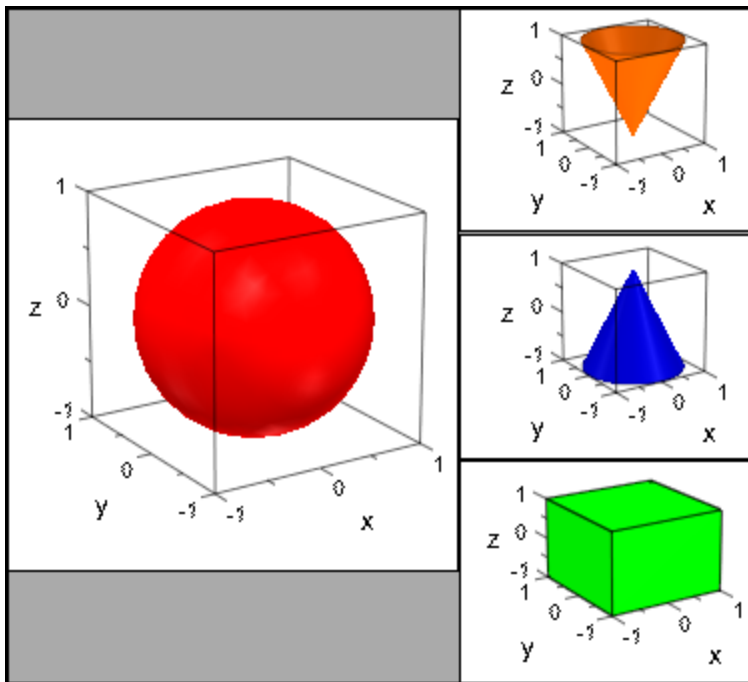

For `Layout = Relative`, the scene attributes `Left`, `Width`, `Bottom`, `Height` must be given as fractions of the canvas width and height, respectively:

```
S1::Left := 0: S1::Width := 0.6:
S1::Bottom := 0: S1::Height := 0.6:
S2::Left := 0: S2::Width := 0.5:
S2::Bottom := 0.6: S2::Height := 0.4:
S3::Left := 0.5: S3::Width := 0.5:
S3::Bottom := 0.6: S3::Height := 0.4:
```

```

S4::Left := 0.58: S4::Width := 0.4:
S4::Bottom := 0.35: S4::Height := 0.4:
S4::BackgroundTransparent := TRUE:

plot(S1, S2, S3, S4, Layout = Relative,
     BorderWidth = 0.5*unit::mm, BorderColor = RGB::Black,
     BackgroundColor = RGB::LightGrey,
     Height = 87*unit::mm, Width = 104*unit::mm):

```

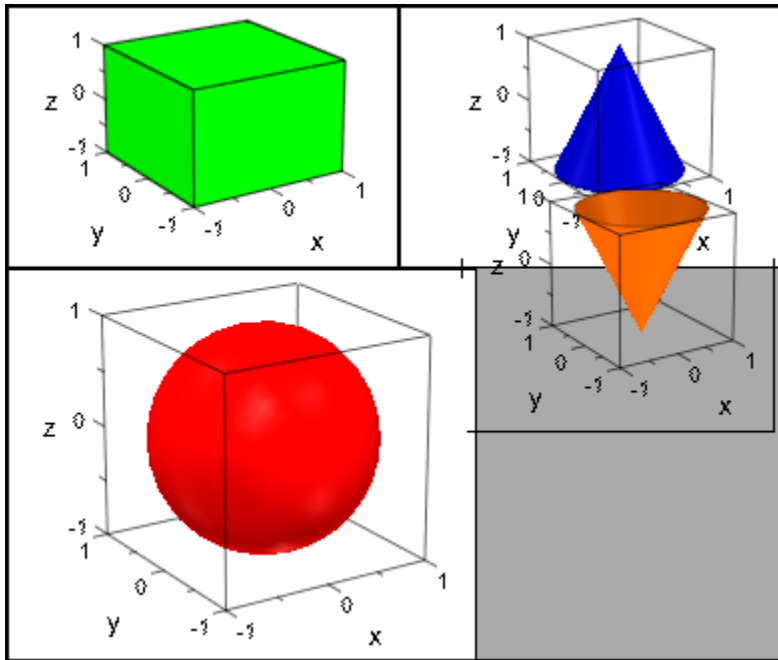

```
delete S1, S2, S3, S4:
```

## Example 2

We demonstrate the layout of the canvas with `Layout = Relative`. Apart from the scene headers and the positioning via `Bottom` and `Left`, all scene attributes are set in the `plot` call via specifications such as `plot::Scene2d::Width` etc. This distinguishes the scene attributes from the canvas attributes `Width`, `BorderWidth` etc.

```

S1 := plot::Scene2d(plot::Function2d(sin(x), x = 0..2*PI),
                   Left = 0.02, Bottom = 0.46,

```

```

Header = "the sine function"):
S2 := plot::Scene2d(plot::Function2d(cos(x), x = 0..2*PI),
  Left = 0.51, Bottom = 0.46,
  Header = "the cosine function"):
S3 := plot::Scene2d(plot::Function2d(tan(x), x = 0..PI),
  Left = 0.02, Bottom = 0.02,
  Header = "the tan function"):
S4 := plot::Scene2d(plot::Function2d(cot(x), x = 0..PI),
  Left = 0.51, Bottom = 0.02,
  Header = "the cot function"):
plot(S1, S2, S3, S4, Layout = Relative,
  Width = 120*unit::mm, Height = 80*unit::mm,
  BorderWidth = 0.5*unit::mm,
  HeaderFont = ["Times New Roman", 18, Bold],
  Header = "trigonometric functions",
  plot::Scene2d::Width = 0.475,
  plot::Scene2d::Height = 0.42,
  plot::Scene2d::BorderWidth = 0.2*unit::mm,
  plot::Scene2d::HeaderFont =
    ["Times New Roman", Italic, 12]):

```

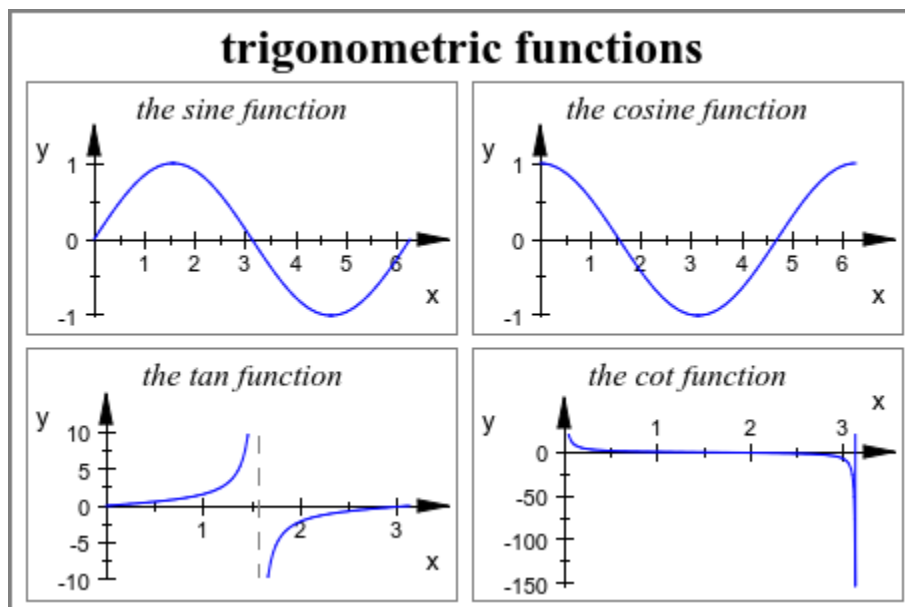

Finally, we demonstrate the attributes `Rows` and `Columns`. The automatic tabular layout ignores the explicit positioning of the scenes and chooses the following arrangement:

```
plot(S1, S2, S3, S4)
```

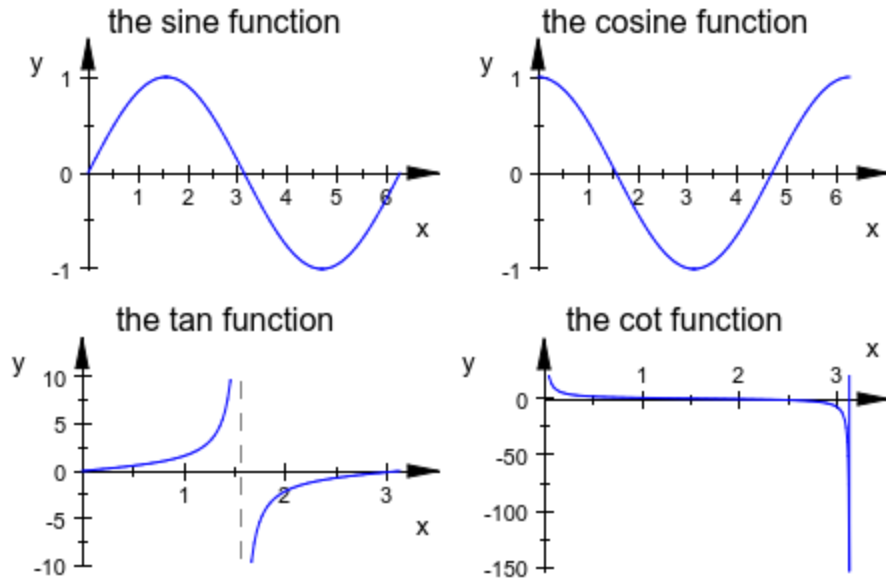

We explicitly request three rows:

```
plot(S1, S2, S3, S4, Rows = 3)
```

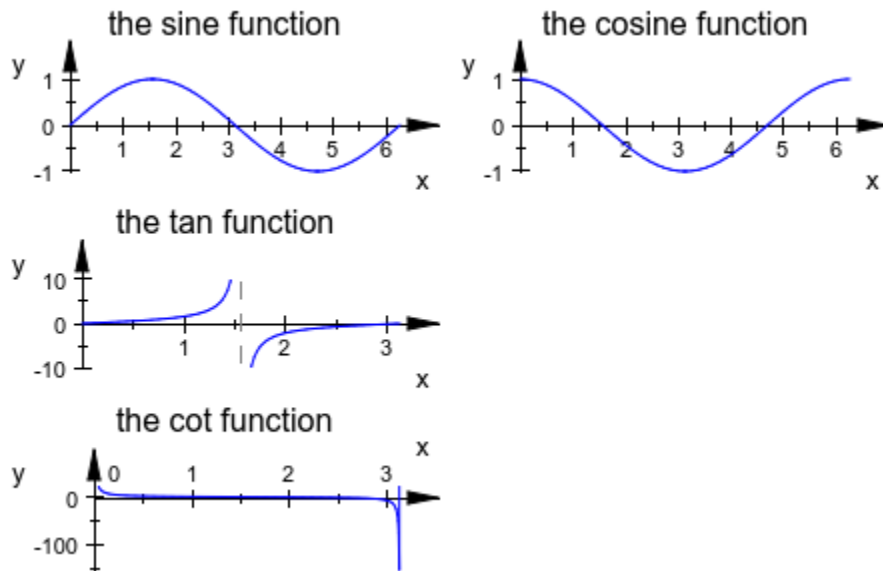

We explicitly request three columns:

```
plot(S1, S2, S3, S4, Columns = 3)
```

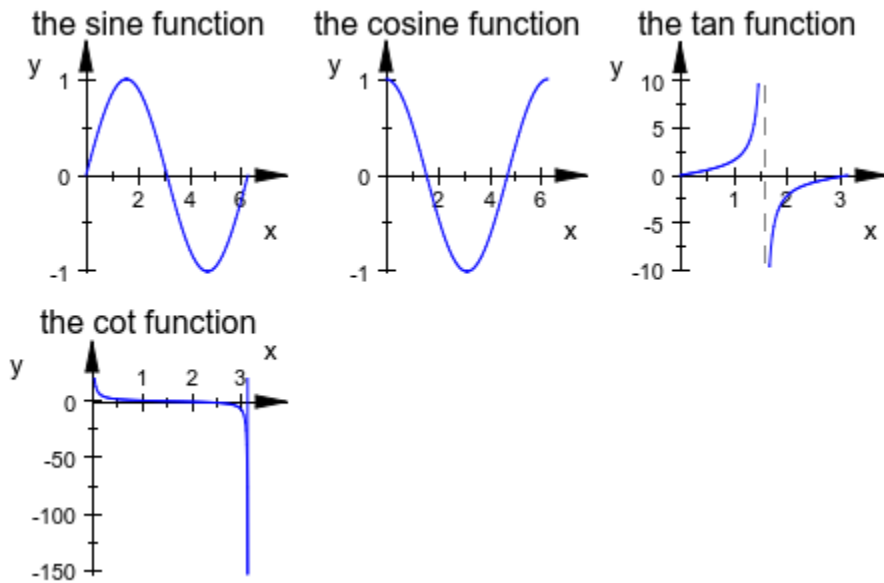

We generate an empty scene:

```
empty := plot::Scene2d(Axes = None):
```

The tabular layout is filled in with empty scenes:

```
plot(S1, S2, empty, S3, empty, S4, Rows = 3)
```



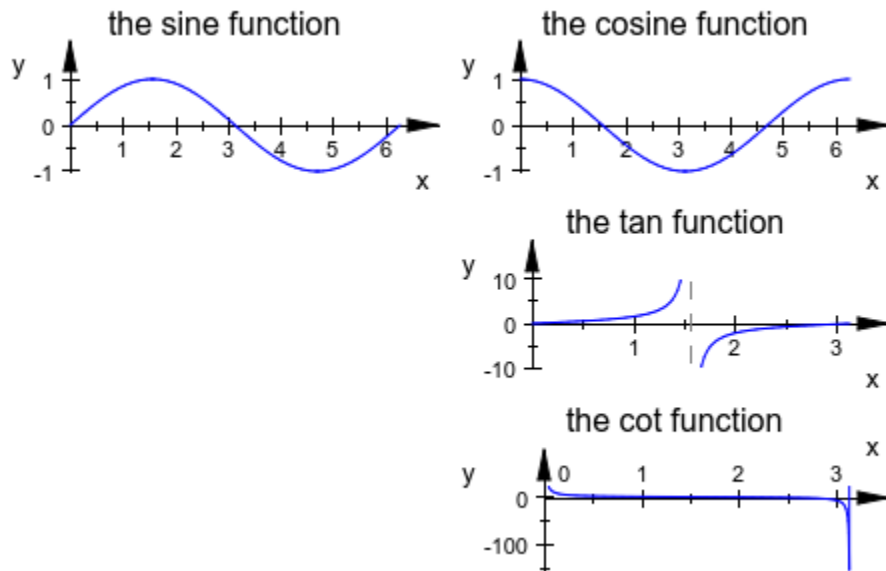

```
plot(S1, S2, S3, empty, S4, empty, Columns = 3)
```

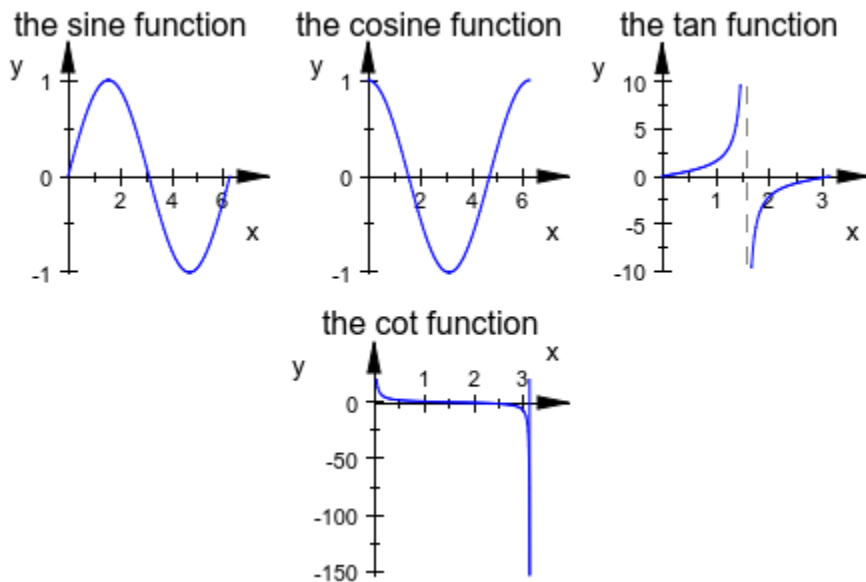

delete S1, S2, S3, S4, empty:

## See Also

### MuPAD Functions

BorderColor | BorderWidth | Bottom | BottomMargin | Left | LeftMargin | Margin  
| RightMargin | Spacing | TopMargin

# MarginBottomMarginTopMarginLeftMarginRightMargin

Margins around canvas and scenes

## Value Summary

Margin	[[BottomMargin, LeftMargin, RightMargin, TopMargin]]	Non-negative output size
BottomMargin, LeftMargin, RightMargin, TopMargin	Inherited	Non-negative output size

## Graphics Primitives

Objects	Default Values
plot::Canvas, plot::Scene2d, plot::Scene3d	Margin, BottomMargin, TopMargin, LeftMargin, RightMargin: 1

## Description

`Margin = d` sets a margin of size `d` around a canvas or scene. The margins at the bottom, to the left etc. can also be specified separately via `BottomMargin = d1`, `LeftMargin = d2` etc.

The canvas as well as the scenes have a margin that is not used for displaying graphical objects or captions. Its color coincides with the background color of the canvas or the scenes, respectively.

The size  $d$  of this margin is set by specifying `Margin = d` in a canvas on page 24-1053 or in a scene (of type `plot::Scene2d` or `plot::Scene3d`), respectively. Here,  $d$  is the physical width of the margin, e.g., `Margin = 0.5*unit::mm`.

The margin sizes at the bottom, left, right, top of the canvas or the scenes can be specified separately via `BottomMargin = d1`, `LeftMargin = d2`, `RightMargin = d3`, `TopMargin = d4`.

The attribute `Margin = d` is a shortcut for `BottomMargin = d`, `LeftMargin = d`, `RightMargin = d`, `TopMargin = d`.

The following picture illustrates the layout of the canvas:

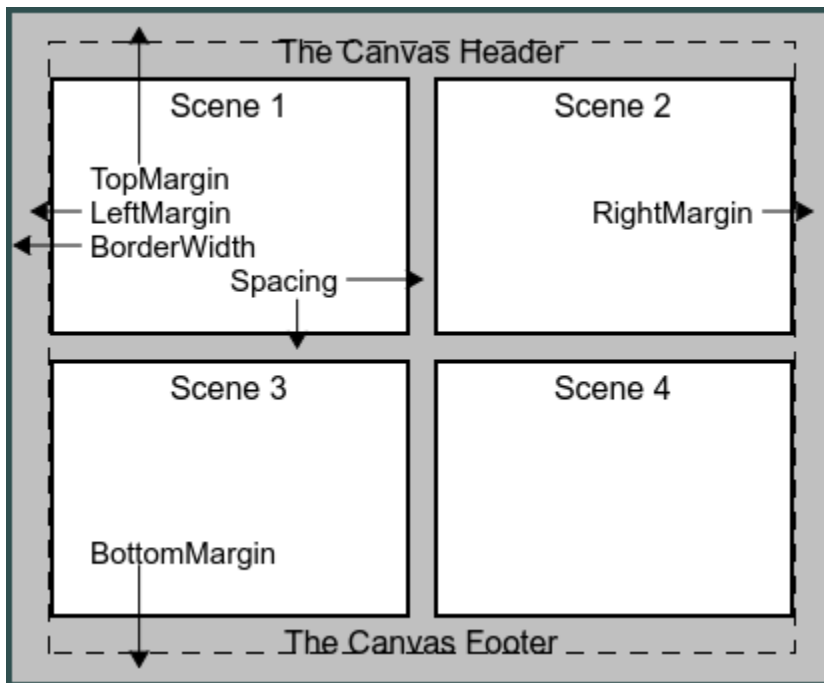

The following picture illustrates the layout of a scene:

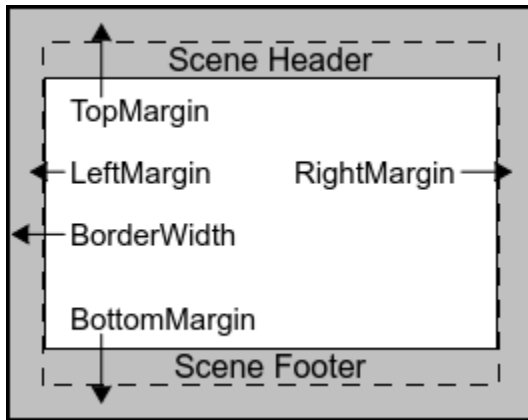

The size of a canvas, set by the attributes `Width` and `Height`, includes the width of the margin set by `Margin`. The same holds for the scenes.

With `BackgroundTransparent = TRUE`, transparent scenes (without a background) can be created. The margin becomes transparent as well.

The margins do not react to `Layout = Relative`. One always has to specify the margin width as absolute physical lengths such as `0.5*unit::mm`.

Scenes do *not* inherit margin widths from the enclosing canvas. You can set margin widths for all scenes simultaneously by specifying them in `plot::setDefault` as `plot::Scene2d::Margin` or `plot::Scene3d::Margin`, respectively. Cf. "Example 2" on page 24-1670 (Symbolic Math Toolbox).

## Examples

### Example 1

The following two scenes display the same function graph using different margins:

```
f := plot::Function2d(exp(-x^2), x = -3..3):
plot(plot::Scene2d(f, Margin = 2*unit::mm,
  BackgroundColor = RGB::Grey),
  plot::Scene2d(f, Margin = 8*unit::mm,
  BackgroundColor = RGB::Grey),
```

```
Layout = Horizontal, Axes = Frame,
Width = 120*unit::mm, Height = 60*unit::mm):
```

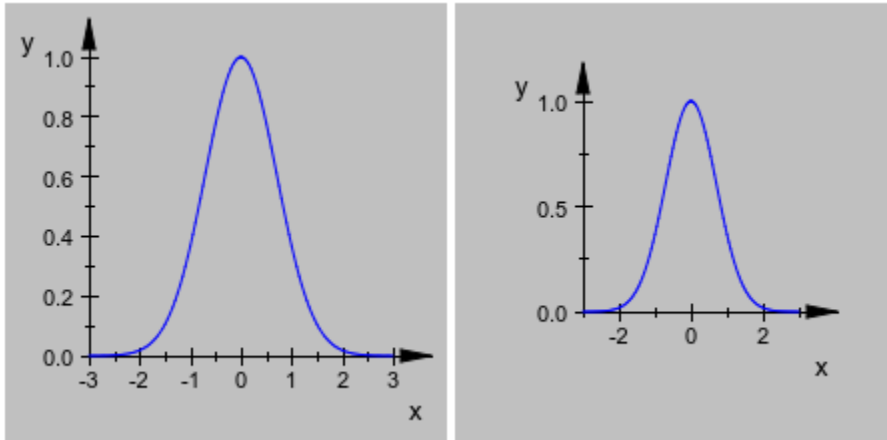

```
delete f:
```

## Example 2

We use `plot::setDefault` to define new default values for the layout and style parameters `BorderWidth`, `BorderColor`, `Margin`, and `BackgroundColor`:

```
plot::setDefault(
  plot::Canvas::BorderWidth = 0.5*unit::mm,
  plot::Canvas::BorderColor = RGB::Black,
  plot::Canvas::Margin = 1.5*unit::mm,
  plot::Canvas::BackgroundColor = RGB::SlateGrey,
  plot::Scene2d::BorderWidth = 0.5*unit::mm,
  plot::Scene2d::BorderColor = RGB::Black,
  plot::Scene2d::Margin = 2*unit::mm,
  plot::Scene2d::BackgroundColor = RGB::Grey
):
```

The following canvas contains two scenes. This plot uses the new defaults:

```
plot(plot::Scene2d(plot::Rectangle(-1..1, -1..1,
  Filled = TRUE, FillColor = RGB::Red,
  Header = "Scene 1")),
  plot::Scene2d(plot::Rectangle(-1..1, -1..1,
```

```
Filled = TRUE, FillColor = RGB::Blue,  
Header = "Scene 2")),  
Layout = Horizontal, Axes = None,  
Header = "Canvas Header"):
```

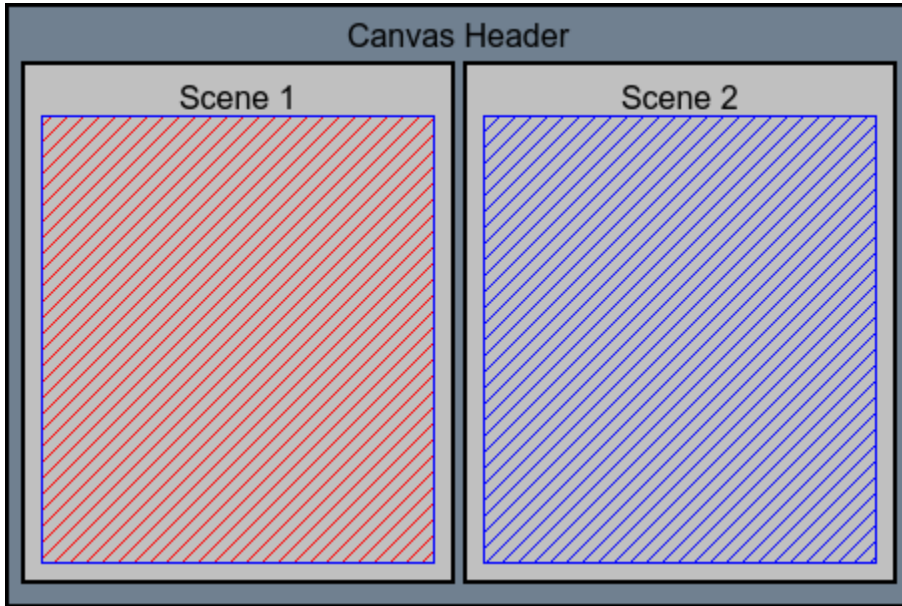

## See Also

### MuPAD Functions

BackgroundColor | BackgroundColor2 | BackgroundStyle |  
BackgroundTransparent | BorderColor | BorderWidth | Bottom | Left

## OutputUnits

Physical length unit used by the inspector

### Value Summary

Optional	<code>unit::cm, unit::dm, unit::inch,</code> <code>unit::km, unit::m, unit::mm, or</code> <code>unit::pt</code>
----------	---

### Graphics Primitives

Objects	OutputUnits Default Values
<code>plot::Canvas</code>	<code>unit::mm</code>

### Description

Various length parameters in the MuPAD graphics such as the width and the height of the canvas, the length of tick marks, the width of lines, the size of points etc. may be specified as physical lengths with a length unit on page 1-2196. The inspector (Symbolic Math Toolbox) allows to display a physical length in the physical unit set by `OutputUnits`.

For example, when specifying the canvas size by the attributes `Width = 120*unit::mm`, `Height = 80*unit::mm`, the MuPAD graphics will appear on the screen in a canvas of 120 × 80 mm (approximately). A printout of the MuPAD graphics will have this physical size precisely.

One may also specify these lengths as pure numbers such as `Width = 120`, `Height = 80`. In this case, the physical length unit is given in mm.

In the “object inspector” of the MuPAD Graphics Tool (see the section Viewer, Browser, and Inspector: Interactive Manipulation (Symbolic Math Toolbox) of this document), lengths are displayed as numbers without unit. The actual physical length is given by these numbers times the physical length unit given by `OutputUnits`.



---

**Note** Note that the specification `Width = 10, OutputUnit = unit::inch` does not mean `Width = 10*unit::inch`, but `Width = 10*unit::mm`, displayed as `0.3937...` inches.

It is recommended to specify output sizes always as products of the numerical values times the unit.

---

Changing the value of `OutputUnits` does not change the physical lengths! When changing `OutputUnits = unit::mm` to `OutputUnits = unit::inch`, say, the numbers in the object inspector such as `Width = 120` (corresponding to a canvas size of 120 mm in the real world) change automatically to `Width = 4.7244...` (corresponding to the same canvas size 120 mm = 4.7244... inches).

If you want to change the physical length, you need to change the number in the input region of `Width` in the object inspector.

Switching between different output units via `OutputUnits` is convenient if physical conditions such as the real world size of a printout have to be met. Depending on your nationality, you will have a preference for inches or millimeters.

## Examples

### Example 1

The following calls all produce graphical output of the same physical size:

```
f := plot::Function2d(sin(x), x = 0..PI):  
plot(f, Width = 90*unit::mm, Height = 40*unit::mm):
```

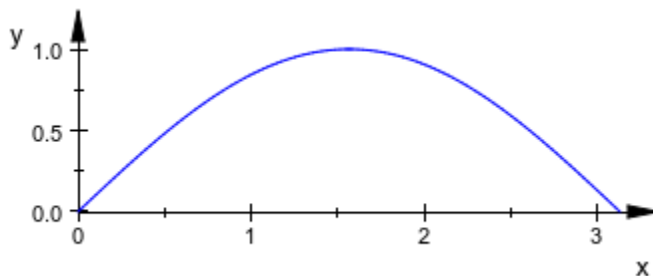

```
plot(f, Width = 90, Height = 40, OutputUnits = unit::mm):
```

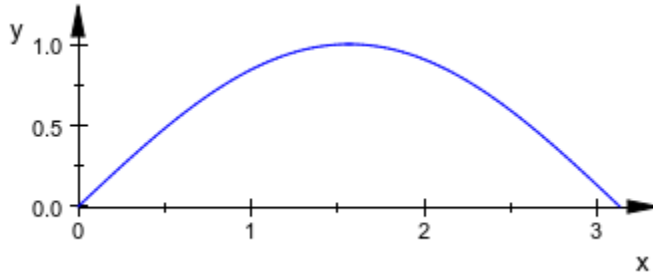

```
plot(f, Width = 90, Height = 40, OutputUnits = unit::inch):
```

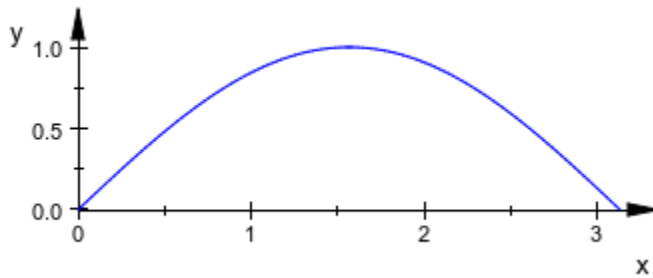

```
plot(f, Width = 3.544*unit::inch, Height = 40*unit::mm):
```

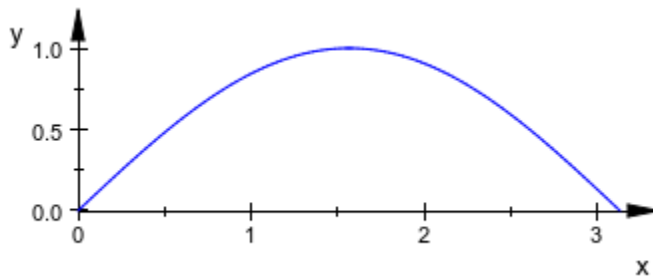

```
plot(f, Width = 3.544*unit::inch, Height = 1.575*unit::inch):
```

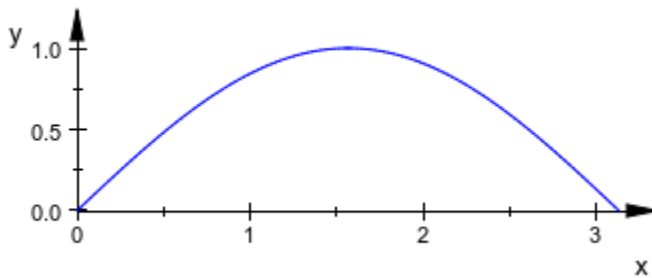

In the following plot command, the size of graphical points is specified in millimeters. The specification of `OutputUnits = unit::inch` does not change the physical point size of  $2 \text{ mm} = 0.07874\dots \text{ inch}$ . It just means that the value of the point size is displayed as  $0.07874$  in the object inspector of the MuPAD Graphics Tool, not as  $2$ :

```
plot(plot::Function2d(sin(x), x = 0..PI, Mesh = 30),
      PointsVisible = TRUE, PointSize = 2*unit::mm,
      Width = 90*unit::mm, Height = 40*unit::mm,
      OutputUnits = unit::inch):
```

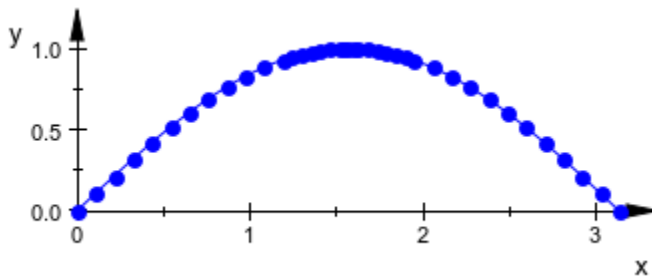

```
delete f:
```

## Example 2

The conversion between the output sizes can be computed via MuPAD:

```
120.0*unit::mm = unit::convert(120.0*unit::mm, unit::inch),
4.7244*unit::inch = unit::convert(4.7244*unit::inch, unit::pt)
```

$120.0 \text{ mm} = 4.724409449 \text{ inch}$ ,  $4.7244 \text{ inch} = 341.4323914 \text{ pt}$

## See Also

### **MuPAD Functions**

AxesLineWidth | Bottom | BottomMargin | GridLineWidth | Height | Left |  
LeftMargin | LineWidth | PointSize | RightMargin | Spacing |  
SubgridLineWidth | TicksLength | TipLength | TopMargin | TubeDiameter |  
VerticalAsymptotesWidth | Width

# Spacing

Space between scenes

## Value Summary

Optional	Non-negative output size
----------	--------------------------

## Graphics Primitives

Objects	Spacing Default Values
<code>plot::Canvas</code>	1.0

## Description

`Spacing = d` sets a gap of size  $d$  between neighboring scenes in a canvas.

If a canvas contains several scenes, an automatic layout of the canvas may be requested by `Layout = Horizontal`, `Layout = Tabular`, or `Layout = Vertical`. In these modes, the scenes are separated by a gap that is set by `Spacing = d`. Here,  $d$  is the physical width of the gap, e.g., `Spacing = 0.5*unit::mm`.

The `Spacing` attribute has an effect only in conjunction with the automatic layout modes `Layout = Horizontal`, `Layout = Tabular`, or `Layout = Vertical`, respectively.

The following picture illustrates the layout of the canvas:

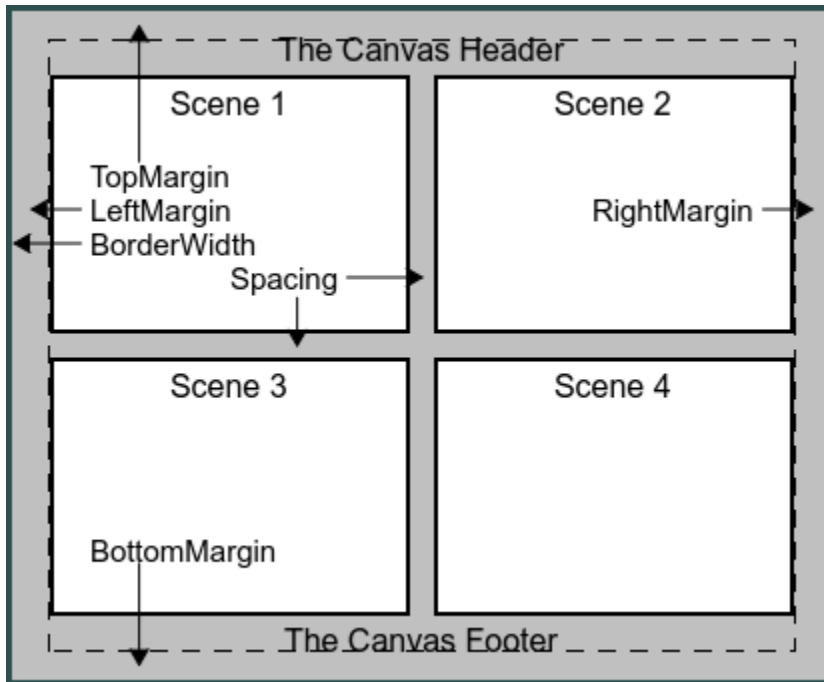

## Examples

### Example 1

We define four scenes:

```

S1 := plot::Scene3d(plot::Sphere(1, [0, 0, 0]),
    BackgroundColor = RGB::Grey,
    BorderWidth = 0.5*unit::mm):
S2 := plot::Scene3d(plot::Cylinder(1, [0, 0, 0], [0, 0, 1]),
    BackgroundColor = RGB::Grey,
    BorderWidth = 0.5*unit::mm):
S3 := plot::Scene3d(plot::Cone(1, [0, 0, 0], [0, 0, 1]),
    BackgroundColor = RGB::Grey,
    BorderWidth = 0.5*unit::mm):
S4 := plot::Scene3d(plot::Cone(1, [0, 0, 1], [0, 0, 0]),

```

```

BackgroundColor = RGB::Grey,
BorderWidth = 0.5*unit::mm):

```

These scenes are positioned in the canvas with no gap between them (Spacing = 0). By default, the automatic layout mode Layout = Tabular is used:

```

plot(S1, S2, S3, S4, Spacing = 0,
     BorderWidth = 1.0*unit::mm):

```

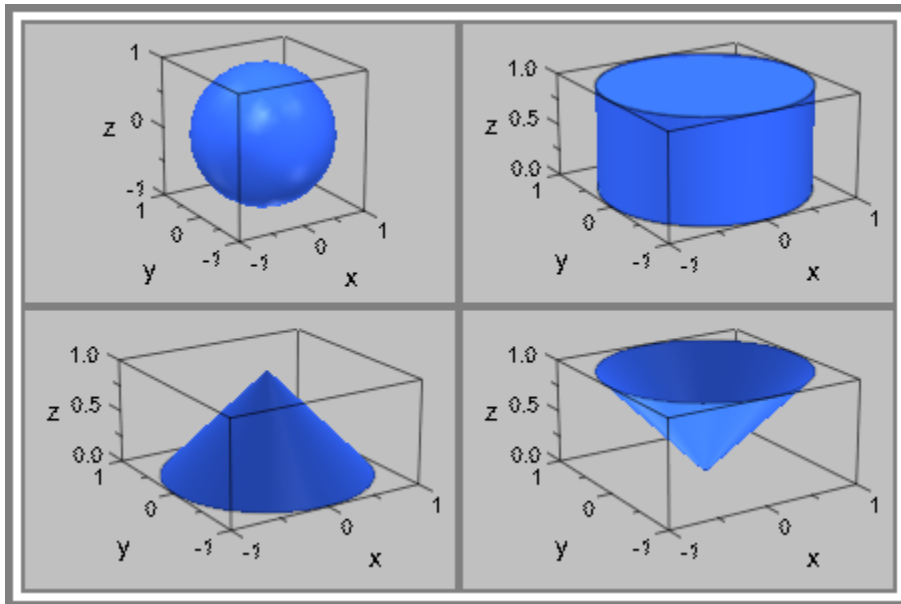

We introduce a gap of 1 mm:

```

plot(S1, S2, S3, S4, Spacing = 1.0*unit::mm,
     BorderWidth = 1.0*unit::mm):

```

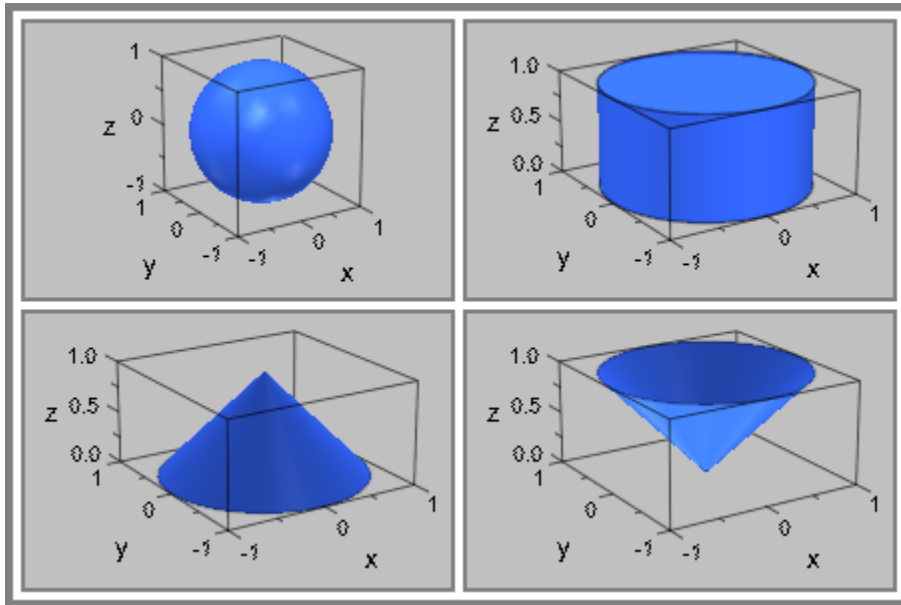

delete S1, S2, S3, S4:

## See Also

### MuPAD Functions

Bottom | BottomMargin | Layout | Left | LeftMargin | Margin | RightMargin | TopMargin



# AbsoluteErrorRelativeError

Maximal absolute discretization error

## Value Summary

AbsoluteError, RelativeError	Optional	MuPAD expression
---------------------------------	----------	------------------

## Graphics Primitives

Objects	Default Values
plot::0de2d, plot::0de3d	
plot::Streamlines2d	RelativeError: 1/100000

## Description

`AbsoluteError = atol` sets the tolerance `atol` for the maximal absolute discretization error in the numerical solution of ODEs.

`RelativeError = rtol` sets the tolerance `rtol` for the maximal relative discretization error.

Internally, `plot::0de2d` and `plot::0de3d` call the routine `numeric::odesolve` for solving the given ODE numerically. The attributes `AbsoluteError`, `RelativeError` are forwarded to `numeric::odesolve`. See the corresponding help page on page 19-196 for further details.

## Examples

### Example 1

We consider the initial value problem  $y'(t) = -t \cos(y(t))$ ,  $y(0) = 4.7$ . The ODE is solved numerically with different tolerances for the relative discretization error. The 'oscillating' behaviour of the red solution curve is a numerical artifact. The blue solution curve, computed with a smaller tolerance, is more precise:

```
f := (t, Y) -> [-t*cos(Y[1])]:
Y0 := [4.7]:
plot(plot::Ode2d(f, [i $ i = 0..20], Y0, Color = RGB::Blue,
                RelativeError = 0.0001),
     plot::Ode2d(f, [i $ i = 0..20], Y0, Color = RGB::Red,
                RelativeError = 0.001))
```

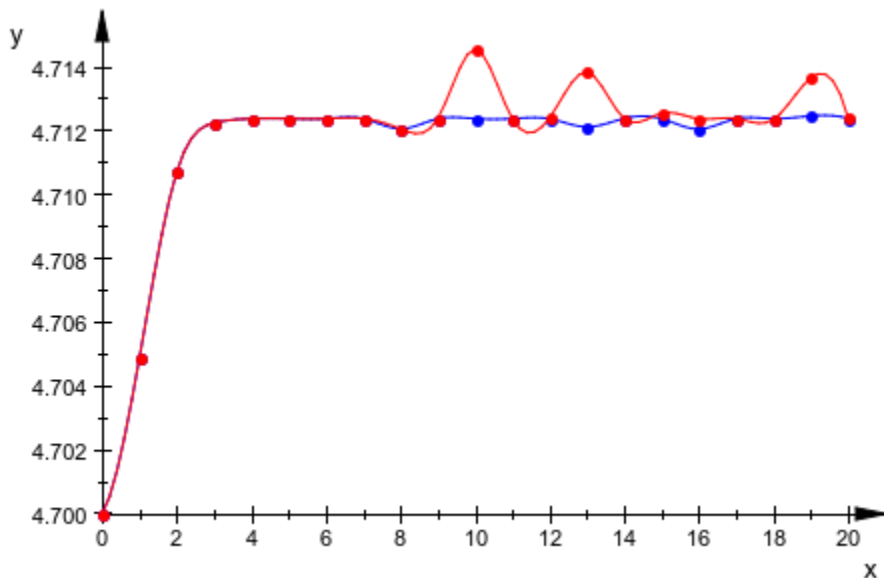

```
delete f, Y0:
```

## See Also

### **MuPAD Functions**

[InitialConditions](#) | [ODEMethod](#) | [Projectors](#) | [Stepsize](#) | [TimeMesh](#)

## AdaptiveMesh

Adaptive sampling

### Value Summary

Inherited	Non-negative integer
-----------	----------------------

### Graphics Primitives

Objects	AdaptiveMesh Default Values
plot::Function2d	2
plot::Conformal, plot::Curve2d, plot::Curve3d, plot::Cylindrical, plot::Function3d, plot::Implicit3d, plot::Polar, plot::Spherical, plot::Surface, plot::Sweep, plot::XRotate, plot::ZRotate	0
plot::Rootlocus	4

### Description

`AdaptiveMesh = n` controls the adaptive sampling in the numerical evaluation of functions, curves and surfaces. With  $n = 0$ , adaptive sampling is disabled. With  $n > 0$ , adaptive sampling is enabled.

The “depth”  $n$  of the adaptive sampling should be a *small* integer such as 0, 1, 2, or 3.

Continuous graphical objects such as function graphs, parameterized curves and surfaces are approximated by a discrete mesh of numerical points.

This mesh may be controlled by the user via the attributes `Mesh`, `Submesh`, and `AdaptiveMesh`. (Depending on the object, the `Mesh` attribute splits into more specific

versions such as UMesh and VMesh for curve and surface plots, or XMesh, YMesh, ZMesh for function and implicit plots.)

First, the object is evaluated numerically on an equidistant “initial mesh” set via the attribute Mesh (or the more specific versions mentioned above).

With AdaptiveMesh = 0, the numerical data over the initial mesh are used to render the object without any further adaptive refinement.

With AdaptiveMesh =  $n$ ,  $n > 0$ , further numerical data are computed before the renderer is called. In particular, the data of neighboring points on the initial mesh are investigated. If a point is not reasonably represented by a straight line connecting the neighboring points, the corresponding intervals of the initial mesh are sub-divided recursively. The adaptive mechanism descends into the sub-intervals of the initial mesh if consecutive line segments of the discretized plot object deviate from a straight line by a “bend angle” of more than 10 degrees. The intervals involved in such a situation are split into halves, recursively.

The value of  $n$  should be a *small* integer that determines the recursive depth of the adaptive refinement. In each direction, up to  $2^n - 1$  additional points are placed between the points of the initial mesh.

If the object looks smooth on the initial mesh set via the attribute Mesh or its more detailed variants, the adaptive mechanism does *not* descend into the intervals of the initial mesh. If there are fine structures hidden inside these intervals, specifying AdaptiveMesh =  $n$  with  $n > 0$  will *not* help to improve the plot. In such a case, the initial mesh should be refined via the appropriate attribute for the initial mesh.

On the other hand, if the initial mesh is fine enough to indicate finer internal structures via the “max bend angle” criterion, it is often more efficient to use AdaptiveMesh =  $n$  than to refine the initial mesh, because the adaptive mechanism refines only those parts of the object that do need refinement. This effect can be seen in “Example 3” on page 24-1691 (Symbolic Math Toolbox).

---

**Note** Note that increasing the recursive depth  $n$  by 1 may increase the run time by a factor of 2 for line objects (2D function graphs and curves) and by a factor of 4 for surface objects (3D function graphs and surfaces). In most cases, a *small* value such as  $n \in \{1, 2, 3\}$  suffices to obtain a reasonably smooth plot object.

---

**Note** Note that the adaptive algorithm for surface objects in 3D is *very expensive!* As an alternative to values  $n > 0$  in `AdaptiveMesh = n`, you may experiment with `AdaptiveMesh = 0, Submesh = [2n- 1, 2n- 1]` in 3D function graphs on page 24-315 or surfaces on page 24-803. The granularity of the “initial mesh” generated with these attribute values is approximately of the same size as the adaptive mesh generated with `AdaptiveMesh = n, Submesh = [0, 0]`. The non-adaptive evaluation on the refined regular mesh may still be more efficient than the evaluation on the (irregular) non-adaptive mesh.

---

## Examples

### Example 1

The following function plot contains areas of high variation. Without a specification of `AdaptiveMesh`, the default mode `AdaptiveMesh = 0` is used and we clearly see artifacts caused by the evaluation on a discrete mesh:

```
plot(plot::Function2d(  
    sin(x) + exp(-5*(x - PI/2)^2)*sin(110*x)/10, x = 0..PI)):
```

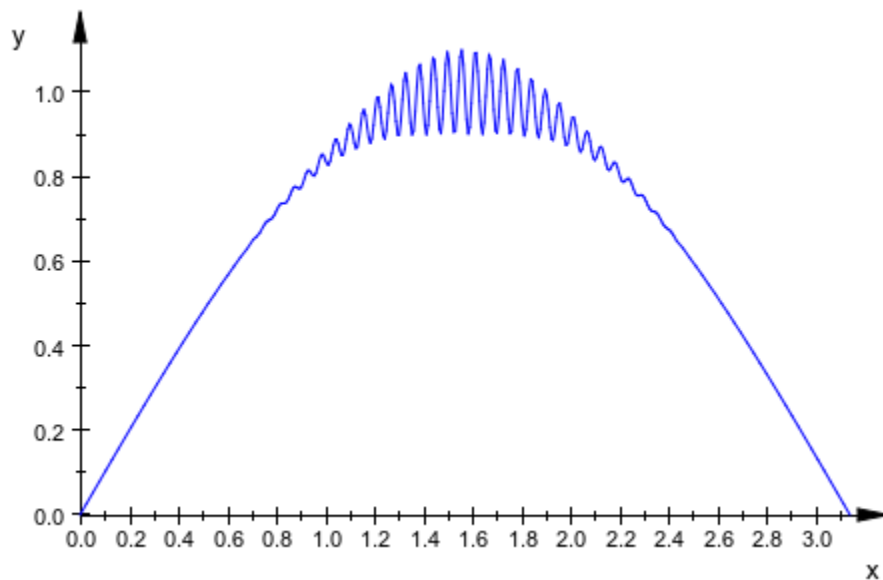

We activate the adaptive refinement with a high level of 3:

```
plot(plot::Function2d(  
  sin(x) + exp(-5*(x - PI/2)^2)*sin(110*x)/10, x = 0..PI,  
  AdaptiveMesh = 3)):
```

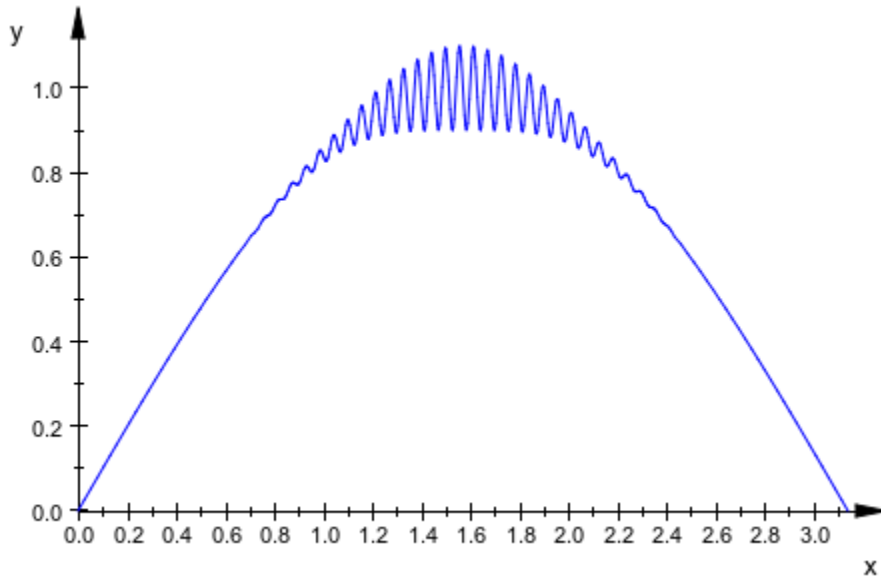

We set the attribute `PointsVisible = TRUE` so that the points of the adaptive mesh become visible:

```
plot(plot::Function2d(  
  sin(x) + exp(-5*(x - PI/2)^2)*sin(110*x)/10, x = 0..PI,  
  AdaptiveMesh = 3, PointsVisible = TRUE)):
```

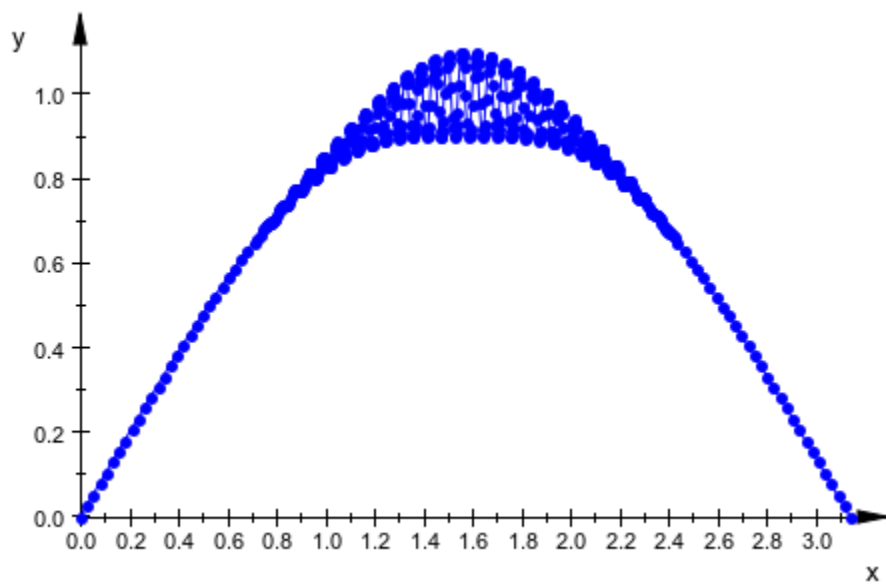

### Example 2

The default value of Mesh does not provide a sufficient resolution for the following spiral:

```
plot(plot::Curve2d([x*cos(x), x*sin(x)], x = 0..50*PI)):
```



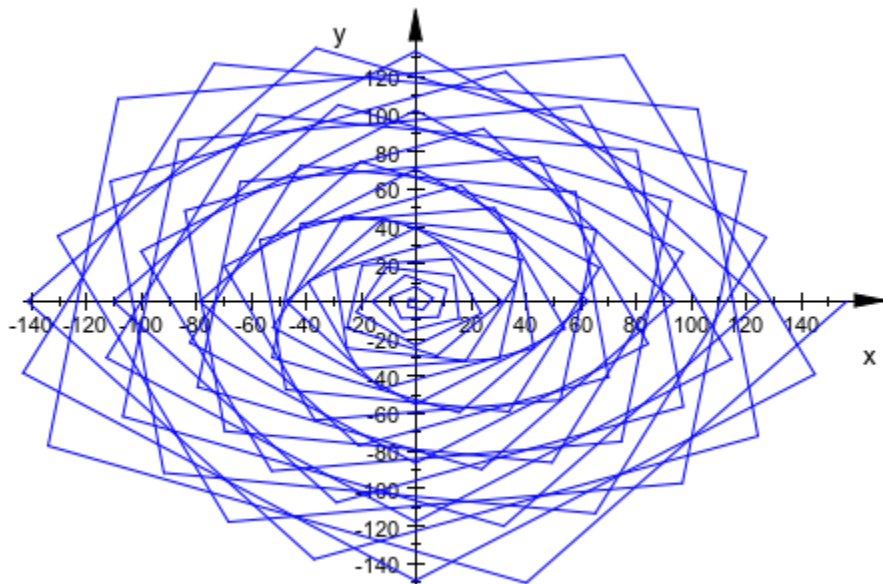

Increasing the Mesh value improves the plot:

```
plot(plot::Curve2d([x*cos(x), x*sin(x)], x = 0..50*PI,  
  Mesh = 1000)):
```

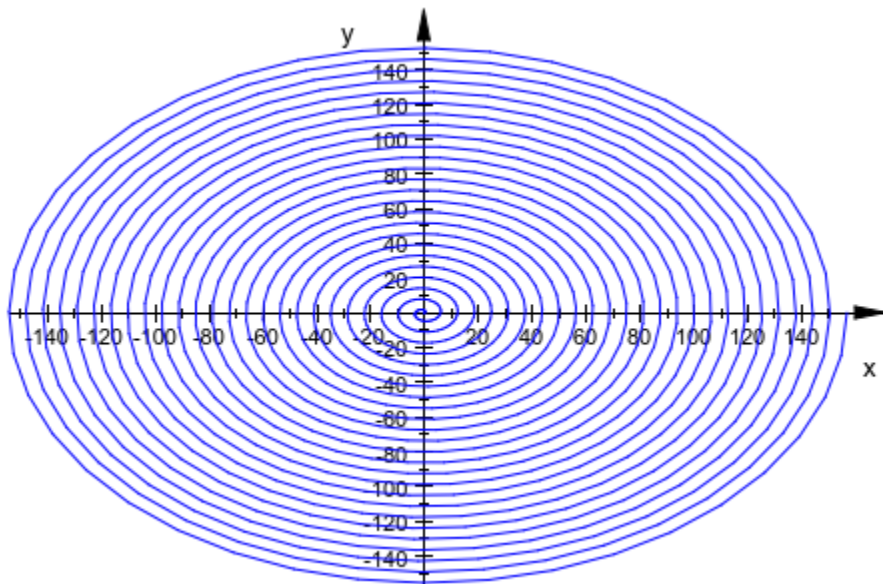

Alternatively, adaptive plotting can be used:

```
plot(plot::Curve2d([x*cos(x), x*sin(x)], x = 0..50*PI,  
AdaptiveMesh = 3)):
```

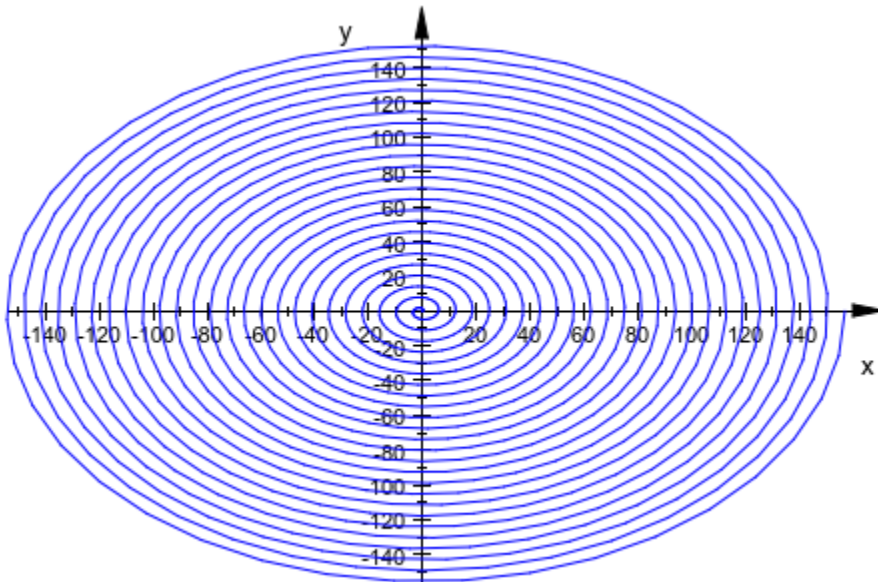

### Example 3

In 3D the typical artifacts caused by the rectilinear initial mesh are “dents” on surface features that are not parallel to a parameter axis. Without a specification of AdaptiveMesh, the default mode `AdaptiveMesh = 0` is used:

```
f := plot::Function3d(sin(x*y)/(abs(x*y) + 1),  
                      x = -4 .. 4, y = -4 .. 4):  
plot(f):
```

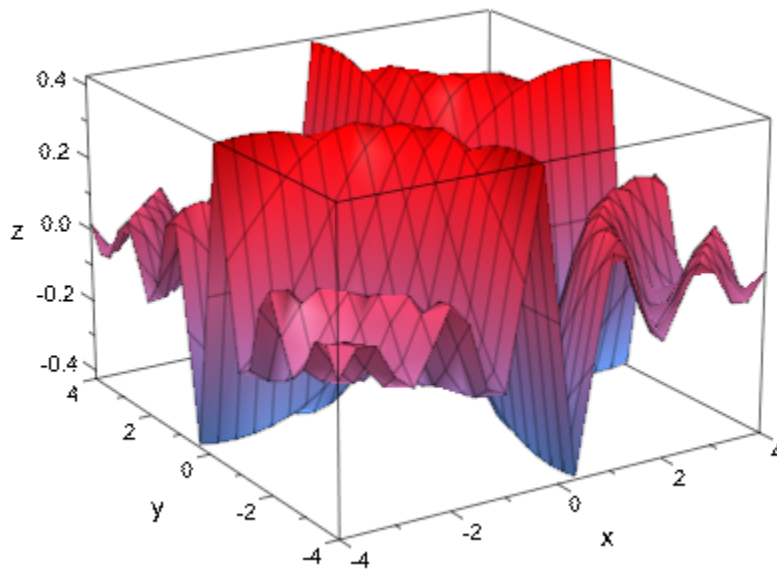

Activating the adaptive refinement, we get a much more accurate plot. However, the computation takes *much longer*:

```
plot(f, AdaptiveMesh = 2):
```

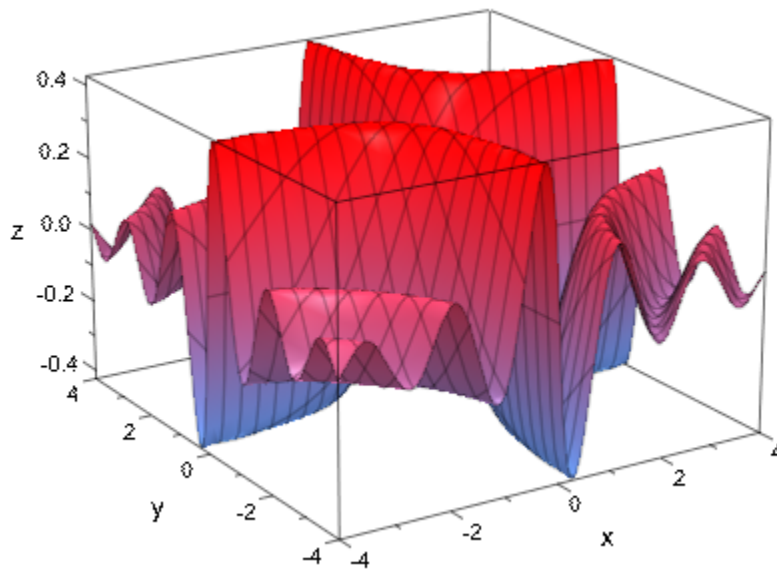

To see how local the refinement is, we set the attribute `MeshVisible = TRUE` so that the internal triangulation of the adaptive mesh becomes visible:

```
plot(f, AdaptiveMesh = 2, MeshVisible = TRUE):
```

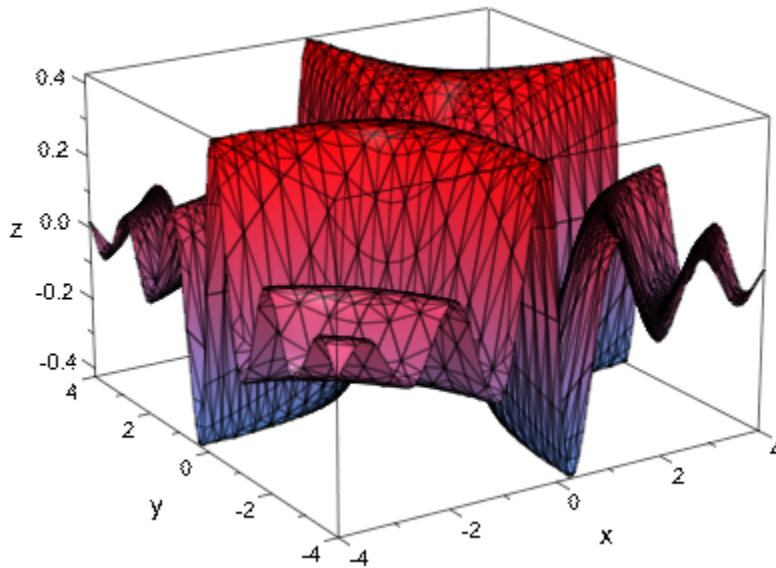

We use a non-adaptive evaluation, but refine the regular mesh by setting Submesh values  $2^n - 1$  that correspond to the adaptive depth  $n = 2$  used above. The result is of a similar quality as before:

```
plot(plot::Function3d(sin(x*y)/(abs(x*y) + 1),  
  x = -4 .. 4, y = -4 .. 4,  
  Submesh = [3, 3])):
```

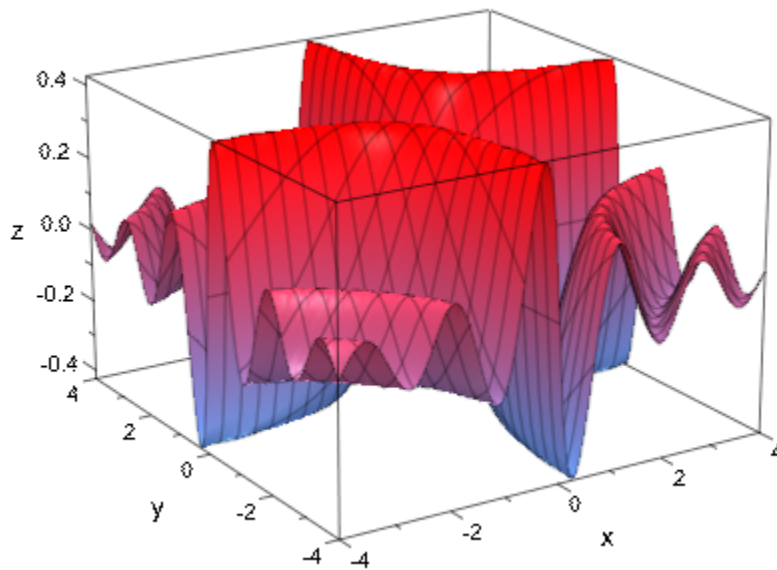

delete f:

## See Also

### MuPAD Functions

Mesh | MeshVisible | Submesh | UMesh | USubmesh | VMesh | VSubmesh | XMesh | XSubmesh | YMesh | YSubmesh | ZMesh

# DiscontinuitySearch

Semi-symbolic search for discontinuities

## Value Summary

Inherited	FALSE, or TRUE
-----------	----------------

## Graphics Primitives

Objects	DiscontinuitySearch Default Values
plot::Curve2d, plot::Curve3d, plot::Function2d, plot::Polar, plot::Sweep	TRUE

## Description

`DiscontinuitySearch = TRUE` versus `DiscontinuitySearch = FALSE` determines whether a graphical object is checked (semi-)symbolically for discontinuities and singularities.

Certain graphical objects such as function graphs or parametrized curves may have singularities. This may create graphical artifacts such as spurious lines between numerical sample points that enclose a singularity. With `DiscontinuitySearch = TRUE`, the object is pre-processed to find potential singularities. If singular points are found, the object is split into several disjoint sub-objects (“branches”), each of which is smooth.

---

**Note** `DiscontinuitySearch` is only available for line objects (2D function graphs and parametrized curves in 2D and 3D). It is not available for surface objects such as 3D function graphs and parametrized surfaces!

---



Discontinuities will only be detected if they are caused by system functions that are implemented as a function environment on page 1-846 with an appropriate "realDiscont" or "numericDiscont" slot.

The search for discontinuities uses interval arithmetic on page 7-33. If special functions are involved that do not support this kind of arithmetic, the search will not succeed.

For efficiency reasons, it is recommended to disable the search for discontinuities with `DiscontinuitySearch = FALSE` when it is known that the graphical object is continuous.

## Examples

### Example 1

The following plot contains first order poles. When the discontinuity search is disabled, spurious vertical lines occur connecting sample points to the left of a pole with neighboring sample points to the right of the pole. Further, the neighborhood of the poles is poorly sampled:

```
plot(plot::Function2d(tan(x^2), x=-3..3,  
                      ViewingBoxYRange = -10..10,  
                      DiscontinuitySearch = FALSE)):
```

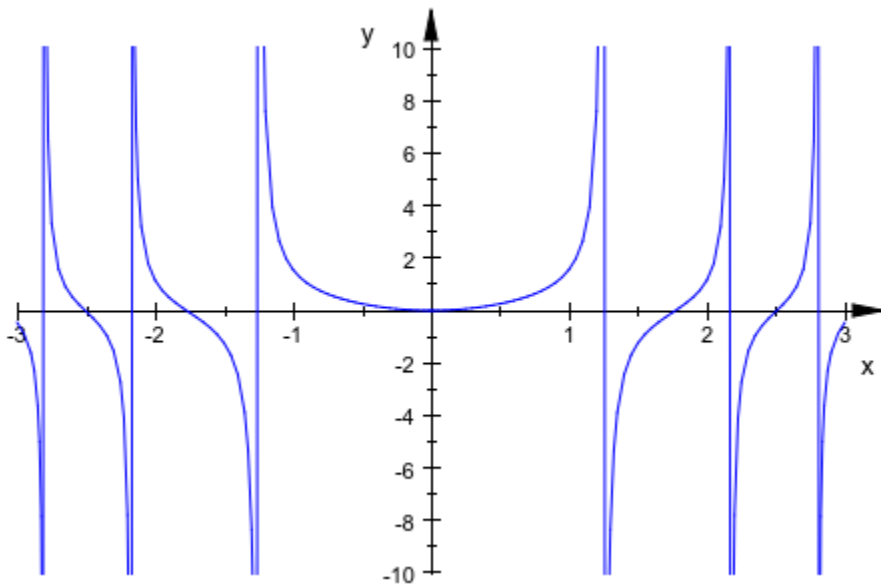

Without specification of `DiscontinuitySearch`, the default setting `DiscontinuitySearch = TRUE` is used. The spurious lines disappear. With the default `VerticalAsymptotesVisible = TRUE`, they are replaced by dashed vertical asymptotes indicating the poles. Also note that the numerical sampling near the poles is better, because the existence of the singularities and their positions is known before the numerical evaluation of the function graph starts:

```
plot(plot::Function2d(tan(x^2), x=-3..3,  
                      ViewingBoxYRange = -10..10)):
```

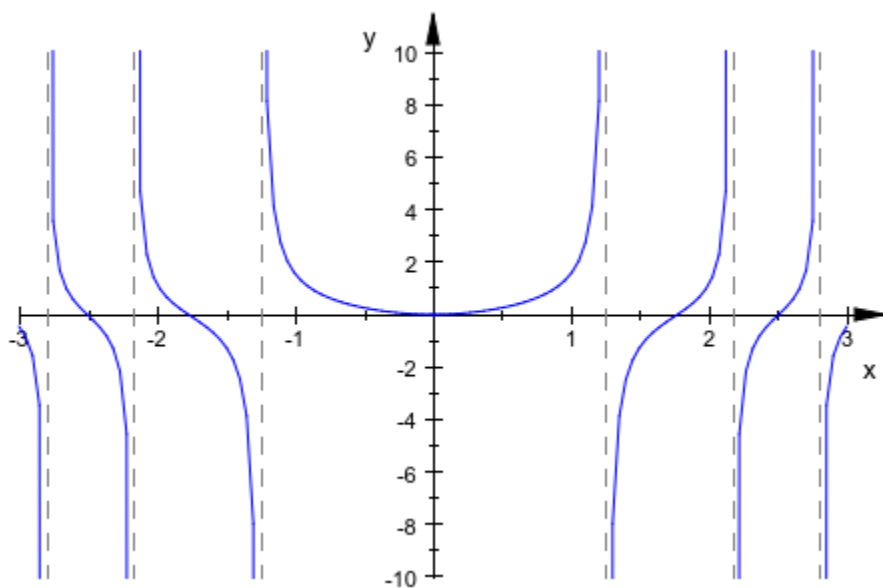

## Example 2

The Heaviside on page 1-917 function has a jump discontinuity. Without a discontinuity search, a spurious line connecting the left and the right limit points of the jump appears:

```
plot(plot::Function2d(heaviside(x-1), x = -1..3,  
                      DiscontinuitySearch = FALSE)):
```

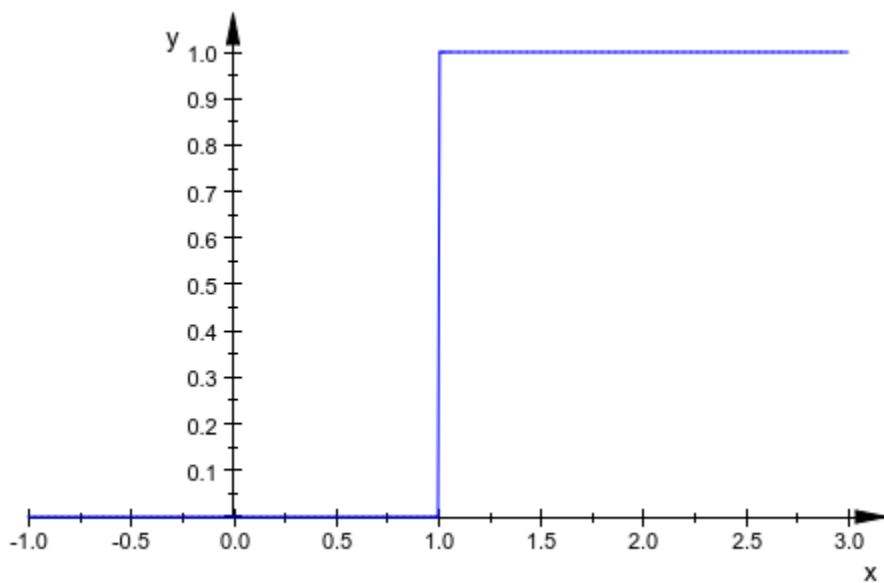

This spurious line disappears with the default setting `DiscontinuitySearch = TRUE`:

```
plot(plot::Function2d(heaviside(x-1), x = -1..3),  
      VerticalAsymptotesVisible = FALSE):
```

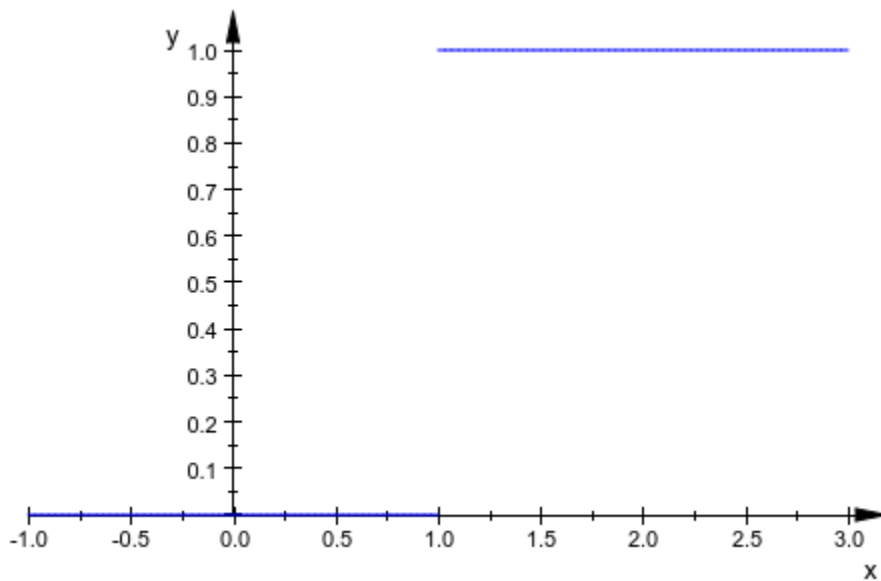

### Example 3

Without a discontinuity search, the poles of the following singular 3D curve are poorly presented graphically:

```
plot(plot::Curve3d([cos(u), sin(u), tan(2*u)], u = 0..2*PI,  
    ViewingBox = [-1..1, -1..1, -10..10],  
    DiscontinuitySearch = FALSE)):
```

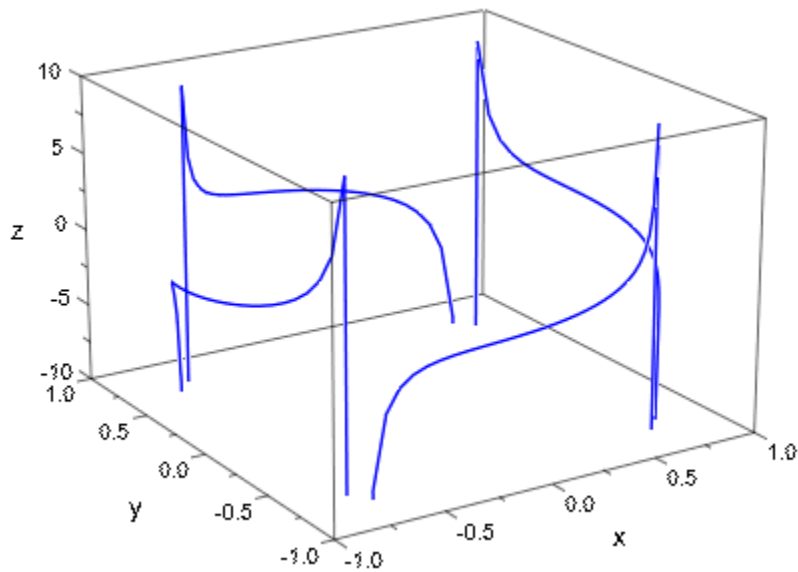

The default setting `DiscontinuitySearch = TRUE` produces a better graphical presentation:

```
plot(plot::Curve3d([cos(u), sin(u), tan(2*u)], u = 0..2*PI,  
  ViewingBox = [-1..1, -1..1, -10..10])):
```

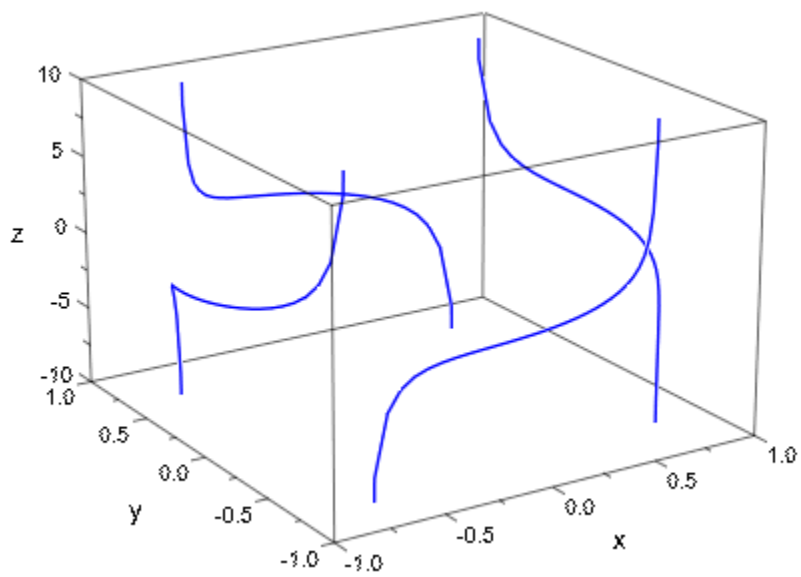

## MeshSubmesh

Number of sample points

### Value Summary

Mesh	Library wrapper for “UMesh, VMesh, XMesh, YMesh, and ZMesh”	See below
Submesh	Library wrapper for “USubmesh, VSubmesh, XSubmesh, and YSubmesh”	See below

### Graphics Primitives

Objects	Default Values
plot::Cylindrical, plot::Function3d, plot::Spherical, plot::Surface, plot::XRotate, plot::ZRotate	Mesh: [25, 25] Submesh: [0, 0]
plot::Rootlocus	Mesh: 51
plot::Sweep	Mesh: 25 Submesh: 4
plot::Curve2d, plot::Curve3d, plot::Function2d, plot::Polar	Mesh: 121 Submesh: 0
plot::Conformal	Mesh: [11, 11] Submesh: [0, 0]
plot::Plane	Mesh: [15, 15]



Objects	Default Values
plot::Implicit2d, plot::Raster, plot::VectorField2d	Mesh: [11, 11]
plot::VectorField3d	Mesh: [7, 7, 7]
plot::Implicit3d	Mesh: [11, 11, 11]
plot::Inequality	Mesh: [256, 256]
plot::Density	Mesh: [25, 25]
plot::Tube	Mesh: [60, 11] Submesh: [0, 1]
plot::Matrixplot	Submesh: [2, 2]
plot::Ode2d, plot::Ode3d	Submesh: 4
plot::Listplot	Submesh: 6

## Description

The attributes `Mesh` and `Submesh` determine the number of sample points used for the numerical approximation of plot objects.

Many plot objects have to be evaluated numerically on a discrete mesh. Depending on the object type, there are type specific attributes such as `XMesh` (for 2D function graphs), `UMesh`, `VMesh` (for parametrized surfaces), `XMesh`, `YMesh`, `ZMesh` (for implicit plots in 3D) etc. setting the number of sample points of the numerical mesh.

The `Mesh` attribute unifies these more specific attributes and can be set for all objects that use a discrete numerical mesh. Depending on the object, the values for `Mesh` must be integer numbers or lists of such numbers. The more specific attributes are set automatically when `Mesh` values are specified.

E.g., in a 2D function plot of type `plot::Function2d`, `Mesh = 200` is equivalent to `XMesh = 200`. In a 3D surface plot of type `plot::Surface`, `Mesh = [40, 50]` is equivalent to `UMesh = 40`, `VMesh = 50`.

In the “object inspector” of the interactive graphics tool (see section `Viewer`, `Browser`, and `Inspector: Interactive Manipulation (Symbolic Math Toolbox)` in this document), only the type specific attributes are visible, not the `Mesh` attribute.

Roughly speaking, high Mesh values yield smooth plots but cost run time.

With the attribute `Submesh = m`, additional  $m$  equidistant sample points are inserted between each pair of adjacent sample points set by the `Mesh` attribute. This smoothens the object.

Like `Mesh`, the attribute `Submesh` unifies type specific attributes such as `XSubmesh`, `USubmesh` etc. Depending on the object, the values of `Submesh` have to be integers or lists of integers.

There is a semantical difference between the “major” mesh points set by `Mesh` and the “minor” mesh points inserted by `Submesh`. There are coordinate lines associated with the (regular) numerical mesh. See `XLinesVisible`, `ULinesVisible` etc. The coordinates lines are available only for the mesh given by the “major” mesh points, whereas `Submesh` does not influence the number of coordinate lines. Thus, increased `Mesh` values yield a smoother plot with more coordinate lines, whereas `Submesh` can be used to smoothen the plot without adding further coordinate lines.

Apart from this effect, the pair `Mesh = n`, `Submesh = m` corresponds to the combination `Mesh = (n - 1) (m + 1) + 1`, `Submesh = 0`.

If adaptive sampling on page 24-1684 is enabled, further non-equidistant sample points are chosen automatically between the equidistant points of the ‘initial mesh’ set via the `Mesh` and `Submesh` attributes.

## Examples

### Example 1

In the following plot, the default value of `Mesh` does not suffice to produce a sufficiently exact picture:

```
plot(plot::Function2d(sin(x^2), x = 0..10)):
```

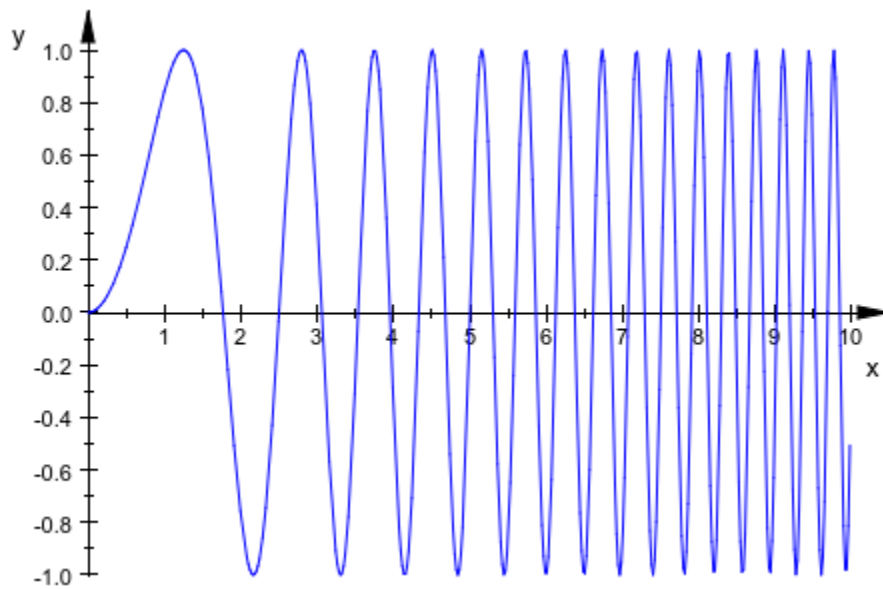

A mesh with more sample points yields a higher resolution graphics:

```
plot(plot::Function2d(sin(x^2), x = 0..10, Mesh = 500)):
```

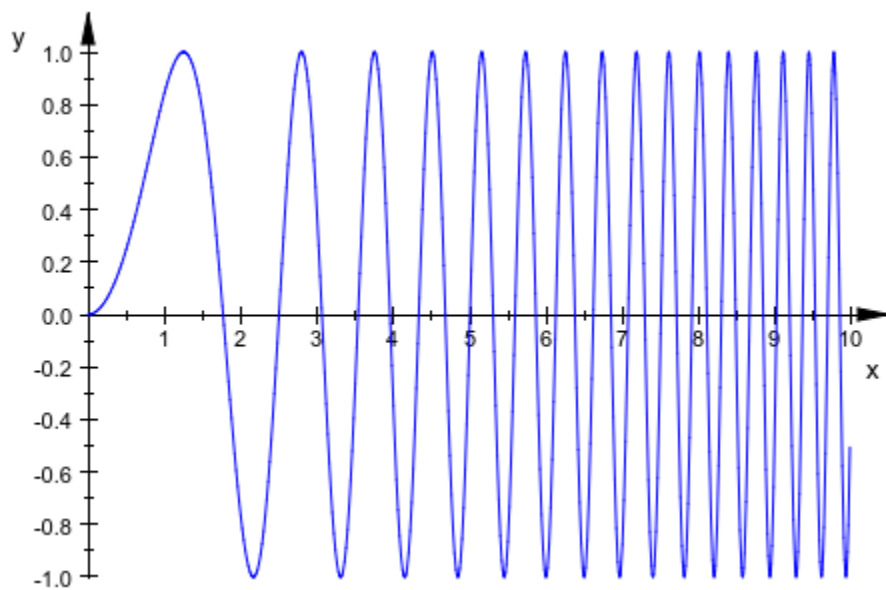

## Example 2

The default value of Mesh does not provide a sufficient resolution for the following spiral:

```
plot(plot::Curve2d([x*cos(x), x*sin(x)], x = 0..50*PI)):
```

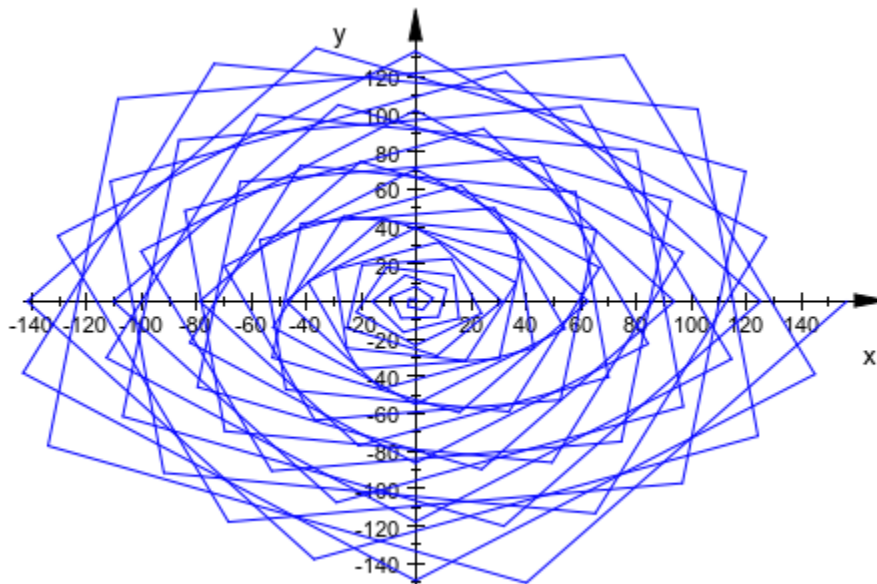

The spiral winds around the origin 25 times. We wish to have approximately 40 sample points per revolution, so we need to use a total of 1000 sample points:

```
plot(plot::Curve2d([x*cos(x), x*sin(x)], x = 0..50*PI,  
  Mesh = 1000)):
```

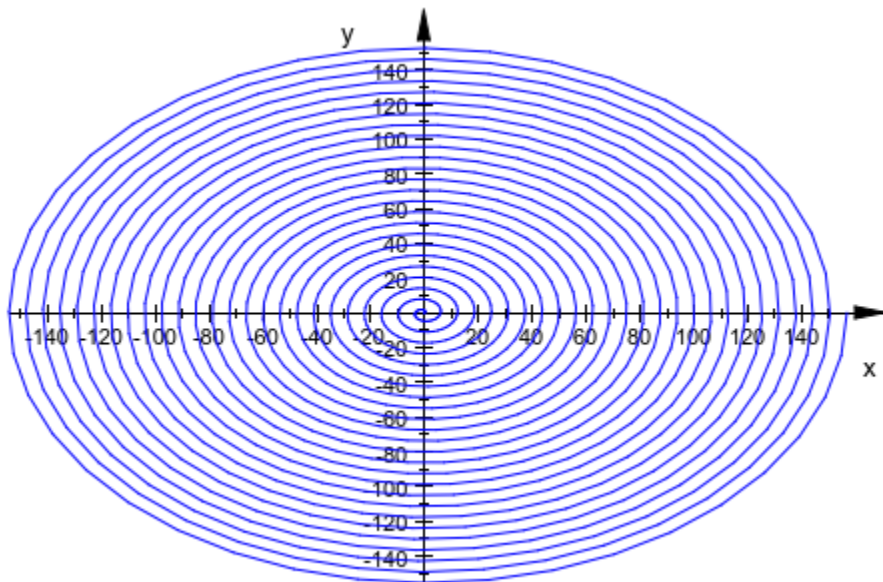

### Example 3

Note the difference between increased Mesh values and additional sample points inserted via Submesh. Submesh does not introduce additional coordinate lines:

```
S1 := plot::Scene3d(plot::Function3d(
    x^2 + y^2, x = 0..1/2, y = 0..1, Mesh = [4, 4])):
S2 := plot::Scene3d(plot::Function3d(
    x^2 + y^2, x = 0..1/2, y = 0..1, Mesh = [4, 4],
    Submesh = [2, 2])):
S3 := plot::Scene3d(plot::Function3d(
    x^2 + y^2, x = 0..1/2, y = 0..1, Mesh = [10, 10])):
plot(S1, S2, S3, Layout = Horizontal,
    Height = 5*unit::cm, Width = 12*unit::cm,
    LineColor = RGB::Black):
```

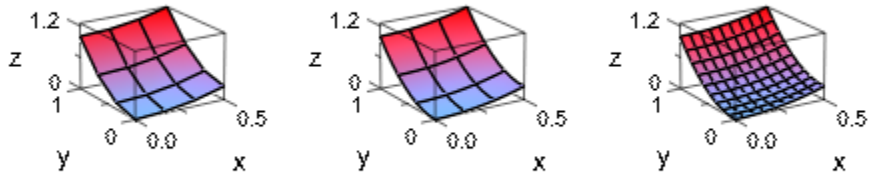

delete S1, S2, S3:

## See Also

### MuPAD Functions

[AdaptiveMesh](#) | [UMesh](#) | [USubmesh](#) | [VMesh](#) | [VSubmesh](#) | [XMesh](#) | [YMesh](#) | [ZMesh](#)

## MinimumDistance

Space between stream lines

### Value Summary

Optional	MuPAD expression
----------	------------------

### Graphics Primitives

Objects	MinimumDistance Default Values
<code>plot::Streamlines2d</code>	

### Description

`MinimumDistance` determines how closely spaced the stream lines generated by a `plot::Streamlines2d` object are.

`plot::Streamlines2d` displays orbits (stream lines) of ODEs which are at least  $m$  and at most  $2m$  units apart from one another, if `MinimumDistance` has been set to  $m$ .

The distance of stream lines is taken as the Euclidean distance, measured in coordinate units. If `MinimumDistance` is not set, it defaults to 0.02 times the maximum extent in either direction.

### Examples

#### Example 1

The default setting is adequate for many stream lines plots:



```
plot(plot::Streamlines2d([sin(x)^2-cos(y^2),  
                          sin(x^2)-cos(y)^2],  
                          x=0..4, y=0..4))
```

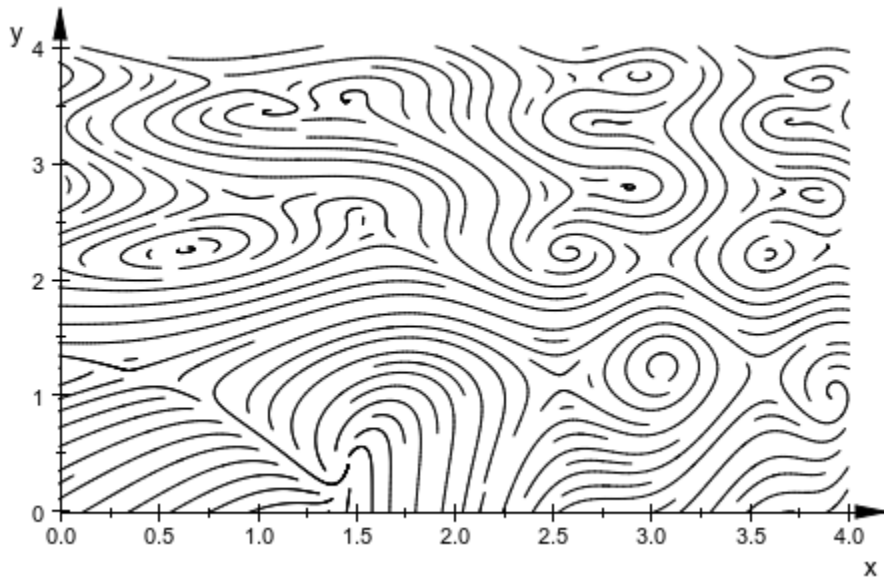

To display simple ODEs, you may wish to reduce the number of stream lines:

```
plot(plot::Streamlines2d([1, 1], x=0..4, y=0..4))
```

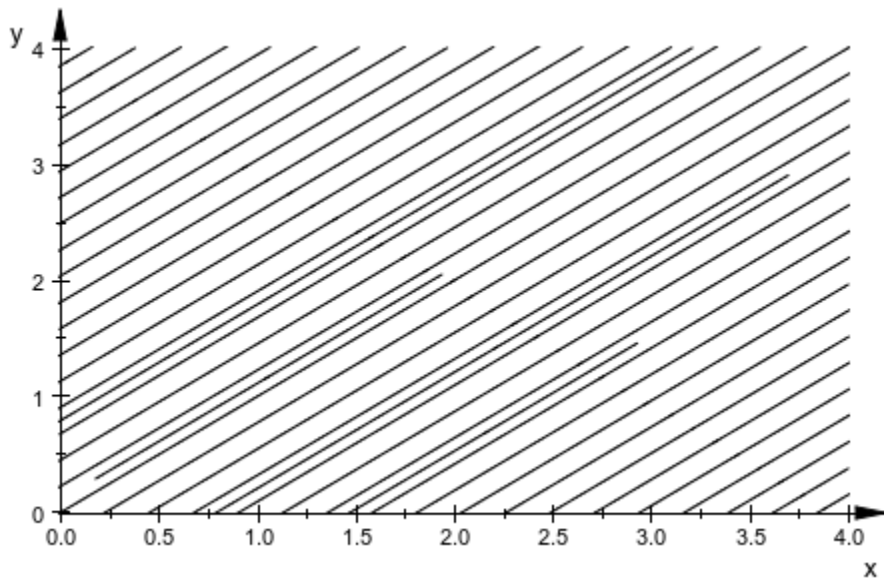

```
plot(plot::Streamlines2d([1, 1], x=0..4, y=0..4, MinimumDistance=0.25))
```

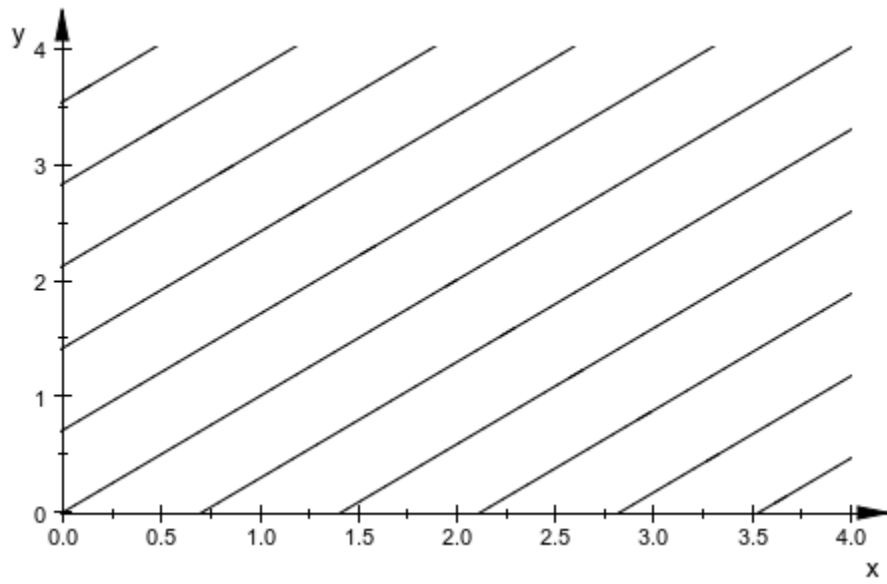

## ODEMethodStepsize

Numerical scheme used for solving the ODE

### Value Summary

ODEMethod, Stepsize	Optional	MuPAD expression
---------------------	----------	------------------

### Graphics Primitives

Objects	Default Values
plot::Ode2d, plot::Ode3d	ODEMethod: DOPRI78
plot::Streamlines2d	ODEMethod: ABM4

### Description

`ODEMethod = method` determines the numerical scheme for solving the ODE. The parameter `method` is a name such as `EULER1`, `RK4`, `RKF78` etc.

`Stepsize = h` sets a constant step size  $h$  that is used to compute the numerical solution.

Internally, `plot::Ode2d`, `plot::Ode3d`, and `plot::Streamlines2d` call the routine `numeric::odesolve` for solving the given ODE numerically. The method set by the attribute `ODEMethod = method` and/or the step size set by `Stepsize = h` are forwarded to `numeric::odesolve`. See the corresponding help page on page 19-196 for a complete list of all methods available and for further details on the step size.

The setting `ODEMethod = ABM4` is an exception to the above: It is only available with `plot::Streamlines2d` and makes the plot use a fast Adams-Bashforth-Moulton predictor corrector integrator of fourth order with fixed step size. It ignores the settings of `RelativeError` and `AbsoluteError`.

## Examples

### Example 1

We solve the initial value problem  $y'(t) = -y(t)$ ,  $y(0) = 1$  numerically by the classical 4th order Runge-Kutta scheme RK4 using a constant step size 0.1:

```
f := (t, Y) -> [-Y[1]]:
Y0 := [1]:
timemesh:= [0, 1, 2, 3, 4, 5]:
plot(plot::Ode2d(f, timemesh, Y0, ODEMethod = RK4,
                StepSize = 0.1))
```

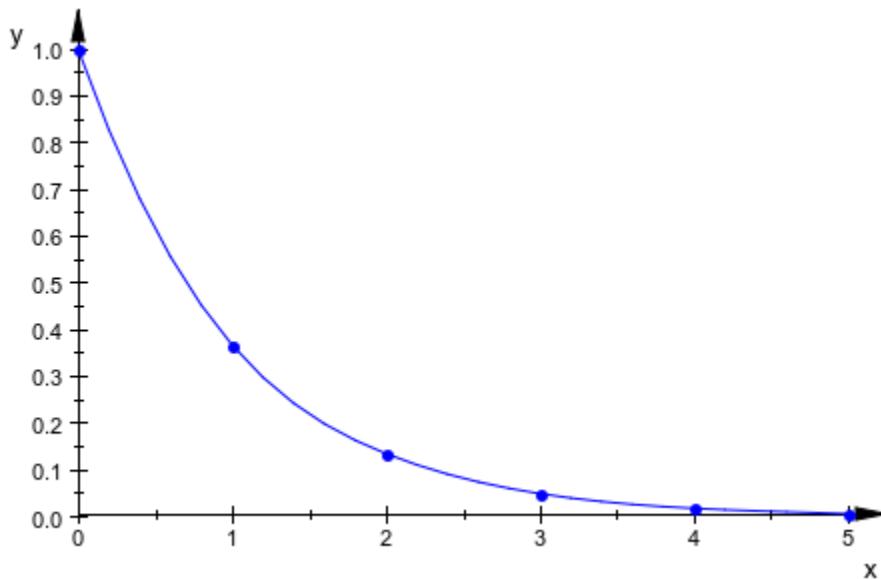

```
delete f, Y0, timemesh:
```

### Example 2

With the default settings, `plot::Streamlines2d` is not able to plot the vector field

$\left[1, 3^{2/y}\right]$  (which is not Lipschitz continuous) in a satisfying way:

```
plot(plot::Streamlines2d([1, surd(3,y)^2],
                        x=-3..3, y=-2..2))
```

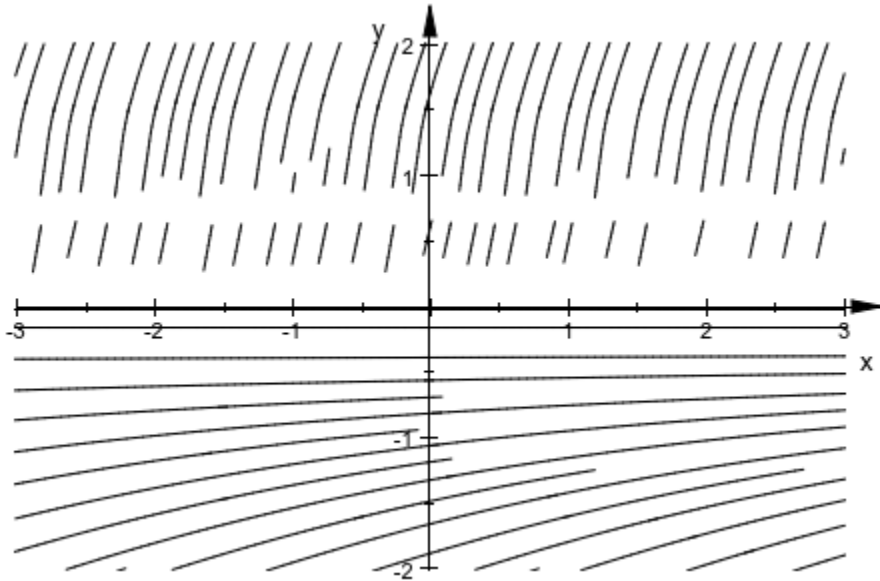

By using a different numerical integrator, the problems can be overcome (at the cost of longer computation):

```
plot(plot::Streamlines2d([1, surd(3,y)^2],
                        x=-3..3, y=-2..2,
                        ODEMethod=RKF43,
                        RelativeError=1e-3))
```

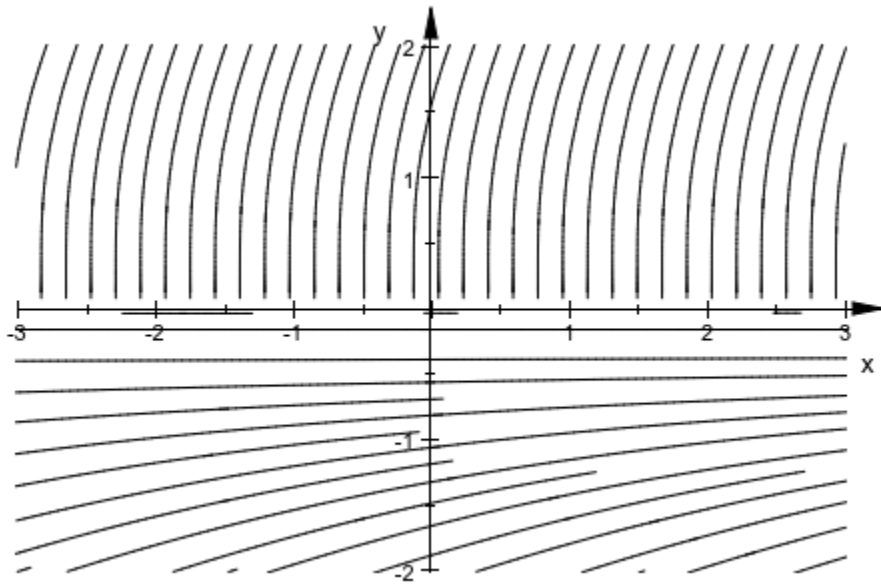

## See Also

### MuPAD Functions

[AbsoluteError](#) | [InitialConditions](#) | [ODEMethod](#) | [Projectors](#) | [RelativeError](#)

## UMeshVMeshUSubmeshVSubmesh

Number of sample points

### Value Summary

UMesh, USubmesh, VMesh, VSubmesh	Inherited	Positive integer
----------------------------------	-----------	------------------

### Graphics Primitives

Objects	Default Values
plot::Curve2d, plot::Curve3d, plot::Polar	UMesh: 121 USubmesh: 0
plot::Cylindrical, plot::Spherical, plot::Surface, plot::XRotate, plot::ZRotate	UMesh, VMesh: 25 USubmesh, VSubmesh: 0
plot::Rootlocus	UMesh: 51
plot::Sweep	UMesh: 25 USubmesh: 4
plot::Plane	UMesh, VMesh: 15
plot::Tube	UMesh: 60 VMesh: 11 USubmesh: 0 VSubmesh: 1
plot::Ode2d, plot::Ode3d	USubmesh: 4



## Description

The attributes UMesh etc. determine the number of sample points used for the numerical approximation of parameterized plot objects such as curves and surfaces.

Many plot objects have to be evaluated numerically on a discrete mesh. The attributes described on this help page serve for setting the number of sample points of the numerical mesh.

For curves in 2D and 3D given by a parametrization  $x(u)$ ,  $y(u)$  and, possibly,  $z(u)$  with the curve parameter  $u$ , the attribute UMesh =  $n$  creates a numerical mesh of  $n$  equidistant  $u$  values. The attribute USubmesh =  $m$  inserts additional  $m$  mesh points between each pair of adjacent points set by UMesh.

The combinations UMesh =  $n$ , USubmesh =  $m$  and UMesh =  $(m + 1)(n - 1) + 1$ , USubmesh = 0 are equivalent.

Specifying Mesh, Submesh has the same effect as specifying UMesh, USubmesh.

The sample points of a curve can be made visible by setting PointsVisible = TRUE.

Surface objects in 3D are parameterized by coordinate functions  $x(u, v)$ ,  $y(u, v)$ ,  $z(u, v)$  of two surface parameters  $u, v$ .

The attribute UMesh =  $n_u$  sets the number  $n_u$  of sample points for the first surface parameter. The attribute VMesh =  $n_v$  sets the number  $n_v$  of sample points for the second surface parameter. The parametrization is evaluated on a regular mesh of  $n_u \times n_v$  values of the surface parameters  $u, v$ .

With the USubmesh, VSubmesh attributes, additional equidistant sample points can be inserted between each pair of adjacent sample points set by the UMesh, VMesh attributes.

With ULinesVisible = TRUE and VLinesVisible = TRUE, respectively, the parameter lines of the regular mesh set by the attributes UMesh, VMesh are displayed on the surface. Additional points inserted via USubmesh, VSubmesh do *not* create additional parameter lines.

You can also specify UMesh =  $n_u$ , VMesh =  $n_v$ , USubmesh =  $m_u$ , VSubmesh =  $m_v$  in the shorter form Mesh = [ $n_u, n_v$ ], Submesh = [ $m_u, m_v$ ].

If adaptive sampling on page 24-1684 is enabled, further non-equidistant sample points are chosen automatically between the equidistant points of the 'initial mesh' set via the `UMesh`, `USubmesh`, `VMesh`, `VSubmesh` attributes.

## Examples

### Example 1

It is possible to use low settings of mesh parameters to achieve special effects. As an example, we draw a parametrization of a circle with just six evaluation points:

```
plot(plot::Curve2d([cos(t), sin(t)], t = 0..2*PI, UMesh = 6,  
  Scaling = Constrained))
```

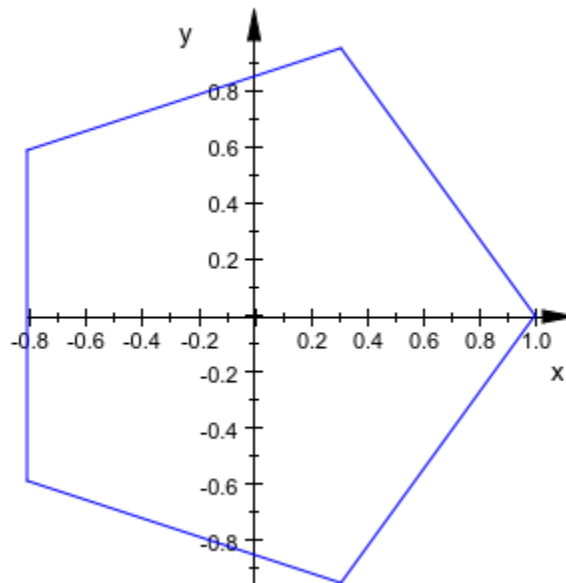

The reason we get a pentagon here and not a hexagon is that the first and the last evaluation points coincide: six points in a line means five line segments.

With `UMesh = 30`, the circle looks like a circle:

```
plot(plot::Curve2d([cos(t), sin(t)], t = 0..2*PI, UMesh = 30,  
  Scaling = Constrained))
```

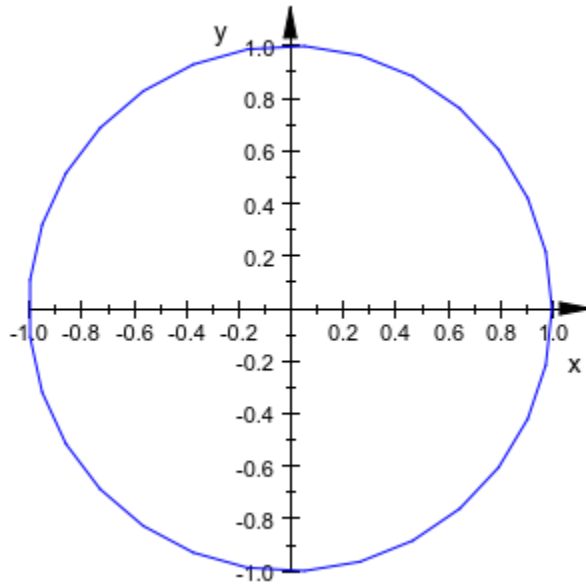

## Example 2

The default values of UMesh, VMesh do not provide a sufficient resolution for the following graphics:

```
plot(plot::Surface([r*cos(phi), r*sin(phi), r*phi],  
  r = 0.. 1, phi = 0..10*PI)):
```

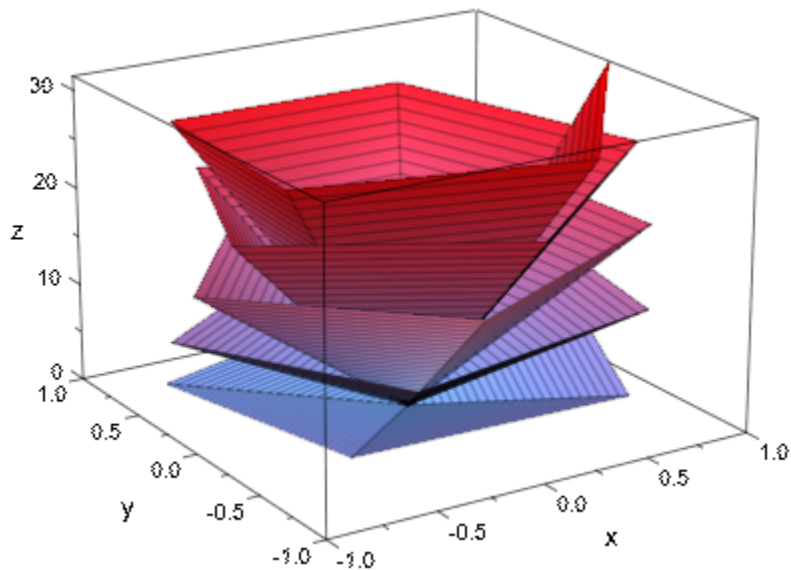

The spiral winds around the  $z$ -axis 5 times. We wish to have approximately 40 sample points per revolution, so we need to use a total of 200 sample points with respect to the angle parameter  $\phi$ . The coordinate lines related to the radial parameter  $r$  are straight lines, so a very low resolution in this direction suffices:

```
plot(plot::Surface([r*cos(phi), r*sin(phi), r*phi],  
                  r = 0..1, phi = 0..10*PI,  
                  UMesh = 2, VMesh = 200)):
```

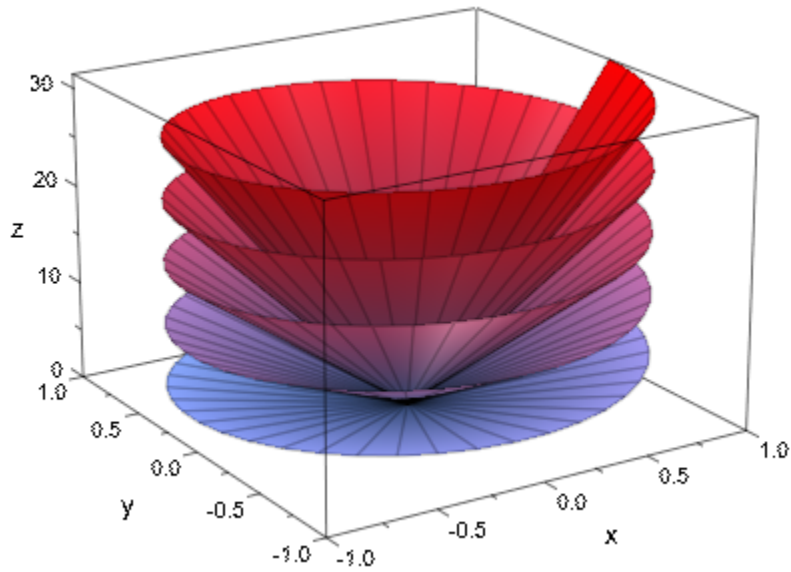

When refining the mesh via VSubmesh, no additional parameter lines are created:

```
plot(plot::Surface([r*cos(phi), r*sin(phi), r*phi],  
  r = 0..1, phi = 0..10*PI,  
  UMesh = 2, VMesh = 25, VSubmesh = 8)):
```

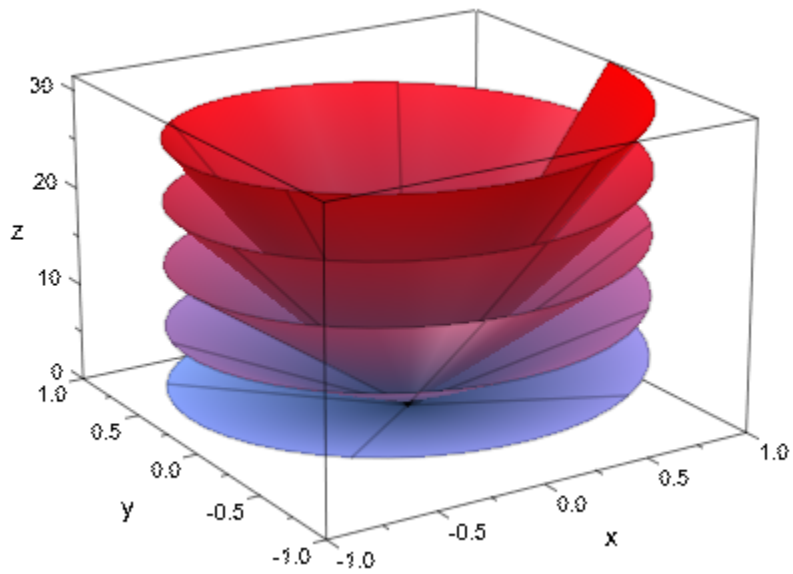

## See Also

### MuPAD Functions

[AdaptiveMesh](#) | [Mesh](#) | [Submesh](#) | [XMesh](#) | [YMesh](#) | [ZMesh](#)

# XMeshXSubmeshYMeshYSubmeshZMesh

Number of sample points

## Value Summary

XMesh, XSubmesh, YMesh, YSubmesh, ZMesh	Inherited	Positive integer
---	-----------	------------------

## Graphics Primitives

Objects	Default Values
plot::Function2d	XMesh: 121 XSubmesh: 0
plot::Function3d	XMesh, YMesh: 25 XSubmesh, YSubmesh: 0
plot::Implicit2d, plot::Raster, plot::VectorField2d	XMesh, YMesh: 11
plot::Implicit3d	XMesh, YMesh, ZMesh: 11
plot::VectorField3d	XMesh, YMesh, ZMesh: 7
plot::Conformal	XMesh, YMesh: 11 XSubmesh, YSubmesh: 0
plot::Inequality	XMesh, YMesh: 256
plot::Density	XMesh, YMesh: 25
plot::Matrixplot	XSubmesh, YSubmesh: 2
plot::Listplot	XSubmesh: 6

## Description

The attributes `XMesh` etc. determine the number of sample points used for the numerical approximation of plot objects such as function graphs, implicit plots etc.

Various object types use numerical function evaluations on a discrete equidistant mesh. `XMesh`, `YMesh`, and for `plot::Implicit3d` also `ZMesh` set the number of points of this mesh. An exception of this are parameterized curves and surfaces, which use the attributes `UMesh`, `USubmesh`, `VMesh`, and `VSubmesh`.

For most of the object types listed above, the interpretation of the integers set by these attributes is as follows: In each of `XRange`, `YRange`, `ZRange`, the corresponding number of points is spread out equidistantly. For `XMesh = 2` and `XRange = 0..1`, for example, evaluation takes place for  $x = 0$  and  $x = 1$ . For `XMesh = 3`, a further mesh point at  $x = \frac{1}{2}$  is used.

The exception to this rule is `plot::Implicit2d`: Here, the values of `XMesh` and `YMesh` determine the density of the grid *used for finding components* and increasing their values helps exactly in those cases where components (i.e., lines) are missing from the plot. Decreasing `XMesh` and `YMesh` in a 2D implicit plot will not make the curves appear rougher; it may result in curves missing.

For types reacting to `AdaptiveMesh` and for `plot::Implicit3d`, this mesh is used to find *initial* values that can be refined further. See the documentation of the specific types and of `AdaptiveMesh` for details.

In general, a finer mesh (higher values) leads to a longer computation, while a coarser mesh may cause details being missed.

One may specify `XMesh = nx`, `YMesh = ny`, `XSubmesh = mx`, `YSubmesh = my` also in the shorter Form `Mesh = [nx, ny]`, `Submesh = [mx, my]`.

## Examples

### Example 1

The notorious function  $\sin\left(\frac{1}{x}\right)$  oscillates wildly near the origin. The standard mesh values do not suffice to resolve the behavior of the function near the critical point:



```
plot(plot::Function2d(sin(1/x), x = -1 .. 1))
```

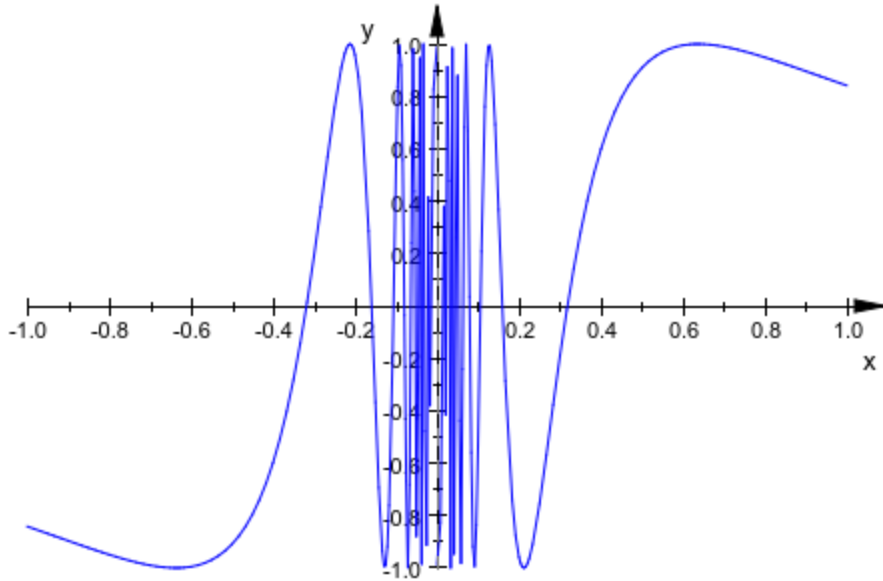

We get a better result with an increased value of XMesh:

```
plot(plot::Function2d(sin(1/x), x = -1 .. 1), XMesh = 1000)
```

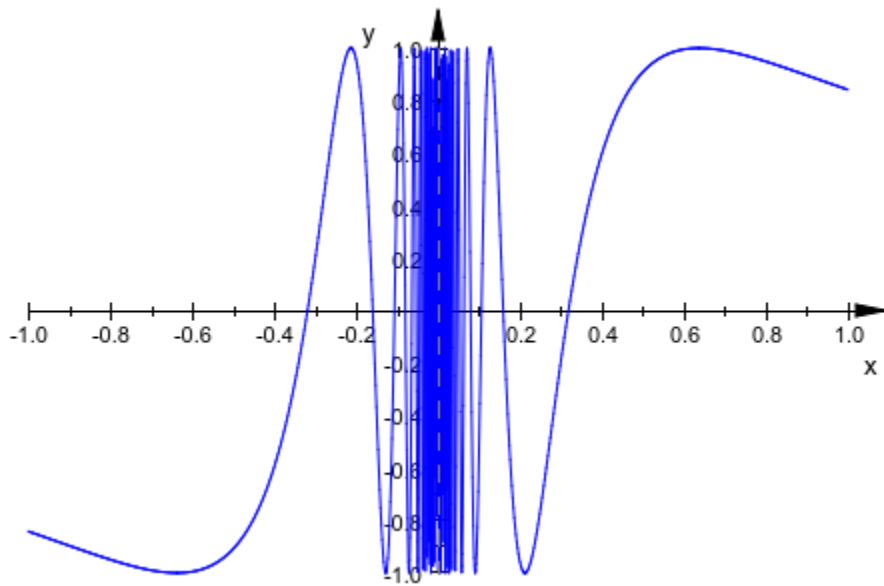

## Example 2

In the following plot, the default values of XMesh, YMesh do not suffice to produce a sufficiently smooth function graph:

```
plot(plot::Function3d(besselJ(0, sqrt(x^2 + y^2)),  
      x = -20 .. 20, y = -20 .. 20)):
```

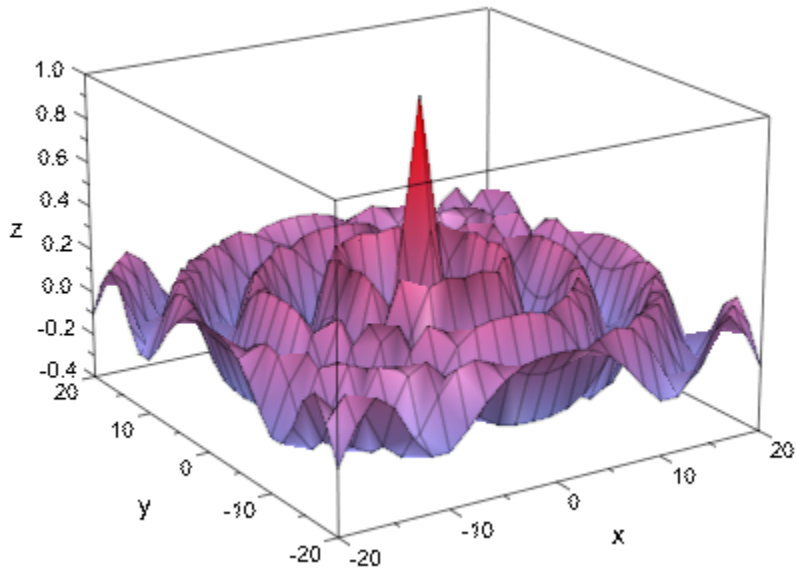

Increasing the default values `XSubmesh = 0`, `YSubmesh = 0` yields a higher resolution plot. Note that this does not influence the number of mesh lines that are displayed:

```
plot(plot::Function3d(besselJ(0, sqrt(x^2 + y^2)),  
  x = -20 .. 20, y = -20 .. 20,  
  XSubmesh = 2, YSubmesh = 2)):
```

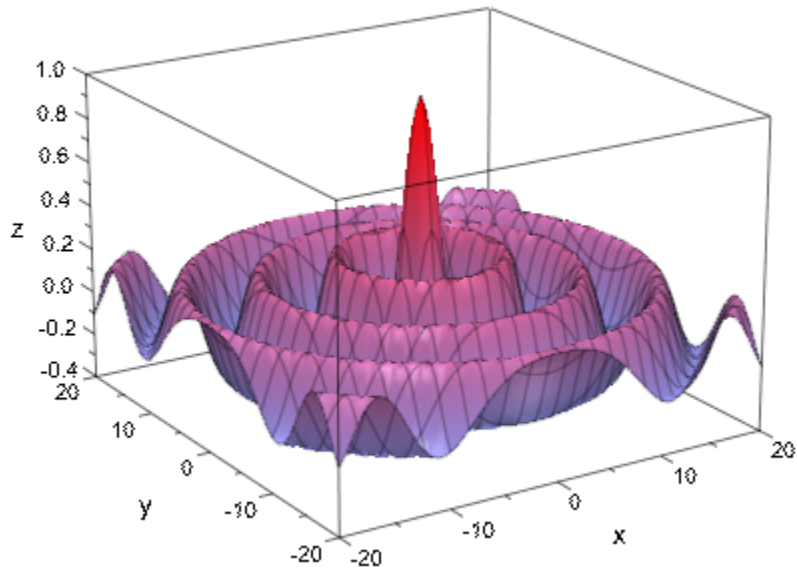

Alternatively, we increase the values of XMesh, YMesh and use the default values XSubmesh = 0, YSubmesh = 0. This, however, increases the number of mesh lines that are displayed:

```
plot(plot::Function3d(besselJ(0, sqrt(x^2 + y^2)),  
  x = -20 .. 20, y = -20 .. 20,  
  XMesh = 73, YMesh = 73)):
```

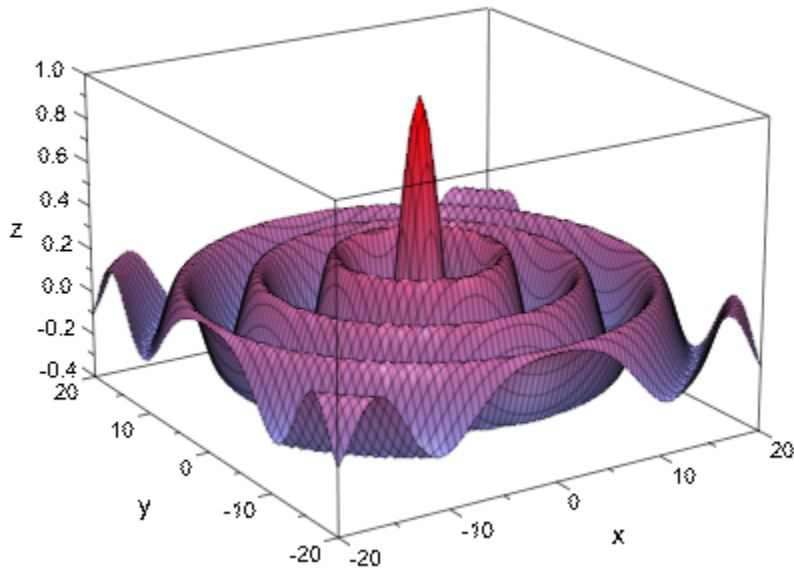

Yet another possibility is to use the default values of XMesh, YMesh, XSubmesh, YSubmesh and activate the adaptive mechanism on page 24-1684 to smoothen the critical regions of the plot. However, this plot consists almost completely of critical regions and the adaptive mechanism will therefore be slower than a direct calculation with a finer mesh that leads to almost the same result:

```
plot(plot::Function3d(besselJ(0, sqrt(x^2 + y^2)),  
    x = -20 .. 20, y = -20 .. 20,  
    AdaptiveMesh = 2)):
```

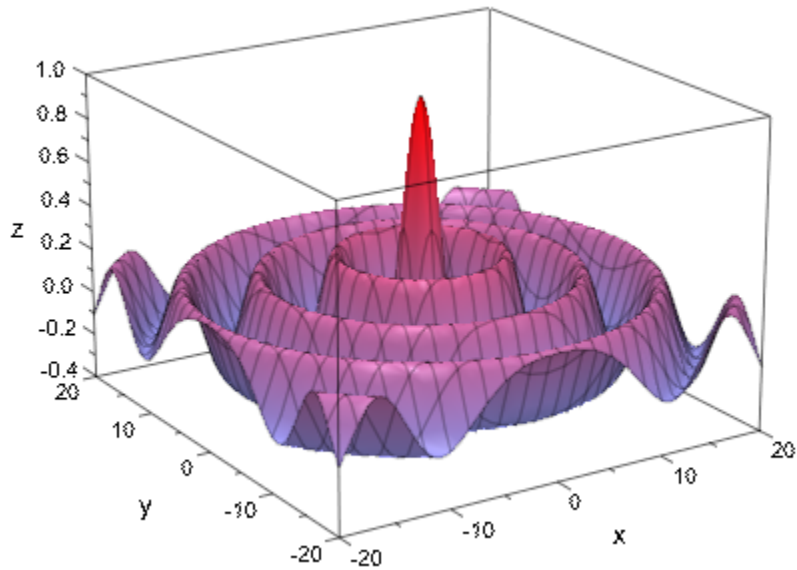

### Example 3

For two-dimensional implicit plots, `XMesh` and `YMesh` determine the mesh of “seed points” that are used to find components (see the documentation of `plot::Implicit2d` for more details). In effect, this means that if some components are missing from a plot, the values of these attributes should be increased:

```
plot(plot::Implicit2d(sin(2*x*y), x = -3..3, y = -3..3))
```

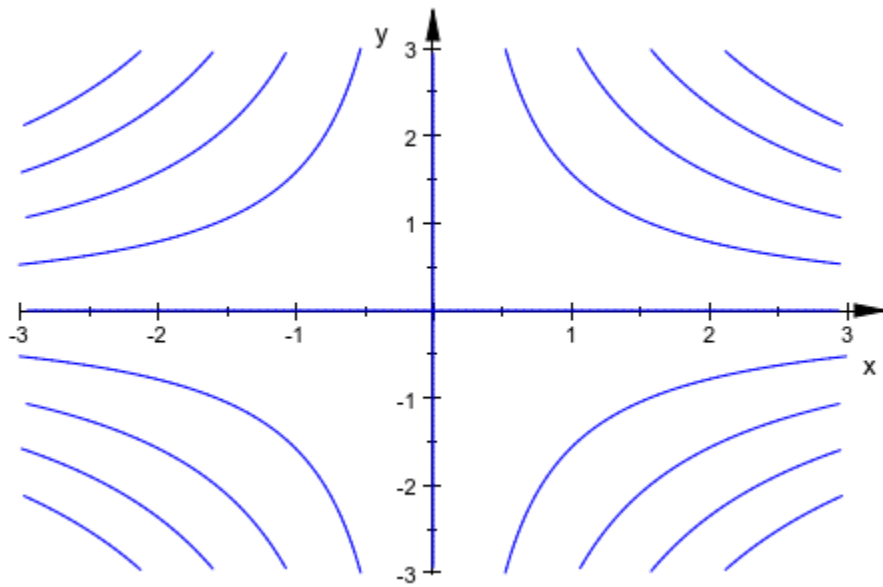

```
plot(plot::Implicit2d(sin(2*x*y), x = -3..3, y = -3..3,  
XMesh = 20, YMesh = 20))
```

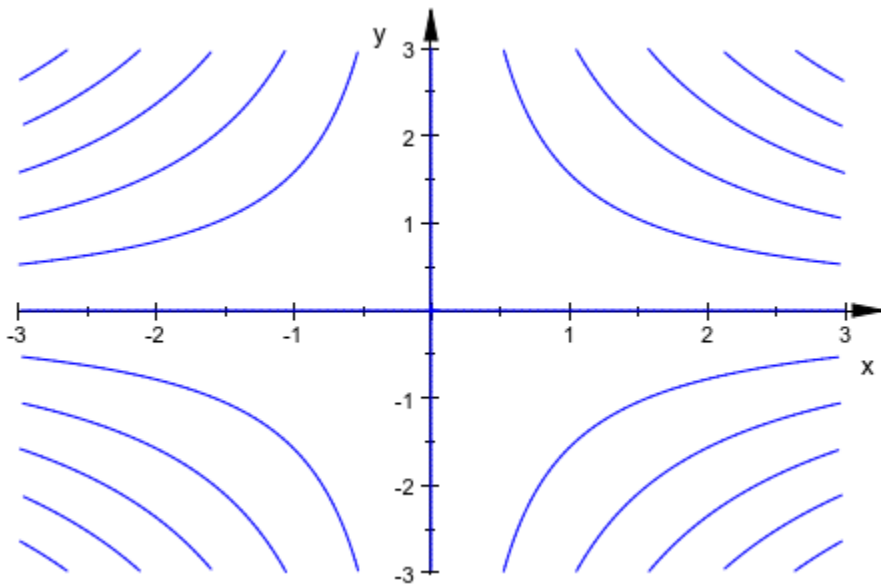

## See Also

### MuPAD Functions

[AdaptiveMesh](#) | [Mesh](#) | [Submesh](#) | [UMesh](#) | [USubmesh](#) | [VMesh](#) | [VSubmesh](#)



# CameraCoordinates

Position of light sources relative to the camera?

## Value Summary

Inherited	FALSE, or TRUE
-----------	----------------

## Graphics Primitives

Objects	CameraCoordinates Default Values
<code>plot::DistantLight</code> , <code>plot::PointLight</code> , <code>plot::SpotLight</code>	FALSE

## Description

With `CameraCoordinates = FALSE`, the coordinates defining the position of a light are interpreted as model coordinates in 3 space. Thus, the lights are positioned relative to the objects in the scene. They do not move when the camera moves.

With `CameraCoordinates = TRUE`, these coordinates are interpreted as “camera coordinates”. Thus, the lights are attached to the camera and move automatically with the camera when it is moved.

A vector  $(x, y, z)$  in “camera coordinates” has to be interpreted as follows:

The  $x$ -coordinate refers to the horizontal axis of the picture that you see in the finder of the camera. Positive  $x$  values are to your right hand side, negative  $x$  values to your left hand side.

The  $y$ -coordinate refers to the vertical axis of the picture that you see in the finder. Positive  $y$  values are above you, negative  $y$  values below you.

The  $z$ -coordinate refers to the position along the optical axis of the camera. Positive  $z$  values refer to points in front of you, negative  $z$  values to points behind you.

In camera coordinates, the camera position is (0, 0, 0).

For example, a point light positioned at the point (0, 1, 0) in camera coordinates is a “head lamp” fixed at a distance of 1 above the camera.

A 3D plot may contain several cameras. Changing the state of `CameraCoordinates` for a light affects its relation to *all* cameras of a scene. With `CameraCoordinates = TRUE`, the position of the light in 3 space changes, when a new camera is chosen interactively.

## Examples

### Example 1

We define a sphere:

```
sphere := plot::Spherical(  
  [1, u, v], u = 0..2*PI, v = 0..PI,  
  FillColorType = Functional,  
  FillColorFunction =  
    proc(u, v) begin  
      [(2 + cos(2*u))/3, (2 + sin(2*u))/3, 0]  
    end_proc):
```

We define sunlight shining from above:

```
sunlight := plot::DistantLight([0, 0, 1], [0, 0, 0]):  
plot(sphere, sunlight):
```

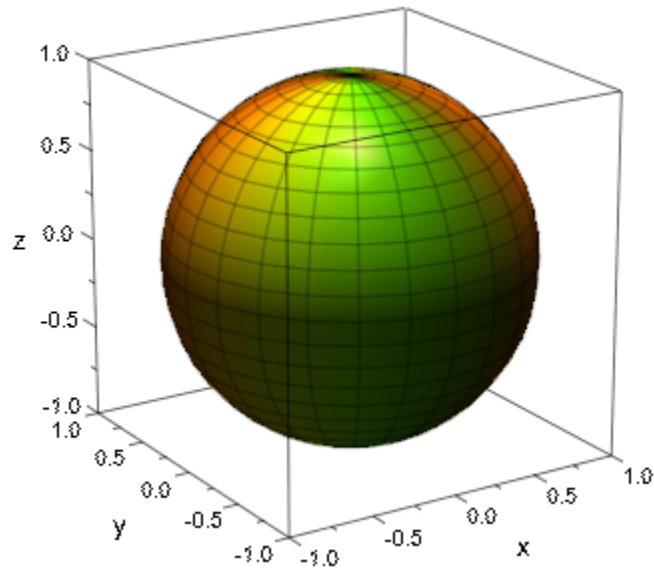

Next, the sunlight is defined relative to the camera. In camera coordinates, “above the camera” is given by the Position[0, 1, 0]. Because the camera points downwards, we set the direction of the sunlight “behind” the camera as well by choosing the direction [0, 1, -1.5] w.r.t. the camera:

```
sunlight := plot::DistantLight([0, 1, -1.5], [0, 0, 0],  
                                CameraCoordinates = TRUE):  
plot(sphere, sunlight):
```

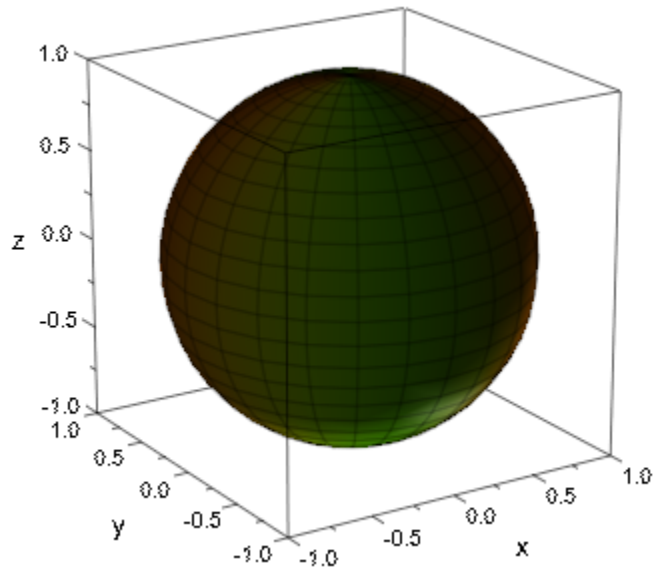

```
delete sphere, sunlight, pointlight:
```

## Example 2

We define the same sphere as in the previous example:

```
sphere := plot::Spherical(  
    [1, u, v], u = 0..2*PI, v = 0..PI,  
    FillColorType = Functional,  
    FillColorFunction =  
        proc(u, v) begin  
            [(2 + cos(2*u))/3, (2 + sin(2*u))/3, 0]  
        end_proc):
```

We define an animated camera. First, we use sunlight fixed in space:

```
camera := plot::Camera([-3*sin(a), -3*cos(a), 2],  
    [0, 0, 0], 0.3*PI, a = 0..2*PI):  
sunlight:= plot::DistantLight([0, -2, 3], [0, 0, 0]):  
plot(sphere, camera, sunlight):
```

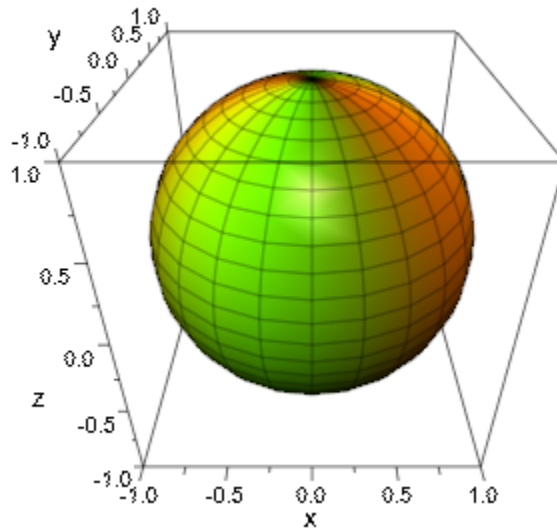

Next, we use sunlight moving with the camera:

```
sunlight:= plot::DistantLight([0, 3, -2], [0, 0, 0],  
                             CameraCoordinates = TRUE):  
plot(sphere, camera, sunlight):
```

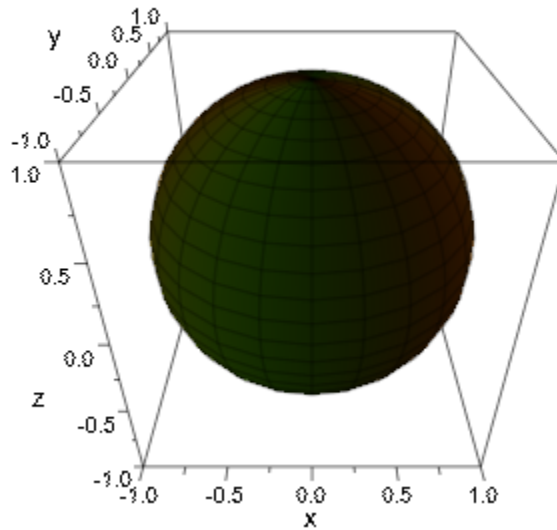

We define a point light that is fixed to some point above the camera:

```
pointlight := plot::PointLight([0, 1, 0],  
                                CameraCoordinates = TRUE):  
plot(sphere, camera, pointlight):
```

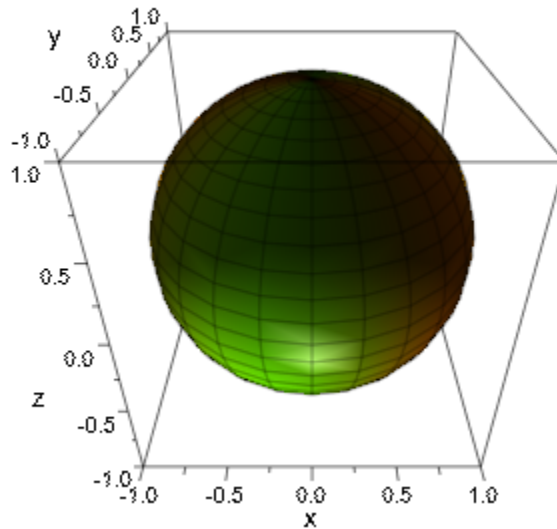

```
delete sphere, camera, sunlight, pointlight:
```

### Example 3

We define the same sphere as in the previous examples:

```
sphere := plot::Spherical(
  [1, u, v], u = 0..2*PI, v = 0..PI,
  FillColorType = Functional,
  FillColorFunction =
    proc(u, v) begin
      [(2 + cos(2*u))/3, (2 + sin(2*u))/3, 0]
    end_proc):
```

We define an animated point light that is positioned below the camera initially. It moves to some point above the camera during the animation:

```
pointlight := plot::PointLight([0, 10*a, 0], a = -1..1,
                               CameraCoordinates = TRUE):
plot(sphere, pointlight):
```

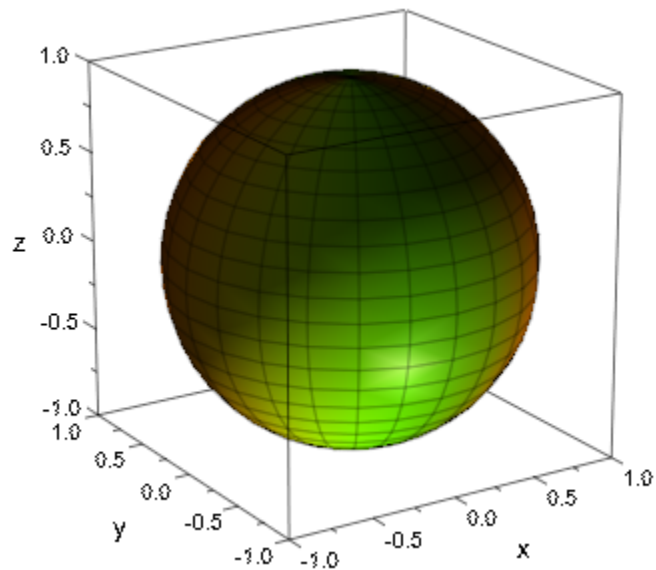

We define an animated point light that is positioned to the left of the camera initially. It moves to the right of the camera:

```
pointlight := plot::PointLight([10*a, 0, 0], a = -1 .. 1,  
                               CameraCoordinates = TRUE):  
plot(sphere, pointlight):
```



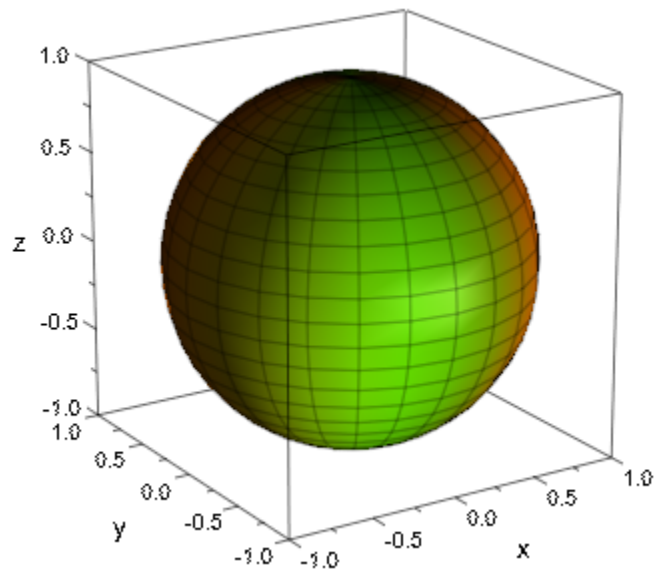

`delete sphere, pointlight:`

## See Also

### MuPAD Functions

`LightColor` | `LightIntensity` | `Position` | `SpotAngle` | `Target`

## CameraDirection CameraDirectionX CameraDirectionY CameraDirectionZ

Direction of the automatic camera

### Value Summary

CameraDirection	Library wrapper for “[CameraDirectionX, CameraDirectionY, CameraDirectionZ]” (3D)	See below
CameraDirectionX, CameraDirectionY, CameraDirectionZ		See below

### Graphics Primitives

Objects	Default Values
plot::Scene3d	

### Description

CameraDirection controls the direction where the automatically set camera is positioned.

CameraDirectionX etc. refer to the single coordinates of this direction.

When creating a 3D scene, an “automatic camera” is used. It is placed somewhere along the ray starting at the center of the scene (or the center of an explicitly requested ViewingBox, respectively) with the direction given by CameraDirection.

The distance to the scene is chosen automatically such that the graphical scene or ViewingBox fills the drawing area optimally.

The `CameraDirection` value is a list or vector of numbers.

---

**Note** This vector represents a direction, where the camera is found when starting at the center of the scene or viewing box. It is not the position of the camera!

---

The length of the `CameraDirection` does not matter, only its direction. The length should not be zero, though.

`CameraDirection = [0, 0, 1]` (looking straight down onto the  $x$ - $y$  plane along the  $z$ -axis) does not yield a well defined camera view. This direction is automatically replaced by a direction that is close to, but not exactly equal to the  $z$  direction and orients the scene similar to a 2D plot.

The `CameraDirection` attributes cannot be animated.

The automatic camera is designed to produce a picture of the entire scene or viewing box, filling the drawing area optimally. `CameraDirection` is the only means to control it.

If only parts of a scene shall be visible, or if the camera is not to aim at the center of the scene, or if large perspective distortions are desired, or if the camera position is to be animated, one has to define one's own camera of type `plot::Camera`. It can be placed at an arbitrary `Position` with an arbitrary `FocalPoint` and can have an arbitrary `ViewingAngle`. Further, it can be animated (allowing to realize a flight through a 3D scene).

When such a camera object is inserted in a graphical scene, the automatic camera is switched off and the user defined camera takes over, automatically. It uses its own perspective parameters and ignores the attribute `CameraDirection`.

## Examples

### Example 1

We look at a function with the default direction of the automatic camera:

```
f := plot::Function3d(x^2 + y^3, x = 0..1, y = -1 ..1):  
plot(f):
```

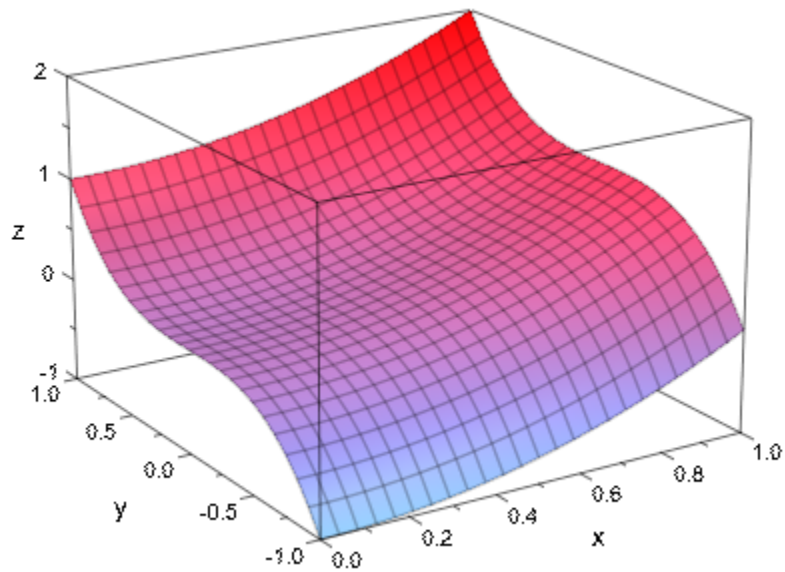

We look from different directions:

```
S1 := plot::Scene3d(f, CameraDirection = [-3,-4, 5]):  
S2 := plot::Scene3d(f, CameraDirection = [ 3,-4, 5]):  
S3 := plot::Scene3d(f, CameraDirection = [ 3, 4, 5]):  
S4 := plot::Scene3d(f, CameraDirection = [-3, 4, 5]):  
plot(S1, S2, S3, S4)
```

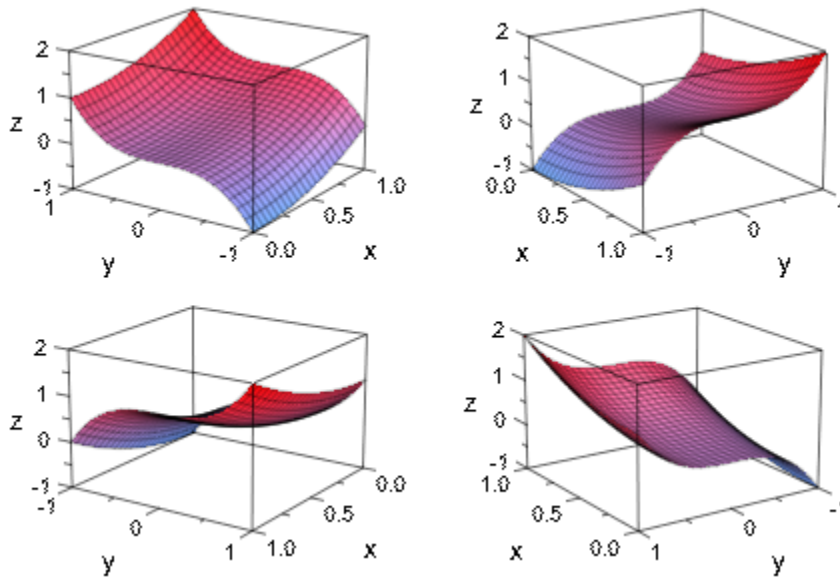

We look straight down onto the  $x$ - $y$  plane along the  $z$ -axis:

```
plot(f, CameraDirection = [0, 0, 1])
```

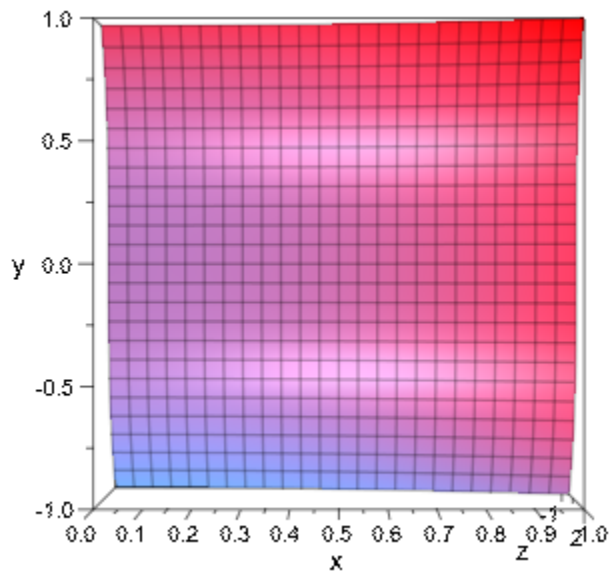

delete f, S1, S2, S3:

## See Also

### MuPAD Functions

FocalPoint | OrthogonalProjection | Position | ViewingAngle

# FocalPointFocalPointXFocalPointYFocalPointZ

Focal point of a camera

## Value Summary

FocalPoint	Library wrapper for “[FocalPointX, FocalPointY, FocalPointZ]” (3D)	List of 2 or 3 expressions, depending on the dimension
FocalPointX, FocalPointY, FocalPointZ	Optional	MuPAD expression

## Graphics Primitives

Objects	Default Values
plot::Camera	

## Description

The attribute `FocalPoint` refers to the point a camera on page 24-1158 taking pictures of a 3D scene is aimed at. Its value is a list or vector of coordinates (numerical values or symbolic expressions of an animation parameter).

`FocalPointX` etc. refer to the single coordinates `x` etc.

The optical axis of the camera is given by the vector from the camera `Position` to its `FocalPoint`.

When creating a camera by

```
camera := plot::Camera(camera_position, focal_point, opening_angle),
```

the focal point is the second argument. Internally, this point is stored as the attribute `FocalPoint` and can be accessed and changed as `camera::FocalPoint`.

The focal point attributes can be animated.

Of course, the focal point should be set such that the camera points into the direction of the objects that are to be rendered. Typically, for a camera positioned on page 24-1368 outside the graphical scene, a good focal point is the center of the scene.

## Examples

### Example 1

We define a scene consisting of 4 geometric objects:

```
b := plot::Box(4..5, -1..1, -1..1, Filled = FALSE,  
              LineColor = RGB::Red):  
c1 := plot::Cone(1, [0, 4, 0], [0, 4, 1], Color = RGB::Green):  
s := plot::Sphere(1, [-4, 0, 0], Color = RGB::Blue):  
c2 := plot::Cone(1, [0, -4, 1], [0, -4, 0],  
               Color = RGB::Orange):
```

We use a small black object to mark the point (0, 0, 0.5), where we wish to place an animated camera:

```
cameraposition := plot::Group3d(  
  plot::Box(-0.1..0.1, -0.3..0.3, 0.3..0.7,  
            Color = RGB::Black),  
  plot::Cone(0.1, [0, 0, 0.5], 0.3, [0.5, 0, 0.5],  
            Color = RGB::DarkGrey)):  
plot(b, c1, s, c2, cameraposition)
```



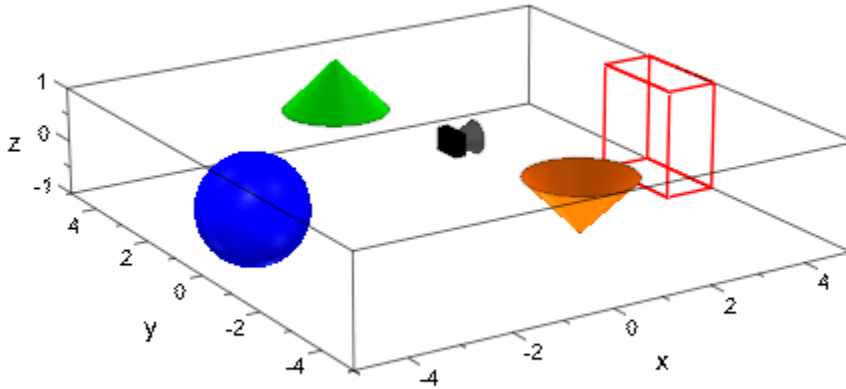

When defining the camera, the second argument is the FocalPoint. In this case, it is animated: The camera is to turn around the z-axis.

```
camera := plot::Camera([0, 0, 0.5], [4*cos(a), 4*sin(a), 0],
                       PI/4, a = 0..2*PI):
camera::FocalPoint
```

```
[4 cos(a), 4 sin(a), 0]
```

We insert the animated camera:

```
plot(b, c1, s, c2, camera)
```

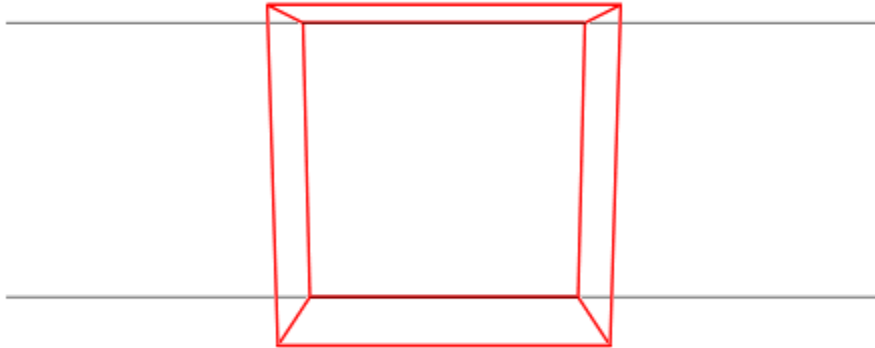

```
delete b, c1, s, c2, cameraposition, camera:
```

## Example 2

We define a function and a camera with an animated focal point:

```
f := plot::Function3d(sin(x^2-y^2), x = -2..2, y = -2..2,  
                      Submesh = [2, 2]):  
camera := plot::Camera([3, 3, 3], [sin(a), cos(a), 0],  
                      PI/6, a = 0..2*PI):  
plot(f, camera)
```

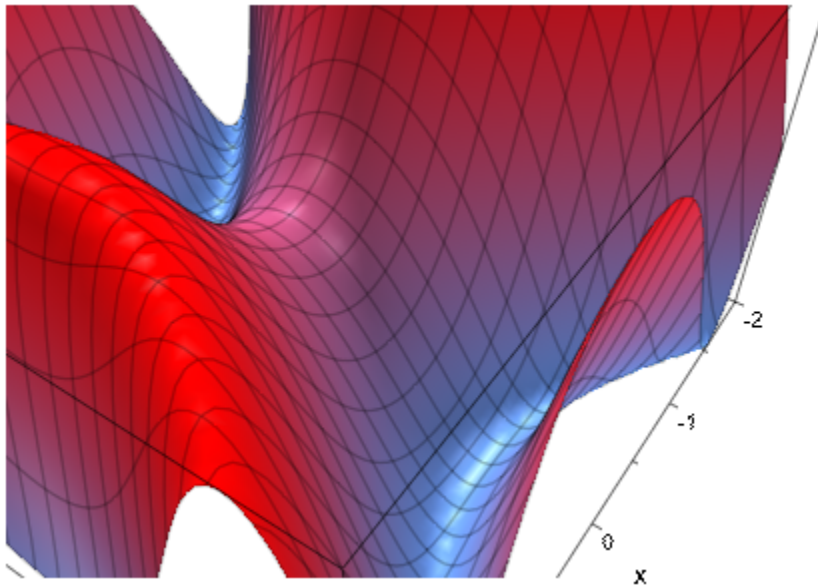

delete f, camera:

## See Also

### MuPAD Functions

CameraDirection | OrthogonalProjection | Position | ViewingAngle

# LightColor

Color of light

## Value Summary

Inherited	Color
-----------	-------

## Description

`LightColor` sets the color of user-defined light sources such as `plot::AmbientLight`, `plot::DistantLight` etc.

The value of `LightColor` must be an RGB or RGBa color, i.e., a list of three or four numerical values between 0 and 1. (The fourth value is the opacity entry of an RGBa color. It is accepted but does not have any effect on the light color.)

The RGB library provides many predefined colors such as `RGB::Blue` etc. See Section (Symbolic Math Toolbox) of this document for more information on colors.

`LightColor` cannot be animated.

## Examples

### Example 1

We define a white box and illuminate it by a yellow distant light:

```
b := plot::Box(-1..1, -1..1, -1..1, Color = RGB::White):  
light := plot::DistantLight([-1, -2, 3], [0, 0, 0],  
                             Color = RGB::Yellow):  
plot(b, light, Axes = None)
```

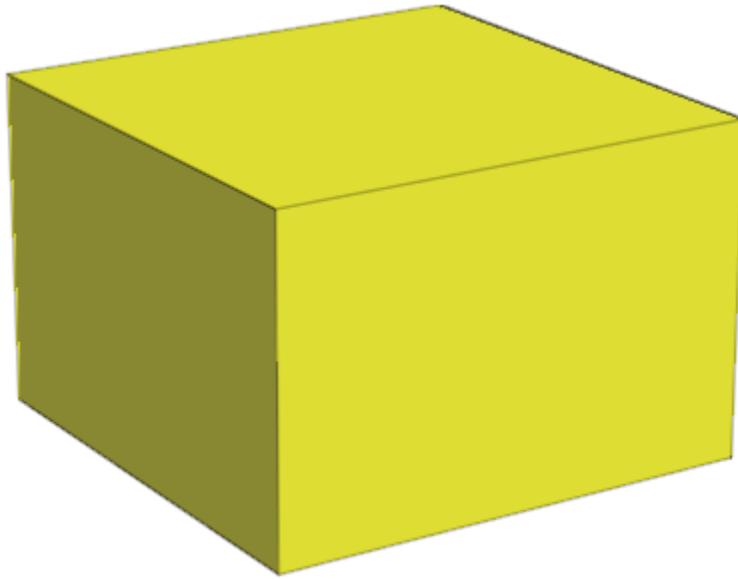

We change the color of the light source:

```
light::LightColor := RGB::Blue:  
plot(b, light, Axes = None)
```

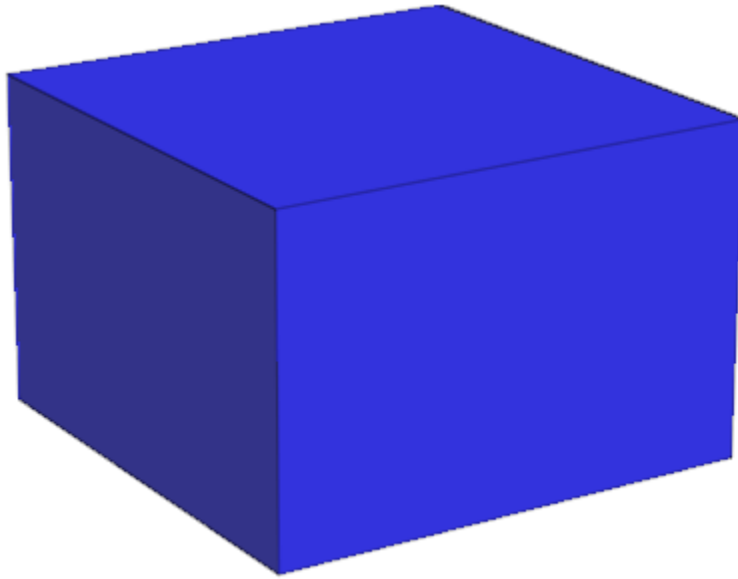

`delete b, light:`

## See Also

### **MuPAD Functions**

`CameraCoordinates` | `LightIntensity` | `Position` | `SpotAngle` | `Target`

# Lighting

Light schemes for 3D graphics

## Value Summary

Inherited	Automatic, Explicit, or None
-----------	------------------------------

## Graphics Primitives

Objects	Lighting Default Values
<code>plot::Scene3d</code>	Automatic

## Description

Lighting determines the light scheme used to illuminate a 3D scene.

With the default `Lighting = Automatic`, several light sources are set automatically to illuminate a 3D scene. Firstly, there is ambient white light of type `plot::AmbientLight`:

- Light 0: `LightIntensity = 0.25`, `LightColor = RGB::White`

In addition, there are 6 directed lights of type `plot::DistantLight` with `LightColor = RGB::White`. Their directions is given as follows: Think of the graphical scene as being scaled to a standard box extending from -1 to 1 in each coordinate direction. In these scaled coordinates, the directed lights shine into the directions given by the following Target attributes:

- Light 1: `Target = [-5, -6, -8]`, `LightIntensity = 0.50`,
- Light 2: `Target = [ 5, 6, 8]`, `LightIntensity = 0.60`,
- Light 3: `Target = [ 5, -6, -8]`, `LightIntensity = 0.20`,
- Light 4: `Target = [-5, 6, 8]`, `LightIntensity = 0.25`,
- Light 5: `Target = [-5, 6, -8]`, `LightIntensity = 0.20`,

- Light 6: Target = [ 5, -6, 8], LightIntensity = 0.25.

User-defined lights in the scene are ignored with `Lighting = Automatic`.

With `Lighting = Explicit`, the light sources set via `Lighting = Automatic` are switched off and user-defined light sources are switched on.

A `plot` command searches for light objects set by the user. If `Lighting` is not specified and any kind of user-defined light object is found in the scene, `Lighting = Explicit` is set automatically.

Switching between `Lighting = Automatic` and `Lighting = Explicit` in the inspector (Symbolic Math Toolbox), one can easily compare the effect of the automatic lights with the effect of ones own lights.

With `Lighting = None`, the 3D shading algorithm based on reflections of light emitted from light sources in the graphical scene is switched off. This does not mean that the graphical scene turns black: all objects are painted in the color they are defined with. However, the scene will appear flat, because the depth of a 3D scene is created via the shading caused by different reflections of light at different points of the scene.

The maximal number of lights that can be used to illuminate a 3D scene depends on the OpenGL driver installed on the computer.

---

**Note** Some OpenGL drivers do not allow more than 6 light sources. If there are more light sources in the scene, the surplus lights are ignored. Lights that are switched off via `Visible = FALSE` are not counted.

---

After activating a 3D plot (by clicking it), the “Help” menu contains an item “OpenGL Info” that provides information about the maximal number of lights.

## Examples

### Example 1

In our first scene, no lights are specified. The default setting `Lighting = Automatic` is used:



```
f := plot::Function3d(sin(x^2 + y^2), x = -2..2, y = -2..2):  
plot(f):
```

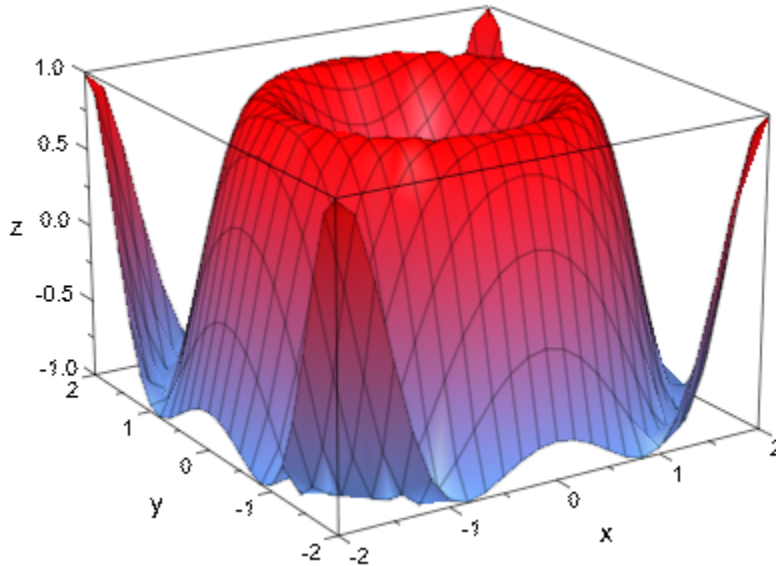

When specifying `Lighting = Explicit`, the lights set by the user are used. Since the scene does not contain any lights, the scene turns dark:

```
plot(f, Lighting = Explicit):
```

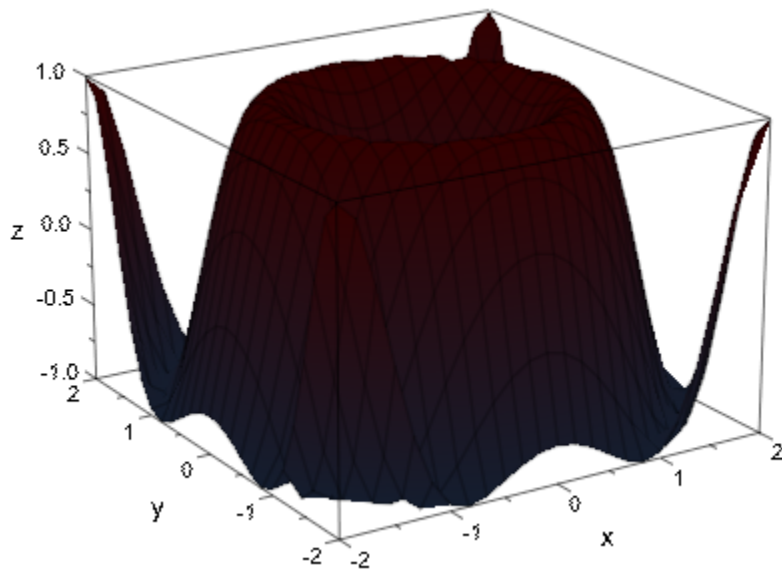

Lights are specified in the next scene. The setting `Lighting = Explicit` is used automatically:

```
Light0 := plot::AmbientLight(0.25):  
Light1 := plot::DistantLight([ 1,  0,  1], [0, 0, 0], 0.3):  
Light2 := plot::DistantLight([-1,  0,  1], [0, 0, 0], 0.3):  
Light3 := plot::DistantLight([ 0,  1,  1], [0, 0, 0], 0.3):  
Light4 := plot::DistantLight([ 0, -1,  1], [0, 0, 0], 0.3):  
plot(f, Light0, Light1, Light2, Light3, Light4):
```

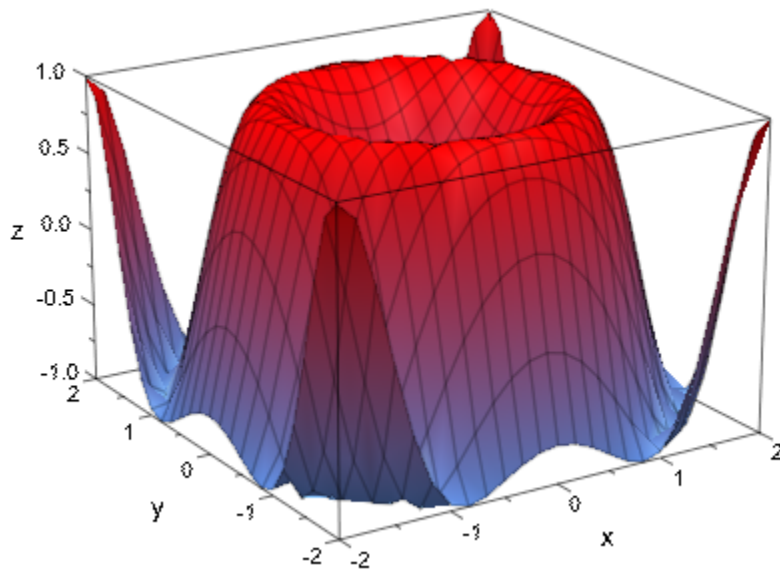

We switch off the parameter lines:

```
plot(f, Light0, Light1, Light2, Light3, Light4,  
      XLinesVisible = FALSE, YLinesVisible = FALSE,  
      Axes = None):
```



In the next scene, the 3D shading model is switched off via `Lighting = None`:

```
plot(f, Lighting = None):
```

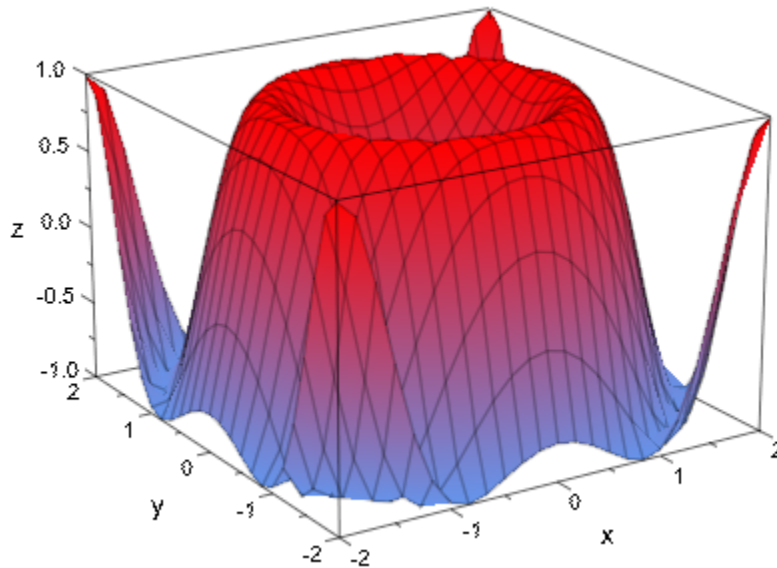

In the previous picture, the axes box and the mesh lines are switched on and create a certain 3D effect. After switching the box and the mesh lines off, the scene appears flat when rendered without shading:

```
plot(f, Lighting = None, Axes = None,  
      XLinesVisible = FALSE, YLinesVisible = FALSE):
```



```
delete f, Light0, Light1, Light2, Light3, Light4:
```

## See Also

### MuPAD Functions

`LightColor` | `LightIntensity` | `SpotAngle`

### MuPAD Graphical Primitives

`plot::AmbientLight` | `plot::DistantLight` | `plot::PointLight` |  
`plot::SpotLight`

# LightIntensity

Intensity of light

## Value Summary

Optional	Arithmetical expression between 0 and 1
----------	---

## Description

`LightIntensity` governs the intensity of user defined light sources such as `plot::AmbientLight`, `plot::DistantLight` etc.

The intensity of all user defined light source can be set by `Intensity = intensity`. The value `intensity` must be a number between 0 and 1. Values smaller than 0 or larger than 1 are accepted and handled like 0 or 1, respectively.

This attribute can be animated.

Undirected ambient light on page 24-1152 of intensity 1 dominates all other light sources.

## Examples

### Example 1

When generating a light source of type `plot::DistantLight`, the third argument is the light intensity. Internally, this value is stored as the attribute `LightIntensity` and can be accessed and changed as the corresponding slot of the light object:

```
light := plot::DistantLight([2, -1, 3], [0, 0, 0], 0.5):  
light::LightIntensity
```

0.5

```
light::LightIntensity:= 0.4:  
light::LightIntensity
```

0.4

We illuminate a function plot by two distant lights with animated intensities:

```
plot(plot::Function3d(exp(-x^2 - y^2), x = -2..2, y = -2..2),  
      plot::DistantLight([5, -1, 3], [0, 0, 0], 1 - a, a = 0..1),  
      plot::DistantLight([-3, 5, 2], [0, 0, 0], a, a = 0..1)):
```

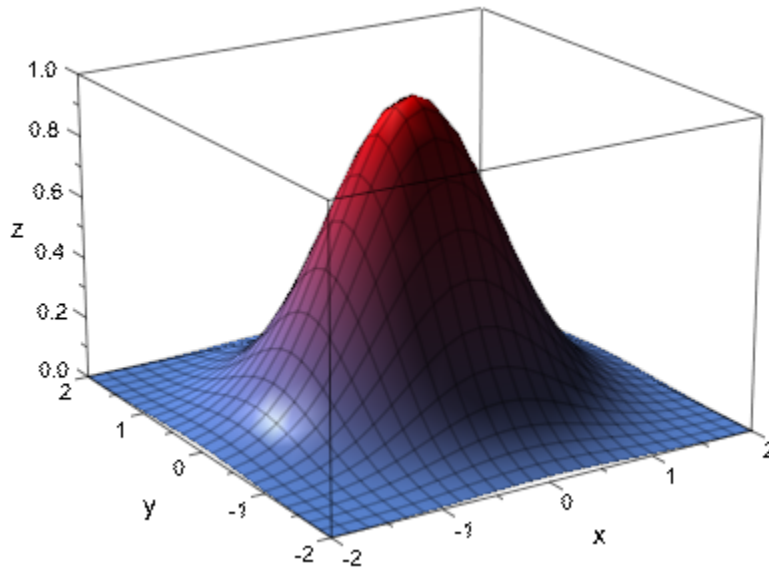

```
delete light:
```

## See Also

### MuPAD Functions

CameraCoordinates | LightColor | Position | SpotAngle | Target



# OrthogonalProjection

Parallel projection without perspective distortion

## Value Summary

Inherited	FALSE, or TRUE
-----------	----------------

## Graphics Primitives

Objects	OrthogonalProjection Default Values
plot::Camera	FALSE

## Description

Setting `OrthogonalProjection = TRUE`, a camera uses parallel projection without perspective distortion.

By default, a camera uses `OrthogonalProjection = FALSE`. Depending on the distance of the camera to the graphical scene (set by the attribute `Position`), the scene is subject to some natural perspective distortion. The distortion is large when the camera is near the scene. It is small when the camera is far away.

In principle, using parallel projection is equivalent to placing a camera at a very large distance from the scene, looking through a very powerful tele lens.

For technical reasons, however, you should *not* suppress perspective distortion by placing the camera yourself somewhere far away via the attribute `Position` and turning the camera's lens into a tele lens by setting a small value for its opening angle (cf. `ViewingAngle`). This may lead to problems with the hidden line algorithm used by the 3D renderer. Further, a suitable opening angle has to be found experimentally such that the scene fills a reasonable portion of the drawing area.

Use `OrthogonalProjection = TRUE` instead. The scaling of the scene is done automatically to fill the drawing area optimally.

With `OrthogonalProjection = TRUE`, the view is only determined by the direction of the vector from the `FocalPoint` of the camera to its `Position`. (The camera is moved to infinity along the ray given by this “optical axis”, using an infinitesimal opening angle.)

The absolute camera position in 3-space as well as its opening angle are ignored.

## Examples

### Example 1

We look at a box with side length 2 using cameras at different positions. We double the distance between the camera and the center of the box from one scene to the next. At the same time, we use more and more powerful tele lenses by decreasing the camera's

opening angle by a factor of  $\frac{1}{2}$ , so that the box has approximately the same size.

- In S1, the camera is close to the box. The box is distorted heavily.
- In S2, the camera is farther away. The perspective distortions are smaller.
- In S3, the distance of the camera to the box center is about 5 times the diameter of the box. Only minor perspective distortions are visible.
- In S4, the distance of the camera is about 10 times the diameter of the box. The perspective distortions are almost gone:

```
b := plot::Box(-1..1, -1..1, -1..1, Filled = FALSE,  
              LineColor = RGB::Black):  
S1:= plot::Scene3d(b, plot::Camera([ 2, 1.8, 2.5], [0, 0, 0], PI/3)):  
S2:= plot::Scene3d(b, plot::Camera([ 4, 3.6, 5.0], [0, 0, 0], PI/6)):  
S3:= plot::Scene3d(b, plot::Camera([ 8, 7.2, 10.0], [0, 0, 0], PI/12)):  
S4:= plot::Scene3d(b, plot::Camera([16, 14.4, 20.0], [0, 0, 0], PI/24)):  
plot(S1, S2, S3, S4, Axes = None)
```

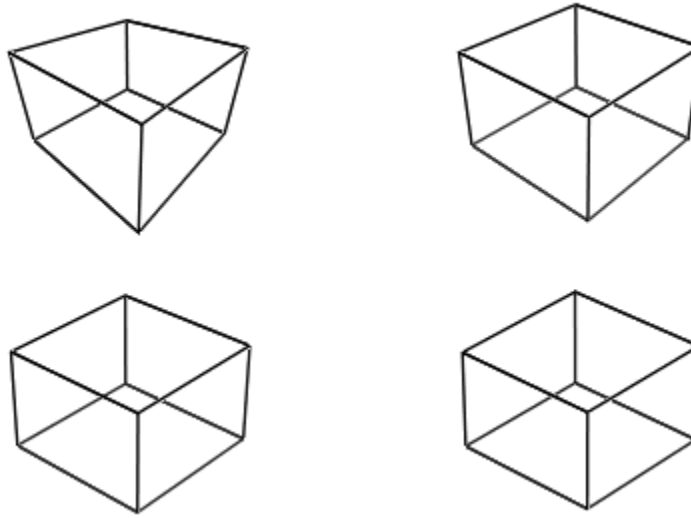

We suppress the distortions completely by setting `OrthogonalProjection = TRUE`.  
Note the automatic scaling of the scene:

```
plot(S1, S2, S3, S4, Axes = None, OrthogonalProjection = TRUE)
```

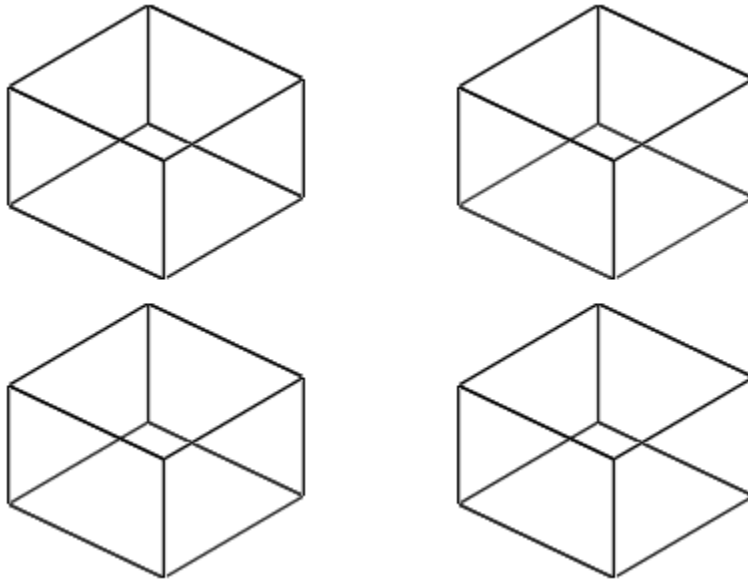

```
delete b, S1, S2, S3, S4:
```

## Example 2

The following camera is too close to the scene to make all parts of the function graph visible:

```
f := plot::Function3d(sin(x^2 - y^2), x = -2..2, y = -2..2):  
camera := plot::Camera([2, 2, 2], [0, 0, 0], PI/5):  
plot(f, camera)
```

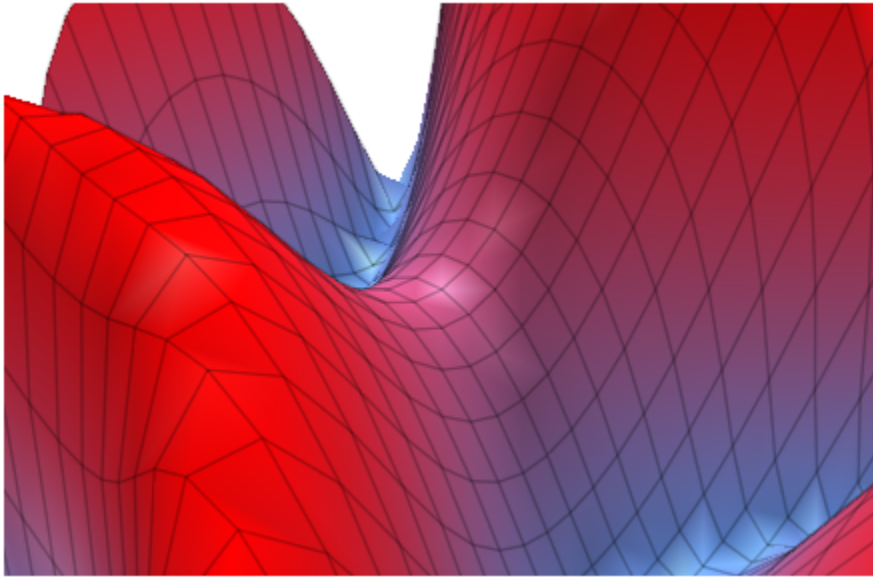

With `OrthogonalProjection = TRUE`, the specified position and opening angle are ignored. The effect of `OrthogonalProjection` is the same as placing the camera far away and choosing a tiny opening angle such that the scene fills the drawing area optimally:

```
camera::OrthogonalProjection := TRUE:  
plot(f, camera)
```

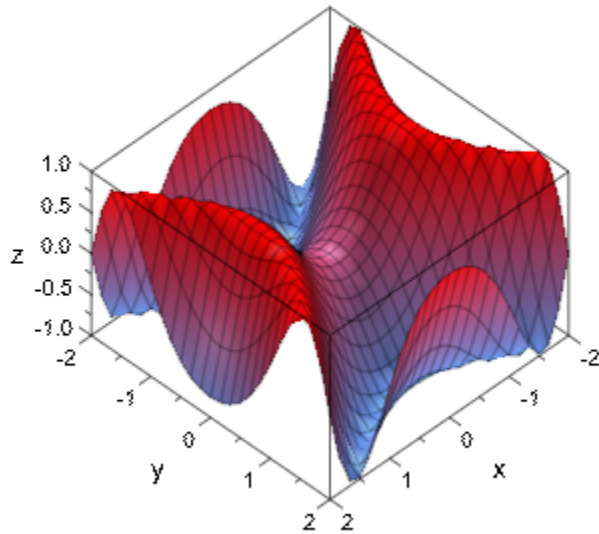

delete f, camera:

## See Also

### MuPAD Functions

CameraDirection | FocalPoint | Position | ViewingAngle

# SpotAngle

Opening angle of the light cone of a spot light

## Value Summary

Mandatory	Real-valued expression (interpreted in radians)
-----------	---

## Graphics Primitives

Objects	SpotAngle Default Values
<code>plot::SpotLight</code>	

## Description

`SpotAngle` sets the opening angle of the light cone of a spot light in radians, and defines the opening angle of the light cone emitted by spot lights of type `plot::SpotLight`.

The values for `SpotAngle` have to be given in radians. Reasonable values lie between 0 and  $\pi$ .

`SpotAngle` can be animated.

## Examples

### Example 1

When creating a spot light, the third argument is the `SpotAngle`:

```
spotlight := plot::SpotLight([0, 0, 1], [0, 0, 0], a*PI, 1,
                             a = 0..0.4, LightColor = RGB::White):
spotlight::SpotAngle
```

$\pi a$ 

We illuminate the x-y plane by the animated spot light and some ambient light. The spot light is visualized by a cone:

```
ambientlight := plot::AmbientLight(0.2):  
s := plot::Surface([x, y, 0], x = -1..1, y = -1..1,  
    Submesh = [2, 2], Color = RGB::White,  
    FillColorType = Flat):  
c := plot::Cone(0, [0, 0, 1],  
    0.6*tan(a*PI/2), [0, 0, 1 - 0.6],  
    a = 0..0.4, Color = RGB::Orange.[0.5]):  
plot(s, c, spotlight, ambientlight,  
    CameraDirection = [-9, -18, 12])
```

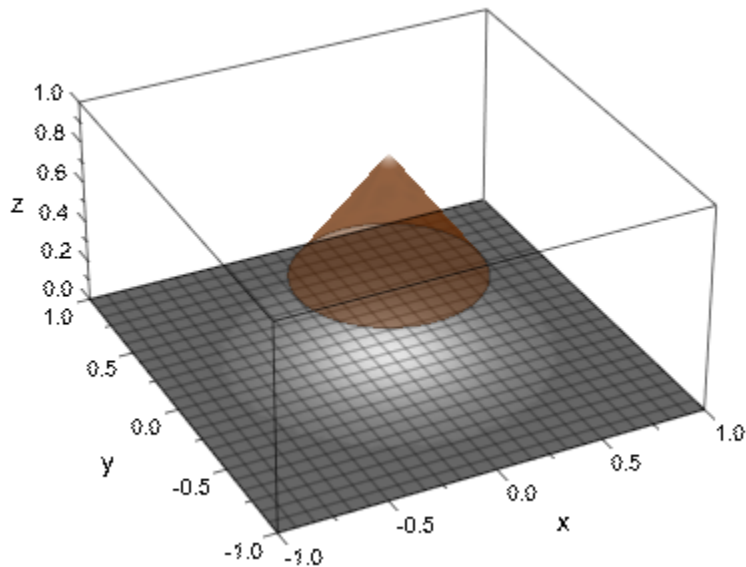

```
delete spotlight, ambientlight, s, c:
```



## See Also

### MuPAD Functions

CameraCoordinates | LightColor | LightIntensity | Position | Target

## TargetTargetXTargetYTargetZ

Target point of a light

### Value Summary

Target	Library wrapper for “[TargetX, TargetY, TargetZ]” (3D)	List of 2 or 3 expressions, depending on the dimension
TargetX, TargetY, TargetZ	Mandatory	MuPAD expression

### Graphics Primitives

Objects	Default Values
plot::DistantLight, plot::SpotLight	

### Description

The `Target` attribute refers to the point a spot light on page 24-1179 is aimed at. It also controls the direction of a distant light on page 24-1167 which is given by the vector `Target - Position`.

`Target` sets the position of the point lights of type `plot::DistantLight` and `plot::SpotLight` are aimed at. `TargetX` etc. refer to the single coordinates of this point.

The value of `Target` is a list or vector of coordinates. `TargetX = x` etc. refer to the single coordinates of this list.

These attributes can be animated.

By default, the positions and the targets of light objects are given in model coordinates that have nothing to do with the camera that is used to view the scene.

When using the attribute `CameraCoordinates = TRUE`, the light source is fixed to the camera. It moves automatically, when the camera is moved.

## Examples

### Example 1

When generating lights of type `plot::DistantLight` and `plot::SpotLight`, the second argument is the `Target`. In the following example, it is animated:

```
sunlight := plot::DistantLight([0, 0, 2],
                               [cos(a), sin(a), 1],
                               a = 0..2*PI):
spotlight := plot::SpotLight([0, 0, 1],
                              [cos(a), sin(a), 1/2],
                              PI/5, a = 0..2*PI):
sunlight::Target, spotlight::Target
```

$$[\cos(a), \sin(a), 1], \left[\cos(a), \sin(a), \frac{1}{2}\right]$$

We illuminate a paraboloid with sunlight. Its direction is animated by the `Target` attribute:

```
f := plot::Function3d(x^2 + y^2, x = -1..1, y = -1..1):
plot(f, sunlight, CameraDirection = [-1, -2, 6])
```

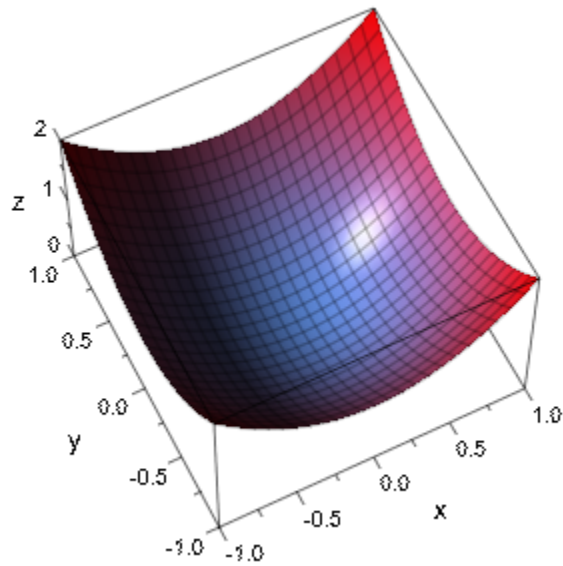

We use the animated spot light:

```
plot(f, spotlight, CameraDirection = [-1, -2, 6])
```

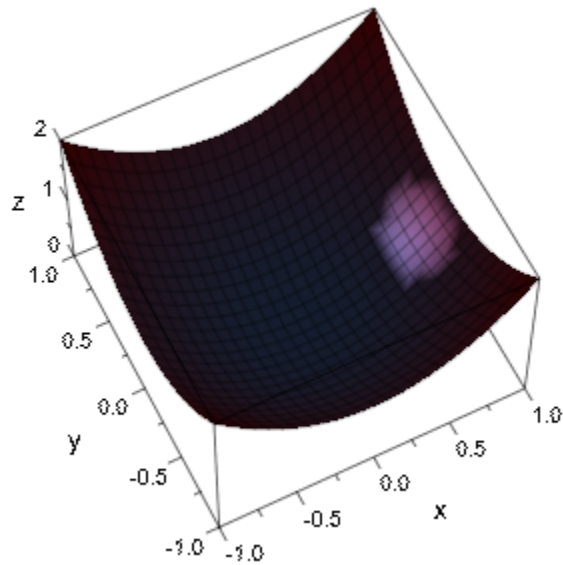

`delete sunlight, spotlight, f:`

## See Also

### MuPAD Functions

[CameraCoordinates](#) | [LightIntensity](#) | [Position](#) | [SpotAngle](#)

## UpVectorUpVectorXUpVectorYUpVectorZKeepUpVector

Up direction of a camera

### Value Summary

UpVector	Library wrapper for “[UpVectorX, UpVectorY, UpVectorZ]” (3D)	List of 2 or 3 expressions, depending on the dimension
UpVectorX, UpVectorY, UpVectorZ	Optional	MuPAD expression
KeepUpVector	Inherited	FALSE, or TRUE

### Graphics Primitives

Objects	Default Values
plot::Camera	UpVector: [0.0, 0.0, 1.0] UpVectorX, UpVectorY: 0.0 UpVectorZ: 1.0 KeepUpVector: TRUE

### Description

UpVector = [x, y, z] sets the 3D vector that corresponds to the vertical direction of the 2D picture taken by the camera.

UpVectorX etc. denote the coordinates of the UpVector.

`KeepUpVector = TRUE` keeps the `UpVector` constant when the camera is moved. With `KeepUpVector = FALSE`, the `UpVector` is kept orthogonal to the optical axis when the camera is moved.

The picture taken by a camera is defined by the attributes `Position` (the 3D position of the camera) and `FocalPoint` (the 3D point the camera is pointed at). The vector from the position to the focal point is the optical axis of the camera.

As an additional degree of freedom, the camera may be rotated around the optical axis. This rotation is defined by specifying a 3D vector `UpVector`. In the final 2D picture taken by the camera, this vector is parallel to the vertical axis, pointing upwards.

With the default value `UpVector = [0, 0, 1]` the z-axis in 3D points upwards in the 2D picture.

The `UpVector` of a camera must not be zero and must not be parallel to the optical axis.

The default values are `UpVector = [0, 0, 1]` and `KeepUpVector = TRUE`.

The restriction that the `UpVector` must not be parallel to the optical axis leads to discontinuities when the camera moves in such a way that this restriction is violated. In such a case, `KeepUpVector = FALSE` should be used. Cf. "Example 2" on page 24-1785 (Symbolic Math Toolbox).

## Examples

### Example 1

We view a cross of three arrows by a camera with the usual `UpVector` pointing into z-direction:

```
camera := plot::Camera([0.3, -4.0, 0.2], [0, 0, 0], PI/4,  
                      UpVector = [0, 0, 1]):  
plot(plot::Arrow3d([-1, 0, 0], [1, 0, 0], Color = RGB::Red),  
     plot::Arrow3d([0, -1, 0], [0, 1, 0], Color = RGB::Green),  
     plot::Arrow3d([0, 0, -1], [0, 0, 1], Color = RGB::Blue),  
     camera)
```

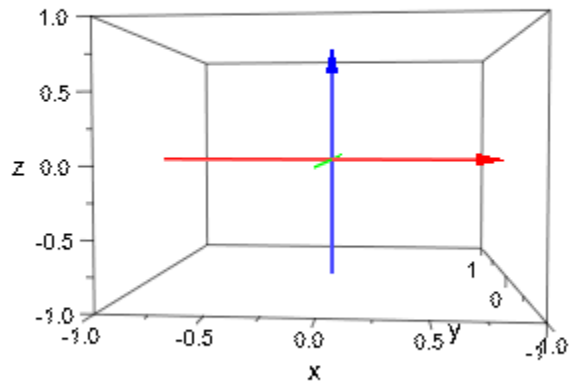

We redefine the `UpVector` of the camera to point into the direction  $[1, 0, 1]$ . Now, this 3D direction becomes the vertical direction of the 2D picture:

```
camera::UpVector := [1, 0, 1]:
plot(plot::Arrow3d([-1, 0, 0], [1, 0, 0], Color = RGB::Red),
      plot::Arrow3d([0, -1, 0], [0, 1, 0], Color = RGB::Green),
      plot::Arrow3d([0, 0, -1], [0, 0, 1], Color = RGB::Blue),
      camera)
```



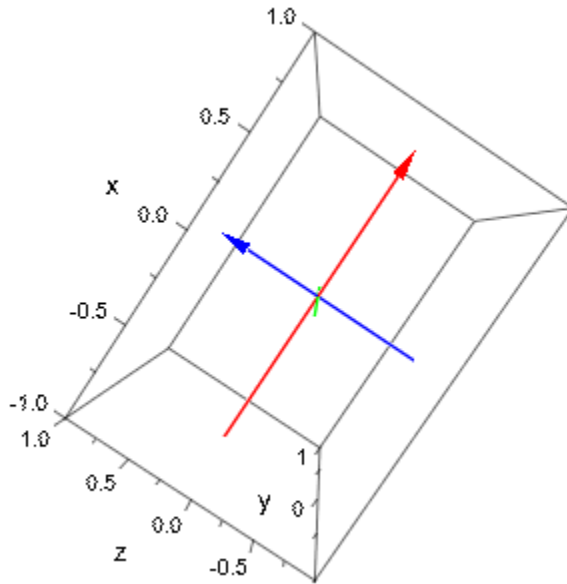

delete camera:

## Example 2

We use an animated camera to fly over the north pole of a planet using the default  $\text{UpVector} = [0, 0, 1]$ . With  $\text{KeepUpVector} = \text{TRUE}$ , we encounter a discontinuity when the camera is positioned exactly over the north pole pointing straight down. The  $\text{UpVector}$  is parallel to the optical axis at this point:

```
camera := plot::Camera([4*cos(a), 0, 4*sin(a)], [0, 0, 0], PI/4,
                      a = 0..PI, Frames = 300,
                      UpVector = [0, 0, 1],
                      KeepUpVector = TRUE):
planet := plot::Surface([cos(u)*sin(v), sin(u)*sin(v), cos(v)],
                       u = 0..2*PI, v = 0..PI,
                       FillColorFunction = proc(u, v)
                       begin
                           [cos(u)*cos(v)^2, cos(u)*cos(v)^2, cos(u)]
                       end_proc):
font := ["sans-serif", 10, RGB::Grey80]:
text1 := plot::Text3d("North", [0, 0, 1.2], TextFont = font):
```

```
text2 := plot::Text3d("South", [0, 0, -1.2], TextFont = font):
plot(camera, planet, text1, text2, Scaling = Constrained);
```

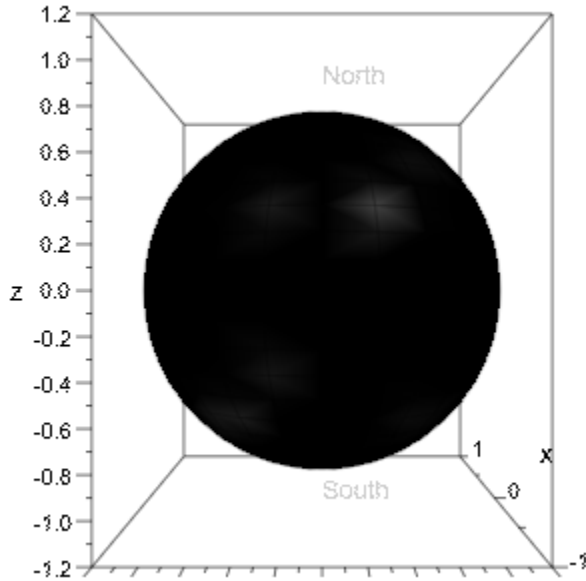

With `KeepUpVector = FALSE`, no such discontinuity is encountered. However, when reaching the equator on the dark side of the planet, the `UpVector` has turned around: the upper side of the picture now is south, the lower side is north:

```
camera::KeepUpVector := FALSE:
plot(camera, planet, text1, text2, Scaling = Constrained);
```

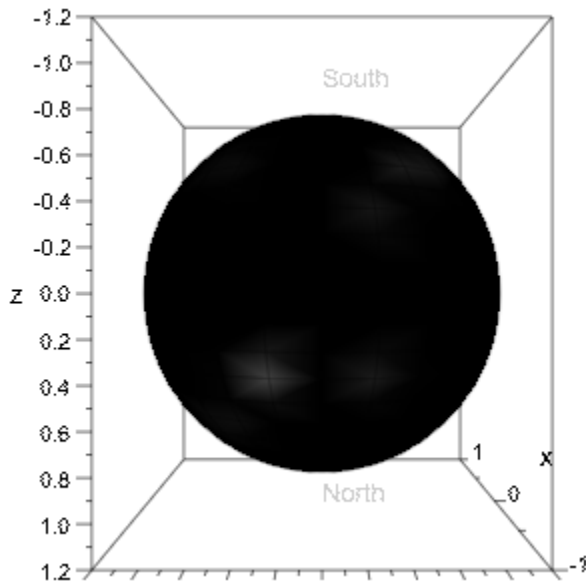

`delete camera, planet, font, text1, text2:`

## See Also

**MuPAD Functions**  
FocalPoint | Position

## ViewingAngle

Opening angle of the camera lense

### Value Summary

Mandatory	MuPAD expression
-----------	------------------

### Graphics Primitives

Objects	ViewingAngle Default Values
plot::Camera	

### Description

ViewingAngle defines the viewing angle of a camera. It is also known as the “opening angle” of the camera's lense and is determined by its focal length.

Small viewing angles correspond to a tele lense, large opening angles to a wide angle lense. Angles close to  $\pi$  correspond to an (extreme) fish eye lense.

The values for ViewingAngle have to be given in radians. The angles should be larger than  $\frac{1}{100}$  and smaller than  $\pi$ . Other values are replaced by some small positive angle or by an angle slightly less than  $\pi$ , respectively.

Note that when using a wide angle lense, the scene may fill only a part of the drawing area. With a tele lense, only parts of the scene may be visible.

When using a camera object with a given Position, you have to find out experimentally what viewing angle is suitable to make the scene fill a reasonable portion of the drawing area.

ViewingAngle does not have any effect when the attribute OrthogonalProjection = TRUE is set for the camera.

---

**Note** In fact, when a parallel projection without perspective distortion is desired, one should *not* position the camera far away from the scene and use an extreme tele lens (i.e, very small ViewingAngle values). This may lead to problems with the hidden line algorithm of the 3D renderer. Use `OrthogonalProjection = TRUE` instead.

---

ViewingAngle can be animated. Increasing or decreasing values of ViewingAngle correspond to “zooming out” or “zooming in”, respectively.

## Examples

### Example 1

When creating a camera object, the third argument is the ViewingAngle:

```
camera:= plot::Camera([5, 5, 5], [0, 0, 0], PI/4):
camera::ViewingAngle
```

$$\frac{\pi}{4}$$

We animate ViewingAngle. With the initial value of  $\frac{\pi}{3}$  the scene is fully visible (but rather small). Zooming in by decreasing the viewing angle, only parts of the scene are visible:

```
f := plot::Function3d(sin(x^3 - y^2), x = -2..2, y = -2..2,
                      Submesh = [2, 2]):
camera:= plot::Camera([5, 5, 5], [0, 0, 0],
                      (1 - a)*PI/3 + a*PI/10,
                      a = 0..1, Frames = 200):
plot(f, camera)
```

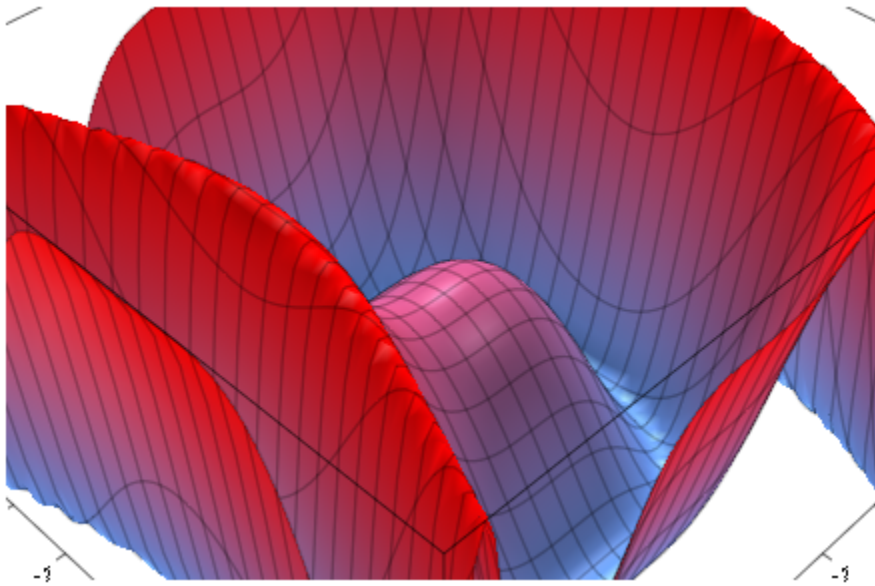

delete f, camera:

## See Also

### MuPAD Functions

CameraDirection | FocalPoint | OrthogonalProjection | Position

# AntiAliased

Antialiased lines and points

## Value Summary

Inherited	FALSE, or TRUE
-----------	----------------

## Graphics Primitives

Objects	AntiAliased Default Values
plot::Arc2d, plot::Arrow2d, plot::Circle2d, plot::Conformal, plot::Curve2d, plot::Ellipse2d, plot::Function2d, plot::Hatch, plot::Histogram2d, plot::Implicit2d, plot::Integral, plot::Line2d, plot::Listplot, plot::Ode2d, plot::Parallelogram2d, plot::Piechart2d, plot::Point2d, plot::PointList2d, plot::Polar, plot::Polygon2d, plot::QQplot, plot::Rootlocus, plot::Scatterplot, plot::Sequence, plot::SparseMatrixplot, plot::Streamlines2d, plot::Turtle, plot::VectorField2d	TRUE
plot::Bars2d, plot::Boxplot, plot::Density, plot::Inequality, plot::Iteration, plot::Lsys, plot::Raster, plot::Rectangle, plot::Sum	FALSE

## Description

`AntiAliased` controls whether lines and points are drawn antialiased or not. With `AntiAliased` enabled graphics usually look smoother.

## Examples

### Example 1

We draw a points in different sizes and point styles. The black points are drawn with `AntiAliased = FALSE`, the blue points are drawn with `AntiAliased = TRUE`:

```
pointStyles := [Squares, FilledSquares, Circles,
                FilledCircles, Crosses, XCrosses,
                Diamonds, FilledDiamonds, Stars]:
pointSizes := [1.5, 3, 4.5, 6]:
plot(Axes = None,
     (plot::Point2d(i, 2*j, AntiAliased = TRUE,
                   PointStyle = pointStyles[i],
                   PointSize = pointSizes[j],
                   Color = RGB::Blue),
      plot::Point2d(i, 2*j + 1, AntiAliased = FALSE,
                   PointStyle = pointStyles[i],
                   PointSize = pointSizes[j],
                   Color = RGB::Black))
     $ i = 1..nops(pointStyles) $ j = 1..nops(pointSizes)
)
```



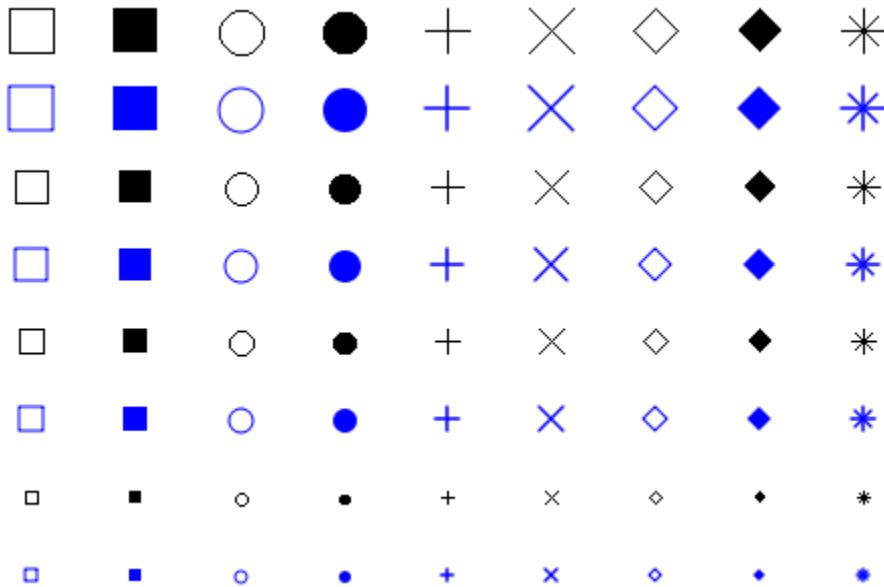

With horizontal lines we see not much difference between `AntiAliased = FALSE` (black lines) and `AntiAliased = TRUE` (blue lines):

```

lineStyles := [Solid, Dashed, Dotted]:
lineWidth := [.25, .5, .75, 1, 1.25, 1.5]:
plot(Axes = None,
     (plot::Line2d([i, 2*j], [i+.8, 2*j],
                  AntiAliased = TRUE,
                  LineStyle = lineStyles[i],
                  LineWidth = lineWidth[j],
                  Color = RGB::Blue),
     plot::Line2d([i, 2*j+1], [i+.8, 2*j+1],
                  AntiAliased = FALSE,
                  LineStyle = lineStyles[i],
                  LineWidth = lineWidth[j],
                  Color = RGB::Black))
  $ i = 1..nops(lineStyles) $ j = 1..nops(lineWidth)
)

```

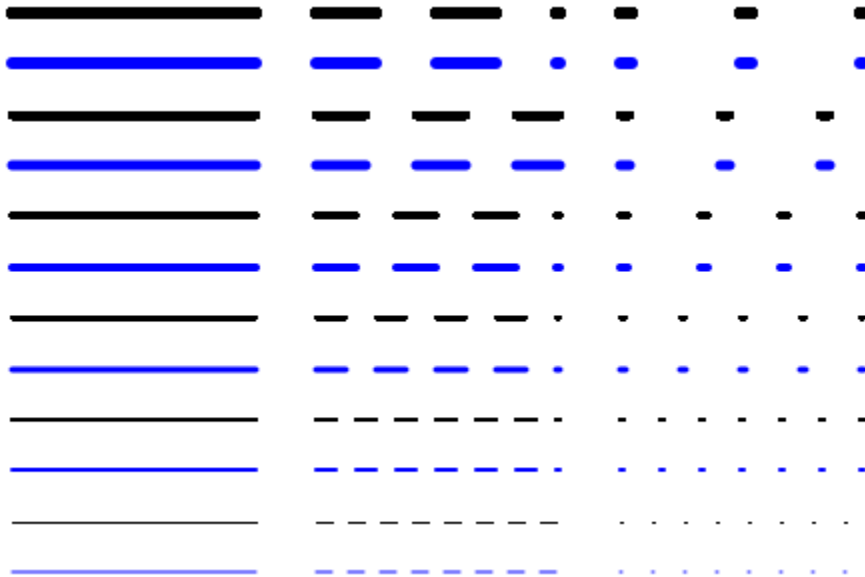

Diagonal lines are much smoother with `AntiAliased = TRUE`:

```

lineStyles := [Solid, Dashed, Dotted]:
lineWidth := [.25, .5, .75, 1, 1.25, 1.5]:
plot(Axes = None,
  (plot::Line2d([i, 2*j], [i + .8, 2*j + 1],
    AntiAliased = TRUE,
    LineStyle = lineStyles[i],
    LineWidth = lineWidth[j],
    Color = RGB::Blue),
  plot::Line2d([i, 2*j + 1], [i + .8, 2*j + 2],
    AntiAliased = FALSE,
    LineStyle = lineStyles[i],
    LineWidth = lineWidth[j],
    Color = RGB::Black))
  $ i = 1..nops(lineStyles) $ j = 1..nops(lineWidth)
)

```

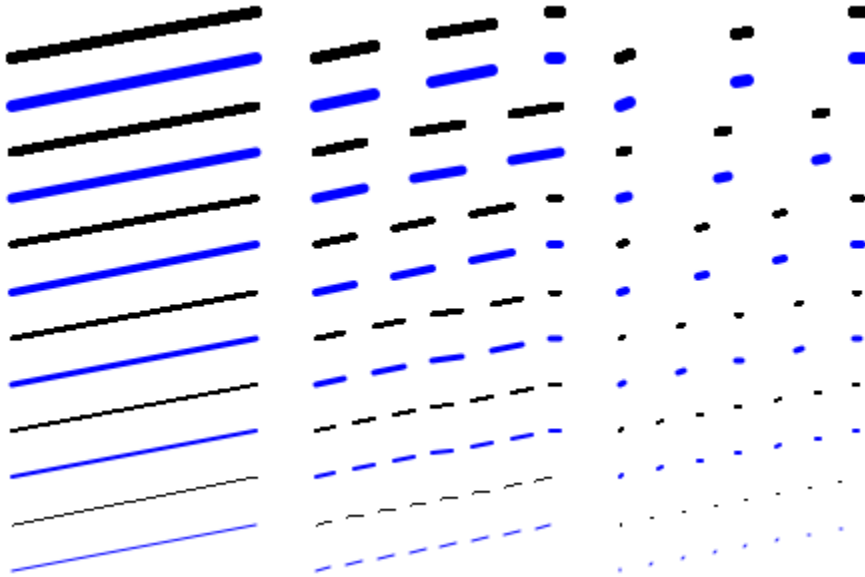

By default curves are plotted with `AntiAliased = TRUE` (blue curve) which is much nicer:

```
f := plot::Curve2d([Re, Im](zeta(I*y + 1/2)), y = 0.42,
                  AdaptiveMesh = 3):
f1 := plot::modify(f, AntiAliased = FALSE,
                  Color = RGB::Black):
plot(
  f, plot::Translate2d([5, 0], f1), XAxisTitle = "Re(z)",
  YAxisTitle = "Im(z)"
)
```

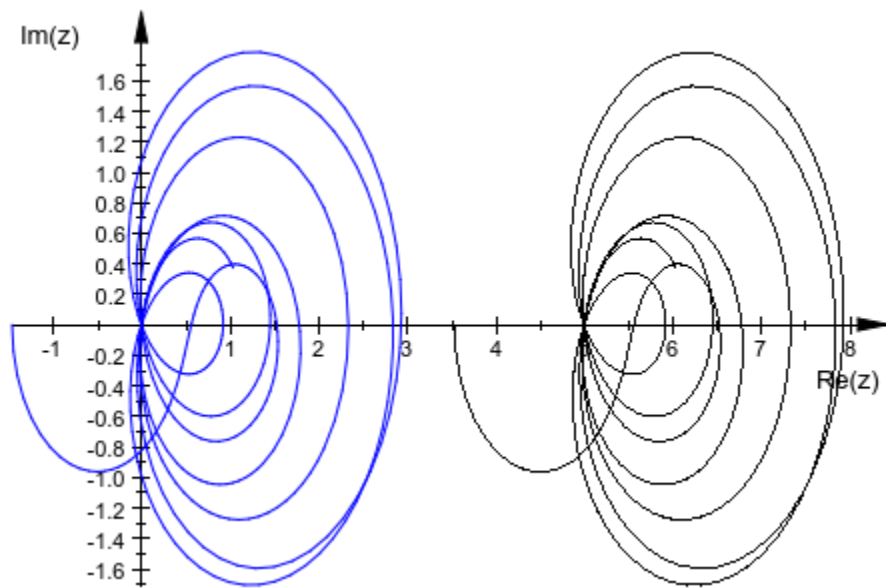

## See Also

**MuPAD Functions**  
LineStyle | PointStyle

# ArrowLength

Scaling of arrows in a vector field

## Value Summary

Inherited	Fixed, Logarithmic, or Proportional
-----------	-------------------------------------

## Graphics Primitives

Objects	ArrowLength Default Values
plot::VectorField2d, plot::VectorField3d	Proportional

## Description

ArrowLength determines how the lengths of the arrows in a vector field plot depend on the norms of the field at the evaluated points.

plot::VectorField2d plots a vector field by placing arrows at regular intervals, pointing in the directions of the field at these points. ArrowLength determines whether the lengths of those arrows are constant (ArrowLength =Fixed), proportional to the norms of the field (ArrowLength =Proportional, the default), or proportional to the logarithm of these values increased by 1 (ArrowLength =Logarithmic).

## Examples

### Example 1

The vector field defined by  $f(x, y) = (x, y)^t$  takes on different absolute values at different points. By default, plot::VectorField2d plots arrows whose lengths are proportional to the norms of the field:

```
v := plot::VectorField2d(x, y, x=-3..3, y=-3..3):  
plot(v)
```

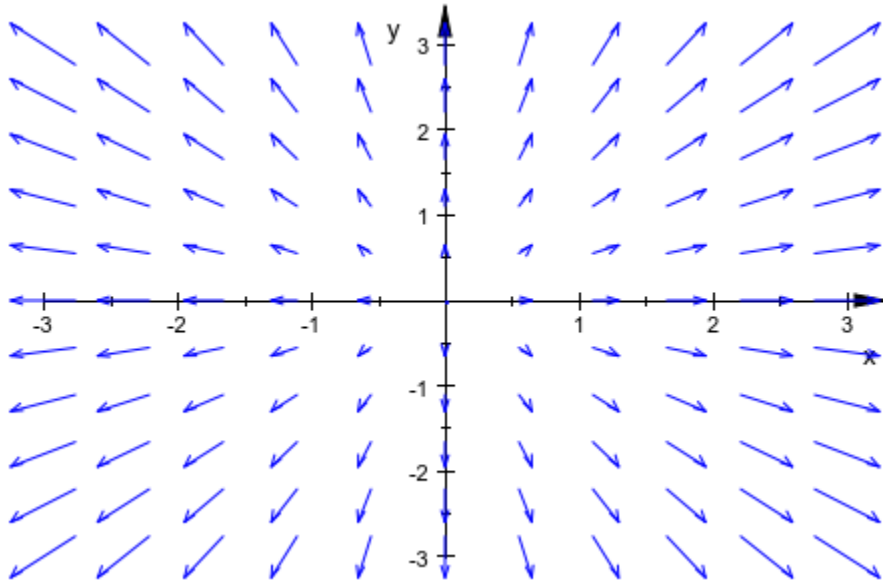

If you only want to display the direction of the field, not its “strength”, use `ArrowLength =Fixed`:

```
v::ArrowLength := Fixed:  
plot(v)
```

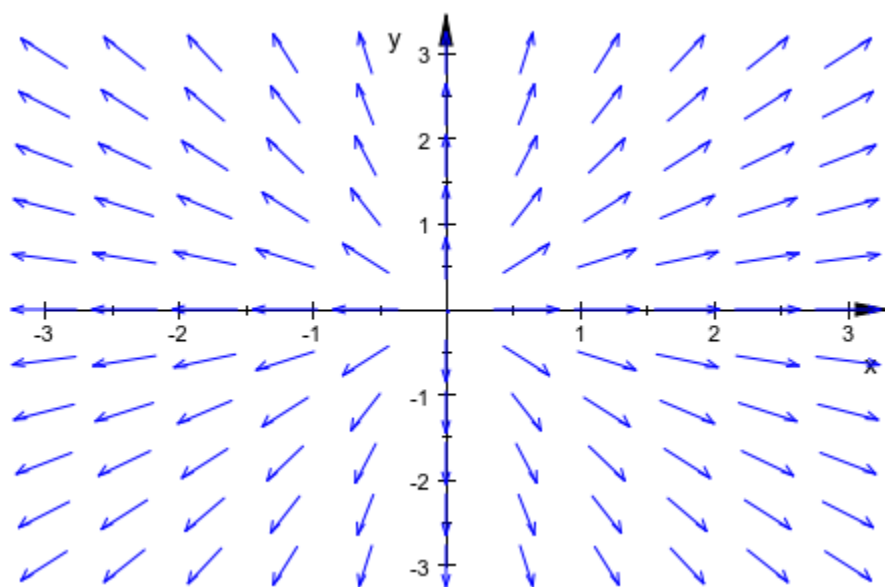

## AxesTitleFont FooterFont HeaderFont LegendFont TextFont TicksLabelFont TitleFont

Font of axes titles

### Value Summary

AxesTitleFont, FooterFont, HeaderFont, LegendFont, TextFont, TicksLabelFont, TitleFont	Inherited	Font definition
--	-----------	-----------------

### Graphics Primitives

Objects	Default Values
plot::CoordinateSystem2d, plot::CoordinateSystem3d	AxesTitleFont: [" sans-serif ", 10] TicksLabelFont: [" sans-serif ", 8]
plot::Canvas	FooterFont, HeaderFont: [" sans-serif ", 12]
plot::Scene2d, plot::Scene3d	FooterFont, HeaderFont: [" sans-serif ", 12] LegendFont: [" sans-serif ", 8]
plot::Integral, plot::Piechart2d, plot::Piechart3d, plot::Text2d, plot::Text3d	TextFont, TitleFont: [" sans-serif ", 11]

### Description

AxesTitleFont etc. determine the fonts to be used for axes titles etc.



A font is specified as follows:

```
XXXFont = [< family >, < size >, <<Bold>>, <<Italic>>, < color >>, < alignment >]
```

The meaning of the parameters is as follows.

family	Font family name: a string.  The available font families depend on the fonts that are installed on your machine. For example, typical font families available on Windows systems are "Times New Roman" (of type "serif"), "Arial" (of type "sans-serif"), or "Courier New" (of type "monospace").  To find out which fonts are available on your machine, open the menu "Format", submenu "Font" in your MuPAD notebook. The first column in the font dialog provides the names of the font families that you may specify. You may also specify one the three generic family names "serif", "sans-serif", or "monospace", and the system will automatically choose one of the available font families of the specified type for you.
size	Size of the font in integral points: a positive integer.
Bold	If specified, the font is bold.
Italic	If specified, the font is italic.
color	RGB color value: a list of 3 numerical values between 0 and 1
alignmen t	Text alignment in case of new-lines: one of the flags Left, Center, or Right.

All font parameters are optional; some default values are chosen for entries that are not specified. For example, if you do not care about the footer font family for your plot, but you insist on a specific font size, you may specify an 18 pt font for the canvas footer by `FooterFont = [18]`.

## Examples

### Example 1

We specify the font for the canvas header on page 24-1589:

```
plot(plot::Function2d(sin(x), x = 0 .. 2*PI),  
      Header = "The sine function",  
      HeaderFont = ["monospace", 14, Bold])
```

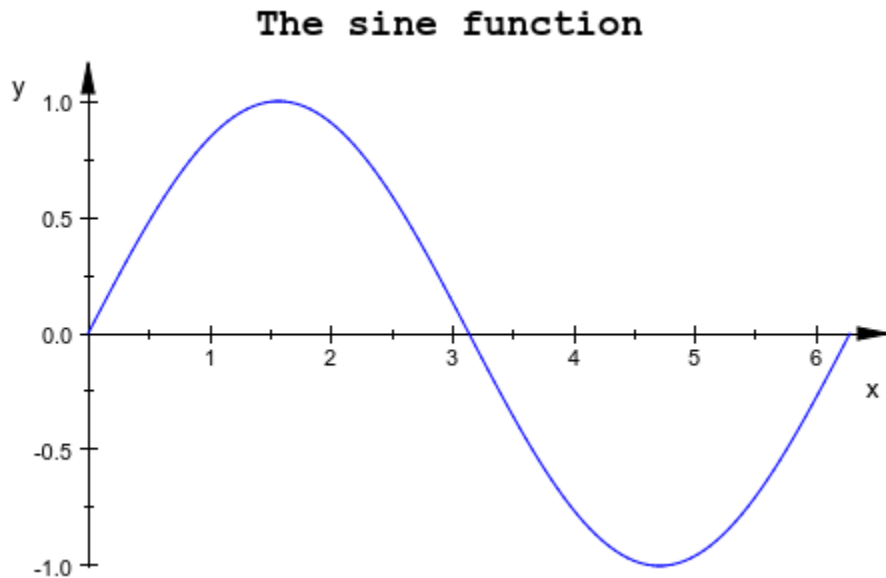

We specify a font size of 18 pt for the canvas footer on page 24-1589:

```
plot(plot::Function2d(sin(x), x = 0 .. 2*PI),  
      Footer = "The sine function", FooterFont = [18])
```

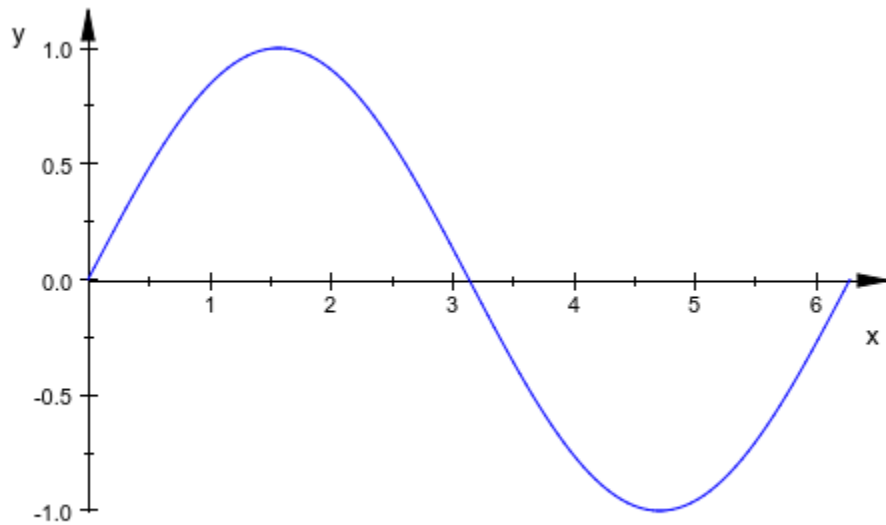

The sine function

## Example 2

Display Greek characters for the tick labels:

```
plot(plot::Function2d(cos(x), x = -PI..PI),  
      XTicksNumber = None,  
      XTicksAt = [-PI/2 = "-π/2", PI = "π"])
```

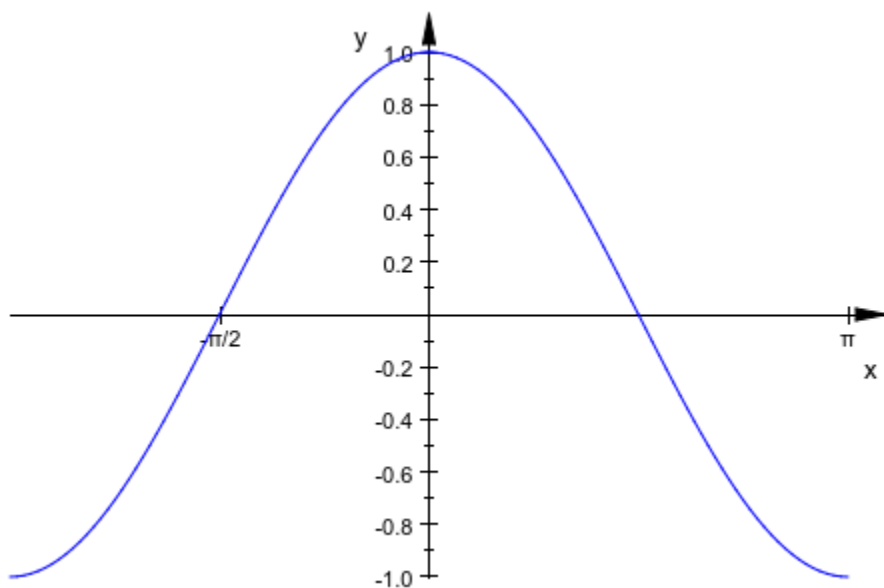

You can change the appearance of Greek characters by specifying the font. Note that this font is used for all tick labels.

```
plot(plot::Function2d(cos(x), x = -PI..PI),  
      XTicksNumber = None,  
      XTicksAt = [-PI/2 = "-π/2", PI = "π"],  
      TicksLabelFont = ["Times New Roman", 12])
```

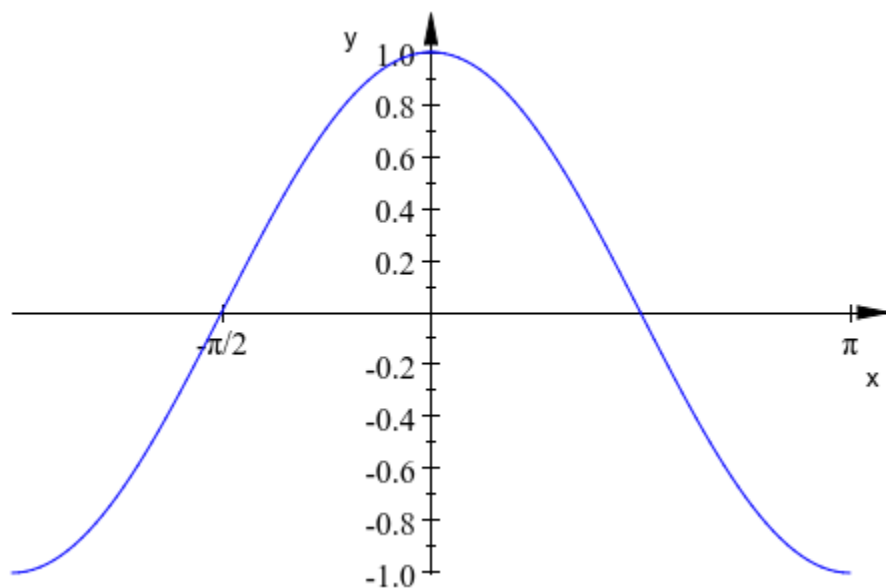

## See Also

### MuPAD Functions

[AxesTitles](#) | [Footer](#) | [Header](#) | [LegendText](#) | [LegendVisible](#) | [TicksAt](#) | [TicksLabelsVisible](#) | [Title](#)

### Topics

“Fonts” (Symbolic Math Toolbox)

## BackgroundColorBackgroundColor2

Background color

### Value Summary

BackgroundColor, BackgroundColor2	Inherited	Color
--------------------------------------	-----------	-------

### Graphics Primitives

Objects	Default Values
plot::Canvas, plot::Scene2d	BackgroundColor: RGB::White
plot::Scene3d	BackgroundColor: RGB::White BackgroundColor2: RGB::Grey75

### Description

These attributes set background colors for scenes, scene margins, and the remaining space in a canvas.

BackgroundColor sets the background color of a scene or canvas, where “background” refers to any area not occupied by graphical elements, including the margin on page 24-1667.

For a 3D-scene on page 24-1090, if BackgroundStyle is not Flat, the actual scene background (not including the margin) is a blend from BackgroundColor to BackgroundColor2. See BackgroundStyle for details.

## Examples

### Example 1

In the following plot, we combine three scenes with backgrounds in red, blue, and green and set the background color of the canvas to yellow:

```
s1 := plot::Scene3d(plot::Sphere(1, Color = RGB::White),  
                    BackgroundColor = RGB::Red):  
s2 := plot::modify(s1, BackgroundColor = RGB::Blue):  
s3 := plot::modify(s1, BackgroundColor = RGB::Green):  
plot(s1, s2, s3, BackgroundColor = RGB::Yellow):
```

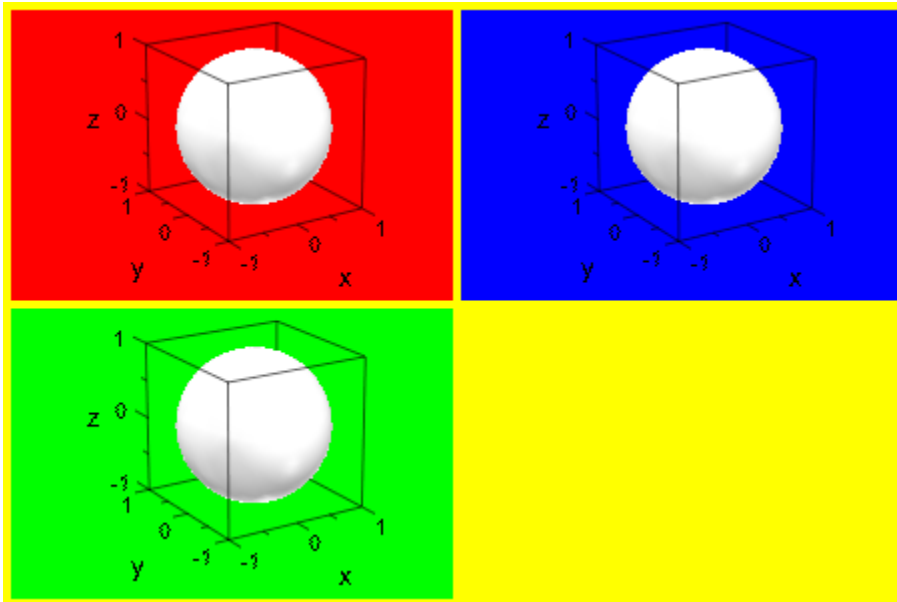

### Example 2

Using `BackgroundColor2` and `BackgroundStyle`, you can set the background of 3D-scenes to use a color blend:

```
plotfunc3d(x^2-y^2,  
          BackgroundStyle = LeftRight,  
          BackgroundColor2 = RGB::Chartreuse)
```

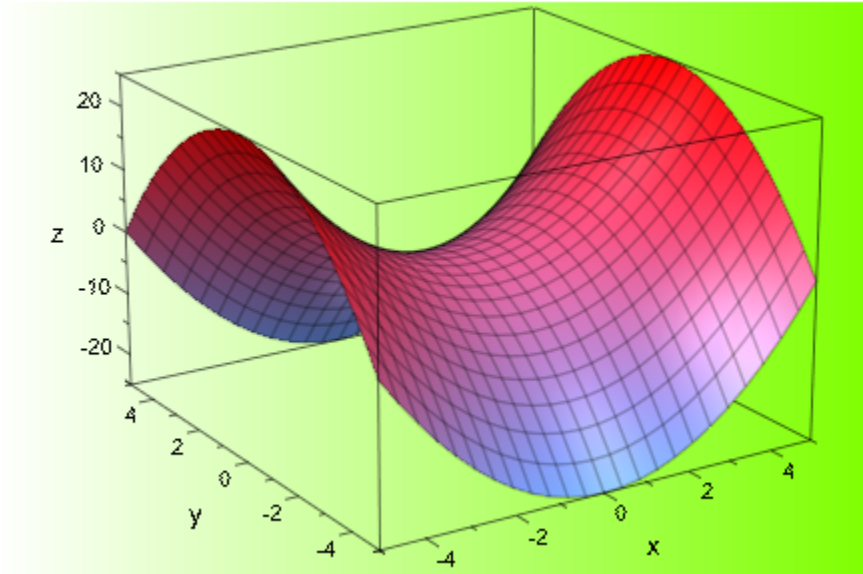

But note that the margin of the scene is still painted in its BackgroundColor:

```
plotfunc3d(x^2-y^2,  
          plot::Scene3d::BackgroundColor = RGB::Yellow,  
          plot::Scene3d::BackgroundStyle = LeftRight,  
          plot::Scene3d::BackgroundColor2 = RGB::LightBlue)
```



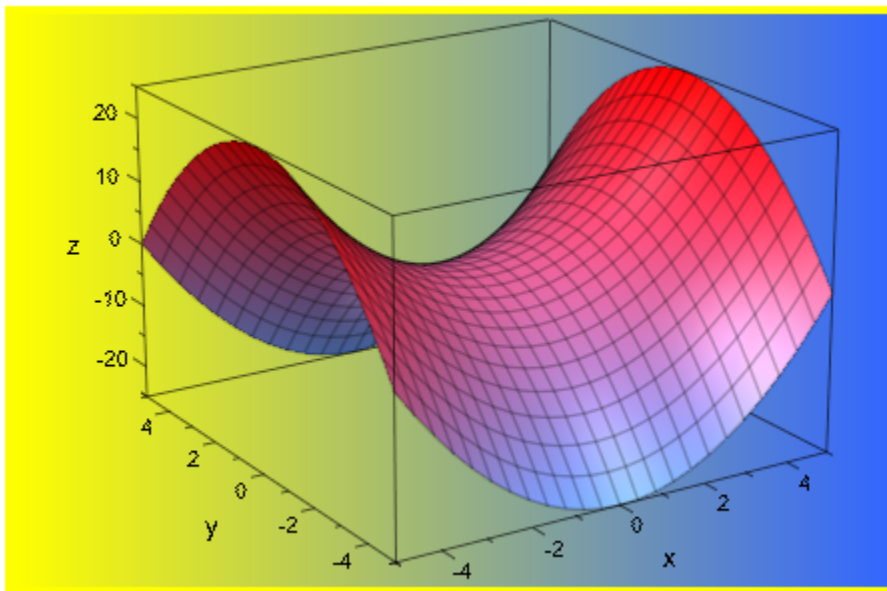

To avoid this margin, we set its width to zero:

```
plotfunc3d(x^2-y^2,  
           plot::Scene3d::BackgroundColor = RGB::Yellow,  
           plot::Scene3d::BackgroundStyle = LeftRight,  
           plot::Scene3d::BackgroundColor2 = RGB::LightBlue,  
           plot::Scene3d::Margin = 0)
```

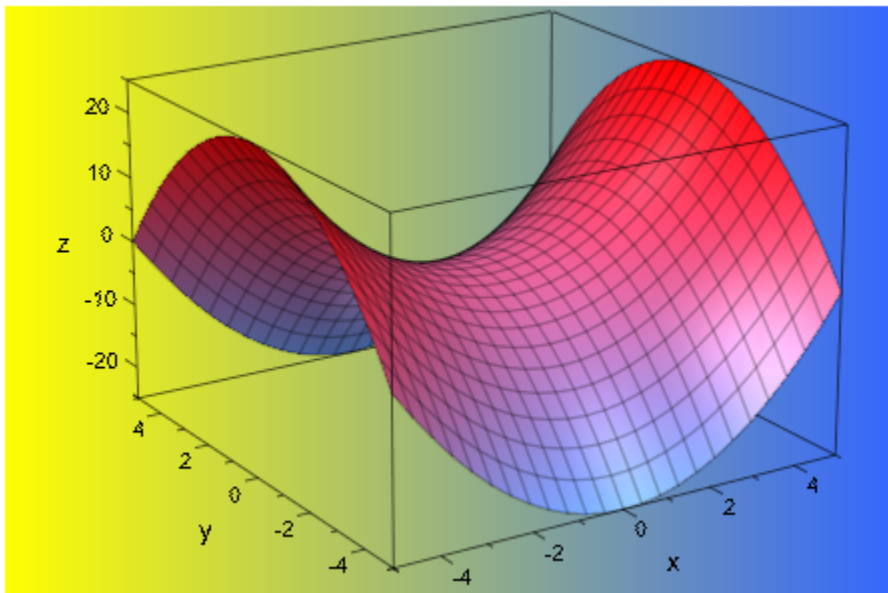

### Example 3

The fact that `BackgroundColor` is an attribute of both canvas and scenes has the effect that giving it directly in a plot command will only affect the canvas, not the implicitly generated scenes of a plot:

```
plot(plot::Circle2d(1),  
      BackgroundColor = RGB::Yellow)
```

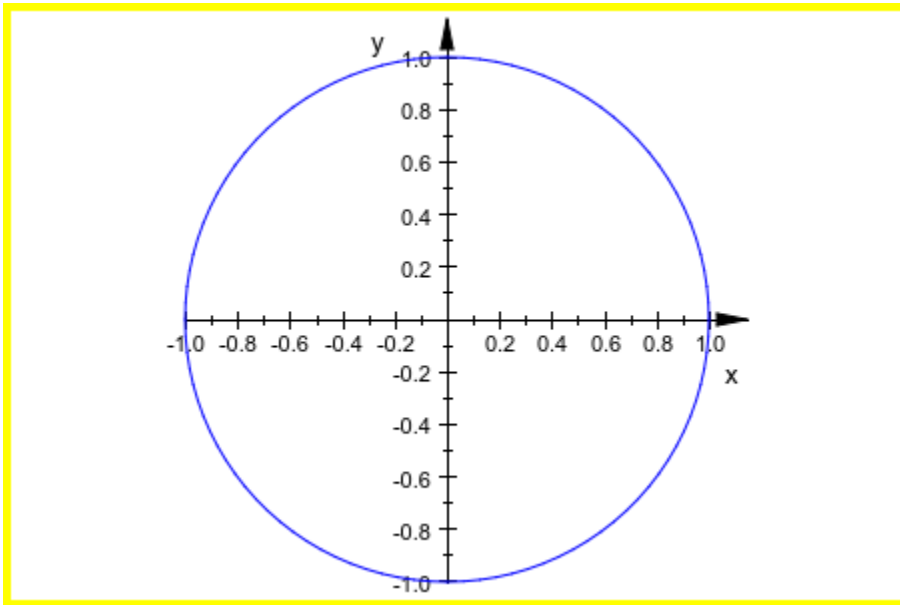

```
plotfunc2d(sin(x), BackgroundColor = RGB::Black)
```

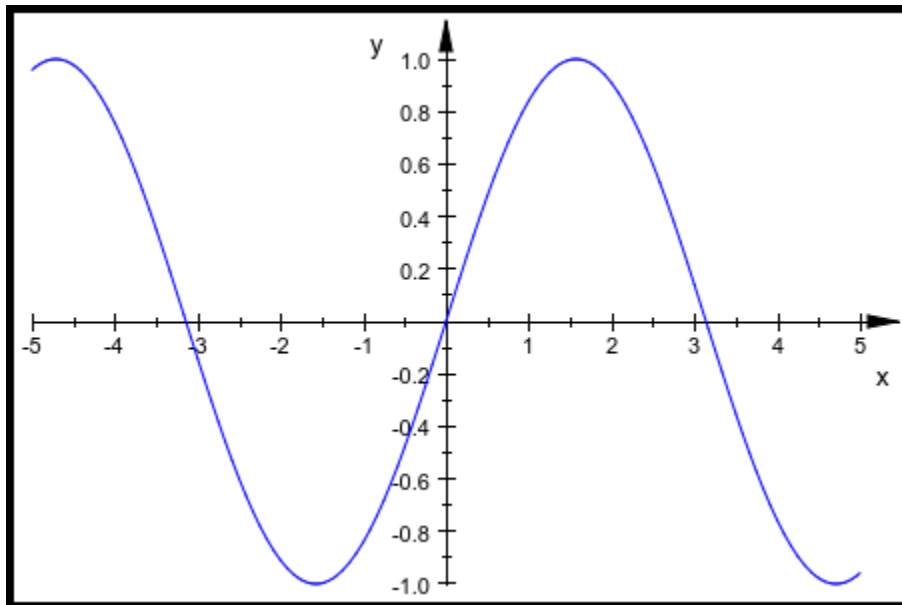

To set the background color of a scene, use one of the styles illustrated above: Either create a scene explicitly:

```
plot(plot::Scene2d(plot::Circle2d(1),  
                BackgroundColor = RGB::Yellow))
```

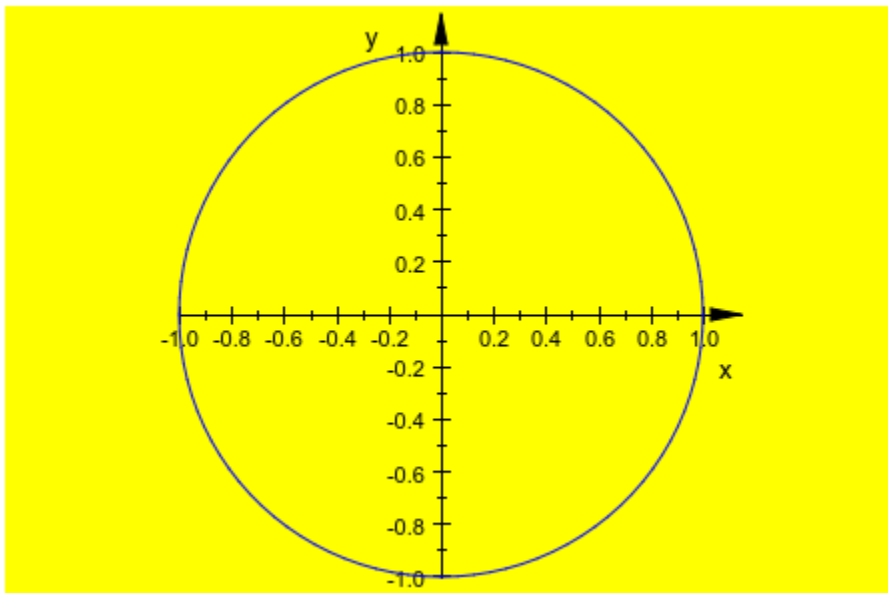

Or, set the attribute explicitly for scenes:

```
plotfunc2d(sin(x),  
            plot::Scene2d::BackgroundColor = RGB::Orange)
```

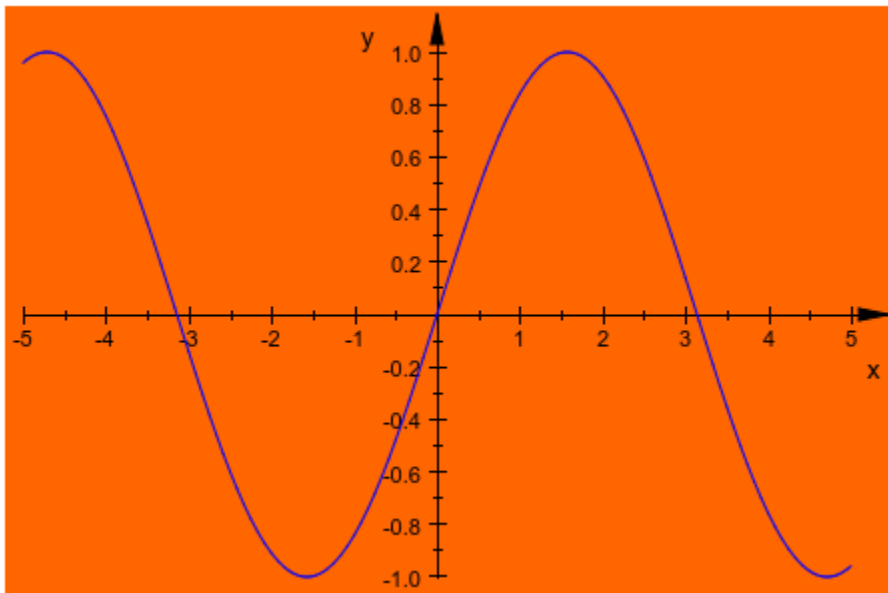

There is also a third option, not used in the examples above: You can set `BackgroundColor` as a hint (Symbolic Math Toolbox) in an object to be shown (but this does not work for `plotfunc2d` and `plotfunc3d`):

```
plot(plot::Text2d("Sample", [0, 0],  
    TextFont = [RGB::White, 60],  
    HorizontalAlignment = Center,  
    BackgroundColor = RGB::Black))
```



Sample

## See Also

### **MuPAD Functions**

[BackgroundStyle](#) | [BackgroundTransparent](#) | [Margin](#)

## BackgroundStyle

Color blends in the background

### Value Summary

Inherited	Flat, LeftRight, Pyramid, or TopBottom
-----------	--

### Graphics Primitives

Objects	BackgroundStyle Default Values
plot::Scene3d	Flat

### Description

BackgroundStyle gives a color blend in the background of a 3D scene.

The background of a 3D scene may be set to a single color (BackgroundStyle = Flat, using BackgroundColor) or to a blend from BackgroundColor to BackgroundColor2, in one of three possible directions: LeftRight and TopBottom are linear blends from left to right or from top to bottom, respectively, while Pyramid sets a linear blend from the center to the borders.

### Examples

#### Example 1

We demonstrate all possible styles, using a simple plot and the default values for BackgroundColor and BackgroundColor2:

```
c1 := plot::Cone(1, [0, 0, 0], [0, 0, 1]):  
c2 := plot::Cone(1, [0, 0, 2], [0, 0, 1]):
```



```
plot(plot::Scene3d(c1, c2, BackgroundStyle = Flat),  
     plot::Scene3d(c1, c2, BackgroundStyle = TopBottom),  
     plot::Scene3d(c1, c2, BackgroundStyle = LeftRight),  
     plot::Scene3d(c1, c2, BackgroundStyle = Pyramid),  
     Layout = Tabular)
```

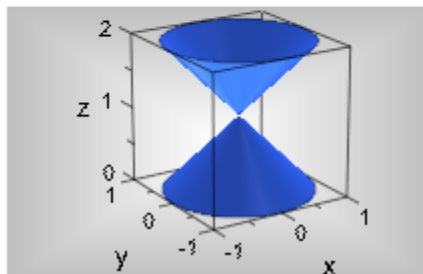
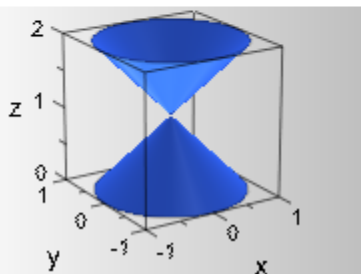
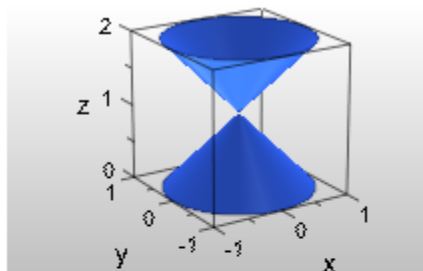
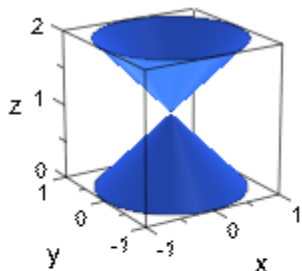

```
delete c1, c2:
```

## See Also

### MuPAD Functions

BackgroundColor | BackgroundColor2

## BackgroundTransparent

Plot a scene on a transparent background

### Value Summary

Inherited	FALSE, or TRUE
-----------	----------------

### Graphics Primitives

Objects	BackgroundTransparent Default Values
<code>plot::Scene2d</code> , <code>plot::Scene3d</code>	FALSE

### Description

Using `BackgroundTransparent`, you can have a scene “without a background.”

By default, each scene has an opaque background. In the case of overlapping scenes (which you can achieve by setting `Layout = Absolute` or `Layout = Relative` in the canvas and providing suitable values for `Bottom` and `Left` for the scenes), this may be undesirable. Using `BackgroundTransparent`, you can make the background of a scene transparent, so the canvas background and scenes behind it are visible.

With `BackgroundTransparent = TRUE`, other background settings (`BackgroundColor`, `BackgroundStyle`, `BackgroundColor2`) are ignored.

### Examples

#### Example 1

We create a number of random points and two statistical plots of this sample:

```

gen := stats::normalRandom(0, 1):
data := [gen() $ i = 1..1000]:
s1 := plot::Scene2d(plot::PointList2d([[i, data[i]]
                                     $ i = 1..1000]),
                   Left = 0, Bottom = 10,
                   Width = 120, Height = 80):
s2 := plot::Scene2d(plot::Histogram2d(data, Cells=[20]),
                   Left = 80, Bottom = 0,
                   Width = 50, Height = 40):
plot(s1, s2, Layout = Absolute, Width = 130, Height = 90)

```

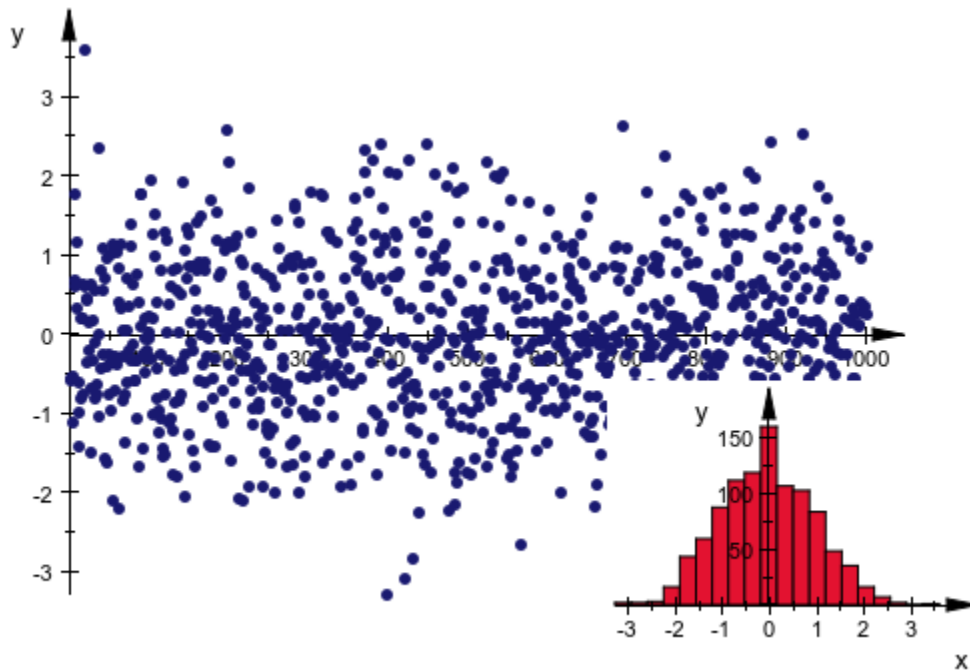

The histogram plot obscures parts of the point list in a rectangle much larger than the bars of the histogram plot. Using `BackgroundTransparent`, we can set this rectangle to transparent:

```

s2::BackgroundTransparent := TRUE:
plot(s1, s2, Layout = Absolute, Width = 130, Height = 90)

```

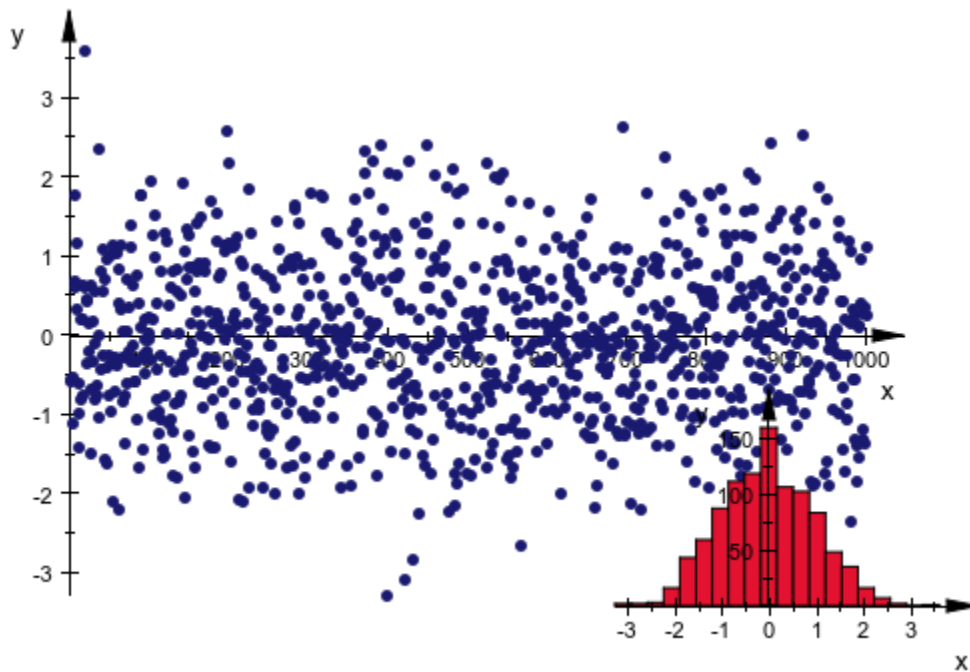

## See Also

### MuPAD Functions

[BackgroundColor](#) | [BackgroundColor2](#) | [Bottom](#) | [Layout](#) | [Left](#)

# Billboarding

Text orientation in space or towards observer

## Value Summary

Inherited	FALSE, or TRUE
-----------	----------------

## Graphics Primitives

Objects	Billboarding Default Values
plot::Piechart3d, plot::Text3d	TRUE

## Description

With `Billboarding = TRUE`, text objects are always facing the observer. With `Billboarding = FALSE`, text objects retain their orientation relative to other objects.

Often, text objects in 3D are used to label certain places in a graphic (note that objects can contain a title on page 24-1629, so text objects are usually only necessary for additional descriptions). In this case, it is desirable that they always face the observer to be readable and not rotate along with the rest of the scene. This is the default behavior. To get text objects that are actually part of the scene in the sense that rotating the scene also rotates the texts, set `Billboarding = FALSE`.

## Examples

### Example 1

In the following image, the prime numbers use `Billboarding = TRUE`, while other numbers do not:

```
plot(plot::Text3d(expr2text(i),  
                 [3*i, 0, 0],  
                 TextOrientation = [1, 0, 0, 0, 1, 0],  
                 Billboarding = isprime(i))  
$ i = 1..15,  
  TextFont = [20], Scaling = Constrained, Axes = None)
```

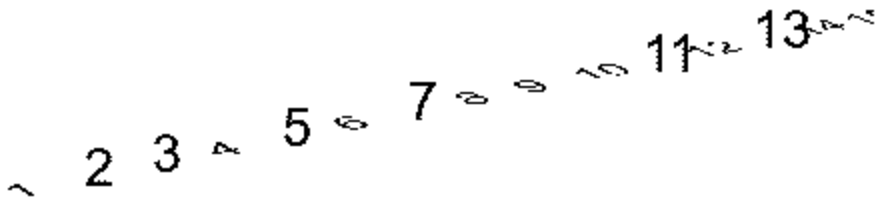

1 2 3 4 5 6 7 8 9 10 11 12 13 14 15

Note that text objects with `Billboarding = TRUE` ignore `TextOrientation`.

## See Also

### MuPAD Functions

Title

# BorderColorBorderWidth

Color of frame/border around canvas and scenes

## Value Summary

BorderColor, BorderWidth	Inherited	Color
-----------------------------	-----------	-------

## Graphics Primitives

Objects	Default Values
plot::Canvas, plot::Scene2d, plot::Scene3d	BorderColor: RGB::Grey50  BorderWidth: 0

## Description

The canvas as well as the scenes in a canvas can be framed by a rectangular border. The width of the border is set by `BorderWidth`, its color is set by `BorderColor`.

With the attributes `BorderWidth` and `BorderColor`, a canvas or individual scenes can be given a border, similar to an image frame. The border is “switched off” with the default value `BorderWidth = 0`. Set the border width to some positive value such as `BorderWidth = 0.5*unit::mm` to make the border visible.

The following picture illustrates the layout of the canvas:

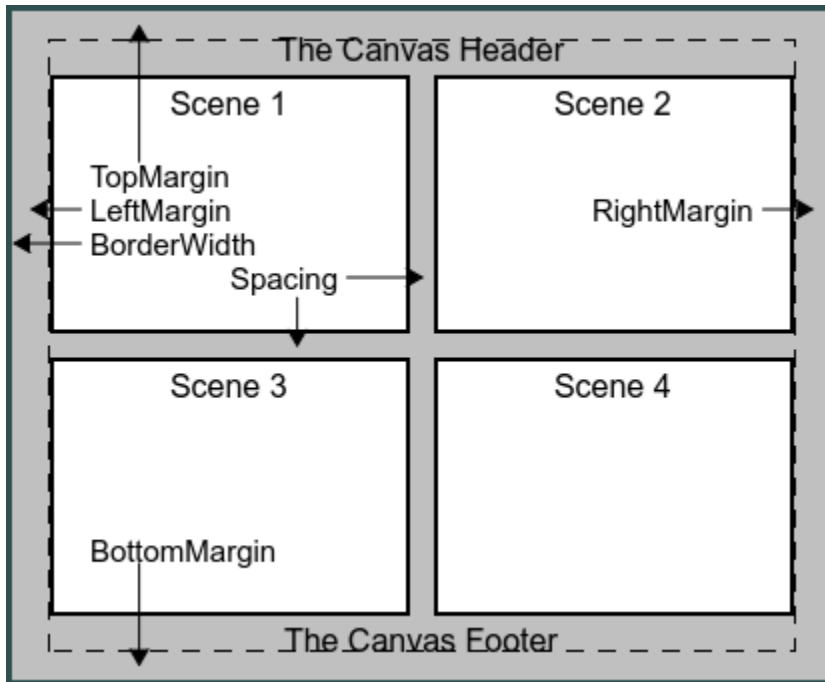

The following picture illustrates the layout of a scene:

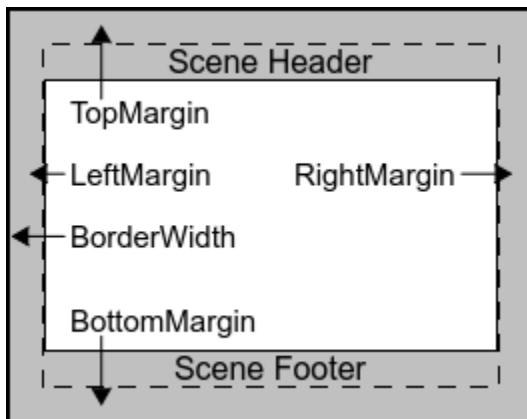

The size of a canvas, set by the attributes `Width` and `Height`, includes the width of the border set by `BorderWidth`. The same holds for the scenes.



With `BackgroundTransparent = TRUE`, transparent scenes (without a background) can be created. The borders do *not* become transparent!

The scene borders do not react to `Layout = Relative`. One always has to specify the border width as absolute physical lengths such as `BorderWidth = 0.5*unit::mm`.

Scenes do *not* inherit borders from the enclosing canvas. You can set the borders for all scenes simultaneously by specifying them in `plot::setDefault` as

```
plot::Scene2d::BorderWidth, plot::Scene2d::BorderColor
```

or

```
plot::Scene3d::BorderWidth, plot::Scene3d::BorderColor,
```

respectively. Cf. “Example 2” on page 24-1826 (Symbolic Math Toolbox).

## Examples

### Example 1

Two scenes are displayed side by side. The borders of the canvas and the two scenes are “switched on” by specifying positive values for `BorderWidth`:

```
S1 := plot::Scene2d(plot::Function2d(sin(x), x = 0 .. 2*PI),
                    Header = "The sine function",
                    BorderWidth = 0.5*unit::mm):
S2 := plot::Scene2d(plot::Function2d(cos(x), x = 0 .. 2*PI),
                    Header = "The cosine function",
                    BorderWidth = 0.5*unit::mm):
plot(S1, S2, Header = "Trigonometric functions",
     Width = 120*unit::mm, Height = 50*unit::mm,
     BorderWidth = 1.0*unit::mm, BorderColor = RGB::Black,
     Layout = Horizontal):
```

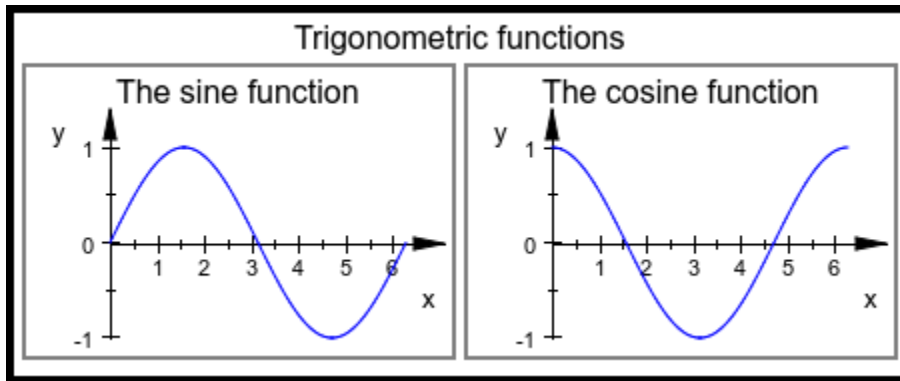

delete S1, S2:

## Example 2

We use `plot::setDefault` to define new default values for the layout and style parameters `BorderWidth`, `BorderColor`, `Margin`, and `BackgroundColor`:

```
plot::setDefault(
  plot::Canvas::BorderWidth = 0.5*unit::mm,
  plot::Canvas::BorderColor = RGB::Black,
  plot::Canvas::Margin = 1.5*unit::mm,
  plot::Canvas::BackgroundColor = RGB::SlateGrey,
  plot::Scene2d::BorderWidth = 0.5*unit::mm,
  plot::Scene2d::BorderColor = RGB::Black,
  plot::Scene2d::Margin = 2*unit::mm,
  plot::Scene2d::BackgroundColor = RGB::Grey
):
```

The following canvas contains two scenes. This plot uses the new defaults:

```
plot(plot::Scene2d(plot::Rectangle(-1..1, -1..1,
  Filled = TRUE, FillColor = RGB::Red,
  Header = "Scene 1")),
  plot::Scene2d(plot::Rectangle(-1..1, -1..1,
  Filled = TRUE, FillColor = RGB::Blue,
  Header = "Scene 2")),
  Layout = Horizontal, Axes = None,
  Header = "Canvas Header"):
```

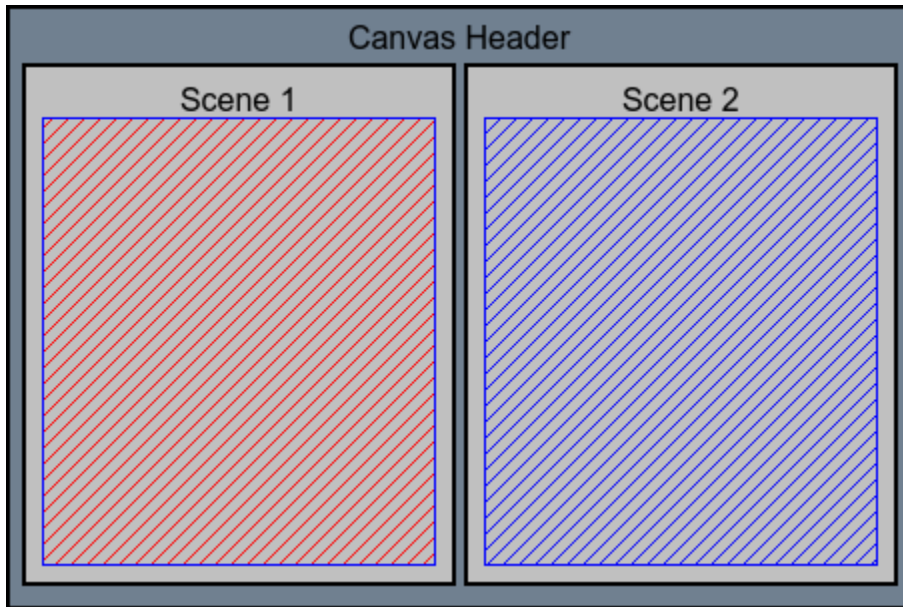

## See Also

### MuPAD Functions

[BackgroundColor](#) | [BackgroundColor2](#) | [BackgroundStyle](#) | [BackgroundTransparent](#) | [Bottom](#) | [Left](#) | [Margin](#)

## BoxCentersBoxWidths

Position of boxes in a box plot

### Value Summary

BoxCenters, BoxWidths	Optional	List of arithmetical expressions
-----------------------	----------	----------------------------------

### Graphics Primitives

Objects	Default Values
<code>plot::Boxplot</code>	BoxCenters: [1] BoxWidths: [0.8]

### Description

`BoxCenters` and `BoxWidths` govern horizontal center positions and widths of boxes in statistical box plots of Type `plot::Boxplot`.

A plot of type `plot::Boxplot` serves for visualizing and comparing statistical data samples.

A data sample defines the vertical coordinates of the corresponding box. The position along the horizontal axis as well as the horizontal width, however, is arbitrary and may be manipulated by the attributes `BoxCenters` and `BoxWidths`.

By default, the box of the  $i$ -th data sample is positioned at the horizontal value  $x = i$ . With the default width of 0.8, the  $i$ -th box extends from  $x = i - 0.4$  to  $x = i + 0.4$ .

The value of the attribute `BoxCenters` must be a list of  $x$ -values for the horizontal centers of the boxes.

If the length of this list is smaller than the number of data samples in the box plot, the center values are incremented by 1 for each surplus box.

If the length of the `BoxCenters` list is larger than the number of data samples, the surplus center values are ignored.

Setting `BoxCenters = [x1]`, the first box is centered at  $x = x_1$ , while the standard distance between the boxes is kept. Thus, `BoxCenters = [x1]` allows to shift the entire box plot along the horizontal axis.

The value of the attribute `BoxWidths` must be a list of positive real values.

If the length of this list is smaller than the number of data samples in the box plot, the default width 0.8 is used for the surplus boxes.

If the length of the `BoxWidth` list is larger than the number of data samples, the surplus width values are ignored.

If the attribute `DrawMode = Horizontal` is set in the `plot::Boxplot` object, the boxes are drawn from left to right instead from bottom to top.

In this case, the attributes `BoxCenters` and `BoxWidths` refer to the vertical coordinates of the boxes.

## Examples

### Example 1

We create a box plot visualizing 5 data samples:

```
data1 := [stats::uniformRandom(2, 4)() $ k = 1..100]:
data2 := [stats::normalRandom(3, 0.3)() $ k = 1..100]:
data3 := [stats::normalRandom(3, 1)() $ k = 1..100]:
data4 := [stats::normalRandom(3, 1)() $ k = 1..100]:
data5 := [stats::normalRandom(3, 1)() $ k = 1..100]:
plot(plot::Boxplot(data1, data2, data3, data4, data5,
                  Notched = TRUE)):
```

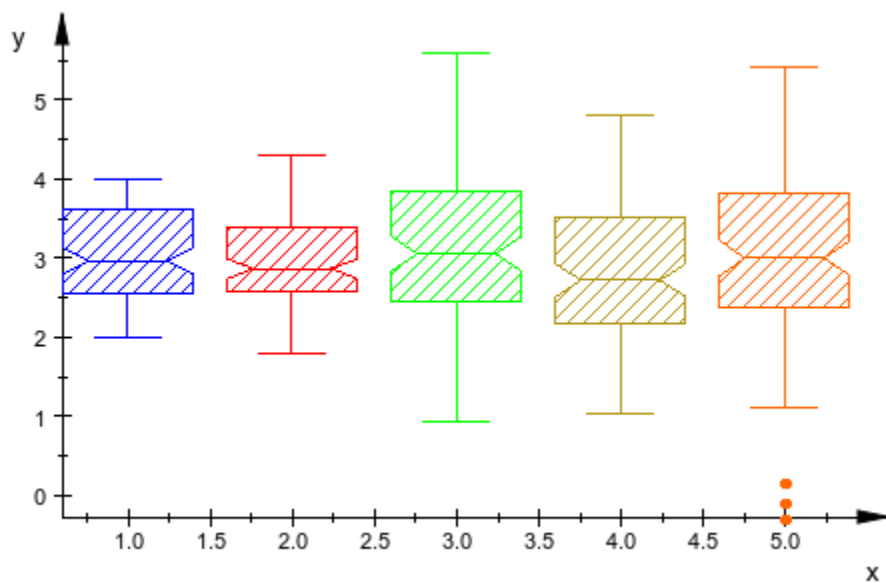

We specify the horizontal centers and the widths of the boxes such that the first two and the last three boxes touch each other:

```
plot(plot::Boxplot(data1, data2, data3, data4, data5,  
  Notched = TRUE,  
  BoxCenters = [1, 2, 4, 5, 6],  
  BoxWidths = [1, 1, 1, 1, 1])):
```

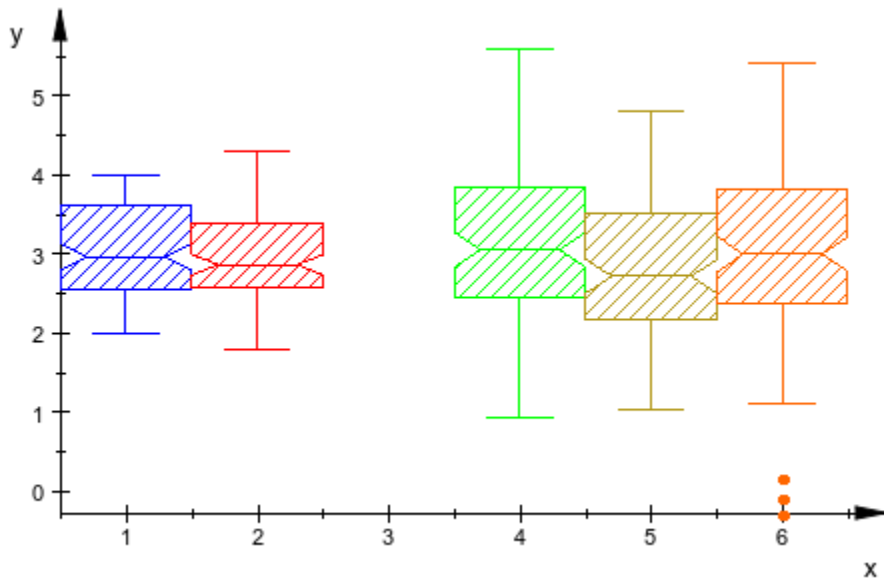

We place two of the data boxes on top of each other for direct comparison:

```
plot(plot::Boxplot(data1, data4, Notched = TRUE,  
  BoxCenters = [1, 1], BoxWidths = [2, 2]))
```

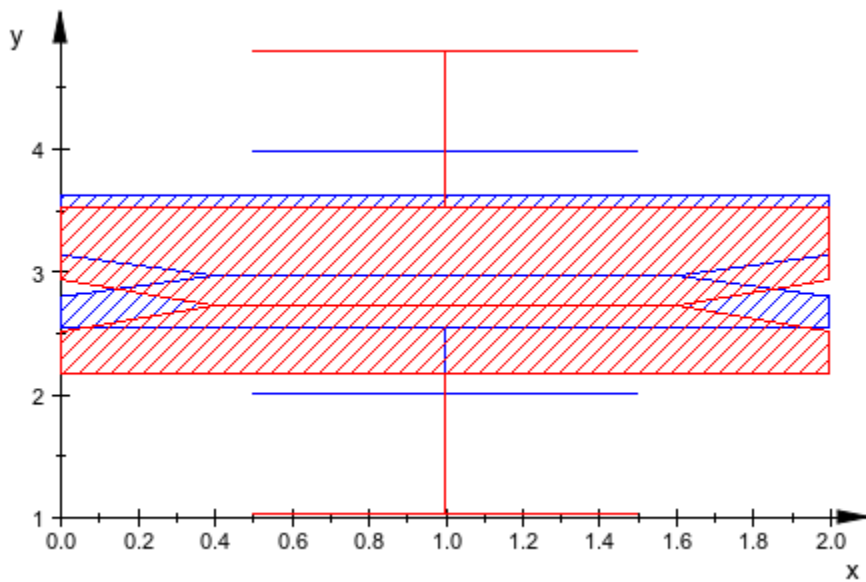

```
delete data1, data2, data3, data4, data5:
```

## See Also

### MuPAD Functions

DrawMode | NotchWidth | Notched



# DrawMode

Orientation of boxes and bars

## Value Summary

Optional	Horizontal or Vertical
----------	------------------------

## Graphics Primitives

Objects	DrawMode Default Values
<code>plot::Bars2d</code> , <code>plot::Boxplot</code> , <code>plot::Histogram2d</code>	Vertical

## Description

`DrawMode = Vertical` versus `DrawMode = Horizontal` determines the orientation of boxes in a box plot and bars in bar plots and histogram plots.

A plot of type `plot::Boxplot` serves for visualizing and comparing statistical data samples. The plot reduces the data to few simple descriptive parameters.

One coordinate direction provides information on the statistical data (25% quantile, median, 75% quantile etc.). The other coordinate direction just serves for placing several boxes associated with different data samples side by side for comparison.

With `DrawMode = Vertical`, the vertical direction provides the information on the statistical data.

With `DrawMode = Horizontal`, the boxes are turned by 90 degrees. Now, the horizontal direction provides the information on the statistical data.

Corresponding statements hold for the bars in a 2D bar plot of type `plot::Bars2d` and 2D histograms of type `plot::Histogram2d`.

## Examples

### Example 1

We create a box plot:

```
data1 := [2, 6, 4, 3, 1, 7, 9, 5, 3]:
data2 := [2, 4, 8, 8, 7, 6, 8, 7, 3, 1, 10]:
data3 := [stats::normalRandom(6, 2)() $ k = 1 .. 100]:
plot(plot::Boxplot(data1, data2, data3, Notched = TRUE)):
```

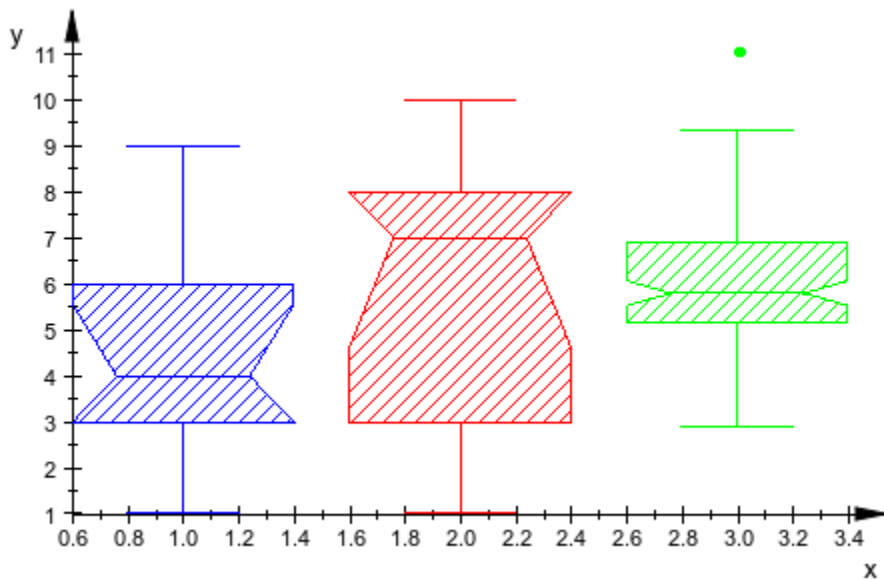

The boxes are rendered horizontally:

```
plot(plot::Boxplot(data1, data2, data3, Notched = TRUE,
  DrawMode = Horizontal)):
```

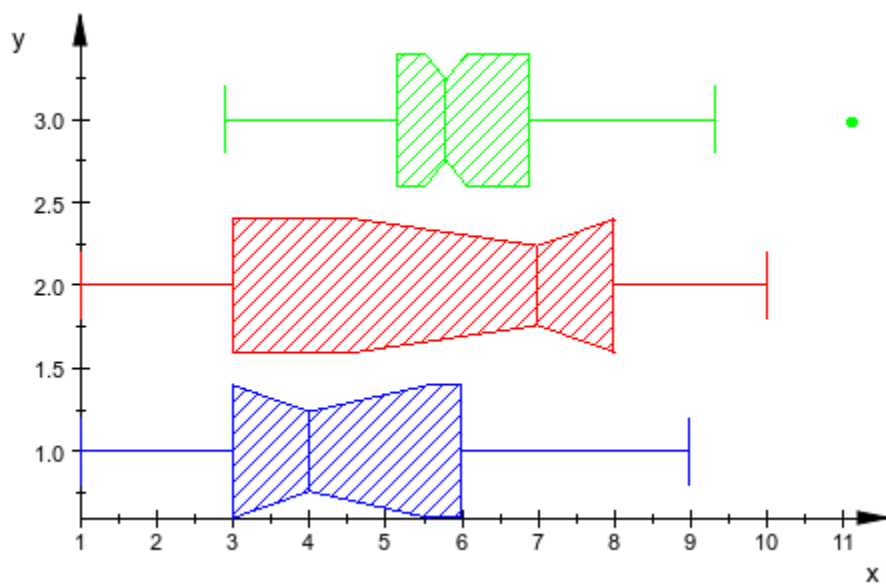

```
delete data1, data2, data3:
```

## See Also

### MuPAD Functions

BoxCenters | BoxWidths | NotchWidth | Notched

## GapXGapYGap

Gaps between the bars of a bar chart

### Value Summary

Gap	[[XGap, YGap]]	See below
XGap, YGap	Optional	MuPAD expression

### Graphics Primitives

Objects	Default Values
<code>plot::Bars3d</code>	Gap: [0, 0] XGap, YGap: 0

### Description

Gap, XGap, YGap sets gaps between the bars of a bar chart.

In `plot::Bars3d`, the attribute `Gap = [gx, gy]` or, equivalently, `XGap = gx`, `YGap = gy` allows to introduce gaps between adjacent bars. The values `gx`, `gy` may be real numerical values between 0 and 1 or expressions of the animation parameter. These values set the fraction of the space reserved for a bar that is not filled by the bar.

With `gx = 0`, `gy = 0`, there are no gaps. With `gx = 0.5`, `gy = 0.5`, the gaps between adjacent bars are of the same size as the bars. With `gx = 1`, `gy = 1`, there bars become lines.

Values of `gx`, `gy` larger than 1 are treated like 1, negative values like 0.

The `Gap` attribute has an effect only for `BarStyle = Boxes`.

# Examples

## Example 1

We display the same data with different Gap values:

```
A := matrix::random(5, 5, frandom) :  
plot(plot::Scene3d(plot::Bars3d(A, Gap = [0, 0])),  
      plot::Scene3d(plot::Bars3d(A, Gap = [0.4, 0.4])),  
      plot::Scene3d(plot::Bars3d(A, Gap = [0.7, 0.7])),  
      Width = 150*unit::mm, Height = 50*unit::mm,  
      Layout = Horizontal):
```

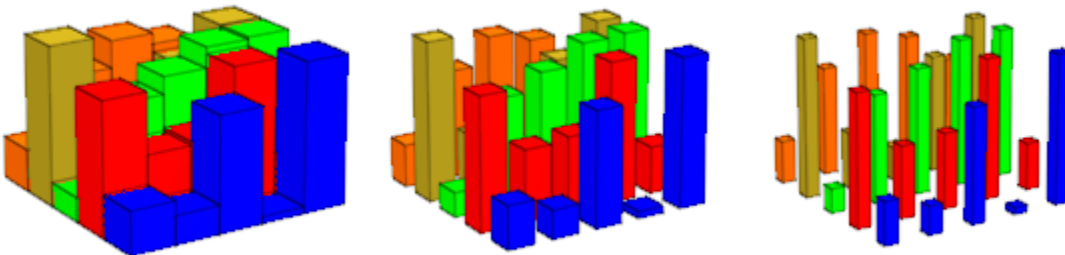

```
delete A:
```

## NotchedNotchWidth

Notched boxes in box plots

### Value Summary

Notched, NotchWidth	Optional	TRUE or FALSE
---------------------	----------	---------------

### Graphics Primitives

Objects	Default Values
<code>plot::Boxplot</code>	Notched: FALSE NotchWidth: 0.2

### Description

With `Notched = TRUE`, the boxes in a statistical box plot of type `plot::Boxplot` are notched. The notches provide further information on the statistical data.

The attribute `NotchWidth` determines the horizontal width of the notches.

A plot of type `plot::Boxplot` serves for visualizing and comparing statistical data samples. The plot reduces the data to few simple descriptive parameters.

One graphical parameter is the height of notches that are displayed in the sides of the boxes when using `Notched = TRUE`. A typical notched box looks like this:

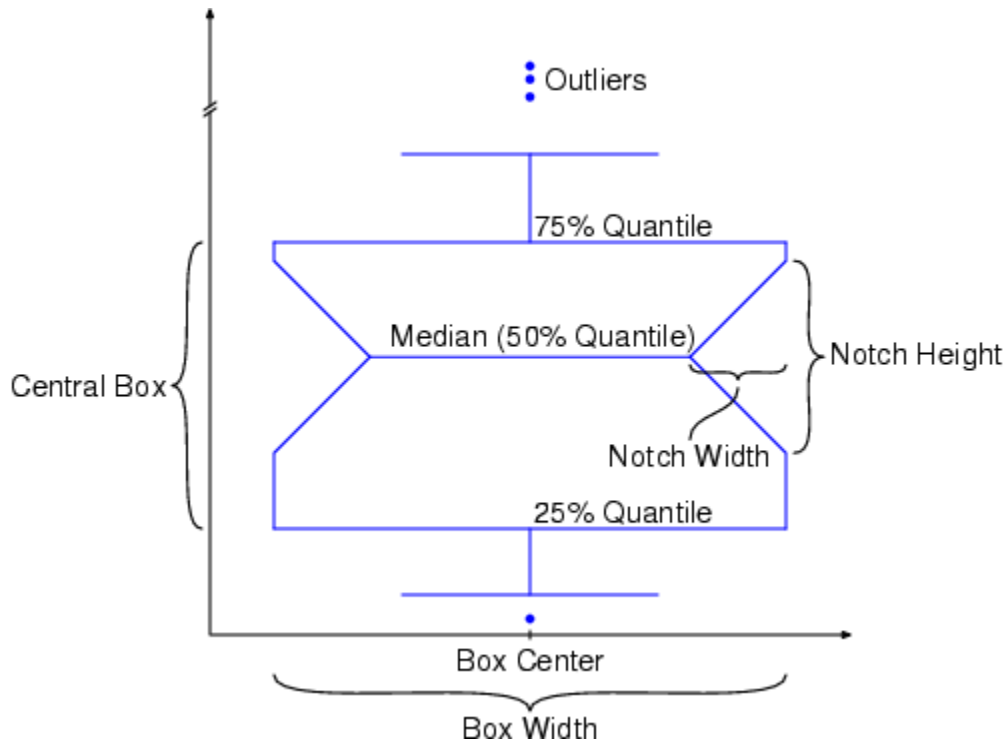

The height of the notches is 3.14 times the height of the central box divided by the square root of the number of data elements in the corresponding data sample.

Notched box plots are useful for determining whether two random samples were drawn from the same population. Similar notches of boxes indicate that the data visualized by the boxes have the same distribution.

This, however, is not a *rigorous* criterion that the data samples are indeed identically distributed.

The horizontal width of the notches bears no statistical significance and is just a layout parameter. Setting `NotchWidth = r`, the absolute horizontal notch width of a box is  $r$  times the width of the box. Reasonable values for  $r$  lie between 0 and  $\frac{1}{2}$ .

The widths of the boxes can be set via the attribute `BoxWidths`.

## Examples

### Example 1

We create a notched box plot of several random samples:

```
r := stats::normalRandom(0, 1):  
data1 := [r() $ k = 1..100]:  
data2 := [r() $ k = 1..200]:  
data3 := [r() $ k = 1..300]:  
plot(plot::Boxplot(data1, data2, data3, Notched = TRUE)):
```

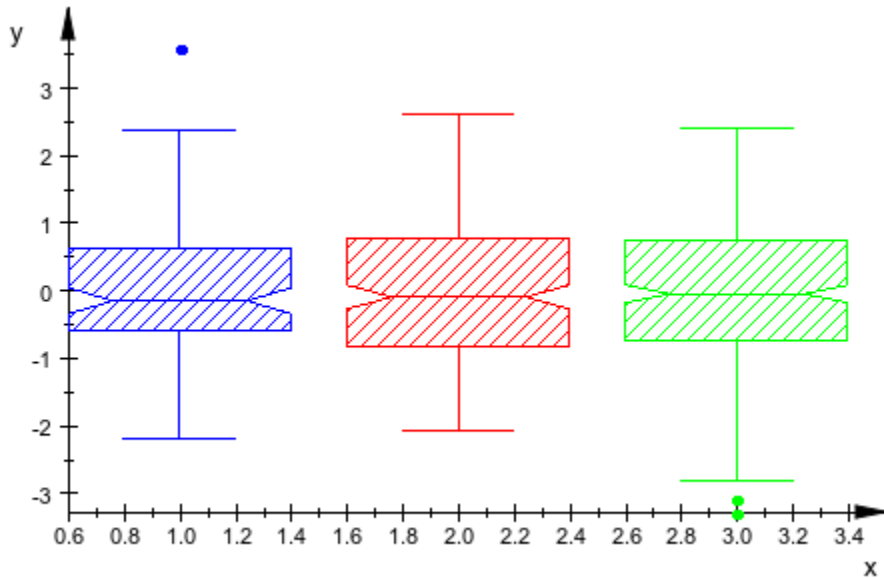

We change the NotchWidth:

```
plot(plot::Boxplot(data1, data2, data3, Notched = TRUE,  
                  NotchWidth = 0.4)):
```



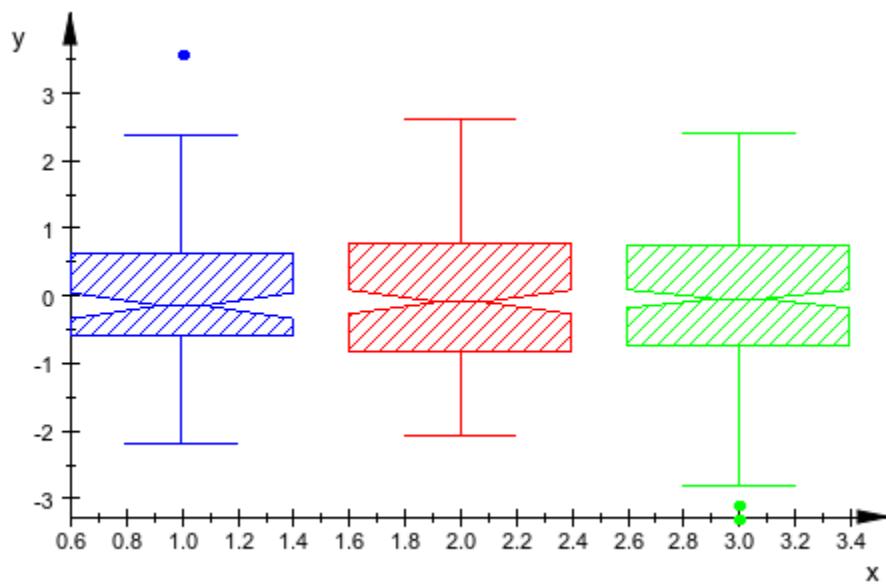

```
delete r, data1, data2, data3:
```

## See Also

### MuPAD Functions

BoxCenters | BoxWidths | DrawMode

## Projectors

Project an ODE solution to graphical points

### Value Summary

Mandatory	List of arithmetical expressions
-----------	----------------------------------

### Graphics Primitives

Objects	Projectors Default Values
<code>plot::0de2d</code> , <code>plot::0de3d</code>	

### Description

Projectors defines “generators of plot data” that project solution points  $(t, Y(t))$  of an ODE to graphical points  $[x, y]$  in 2D or  $[x, y, z]$  in 3D, respectively.

Internally, `plot::0de2d` and `plot::0de3d` generate a sequence of numerical solution points  $(t_0, Y(t_0)), (t_1, Y(t_1))$  etc. of an ODE. Each of these solution points is mapped to a graphical point via the “projectors” defined by Projectors.

Each projector  $G_i$  in `Projectors = [[G1], [G2], ...]` is a list

$[G_i] = [(t, Y) \rightarrow [x(t, Y), y(t, Y), \langle z(t, Y) \rangle], \langle \text{Style} = \text{style} \rangle, \langle \text{Color} = \text{color} \rangle]$ .

The procedures  $(t, Y) \rightarrow [x(t, Y), y(t, Y), \langle z(t, Y) \rangle]$  map the solution points  $(t_i, Y_i)$  of the ODE to points  $[x(t_i, Y_i), y(t_i, Y_i)]$  in 2D (for `plot::0de2d`) or  $[x(t_i, Y_i), y(t_i, Y_i), z(t_i, Y_i)]$  in 3D (for `plot::0de3d`). These points are drawn in the picture, interpolated by linear or cubic spline interpolation according to the attribute `Style = style` in the color set by the attribute `Color = color`.

The style parameter may be one of the flags `Points` (only the points are displayed), `Lines` (only interpolating line segments are displayed), `Splines` (only the interpolating

cubic spline curve is displayed), [Lines, Points] (interpolating line segments together with the interpolation points are displayed) , or [Splines, Points] (the interpolating cubic spline curve together with the interpolation points are displayed).

The default style is `Style= [Splines, Points]`.

Each of the projectors  $G_1, G_2$  etc. (denoted by  $G$  in the following) is a mapping

$G: (t, Y) \rightarrow [x(t, Y), y(t, Y)]$  in 2D or  $G: (t, Y) \rightarrow [x(t, Y), y(t, Y), z(t, Y)]$  in 3D. It must accept a numerical argument  $t$  and a vector  $Y$  (a list or a one-dimensional array) and must return a list of numerical coordinate values  $[x, y]$  (in `plot::0de2d`) or  $[x, y, z]$  (in `plot::0de3d`), respectively. Defining appropriate projectors, any information on the solution curve of the ODE can be displayed graphically.

Here are some examples:

`G := (t, Y) -> [t, Y[1]]` creates a 2D plot of the first component of the solution vector along the  $y$ -axis, plotted against the time variable  $t$  along the  $x$ -axis

`G := (t, Y) -> [Y[1], Y[2]]` creates a 2D phase plot, plotting the first component of the solution along the  $x$ -axis and the second component along the  $y$ -axis. The result is a solution curve in phase space (parametrized by the time  $t$ ).

`G := (t, Y) -> [Y[1], Y[2], Y[3]]` creates a 3D phase plot of the first three components of the solution curve.

If no projectors are specified in a call to `plot::0de2d`, the default projectors `Generators = [[G1], [G2], ...]` are used, where

`[Gi] = [(t, Y) -> [t, Y[i]], Style = [Splines, Points]]`.

This plots the  $i$ -th component of the solution vector along the  $y$ -axis against the "time"  $t$  plotted along the  $x$ -axis.

In `plot::0de3d`, the default projectors are

`[Gi] = [(t, Y) -> [t, Y[2*i - 1], Y[2*i]], Style = [Splines, Points]]`.

This plots two of the components of the solution vector along the  $y$ - and  $z$ -axis against the "time"  $t$  plotted along the  $x$ -axis.

## Examples

### Example 1

We consider the 2nd order ODE  $y'' = -y + \sin(3y)$ ,  $y(0) = 1$ ,  $y'(0) = 0$ . As a dynamical system for  $Y = (Y_1, Y_2) = (y, y')$ , the ODE to be solved is

$$\frac{d}{dt} Y = \frac{d}{dt} \begin{pmatrix} Y_1 \\ Y_2 \end{pmatrix} = \begin{pmatrix} Y_2 \\ -Y_1 + \sin(3Y_1) \end{pmatrix}$$

The first projector  $G_1$  plots the solution in red as a phase curve in the  $(x, y)$ -plane.

The second projector  $G_2$  plots the kinetic energy  $\frac{Y_2^2}{2} = \frac{y'^2}{2}$  in green along the  $z$ -axis.

The third projector  $G_3$  plots the potential energy  $Y_1^2 + \frac{\cos(3Y_1)}{3} = \frac{y^2}{2} + \frac{\cos(3y)}{3}$  in blue along the  $z$ -axis.

The fourth projector  $G_4$  plots the total energy in black along the  $z$ -axis:

```
f := (t, Y) -> [Y[2], - Y[1] + sin(3*Y[1])]:
Y0 := [0, 1]:
G1 := (t, Y) -> [Y[1], Y[2], 0]:
G2 := (t, Y) -> [Y[1], Y[2], Y[2]^2/2]:
G3 := (t, Y) -> [Y[1], Y[2], Y[1]^2/2 + cos(3*Y[1])/3]:
G4 := (t, Y) -> [Y[1], Y[2], Y[1]^2/2 + cos(3*Y[1])/3 + Y[2]^2/2]:
plot(plot::Ode3d(
  f, [i/10 $ i = 0..100], Y0,
  [G1, Style = Splines, Color = RGB::Red],
  [G2, Style = Lines, Color = RGB::Green],
  [G3, Color = RGB::Blue],
  [G4, Style = [Lines, Points], Color = RGB::Black]))
```

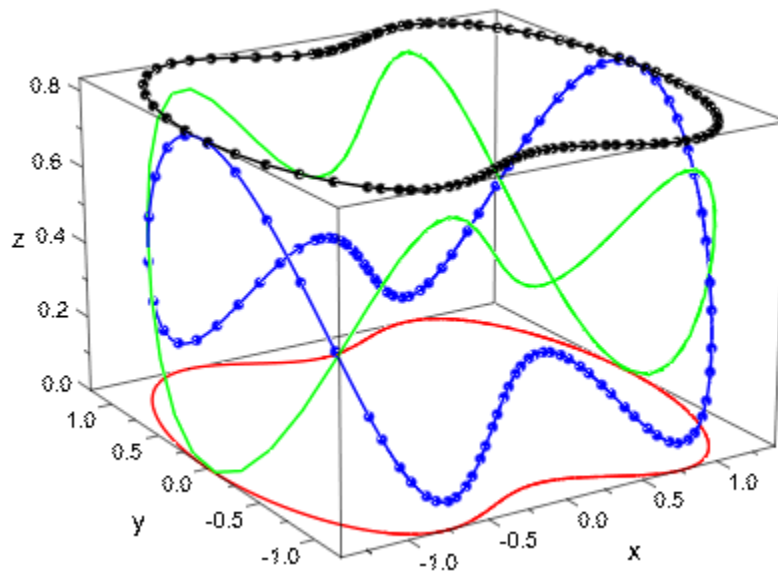

delete f, Y0, G1, G2, G3, G4:

## See Also

### MuPAD Functions

[AbsoluteError](#) | [InitialConditions](#) | [ODEMethod](#) | [RelativeError](#) | [Stepsize](#) | [TimeMesh](#)

## ScalingYXRatioZXRatio

Scaling ratios

### Value Summary

Scaling	Inherited	Automatic, Constrained, or Unconstrained
YXRatio, ZXRatio	Inherited	Positive real numberReal number

### Graphics Primitives

Objects	Default Values
plot::CoordinateSystem2d, plot::CoordinateSystem3d	Scaling: Unconstrained
plot::Scene3d	YXRatio: 1 ZXRatio: 2/3

### Description

With `Scaling = Constrained`, the graphics output is scaled like the model coordinates, i.e., circles appear as circles, spheres as spheres.

With `Scaling = Unconstrained`, the graphics output is scaled independently in each coordinate direction such that the graphics fits optimally into the viewing area. Circles may appear as ellipses, spheres as ellipsoids.

For `Scaling = Unconstrained`, the scaling ratios of the different coordinate directions in a 3D plot can be set via the attributes `YXRatio` and `ZXRatio`.

If the graphics consists of geometrical objects such as circles, pie charts, spheres etc., the setting `Scaling = Constrained` is appropriate. This prevents circles from being deformed to ellipses in the graphical output.

For the visualization of non-geometrical data (usually, in function plots etc.), a scaling constrained to model coordinates is usually not appropriate. Think of the graph of  $y = e^x$  for  $x \in [0, 10]$ , where the  $y$  values extend over the range  $y \in [e^0, e^{10}]$ , which is roughly  $[1, 22026]$ . With `Scaling = Constrained`, the graphical output would consist of a narrow vertical strip with the side ratio  $y : x = 22025 : 10$ . Here, `Scaling = Unconstrained` is appropriate.

The default value is `Scaling = Unconstrained`. However, many “geometrical” objects in the MuPAD plot library override this default setting via the “hint mechanism” (see section Primitives Requesting Special Scene Attributes: “Hints” (Symbolic Math Toolbox) in this document). Whenever such an object is plotted in a scene, the whole scene uses `Scaling = Constrained`. A complete list of these “geometrical objects” such as circles, spheres, cones etc. is given further up on this help page.

With `Scaling = Automatic`, the graphics uses `Scaling = Constrained` for plots in which the coordinate ranges to be displayed have a ratio close to  $1 : 1$  in 2D or  $1 : 1 : 1$  in 3D. Otherwise, `Scaling = Unconstrained` is used.

The attributes `YXRatio = r1` and `ZXRatio = r2` only have an effect in 3D with `Scaling = Unconstrained`. The graphical scene is scaled to a box with side ratios  $z : y : x = r_2 : r_1 : 1$ . On the screen, the bounding box of the scene looks like a box with these side ratios.

## Examples

### Example 1

We plot a scene containing a function graph and some circles highlighting the extrema. Because the circle sends the “hint” `Scaling = Constrained`, this scaling is used for the whole scene. Consequently, the circles appear as circles:

```
plot(plot::Function2d(sin(x), x = 0 .. 2*PI),
      plot::Circle2d(0.2, [PI/2, 1], Color = RGB::Black),
      plot::Circle2d(0.2, [3*PI/2, -1], Color = RGB::Black),
```

```

BorderWidth = 1.0*unit::mm,
Header = "Scaling = Constrained")

```

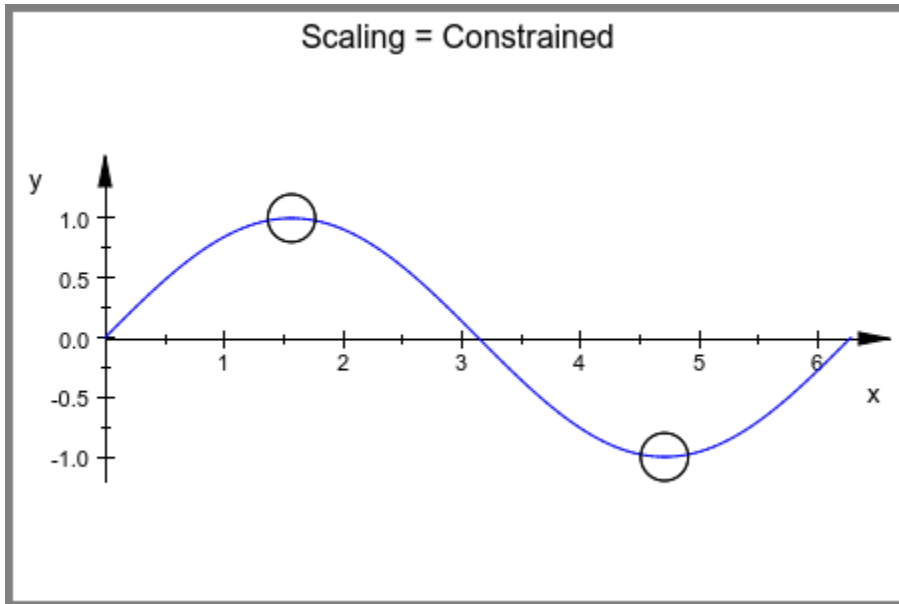

With `Scaling = UnConstrained`, we get a better fit of the plot in the canvas. However, the circles are deformed to ellipses:

```

plot(plot::Function2d(sin(x), x = 0 .. 2*PI),
      plot::Circle2d(0.2, [PI/2, 1], Color = RGB::Black),
      plot::Circle2d(0.2, [3*PI/2, -1], Color = RGB::Black),
      Scaling = Unconstrained, BorderWidth = 1.0*unit::mm,
      Header = "Scaling = Unconstrained")

```



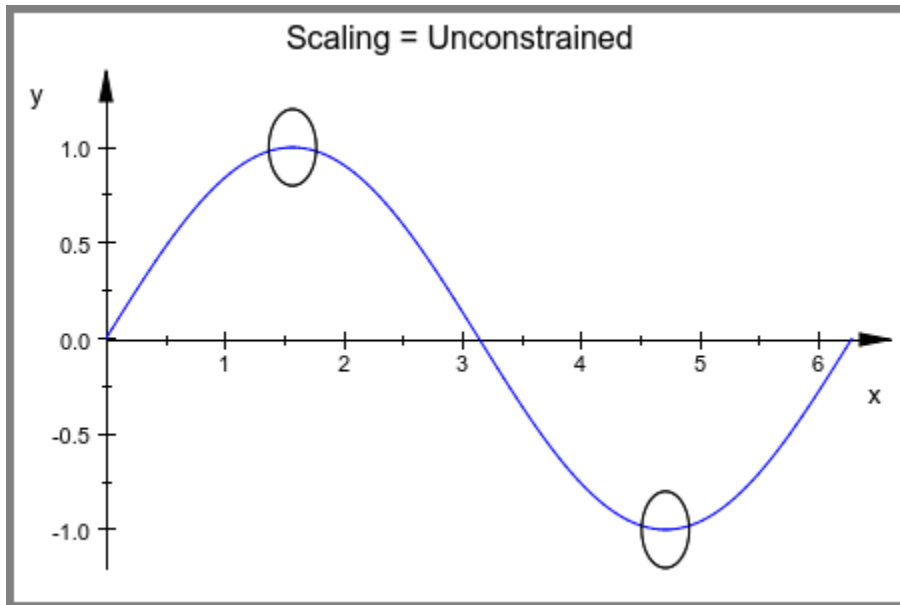

## Example 2

A sphere of type `plot::Sphere` sends the "hint" `Scaling = Constrained`. With this scaling, `YXRatio`, `ZXRatio` have no effect:

```
s := plot::Sphere(1, [0, 0, 0]):  
plot(s, BorderWidth = 0.5*unit::mm,  
      Header = "Scaling = Constrained",  
      YXRatio = 3, ZXRatio = 10)
```

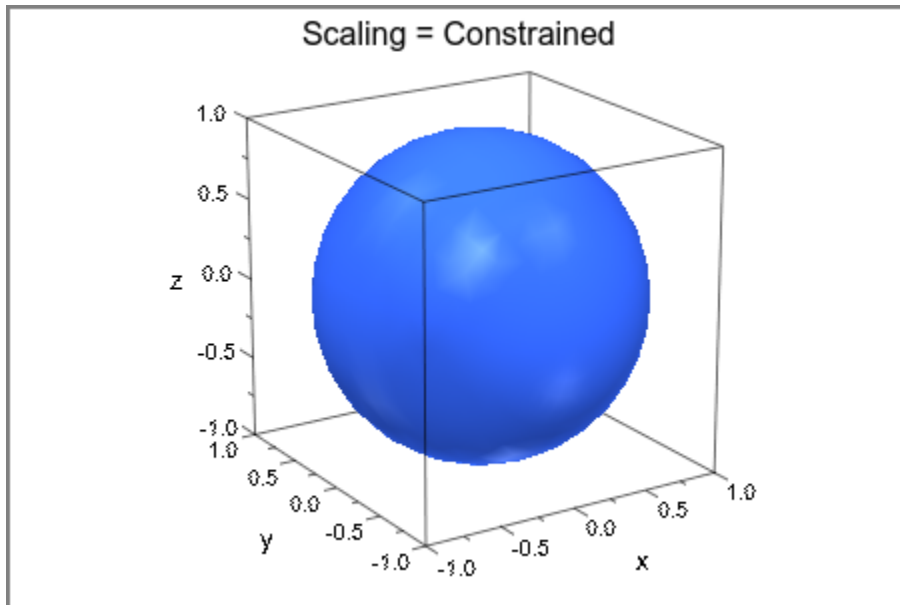

We use `Scaling = Unconstrained`. With the default values `YXRatio = 1`, `ZXRatio = 2/3`, the objects in a 3D scene are displayed like a box with side ratios  $X : Y : Z = 3 : 3 : 2$ :

```
plot(s, BorderWidth = 0.5*unit::mm,  
      Scaling = Unconstrained, Header = "X:Y:Z = 3:3:2")
```

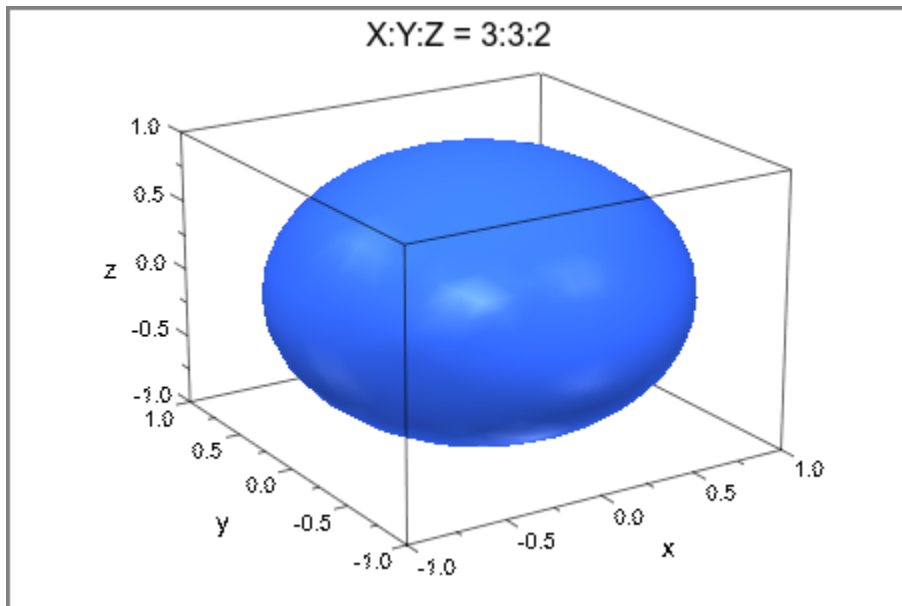

We request different scaling ratios:

```
plot(s, BorderWidth = 0.5*unit::mm, Header = "X:Y:Z = 5:5:1",  
      Scaling = Unconstrained, YXRatio = 1, ZXRatio = 1/5,  
      BorderWidth = 0.5*unit::mm)
```

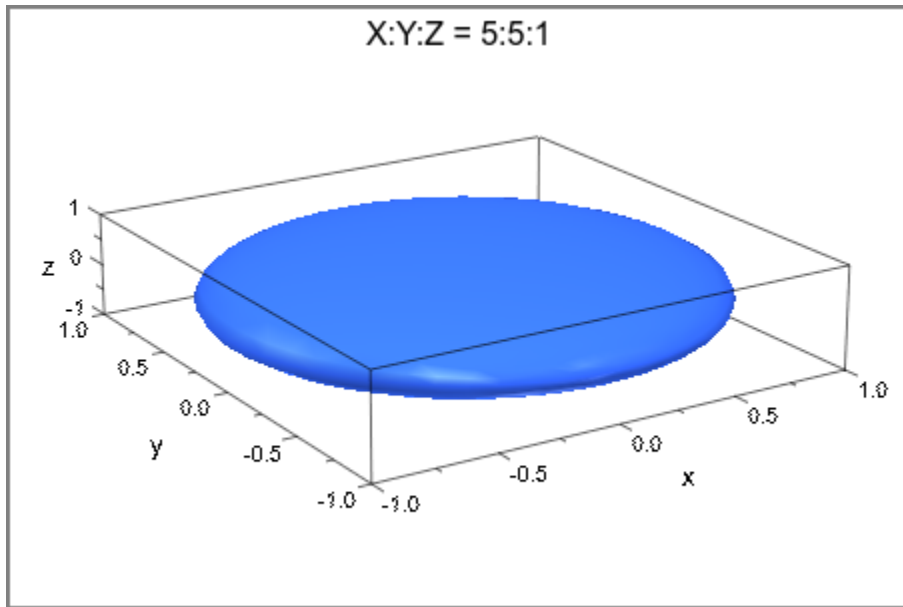

```
plot(s, BorderWidth = 0.5*unit::mm, Header = "X:Y:Z = 7:3:1",  
      Scaling = Unconstrained, YXRatio = 3/7, ZXRatio = 1/7,  
      BorderWidth = 0.5*unit::mm)
```

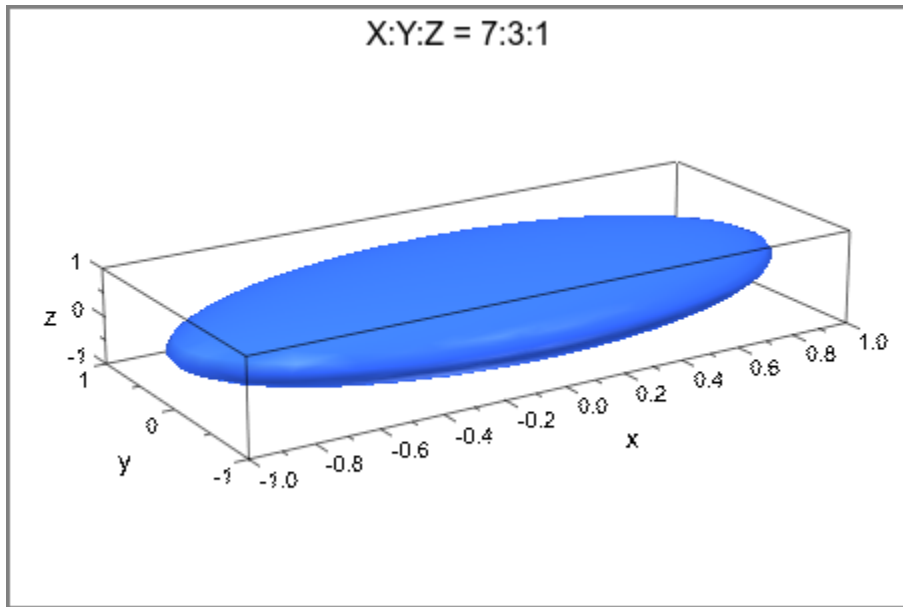

delete s:

## VerticalAsymptotesVisibleVerticalAsymptotesStyleVerticalAsymptotesColorVerticalAsymptotesWidth

Vertical asymptotes indicating poles

### Value Summary

VerticalAsymptotesVisible	Inherited	FALSE, or TRUE
VerticalAsymptotesStyle	Inherited	Dashed, Dotted, or Solid
VerticalAsymptotesColor, VerticalAsymptotesWidth	Inherited	Color

### Graphics Primitives

Objects	Default Values
plot::Function2d	VerticalAsymptotesVisible: TRUE VerticalAsymptotesStyle: Dashed VerticalAsymptotesColor: RGB::Grey50 VerticalAsymptotesWidth: 0.2

### Description

These options control the appearance of vertical asymptotes in 2D function plots.

`plot::Function2d` and `plotfunc2d` are able to indicate poles by drawing vertical asymptotes. These asymptotes can be switched off with `VerticalAsymptotesVisible = FALSE`. Other than that, the attributes `VerticalAsymptotesStyle`, `VerticalAsymptotesColor`, and `VerticalAsymptotesWidth` influence their appearance, in the same way `LineStyle`, `LineColor`, and `LineWidth` do for other lines.

## Examples

### Example 1

By default, vertical asymptotes are drawn as dashed, gray lines:

```
plotfunc2d(tan(x))
```

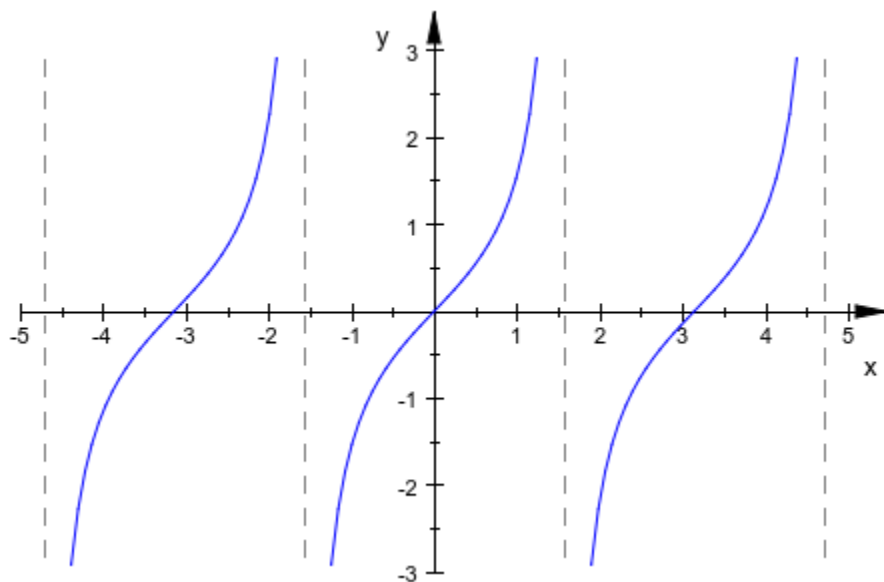

The attributes mentioned above can be used to change these settings:

```
plotfunc2d(tan(x),  
           VerticalAsymptotesColor = RGB::Blue,
```

```
VerticalAsymptotesWidth = 1.0*unit::mm,
VerticalAsymptotesStyle = Dotted)
```

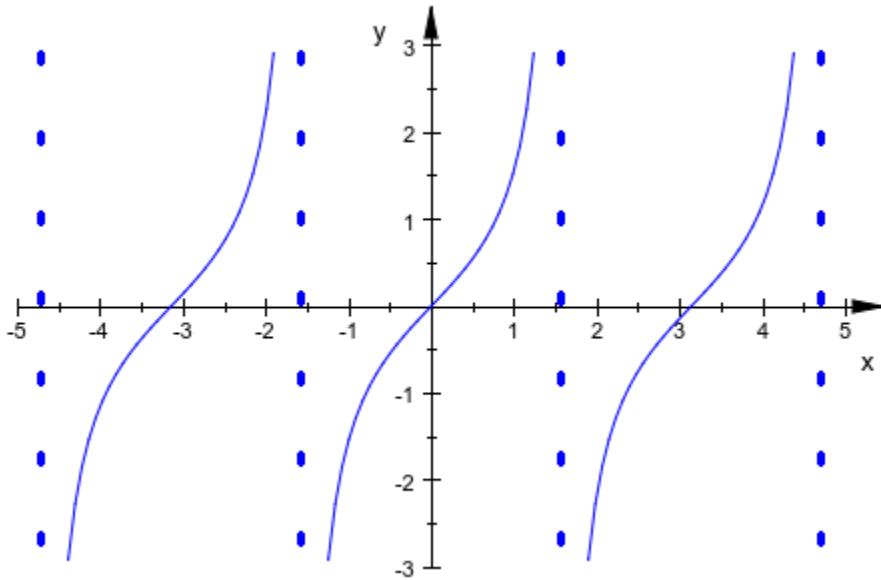

## Example 2

Note that vertical asymptotes obey the setting of `Visible` of their function object: No asymptotes are drawn for an invisible object.

```
t := plot::Function2d(tan(x), x = -2*PI..2*PI, Visible = FALSE):
s := plot::Function2d(sin(x), x = -2*PI..2*PI):
plot(s, t)
```



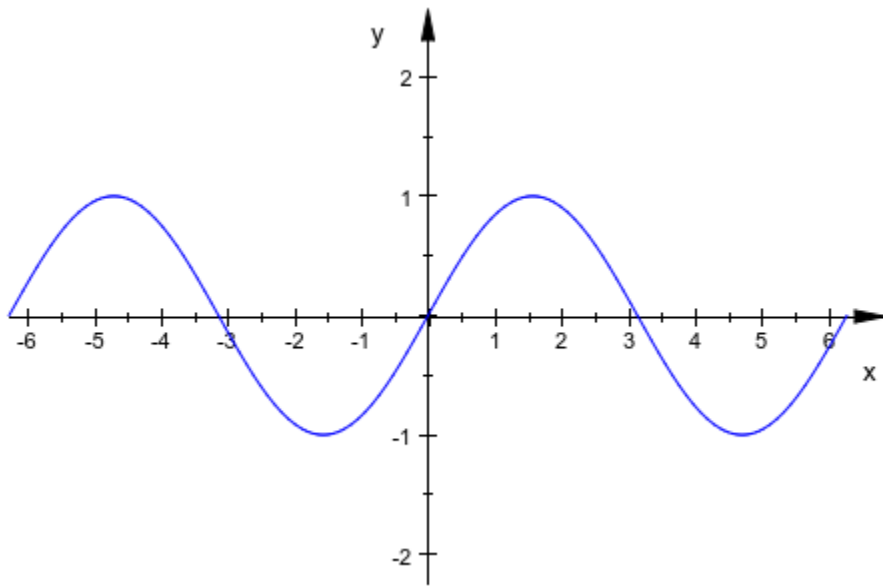

To have `t` show its asymptotes, we must set `Visible` to `TRUE`. If we only want to see the asymptotes, we can set `LinesVisible` to `FALSE`:

```
t::Visible := TRUE:  
t::LinesVisible := FALSE:  
plot(s, t)
```

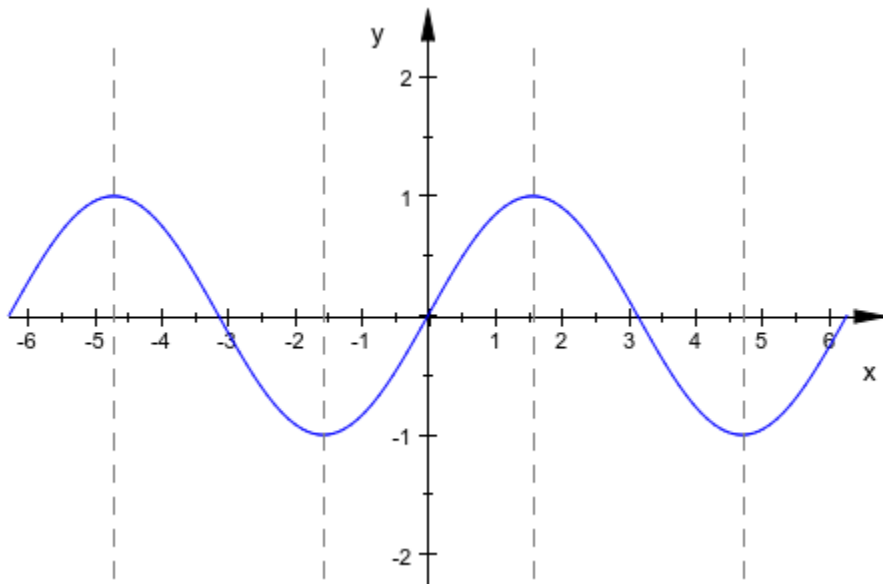

## See Also

### MuPAD Functions

[LineColor](#) | [LineStyle](#) | [LineWidth](#)

# LineColorLineColor2

Color of lines

## Value Summary

LineColor, LineColor2	Inherited	Color
-----------------------	-----------	-------

## Graphics Primitives

Objects	Default Values
plot::Bars2d, plot::Histogram2d, plot::Piechart2d	LineColor: RGB::Black
plot::Cylindrical, plot::Dodecahedron, plot::Function3d, plot::Hexahedron, plot::Icosahedron, plot::Matrixplot, plot::Octahedron, plot::Prism, plot::Pyramid, plot::Spherical, plot::Surface, plot::SurfaceSet, plot::SurfaceSTL, plot::Sweep, plot::Tetrahedron, plot::Tube, plot::XRotate, plot::ZRotate	LineColor: RGB::Black. [0.25] LineColor2: RGB::DeepPink
plot::Arc2d, plot::Arrow2d, plot::Arrow3d, plot::Circle2d, plot::Circle3d, plot::Density, plot::Ellipse2d, plot::Inequality, plot::Line2d, plot::Line3d, plot::Lsys, plot::Parallelogram2d, plot::Raster, plot::Rectangle, plot::Rootlocus, plot::Turtle	LineColor: RGB::Blue

Objects	Default Values
plot::Arc3d, plot::Conformal, plot::Curve2d, plot::Curve3d, plot::Ellipse3d, plot::Function2d, plot::Implicit2d, plot::Listplot, plot::Polar, plot::Polygon2d, plot::Polygon3d, plot::Sequence, plot::Sum, plot::VectorField2d, plot::VectorField3d	LineColor: RGB::Blue  LineColor2: RGB::DeepPink
plot::Bars3d, plot::Box, plot::Cone, plot::Cylinder, plot::Parallelogram3d, plot::Piechart3d, plot::Plane	LineColor: RGB::Black.[0.25]
plot::QQplot, plot::Scatterplot	LineColor: RGB::Red
plot::Iteration	LineColor: RGB::Grey50
plot::Implicit3d	LineColor: RGB::Black.[0.15]  LineColor2: RGB::DeepPink
plot::Waterman	LineColor: RGB::Grey40.[0.4]  LineColor2: RGB::DeepPink
plot::Streamlines2d	LineColor: RGB::Black  LineColor2: RGB::DeepPink
plot::Integral	LineColor: RGB::Black  LineColor2: RGB::Grey

## Description

LineColor sets the color of line objects such as 2D function graphs, curves in 2D and 3D, parameter lines on surfaces etc.

LineColor2 is a secondary color used for color blends.

`LineColor` determines the RGB color of line objects. The RGB library provides many pre-defined colors such as `RGB::Red` etc. See the section Colors (Symbolic Math Toolbox) of this document for more information on colors.

For pure line objects such as lines on page 24-435, curves on page 24-217, arrows on page 24-217, 2D function graphs on page 24-295 etc., the line color can also be set by the attribute `Color`.

For surface objects such as 3D function graphs on page 24-315, surfaces on page 24-803 etc., however, the attribute `Color` sets the `FillColor`. If you wish to change the color of the parameter lines on a surface, you have to use `LineColor`.

The RGB color set by `LineColor` cannot be animated. However, setting `LineColorType = Functional`, you can define a `LineColorFunction` that overrides the color set by `LineColor`. The line color function accepts an animation parameter, thus allowing to implement animated coloring of lines. See the help page of `LineColorFunction` for further details.

When the attribute `LineColorType` is set to one of the values `Dichromatic` or `Rainbow`, many line objects react to a secondary color set by the attribute `LineColor2`.

A gradient between the colors defined by `LineColor` and `LineColor2` is created.

The color of the coordinate axes is set by the attribute `AxesLineColor`.

## Examples

### Example 1

We draw arrows of different colors:

```
plot(plot::Arrow2d([0, 0], [1, 2], LineColor = RGB::Red),  
      plot::Arrow2d([0, 0], [1, 1], LineColor = RGB::Green),  
      plot::Arrow2d([0, 0], [2, 1], LineColor = RGB::Blue)):
```

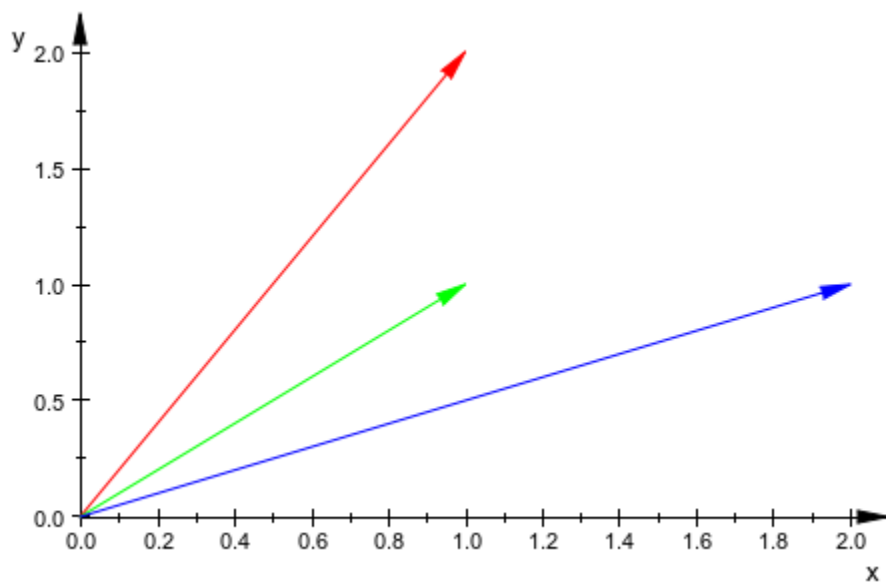

## Example 2

We draw a parabola with a gradient between green and blue:

```
plot(plot::Function2d(x^2, x = 1..10,  
  LineColorType = Dichromatic,  
  LineColor = RGB::Green,  
  LineColor2 = RGB::Blue)):
```

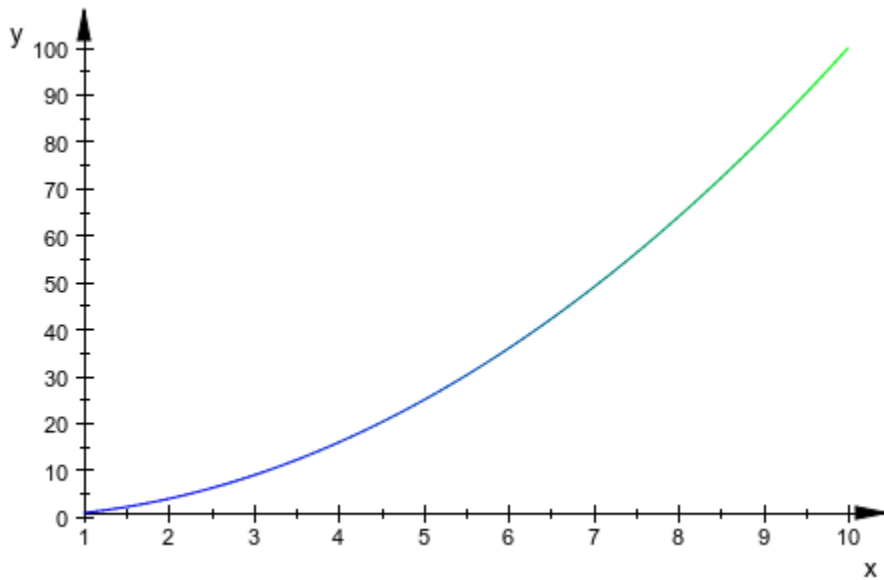

### Example 3

As with any attribute, the line color can be read and changed using the `::`-notation:

```
p := plot::Line2d([1, 2], [4, 5]):  
p::LineColor := RGB::Blue
```

```
[0.0, 0.0, 1.0]
```

```
p::LineColor
```

```
[0.0, 0.0, 1.0]
```

```
delete p:
```

## Example 4

For surface objects such as 3D function graphs, `LineColor` sets the color of the parameter lines on the surface. Here, a semi-transparent RGBa (Symbolic Math Toolbox) color is chosen that gives only a faint indication of these lines:

```
plot(plot::Function3d(x^2 + y^2, x = -1..1, y = -1 ..1,  
    LineColor = RGB::Green.[0.25])):
```

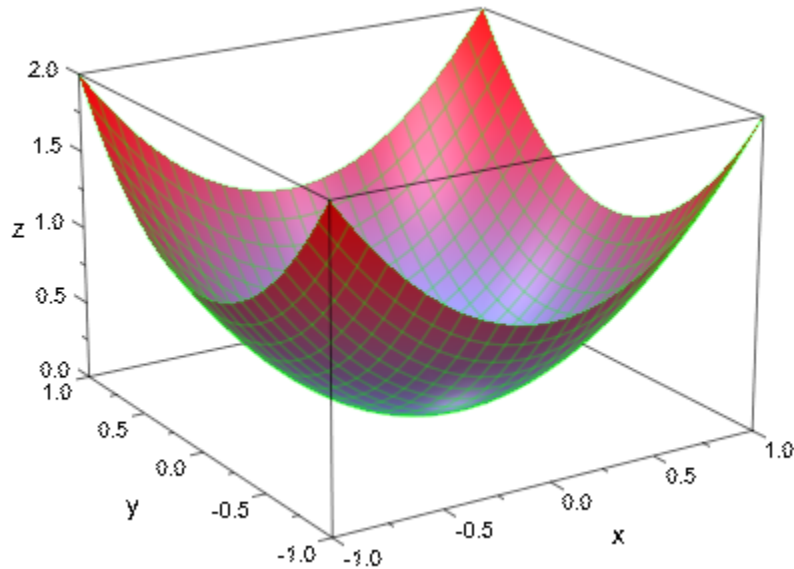

## See Also

### MuPAD Functions

`AxesLineColor` | `LineColorFunction` | `LineColorType` | `LineStyle` | `LineWidth` | `LinesVisible`



# LineColorDirectionLineColorDirectionXLineColorDirectionYLineColorDirectionZ

Direction of color transitions on lines

## Value Summary

LineColorDirection	Library wrapper for "[LineColorDirectionX, LineColorDirectionY]" (2D), "[LineColorDirectionX, LineColorDirectionY, LineColorDirectionZ]" (3D)	See below
LineColorDirectionX, LineColorDirectionY, LineColorDirectionZ	Inherited	Real number

## Graphics Primitives

Objects	Default Values
plot::Arc3d, plot::Circle3d, plot::Curve3d, plot::Cylindrical, plot::Dodecahedron, plot::Ellipse3d, plot::Function3d, plot::Hexahedron, plot::Icosahedron, plot::Implicit3d, plot::Matrixplot, plot::Octahedron, plot::Polygon3d, plot::Prism, plot::Pyramid, plot::Spherical, plot::Surface, plot::SurfaceSet, plot::SurfaceSTL, plot::Sweep, plot::Tetrahedron, plot::Tube, plot::VectorField3d, plot::XRotate, plot::ZRotate	LineColorDirection: [0, 0, 1]  LineColorDirectionX, LineColorDirectionY: 0  LineColorDirectionZ: 1
plot::Arrow2d, plot::Circle2d, plot::Conformal, plot::Curve2d, plot::Ellipse2d, plot::Function2d, plot::Implicit2d, plot::Polar, plot::Polygon2d, plot::Rectangle, plot::Sum, plot::VectorField2d	LineColorDirection: [0, 1]  LineColorDirectionX: 0  LineColorDirectionY: 1
plot::Arrow3d, plot::Box, plot::Cone	LineColorDirection: [0, 0, 1]  LineColorDirectionX, LineColorDirectionY: 0
plot::Listplot	LineColorDirection: [0, 1]  LineColorDirectionX: 0  LineColorDirectionY, LineColorDirectionZ: 1

Objects	Default Values
plot::Waterman	LineColorDirection: [0, 1, 1] LineColorDirectionX: 0 LineColorDirectionY, LineColorDirectionZ: 1

## Description

LineColorDirection determines the direction in which the color transitions for LineColorType = Dichromatic etc. take place.

When setting LineColorType to some other value than Flat or Functional, MuPAD produces a "height-coloring." By default, this color method actually uses the height of a point. Using LineColorDirection, the axis along which the color method should be applied can be changed.

## Examples

### Example 1

By default, MuPAD uses height coloring along the y axis for 2D objects:

```
f := plot::Function2d(sin(x), x=-PI..PI,
                      LineWidth = 1, LineColorType = Rainbow):
plot(f)
```

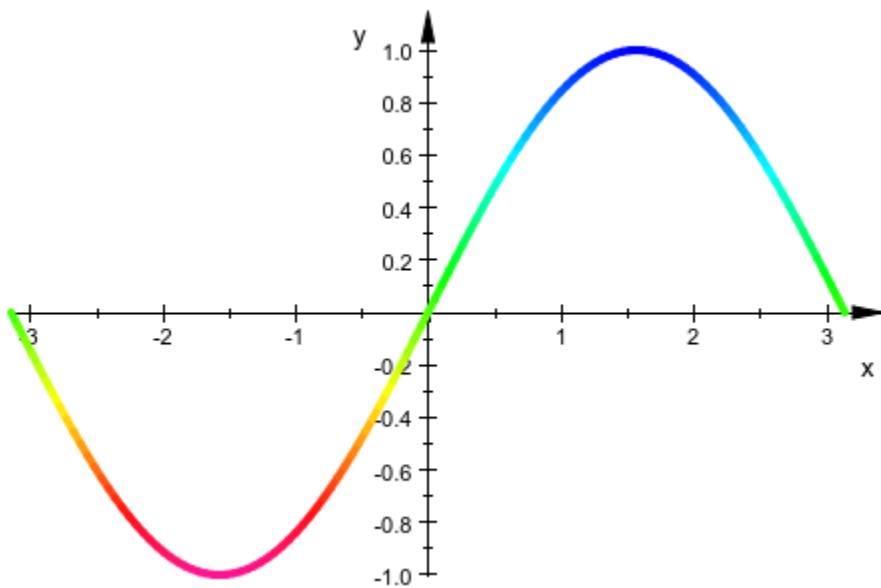

By changing `LineColorDirection`, this direction can be set to any angle. Note that `LineColorDirection` is an inherited attribute and may therefore be set at “top level” in the plot call:

```
plot(f, LineColorDirection = [1, 1])
```

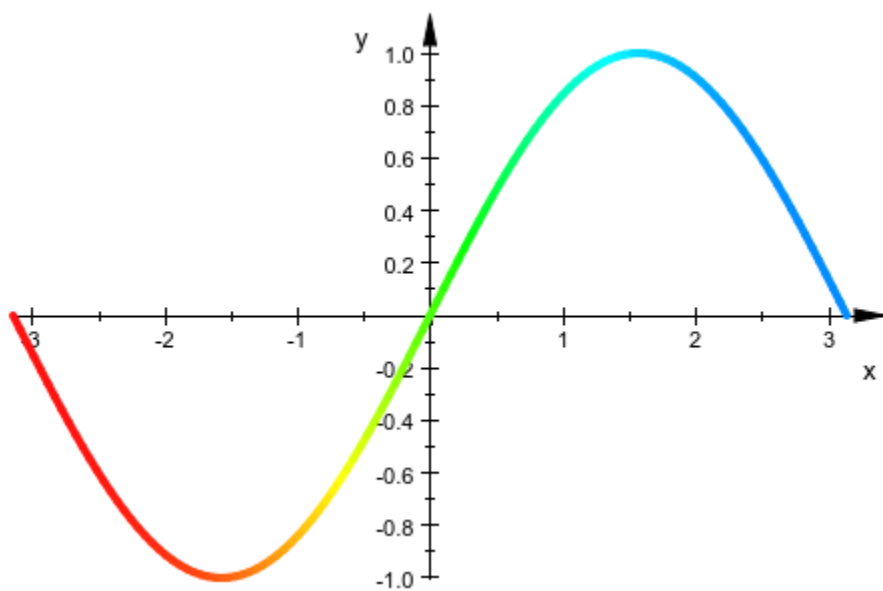

## See Also

### MuPAD Functions

[FillColorDirection](#) | [LineColor](#) | [LineColor2](#) | [LineColorType](#)

## LineColorType

Line coloring types

### Value Summary

Inherited	Dichromatic, Flat, Functional, Monochrome, or Rainbow
-----------	---

### Graphics Primitives

Objects	LineColorType Default Values
plot::Arc3d, plot::Conformal, plot::Curve2d, plot::Curve3d, plot::Cylindrical, plot::Dodecahedron, plot::Ellipse3d, plot::Function2d, plot::Function3d, plot::Hexahedron, plot::Icosahedron, plot::Implicit2d, plot::Implicit3d, plot::Integral, plot::Listplot, plot::Matrixplot, plot::Octahedron, plot::Polar, plot::Polygon2d, plot::Polygon3d, plot::Prism, plot::Pyramid, plot::Rootlocus, plot::Sequence, plot::Spherical, plot::Streamlines2d, plot::Sum, plot::Surface, plot::SurfaceSet, plot::SurfaceSTL, plot::Sweep, plot::Tetrahedron, plot::Tube, plot::VectorField2d, plot::VectorField3d, plot::Waterman, plot::XRotate, plot::ZRotate	Flat

## Description

LineColorType controls the type of line coloring used. With the exception of Flat and Functional, the coloring schemes depend on the height, i.e., the z or y value (in 2D or 3D, respectively) of points on the line, relative to the extension of the viewing box.

By default, lines are drawn in the color set by the attribute LineColor. This is caused by the setting LineColorType = Flat. The other possible values for LineColorType mean:

- Dichromatic

The color of a point on a line depends on its height, with the lowest point using LineColor2, the highest one using LineColor, and all other points using a linear interpolation in RGB color space.

- Flat

The line is drawn with LineColor. No blend is used.

- Monochrome

The line is drawn with a blend from LineColor to a dimmed version of LineColor.

- Rainbow

This setting is technically similar to Dichromatic, but the effect is vastly different, since interpolation takes place in HSV color space. This creates a “rainbow effect”, which mostly conforms with a physical rainbow for suitable choices of colors.

- Functional

Both LineColor and LineColor2 are ignored; the color scheme is derived from LineColorFunction. See ?LineColorFunction for details (which depend on the object type). If no color function is given, the object will be rendered with LineColorType = Flat.

## Examples

### Example 1

By default, lines are drawn in one flat color:

```
plotfunc2d(sin(x))
```

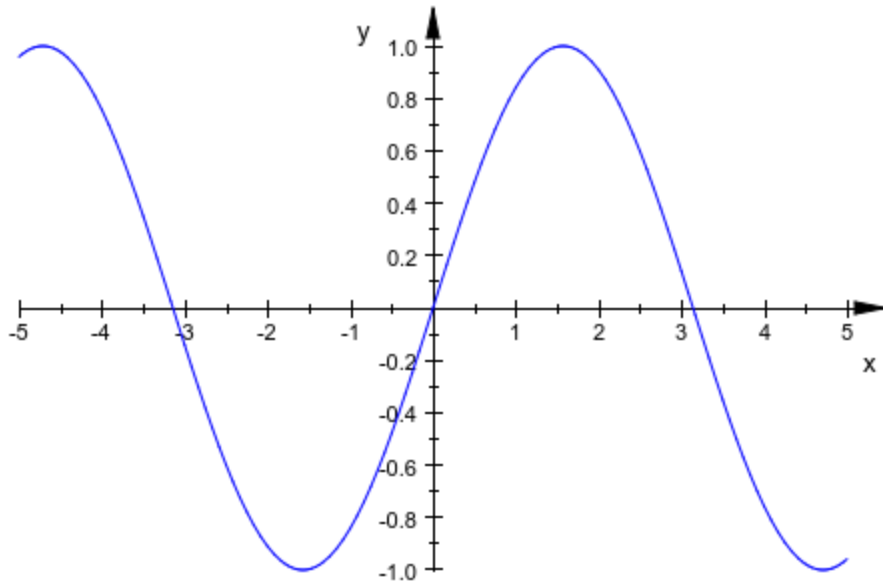

```
plot(plot::Polygon2d([[-1,-1], [1,-1], [1,1], [-1,1]],  
                    Closed = TRUE, Filled = FALSE))
```



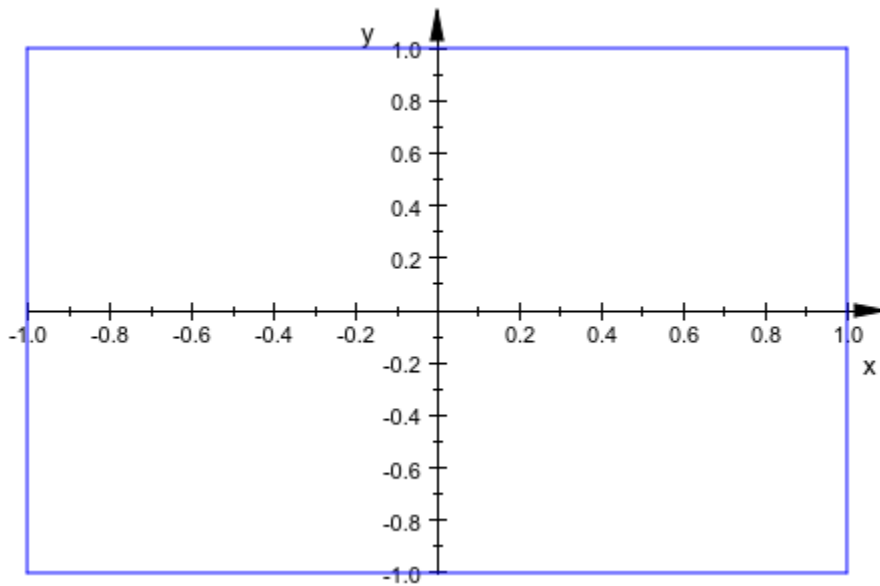

## Example 2

Using `LineColorType = Dichromatic`, `Monochrome`, or `Rainbow` causes a height-dependent color effect:

```
plotfunc2d(sin(x), LineColorType = Rainbow)
```

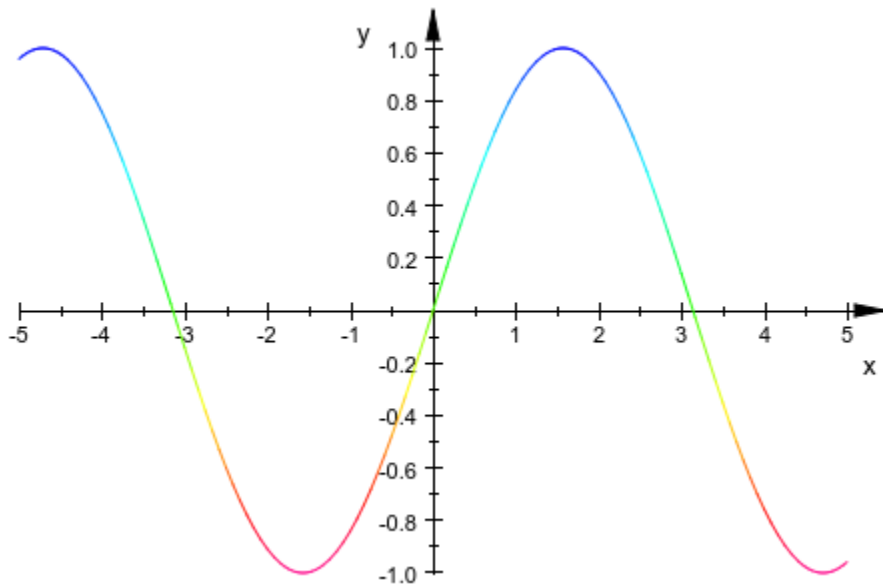

Note that height coloring depends on the height of the whole scene, not only on that of individual objects:

```
plot(  
  plot::Function2d(sin(x) + 0.2, LineColorType = Dichromatic),  
  plot::Function2d(sin(x) + 0.0, LineColorType = Monochrome),  
  plot::Function2d(sin(x) - 0.2, LineColorType = Rainbow),  
  LineColor = RGB::Red, LineColor2 = RGB::Blue  
)
```

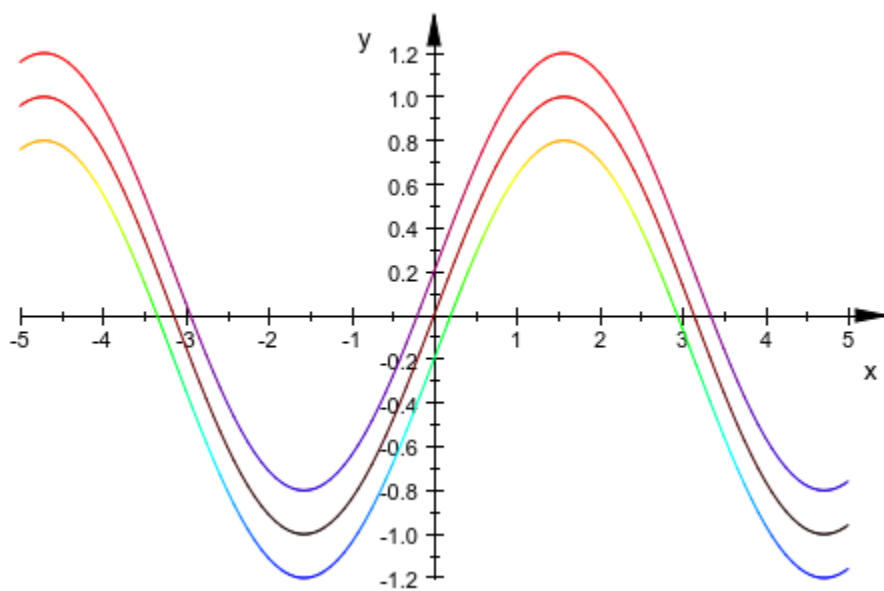

## See Also

### MuPAD Functions

[FillColorType](#) | [LineColor](#) | [LineColor2](#) | [LineColorFunction](#)

## LineStyle

Solid, dashed or dotted lines?

### Value Summary

Inherited	Dashed, Dotted, or Solid
-----------	--------------------------

## Graphics Primitives

Objects	LineStyle Default Values
plot::Arc2d, plot::Arc3d, plot::Arrow2d, plot::Arrow3d, plot::Bars2d, plot::Bars3d, plot::Box, plot::Boxplot, plot::Circle2d, plot::Circle3d, plot::Cone, plot::Conformal, plot::Curve2d, plot::Curve3d, plot::Cylinder, plot::Cylindrical, plot::Density, plot::Dodecahedron, plot::Ellipse2d, plot::Ellipse3d, plot::Function2d, plot::Function3d, plot::Hexahedron, plot::Histogram2d, plot::Icosahedron, plot::Implicit2d, plot::Implicit3d, plot::Inequality, plot::Integral, plot::Iteration, plot::Line2d, plot::Line3d, plot::Listplot, plot::Lsys, plot::Matrixplot, plot::Octahedron, plot::Ode2d, plot::Ode3d, plot::Parallelogram2d, plot::Parallelogram3d, plot::Piechart2d, plot::Piechart3d, plot::Polar, plot::Polygon2d, plot::Polygon3d, plot::Prism, plot::Pyramid, plot::QQplot, plot::Raster, plot::Rectangle, plot::Rootlocus, plot::Scatterplot, plot::Sequence, plot::Spherical, plot::Streamlines2d, plot::Sum, plot::Surface, plot::SurfaceSet, plot::SurfaceSTL, plot::Sweep, plot::Tetrahedron, plot::Turtle, plot::Waterman, plot::XRotate, plot::ZRotate	Solid

## Description

`LineStyle` controls whether lines are drawn as solid, dashed or dotted lines.

`LineStyle` sets the style of line objects such as 2D function graphs, curves in 2D and 3D, arrows, parameter lines on surfaces etc.

The available line styles are `Solid`, `Dashed`, or `Dotted`.

This attribute may be useful to distinguish different curves.

`LineStyle` does not have an effect on the line style of axes and coordinate grid on page 24-1549 lines. Axes are always displayed as solid lines. The style of the coordinate grid can be set by the attribute `GridLineStyle`.

## Examples

### Example 1

We draw a dashed parabola:

```
plot(plot::Function2d(x^2, x = -2..5, LineStyle = Dashed))
```

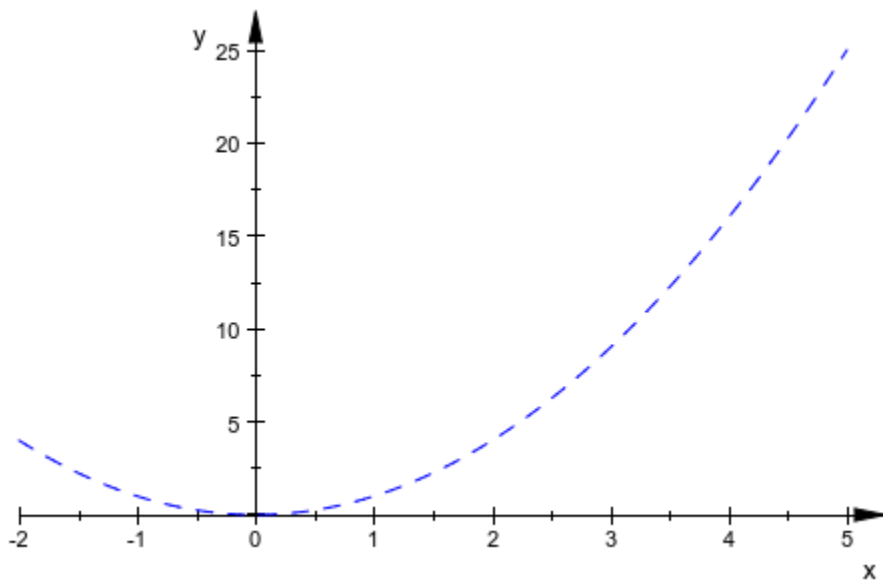

We draw a paraboloid with dashed coordinate lines:

```
plot(plot::Function3d(x^2 + y^2, x = -2..5, y = -2..5,  
  Mesh = [8, 8], Submesh = [3, 3],  
  LineStyle = Dashed))
```

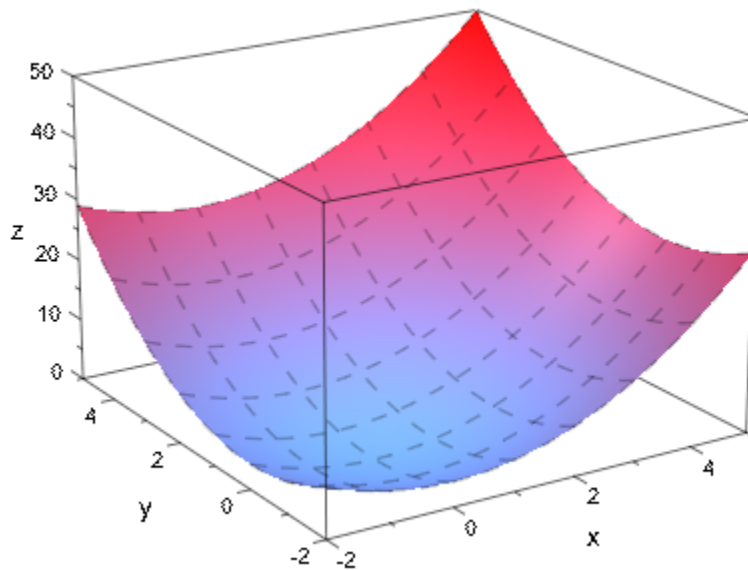

## See Also

### MuPAD Functions

[GridLineStyle](#) | [LineColor](#) | [LineColorType](#) | [LineWidth](#) | [LinesVisible](#)



# LinesVisibleULinesVisibleVLinesVisible XLinesVisibleYLinesVisible

Visibility of lines

## Value Summary

LinesVisible, ULinesVisible, VLinesVisible, XLinesVisible, YLinesVisible	Inherited	FALSE, or TRUE
--	-----------	----------------

## Graphics Primitives

Objects	Default Values
plot::Arc2d, plot::Arc3d, plot::Bars2d, plot::Bars3d, plot::Box, plot::Boxplot, plot::Circle2d, plot::Circle3d, plot::Cone, plot::Conformal, plot::Curve2d, plot::Curve3d, plot::Cylinder, plot::Dodecahedron, plot::Ellipse2d, plot::Ellipse3d, plot::Function2d, plot::Hexahedron, plot::Histogram2d, plot::Icosahedron, plot::Implicit2d, plot::Integral, plot::Listplot, plot::Lsys, plot::Ode2d, plot::Ode3d, plot::Parallelogram2d, plot::Parallelogram3d, plot::Piechart2d, plot::Piechart3d, plot::Plane, plot::Polar, plot::Polygon2d, plot::Polygon3d, plot::Prism, plot::Pyramid, plot::QQplot, plot::Rectangle, plot::Rootlocus, plot::Scatterplot, plot::Sum, plot::Tetrahedron, plot::Turtle, plot::Waterman	LinesVisible: TRUE
plot::Density, plot::Inequality, plot::Raster, plot::Sequence	LinesVisible: FALSE
plot::Function3d	LinesVisible, XLinesVisible, YLinesVisible: TRUE
plot::Cylindrical, plot::Matrixplot, plot::Spherical, plot::Surface, plot::Sweep, plot::Tube, plot::XRotate, plot::ZRotate	ULinesVisible, VLinesVisible, XLinesVisible, YLinesVisible: TRUE

## Description

`LinesVisible = TRUE` versus `LinesVisible = FALSE` governs the visibility of line objects.

`ULinesVisible`, `VLinesVisible` governs the visibility of coordinate lines on parametrized surfaces in 3D.

`XLinesVisible`, `YLinesVisible` governs the visibility of coordinate lines on 3D function graphs and matrix plots.

For most object types, `LinesVisible` determines whether lines are drawn. This includes the lines making up 2D function plots on page 24-295, curves on page 24-217, polygons on page 24-634, etc. as well as the circumference of (filled) circles on page 24-181, the edges of 2D rectangles on page 24-691 and 3D boxes on page 24-158 etc.

The exception are surface objects that exhibit parameter lines in two directions, such as 3D function plots on page 24-315, parameterized surfaces on page 24-803, tube plots on page 24-972 etc. Depending on whether they react to `XMesh`, `YMesh` or to `UMesh`, `VMesh`, the parameter lines on the surfaces can be made visible or invisible with the attributes `XLinesVisible`, `YLinesVisible` or `ULinesVisible`, `VLinesVisible`, respectively.

Note that setting `LinesVisible = FALSE` for a 2D function plot without setting `PointsVisible = TRUE` will render the function invisible. (In case of singular functions, the vertical asymptotes on page 24-1854 may remain visible, though).

The same holds true for plots involving filled areas: switching off the lines and the filling makes such objects invisible.

`LinesVisible` etc. do not have an effect on coordinate axes and coordinate grid on page 24-1549 lines. Use the attributes `AxesVisible` and `GridVisible` to control the visibility of axes and coordinate grid.

## Examples

### Example 1

By default, the lines of a box are visible:

```
plot(plot::Box(1..4, 2..5, 3..6), Axes = None)
```

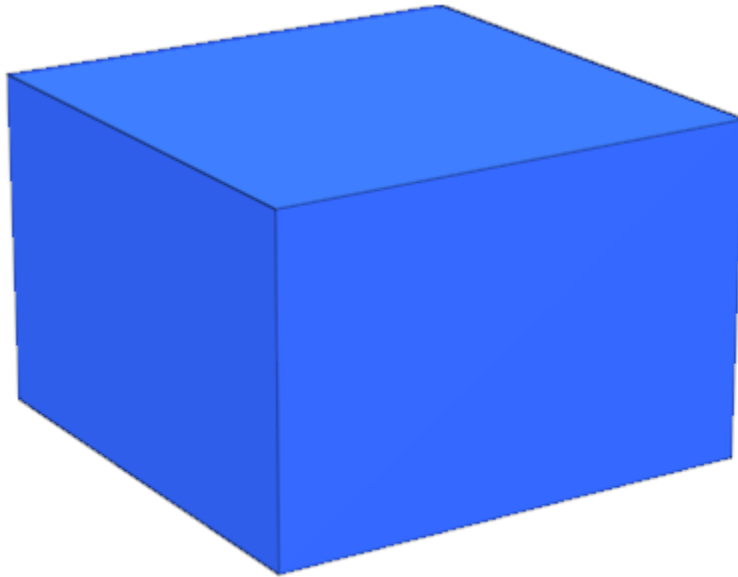

We set `LinesVisible = FALSE` to switch them off:

```
plot(plot::Box(1..4, 2..5, 3..6, LinesVisible = FALSE),  
      Axes = None)
```

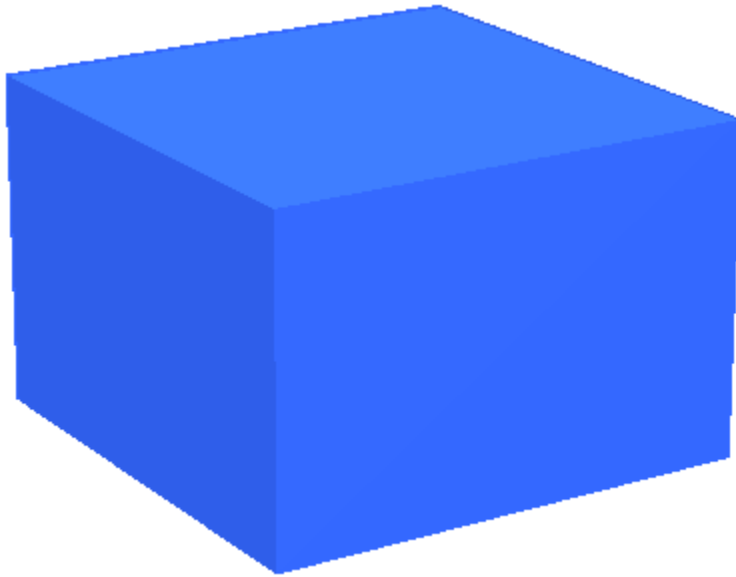

## Example 2

By default, parameter lines are drawn on a parametrized surface:

```
plot(plot::Surface([u*cos(v), u*sin(v), u^2*sin(5*v)],  
u = 0..2, v = 0..2*PI, VSubmesh = 3)):
```

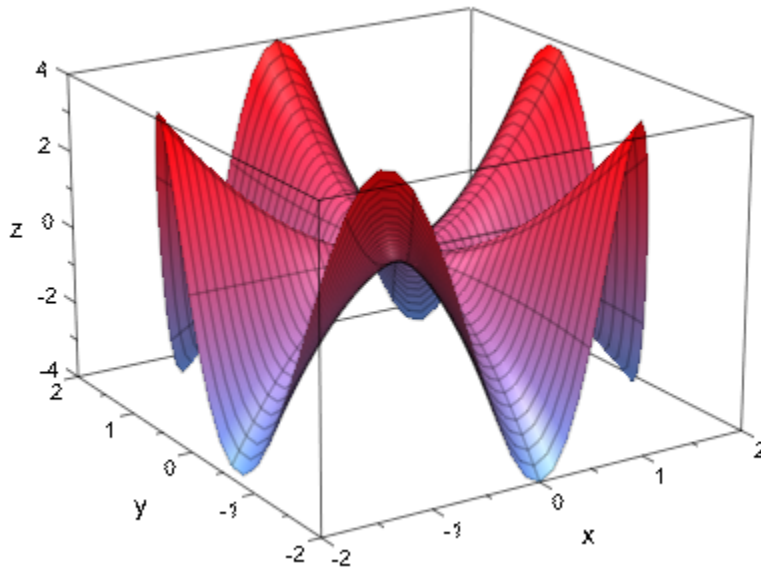

You can switch these lines off interactively, or, as we do here, by setting `ULinesVisible` and `VLinesVisible` to `FALSE` in the plot command:

```
plot(plot::Surface([u*cos(v), u*sin(v), u^2*sin(5*v)],  
  u = 0..2, v = 0..2*PI, VSubmesh = 3,  
  ULinesVisible = FALSE,  
  VLinesVisible = FALSE)):
```

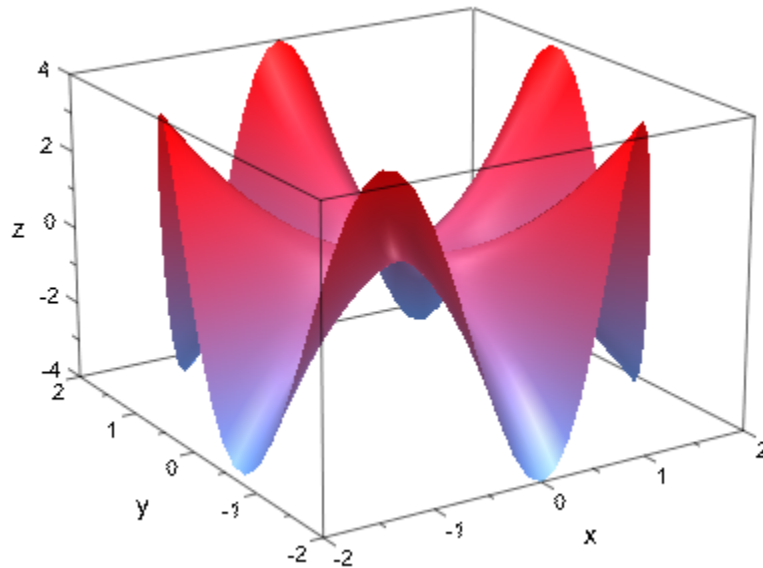

When the surface is created with an adaptive mesh on page 24-1684, we can make the irregular adaptive mesh visible by setting `MeshVisible = TRUE`:

```
plot(plot::Surface([u*cos(v), u*sin(v), u^2*sin(5*v)],  
  u = 0..2, v = 0..2*PI,  
  UMesh = 5, VMesh = 10,  
  ULinesVisible = FALSE,  
  VLinesVisible = FALSE,  
  AdaptiveMesh = 3,  
  MeshVisible = TRUE)):
```

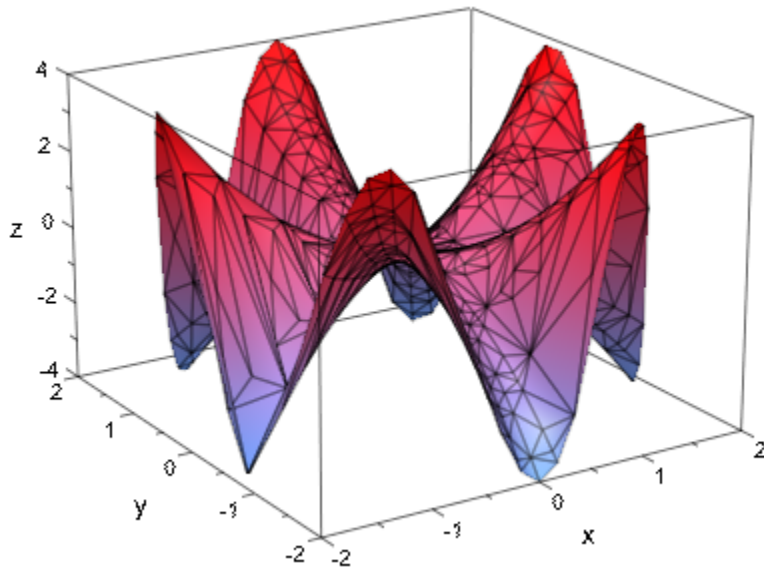

### Example 3

We plot a dodecahedron with and without the border lines of its faces:

```
plot(plot::Scene3d(plot::Dodecahedron(LinesVisible = TRUE)),  
      plot::Scene3d(plot::Dodecahedron(LinesVisible = FALSE)),  
      Layout = Horizontal, Axes = None):
```



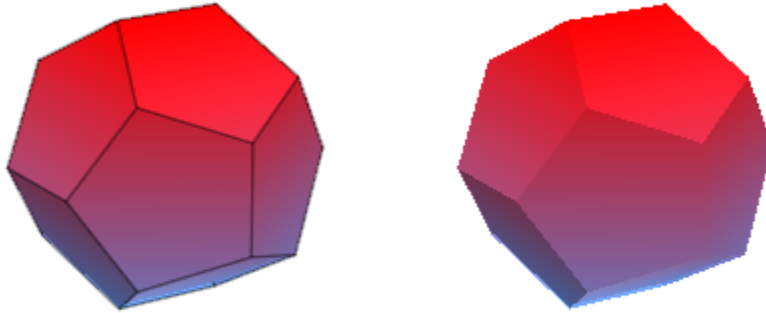

## See Also

### MuPAD Functions

[AxesVisible](#) | [GridVisible](#) | [LineColor](#) | [LineColorType](#) | [LineStyle](#) | [LineWidth](#)

## LineWidth

Width of lines

### Value Summary

Inherited	Positive output size
-----------	----------------------

## Graphics Primitives

Objects	LineWidth Default Values
plot::Arc2d, plot::Arc3d, plot::Arrow2d, plot::Arrow3d, plot::Bars2d, plot::Bars3d, plot::Box, plot::Boxplot, plot::Circle2d, plot::Circle3d, plot::Cone, plot::Conformal, plot::Curve2d, plot::Curve3d, plot::Cylinder, plot::Cylindrical, plot::Density, plot::Dodecahedron, plot::Ellipse2d, plot::Ellipse3d, plot::Function2d, plot::Function3d, plot::Hexahedron, plot::Histogram2d, plot::Icosahedron, plot::Implicit2d, plot::Implicit3d, plot::Inequality, plot::Integral, plot::Iteration, plot::Line2d, plot::Line3d, plot::Listplot, plot::Lsys, plot::Matrixplot, plot::Octahedron, plot::Ode2d, plot::Ode3d, plot::Parallelogram2d, plot::Parallelogram3d, plot::Piechart2d, plot::Piechart3d, plot::Polar, plot::Polygon2d, plot::Polygon3d, plot::Prism, plot::Pyramid, plot::QQplot, plot::Raster, plot::Rectangle, plot::Rootlocus, plot::Scatterplot, plot::Sequence, plot::Spherical, plot::Sum, plot::Surface, plot::SurfaceSet, plot::SurfaceSTL, plot::Sweep, plot::Tetrahedron, plot::Tube, plot::Turtle, plot::VectorField2d, plot::XRotate, plot::ZRotate	0.35

Objects	LineWidth Default Values
plot::VectorField3d	0.1
plot::Waterman	0.25
plot::Streamlines2d	0.35*unit::mm

## Description

LineWidth sets the width of line objects such as 2D function graphs, curves in 2D and 3D, arrows, parameter lines on surfaces etc.

The value should be specified as an absolute physical length including a length unit on page 1-2196 such as `LineWidth = 1.5*unit::mm`. Numbers without a physical unit give the size in mm.

Note that the graphics cannot always react to small changes of the line width because of the discretization into pixels.

One cannot make lines invisible by setting their width to 0. Use `LinesVisible = FALSE` instead.

LineWidth does not have an effect on the line width of axes and coordinate grid on page 24-1549 lines. Use the attributes `AxesLineWidth` and `GridLineWidth` to manipulate axes and coordinate grid, respectively.

## Examples

### Example 1

We draw a house with thick walls:

```
plot(plot::Polygon2d(
  [[0, 0], [0, 3], [2, 5], [4, 3], [0, 3],
   [4, 0], [0, 0], [4, 3], [4, 0] ],
  LineWidth = 4*unit::mm, Color = RGB::Grey),
  Axes = None):
```



The building instructions are added by arrows. The drawing order is indicated by the titles of the arrows and their increasing line width:

```
plot(plot::Polygon2d(
  [[0, 0], [0, 3], [2, 5], [4, 3], [0, 3],
   [4, 0], [0, 0], [4, 3], [4, 0] ],
  LineWidth = 4*unit::mm, Color = RGB::Grey),
plot::Arrow2d([0, 0], [0, 3], LineWidth = 0.3*unit::mm,
  Title = "1", TitlePosition = [0.2, 1.4]),
plot::Arrow2d([0, 3], [2, 5], LineWidth = 0.5*unit::mm,
  Title = "2", TitlePosition = [0.5, 3.9]),
plot::Arrow2d([2, 5], [4, 3], LineWidth = 0.7*unit::mm,
  Title = "3", TitlePosition = [3.4, 3.9]),
plot::Arrow2d([4, 3], [0, 3], LineWidth = 0.9*unit::mm,
  Title = "4", TitlePosition = [1.9, 3.2]),
plot::Arrow2d([0, 3], [4, 0], LineWidth = 1.1*unit::mm,
  Title = "5", TitlePosition = [1.0, 2.5]),
plot::Arrow2d([4, 0], [0, 0], LineWidth = 1.3*unit::mm,
  Title = "6", TitlePosition = [1.9, 0.2]),
plot::Arrow2d([0, 0], [4, 3], LineWidth = 1.5*unit::mm,
  Title = "7", TitlePosition = [0.7, 0.9]),
plot::Arrow2d([4, 3], [4, 0], LineWidth = 1.7*unit::mm,
```

```
Title = "8", TitlePosition = [3.7, 1.4]),  
Axes = None,  
TipLength = 5*unit::mm  
):
```

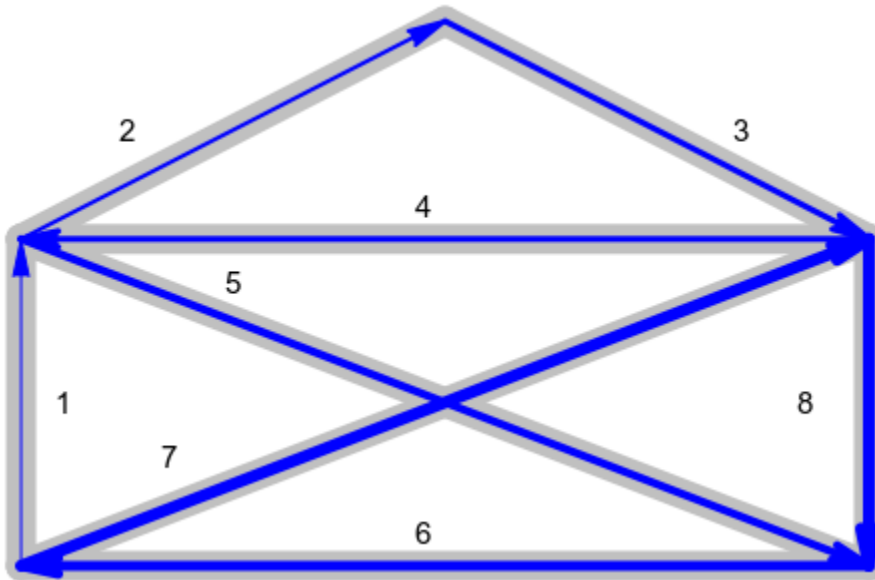

## See Also

### MuPAD Functions

AxesLineWidth | GridLineWidth | LineColor | LineColorType | LineStyle |  
LinesVisible

# MeshVisible

Visibility of irregular mesh lines in 3D

## Value Summary

Inherited	FALSE, or TRUE
-----------	----------------

## Graphics Primitives

Objects	MeshVisible Default Values
<code>plot::Cylindrical</code> , <code>plot::Function3d</code> , <code>plot::Implicit3d</code> , <code>plot::Spherical</code> , <code>plot::Surface</code> , <code>plot::SurfaceSet</code> , <code>plot::SurfaceSTL</code> , <code>plot::XRotate</code> , <code>plot::ZRotate</code>	FALSE

## Description

`MeshVisible = TRUE` versus `MeshVisible = FALSE` controls the visibility of the irregular mesh defining surfaces that are either computed by an adaptive algorithm or are given explicitly by a triangulation.

3D function plots on page 24-315 and parametrized surfaces on page 24-803 are usually defined over a regular mesh. When setting `AdaptiveMesh = n` with  $n > 0$ , an irregular adaptive mesh is created that refines the graphical object automatically in critical regions.

While visibility of the regular mesh is controlled by the attributes `XLinesVisible`, `YLinesVisible` or `ULinesVisible`, `VLinesVisible`, respectively, the visibility of the adaptively refined mesh is set `MeshVisible`.

Also special surfaces created from a given triangulation such as `plot::SurfaceSet` and `plot::SurfaceSTL` allow to make the triangulation visible by setting `MeshVisible = TRUE`.

The irregular mesh lines switched on by `MeshVisible = TRUE` react to the attributes `LineColor`, `LineStyle`, and `LineWidth`.

## Examples

### Example 1

We create a 3D function plot:

```
plot(plot::Function3d(sin(x*y), x = -3..3, y = -3..3))
```

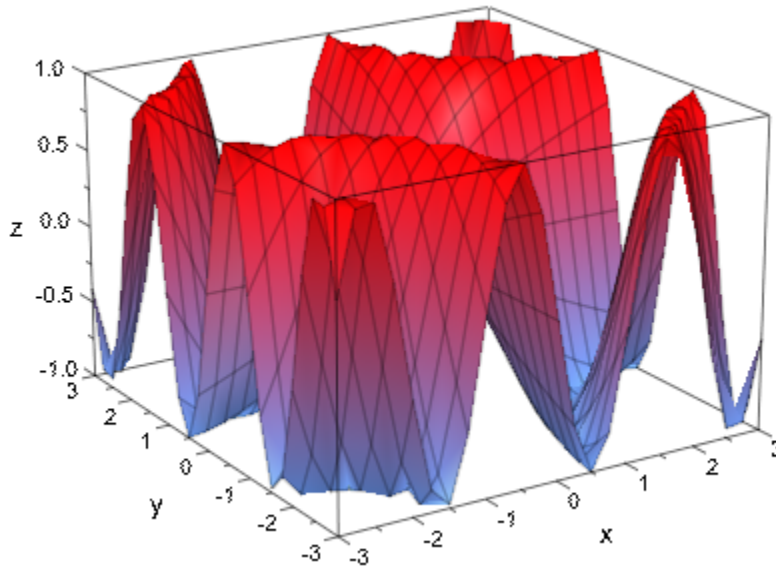

By default, only the regular mesh is visible, even if adaptive evaluation is used:

```
plot(plot::Function3d(sin(x*y), x = -3..3, y = -3..3,  
AdaptiveMesh = 2))
```



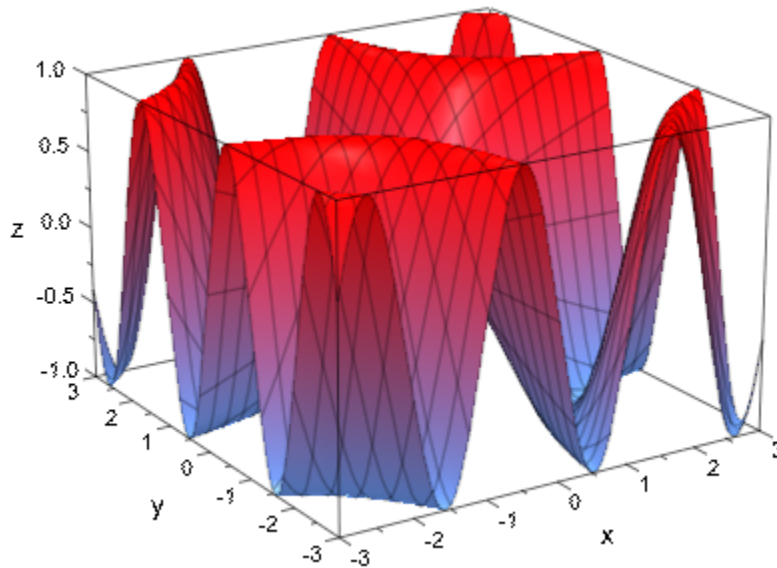

The irregular mesh is made visible when using `MeshVisible = TRUE`:

```
plot(plot::Function3d(sin(x*y), x = -3..3, y = -3..3,  
      AdaptiveMesh = 2, MeshVisible = TRUE))
```

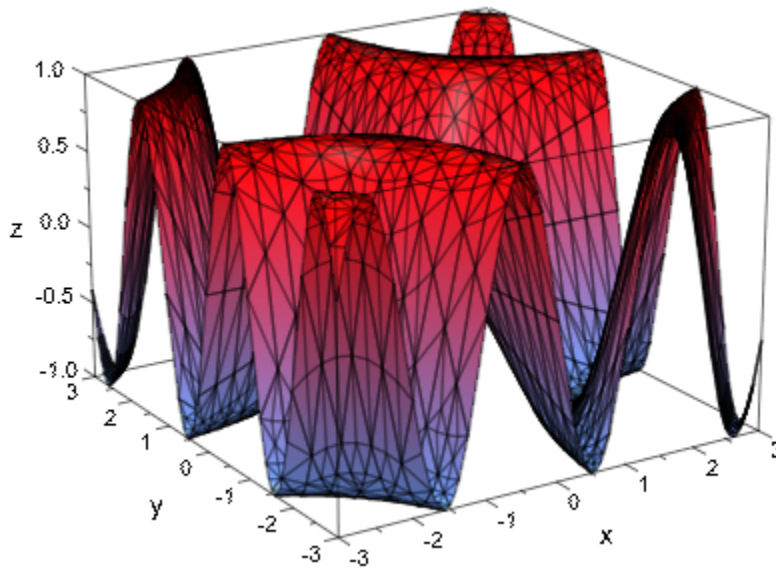

A 3D plot of an implicit surface does not have regular mesh lines. We plot such a surface with and without the irregular mesh:

```
plot(plot::Implicit3d(z^4 + z^2 - x^2 + y^3,  
                    x = -1..1, y = -1..1, z = -1..1,  
                    MeshVisible = TRUE))
```

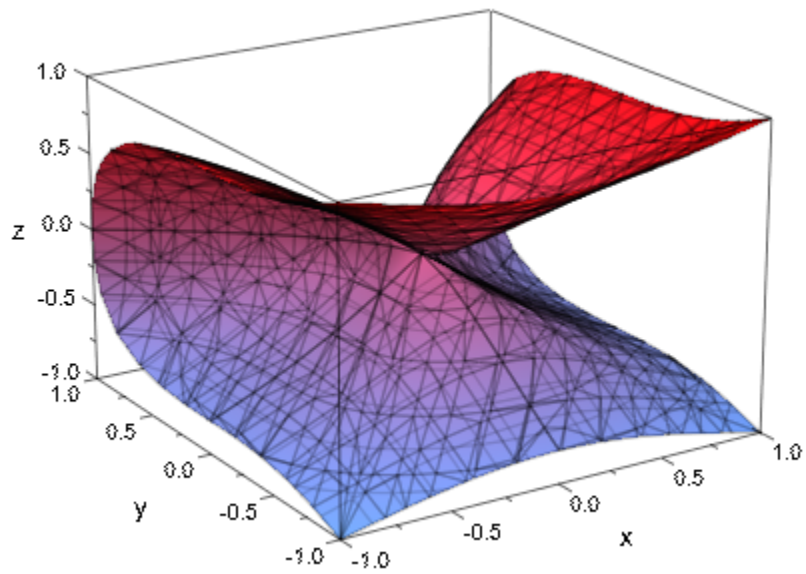

```
plot(plot::Implicit3d(z^4 + z^2 - x^2 + y^3,  
  x = -1..1, y = -1..1, z = -1..1,  
  MeshVisible = FALSE))
```

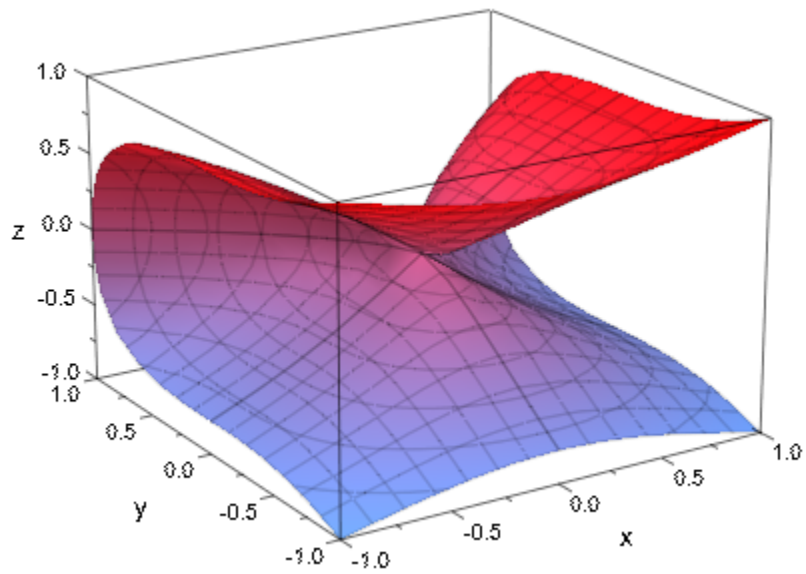

## See Also

### MuPAD Functions

[AdaptiveMesh](#) | [LineColor](#) | [LineStyle](#) | [LineWidth](#)

# XContoursYContoursZContours

Contour lines at constant x values

## Value Summary

XContours, YContours, ZContours	Optional	List of arithmetical expressions
---------------------------------	----------	----------------------------------

## Graphics Primitives

Objects	Default Values
plot::Implicit3d	XContours, YContours, ZContours: [Automatic, 15]
plot::Cylindrical, plot::Function3d, plot::Spherical, plot::Surface, plot::XRotate, plot::ZRotate	XContours, YContours, ZContours: []

## Description

XContours, YContours, and ZContours cause contour lines on surface objects at constant x, y, or z-values, respectively.

By setting these attributes, many surface objects (such as implicit surfaces, function objects etc.) can be instructed to display contour lines.

By setting `ZContours = [z1, z2, ...]`, contour lines can be requested at specific places. This is demonstrated in “Example 1” on page 24-1902 (Symbolic Math Toolbox).

`ZContours = [Automatic, n]` causes *n* contour lines to be evenly spaced along the range of *z* values of the object. Cf. “Example 2” on page 24-1903 (Symbolic Math Toolbox).

## Examples

### Example 1

A function plot by default uses height coloring and mesh lines to improve the visual display. With mesh lines disabled, height coloring is often still sufficient:

```
plotfunc3d(sin(x+cos(0.3*y))*cos(y),  
           XLinesVisible=FALSE, YLinesVisible=FALSE,  
           CameraDirection=[0,0.01,1])
```

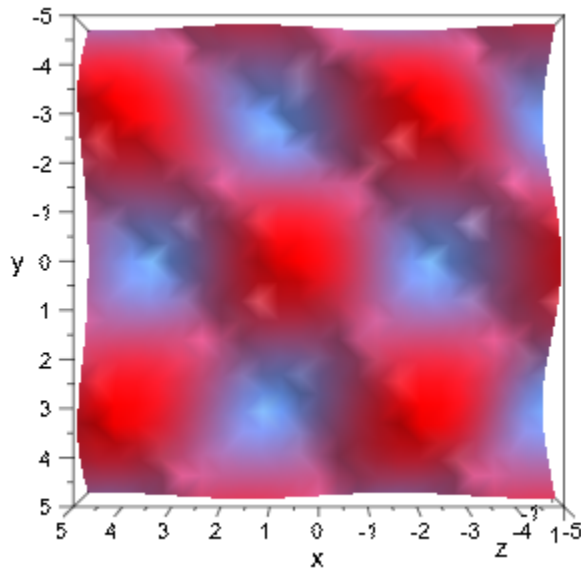

To get a better depth impression, it would help in this example to add contour lines:

```
plotfunc3d(sin(x+cos(0.3*y))*cos(y),  
           ZContours=[$ -1..1 step 0.25],  
           XLinesVisible=FALSE, YLinesVisible=FALSE,  
           CameraDirection=[0,0.01,1])
```

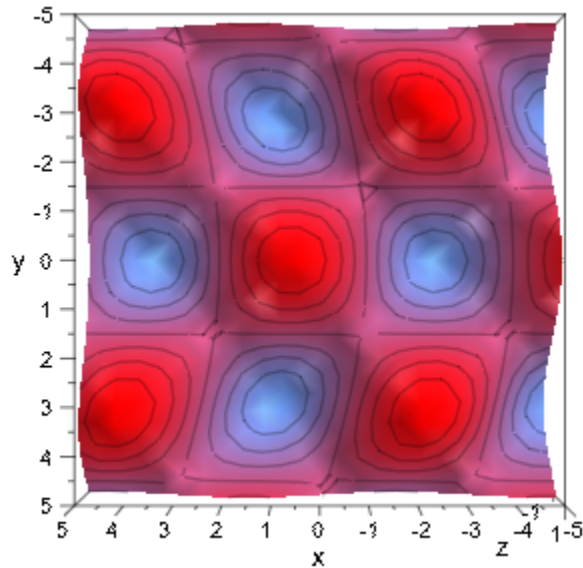

## Example 2

In the previous example, we set  $z$  values for the contour lines explicitly. There is an easier way of specifying equidistant lines, though, by giving the special value `Automatic`, followed by the number of lines to use. For example, implicit surfaces by default use 15 lines in each direction of space:

```
plot(plot::Implicit3d(abs(x)^3+abs(y)^3+abs(z)^3 - 1,  
                    x = -1..1, y=-1..1, z=-1..1),  
      Axes = None, Scaling = Constrained)
```

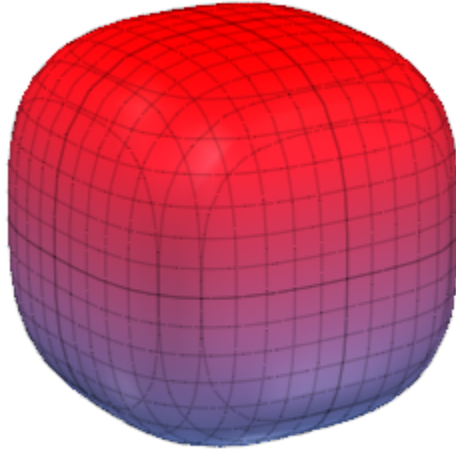

To change the number of lines, we use the syntax outlined above:

```
plot(plot::Implicit3d(abs(x)^3+abs(y)^3+abs(z)^3 - 1,  
  x = -1..1, y=-1..1, z=-1..1,  
  XContours = [Automatic, 4],  
  YContours = [Automatic, 11],  
  ZContours = [Automatic, 21]),  
  Axes = None, Scaling = Constrained)
```



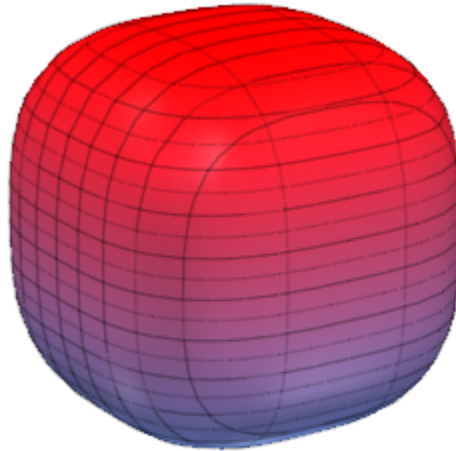

Note that two of the lines are at the extremal values and therefore usually not visible.

### Example 3

Contour lines are drawn using the same settings for `LineWidth` and `LineColor` as parameter lines are. In the following example, we use a modified copy of a function object that *only* displays contour lines, but with settings different from the function object proper.

```
f := plot::Function3d(x^2 - 2*x*y - y^2, x = -2..2, y = -2..2):  
plot(f, plot::modify(f, ZContours = [Automatic, 15],  
    LineWidth = 1,  
    LineColor = RGB::Gray30.[0.8],  
    XLinesVisible = FALSE,  
    YLinesVisible = FALSE,  
    Filled = FALSE))
```

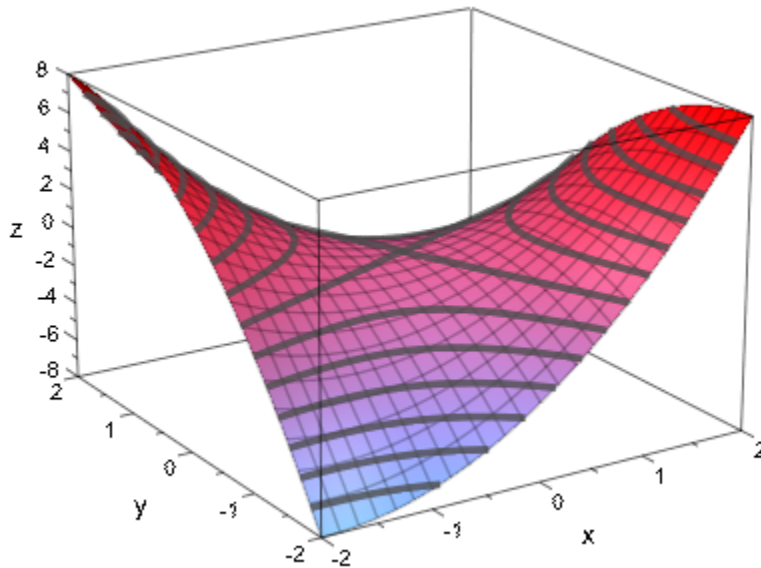

By using a transformation on page 24-1138 that maps space into a plane, we can use this technique (by setting some more options) to display height-colored contour lines below a function plot:

```
f := plot::Function3d(8*sin(x-cos(y))+(x^2+x*y),
                    x = -3..3, y = -3..3, Submesh=[2,2]):
plot(f, plot::Transform3d([0, 0, -9], [1, 0, 0, 0, 1, 0, 0, 0, 0]),
     plot::modify(f, ZContours = [Automatic, 15],
                  LineWidth = 0.5,
                  LineColorType = Dichromatic,
                  LineColor = RGB::Red,
                  LineColor2 = RGB::CornflowerBlue,
                  XLinesVisible = FALSE,
                  YLinesVisible = FALSE,
                  Filled = FALSE)))
```

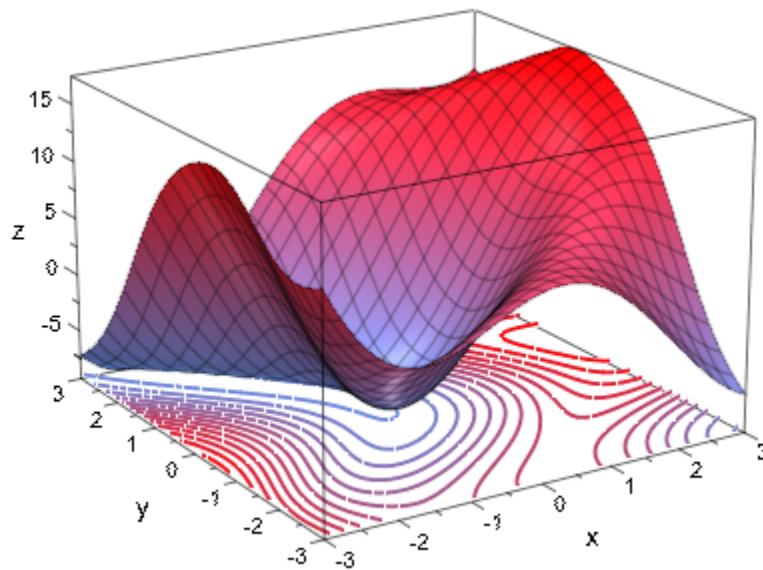

## See Also

### MuPAD Functions

[LineColor](#) | [LineWidth](#) | [LinesVisible](#)

## PointColor

Color of points

### Value Summary

Inherited	Color
-----------	-------

### Graphics Primitives

Objects	PointColor Default Values
<code>plot::Matrixplot</code> , <code>plot::Point2d</code> , <code>plot::Point3d</code> , <code>plot::PointList2d</code> , <code>plot::PointList3d</code> , <code>plot::SparseMatrixplot</code> , <code>plot::Sum</code>	RGB: :MidnightBlue
<code>plot::Listplot</code> , <code>plot::QQplot</code> , <code>plot::Scatterplot</code>	RGB: :Black

### Description

`PointColor` determines the color of points. The RGB library provides many pre-defined colors such as `RGB: :Red` etc. See section Colors (Symbolic Math Toolbox) of this document for more information on colors.

Many graphical objects such as curves, surfaces etc. are approximated by a numerical mesh. With `PointsVisible = TRUE`, the points of this mesh become visible. These points do *not* react to `PointColor`.

`PointColor` cannot be animated.

For points of type `plot::Point2d` and `plot::Point3d`, the point color can also be set by the attribute `Color`.

## Examples

### Example 1

We plot a cluster of random points with random sizes and random colors:

```
r := frandom:
plot(plot::Point2d([r(),r()], PointSize = 5*r()*unit::mm,
                   PointColor = [r(), r(), r()])
     $ i = 1 .. 200):
```

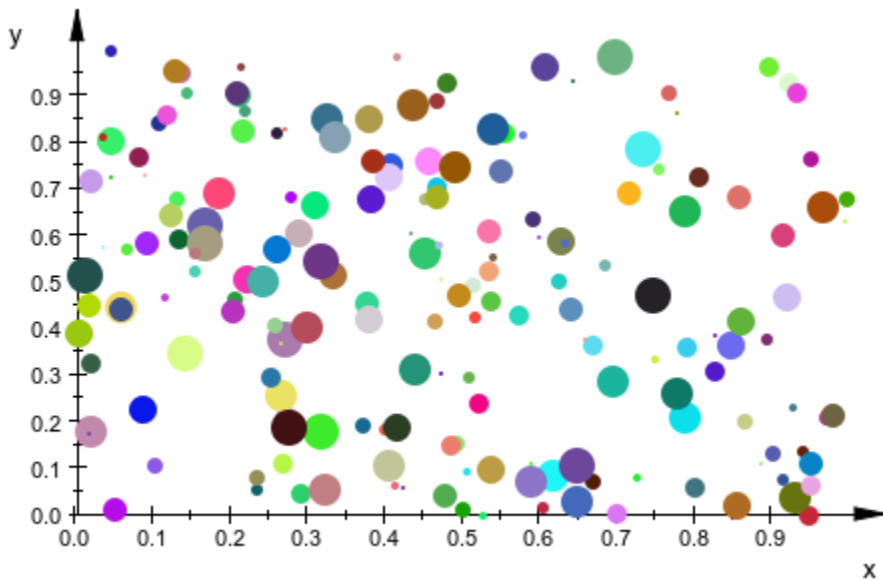

```
delete r:
```

### Example 2

We can access the PointColor attribute from a point and change it:

```
p := plot::Point2d(1, 2):
p::PointColor := RGB::Black:
p::PointColor
```

[0.0, 0.0, 0.0]

delete p:

## See Also

### MuPAD Functions

PointColor2 | PointColorType | PointSize | PointStyle | PointsVisible

# PointColor2

Secondary point color for color blends

## Value Summary

Optional	Color
----------	-------

## Graphics Primitives

Objects	PointColor2 Default Values
<code>plot::SparseMatrixplot</code>	RGB: :Red

## Description

`PointColor2` sets the secondary point color in objects of type `plot::SparseMatrixplot`.

Objects of type `plot::SparseMatrixplot` color their points according to the attribute `PointColorType = Flat` or `PointColorType = Dichromatic`, respectively.

With `PointColorType = Flat`, all points in a `plot::SparseMatrixplot` object are displayed in the color given by `PointColor`.

With `PointColorType = Dichromatic`, the points are colored differently using a color blend from the color `PointColor` to the color `PointColor2`. The actual color of a point indicates the size of the matrix entry visualized by `plot::SparseMatrixplot`.

`PointColor` corresponds to small matrix entries, `PointColor2` corresponds to large matrix entries.

## Examples

### Example 1

We create a 30×50 matrix with 500 random entries.

```
smp := plot::SparseMatrixplot(  
    matrix::random(30, 50, 500, frandom)):
```

We use the color type `Dichromatic` and request a dark green for large matrix entries and a light green for small matrix entries:

```
smp::PointColorType := Dichromatic:  
smp::PointColor := RGB::LightGreen:  
smp::PointColor2 := RGB::DarkGreen:  
smp::PointStyle := FilledDiamonds:  
smp::PointSize := 2.5*unit::mm:  
plot(smp):
```

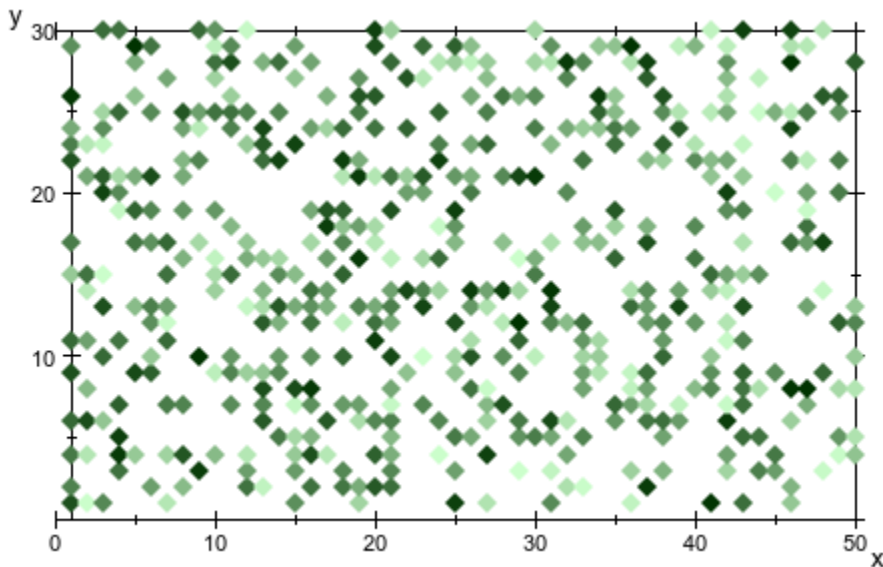

The secondary color is changed to a dark red:



```
smp::PointColor2 := RGB::DarkRed:  
plot(smp):
```

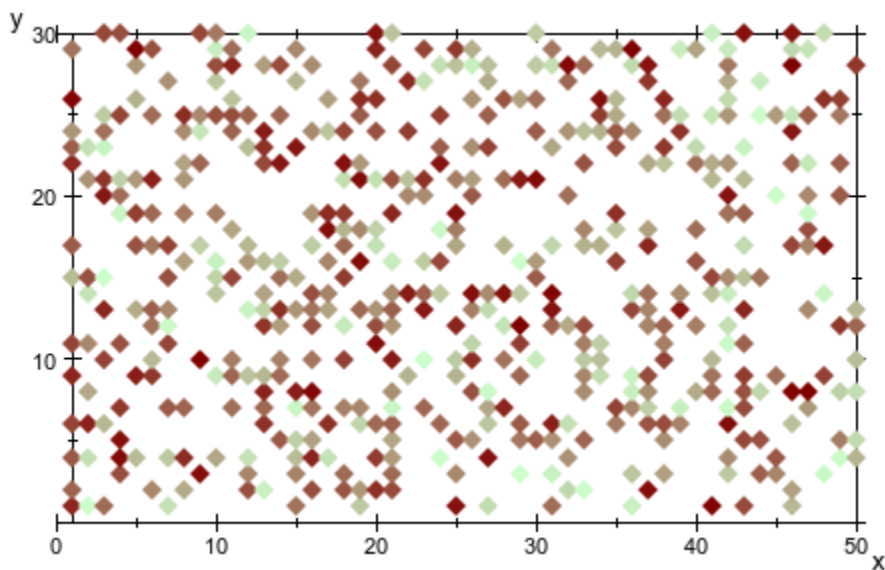

```
delete smp:
```

## See Also

### MuPAD Functions

[PointColor](#) | [PointColorType](#) | [PointSize](#) | [PointStyle](#)

## PointColorType

Point coloring types

### Value Summary

Optional	Dichromatic, or Flat
----------	----------------------

### Graphics Primitives

Objects	PointColorType Default Values
<code>plot::SparseMatrixplot</code>	Flat

### Description

`PointColorType` controls the type of point coloring used in objects of type `plot::SparseMatrixplot`.

With `PointColorType = Flat`, all points in a `plot::SparseMatrixplot` object are displayed in the color given by `PointColor`.

With `PointColorType = Dichromatic`, the points are colored differently using a color blend from the color `PointColor` to the color `PointColor2`. The actual color of a point indicates the size of the matrix entry visualized by `plot::SparseMatrixplot`.

### Examples

#### Example 1

We create a 30×50 matrix with 500 random entries. With the default setting of `PointColorType = Flat`, all nonzero entries are displayed in the color given by `PointColor`:

```
smp := plot::SparseMatrixplot(  
    matrix::random(30, 50, 500, frandom)):  
plot(smp):
```

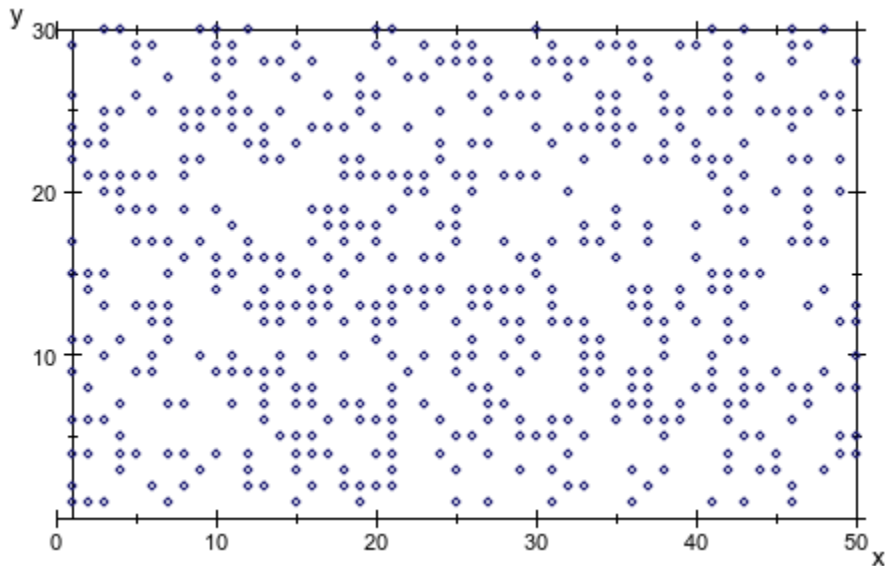

We change the color type to `Dichromatic` and request a dark green for large matrix entries and a light green for small matrix entries:

```
smp::PointColorType := Dichromatic:  
smp::PointColor := RGB::LightGreen:  
smp::PointColor2 := RGB::DarkGreen:  
smp::PointStyle := FilledDiamonds:  
smp::PointSize := 2.5*unit::mm:  
plot(smp):
```

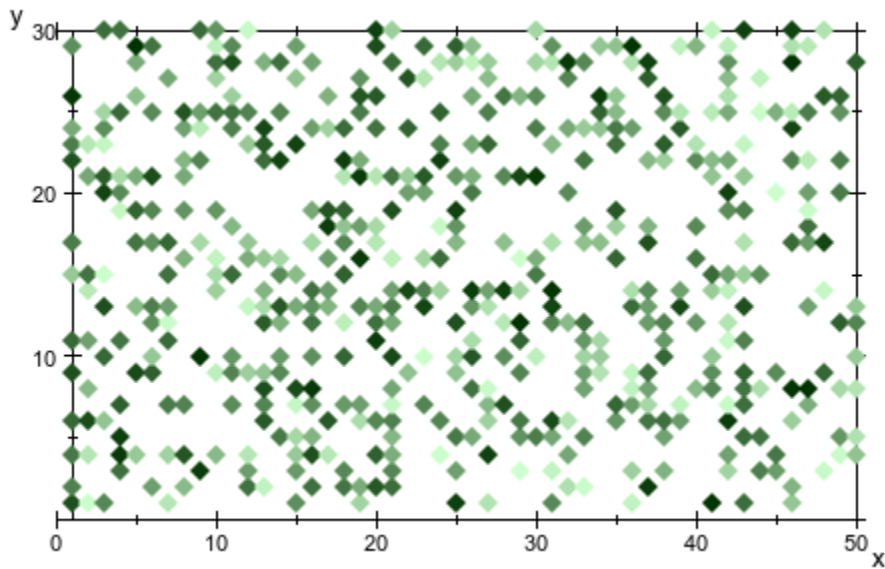

delete smp:

## See Also

### MuPAD Functions

[PointColor](#) | [PointColor2](#) | [PointSize](#) | [PointStyle](#)

# PointSize

Size of points

## Value Summary

Inherited	Positive output size
-----------	----------------------

## Graphics Primitives

Objects	PointSize Default Values
plot::Bars2d, plot::Bars3d, plot::Conformal, plot::Curve2d, plot::Curve3d, plot::Cylindrical, plot::Dodecahedron, plot::Function2d, plot::Function3d, plot::Hexahedron, plot::Histogram2d, plot::Icosahedron, plot::Integral, plot::Listplot, plot::Matrixplot, plot::Octahedron, plot::Ode2d, plot::Ode3d, plot::Point2d, plot::Point3d, plot::PointList2d, plot::PointList3d, plot::Polar, plot::Polygon2d, plot::Polygon3d, plot::Prism, plot::Pyramid, plot::QQplot, plot::Scatterplot, plot::Spherical, plot::Surface, plot::SurfaceSet, plot::SurfaceSTL, plot::Sweep, plot::Tetrahedron, plot::Turtle, plot::VectorField3d, plot::Waterman, plot::XRotate, plot::ZRotate	1.5

Objects	PointSize Default Values
plot::Rootlocus, plot::SparseMatrixplot	1.0
plot::Sequence	2

## Description

PointSize determines the physical size of points. The value should be specified as an absolute physical length including a length unit on page 1-2196 such as `PointSize = 1.5*unit::mm`. Numbers without a physical unit give the size in mm.

Typical points have a size of only a few pixels on the screen. Hence, the renderers cannot always react to small changes of the `PointSize`, because the actual size of the graphical points can attain only discrete values.

Depending on your hardware, there is a maximal size of the graphical points that can be rendered in 3D. If the `PointSize` is too large, the 3D renderer uses the maximal size that is supported.

Many graphical objects such as curves, surfaces etc. are approximated by a numerical mesh. With `PointsVisible = TRUE`, the points of this mesh become visible. These points react to `PointSize`.

`PointSize` cannot be animated.

## Examples

### Example 1

We plot a cluster of points with random sizes within the unit square:

```
r := random:  
plot(plot::Point2d(r(),r()), PointSize = 2*r()*unit::mm)  
$ i = 1 .. 200)
```

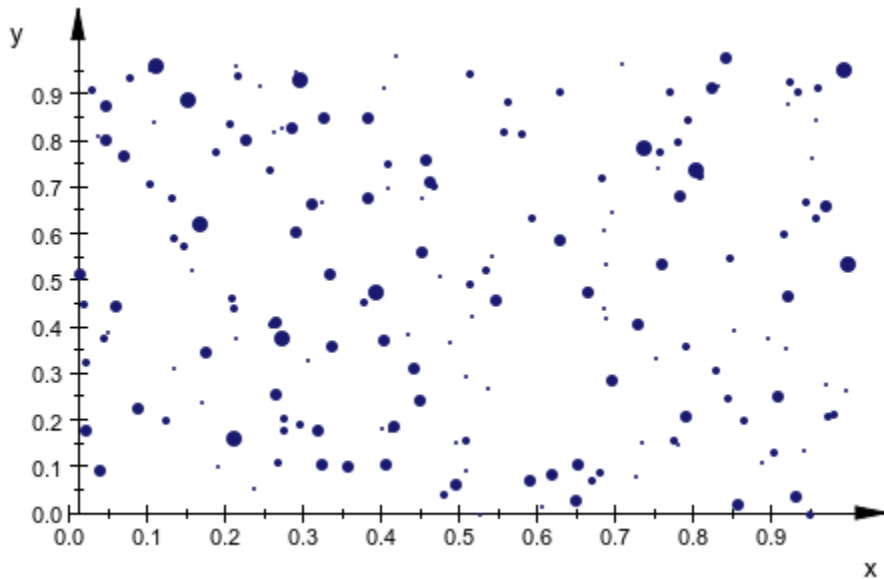

delete r:

## Example 2

Due to pixelation, there is only a discrete number of `PointSize` values that the renderers can display faithfully. Further, note that the large points may protrude over the edges of the viewing box without being clipped:

```
plot(plot::Point2d([i, 5], PointSize = i*0.1*unit::mm,
  Color = RGB::Red)
  $ i = 1 .. 30,
  plot::Point2d([3*i, 15], PointSize = i*unit::mm,
  Color = RGB::Green)
  $ i = 1 .. 10,
  plot::Point2d([9*i, 30], PointSize = i*unit::cm,
  Color = RGB::Blue)
  $ i in [0.3, 0.5, 0.8, 1.3, 2, 3],
  ViewingBox = [0 .. 30, 0 .. 35], Axes = Boxed)
```

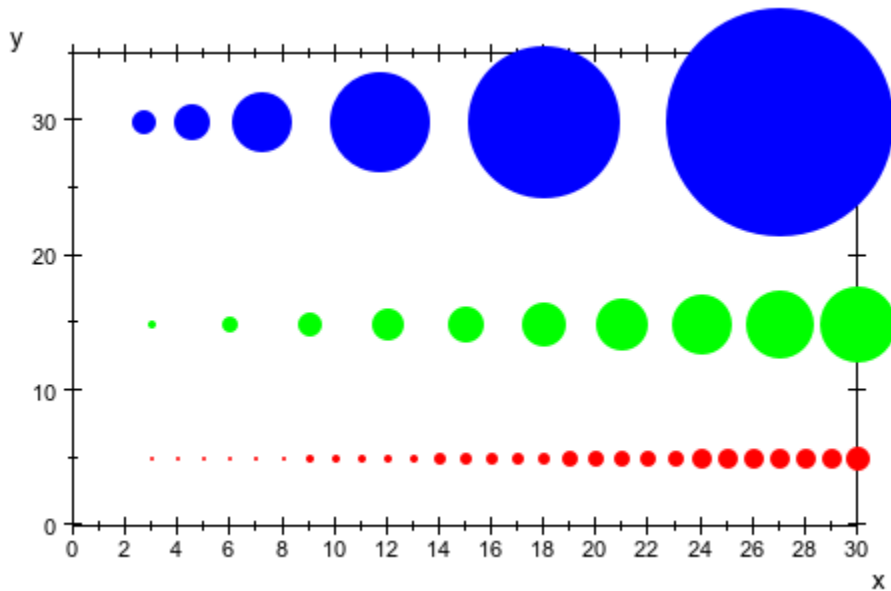

Here are the same points in 3D. Note the threshold for `PointSize` beyond which the graphical points do not grow:

```
plot(plot::Point3d([i, 5, 0], PointSize = i*0.1*unit::mm,
  Color = RGB::Red)
  $ i = 1 .. 30,
  plot::Point3d([3*i, 15, 0], PointSize = i*unit::mm,
  Color = RGB::Green)
  $ i = 1 .. 10,
  plot::Point3d([9*i, 30, 0], PointSize = i*unit::cm,
  Color = RGB::Blue)
  $ i in [0.3, 0.5, 0.8, 1.3, 2, 3],
  ViewingBox = [0 .. 30, 0 .. 35, -1 .. 1],
  Axes = Boxed, CameraDirection = [0, -10, 1000],
  YXRatio = 2/3)
```



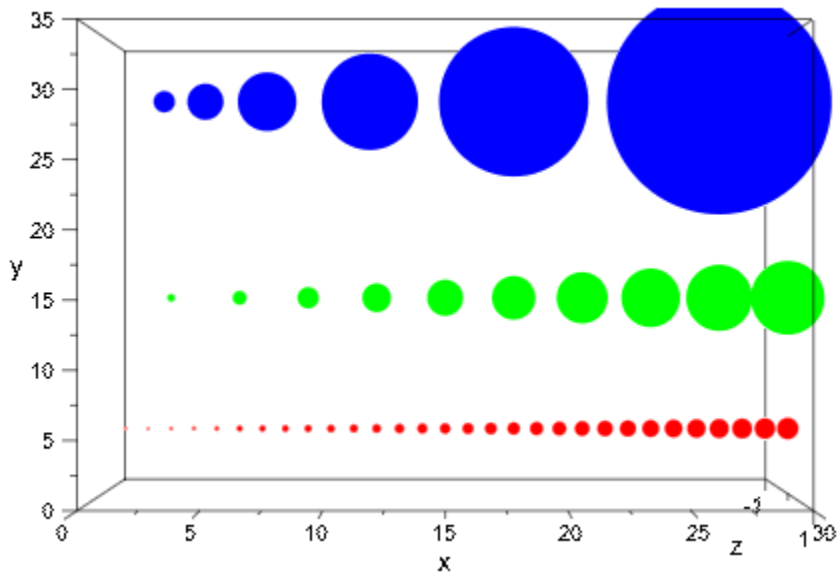

### Example 3

We can access the PointSize attribute from a point and change it:

```
p := plot::Point2d(1, 2):
p::PointSize := 4*unit::inch:
p::PointSize
```

$$\frac{508 \text{ mm}}{5}$$

delete p:

### See Also

#### MuPAD Functions

PointColor | PointStyle | PointsVisible

## PointStyle

Presentation style of points

### Value Summary

Inherited	Squares, FilledSquares, Circles, FilledCircles, Crosses, XCrosses, Diamonds, FilledDiamonds, or Stars (2D), FilledSquares or FilledCircles (3D)
-----------	---

## Graphics Primitives

Objects	PointStyle Default Values
plot::Bars2d, plot::Bars3d, plot::Curve2d, plot::Curve3d, plot::Cylindrical, plot::Dodecahedron, plot::Function2d, plot::Function3d, plot::Hexahedron, plot::Histogram2d, plot::Icosahedron, plot::Implicit3d, plot::Integral, plot::Listplot, plot::Matrixplot, plot::Octahedron, plot::Ode2d, plot::Ode3d, plot::Point2d, plot::Point3d, plot::PointList2d, plot::PointList3d, plot::Polar, plot::Polygon2d, plot::Polygon3d, plot::Prism, plot::Pyramid, plot::QQplot, plot::Rootlocus, plot::Scatterplot, plot::Sequence, plot::Spherical, plot::Surface, plot::SurfaceSet, plot::SurfaceSTL, plot::Sweep, plot::Tetrahedron, plot::Turtle, plot::VectorField3d, plot::Waterman, plot::XRotate, plot::ZRotate	FilledCircles
plot::SparseMatrixplot	Diamonds

## Description

PointStyle determines the presentation style of points. The various styles are demonstrated in “Example 1” on page 24-1924 (Symbolic Math Toolbox).

In 3D, only two styles FilledCircles and FilledSquares are supported by the renderer.

Many graphical objects such as curves, surfaces etc. are approximated by a numerical mesh. With `PointsVisible = TRUE`, the points of this mesh become visible. These points react to `PointStyle`.

`PointStyle` cannot be animated.

## Examples

### Example 1

We plot 2D points in all available styles:

```
styles := [Circles, FilledCircles,
           Crosses, XCrosses,
           Diamonds, FilledDiamonds,
           Squares, FilledSquares,
           Stars]:
points := null():
for i from 1 to nops(styles) do
  points := points,
  plot::Point2d([i, i], PointStyle = styles[i],
                Title = expr2text(styles[i]),
                TitlePosition = [i + 0.3, i - 0.15]):
end_for:
plot(points, PointSize = 3*unit::mm, Axes = None,
     TitleAlignment = Left):
```

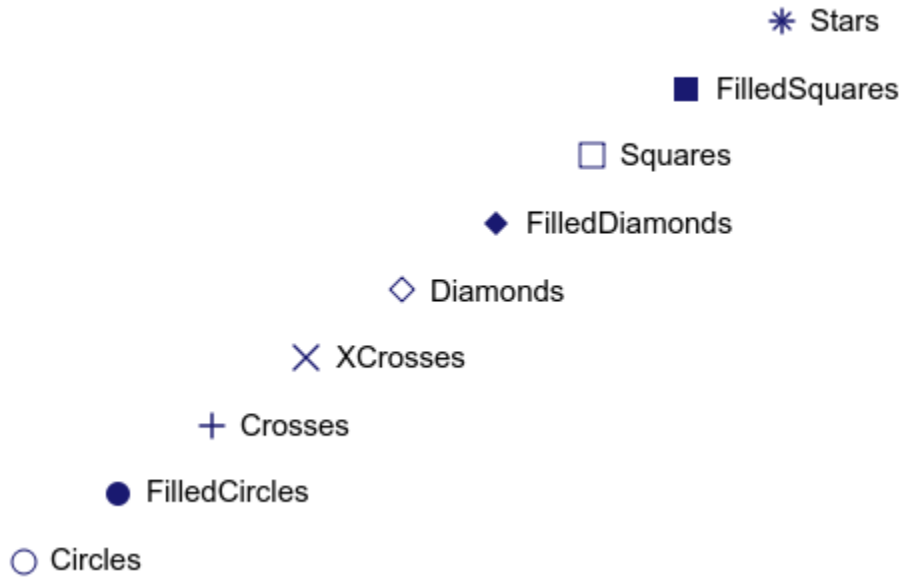

```
delete styles, points, i:
```

## Example 2

In 3D, the renderer only supports the point styles FilledCircles and FilledSquares:

```
plot(plot::Point3d([-1, -1, 0], PointStyle = FilledCircles,  
                  Title = "FilledCircles",  
                  TitlePosition = [-1, -0.8, 0]),  
      plot::Point3d([1, 1, 0], PointStyle = FilledSquares,  
                  Title = "FilledSquares",  
                  TitlePosition = [1, 1.2, 0]),  
      PointSize = 3*unit:mm,  
      ViewingBox = [-2..2, -2..2, 0..1],  
      CameraDirection = [0, -1, 1000]):
```

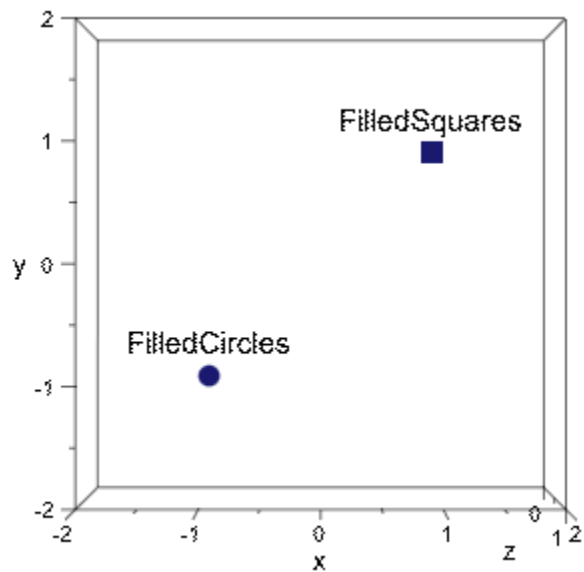

### Example 3

We can access the `PointStyle` attribute from a point and change it:

```
p := plot::Point2d(1, 2):  
p::PointStyle := Diamonds:  
p::PointStyle
```

Diamonds

```
delete p:
```

### See Also

#### MuPAD Functions

`PointColor` | `PointSize` | `PointsVisible`

# PointsVisible

Visibility of mesh points

## Value Summary

Inherited	FALSE, or TRUE
-----------	----------------

## Graphics Primitives

Objects	PointsVisible Default Values
plot::Conformal, plot::Curve2d, plot::Curve3d, plot::Cylindrical, plot::Dodecahedron, plot::Function2d, plot::Function3d, plot::Hexahedron, plot::Icosahedron, plot::Implicit3d, plot::Integral, plot::Octahedron, plot::Polar, plot::Polygon2d, plot::Polygon3d, plot::Prism, plot::Pyramid, plot::Rootlocus, plot::Spherical, plot::Sum, plot::Surface, plot::SurfaceSet, plot::SurfaceSTL, plot::Sweep, plot::Tetrahedron, plot::Tube, plot::Turtle, plot::Waterman, plot::XRotate, plot::ZRotate	FALSE
plot::Listplot, plot::Matrixplot, plot::Ode2d, plot::Ode3d, plot::QQplot, plot::Scatterplot, plot::Sequence, plot::SparseMatrixplot, plot::VectorField3d	TRUE

## Description

`PointsVisible = TRUE/FALSE` enables/disables the plotting of mesh and submesh points.

The mesh points react to the attributes `PointSize` and `PointStyle`. However, they do *not* react to the attribute `PointColor`. Typically, mesh points are painted in the same color used for the line objects defined by the mesh points.

`PointsVisible` cannot be animated.

## Examples

### Example 1

We plot the sine function on a rather coarse mesh using the `PointsVisible` default value `FALSE`:

```
f := plot::Function2d(sin(x), x = -PI .. PI, Mesh = 20):  
plot(f):
```

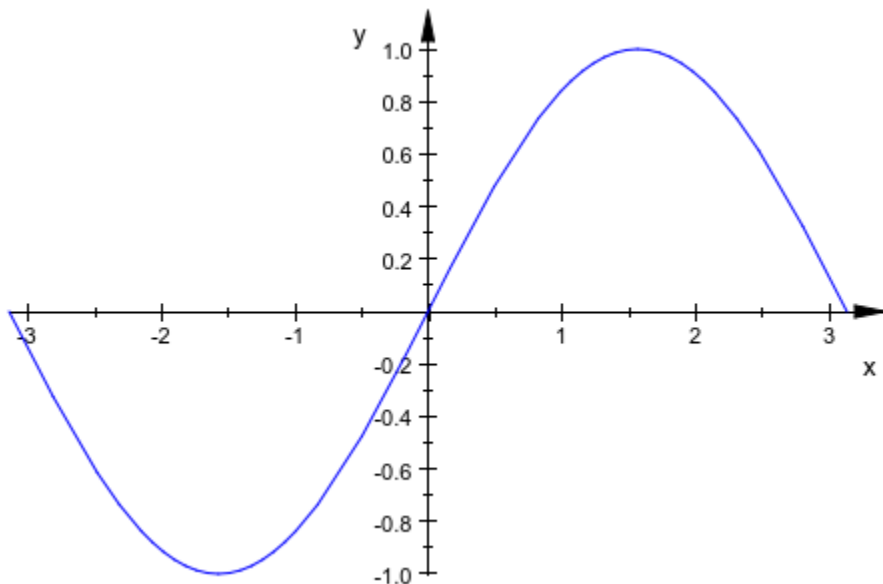



We use `PointsVisible = TRUE` to make the mesh points visible:

```
f::PointsVisible := TRUE:  
plot(f, PointSize = 2*unit::mm)
```

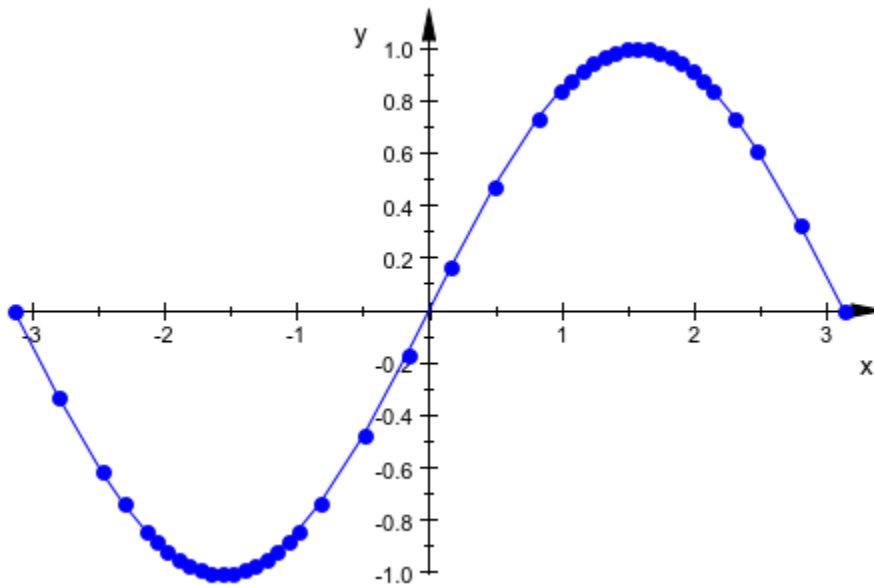

We enable adaptive plotting:

```
f::AdaptiveMesh := 2:  
plot(f, PointSize = 2*unit::mm)
```

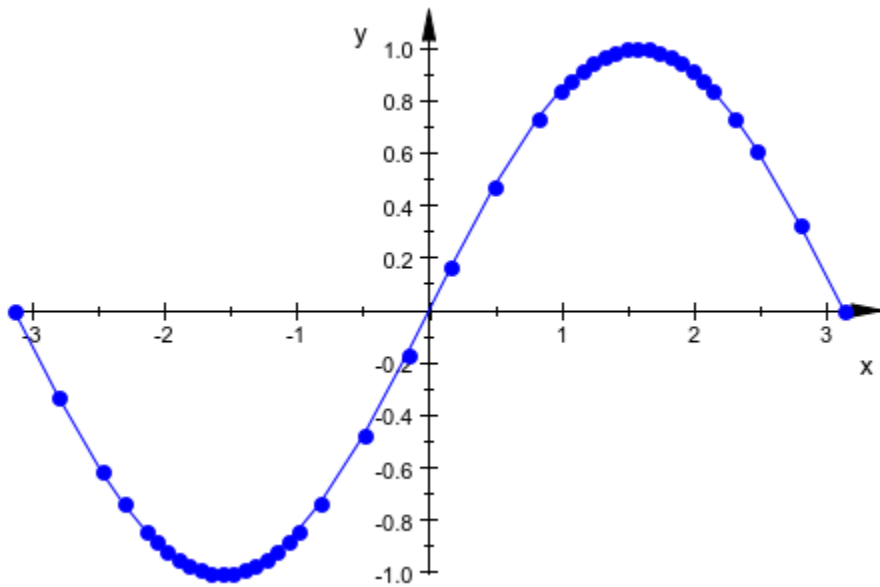

delete f:

## See Also

**MuPAD Functions**  
PointSize | PointStyle

# BarCentersBarWidths

Position of bars

## Value Summary

BarCenters, BarWidths	Optional	List of arithmetical expressions
-----------------------	----------	----------------------------------

## Graphics Primitives

Objects	Default Values
<code>plot::Bars2d</code>	BarWidths: <code>[[1.0]]</code>

## Description

BarCenters and BarWidths govern horizontal center positions and widths of the bars in 2D bar plots of Type `plot::Bars2d`.

A plot of type `plot::Bars2d` serves for visualizing and comparing discrete data samples by a 2D bar plot.

The data values define the vertical coordinates of the bars. The position along the horizontal axis and the horizontal width of the bars are controlled by the attributes BarCenters and BarWidths.

The value of the attribute BarCenters may be a list  $[x_1, x_2, \dots]$  of numerical values or expressions of the animation parameter. These values define the horizontal coordinates of the bar centers.

If several data samples are to be displayed simultaneously, the value of BarCenters may be a list of lists  $[[x_{11}, x_{12}, \dots], [x_{21}, x_{22}, \dots], \dots]$ , where  $x_{ij}$  is the center position of the bar indicating the  $j$ -th data point in the  $i$ -th sample.

If the length of a list in the `BarCenters` attribute is smaller than the number of data in the corresponding sample, the center values are chosen automatically for the surplus data items.

If the length of the `BarCenters` list is larger than the number of corresponding data items, the surplus center values are ignored.

Setting `BarCenters = [x1]`, the first bar is centered at  $x = x_1$ , while the standard distance between the bars is kept. Thus, `BarCenters = [x1]` allows to shift the entire bar plot along the horizontal axis.

The value of the attribute `BarWidths` may be a numerical value or an expression of the animation parameter. This sets the horizontal width of *all* bars.

Alternatively, it may be a list of values `[w1, w2, ...]` allowing to define different widths of the bars. If several data samples are specified, each data sample uses the same list of `BarWidths` values.

Alternatively, the value of `BarWidths` may be a list of lists `[[w11, w12, ...], [w21, w22, ...], ...]`, where  $w_{ij}$  is the horizontal width of the bar indicating the  $j$ -th data point in the  $i$ -th sample.

If the length of a list in the `BarWidths` attribute is smaller than the number of data in the corresponding sample, the width values are chosen automatically for the surplus data items.

If the length of the `BarWidths` list is larger than the number of corresponding data items, the surplus width values are ignored.

The `BarWidths` attribute only has an effect in conjunction with the (default) `BarStyle = Boxes`.

If the attribute `DrawMode = Horizontal` is set in the `plot::Bars2d` object, the bars are drawn from left to right instead from bottom to top.

In this case, the attributes `BarCenters` and `BarWidths` refer to the vertical coordinates of the bars.

## Examples

### Example 1

We display some discrete values as a bar plot:

```
data := [binomial(10, j) $ j = 0..10]:  
plot(plot::Bars2d(data, BarCenters = [j $ j = 0..10])):
```

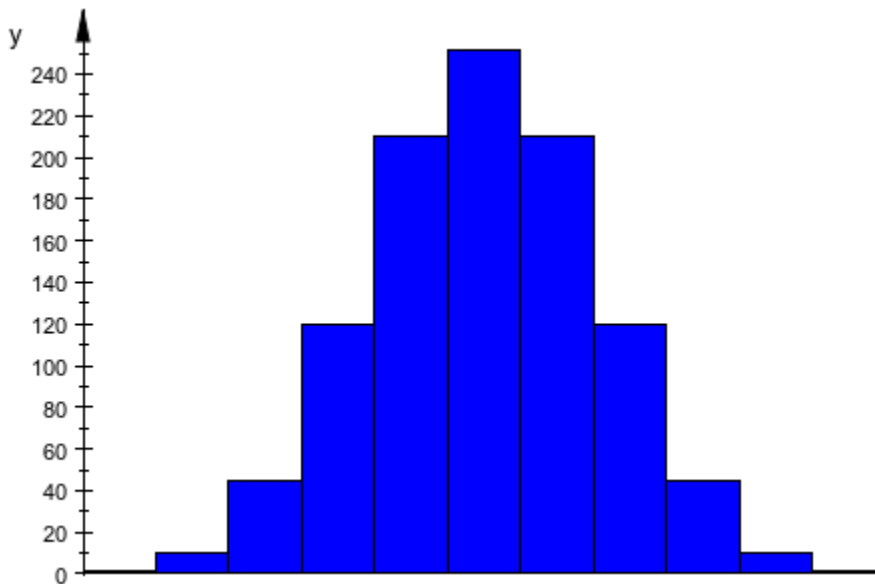

We reduce the widths of the bars:

```
plot(plot::Bars2d(data, BarCenters = [j $ j = 0..10],  
BarWidths = 0.6)):
```

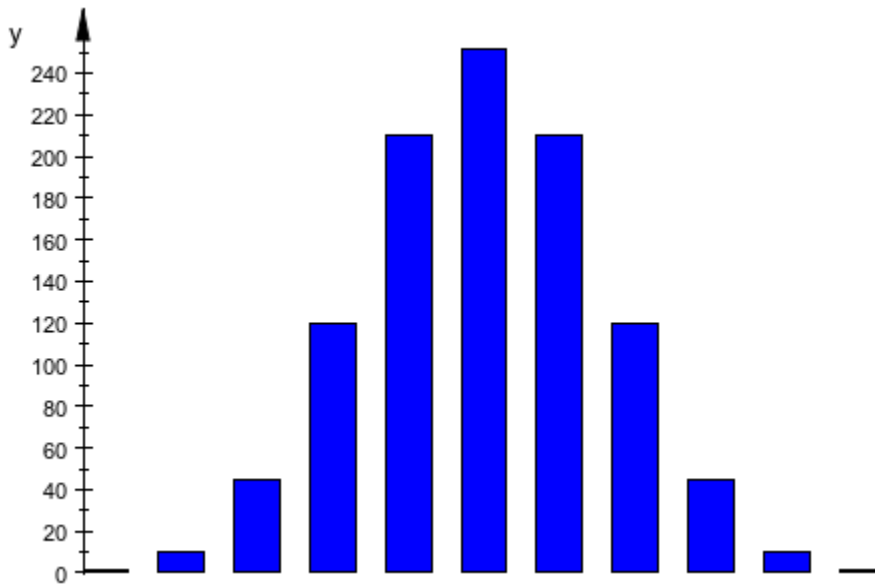

delete data:

## Example 2

For large values of  $n$  and small values of  $p$ , the binomial distribution `stats::binomialPF(n, p)` is approximated by the Poisson distribution `stats::poissonPF(n*p)`. We demonstrate this fact by plotting the probability values of these distributions in one bar plot:

```
n := 100: p:= 0.1:
data1 := [stats::binomialPF(n, p)(j) $ j = 0..20]:
data2 := [stats::poissonPF(n*p)(j) $ j = 0..20]:
plot(plot::Bars2d([data1, data2],
  BarCenters = [[j $ j = 0..20], [j + 0.4 $ j = 0..20]],
  BarWidths = 0.4)):
```



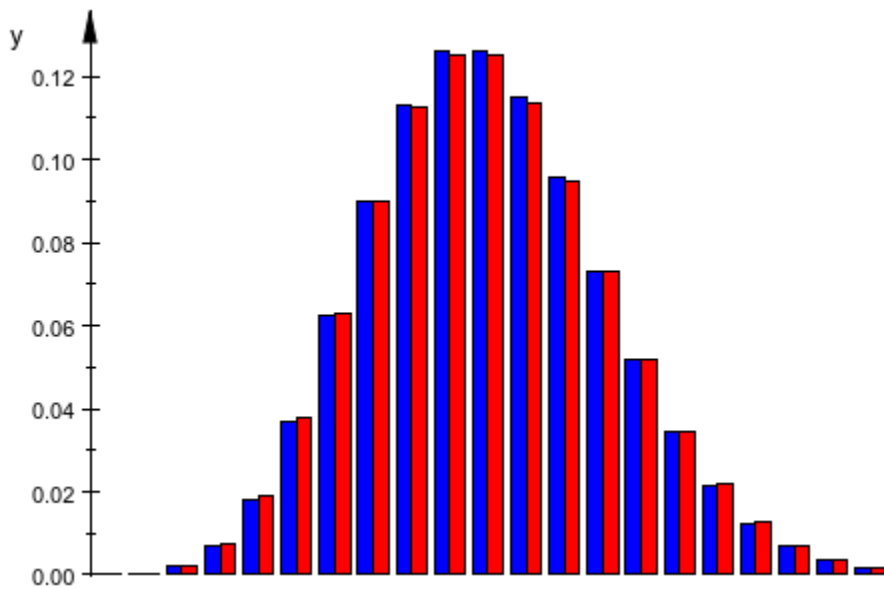

```
delete n, p, data1, data2:
```

## See Also

**MuPAD Functions**  
BarStyle | DrawMode



# BarStyleShadows

Display style of bar plots

## Value Summary

BarStyle	Optional	Boxes, Lines, LinesPoints, or Points
Shadows	Optional	TRUE or FALSE

## Graphics Primitives

Objects	Default Values
plot::Bars3d	BarStyle: Boxes
plot::Bars2d	BarStyle: Boxes Shadows: FALSE

## Description

BarStyle selects between bars drawn as boxes, as lines, just points, or lines with points. For box diagrams, Shadows can be used to have simple “shadows” drawn.

Bar plots can use different types of bars. The options are shown in the examples.

## Examples

### Example 1

With only few data, the option Boxes is often the most useful one:

```
plot(plot::Bars2d([[1,2,3],[2,5,4],[1,0.5,-1]],  
  BarStyle = Boxes))
```

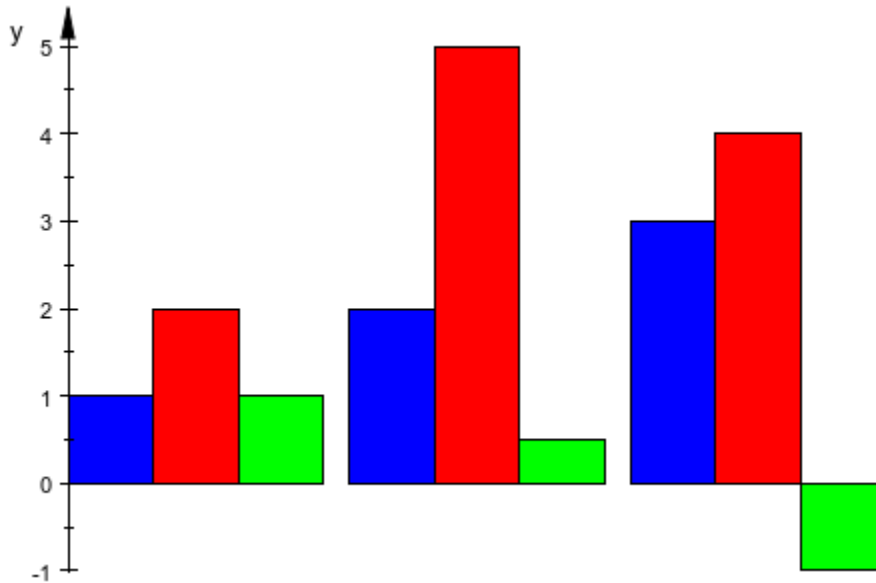

It can be combined with `Shadows = TRUE` and possibly `LinesVisible = FALSE` for a more pleasant display:

```
plot(plot::Bars2d([[1,2,3],[2,5,4],[1,0.5,-1]],  
  BarStyle = Boxes, Shadows = TRUE,  
  LinesVisible = FALSE))
```

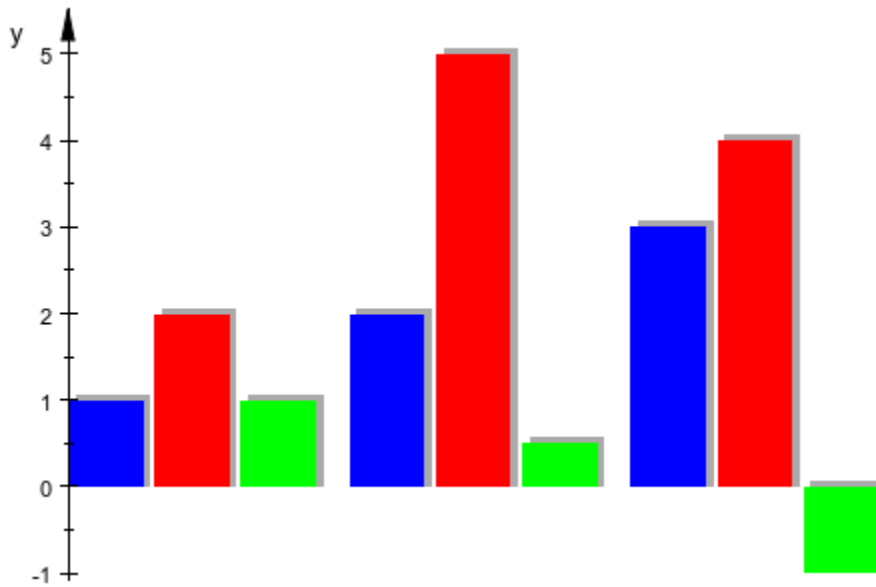

Shadows are not displayed for the other bar styles:

```
plot(plot::Bars2d([[1,2,3],[2,5,4],[1,0.5,-1]],  
                BarStyle = Lines, Shadows = TRUE))
```

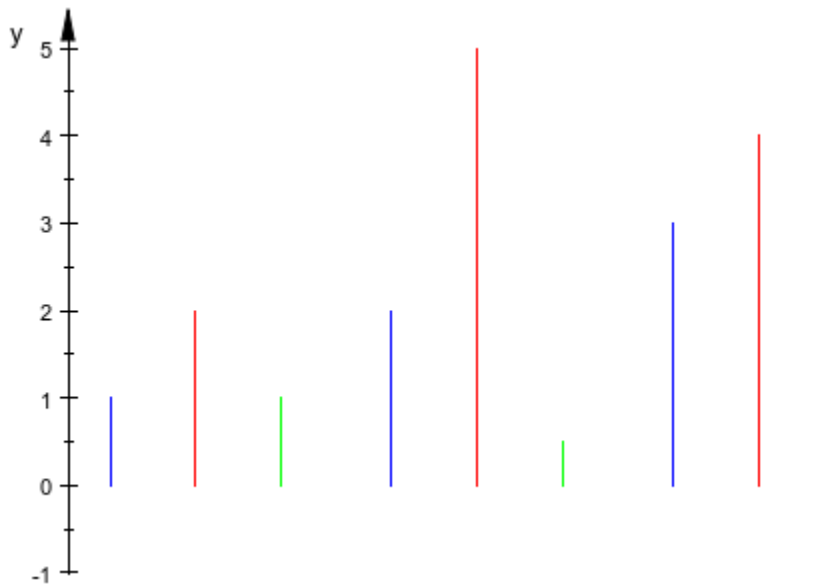

## Example 2

When more data is to be displayed, a bar plot may be less adequate:

```
b := plot::Bars2d([[1/i^k$i=1..20] $ k = 1..4]):  
plot(b)
```

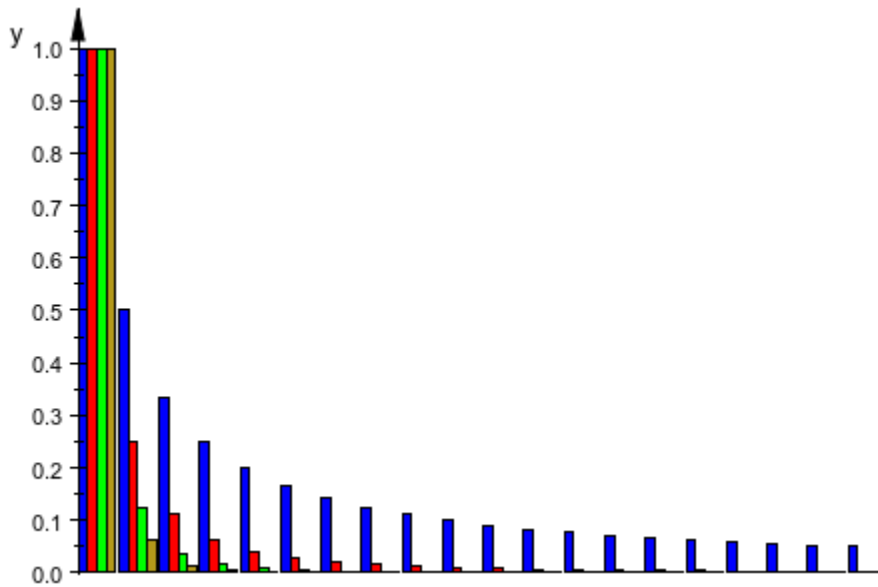

We demonstrate the alternatives without any further comment:

```
b::BarStyle := Lines:  
plot(b)
```

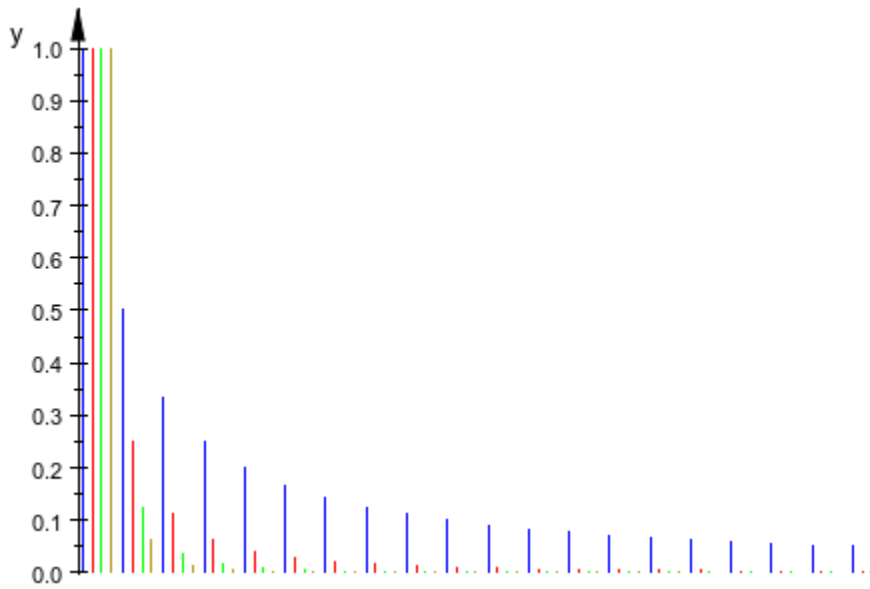

```
b::BarStyle := Points:  
plot(b)
```

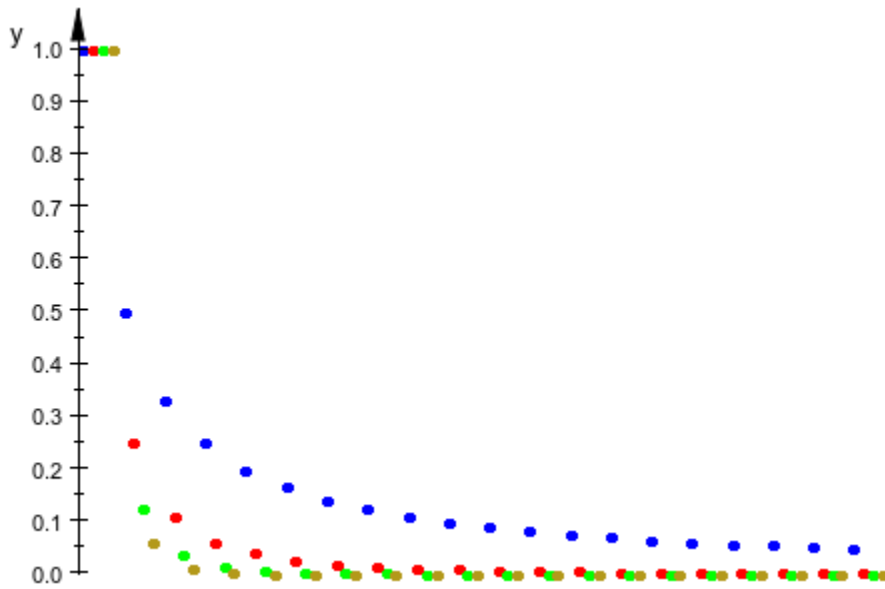

```
b::BarStyle := LinesPoints:  
plot(b)
```

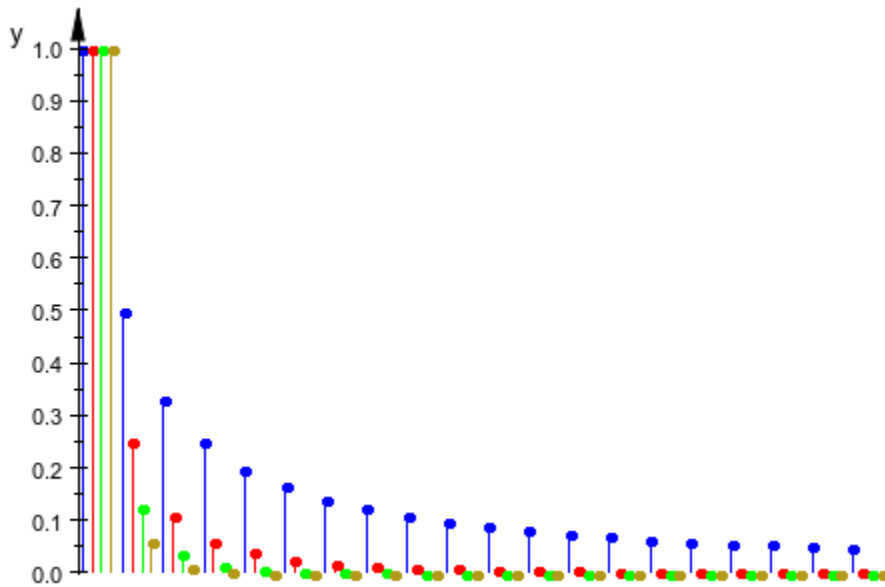

## See Also

**MuPAD Functions**  
Colors | FillPatterns



# Color

Main color

## Value Summary

Library wrapper for “Colors, FillColor, LightColor, LineColor, and PointColor”	See below
--	-----------

## Graphics Primitives

Objects	Color Default Values
plot::Histogram2d	RGB::GeraniumLake
plot::Cylindrical, plot::Density, plot::Dodecahedron, plot::Function3d, plot::Hatch, plot::Hexahedron, plot::Icosahedron, plot::Implicit3d, plot::Matrixplot, plot::Octahedron, plot::Prism, plot::Pyramid, plot::Spherical, plot::Surface, plot::SurfaceSet, plot::SurfaceSTL, plot::Tetrahedron, plot::XRotate, plot::ZRotate	RGB::Red
plot::Box, plot::Cone, plot::Ellipsoid, plot::Parallelogram3d, plot::Plane, plot::Sphere	RGB::LightBlue

Objects	Color Default Values
<code>plot::Arrow2d</code> , <code>plot::Arrow3d</code> , <code>plot::Circle2d</code> , <code>plot::Circle3d</code> , <code>plot::Conformal</code> , <code>plot::Curve2d</code> , <code>plot::Curve3d</code> , <code>plot::Ellipse2d</code> , <code>plot::Function2d</code> , <code>plot::Implicit2d</code> , <code>plot::Line2d</code> , <code>plot::Line3d</code> , <code>plot::Lsys</code> , <code>plot::Parallelogram2d</code> , <code>plot::Polar</code> , <code>plot::Polygon2d</code> , <code>plot::Polygon3d</code> , <code>plot::Raster</code> , <code>plot::Rectangle</code> , <code>plot::Sequence</code> , <code>plot::Sum</code> , <code>plot::Turtle</code> , <code>plot::VectorField2d</code> , <code>plot::VectorField3d</code>	RGB::Blue
<code>plot::Point2d</code> , <code>plot::Point3d</code> , <code>plot::PointList2d</code> , <code>plot::PointList3d</code> , <code>plot::SparseMatrixplot</code>	RGB::MidnightBlue
<code>plot::Sweep</code>	RGB::Black.[0.25]
<code>plot::Iteration</code>	RGB::Grey50
<code>plot::Bars2d</code> , <code>plot::Bars3d</code> , <code>plot::Boxplot</code> , <code>plot::Piechart2d</code> , <code>plot::Piechart3d</code>	
<code>plot::Waterman</code>	RGB::SafetyOrange
<code>plot::Integral</code>	RGB::PaleBlue

## Description

Color refers to the “main color” of an object.

Depending on the object type, Color refers to the line color (e.g., `plot::Function2d`), the fill color (`plot::Surface`), the point color (`plot::Point2d`), the light color (`plot::PointLight`), or the one-and-only entry in Colors (`plot::Histogram2d`).

In general, the main color of an object is the first one available in the list

- 1 The first entry of Colors, if Colors contains exactly one entry.
- 2 FillColor
- 3 LineColor
- 4 PointColor
- 5 LightColor

The following object types deviate from this general rule and choose the line color as main color: `plot::Arc2d`, `plot::Arc3d`, `plot::Circle2d`, `plot::Circle3d`, `plot::Ellipse2d`, `plot::Ellipse3d`, `plot::Ode2d`, `plot::Ode3d`, `plot::Parallelogram2d`, `plot::Polygon2d`, `plot::Polygon3d`, and `plot::Rectangle`. `plot::Sequence` uses `PointColor` as the main color.

---

**Note** Color is a *library attribute* and does not appear in the inspector (Symbolic Math Toolbox).

---

## Examples

### Example 1

Color is useful for unified input of different object types:

```
plot(plot::Function3d(sin(x-y/2), Color = RGB::Green),
      plot::Point3d([0, 0, 0], Color = RGB::Red),
      plot::Curve3d([x, 0, sin(x)], x = -6..6,
                    LineWidth = 2*unit::mm,
                    Color = RGB::Blue),
      Scaling = Constrained)
```

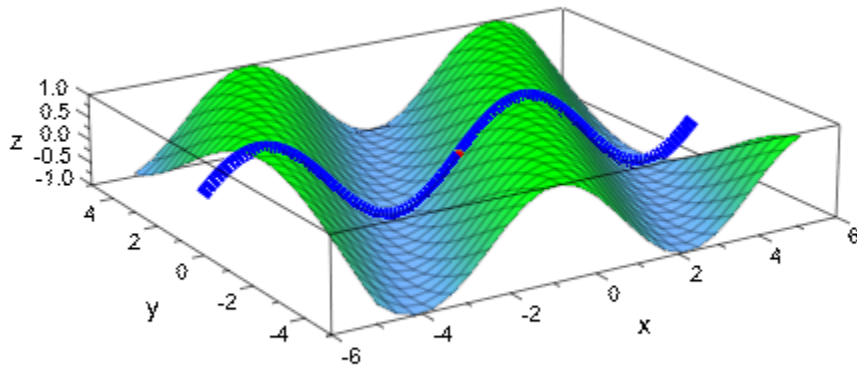

## See Also

### MuPAD Functions

[Colors](#) | [FillColor](#) | [LineColor](#) | [PointColor](#)

# Colors

List of colors to use

---

**Note** For colors in MATLAB®, see `colspec`.

---

## Value Summary

Optional	List of colors
----------	----------------

## Graphics Primitives

Objects	Colors Default Values
<code>plot::Bars2d</code> , <code>plot::Bars3d</code> , <code>plot::Ode2d</code> , <code>plot::Ode3d</code>	[RGB::Blue, RGB::Red, RGB::Green, RGB::MuPADGold, RGB::Orange, RGB::Cyan, RGB::Magenta, RGB::LimeGreen, RGB::CadmiumYellowLight, RGB::AlizarinCrimson, RGB::Aqua, RGB::Lavender, RGB::SeaGreen, RGB::AureolineYellow, RGB::Banana, RGB::Beige, RGB::YellowGreen, RGB::Wheat, RGB::IndianRed, RGB::Black]
<code>plot::MuPADCube</code>	[RGB::Green, RGB::Blue, RGB::Red, RGB::Yellow, RGB::Antique]
<code>plot::Boxplot</code> , <code>plot::Piechart2d</code> , <code>plot::Piechart3d</code>	[RGB::Blue, RGB::Red, RGB::Green, RGB::MuPADGold, RGB::Orange, RGB::Cyan, RGB::Magenta, RGB::LimeGreen, RGB::CadmiumYellowLight, RGB::AlizarinCrimson]

## Description

Colors sets a list of colors to use for object parts.

Plot objects like `plot::Piechart3d` or `plot::MuPADCube` that use more than one color use `Colors` to have a configurable list of colors to use.

The length of the list in `Colors` need not be fixed, it just must not be empty. If the list contains more colors than needed, the remaining colors are simply not used; if the list contains fewer colors than needed, it will be used cyclically, i.e., as if it were repeated as often as necessary. Cf. “Example 2” on page 24-1951 (Symbolic Math Toolbox).

## Examples

### Example 1

Most of the statistical plots use `Colors` for the colors of their groups:

```
plot(plot::Bars2d([[frandom() $i=1..2] $ i = 1..3]))
```

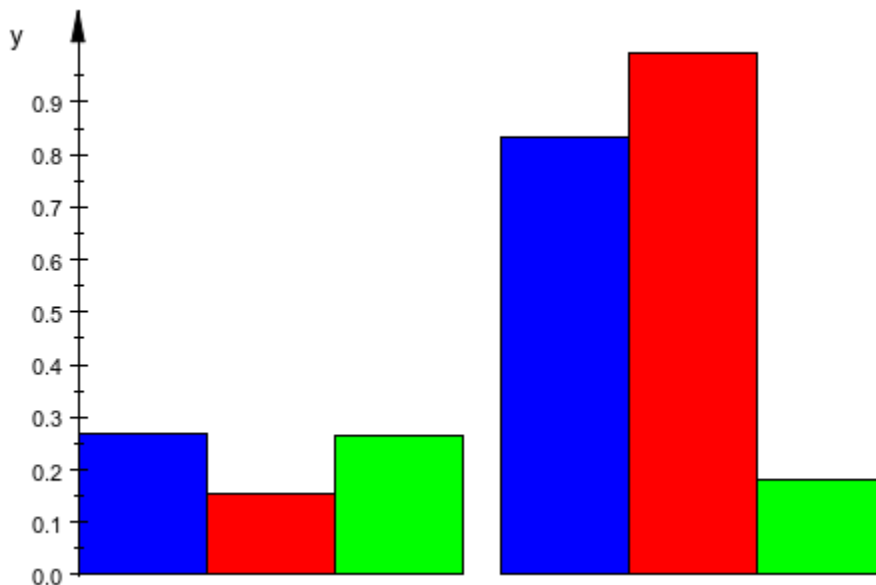

```
plot(plot::Bars2d([[frandom() $i=1..2] $ i = 1..3],  
  Colors = [RGB::Orange, RGB::Yellow, RGB::Magenta]))
```

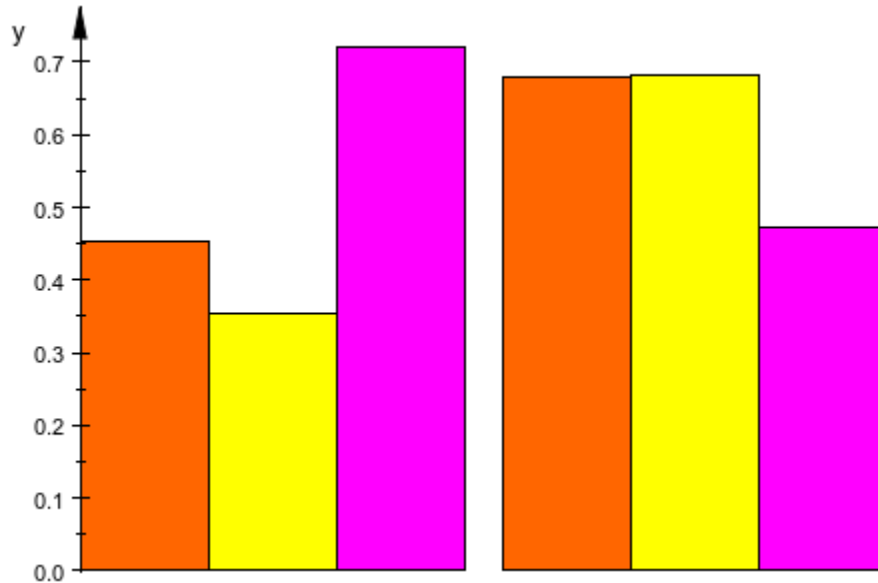

## Example 2

If more colors are required than given in `Colors`, the given list is used cyclically:

```
plot(plot::Piechart2d([1, 1, 1, 1], Colors = [RGB::White, RGB::Blue]))
```

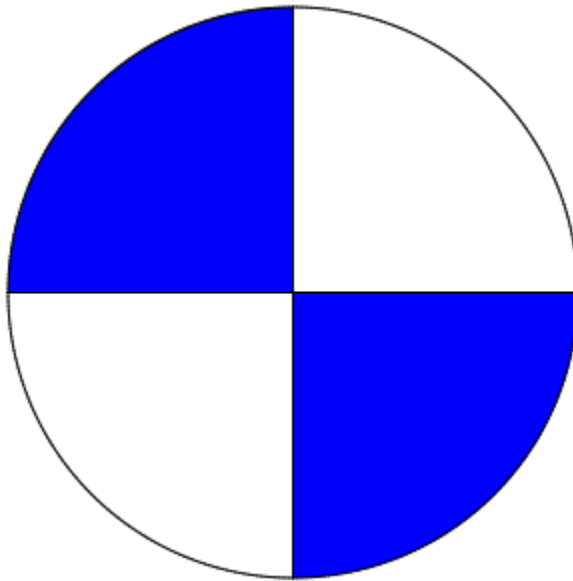

## See Also

### MuPAD Functions

`Color` | `FillColor` | `LineColor` | `PointColor`



# FillColorFillColor2

Color of areas and surfaces

## Value Summary

FillColor,FillColor2	Inherited	Color
----------------------	-----------	-------

## Graphics Primitives

Objects	Default Values
plot::Histogram2d	FillColor: RGB::GeraniumLake
plot::Cylindrical, plot::Density, plot::Dodecahedron, plot::Function3d, plot::Hexahedron, plot::Icosahedron, plot::Implicit3d, plot::Matrixplot, plot::Octahedron, plot::Prism, plot::Pyramid, plot::Spherical, plot::Surface, plot::SurfaceSet, plot::SurfaceSTL, plot::Sweep, plot::Tetrahedron, plot::Tube, plot::XRotate, plot::ZRotate	FillColor: RGB::Red FillColor2: RGB::CornflowerBlue
plot::Box, plot::Circle3d, plot::Cone, plot::Cylinder, plot::Ellipsoid, plot::Plane, plot::Polygon3d, plot::Sphere	FillColor: RGB::LightBlue
plot::Arc2d, plot::Circle2d, plot::Ellipse2d, plot::Hatch, plot::Parallelogram2d, plot::Polygon2d, plot::Rectangle, plot::Sum	FillColor: RGB::Red

Objects	Default Values
plot::Arc3d, plot::Ellipse3d, plot::Parallelogram3d	FillColor: RGB::LightBlue FillColor2: RGB::CornflowerBlue
plot::Waterman	FillColor: RGB::SafetyOrange FillColor2: RGB::CornflowerBlue
plot::Integral	FillColor: RGB::PaleBlue

## Description

FillColor determines the color used to fill all types of areas and surfaces. FillColor2 is used for color blends. FillColors is used for objects that need more than one color.

2D objects that have a notion of “area” and 3D objects that have a surface support FillColor to determine the primary color to show objects in. If FillColorType is set to Dichromatic, FillColor2 sets the second color to blend to.

Functions and primitives displaying more than one object, such as plot::Bars2d, use FillColors for a list of colors used cyclically.

## Examples

### Example 1

By default, plot::Hatch objects are hatched in RGB ::Red, the same color used by default for plot::Function2d:

```
f := plot::Function2d(cos(2*x)+cos(x), x=-PI..PI):
h := plot::Hatch(f):
plot(h, f)
```

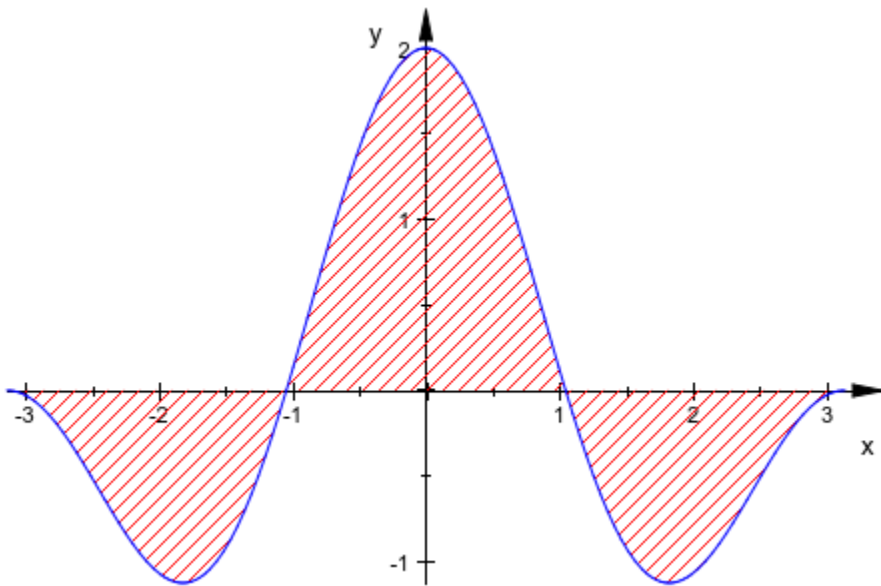

To change the color of the hatch, simply set the "FillColor"-slot to some other value:

```
h::FillColor := RGB::Grey:  
plot(h, f)
```

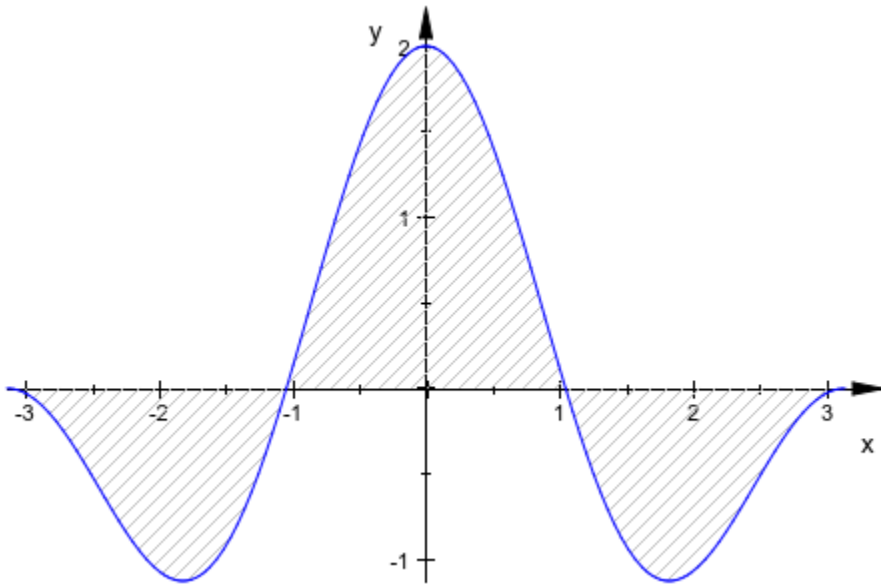

## Example 2

The default setting for a surface is to have a height-dependent coloring with a linear blend from `FillColor` to `FillColor2`:

```
s := plot::Surface([cos(2*u+v), sin(u+2*v), sin(u+v)],  
                  u = 0..2*PI, v = 0..2*PI,  
                  ULinesVisible = FALSE,  
                  VLinesVisible = FALSE):  
plot(s)
```

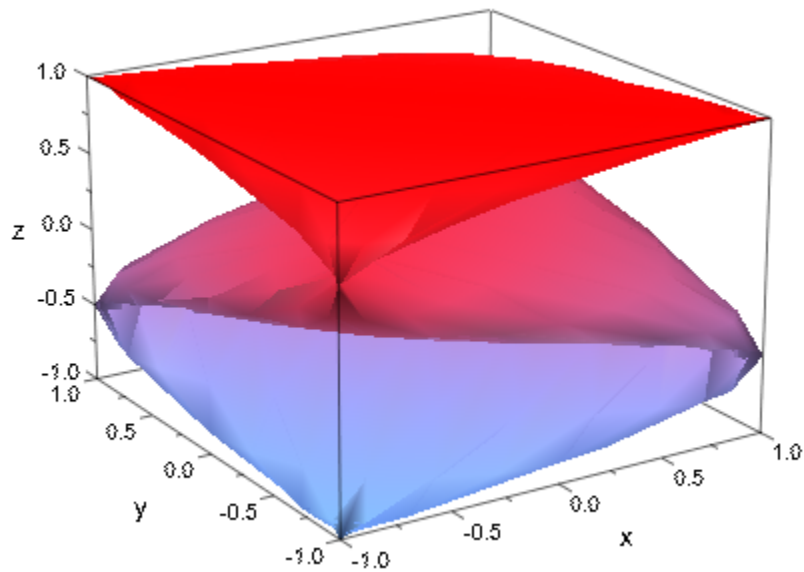

These colors can be manipulated in the usual way. As an example, we set the transition to a monochrome transition from opaque to transparent:

```
s::FillColor := RGB::Green:  
s::FillColor2 := s::FillColor . [0.0]:  
plot(s)
```

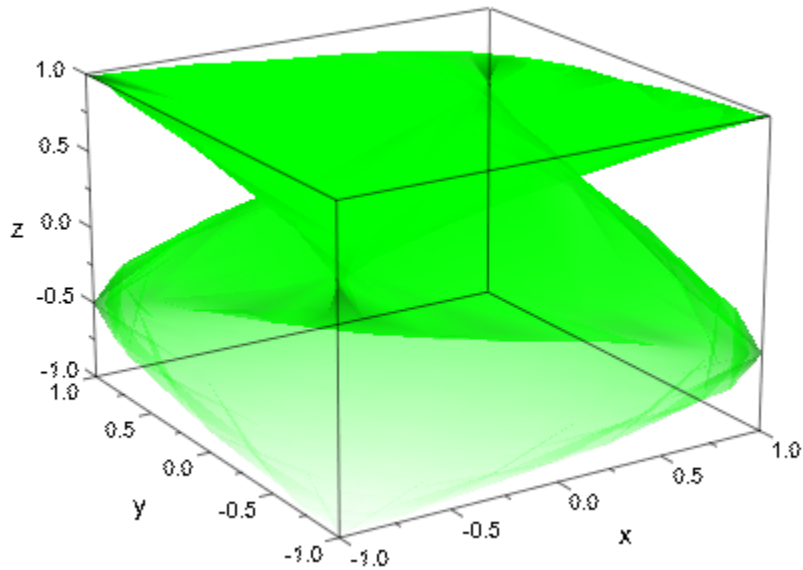

### Example 3

Using a utility function `randrange` that returns random ranges in  $[0, 1]$ , we can plot random rectangles with random colors:

```
randrange := () -> _range(op(sort([frandom(), frandom()])))  
plot(plot::Rectangle(randrange(), randrange(),  
    LinesVisible = FALSE,  
    Filled = TRUE, FillPattern = Solid,  
    FillColor = [frandom(), frandom(), frandom()])  
$k=1..20,  
AxesVisible = FALSE)
```

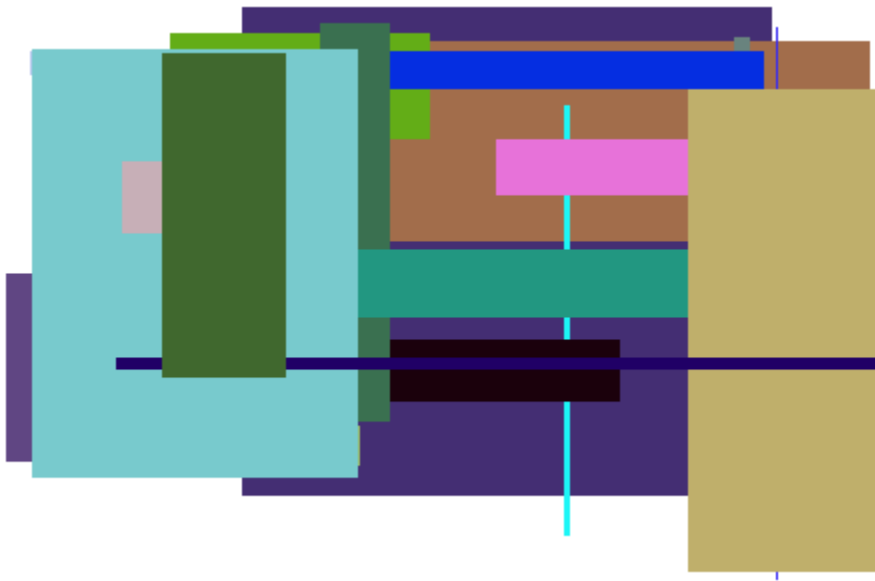

## See Also

### MuPAD Functions

[FillColorType](#) | [FillPattern](#) | [Filled](#) | [LineColor](#) | [Shading](#)

# FillColorDirectionFillColorDirectionXFillColorDirectionYFillColorDirectionZ

Direction of color transitions on surfaces

## Value Summary

FillColorDirection	Library wrapper for "[FillColorDirectionX, FillColorDirectionY]" (2D), "[FillColorDirectionX, FillColorDirectionY, FillColorDirectionZ]" (3D)	See below
FillColorDirectionX, FillColorDirectionY, FillColorDirectionZ	Inherited	Real number



## Graphics Primitives

Objects	Default Values
plot::Arc3d, plot::Cylindrical, plot::Dodecahedron, plot::Ellipse3d, plot::Function3d, plot::Hexahedron, plot::Icosahedron, plot::Implicit3d, plot::Matrixplot, plot::Octahedron, plot::Parallelogram3d, plot::Prism, plot::Pyramid, plot::Spherical, plot::Surface, plot::SurfaceSet, plot::SurfaceSTL, plot::Sweep, plot::Tetrahedron, plot::Tube, plot::Waterman, plot::XRotate, plot::ZRotate	FillColorDirection: [0, 0, 1]  FillColorDirectionX, FillColorDirectionY: 0  FillColorDirectionZ: 1
plot::Listplot	FillColorDirection: [0, 0]

## Description

FillColorDirection determines the direction in which the color transitions for FillColorType = Dichromatic etc. take place.

When setting FillColorType to some other value than Flat or Functional, MuPAD produces a "height-coloring." By default, this color method actually uses the height of a point. Using FillColorDirection, the axis along which the color method should be applied can be changed.

## Examples

### Example 1

By default, MuPAD uses height coloring along the  $z$  axis for 3D objects:

```
s := plot::Spherical([sin(r),thet/(r+1)+1, thet*r],  
                    r=0..1, thet=0..3*PI, Submesh=[2,2]):  
plot(s)
```

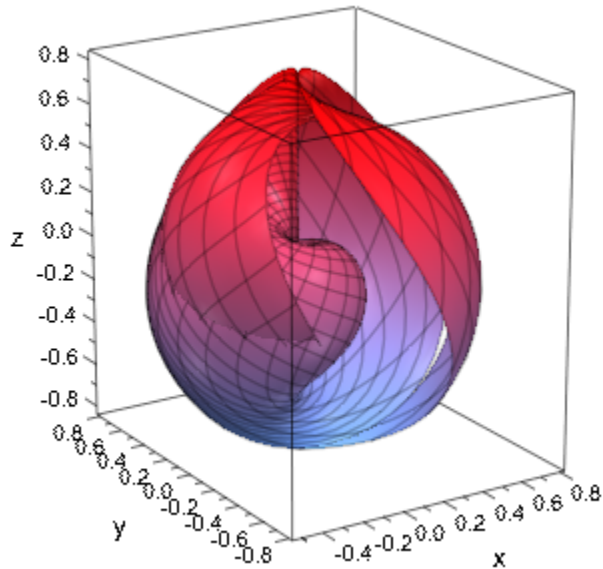

By changing FillColorDirection, the color can be rotated on the object:

```
plot(s, FillColorDirection = [0, 1, 0])
```

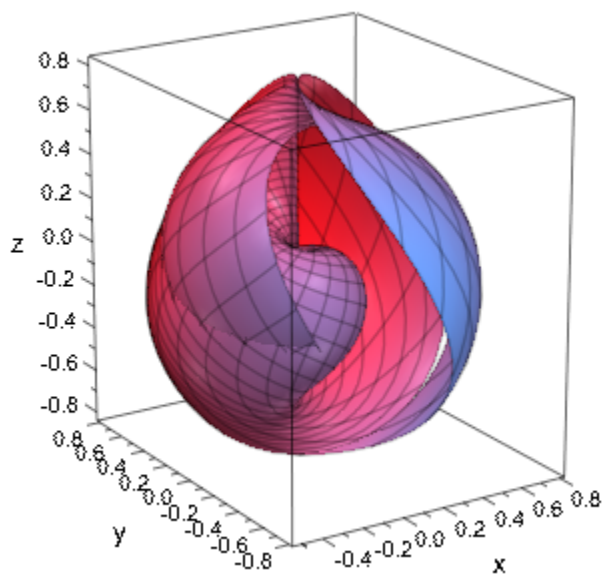

## See Also

### MuPAD Functions

[FillColor](#) | [FillColor2](#) | [FillColorType](#) | [LineColorDirection](#)

## FillColorTrueFillColorFalseFillColorUnknown

Color for “true” areas (inequality plot)

### Value Summary

FillColorFalse, FillColorTrue, FillColorUnknown	Optional	Color
---	----------	-------

### Graphics Primitives

Objects	Default Values
plot::Inequality	FillColorTrue: RGB::Green FillColorFalse: RGB::Red FillColorUnknown: RGB::Black

### Description

FillColorTrue,FillColorFalse, andFillColorUnknown define the three colors use by plot::Inequality for the areas where the inequalities are fulfilled (true), violated (false) or the granularity is too small to decide (unknown).

plot::Inequality divides the plot area into rectangles that are colored according to these three attributes. Rectangles over which the inequalities are true get the color set byFillColorTrue; rectangles over which at least one inequality is violated (i.e., false over the whole rectangle) useFillColorFalse. If neither of these two apply and the rectangle is already too small for subdivision (the settings forXMesh andYMesh control this), it will be painted inFillColorUnknown.

## Examples

### Example 1

We show the same inequality plot with different settings of these three attributes:

```
ineq := plot::Inequality([sin(x)^2>y, y>x^5], x=-1..1, y=-1..1):  
plot(ineq)
```

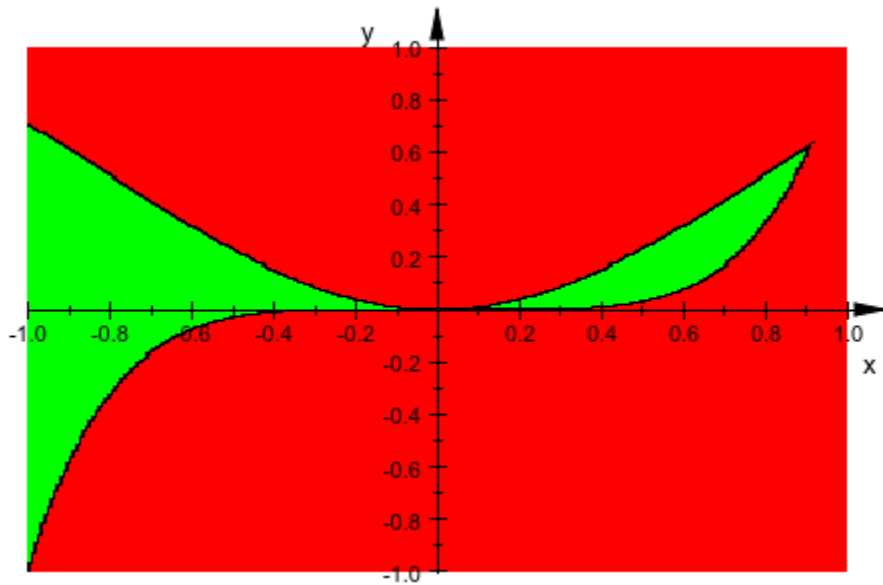

```
ineq::FillColorTrue := RGB::Green:  
ineq::FillColorFalse := RGB::Red:  
ineq::FillColorUnknown := RGB::Blue:  
plot(ineq)
```

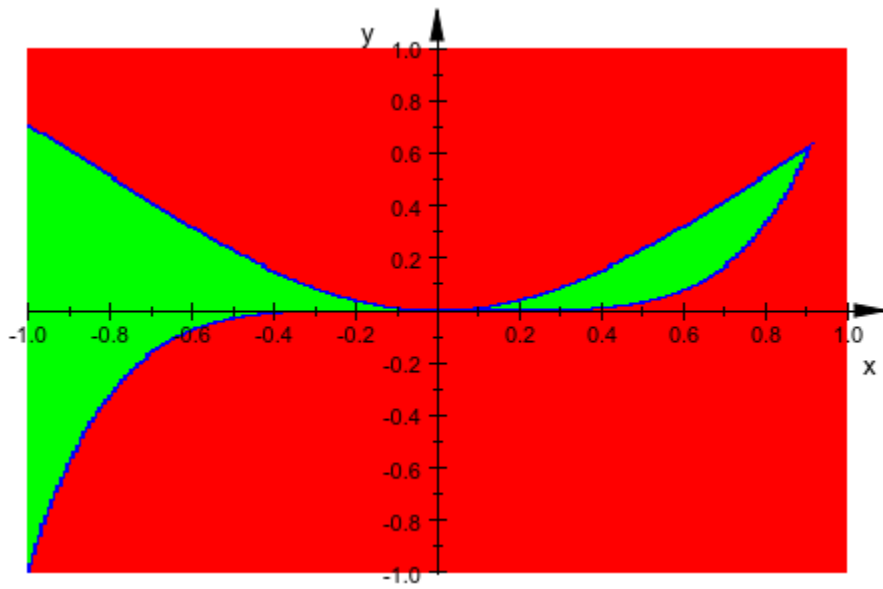

# FillColorType

Surface filling types

## Value Summary

Inherited	Dichromatic, Flat, Functional, Monochrome, or Rainbow
-----------	---

## Graphics Primitives

Objects	FillColorType Default Values
plot::Cylindrical, plot::Density, plot::Dodecahedron, plot::Function3d, plot::Hexahedron, plot::Icosahedron, plot::Implicit3d, plot::Matrixplot, plot::Octahedron, plot::Prism, plot::Pyramid, plot::Spherical, plot::Surface, plot::SurfaceSet, plot::SurfaceSTL, plot::Sweep, plot::Tetrahedron, plot::Tube, plot::XRotate, plot::ZRotate	Dichromatic
plot::Arc3d, plot::Ellipse3d, plot::Parallelogram3d, plot::Waterman	Flat

## Description

FillColorType selects the type of surface fill color used.

With the exception of Flat and Functional, the coloring schemes depend on the height, i.e., the z value of points on the surface, in relation to the height of the whole coordinate

system. (Everything on this page relating to surfaces holds for objects of type `plot::Density`, too, with the values plotted replacing height information.)

By default, surfaces are drawn with a linear blend from `FillColor` to `FillColor2`. This behavior may be changed with `FillColorType`, using one of the following options:

- **Dichromatic**

The default just described.

- **Flat**

The surface is filled with `FillColor`. No blend is used.

- **Monochrome**

The surface is filled with a blend from `FillColor` to a dimmed version of `FillColor`.

- **Rainbow**

This setting is technically similar to `Dichromatic`, but the effect is vastly different, since interpolation takes place in HSV color space. This creates a rainbow effect, similar to a physical rainbow for suitable choices of colors.

- **Functional**

Both `FillColor` and `FillColor2` are ignored; the color scheme is derived from `FillColorFunction`. See `FillColorFunction` for details (which depend on the object type). If no color function is given, the object will be rendered with `FillColorType = Flat`.

In this context, “a blend from *A* to *B*” means that color *A* is used at the top of the coordinate system (the part with the lowest *z* coordinate), color *B* is used at the bottom and in between each or the red, green, blues, and alpha channel are interpolated linearly.

## Examples

### Example 1

By default, function plots use `FillColorType = Dichromatic` with a color range from blue to red (as in a temperature scale):

```
plotfunc3d(sin(x)*sin(y))
```



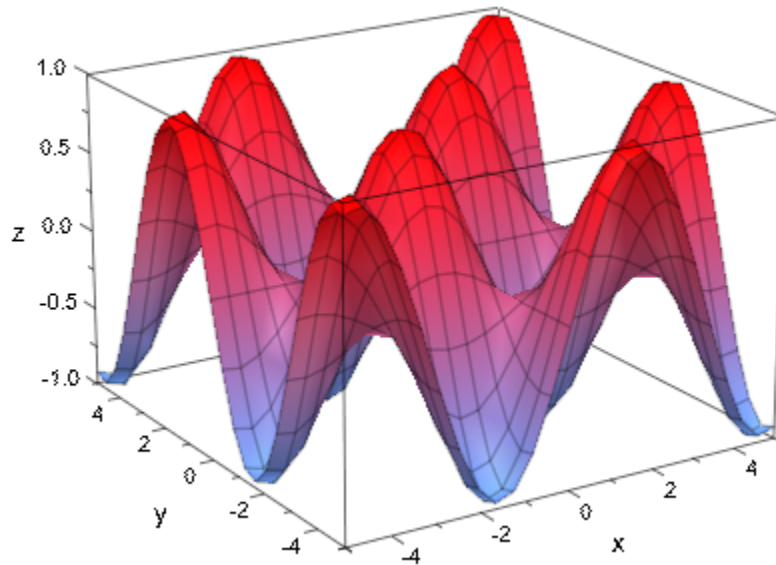

Using `FillColorType`, we color the graph completely in red:

```
plotfunc3d(sin(x)*sin(y), FillColorType = Flat)
```

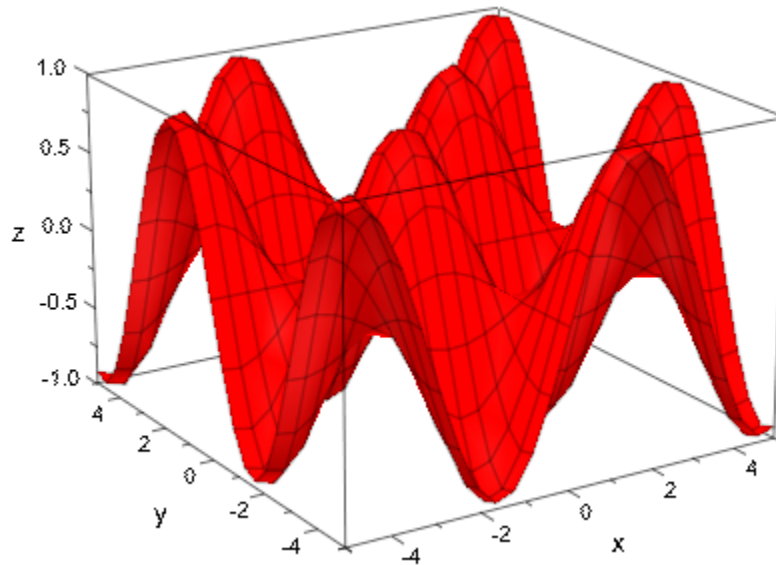

Note, however, that the coloring is a visual aid, e.g., when looking from above:

```
plotfunc3d(sin(x)*sin(y),  
           CameraDirection = [0, 0, 1])
```

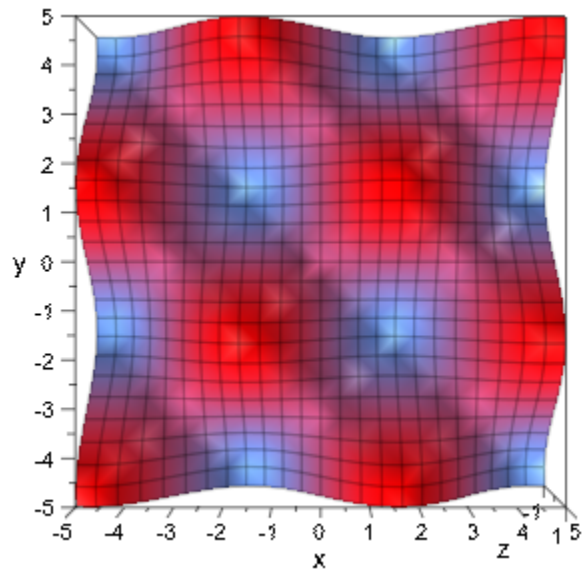

```
plotfunc3d(sin(x)*sin(y), FillColorType = Flat,  
           CameraDirection = [0, 0, 1])
```

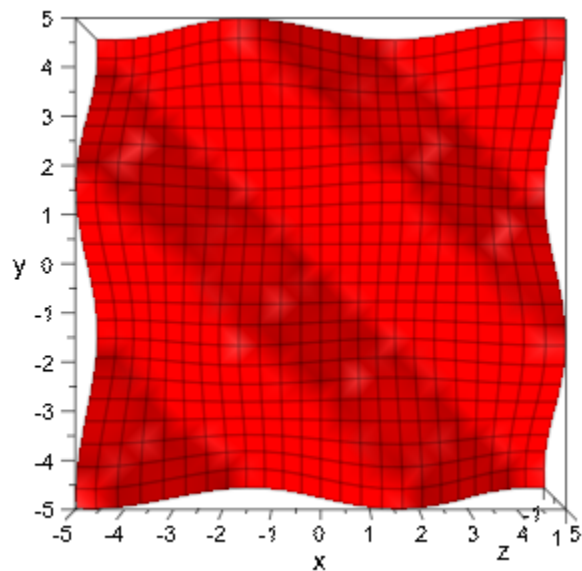

## Example 2

In MuPAD, rainbow coloring does react to `FillColor` and `FillColor2`. The following plot uses different color settings to show this effect:

```
plot(plot::Function3d(sin(y), x = 0..10, y = -PI..PI,
    FillColor = RGB::BlueLight,
    FillColor2 = RGB::Blue),
    plot::Function3d(sin(y), x = 0..10, y = PI..3*PI,
    FillColor = RGB::Green,
    FillColor2 = RGB::Red),
    FillColorType = Rainbow,
    XLinesVisible = FALSE, YLinesVisible = FALSE)
```

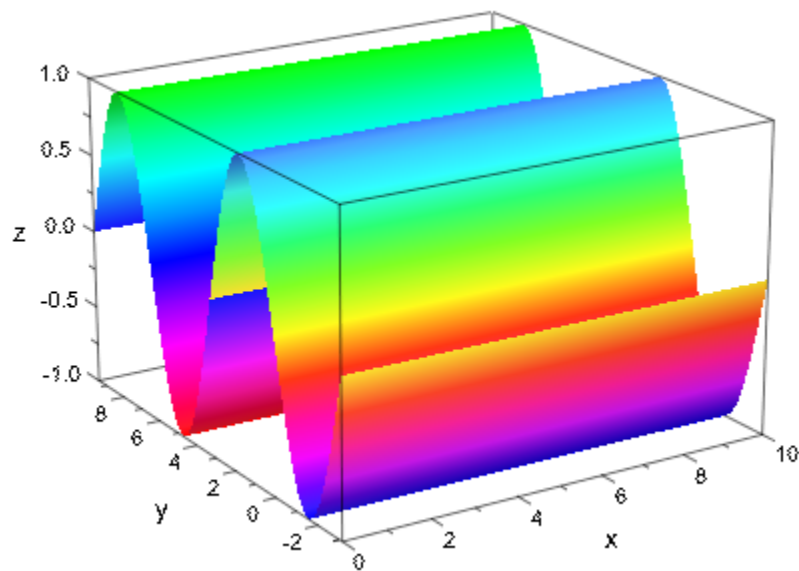

What is happening here technically is that MuPAD performs a linear interpolation in HSV color space, i.e., the *longest* path round the following color circle is followed, with saturation and value (roughly speaking, whiteness and blackness) interpolated linearly:



The opacity of colors is treated the same way in both the Rainbow and Dichromatic settings of `FillColorType`, by linear interpolation:

```
plot((f:=plot::Function3d(sin(y), x = 0..10, y = -PI..PI,  
FillColorType = Rainbow, FillColor2 = RGB::VioletDark.[0.2],  
XLinesVisible = FALSE, YLinesVisible = FALSE)))
```

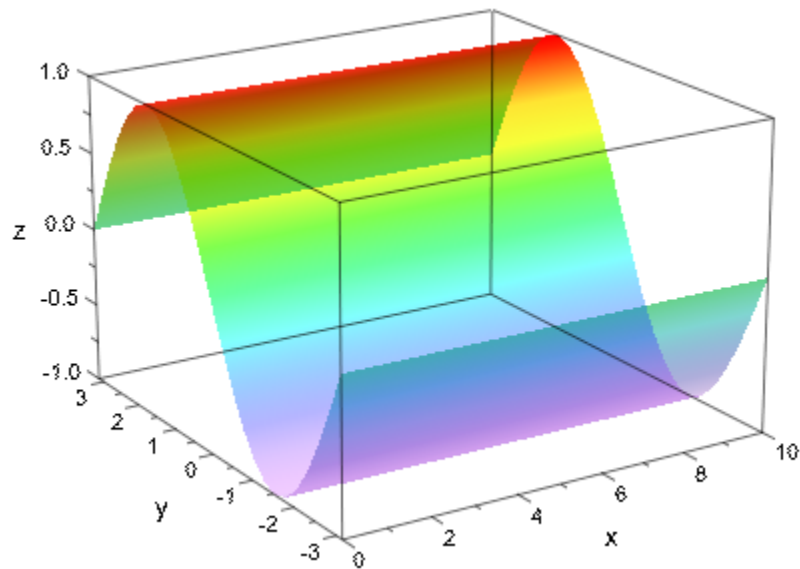

### Example 3

Setting a `FillColorFunction` for an object automatically sets `FillColorType` to `Functional`:

```
colorfunc := (x, y) -> [abs(x)/PI, 0, abs(y)/PI]:  
f := plot::Function3d(sin(x)*cos(y), x = -PI..PI, y = -PI..PI,  
    FillColorFunction = colorfunc):  
f::FillColorType
```

`Functional`

```
plot(f)
```

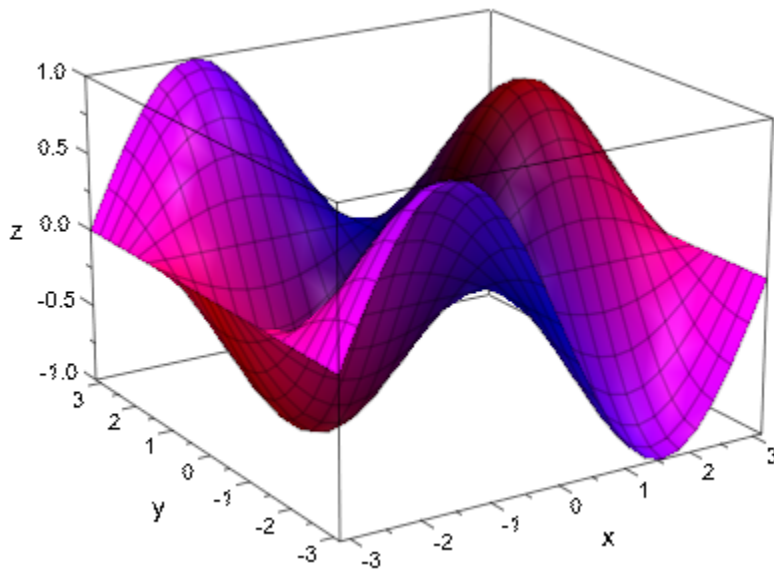

`delete colorfunc, f:`

## See Also

### MuPAD Functions

[FillColor](#) | [FillColor2](#) | [FillPattern](#) | [Filled](#) | [LineColorType](#) | [Shading](#)



# Filled

Filled or transparent areas and surfaces

## Value Summary

Inherited	FALSE, or TRUE
-----------	----------------

## Graphics Primitives

Objects	Filled Default Values
plot::Bars2d, plot::Bars3d, plot::Box, plot::Boxplot, plot::Cone, plot::Cylinder, plot::Cylindrical, plot::Dodecahedron, plot::Function3d, plot::Hexahedron, plot::Histogram2d, plot::Icosahedron, plot::Implicit3d, plot::Integral, plot::Matrixplot, plot::Octahedron, plot::Parallelogram3d, plot::Piechart2d, plot::Piechart3d, plot::Plane, plot::Prism, plot::Pyramid, plot::Spherical, plot::Surface, plot::SurfaceSet, plot::SurfaceSTL, plot::Sweep, plot::Tetrahedron, plot::Tube, plot::Waterman, plot::XRotate, plot::ZRotate	TRUE

Objects	Filled Default Values
<code>plot::Arc2d, plot::Arc3d, plot::Circle2d, plot::Circle3d, plot::Ellipse2d, plot::Ellipse3d, plot::Parallelogram2d, plot::Polygon2d, plot::Polygon3d, plot::Rectangle, plot::Sum</code>	FALSE

## Description

Filled controls whether areas and surfaces are filled or transparent.

With `Filled = FALSE`, areas and surfaces are not filled. This means that, e.g., a surface plot is reduced to a wire frame model.

## Examples

### Example 1

The following parametrization of a sphere uses a mesh similar to the graticule (longitudes and latitudes) of geography:

```
globe := plot::Surface([sin(u)*cos(v), cos(u)*cos(v), sin(v)],  
                       u = 0..2*PI, v = 0..2*PI,  
                       Mesh = [12, 12], Submesh = [3, 3]):  
plot(globe, Scaling = Constrained)
```

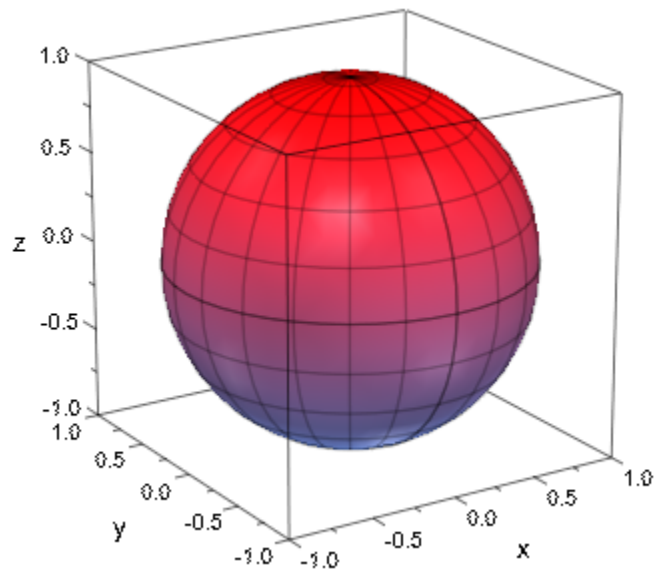

To get a wire frame model, we set `Filled = FALSE`:

```
plot(globe, Filled = FALSE, LineColor = RGB::Black,  
      Scaling = Constrained)
```

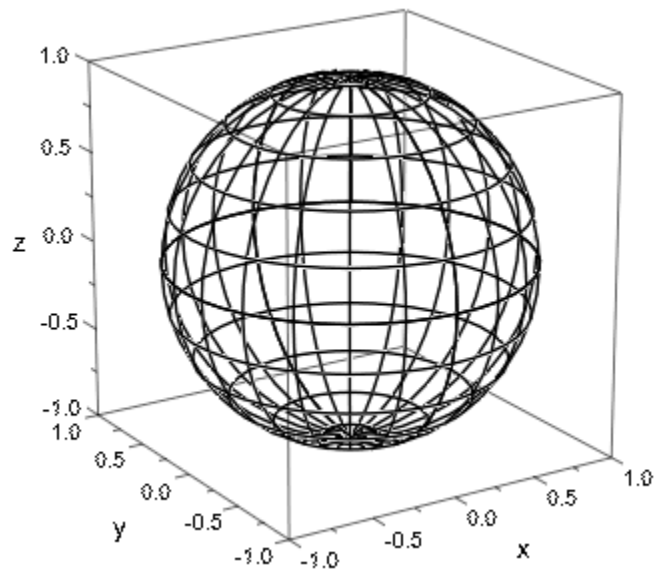

## See Also

### MuPAD Functions

[Colors](#) | [FillColor](#) | [FillColor2](#) | [FillColorType](#) | [FillPattern](#) | [FillStyle](#) | [LinesVisible](#) | [ULinesVisible](#) | [VLinesVisible](#)

# FillPatternFillPatterns

Type of area filling

## Value Summary

FillPattern	Inherited	CrossedLines, DiagonalLines, FDiagonalLines, HorizontalLines, Solid, VerticalLines, or XCrossedLines
FillPatterns	Optional	Solid, HorizontalLines, VerticalLines, DiagonalLines, FDiagonalLines, CrossedLines, or XCrossedLines

## Graphics Primitives

Objects	Default Values
plot::Arc2d, plot::Boxplot, plot::Circle2d, plot::Ellipse2d, plot::Hatch, plot::Parallelogram2d, plot::Polygon2d, plot::Rectangle	FillPattern: DiagonalLines
plot::Bars2d, plot::Histogram2d, plot::Inequality, plot::Integral, plot::Piechart2d, plot::Sum	FillPattern, FillPatterns: Solid

## Description

FillPattern determines the style of area filling used: lines, grids, or a solid fill.

FillPatterns is used for objects with more than one type of area to fill.

Areas can be filled in various ways. You can have horizontal, vertical, or diagonal lines (HorizontalLines, VerticalLines, DiagonalLines, FDiagonalLines), a horizontal/vertical grid (CrossedLines), a diagonal grid (XCrossedLines), or a solid fill (Solid).

For types like `plot::Bars2d`, FillPatterns is a list of fill patterns used cyclically, in this case for the groups of data plotted.

## Examples

### Example 1

The fill patterns look like this:

```
plot(  
  plot::Rectangle(0..1, 0..1, FillPattern = Solid),  
  plot::Rectangle(1..2, 0..1, FillPattern = DiagonalLines),  
  plot::Rectangle(2..3, 0..1, FillPattern = FDiagonalLines),  
  plot::Rectangle(3..4, 0..1, FillPattern = HorizontalLines),  
  plot::Rectangle(4..5, 0..1, FillPattern = VerticalLines),  
  plot::Rectangle(5..6, 0..1, FillPattern = CrossedLines),  
  plot::Rectangle(6..7, 0..1, FillPattern = XCrossedLines),  
  Filled = TRUE, AxesInFront = TRUE  
)
```

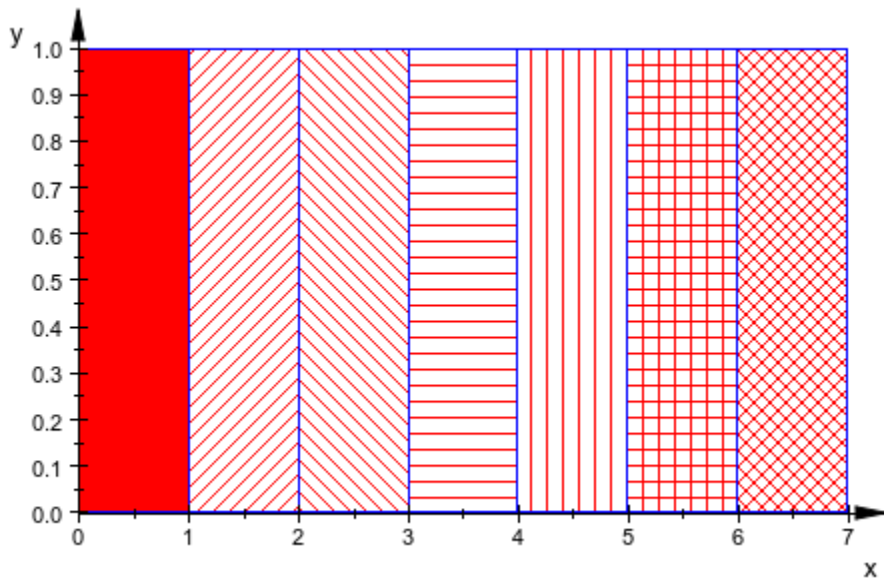

Except for Solid, the fill patterns let objects below be seen:

```
plot(
  plot::Function2d(sin(x*PI/14), x = 0..7, Color = RGB::Black),
  plot::Function2d(cos(x*PI/14), x = 0..7, Color = RGB::Blue),
  plot::Rectangle(0..1, 0..1, FillPattern = Solid),
  plot::Rectangle(1..2, 0..1, FillPattern = DiagonalLines),
  plot::Rectangle(2..3, 0..1, FillPattern = FDiagonalLines),
  plot::Rectangle(3..4, 0..1, FillPattern = HorizontalLines),
  plot::Rectangle(4..5, 0..1, FillPattern = VerticalLines),
  plot::Rectangle(5..6, 0..1, FillPattern = CrossedLines),
  plot::Rectangle(6..7, 0..1, FillPattern = XCrossedLines),
  Filled = TRUE, AxesInFront = TRUE
)
```

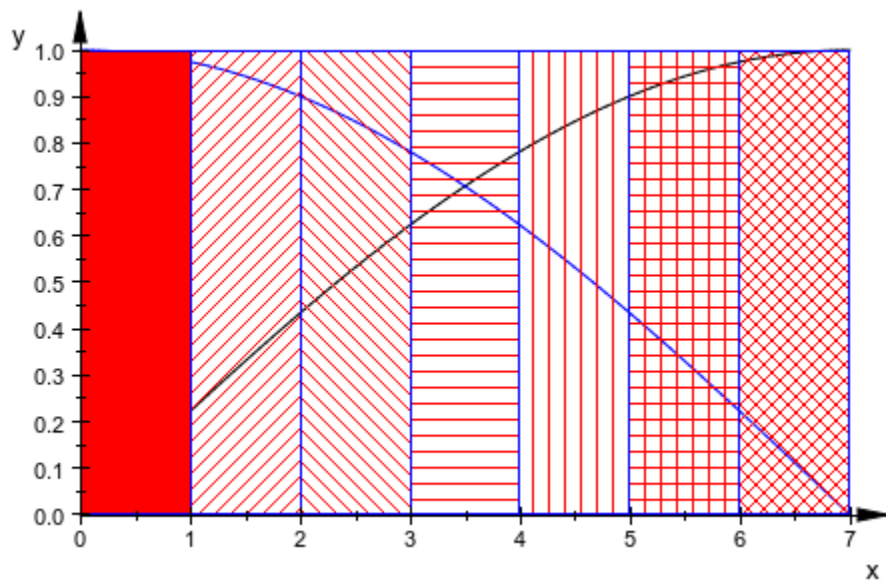

## See Also

### MuPAD Functions

[Color](#) | [Colors](#) | [FillColor](#) | [FillColorType](#) | [Filled](#)



# FillStyle

Definition of inside/outside

## Value Summary

Inherited	EvenOdd, or Winding
-----------	---------------------

## Graphics Primitives

Objects	FillStyle Default Values
<code>plot::Polygon2d</code>	EvenOdd

## Description

For self-intersecting closed curves, `FillStyle` determines how holes are detected/defined.

Closed curves have an inside and an outside. With self-intersecting curves, the inside may have holes which are considered outside and not filled. To explain the difference between `EvenOdd` and `Winding`, we use the following two polygons which differ only in the order the inner points are visited:

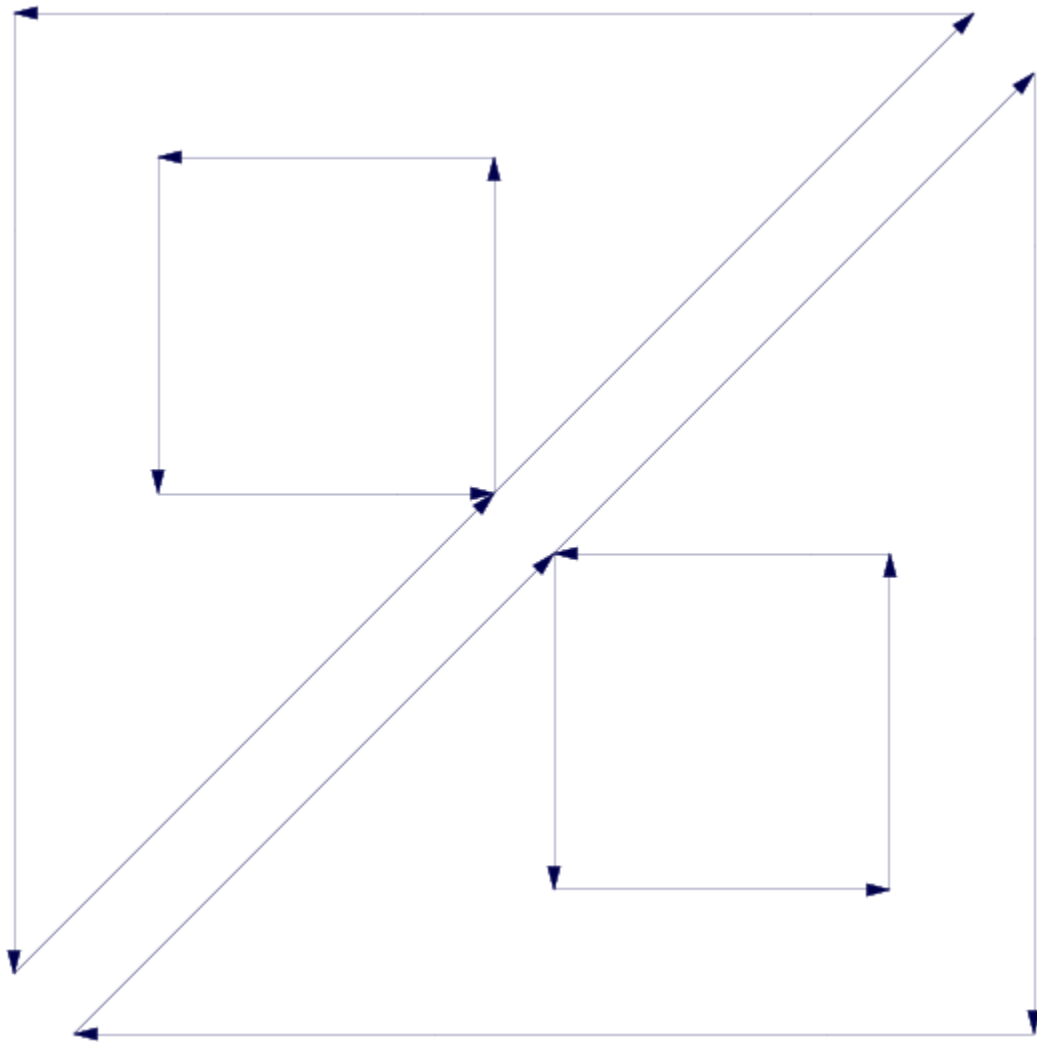

If plotted with `FillStyle = EvenOdd`, there is no difference between the two:



This is because for `FillStyle = EvenOdd`, a point is considered “inside” if a ray starting from the point and extending to infinity has an *odd* number of intersections with the polygon:

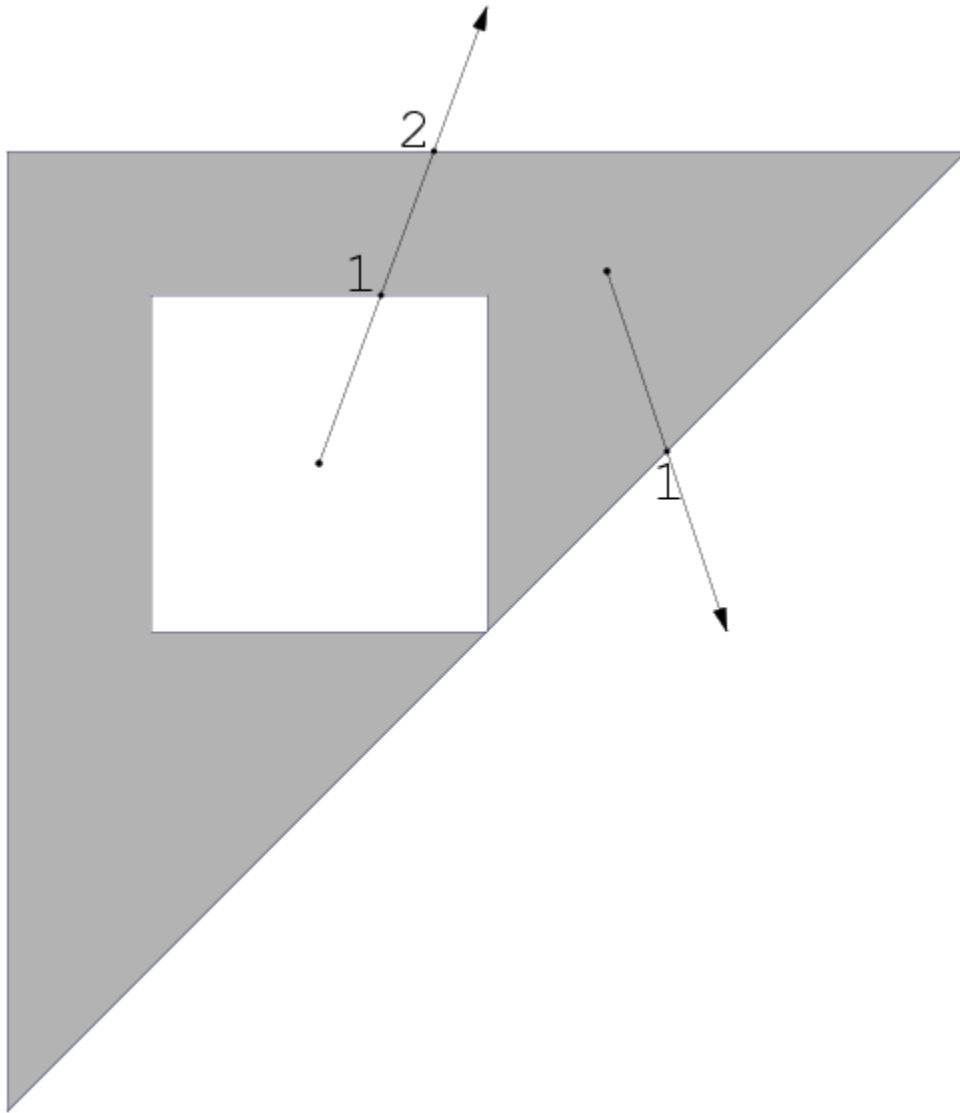

With `FillStyle = Winding`, however, the triangles look different from one another:

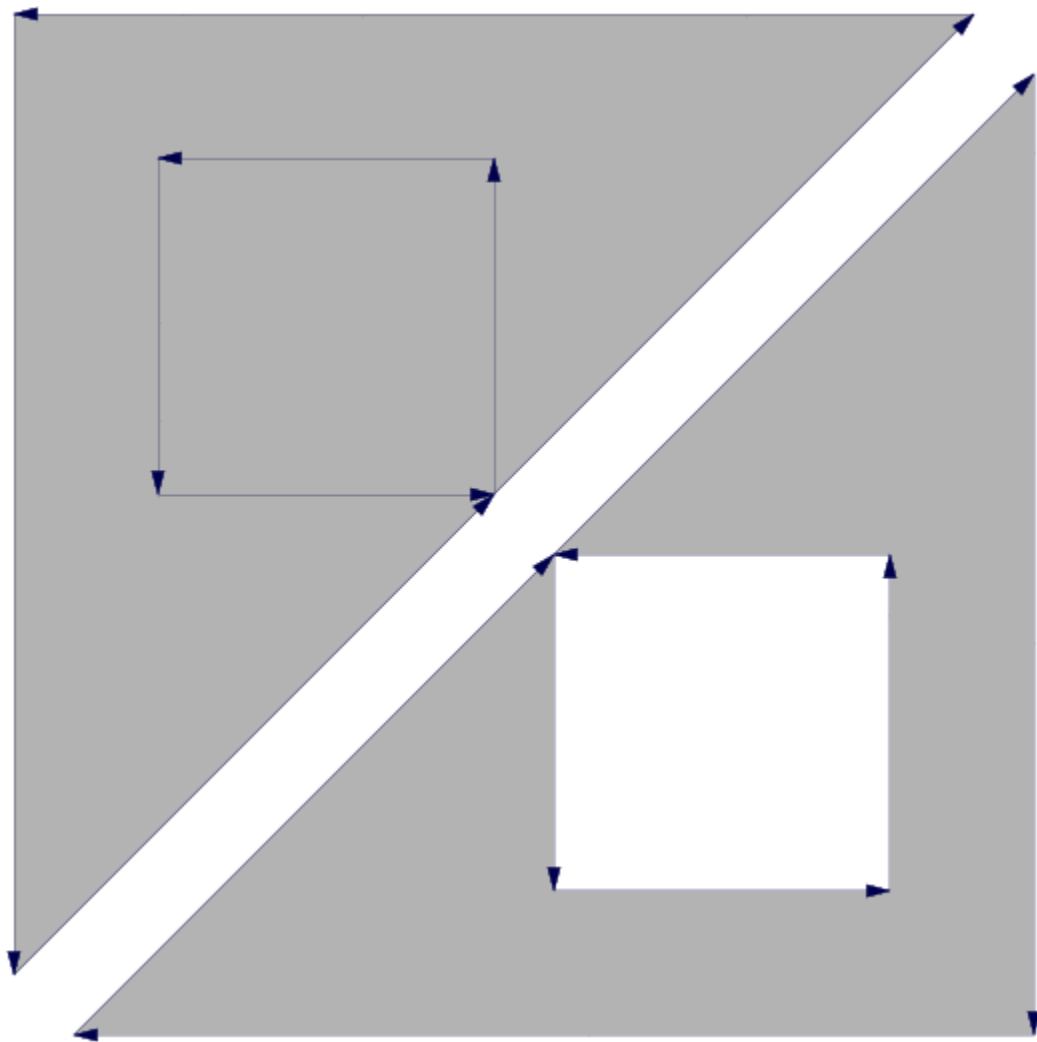

For `FillStyle = Winding`, the *winding number* of a point must be nonzero for this point to be “inside”. The winding number is the number of times the polygon line actually “runs around” the point. It can be determined by sequentially looking at all the edges, summing up the angles under which neighboring edges are seen (take care of the sign of the angle!) and dividing by  $2\pi$ . In our example, a point in the square in the upper triangle

has a winding number of 2, while one in the square in the lower triangle has a winding number of 0:

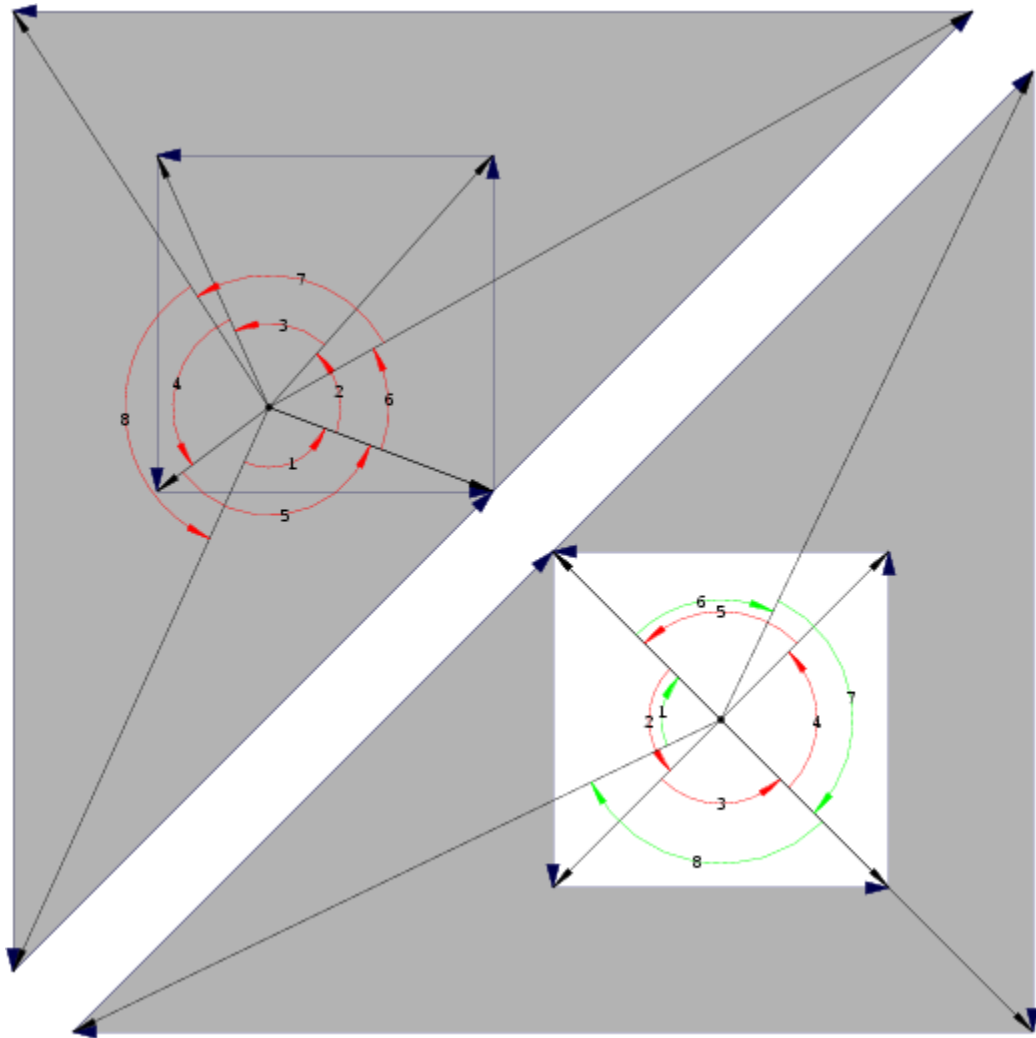

FillStyle = Winding is similar to a complete filling of the polygon area, but it is stable under small displacements of the polygon points:

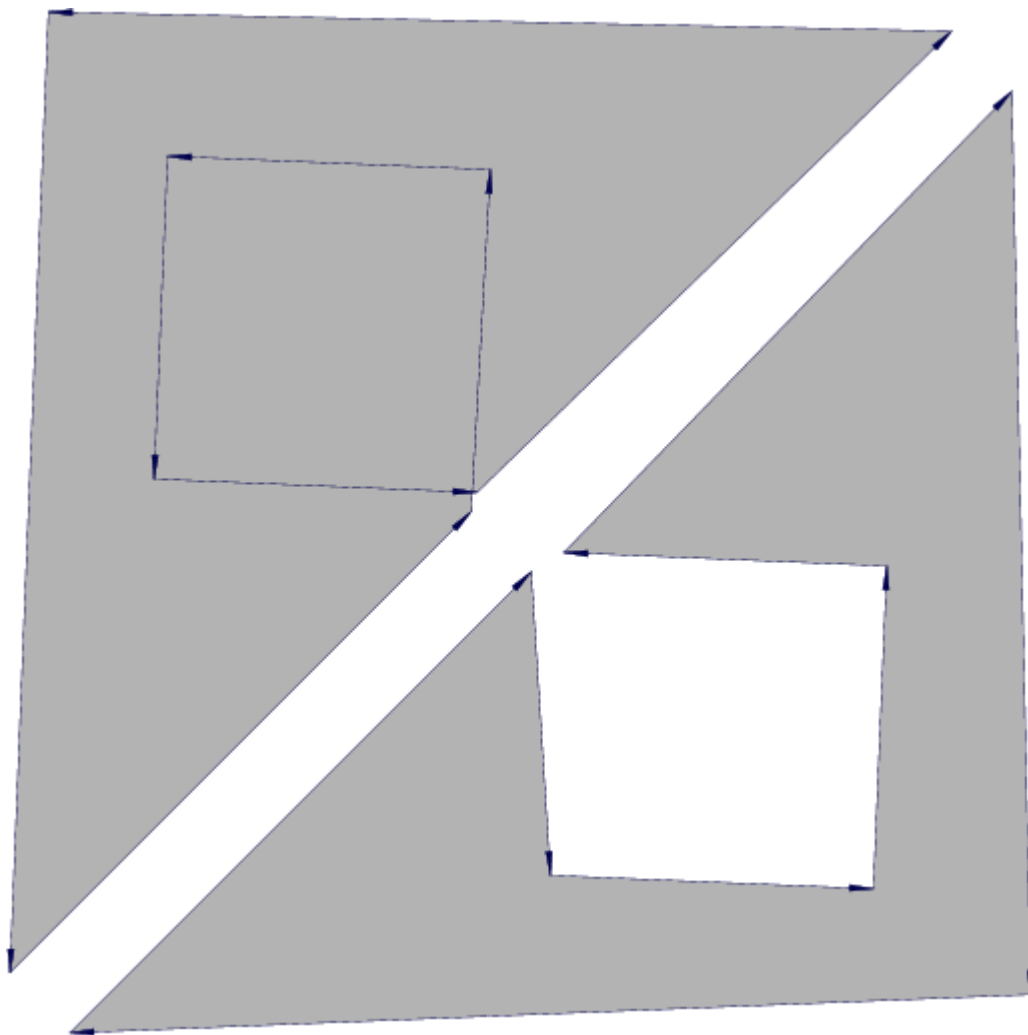

## See Also

**MuPAD Functions**  
Filled

## GroupStyle

Grouping options in 2D bar plots

### Value Summary

Optional	MultipleBars, or SingleBars
----------	-----------------------------

### Graphics Primitives

Objects	GroupStyle Default Values
<code>plot::Bars2d</code>	MultipleBars

### Description

`GroupStyle` determines whether a bar plot visualizes the data of different groups by separate bars or by single bars that are split into colored regions.

2D `plot::Bars2d` can group the bars in various ways. With the default setting `GroupStyle = MultipleBars`, data that are split into several groups are displayed by separate bars for each value in each group. With `GroupStyle = SingleBars`, corresponding data items in different groups are stacked up to one single bar. It is split into differently colored parts that correspond to the different groups.

With `SingleBars`, all data must be nonnegative.

`SingleBars` has no effect if the data of only one group are given. If you wish to visualize the data in a single bar, you have to turn each data item into a separate group. Cf. “Example 2” on page 24-1996 (Symbolic Math Toolbox).



## Examples

### Example 1

The attribute `GroupStyle` can have the values `MultipleBars` or `SingleBars`:

```
group1 := [1.0, 1.2, 0.9, 1.0]:  
group2 := [2.2, 1.9, 1.7, 2.1]:  
data:= [group1, group2]:  
plot(plot::Bars2d(data, GroupStyle = MultipleBars))
```

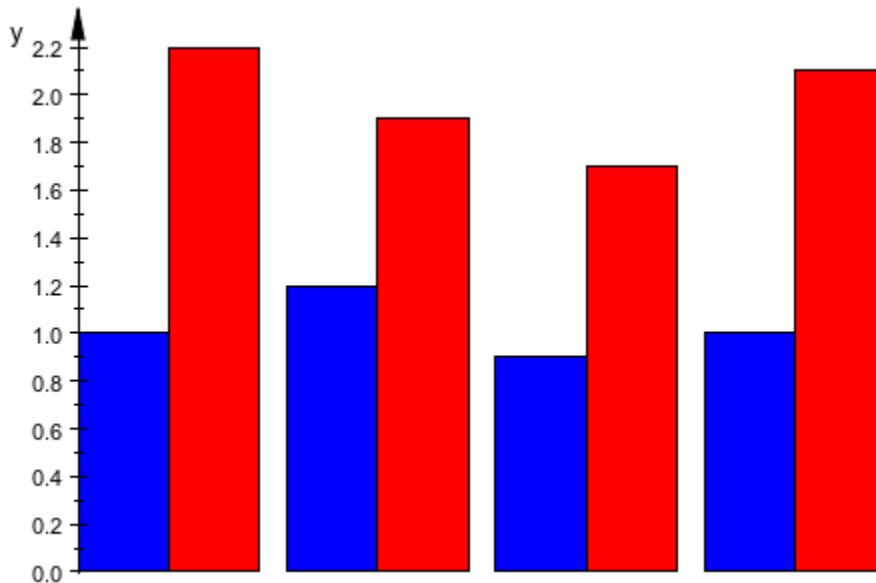

With `SingleBars`, corresponding data items in the different groups are collected in a single bar:

```
plot(plot::Bars2d(data, GroupStyle = SingleBars))
```

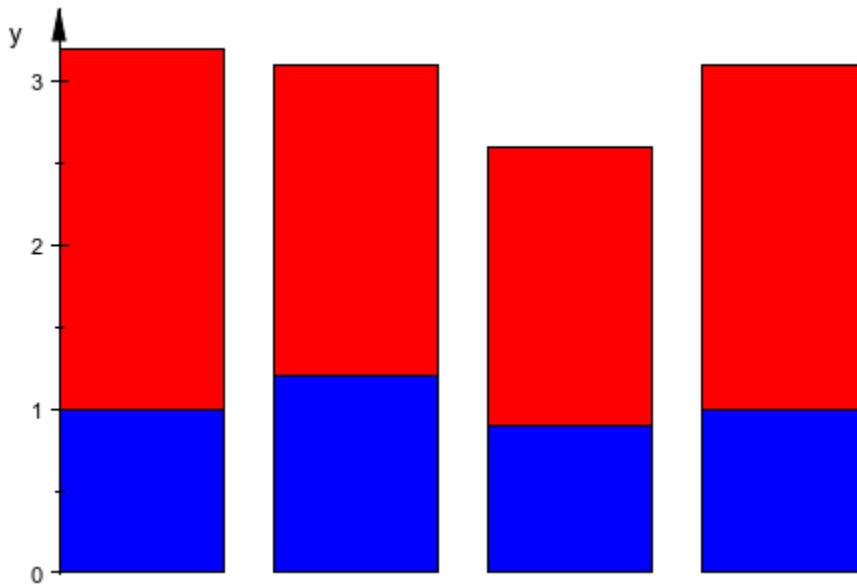

The following data are the australian market shares (in percent) of major car producers in the years 2004 and 2005:

```
// 2004 2005
Toyota:= [21.1, 20.2]:
Holden_GM:= [18.7, 17.9]:
Ford:= [14.0, 13.0]:
Mazda:= [ 5.8,  6.7]:
Mitsubishi:= [ 5.9,  6.4]:
Others:= [34.5, 35.8]:
data:= [Toyota, Holden_GM, Ford, Mazda, Mitsubishi, Others]:
```

We visualize the change of the market shares by bar plots using different group styles:

```
plot(plot::Bars2d(data, GroupStyle = MultipleBars))
```

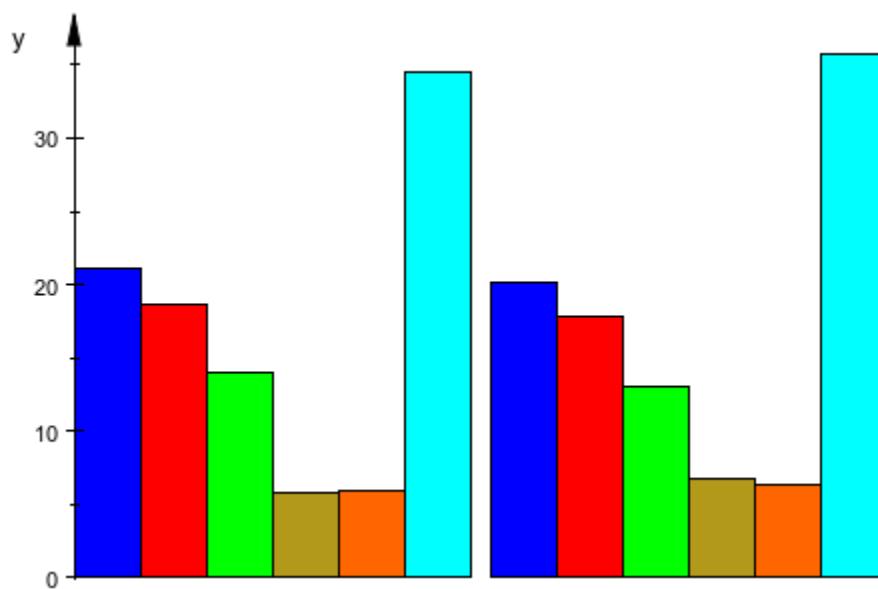

```
plot(plot::Bars2d(data, GroupStyle = SingleBars))
```

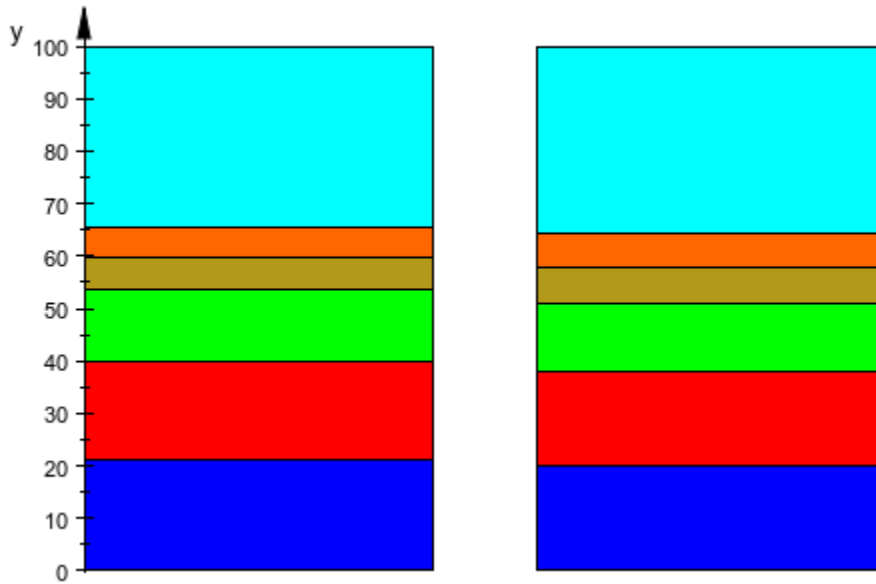

```
delete group1, group2, data, Toyota, Holden_GM,
      Ford, Mazda, Mitsubishi, Others:
```

## Example 2

The option `SingleBars` has no effect when the data of only one group are given:

```
group:= [1, 0.5, 2, PI/3, 2.7]:
plot(plot::Bars2d(group, GroupStyle = SingleBars))
```

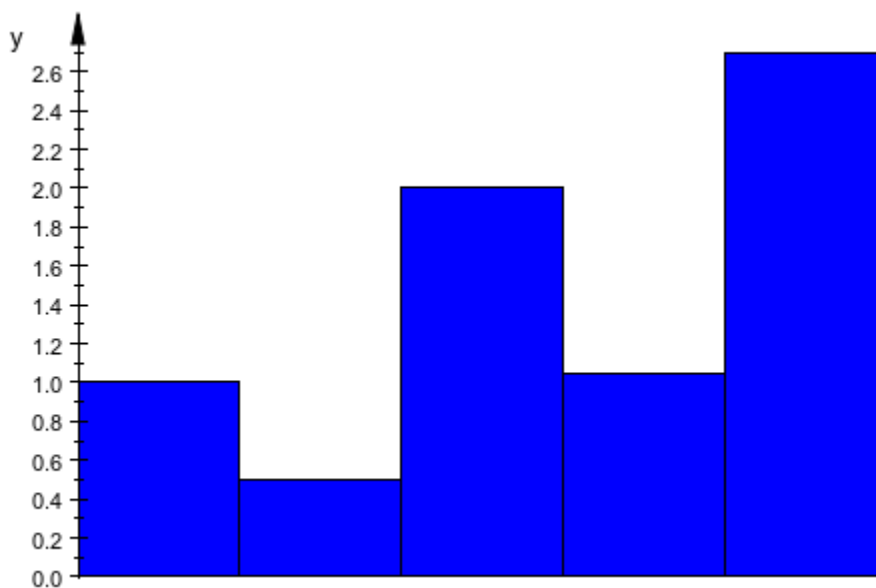

Each value is turned into a separate group:

```
groups:= [[x] $ x in group]
```

```
[1], [0.5], [2], [ $\frac{\pi}{3}$ ], [2.7]
```

Now, `SingleBars` has an effect:

```
plot(plot::Bars2d(groups, GroupStyle = SingleBars,  
  BarCenters = [0.4], BarWidths = [0.3]),  
  ViewingBox = [0..1, Automatic])
```

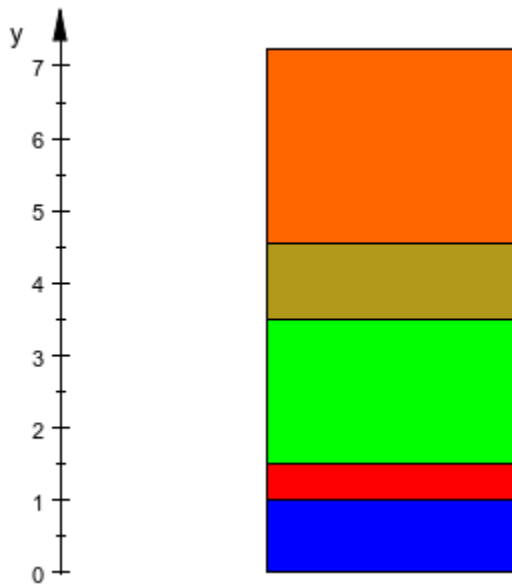

delete group, groups:

## See Also

### MuPAD Functions

BarStyle | Colors | FillPatterns

# InterpolationStyle

Interpolation via linear or cubic splines

## Value Summary

Optional	Cubic, or Linear
----------	------------------

## Graphics Primitives

Objects	InterpolationStyle Default Values
<code>plot::Listplot</code> , <code>plot::Matrixplot</code>	Linear

## Description

`InterpolationStyle` determines whether discrete data are interpolated linearly or via cubic splines.

With the default setting `InterpolationStyle = Linear`, the curve connecting the data points in a plot of type `plot::Listplot` consists of line segments. Similarly, the surface generated from the matrix data in `plot::Matrixplot` consists of linear segments (triangles).

These plot objects do not react to the attribute `Submesh` when using linear interpolation.

With `InterpolationStyle = Cubic`, the curve connecting the data points in a plot of type `plot::Listplot` is the graph of the cubic spline function interpolating the data points. Similarly, the surface generated by `plot::Matrixplot` is the graph of the cubic spline function interpolating the matrix data.

The spline functions can be rendered smoothly by setting appropriate values for the attribute `Submesh`.

For large amounts of data, rendering with cubic spline interpolation may be much more costly than linear interpolation.

## Examples

### Example 1

We sample the function  $f(x) = \frac{1}{(1+x)}$  at various points and store the data in a list. The data are displayed via `plot::Listplot` with different interpolation styles:

```
L := [1 - (i/2)^2 $ i = -2..2]:
plot(plot::Listplot(L, x = -1..1, InterpolationStyle = Cubic,
  Color = RGB::Red),
  plot::Listplot(L, x = -1..1, InterpolationStyle = Linear,
  Color = RGB::Blue)):
```

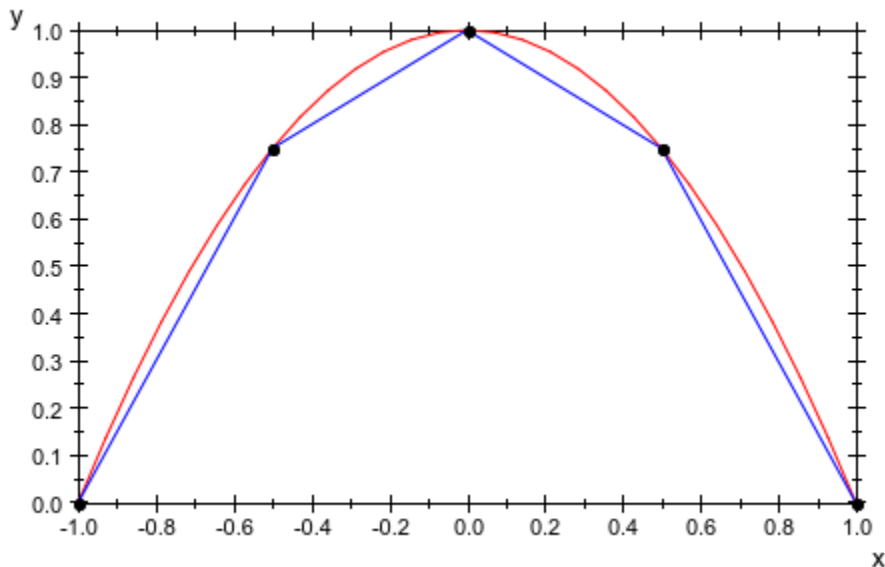

`delete L:`

### Example 2

We sample the function  $f(x, y) = 1 - x^2 - y^2$  at various points and store the data in a matrix. The matrix data are displayed as a matrix plot with different interpolation styles:



```
A := matrix([[1 - (i/2)^2 - (j/2)^2 $ j = 0..2] $ i = 0..2]):  
plot(plot::Matrixplot(A, x = 0..2, y = 0..2,  
    InterpolationStyle = Cubic),  
    plot::Matrixplot(A, x = 4..6, y = 0..2,  
    InterpolationStyle = Linear),  
    CameraDirection = [10, 15, 9]):
```

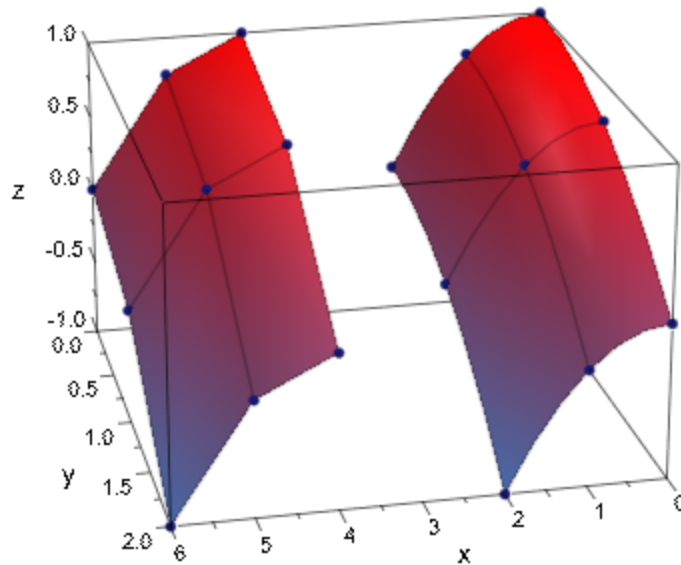

delete A:

## See Also

### MuPAD Functions

Submesh

## Shading

Smooth color blend of surfaces

### Value Summary

Inherited	Flat, or Smooth
-----------	-----------------

### Graphics Primitives

Objects	Shading Default Values
plot::Cone, plot::Dodecahedron, plot::Ellipsoid, plot::Function3d, plot::Hexahedron, plot::Icosahedron, plot::Implicit3d, plot::Matrixplot, plot::Octahedron, plot::Prism, plot::Pyramid, plot::Sphere, plot::Surface, plot::SurfaceSet, plot::SurfaceSTL, plot::Tetrahedron, plot::Tube, plot::Waterman, plot::XRotate, plot::ZRotate	Smooth

### Description

Using `Shading`, a smooth color blend of triangulated surfaces can be (de-)activated.

Most surfaces in 3D are triangulated for display. The triangles are then drawn using Gouraud-shading to achieve a smooth visual effect. Using `Shading = Flat`, you can instruct the viewer to display the plain triangles.

## Examples

### Example 1

Reducing the mesh density of a surface usually has more effect on its outer rim than on the display of the middle:

```
plot(plot::Spherical([1, u, v], u=0..PI, v=0..2*PI,  
                    UMesh=5, VMesh=5))
```

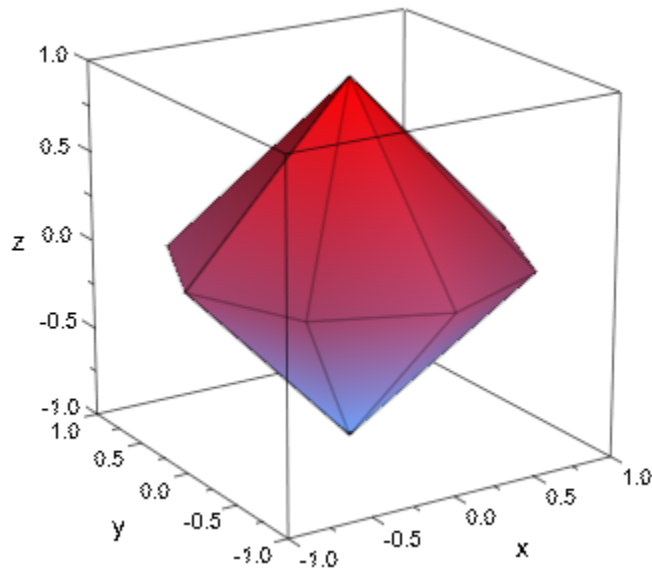

Setting `Shading = Flat`, you can see the triangles from which the sphere is constructed:

```
plot(plot::Spherical([1, u, v], u=0..PI, v=0..2*PI,  
                    UMesh=5, VMesh=5),  
      Shading = Flat)
```

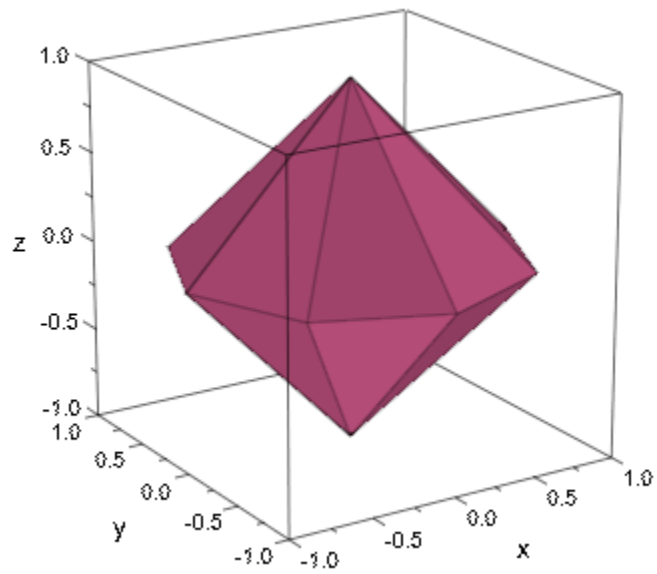

## See Also

### MuPAD Functions

[Lighting](#) | [UMesh](#) | [USubmesh](#) | [VMesh](#) | [VSubmesh](#)

# UseNormals

Use predefined normals?

## Value Summary

Optional	TRUE or FALSE
----------	---------------

## Graphics Primitives

Objects	UseNormals Default Values
plot::SurfaceSet, plot::SurfaceSTL	TRUE

## Description

UseNormals controls whether predefined normals of triangulation data are used when plotting a surface.

With UseNormals = FALSE, the predefined normals given in the triangulation data (MeshList) of a plot::SurfaceSet or in an STL file imported by a plot::SurfaceSTL are ignored when plotting this surface. This may reduce the data volume of the graphical object and the computing time as well. However, it usually leads to a somewhat less brilliant image.

## Examples

### Example 1

By default, the normals defined in STL files are used when plotting the corresponding MuPAD object. For comparison, an STL graphics is plotted with and without using the normals provided by the STL file:

```
plot(plot::Scene3d(plot::SurfaceSTL("skin.stl")),  
      plot::Scene3d(plot::SurfaceSTL("skin.stl",  
                                     UseNormals = FALSE)),  
      Width = 120*unit::mm, Height = 140*unit::mm,  
      Layout = Vertical, BackgroundStyle = Pyramid,  
      Axes = None):
```

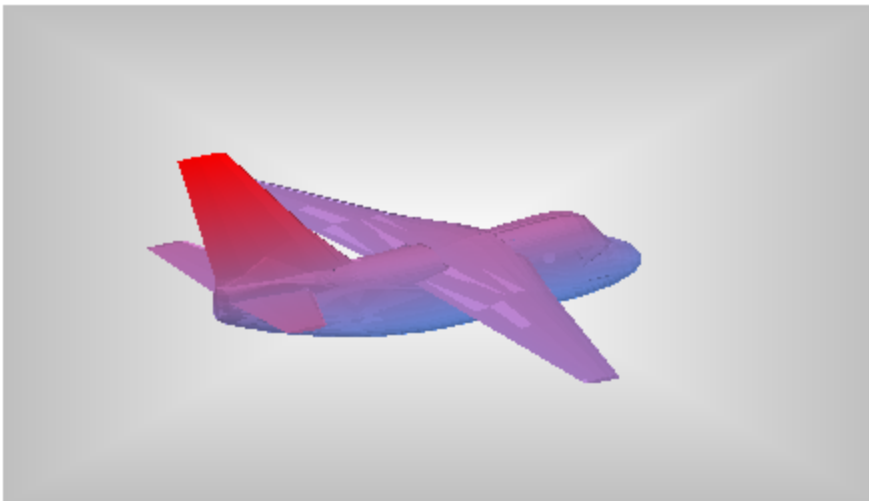
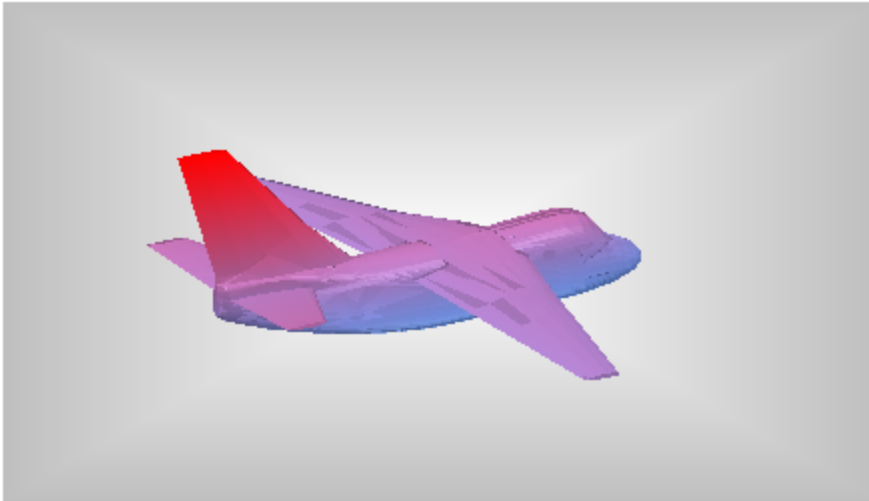

## See Also

### **MuPAD Functions**

Filled | MeshList | MeshListNormals

## TipAngle

Opening angle of arrow heads

### Value Summary

Inherited	Positive real number
-----------	----------------------

### Graphics Primitives

Objects	TipAngle Default Values
plot::Arrow2d, plot::Arrow3d, plot::Streamlines2d	$(2 \cdot \text{PI}) / 15$
plot::VectorField2d	0.6283185307

### Description

TipAngle determines the opening angle of arrow heads in radians.

TipAngle determines the opening angle of the tips of arrows of type `plot::Arrow2d` and `plot::Arrow3d`. Also the arrow tips in a vector field of type `plot::VectorField2d` are controlled by TipAngle. The opening angle must be specified in radians. Values for TipAngle between 0 and  $\pi$  are reasonable.

The tip angle is the geometric angle of the arrow heads as visible in the graphical output. It is invariant under scaling and zooming.

The values of TipAngle cannot be animated.

The attribute TipStyle sets the presentation style of arrow tips. TipLength sets the physical tip length.



## Examples

### Example 1

We create an arrow whose arrow tip has an angle of 20 degrees. This corresponds to  $\frac{\pi}{9}$  radians:

```
plot(plot::Arrow2d([0, 0], [1, 1], TipAngle = PI/9,
                  TipLength = 10*unit::mm)):
```

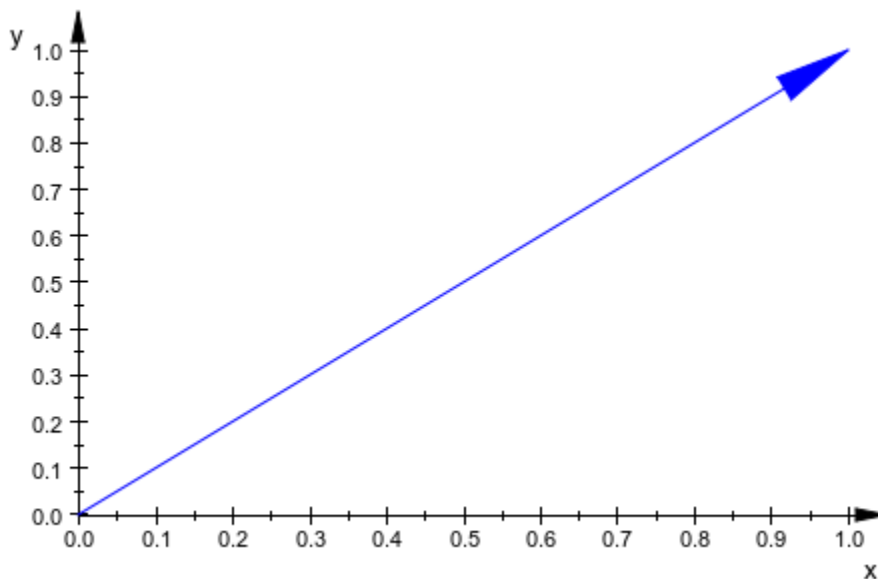

We create several arrows with different tip angles. The angle is increased by 10 degrees from one arrow to the next:

```
plot(plot::Arrow2d([0, 0], [cos(a*2*PI/18), sin(a*2*PI/18)],
                  TipAngle = a*PI/18) $ a = 0 .. 17,
      Scaling = Constrained):
```

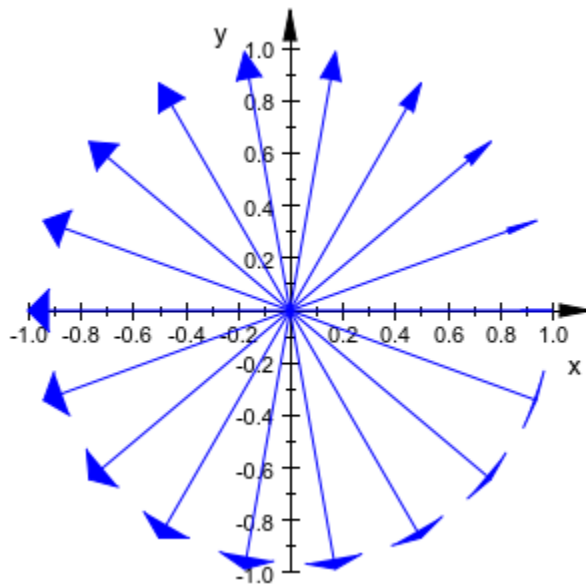

Here are corresponding arrows in 3D:

```
plot(plot::Arrow3d([0, 0, 0],  
                  [cos(a*2*PI/18), sin(a*2*PI/18), 0],  
                  TipAngle = a*PI/18) $ a = 0 .. 17,  
      Scaling = Constrained,  
      CameraDirection = [0, -10, 1000]):
```

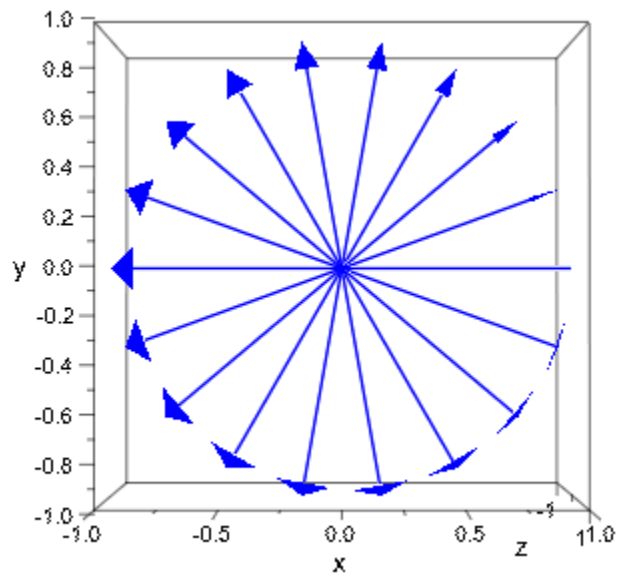

We use Tubular = TRUE:

```
plot(plot::Arrow3d([0, 0, 0],  
                  [cos(a*2*PI/18), sin(a*2*PI/18), 0],  
                  TipAngle = a*PI/18) $ a = 0 .. 17,  
      Tubular = TRUE, Scaling = Constrained,  
      CameraDirection = [0, -10, 1000]):
```

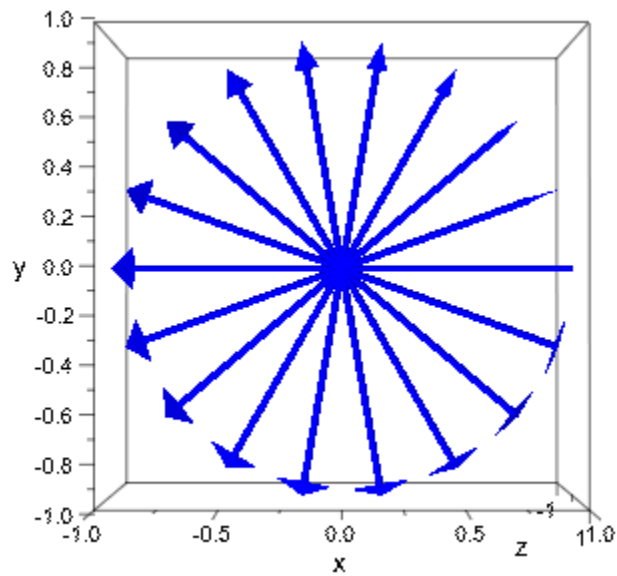

## See Also

### MuPAD Functions

[TipLength](#) | [TipStyle](#) | [TubeDiameter](#) | [Tubular](#)

# TipLength

Length of arrow heads

## Value Summary

Inherited	Non-negative output size
-----------	--------------------------

## Graphics Primitives

Objects	TipLength Default Values
<code>plot::Arrow2d</code> , <code>plot::Arrow3d</code>	4
<code>plot::VectorField2d</code>	1.5
<code>plot::Streamlines2d</code>	0

## Description

TipLength determines the physical length of arrow heads

TipLength determines the length of the tips of arrows of type `plot::Arrow2d` and `plot::Arrow3d`. Also the arrow tips in a vector field of type `plot::VectorField2d` are controlled by TipLength. The value should be specified as an absolute physical length including a length unit on page 1-2196 such as `TipLength = 2.5*unit::mm`. Numbers without a physical unit give the size in mm.

The tip length is the physical length of the arrow heads as visible in the graphical output. It is invariant under scaling and zooming.

The values of TipLength cannot be animated.

The attribute TipStyle sets the presentation style of arrow tips. TipAngle sets the opening angle of the tips.

## Examples

### Example 1

We create an arrow whose tip has physical length of 10 mm:

```
plot(plot::Arrow2d([0, 0], [1, 1], TipAngle = PI/9,  
                  TipLength = 10*unit::mm)):
```

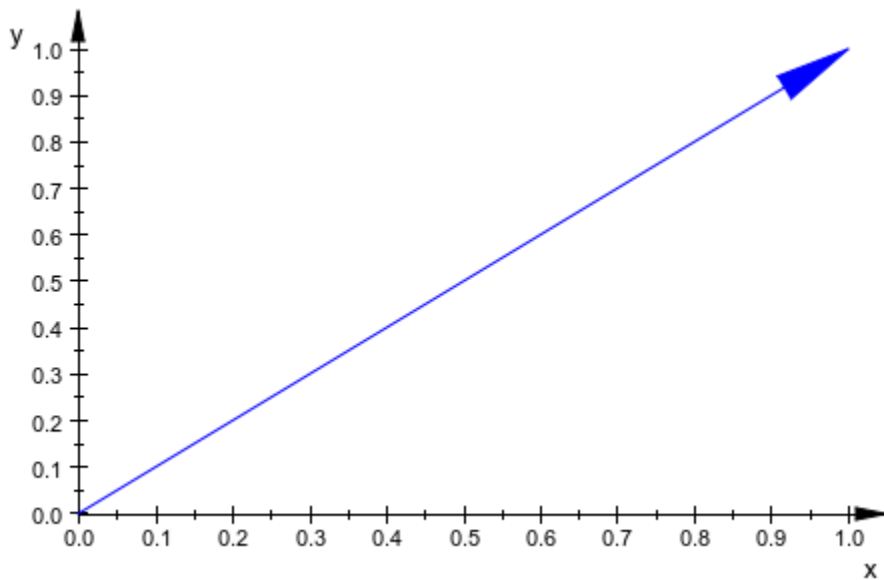

We create several arrows with different tip lengths. The length is increased by 0.7 mm from one arrow to the next:

```
plot(plot::Arrow2d([0, 0], [cos(a*2*PI/18), sin(a*2*PI/18)],  
                  TipLength = a*unit::mm) $ a = 0 .. 17,  
     plot::Circle2d(1, [0, 0]),  
     Scaling = Constrained):
```

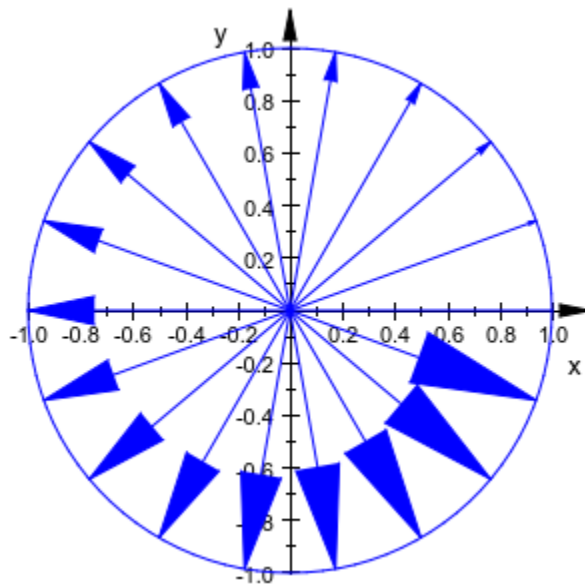

Here are corresponding arrows in 3D:

```
plot(plot::Arrow3d([0, 0, 0],
                  [cos(a*2*PI/18), sin(a*2*PI/18), 0],
                  TipLength = a*unit::mm) $ a = 0 .. 17,
      plot::Circle3d(1, [0, 0, 0], [0, 0, 1]),
      Scaling = Constrained,
      CameraDirection = [0, -10, 1000]):
```

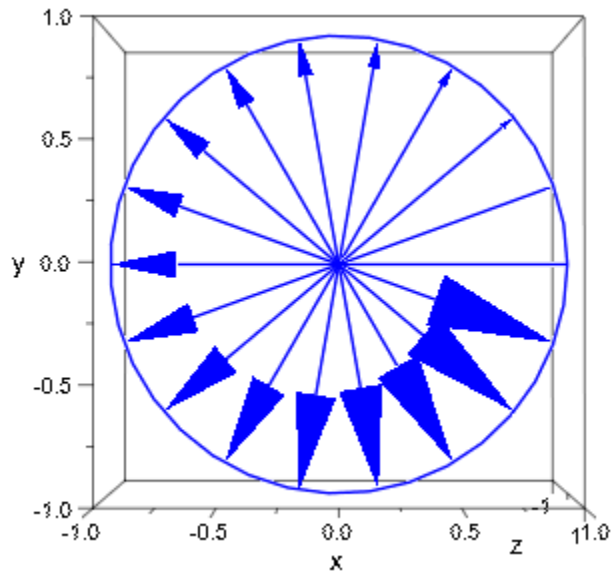

We use Tubular = TRUE:

```
plot(plot::Arrow3d([0, 0, 0],  
                  [cos(a*2*PI/18), sin(a*2*PI/18), 0],  
                  TipLength = a*unit::mm) $ a = 0 .. 17,  
      plot::Circle3d(1, [0, 0, 0], [0, 0, 1]),  
      Tubular = TRUE, Scaling = Constrained,  
      CameraDirection = [0, -10, 1000]):
```



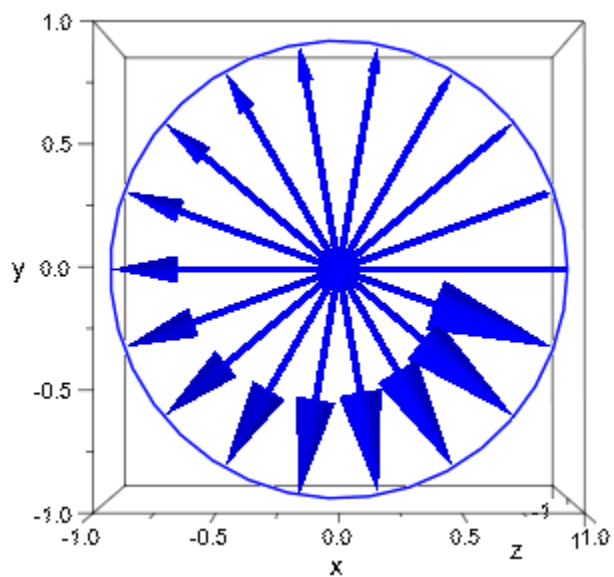

## See Also

### MuPAD Functions

[TipAngle](#) | [TipStyle](#) | [TubeDiameter](#) | [Tubular](#)

## TipStyle

Presentation style of arrow heads

### Value Summary

Inherited	Closed, Filled, or Open
-----------	-------------------------

### Graphics Primitives

Objects	TipStyle Default Values
<code>plot::Arrow2d</code> , <code>plot::Arrow3d</code> , <code>plot::Streamlines2d</code>	Filled
<code>plot::VectorField2d</code>	Open

### Description

`TipStyle` governs the appearance of arrow heads.

`TipStyle` determines how the tips of arrows of type `plot::Arrow2d` and `plot::Arrow3d` look. Also the arrow tips in a vector field of type `plot::VectorField2d` are controlled by `TipStyle`.

With `TipStyle = Open`, the tips are given by two lines.

With `TipStyle = Closed`, the tips are given by a triangle.

With `TipStyle = Filled`, the tips are given by a filled triangle.

`TipStyle` cannot be animated.

The opening angle and the physical length of the arrow tips are set by the attributes `TipAngle` and `TipLength`, respectively.

## Examples

### Example 1

We draw arrows with different tip styles:

```
plot(plot::Arrow2d([0, 0], [1, 0],  
                  TipStyle = Open),  
      plot::Arrow2d([0, 0], [cos(2*PI/3), sin(2*PI/3)],  
                  TipStyle = Closed),  
      plot::Arrow2d([0, 0], [cos(4*PI/3), sin(4*PI/3)],  
                  TipStyle = Filled),  
      Axes = None, ViewingBox = [-1..1, -1..1],  
      TipLength = 8*unit::mm, TipAngle = PI/5,  
      Scaling = Constrained):
```

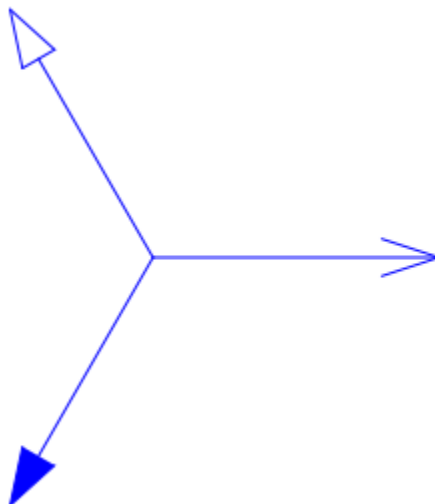

Here are corresponding arrows in 3D:

```
plot(plot::Arrow3d([0, 0, 0], [1, 0, 0],  
                  TipStyle = Open),  
      plot::Arrow3d([0, 0, 0], [cos(2*PI/3), sin(2*PI/3), 0],
```

```
        TipStyle = Closed),
plot::Arrow3d([0, 0, 0], [cos(4*PI/3), sin(4*PI/3), 0],
        TipStyle = Filled),
ViewingBox = [-1..1, -1..1, -1..1],
TipLength = 8*unit::mm, TipAngle = PI/5,
Scaling = Constrained, CameraDirection = [2, -10, 15]):
```

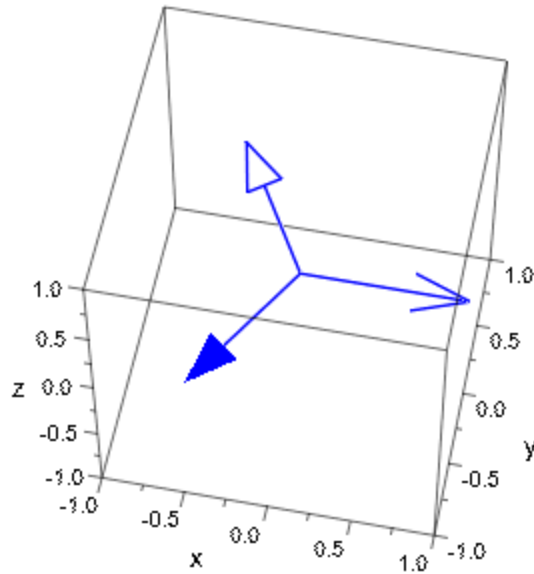

We use `Tubular = TRUE`:

```
plot(plot::Arrow3d([0, 0, 0], [1, 0, 0],
        TipStyle = Open),
plot::Arrow3d([0, 0, 0], [cos(2*PI/3), sin(2*PI/3), 0],
        TipStyle = Closed),
plot::Arrow3d([0, 0, 0], [cos(4*PI/3), sin(4*PI/3), 0],
        TipStyle = Filled),
TipLength = 8*unit::mm, TipAngle = PI/5,
Tubular = TRUE, ViewingBox = [-1..1, -1..1, -1..1],
Scaling = Constrained, CameraDirection = [2, -10, 15]):
```

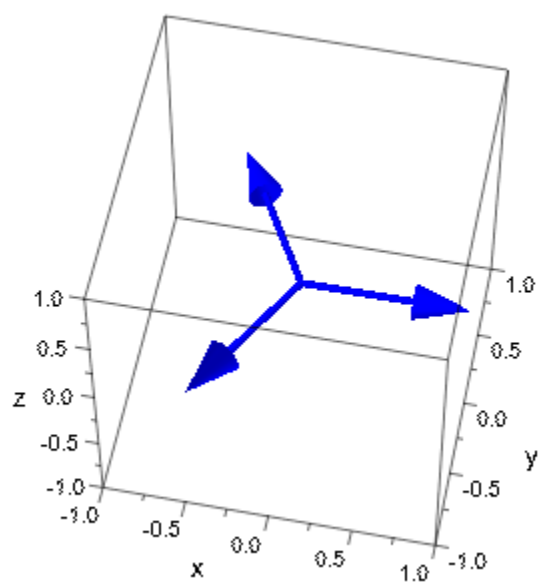

## See Also

### MuPAD Functions

[TipAngle](#) | [TipLength](#) | [TubeDiameter](#) | [Tubular](#)

# TubeDiameter

Diameter of tubular arrows and lines. , and coordinate axes

## Value Summary

Inherited	Positive output size
-----------	----------------------

## Graphics Primitives

Objects	TubeDiameter Default Values
<code>plot::Arrow3d</code> , <code>plot::Line3d</code>	1.0

## Description

TubeDiameter governs the size of tubular arrows and lines in 3D.

Arrows of type `plot::Arrow3d` as well as lines of type `plot::Line3d` can be rendered as 3D tubes by setting the attribute `Tubular = TRUE`.

The attribute `TubeDiameter` determines the diameter of tubular arrows and lines. Its value should be specified as an absolute physical length including a length unit on page 1-2196 such as `TubeDiameter = 2.5*unit::mm`. Numbers without a physical unit give the size in mm.

Tubular arrows have a tip that is rendered as a little cone. The size of these cones is adjusted when the diameter of the arrow shaft changes.

The attribute `TubeDiameter` is not available in 2D.

## Examples

### Example 1

We draw some tubular arrows with different tube diameters:

```
plot(plot::Arrow3d([0, 0, 0], [1, 3, 5], Color = RGB::Red,  
                  TubeDiameter = 2.0*unit::mm),  
      plot::Arrow3d([0, 0, 0], [5, 3, 1], Color = RGB::Green,  
                  TubeDiameter = 3.0*unit::mm),  
      plot::Arrow3d([0, 0, 0], [5, 1, 3], Color = RGB::Blue,  
                  TubeDiameter = 4.0*unit::mm),  
      Tubular = TRUE, TipLength = 18*unit::mm, Axes = Origin):
```

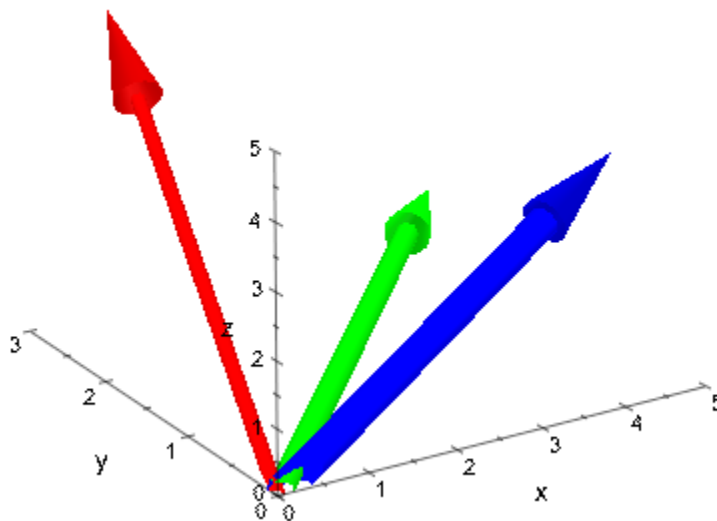

## See Also

### MuPAD Functions

TipAngle | TipLength

# Tubular

Display 3D arrows and lines as tubes?

## Value Summary

Inherited	FALSE, or TRUE
-----------	----------------

## Graphics Primitives

Objects	Tubular Default Values
<code>plot::Arrow3d</code> , <code>plot::Line3d</code>	FALSE

## Description

With `Tubular = TRUE`, arrows of type `plot::Arrow3d` and lines of type `plot::Line3d` are rendered as tubes (cylinders). The diameter is set by the attribute `TubeDiameter`.

Tubular arrows have a tip that is rendered as a little cone. The tip is determined by the attributes `TipLength` and `TipAngle`.

With `Tubular = FALSE`, arrows and lines are displayed as simple lines.

The attribute `Tubular` is not available in 2D.

## Examples

### Example 1

We draw a tubular arrow together with an arrow displayed as a line:

```
plot(plot::Arrow3d([0, 0, 0], [1/2, 3, 5], Tubular = TRUE,  
                  TubeDiameter = 2*unit::mm,
```



```
Color = RGB::Red),  
plot::Arrow3d([0, 0, 0], [3, 5, 1], Tubular = FALSE,  
Color = RGB::Blue),  
TipLength = 12*unit::mm, Axes = Origin):
```

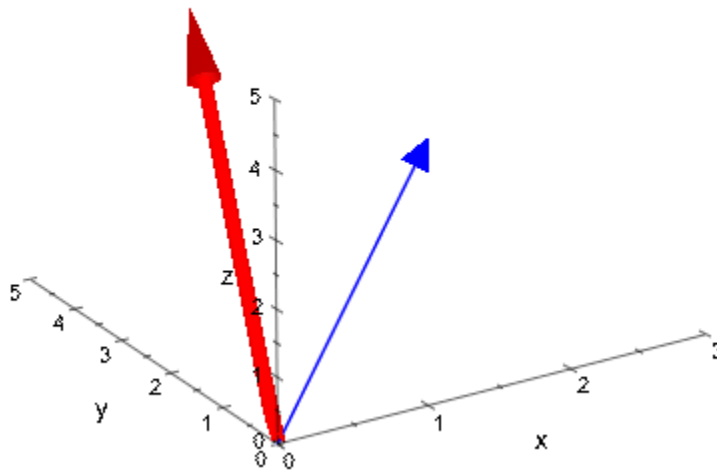

## See Also

### MuPAD Functions

[TipAngle](#) | [TipLength](#) | [TubeDiameter](#)



# **polylib - Manipulating Polynomials**

---

## polylib::coeffRing

Coefficient ring of a polynomial

### Syntax

```
polylib::coeffRing(P)
```

```
polylib::coeffRing(p)
```

### Description

`polylib::coeffRing(p)` returns the coefficient ring of `p`.

`polylib::coeffRing(p)` allows to query in a uniform way the coefficient ring of the polynomial `p` or the polynomial domain `P`.

`P` can be any polynomial domain (`Dom::UnivariatePolynomialx`, `Dom::DistributedPolynomial[x,y]`, ...).

`P` can also be of the form `polylib::Poly([x,y],K)`. If `K` is `Expr` or `IntMod(n)`, then the corresponding domains `Dom::ExpressionField()` or `Dom::IntegerMod(p)` is returned. See `poly` for the details about `Expr` and `IntMod(n)`.

`p` can be a kernel polynomial (`DOM_POLY`), or an element of one of the above domains

### Examples

#### Example 1

We define a polynomial ring over the ring of integers modulo 4, and query for its coefficient ring:

```
P := Dom::UnivariatePolynomial(x, Dom::IntegerMod(4)):  
polylib::coeffRing(P)
```

```
Dom::IntegerMod(4)
```

The coefficient ring of the elements of this domain can be queried the same way:

```
polylib::coeffRing(P(x))
```

```
Dom::IntegerMod(4)
```

```
polylib::coeffRing(Dom::Matrix(Dom::IntegerMod(3)))
```

```
Dom::IntegerMod(3)
```

## Example 2

When no coefficient ring is specified, `poly` currently constructs kernel polynomials over the fake domain `Expr` instead of the mathematically equivalent field `Dom::ExpressionField()` of arbitrary expression (this happens to be more efficient with the current kernels):

```
extop(poly(x))
```

```
x, [x], Expr
```

```
polylib::coeffRing(poly(x))
```

```
Dom::ExpressionField()
```

This makes it possible to plug the result right away as coefficient ring of some other domain:

```
Dom::UnivariatePolynomial(x, polylib::coeffRing(poly(x)))
```

```
Dom::UnivariatePolynomial(x, Dom::ExpressionField(), LexOrder)
```

## **Parameters**

**P**

A polynomial domain

**p**

A polynomial

## **Return Values**

Domain

# polylib::cyclotomic

Cyclotomic polynomials

## Syntax

```
polylib::cyclotomic(n, x)
```

## Description

`polylib::cyclotomic(n, x)` computes the  $n$ -th cyclotomic polynomial, expressed in the indeterminate  $x$ .

The  $n$ -th cyclotomic polynomial is defined to be the minimal polynomial of any  $n$ -th primitive root of unity over the field of rational numbers.

## Examples

### Example 1

We compute the 20th cyclotomic polynomial.

```
polylib::cyclotomic(20, z);
```

```
poly( $z^8 - z^6 + z^4 - z^2 + 1$ , [z])
```

## Parameters

**n**

Positive integer

**x**

Identifier

## **Return Values**

Polynomial over Expr in the indeterminate x.

## **See Also**

### **MuPAD Functions**

numlib::phi



# polylib::decompose

Functional decomposition of a polynomial

## Syntax

```
polylib::decompose(p)
```

```
polylib::decompose(p, x)
```

## Description

`polylib::decompose(p, x)` returns a sequence of polynomials  $q_1, \dots, q_n$  such that  $p(x) = q_1(\dots q_n(x) \dots)$ .

The second argument may be left out if the polynomial is univariate, as in “Example 1” on page 25-7 (Symbolic Math Toolbox).

If a polynomial has several decompositions, it is not specified which of them is returned.

## Examples

### Example 1

In the simplest case, an univariate polynomial is decomposed with respect to its only variable:

```
polylib::decompose(x^4+x^2+1)
```

$$x^2 + x + 1, x^2$$

### Example 2

If there are several variables, a main variable must be specified:

```
polylib::decompose(y*x^4+y,y);
```

$$y x^4 + y$$

## Parameters

**p**

Polynomial or polynomial expression

**x**

One of the indeterminates of the polynomial p

## Return Values

If a decomposition is possible, `polylib::decompose` returns it as an expression sequence, each element being of the same type as the input. If no decomposition is possible, the input is returned.

## Overloaded By

p

## References

A description of the algorithm behind `polylib::decompose` can be found in *Barton and Zippel*, Polynomial decomposition algorithms, *Journal of Symbolic Computation*, 1 (1985), pp. 159-168.

## See Also

### **MuPAD Functions**

factor

## polylib::discrim

Discriminant of a polynomial

### Syntax

```
polylib::discrim(p, x)
```

### Description

`polylib::discrim(p, x)` returns the discriminant of the polynomial `p` with respect to the variable `x`.

The function `normal` is applied to the discriminant before returning it.

### Examples

#### Example 1

We compute the discriminant of the general quadratic equation:

```
polylib::discrim(a*x^2 + b*x + c, x);
```

$$b^2 - 4ac$$

### Parameters

**x**

Indeterminante

**p**

Polynomial or polynomial expression

## Return Values

`polylib::discrim` returns an element of the coefficient ring of `p`. If the coefficient ring is `Expr` or `IntMod(n)`, an expression is returned.

## Overloaded By

`p`

## Algorithms

The discriminant of `p` with respect to the variable `x` is defined as:

$$\frac{(-1)^{\frac{d(d-1)}{2}} \operatorname{res}_x(p, p')}{c},$$

where  $d$  is the degree and  $c$  is the leading coefficient of  $p$ .

## See Also

### MuPAD Functions

`polylib::resultant`

## polylib::divisors

Divisors of a polynomial, polynomial expression, or Factored element

### Syntax

```
polylib::divisors(p)
```

```
polylib::divisors(f)
```

```
polylib::divisors(e)
```

### Description

`polylib::divisors(p)` computes the set of all monic divisors of the polynomial or polynomial expression `p`.

`polylib::divisors(f)` returns all monic divisors of a pre-factored polynomial. Cf. “Example 3” on page 25-13 (Symbolic Math Toolbox).

`polylib::divisors` works on polynomials of category `Cat::Polynomial` as well. Cf. “Example 4” on page 25-13 (Symbolic Math Toolbox).

### Examples

#### Example 1

If the argument is a polynomial, a set of polynomials is returned:

```
polylib::divisors(poly(x^2 - 2*x + 1))
```

```
{ poly(1, [x]), poly(x - 1, [x]), poly(x^2 - 2*x + 1, [x]) }
```

## Example 2

If the argument is a polynomial expression, a set of polynomial expressions is returned:

```
polylib::divisors(x^2 - 1)
```

$$\{1, x^2 - 1, x - 1, x + 1\}$$

## Example 3

If the argument is of type Factored (a factor return value) a set of polynomials is returned:

```
p := factor(poly(x^2 - 1));
polylib::divisors(p)
```

$$\text{poly}(x - 1, [x]) \text{ poly}(x + 1, [x])$$

$$\{\text{poly}(1, [x]), \text{poly}(x - 1, [x]), \text{poly}(x + 1, [x]), \text{poly}(x^2 - 1, [x])\}$$

The polynomials in the resulting set have the same type as the polynomials in the Factored element:

```
p := factor(x^2 - 1);
polylib::divisors(p)
```

$$(x - 1) (x + 1)$$

$$\{1, x^2 - 1, x - 1, x + 1\}$$

## Example 4

polylib::divisors works on polynomials from category Cat::Polynomial as well:

```
P := Dom::Polynomial(Dom::IntegerMod(7)):
polylib::divisors(P(x^3 + 2*x^2 + 1))
```

$$\{1 \bmod 7, (1 \bmod 7) x^3 + (2 \bmod 7) x^2 + (1 \bmod 7)\}$$

## Parameters

**p**

A polynomial or polynomial expression

**f**

Factored (return value of factor)

**e**

Element of a domain of category `Cat::Polynomial`

## Return Values

`polylib::divisors` returns a set of polynomials. The polynomials are from the same type as the polynomials in the argument.

## See Also

### MuPAD Categories

`Cat::Polynomial`

### MuPAD Domains

`DOM_POLY` | `Dom::MultivariatePolynomial` | `Dom::Polynomial` |

`Dom::UnivariatePolynomial`

### MuPAD Functions

`factor` | `irreducible` | `numlib::divisors` | `polylib::sqrfree`



# polylib::Dpoly

Differential operator for polynomials

## Syntax

```
polylib::Dpoly(f)
```

```
polylib::Dpoly(indexlist, f)
```

## Description

If  $f$  is a polynomial in the indeterminates  $x_1$  through  $x_n$ , `polylib::Dpoly([i1, ..., ik], f)` computes the  $k$ -th partial derivative

$$\frac{\partial}{\partial x_{i_1}} \frac{\partial}{\partial \dots} \frac{\partial}{\partial x_{i_k}} f.$$

`polylib::Dpoly(f)` returns the derivative of  $f$  with respect to its only variable for an univariate polynomial  $f$ .

If some element of `indexlist` is greater than the number of indeterminates of  $f$ , the zero polynomial is returned.

`polylib::Dpoly([], p)` returns  $p$ .

If the coefficients of the polynomial are elements of a domain  $d$ , then this domain must have the method "intmult" (`d::intmult(e, i)`) that must calculate the integer multiple of a domain element  $e$  and a positive integer  $i$ .

## Examples

### Example 1

We differentiate a univariate polynomial with respect to its only indeterminate. In this case, we may leave out the first argument.

```
polylib::Dpoly(poly(2*x^2 + x + 1));
```

```
poly(4 x + 1, [x])
```

## Example 2

Now we differentiate a bivariate polynomial, and must specify the indeterminate in this case.

```
polylib::Dpoly([1], poly(x^2*y + 3*x + y, [x, y]));
```

```
poly(2 x y + 3, [x, y])
```

## Example 3

It is also possible to compute second or higher partial derivatives.

```
polylib::Dpoly([1, 2], poly(x^2*y + 3*x + y, [x, y]));
```

```
poly(2 x, [x, y])
```

## Parameters

**f**

Polynomial

**indexlist**

List of positive integers

## Return Values

`polylib::Dpoly` returns a polynomial in the same indeterminates and over the same coefficient ring as the input.

## Overloaded By

f

## See Also

### MuPAD Functions

D | diff

## polylib::elemSym

Elementary symmetric polynomials

### Syntax

```
polylib::elemSym(l, k)
```

### Description

`polylib::elemSym([x1, ..., xn], k)` returns the  $k$ -th elementary symmetric polynomial in the given variables  $x_1$  through  $x_n$ .

A given list  $l$  is a valid first argument only if its elements can be used as indeterminates of a polynomial .

### Examples

#### Example 1

The first elementary symmetric polynomial is just the sum of its variables:

```
polylib::elemSym([x,y,z], 1);
```

```
poly(x + y + z, [x, y, z])
```

#### Example 2

Indeterminates may also be e.g. trigonometric functions:

```
polylib::elemSym([sin(u),cos(u), exp(u)], 2);
```

```
poly(sin(u) cos(u) + sin(u) eu + cos(u) eu, [sin(u), cos(u), eu])
```

## Parameters

**l**

List of indeterminates

**k**

Positive integer

## Return Values

Result is a polynomial over the coefficient ring `Expr`. If `k` is greater than the number of operands of `l`, `undefined` is returned.

## References

For more information about elementary symmetric polynomials, see v.d. Waerden, *Algebra*, vol. 1.

## See Also

### MuPAD Functions

`polylib::representByElemSym`

## polylib::makerat

Convert expression into rational function over a suitable field

### Syntax

```
polylib::makerat(a, <maxd>)
```

```
polylib::makerat(l, <maxd>)
```

### Description

`polylib::makerat(a)` returns two polynomials  $f$  and  $g$  over the rationals and a list of substitutions such that applying the substitutions to the rational function  $\frac{f}{g}$  gives  $a$ .

`polylib::makerat(l)` does the same for every element of the list  $l$  and returns lists of resulting  $f$ 's and  $g$ 's.

`polylib::makerat(a, maxd)` replaces  $d$ -th roots of integers by elements of some algebraic extension field over the rationals if  $d \leq \text{maxd}$ , and returns polynomials  $f$  and  $g$  over that extension field.

`polylib::makerat(a)` replaces all irrational subexpressions (except identifiers) in  $a$  by newly created identifiers, thereby producing a rational function over the rationals. It returns the numerator and denominator of that rational function as polynomials over Expr, and the substitutions to be made to get back the numerator and denominator of the original input  $a$ .

`polylib::makerat(l)` replaces all irrational subexpressions in all elements of  $l$  by newly created identifiers.

Every subexpression is replaced by the same identifier every time it occurs.

All indeterminates of the input and all of the new identifiers become indeterminates of the result, unless a second argument `maxd` is given.

The imaginary unit  $I$  (Symbolic Math Toolbox) is handled in a special way: it is replaced by the element ``#I`` of the algebraic extension field on page 7-58 with minimal

polynomial  $\sqrt{I^2 + 1}$ . If  $I$  (Symbolic Math Toolbox) occurs in the input, the result consists of polynomials over that extension field.

If a second argument  $maxd$  is given,  $d$ -th roots of rationals are replaced by elements of a suitable field extension of the rationals if  $d \leq maxd$ . In the same way, nested fractional powers of rationals are replaced unless the denominator of some exponent exceeds  $maxd$ . In this case, the returned result consists of polynomials over a tower of extension fields over the rationals.

## Examples

### Example 1

In the simplest case (integer polynomial), the numerator equals the input, the denominator equals 1, and no substitutions are necessary:

```
polylib::makerat(x^2+3)
```

```
poly(x2 + 3, [x]), poly(1, [x]), []
```

### Example 2

Transcendental expressions are replaced by new identifiers. The result indicates on which variables the generated identifiers depend:

```
polylib::makerat(sin(u)/x)
```

```
poly(X5, [X5, x]), poly(x, [X5, x]), [X5 = sin(u)]
```

### Example 3

Floating point numbers are considered transcendental:

```
polylib::makerat(0.27*x)
```

```
poly(X8 x, [X8, x]), poly(1, [X8, x]), [X8 = 0.27]
```

### Example 4

By default, radicals are treated like transcendental subexpressions:

```
polylib::makerat(sqrt(2)/x)
```

```
poly(X11, [X11, x]), poly(x, [X11, x]), [X11 =  $\sqrt{2}$ ]
```

### Example 5

If a sufficiently large second argument is given, radicals are replaced by elements of algebraic extensions:

```
polylib::makerat(sqrt(2)/x, 2)
```

```
poly(X14, [x], Dom::AlgebraicExtension(Dom::Rational, X142 - 2 = 0, X14)),
```

```
poly(x, [x], Dom::AlgebraicExtension(Dom::Rational, X142 - 2 = 0, X14)), [X14 =  $\sqrt{2}$ ]
```

## Parameters

**a**

Polynomial over Expr or arithmetical expression

**l**

List or set of polynomials over Expr or arithmetical expressions

**maxd**

Positive integer

## Return Values

polylib::makerat returns an expression sequence consisting of three operands:



- The first operand represents the numerator (or the list/set of numerators, respectively). It is a single polynomial if the call was `polylib::makerat(a)`, otherwise it is a set or list of polynomials (the same type as the input). The polynomial(s) may have more indeterminates than the input. The coefficient ring is either `Expr` or a `Dom::AlgebraicExtension`.
- The second operand represents the denominator (or the list/set of denominators, respectively). It is of the same type as the first operand.
- The third operand is a list of equations.

## See Also

**MuPAD Functions**  
`rationalize`

## polylib::minpoly

Approximate minimal polynomial

### Syntax

```
polylib::minpoly(a, n, x)
```

### Description

`polylib::minpoly(a, n, x)` computes a univariate polynomial  $f$  in the variable  $x$  of degree  $n$  with integer coefficients such that  $a$  equals a root of  $f$  up to the precision given by `DIGITS`, and such that the sum of squares of its coefficients is minimal among all polynomials with this property.

### Environment Interactions

`polylib::minpoly` is sensitive to the environment variable `DIGITS`.

### Examples

#### Example 1

We compute a polynomial of degree 4 that has a root close to  $\pi$  (Symbolic Math Toolbox) (up to 6 decimal digits) and small integer coefficients:

```
DIGITS:=6: polylib::minpoly(PI, 4, x); delete DIGITS:
```

```
poly( $x^4 - 5x^3 + 5x^2 + 9x - 20$ , [x])
```

If the root has to be even closer to  $\pi$  (Symbolic Math Toolbox), bigger coefficients are needed:

```
DIGITS:=20: polylib::minpoly(PI, 4, x); delete DIGITS
```

```
poly(-108 x^4 - 1717 x^3 + 6952 x^2 - 258 x - 4045, [x])
```

## Parameters

**a**

Arithmetical expression that can be converted to a floating point number

**n**

Positive integer

**x**

Identifier

## Return Values

`polylib::minpoly` returns a polynomial in `x`. Its coefficient ring is `Expr`, all of its coefficients are integers.

## References

Lenstra/Lenstra/Lovasz, Factoring polynomials with rational coefficients, Math. Ann. 261(1982), pp. 515-534.

## Algorithms

The problem reduces to finding a shortest integer vector in the lattice

$\{e_i + a^i e_{n+1} \mid 0 \leq i \leq n\}$ , where  $e_i$  denotes the vector with  $e_i[j] = \delta_{i,j}$  (Kronecker symbol). This problem is solved using the algorithm of Lenstra/Lenstra/Lovasz.

## See Also

### MuPAD Functions

`interpolate` | `lllint` | `stats::linReg`

# polylib::Poly

Domain of polynomials

## Syntax

### Domain Creation

```
polylib::Poly([x1, ...], <R>)
```

## Description

`polylib::Poly([x1, ..., xn], R)` creates the ring of polynomials in the unknowns `x1` through `xn` over the coefficient ring `R`. If the argument `R` is missing, `Expr` is used.

`polylib::Poly` is a facade domain; it has no domain elements. It serves only as a coefficient ring for polynomials.

The attempt to create an element of `polylib::Poly` results in a `DOM_POLY`.

The arithmetical operations of the domain are realized by the corresponding kernel methods.

## Examples

### Example 1

`polylib::Poly` can be used for defining polynomials in `x` whose coefficients are polynomials in `y`. Such polynomials must not be confused with bivariate polynomials in `x` and `y`.

```
delete x,y: e:= x*(y^2*2 + y) + 3*y:
poly(e, [x, y]); poly(e, [x], polylib::Poly([y]))
```

```
poly(2 x y2 + x y + 3 y, [x, y])
```

$$\text{poly}((y + 2 y^2) x + 3 y, [x], \text{polylib::Poly}([y], \text{Expr}))$$

## Parameters

$x_1$

Unknown

**R**

Admissible coefficient ring for polynomials. See `poly`.

## Entries

"zero"	the zero polynomial
"one"	the constant polynomial one
"indets"	list of unknowns
"coeffRing"	the coefficient ring R

## See Also

### MuPAD Domains

`Dom::DistributedPolynomial`

# polylib::primitiveElement

Primitive element for tower of field extensions

## Syntax

```
polylib::primitiveElement(F, G)
```

## Description

For given field extensions  $F = K(\alpha)$  and  $G = F(\beta)$ , `polylib::primitiveElement(F, G)` returns a list consisting of a simple algebraic extension of  $K$  that is  $K$ -isomorphic to  $G$ , a symbol for a primitive element of that extension, and the images of  $\alpha$  and  $\beta$  under some fixed  $K$ -isomorphism.

It is presumed that the extension is separable. Otherwise, it may happen that the algorithm does not terminate.

## Examples

### Example 1

Since the rational numbers are perfect, extensions of them can always be handled:

```
F := Dom::AlgebraicExtension(Dom::Rational, sqrt2^2 - 2):
G := Dom::AlgebraicExtension(F, sqrt3^2 - 3):
```

Now  $G = \mathbb{Q}(\sqrt{2}, \sqrt{3})$ , and we use `polylib::primitiveElement` to find a primitive element for  $G$ :

```
polylib::primitiveElement(F, G)
```

```
[Dom::AlgebraicExtension(Dom::Rational, -10 X12 + X14 + 1 = 0, X1),  
X1, X13/2 - 9 X1/2, 11 X1/2 - X13/2]
```

This means that a primitive element  $X_1$  of the extension is determined by its minimal polynomial  $X_1^4 - 10X_1^2 + 1$ . The last two operands of the list are field elements whose squares are 2 and 3, respectively.

## Example 2

The function works also for subdomains of `Dom::AlgebraicExtension`, e.g., Galois fields.

```
F := Dom::GaloisField(7, 2):  
G := Dom::GaloisField(F, 2):  
polylib::primitiveElement(F, G)
```

```
[Dom::AlgebraicExtension(Dom::IntegerMod(7), 3 X5 - X52 + 2 X53 + X54 - 1 = 0, X5),  
X5, -3 X53 + 3 X52 - 3 X5 - 2, X5]
```

## Parameters

**F**

A field created by `Dom::AlgebraicExtension`

**G**

A field created by `Dom::AlgebraicExtension` with ground field `F`

## Return Values

List consisting of four operands:



- a field  $H$  of type `Dom::AlgebraicExtension` over the same ground field as  $F$ ;
- an identifier that equals the entry `H::variable`;
- an object of type  $H$  that satisfies the minimal polynomial for  $\alpha$ ;
- an object of type  $H$  that satisfies the minimal polynomial for  $\beta$ .

## Algorithms

The chosen primitive element is  $\alpha + s\beta$ , where  $s$  is a positive integer.

## See Also

### MuPAD Domains

`Dom::AlgebraicExtension`

### MuPAD Functions

`polylib::splitfield`

## polylib::primpart

Primitive part of a polynomial

### Syntax

```
polylib::primpart(f)
```

```
polylib::primpart(q)
```

```
polylib::primpart({xpr}, <{inds}>)
```

### Description

`polylib::primpart(f)` returns the primitive part of the polynomial `f`.

If the input is a polynomial, the greatest common divisor of its coefficients is removed. The function `gcd` must be able to calculate this gcd.

If the first argument is an expression, it is converted into a polynomial in the indeterminates specified by the second argument, or in all of its indeterminates if no second argument is given. `polylib::primpart` returns FAIL if the expression cannot be converted into a polynomial.

For a rational number, its sign is returned.

### Examples

#### Example 1

In the following example, a bivariate polynomial is given. Its coefficients are the integers 3, 6, and 9; the primitive part is obtained by dividing the polynomial by their gcd.

```
polylib::primpart(poly(6*x^3*y + 3*x*y + 9*y, [x, y]));
```

```
poly(2 x^3 y + x y + 3 y, [x, y])
```

However, consider the same polynomial viewed as a univariate polynomial in  $x$ . Its coefficients are polynomials in  $y$  in this case, and their gcd  $3*y$  is divided off.

```
polylib::primpart(poly(6*x^3*y + 3*x*y + 9*y, [x]));
```

$$\text{poly}(2 x^3 + x + 3, [x])$$

## Example 2

`polylib::primpart` divides the coefficients by their gcd, but does not normalize the result. This must be done explicitly:

```
polylib::primpart(4*x*y + 6*x^3 + 6*x*y^2 + 9*x^3*y, [x])
```

$$\frac{x^3 (9 y + 6)}{3 y + 2} + \frac{x (6 y^2 + 4 y)}{3 y + 2}$$

```
normal(polylib::primpart(4*x*y + 6*x^3 + 6*x*y^2 + 9*x^3*y, [x]))
```

$$3 x^3 + 2 y x$$

## Parameters

**f**

Polynomial

**q**

Rational number

**xpr**

Expression

**inds**

List of identifiers

**Return Values**

`polylib::primpart` returns an object of the same type as the input, or FAIL.

**Overloaded By**

`f`

**Algorithms**

The primitive part of a polynomial  $f$  is a polynomial  $g$  whose coefficients are relatively prime such that  $f = rg$  for some element  $r$  of the coefficient ring.

**See Also****MuPAD Functions**

`content` | `factor` | `gcd` | `icontent` | `irreducible`

# polylib::randpoly

Create a random polynomial

## Syntax

```
polylib::randpoly()
```

```
polylib::randpoly(<list>, <ring>, <Degree = n>, <Terms = k>, <Coeffs = f>, <Monic>)
```

## Description

`polylib::randpoly()` returns a univariate random polynomial with integer coefficients; the global identifier `x` is used as the indeterminate.

`polylib::randpoly(list)` returns a random polynomial in all indeterminates given in `list`.

`polylib::randpoly(list, ring)` returns a random polynomial in the indeterminates given in `list` over the coefficient ring `ring`.

See `poly` for a detailed description of possible indeterminates and coefficient rings.

The polynomial is created by randomly choosing as many exponents as specified through the option `Terms` and then choosing random coefficients. It may of course happen that for some coefficient 0 is chosen, therefore the actual number of terms in the result can be smaller than the value of the option `Terms`.

If the option `Coeffs=f` is given, the random coefficients are generated by calling `f()`. Otherwise, if `ring` is `Expr`, the coefficients will be random integers in the range - 999, ..., 999. If `ring` is a user-defined domain, it must have a method "random" to create the coefficients if no function is given.

If the option `Monic` is given, the resulting polynomial has exactly the specified degree and the leading coefficient is 1.

If the requested number of terms exceeds the maximal possible number of terms for the specified degree and number of variables, a warning is emitted and a dense polynomial is created.

## Environment Interactions

Unless a generator is specified through the option `Coeffs`, `polylib::randpoly` uses `random` to create the exponents and coefficients. Therefore it is sensitive to the environment variable `SEED`.

## Examples

### Example 1

We generate a univariate random polynomial in the indeterminate  $z$ , and use the default values for the other options. Therefore the polynomial has integer coefficients, is of degree 5, and has 6 terms.

```
polylib::randpoly([z])
```

$$\text{poly}(-535 z^5 + 916 z^4 + 663 z^3 - 764 z^2 - 741 z - 65, [z])$$

### Example 2

We create a bivariate random polynomial over the finite field with 7 elements. This works because `Dom::IntegerMod` has a "random" slot that generates random elements:

```
polylib::randpoly([x,y],Dom::IntegerMod(7),Degree=3,Terms=4);
```

$$\text{poly}(2 x^3 y^3 + x^3 y + 4 x y, [x, y], \text{Dom}::\text{IntegerMod}(7))$$

## Parameters

### **list**

List of indeterminates

### **ring**

Coefficient ring

## Options

### **Degree**

Option, specified as `Degree = k`

The maximum degree the result can have in each variable. `k` must be a nonnegative integer. Default is 6.

### **Terms**

Option, specified as `Terms = t`

Makes `polylib::randpoly` generate the sum of `t` random terms. `t` must be a positive integer or `infinity`. If `t` equals `infinity`, `polylib::randpoly` returns a dense polynomial. Default is 5.

### **Coeffs**

Option, specified as `Coeffs = f`

Create the coefficients of the result by calling `f()`.

### **Monic**

The created polynomial is monic, i.e., the leading coefficient is 1.

## Return Values

Polynomial in the given indeterminates over the given ring. If no list of indeterminates is given, [x] is used. If no ring is given, Expr is used.

## See Also

### MuPAD Functions

poly | random



# polylib::realroots

Isolate all real roots of a real univariate polynomial

## Syntax

```
polylib::realroots(p)
```

```
polylib::realroots(p, eps)
```

## Description

`polylib::realroots(p)` returns intervals isolating the real roots of the real univariate polynomial `p`.

`polylib::realroots(p, eps)` returns refined intervals approximating the real roots of `p` to the relative precision given by `eps`.

All coefficients of `p` must be real and numerical, i.e., either integers, rationals or floating-point numbers. Numerical symbolic objects such as `sqrt(2)`, `exp(10*PI)` etc. are accepted, if they can be converted to real floating-point numbers via `float`. The same holds for the precision goal `eps`.

The isolating intervals are ordered such that their centers are increasing, i.e.,  $a_i + b_i < a_{i+1} + b_{i+1}$ .

The number `nops(realroots(p))` of intervals is the number of real roots of `p`. Multiple roots are counted only once. Cf. "Example 3" on page 25-42 (Symbolic Math Toolbox).

Isolating intervals may be quite large. The optional argument `eps` may be used to refine the intervals such that they approximate the real roots to a relative precision `eps`. With

this argument the returned intervals satisfy  $b_i - a_i \leq \frac{\text{eps} |a_i + b_i|}{2}$ , i.e., each center  $\frac{a_i + b_i}{2}$  approximates a root with a relative precision `eps/2`.

**Note** Some care should be taken when trying to obtain highly accurate approximations of the roots via small values of `eps`. Internally, bisectioning with exact rational arithmetic is

used to locate the roots to the precision `eps`. This process may take much more time than determining the isolating intervals without using the second argument `eps` in `polylib::realroots`. It may be faster to use moderate values of `eps` to obtain first approximations of the roots via `polylib::realroots`. These approximations may then be improved by a fast numerical solver such as `numeric::fsolve` with an appropriately high value of `DIGITS`. Cf. “Example 6” on page 25-43 (Symbolic Math Toolbox). However, note that `polylib::realroots` will always succeed in locating the roots to the desired precision eventually. Numerical solvers may fail or return a root not belonging to the interval which was used for the initial approximation.

---

**Note** Unexpected results may be obtained when the polynomial contains irrational coefficients. Internally, any such coefficient  $c$  is converted to a floating-point number. This float is then replaced by an approximating rational number  $r$  satisfying

$|r - c| \leq \frac{1}{\text{DIGITS}} |c|$ . Finally, `polylib::realroots` returns rigorous bounds for the real roots of the rationalized polynomial. Despite the fact that all coefficients are approximated correctly to `DIGITS` decimal places this may change the roots drastically. In particular, multiple roots or clusters of poorly separated simple roots are very sensitive to small perturbations in the coefficients of the polynomial. See “Example 4” on page 25-42 (Symbolic Math Toolbox) and “Example 5” on page 25-43 (Symbolic Math Toolbox).

---

## Environment Interactions

The function is sensitive to the environment variable `DIGITS`, if there are non-integer or non-rational coefficients in the polynomial. Any such coefficient is replaced by a rational number approximating the coefficient to `DIGITS` significant decimal places.

## Examples

### Example 1

We use a polynomial expression as input to `polylib::realroots`:

```
p := (x - 1/3)*(x - 1)*(x - 4/3)*(x - 2)*(x - 17):  
polylib::realroots(p)
```

```
[[0, 1], [1, 1], [1, 2], [2, 2], [16, 32]]
```

The roots 1 and 2 are found exactly: the corresponding intervals have length 0. The other isolating intervals are quite large. We refine the intervals such that they approximate the roots to 12 decimal places. Note that this is independent of the current value of DIGITS, because no floating-point arithmetic is used:

```
polylib::realroots(p, 10^(-12))
```

```
[[ [1466015503701, 733007751851], [4398046511104, 2199023255552] ], [1, 1], [1466015503701, 733007751851], [1099511627776, 549755813888] ], [2, 2], [17, 17]]
```

We convert these exact bounds for the real roots to floating point approximations. Note that with the default value of DIGITS=10 we ignore 2 of the 12 correct digits the rational bounds could potentially give:

```
map(%, map, float)
```

```
[[0.3333333333, 0.3333333333], [1.0, 1.0], [1.333333333, 1.333333333], [2.0, 2.0], [17.0, 17.0]]
```

```
delete p:
```

## Example 2

Orthogonal polynomials of degree  $n$  have  $n$  simple real roots. We consider the Legendre polynomial of degree 5, available in the library `orthpoly` for orthogonal polynomials:

```
polylib::realroots(orthpoly::legendre(5, x), 10^(-DIGITS)):
```

```
map(%, float@op, 1)
```

```
[-0.906179846, -0.5384693101, 0.0, 0.5384693101, 0.9061798459]
```

### Example 3

We consider a polynomial with a multiple root:

```
p := poly((x - 1/3)^3*(x - 1), [x])
```

$$\text{poly}\left(x^4 - 2x^3 + \frac{4x^2}{3} - \frac{10x}{27} + \frac{1}{27}, [x]\right)$$

Note that only one isolating interval  $[0, 1]$  is returned for the triple root  $\frac{1}{3}$ :

```
polylib::realroots(p)
```

```
[[0, 1], [1, 1]]
```

```
delete p:
```

### Example 4

We consider a polynomial with non-rational roots:

```
p := (x - 3)^2*(x - PI)^2:
```

Converting the result of `polylib::realroots` to floating-point numbers one sees that the exact roots  $3, 3, \text{PI}, \text{PI}$  are approximated only to 3 decimal places:

```
map(polylib::realroots(p, 10^(-10)), map, float)
```

```
[[2.998807805, 2.998807805], [3.001213582, 3.001213582], [3.140323518, 3.140323519],  
[3.142840401, 3.142840401]]
```

This is caused by the internal rationalization of the coefficients of  $p$ .

The intervals returned by `polylib::realroots(p, 10^(-10))` correctly locate the 4 exact roots of this rationalized polynomial to a precision of 10 digits. However, because all 4 roots are close, the small perturbations of the coefficients introduced by rationalization have a drastic effect on the location of the roots. In particular, rationalization splits the two original double roots into 4 simple roots.

```
delete p:
```

## Example 5

We consider a further example involving non-exact coefficients. First we approximate the roots of a polynomial with exact coefficients:

```
p1 := (x - 1/3)^3*(x - 4/3):
map(polylib::realroots(p1, 10^(-10)), map, float)

[[0.3333333333, 0.3333333333], [1.333333333, 1.333333333]]
```

Now we introduce roundoff errors by replacing one entry by a floating-point approximation:

```
p2 := (x - 1.0/3)^3*(x - 4/3):
map(polylib::realroots(p2, 10^(-10)),map,float)

[[0.3332481323, 0.3332481323], [1.333333333, 1.333333333]]
```

In this example rationalization caused the triple root  $1/3$  to split into one real root and two complex conjugate roots.

```
delete p1, p2:
```

## Example 6

We want to approximate roots to a precision of 1000 digits:

```
p := x^5 - 129/20*x^4 + 69/5*x^3 - 14*x^2 + 12*x - 8:
```

We recommend not to obtain the result directly by `polylib::realroots(p, 10^(-1000))`, because the internal bisectioning process for refining crude isolating intervals converges only linearly. Instead, we compute first approximations of the roots to a precision of 10 digits:

```
approx := map(polylib::realroots(p, 10^(-10)), float@op, 1)
```

```
[1.489177599, 1.752191733, 3.255184556]
```

These values are used as starting points for a numerical root finder. The internal Newton search in `numeric::fsolve` converges quadratically and yields the high precision results much faster than `polylib::realroots`:

```
DIGITS := 1000:
```

```
roots := map(approx, x0 -> numeric::fsolve([p = 0], [x = x0]))
```

```
[ [x = 1.489177598846870281338916114673844643894...],  
  [x = 1.752191733304413195335101727880090131407...],  
  [x = 3.255184555797733438479691333705558491124...]
```

```
delete approx, DIGITS, roots, x0:
```

## Parameters

### **p**

A univariate polynomial: either an expression or a polynomial of domain type `DOM_POLY`.

### **eps**

A (small) positive real number determining the size of the returned intervals.

## Return Values

List of lists  $[[a_1, b_1], [a_2, b_2], \dots]$  with rational numbers  $a_i \leq b_i$  is returned. Lists with  $a_i = b_i$  represent exact rational roots. Lists with  $a_i < b_i$  represent open intervals containing exactly one real root. If the polynomial has no real roots, then the empty list `[]` is returned.

## See Also

### **MuPAD Functions**

`numeric::fsolve` | `numeric::polyroots` | `numeric::realroot` |  
`numeric::realroots`

## polylib::representByElemSym

Represent symmetric by elementary symmetric polynomials

### Syntax

```
polylib::representByElemSym(f, l)
```

### Description

`polylib::representByElemSym(f, [x1, ..., xn])` returns a polynomial `g` in the identifiers `x1` through `xn` such that replacing each `xi` by the `i`-th elementary symmetric polynomial gives `f`.

The list `l` must have as many operands as `f` has indeterminates.

The result is FAIL if the input is not symmetric.

### Examples

#### Example 1

The symmetric polynomial  $x^2 + y^2$  can be written as  $(x + y)^2 - 2(x y)$ :

```
polylib::representByElemSym(poly(x^2+y^2), [u,v]);
```

```
poly(u^2 - 2 v, [u, v])
```

#### Example 2

`polylib::representByElemSym` works over domains also:

```
f:=poly(x^2+y^2, Dom::IntegerMod(7));  
polylib::representByElemSym(f, [u,v])
```



`poly( $u^2 + 5 v$ , [u, v], Dom::IntegerMod(7))`

## Parameters

**f**

Symmetric polynomial

**l**

List of indeterminates

## Return Values

Result is a polynomial having the same coefficient ring as f.

## Algorithms

It is a well-known theorem that every symmetric polynomial can be written in this way.

## See Also

**MuPAD Functions**

`polylib::elemSym`

## polylib::resultant

Resultant of two polynomials

### Syntax

```
polylib::resultant(f, g, <x>)
```

```
polylib::resultant(fexpr, gexpr, <inds>, <x>)
```

### Description

`polylib::resultant(f, g)` returns the resultant of `f` and `g` with respect to their first variable.

`polylib::resultant(f, g, x)` returns the resultant of `f` and `g` with respect to the variable `x`.

`polylib::resultant(fexpr, gexpr, inds, x)` returns the resultant of `fexpr` and `gexpr` with respect to the variable `x`; `fexpr` and `gexpr` are viewed as polynomials in the indeterminates `inds`.

Both input polynomials must have exactly the same second and third operand, i.e. their variables and coefficient rings must be identical.

If the arguments are expressions then these are converted into polynomials using `poly`. `polylib::resultant` returns `FAIL` if the expressions cannot be converted.

If the argument `inds` is missing, the input expressions are converted into polynomials in all indeterminates occurring in at least one of them. They are *not* independently converted, hence the conversion cannot result in two polynomials with different variables causing an error. See “Example 1” on page 25-49 (Symbolic Math Toolbox).

If the coefficient ring is a domain, it must have a “`_divide`” method.

If the coefficient ring is `Expr`, `polylib::resultant` returns an expression if called with two univariate polynomials. See “Example 2” on page 25-49 (Symbolic Math Toolbox).

For polynomials over  $\text{IntMod}(n)$ , the computation may stop with an error if  $n$  is not prime.

## Examples

### Example 1

If the input consists of expressions, the sets of indeterminates occurring in the expressions need not coincide:

```
polylib::resultant(a*x + c, c*x + d, x);
```

$$ad - c^2$$

### Example 2

If the coefficient ring of two univariate input polynomials is  $\text{Expr}$ , the result is an expression:

```
polylib::resultant(poly(x^2 - 1), poly(x + 1));
```

$$0$$

## Parameters

**f, g**

Polynomials

**fexpr, gexpr**

Expressions

**x**

Indeterminate

**inds**

List of indeterminates

**Return Values**

If the input consists of polynomials in at least two variables, `polylib::resultant` returns a polynomial in one variable less than the input.

**Overloaded By**

`p, q`

**Algorithms**

The resultant of two polynomials is defined to be the determinant of their Sylvester matrix. A call to `polylib::resultant` is more efficient than consecutive calls to `linalg::sylvester` and `det`.

**See Also****MuPAD Functions**

`det` | `linalg::sylvester` | `polylib::discrim`

# polylib::sortMonomials

Sorting monomials with respect to a term ordering

## Syntax

```
polylib::sortMonomials(f)
polylib::sortMonomials(f, vars)
polylib::sortMonomials(f, ord)
polylib::sortMonomials(f, vars, ord)
```

## Description

`polylib::sortMonomials(f, ord)` returns a list of all monomials constituting the polynomial `f`, sorted in descending order with respect to `ord`.

A monomial ordering may be: one of the identifiers `LexOrder`, `DegreeOrder`, `DegInvLexOrder`; or an object of type `Dom::MonomOrdering` or convertible to that type; or any object returning a number when called as `ord(m1, m2)` for two degree vectors `m1` and `m2`. A degree vector is a list of integers, as returned by `degreevec`.

If no order is given, the lexicographical order is used.

If no list of variables is given, all indeterminates of `f` are used.

Given two degree vectors, `m1` is considered to be greater than `m2` if and only if `ord(m1, m2)` is positive.

## Examples

### Example 1

The monomials of the polynomial below are compared using a monomial ordering from `Dom::MonomOrdering`.

```
polylib::sortMonomials(poly(x^2+x*y^3+2, [x,y]), DegRevLex(2))
```

```
[poly(x y3, [x, y]), poly(x2, [x, y]), poly(2, [x, y])]
```

## Parameters

**f**

Polynomial or polynomial expression

**vars**

Nonempty list of identifiers

**ord**

Monomial ordering

## Return Values

List of polynomials or expressions of the same type as `f`.

## Overloaded By

`f`

## See Also

### **MuPAD Domains**

Dom::MonomOrdering

### **MuPAD Functions**

lmonomial | nthmonomial

## polylib::splitfield

Splitting field of a polynomial

### Syntax

`polylib::splitfield(p)`

### Description

Given a polynomial  $p$  over a field  $K$  in one indeterminate  $X$ , `polylib::splitfield(p)` returns a simple field extension  $F$  of  $K$  and some elements  $\alpha_1, \dots, \alpha_n$  of  $F$ , such that

$\prod_{i=1}^n (X - \alpha_i)$  is an associate of  $p$ , and such that  $F$  is the smallest extension of  $K$  containing all of the  $\alpha_i$ .

If the input is a polynomial expression, as in “Example 1” on page 25-54 (Symbolic Math Toolbox), it is treated as a polynomial over the rationals.

The polynomial  $p$  need not be irreducible.

The name for the primitive element of the field extension is generated using `genident` and is therefore different in every call of `polylib::splitfield`, even if the same polynomial is passed.

MuPAD must be able to factor polynomials over the coefficient field of  $p$ .

The coefficient field must be perfect. Otherwise, it may happen that `polylib::splitfield` does not terminate.

### Examples

#### Example 1

We adjoin  $\sqrt{-1}$  to the rationals:



```
polylib::splitfield(x^2+1)
```

```
[Dom::AlgebraicExtension(Dom::Rational, X1^2 + 1 = 0, X1), [X1, 1, -X1, 1]]
```

## Example 2

A call to `polylib::splitfield` becomes more interesting for polynomials for of degree at least 3:

```
polylib::splitfield(x^3-2)
```

```
[Dom::AlgebraicExtension(Dom::Rational, X3^6 + 108 = 0, X3),  
 [X3/2 - X3^4/36, 1, X3^4/18, 1, -X3^4/36 - X3/2, 1]]
```

## Example 3

In this example, we work over the field of univariate rational functions (the quotient field of the univariate polynomials) over the rationals:

```
R:=Dom::DistributedPolynomial([x], Dom::Rational):  
F:=Dom::Fraction(R):  
f:=poly(y^3-x,[y],F):  
polylib::splitfield(f)
```

```
[Dom::AlgebraicExtension(Dom::Fraction(Dom::DistributedPolynomial([x], Dom::Rational,  
LexOrder)), X5^6 + 27 x^2 = 0, X5), [X5/2 - X5^4/18 x, 1, X5^4/9 x, 1, -X5/2 - X5^4/18 x, 1]]
```

## Parameters

**p**

Univariate polynomial over a field or univariate polynomial expression

## Return Values

`polylib::splitfield` returns a list of two operands: the first one is the splitting field of the polynomial, i.e. a `Dom::AlgebraicExtension` of the coefficient ring; the second one is a list of all roots of the polynomial in the splitting field, each root followed by its multiplicity.

## See Also

### **MuPAD Functions**

`evalp` | `factor`

# polylib::sqrfree

Square-free factorization of polynomials

## Syntax

```
polylib::sqrfree(f, <recollect>)
```

## Description

`polylib::sqrfree(f)` returns the square-free factorization of  $f$ , that is, a factorization of  $f$  in the form  $f = u p_1^{e_1} \dots p_r^{e_r}$  with primitive and pairwise different square-free divisors  $p_i$ .

`polylib::sqrfree(f)` returns the square-free factorization of the polynomial  $f$ , that is, a factorization of  $f$  in the form  $f = u f_1^{e_1} \dots f_r^{e_r}$  with primitive and pairwise different square-free divisors  $f_i$  (i.e.,  $\gcd(f_i, f_j) = 1$  for  $i \neq j$ ).

$u$  is a unit of the coefficient ring of  $f$ , and  $e_i$  are positive integers.

The result of `polylib::sqrfree` is an object of the domain type `Factored`. Let `g := polylib::sqrfree(f)` be such an object. It is represented internally as the list `[u, f1, e1, ..., fr, er]` of odd length  $2r + 1$ .

You may extract the unit  $u$  and the terms  $f_i^{e_i}$  by the ordinary index operator `[ ]`, i.e., `g[1] = u`, `g[2] = f1^e1`, `g[3] = f2^e2`, ....

The calls `Factored::factors(g)` and `Factored::exponents(g)` return a list of the factors  $f_i$  and the exponents  $e_i$  ( $1 \leq i \leq r$ ), respectively. The call `convert(g, DOM_LIST)` gives the internal representation of a factored object, i.e., the list `[u, f1, e1, ..., fr, er]`.

Note that the result of `polylib::sqrfree` is printed as an expression and behaves like that. As an example, the result of `polylib::sqrfree(x^2+2*x+1)` is the object printed as  $(x+1)^2$  which is of type `"_power"`.

Please read the help page of `Factored` for details.

The call `polylib::sqrfree(f, FALSE)` returns a square-free factorization of  $f$ , where the exponents  $e_i$  need not be pairwise different.

`polylib::sqrfree` can handle univariate and multivariate polynomials over `Expr`, residue class rings `IntMod(p)` with prime modulus  $p$ , domains representing a unique factorization domain of characteristic zero, and finite fields.

If the argument of `polylib::sqrfree` is an expression, its numerator and denominator are converted into polynomials in all occurring indeterminates.

These polynomials are regarded as polynomials over some extension of the rational numbers (i.e., over `Expr`, see `poly`). The choice of that extension follows the same rules as in the case of the function `factor`.

Factors of the denominator of an expression are indicated by negative multiplicities.

## Examples

### Example 1

The factors in a squarefree factorization are pairwise relatively prime, but they need not be irreducible:

```
polylib::sqrfree(  
  2 - 2*x - 6*x^4 + 6*x^5 + 6*x^8 - 6*x^9 - 2*x^12 + 2*x^13  
)
```

$$2 (x^3 + x^2 + x + 1)^3 (x - 1)^4$$

### Example 2

Even if a factorization into irreducibles has been found, irreducible factors with the same multiplicity are collected again:

```
polylib::sqrfree(x^6 + x^4*y^6 + x^2*y^2*9)
```

$$(x (x^2 + 3 y))^2$$

You can avoid this by giving a second argument:

```
polylib::sqrfree(x^6 + x^4*y^6 + x^2*y^2*9, FALSE)
```

$$x^2 (x^2 + 3 y)^2$$

### Example 3

polylib::sqrfree works also for polynomials:

```
polylib::sqrfree(poly(2 + 5*x + 4*x^2 + x^3))
```

$$\text{poly}(x + 2, [x]) \text{poly}(x + 1, [x])^2$$

## Parameters

**f**

A polynomial or an arithmetical expression

**recollect**

TRUE or FALSE

## Return Values

Factored object, i.e., an object of the domain type Factored.

## See Also

### MuPAD Functions

Factored | content | factor | irreducible | polylib::primpart

## polylib::subresultant

Subresultants of two polynomials

### Syntax

```
polylib::subresultant(f, g, <x>, <i>)
```

```
polylib::subresultant(fexpr, gexpr, <x>, <i>)
```

### Description

`polylib::subresultant(f, g)` returns the table of subresultants of polynomials  $f$  and  $g$  with respect to their first variable.

`polylib::subresultant(f, g, i)` returns the  $i$ th subresultant of polynomials  $f$  and  $g$  with respect to their first variable.

`polylib::subresultant(f, g, x)` returns the table of subresultants of polynomials  $f$  and  $g$  with respect to the variable  $x$ .

`polylib::subresultant(f, g, x, i)` returns the  $i$ th subresultant of polynomials  $f$  and  $g$  with respect to the variable  $x$ .

`polylib::subresultant(fexpr, gexpr, x)` returns the table of subresultants of polynomial expressions  $fexpr$  and  $gexpr$  with respect to the variable  $x$ .

`polylib::subresultant(fexpr, gexpr, x, i)` returns the  $i$ th subresultant of polynomial expressions  $fexpr$  and  $gexpr$  with respect to the variable  $x$ .

`polylib::subresultant` returns a particular subresultant or a table of all subresultants.

The variables and coefficient rings of both input polynomials must be identical.

The 0th subresultant is the resultant of two polynomials. See “Example 1” on page 25-61 (Symbolic Math Toolbox)

If you do not specify the variable when computing the subresultants of two polynomials, `polylib::subresultant` returns subresultants of the polynomials with respect to their first variable. See “Example 2” on page 25-62 (Symbolic Math Toolbox).

If you call `polylib::subresultant` for polynomial expressions, you must specify the variable with respect to which you want to compute subresultants. MuPAD uses the `poly` function to convert polynomial expressions to polynomials with the specified variable. The system also converts computed subresultants back to polynomial expressions.

If `poly` cannot convert expressions to polynomials, `polylib::subresultant` returns FAIL.

If the degree of the polynomial  $f$  is less than the degree of the polynomial  $g$ , the `polylib::subresultant` function interchanges  $f$  and  $g$ .

If the coefficient ring is a domain, it must have a `_divide` method.

## Examples

### Example 1

If you do not specify which subresultant to return, `polylib::subresultant` returns the table of all subresultants:

```
f := poly(3*x^4 + 3*x^3 + 4):
g := poly(x^4 + x^3 + x^2 + x + 1):
polylib::subresultant(f, g)
```

0	<code>poly(205, [x])</code>
1	<code>poly(9 x - 39, [x])</code>
2	<code>poly(9 x + 9 x<sup>2</sup> - 3, [x])</code>
3	<code>poly(3 x + 3 x<sup>2</sup> - 1, [x])</code>
4	<code>poly(3 x<sup>3</sup> + 3 x<sup>4</sup> + 4, [x])</code>

You can specify the number of the subresultant that you want to compute. For example, compute the 0th subresultant of the polynomials  $f$  and  $g$ :

```
polylib::subresultant(f, g, 0)

poly(205, [x])
```

The 0th subresultant is also the resultant of the polynomials:

```
polylib::resultant(f, g)

205
```

## Example 2

`polylib::subresultant` handles multivariate polynomials and polynomial expressions. When you compute subresultants of multivariate polynomials or polynomial expressions, you can specify the variable with respect to which you want to compute subresultants:

```
f := poly(3*x^4*y + 4*z^2):
g := poly(x^4 + x^3*y^3*z^3):
polylib::subresultant(f, g, z)
```

```
0 | poly(27 x18 y9 + 64 x8, [x, y])
1 | poly(16 x4 - 12 x7 y4 z, [x, y])
2 | poly(3 x4 y + 4 z2, [x, y])
3 | poly(x4 + x3 y3 z3, [x, y])
```

For multivariate polynomials, specifying the variable is not necessary. If you do not specify the variable when computing the subresultants of two polynomials, `polylib::subresultant` returns subresultants of the polynomials with respect to their first variable:

```
f := poly(3*x^4*y + 4*z^2):
g := poly(x^4 + x^3*y^3*z^3):
polylib::subresultant(f, g)
```



---

```

0 poly(192 y13 z18 + 256 z8, [y, z])
1 poly(48 y7 z10 + 48 x y4 z7, [y, z])
2 poly(12 y7 z8 + 12 x y4 z5, [y, z])
3 poly(-4 z2 + 3 x3 y4 z3, [y, z])
4 poly(3 x4 y + 4 z2, [y, z])

```

If you call `polylib::subresultant` for polynomial expressions, you must specify the variable with respect to which you want to compute subresultants:

```

f := 3*x^4*y + 4*z^2:
g := x^4 + x^3*y^3*z^3:
polylib::subresultant(f, g)

```

Error: Missing variable. [polylib::subresultant]

```

polylib::subresultant(f, g, x)

```

---

```

0 192 y13 z18 + 256 z8
1 48 y7 z10 + 48 x y4 z7
2 12 y7 z8 + 12 x y4 z5
3 -4 z2 + 3 x3 y4 z3
4 3 x4 y + 4 z2

```

## Parameters

**f, g**

Polynomials over Expr (the ring of arbitrary MuPAD expressions)

**fexpr, gexpr**

Polynomial expressions

**x**

An indeterminate

**i**

A nonnegative integer

## **Return Values**

Subresultant of two polynomials (or polynomial expressions) or a table of subresultants.

## **Overloaded By**

p, q

## **See Also**

**MuPAD Functions**

det | linalg::sylvester | polylib::discrim | polylib::resultant

# polylib::support

Support of a polynomial

## Syntax

```
polylib::support(p)
```

## Description

`polylib::support(p)` returns the support of `p`, that is, the list of indices with non zero coefficient in `p`.

## Examples

### Example 1

The support of a multivariate polynomial is the list of the degree vectors of its terms:

```
polylib::support(poly(x*y*z + x + 1, [x, y, z]))
```

```
[[1, 1, 1], [1, 0, 0], [0, 0, 0]]
```

For a univariate polynomial, the support is the list of the degrees of its terms. In the following polynomial `x` appears with degrees 3, 1, and 0:

```
polylib::support(Dom::UnivariatePolynomial(x)(x^3*y*z + x + 1))
```

```
[3, 1, 0]
```

## **Parameters**

**p**

A polynomial.

## **Return Values**

List of elements of the support.

# Pref - User Preferences

---

## **Pref::abbreviateOutput**

Controls the use of abbreviations in outputs

### **Syntax**

`Pref::abbreviateOutput(TRUE)`

`Pref::abbreviateOutput(FALSE)`

`Pref::abbreviateOutput(NIL)`

`Pref::abbreviateOutput()`

### **Description**

When displaying results, MuPAD by default finds common subexpressions and replaces them with abbreviations. See “Example 1” on page 26-3 (Symbolic Math Toolbox).

If you want to see the results without abbreviations, use the `Pref::abbreviateOutput(FALSE)` command. See “Example 2” on page 26-3 (Symbolic Math Toolbox).

The `Pref::abbreviateOutput()` command shows whether abbreviations are enabled or disabled. See “Example 3” on page 26-4 (Symbolic Math Toolbox).

To restore the default setting, use the `Pref::abbreviateOutput(NIL)` command. See “Example 4” on page 26-5 (Symbolic Math Toolbox).

The output of the `Pref::abbreviateOutput` command itself displays the previous setting. You can save this previous setting and switch to a new setting in a single call of `Pref::abbreviateOutput`. See “Example 5” on page 26-5 (Symbolic Math Toolbox).

## Examples

### Example 1

By default, you can see the abbreviations in long outputs:

```
solve(a*x^3 + b*x + c, x, MaxDegree = 3, IgnoreSpecialCases)
```

$$\left\{ \sigma_1 - \frac{b}{3a\sigma_1}, \frac{b}{6a\sigma_1} - \frac{\sigma_1}{2} - \frac{\sqrt{3}\left(\sigma_1 + \frac{b}{3a\sigma_1}\right)i}{2}, \frac{b}{6a\sigma_1} - \frac{\sigma_1}{2} + \frac{\sqrt{3}\left(\sigma_1 + \frac{b}{3a\sigma_1}\right)i}{2} \right\}$$

where

$$\sigma_1 = \left( \sqrt{\frac{b^3}{27a^3} + \frac{c^2}{4a^2}} - \frac{c}{2a} \right)^{1/3}$$

### Example 2

Setting `Pref::abbreviateOutput(FALSE)`, you can disable the abbreviations in outputs:

```
Pref::abbreviateOutput(FALSE):
solve(a*x^3 + b*x + c, x, MaxDegree = 3, IgnoreSpecialCases)
```

$$\left\{ \begin{aligned}
 & \left( \sqrt{\frac{b^3}{27a^3} + \frac{c^2}{4a^2} - \frac{c}{2a}} \right)^{1/3} - \frac{b}{3a \left( \sqrt{\frac{b^3}{27a^3} + \frac{c^2}{4a^2} - \frac{c}{2a}} \right)^{1/3}}, \\
 & \frac{b}{6a \left( \sqrt{\frac{b^3}{27a^3} + \frac{c^2}{4a^2} - \frac{c}{2a}} \right)^{1/3}} - \frac{\left( \sqrt{\frac{b^3}{27a^3} + \frac{c^2}{4a^2} - \frac{c}{2a}} \right)^{1/3}}{2} \\
 & - \frac{\sqrt{3} \left( \left( \sqrt{\frac{b^3}{27a^3} + \frac{c^2}{4a^2} - \frac{c}{2a}} \right)^{1/3} + \frac{b}{3a \left( \sqrt{\frac{b^3}{27a^3} + \frac{c^2}{4a^2} - \frac{c}{2a}} \right)^{1/3}} \right) i}{2}, \\
 & \frac{b}{6a \left( \sqrt{\frac{b^3}{27a^3} + \frac{c^2}{4a^2} - \frac{c}{2a}} \right)^{1/3}} - \frac{\left( \sqrt{\frac{b^3}{27a^3} + \frac{c^2}{4a^2} - \frac{c}{2a}} \right)^{1/3}}{2} \\
 & + \frac{\sqrt{3} \left( \left( \sqrt{\frac{b^3}{27a^3} + \frac{c^2}{4a^2} - \frac{c}{2a}} \right)^{1/3} + \frac{b}{3a \left( \sqrt{\frac{b^3}{27a^3} + \frac{c^2}{4a^2} - \frac{c}{2a}} \right)^{1/3}} \right) i}{2}
 \end{aligned} \right\}$$

### Example 3

You can check the current setting:

`Pref::abbreviateOutput()`



FALSE

**Example 4**

You can restore the default setting:

```
Pref::abbreviateOutput(NIL):
Pref::abbreviateOutput()
```

TRUE

**Example 5**

You can save the current setting and switch it to a new one in one function call:

```
old := Pref::abbreviateOutput(FALSE):
solve(x^3 + x + 1 = 0, x, MaxDegree = 3)
```

$$\left\{ \left( \frac{\sqrt{31}\sqrt{108}}{108} - \frac{1}{2} \right)^{1/3} - \frac{1}{3 \left( \frac{\sqrt{31}\sqrt{108}}{108} - \frac{1}{2} \right)^{1/3}}, \frac{1}{6 \left( \frac{\sqrt{31}\sqrt{108}}{108} - \frac{1}{2} \right)^{1/3}} - \frac{\left( \frac{\sqrt{31}\sqrt{108}}{108} - \frac{1}{2} \right)^{1/3}}{2} \right.$$

$$\left. - \frac{\sqrt{3} \left( \frac{1}{3 \left( \frac{\sqrt{31}\sqrt{108}}{108} - \frac{1}{2} \right)^{1/3}} + \left( \frac{\sqrt{31}\sqrt{108}}{108} - \frac{1}{2} \right)^{1/3} \right) i}{2}, \frac{1}{6 \left( \frac{\sqrt{31}\sqrt{108}}{108} - \frac{1}{2} \right)^{1/3}} \right.$$

$$\left. - \frac{\left( \frac{\sqrt{31}\sqrt{108}}{108} - \frac{1}{2} \right)^{1/3}}{2} + \frac{\sqrt{3} \left( \frac{1}{3 \left( \frac{\sqrt{31}\sqrt{108}}{108} - \frac{1}{2} \right)^{1/3}} + \left( \frac{\sqrt{31}\sqrt{108}}{108} - \frac{1}{2} \right)^{1/3} \right) i}{2} \right\}$$

You can restore the saved setting:

```
Pref::abbreviateOutput(old):  
solve(x^3 + x + 1 = 0, x, MaxDegree = 3)
```

$$\left\{ \sigma_1 - \frac{1}{3\sigma_1}, \frac{1}{6\sigma_1} - \frac{\sigma_1}{2} - \frac{\sqrt{3} \left( \frac{1}{3\sigma_1} + \sigma_1 \right) i}{2}, \frac{1}{6\sigma_1} - \frac{\sigma_1}{2} + \frac{\sqrt{3} \left( \frac{1}{3\sigma_1} + \sigma_1 \right) i}{2} \right\}$$

where

$$\sigma_1 = \left( \frac{\sqrt{31}\sqrt{108}}{108} - \frac{1}{2} \right)^{1/3}$$

## Return Values

Previously set value TRUE or FALSE

## See Also

### MuPAD Functions

`output::asciiAbbreviate` | `output::subexpr`

## Topics

“Abbreviations” (Symbolic Math Toolbox)

# Pref::alias

Controls the output of aliased expressions

## Syntax

```
Pref::alias(TRUE)
```

```
Pref::alias(FALSE)
```

```
Pref::alias(NIL)
```

```
Pref::alias()
```

## Description

An `alias` is an abbreviation for a MuPAD expression. If `Pref::alias` is enabled, the `alias` abbreviations will be used for output.

`Pref::alias()` returns the current value.

`Pref::alias(TRUE)` switches the usage of `alias` abbreviations in outputs on. This is the default setting.

`Pref::alias(FALSE)` switches the usage of aliases in outputs off.

`Pref::alias(NIL)` restores the default value which is `TRUE`.

`Pref::alias` has no effect on `print` and `fprint`.

## Environment Interactions

`Pref::alias` changes the output of aliased expressions.

## Examples

### Example 1

If an aliased expression occurs in output, it is replaced by the alias abbreviation:

```
alias(X = a + b):
X, a + b
```

*X, X*

This only works if the syntactical structure of expression matches the aliased expression:

```
2*X
```

*2 a + 2 b*

`prog::exprtree` shows that `2*X` does not contain `a + b` any more:

```
prog::exprtree(X): prog::exprtree(2*X):
```

```
_plus
|
+-- a
|
`-- b
```

```
_plus
|
+-- mult
|   |
|   +-- a
|   |   |
|   |   +-- 2
|   |   |
|   |   `-- 2
|   |
|   `-- mult
|       |
|       +-- b
|       |
|       `-- 2
```

The same holds for  $X+c$ :

```
X + c; prog::exprtree(X + c):
```

$$a + b + c$$

```
_plus
|
+-- a
|
+-- b
|
+-- c
```

With `Pref::alias(FALSE)` the back translation of aliases in the output is disabled:

```
Pref::alias(FALSE):
X
```

$$a + b$$

`Pref::alias` has no effect on `print` and `fprint` outputs:

```
Pref::alias(TRUE):
print(X):
```

$$a + b$$

## Return Values

Previously set value

## See Also

### MuPAD Functions

`alias` | `expr2text` | `fprint` | `print`

## Pref::autoExpansionLimit

Set a limit for automatic expansions

### Syntax

```
Pref::autoExpansionLimit(n)
```

```
Pref::autoExpansionLimit(NIL)
```

```
Pref::autoExpansionLimit()
```

### Description

`Pref::autoExpansionLimit(n)` sets a limit for the size of the arguments up to which the functions `bernoulli`, `Ei`, `euler`, `fact`, `fact2`, `gamma`, `harmonic`, `igamma`, `psi`, and `zeta` produce explicit results. Cf. “Example 1” on page 26-10 (Symbolic Math Toolbox).

It also sets a limit for the exponent up to which real and imaginary parts of powers are computed explicitly. Cf. “Example 2” on page 26-12 (Symbolic Math Toolbox).

Use `expand` for larger arguments if explicit results are desired. Cf. “Example 1” on page 26-10 (Symbolic Math Toolbox).

The call `Pref::autoExpansionLimit()` returns the current value of the limit without changing it.

The call `Pref::autoExpansionLimit(NIL)` resets the limit to its default value 1000.

### Examples

#### Example 1

The functions `bernoulli`, `euler`, `gamma`, `zeta` etc. automatically produce explicit results if the arguments are not too large:

```
bernoulli(22),
euler(24),
gamma(26),
zeta(28)
```

$$\frac{854513}{138}, 15514534163557086905, 15511210043330985984000000,$$

$$\frac{6785560294 \pi^{28}}{564653660170076273671875}$$

These functions return symbolic answers when the argument is larger than the limit set by Pref::autoExpansionLimit:

```
Pref::autoExpansionLimit()
```

1000

```
bernoulli(1002),
euler(2002),
gamma(3001),
zeta(4001)
```

bernoulli(1002), euler(2002),  $\Gamma(3001)$ ,  $\zeta(4001)$

We reduce this limit:

```
Pref::autoExpansionLimit(20):
```

```
bernoulli(22),
euler(24),
gamma(26),
zeta(28)
```

bernoulli(22), euler(24),  $\Gamma(26)$ ,  $\zeta(28)$

We can use expand to obtain explicit results:

```
expand(bernoulli(22)),
expand(euler(24)),
```

```
expand(gamma(26)),
expand(zeta(28))
```

$$\frac{854513}{138}, 15514534163557086905, 15511210043330985984000000,$$

$$\frac{6785560294 \pi^{28}}{564653660170076273671875}$$

We restore the default value:

```
Pref::autoExpansionLimit(NIL):
```

## Example 2

If binomial expansion is needed, the closed formula for the real part of an expression can become quite large:

```
Re((a+sqrt(2)*I)^6) assuming a in R_
```

$$\sqrt{2} (\sqrt{2} \sigma_2 - a \sigma_1) - a (\sqrt{2} \sigma_1 + a \sigma_2)$$

where

$$\sigma_1 = a (2 \sqrt{2} a^2 + \sqrt{2} (a^2 - 2)) - \sqrt{2} (4 a - a (a^2 - 2))$$

$$\sigma_2 = \sqrt{2} (2 \sqrt{2} a^2 + \sqrt{2} (a^2 - 2)) + a (4 a - a (a^2 - 2))$$

Thus, for exponents beyond `Pref::autoExpansionLimit()`, no expansion is carried out:

```
Re((a+sqrt(2)*I)^123456) assuming a in R_
```

$$\Re((a + \sqrt{2} i)^{123456})$$



## Parameters

**n**

The limit: a positive numerical real value

## Return Values

Previously defined limit.

## See Also

### MuPAD Functions

Ei | Im | Re | bernoulli | euler | fact | fact2 | gamma | harmonic | igamma | psi | zeta

## Pref::autoPlot

Automatically plot graphical objects

### Syntax

`Pref::autoPlot(TRUE)`

`Pref::autoPlot(FALSE)`

`Pref::autoPlot(NIL)`

`Pref::autoPlot()`

### Description

`Pref::autoPlot(TRUE)` makes graphical objects be plotted instead of typeset.

By default, graphical objects such as `plot::Function3d` are output just like any other MuPAD object, i.e., as a rendered representation of the input. After setting `Pref::autoPlot(TRUE)`, graphical objects and sequences of such objects are automatically rendered instead, as if the user had written `plot(...)`.

This setting only works when typesetting is enabled.

### Return Values

Previously set value

### See Also

#### **MuPAD Functions**

`plot`

# Pref::callBack

Informations during evaluation

## Syntax

Pref::callBack(<func>)

## Description

The function `func` defined by `Pref::callBack(func)` will be called permanently, when the MuPAD kernel works. Therewith informations can be displayed to inform the user.

A call of `Pref::callBack` without arguments returns the current value. The argument `NIL` resets the default value, which is `NIL`.

## Examples

### Example 1

The following combination of `Pref::postInput` (initialization) and time count with `Pref::callBack` shows the seconds during evaluating.

```
Pref::postInput(proc() begin START:= time(); TIME:= START end_proc):
Pref::callBack(proc()
  begin
    if time() - TIME > 1000 then // 1 sec
      TIME:= TIME+1000;
      print(floor((time() - START)/1000))
    end_if
  end_proc):
NOW:= time():
while time() - NOW <= 10000 do 1 end_while:
```

2

3

4

5

6

7

8

9

## **Parameters**

**func**

Function to display informations

## **Return Values**

Previously defined function

## See Also

### **MuPAD Functions**

Pref::postInput | Pref::postOutput | Pref::report

## Pref::callOnExit

Defines an exit handler

### Syntax

Pref::callOnExit(f)

Pref::callOnExit(list)

Pref::callOnExit(NIL)

Pref::callOnExit()

### Description

Pref::callOnExit(f) defines a function `f` which is called on exit or reset of MuPAD.

Pref::callOnExit(list) defines a list of functions which are executed in the order of their occurrence in `list` on exit of MuPAD.

Pref::callOnExit(NIL) sets the default value, which is NIL.

Pref::callOnExit() returns the current value.

### Parameters

**f**

A function

**list**

A list of functions

## Return Values

Pref::callOnExit returns the previously defined function, list of functions, or NIL.

## Algorithms

Pref::callOnExit can be used to send communication modules a disconnect message or to remove temporary user-defined files when leaving MuPAD.

## See Also

### **MuPAD Functions**

Pref::postOutput | reset

## Pref::floatFormat

Representation of floating-point numbers

### Syntax

Pref::floatFormat(mode)

Pref::floatFormat(NIL)

Pref::floatFormat()

### Description

Pref::floatFormat controls the output format of floating-point numbers on page 7-23.

The representation mode can be one of the characters "e", "f", "g", "h", or "x". These are the standard C-command printf switches. Their meaning is:

- "e":  
exponential representation (floating-point representation, "scientific format").
- "f":  
decimal representation without exponents.
- "g":  
a mix between "e" and "f". Numbers  $x$  satisfying  $\frac{1}{10^{DIGITS}} \leq |x| \leq 10^{DIGITS}$  are displayed without exponents. All other numbers are displayed in floating-point representation.
- "h" or "x":  
hexadecimal representation, except for `expr2text` and `typesetting`, which fall back to "g".

The default value is "g".



Pref::floatFormat() returns the current mode without changing it. The call Pref::floatFormat(NIL) resets to the default value "g".

## Examples

### Example 1

The exponential representation of a floating-point number consists of its sign, its mantissa and its exponent:

```
Pref::floatFormat("e"):
12345.67890, -0.00012345
```

12345.6789, -0.00012345

Without exponents, the size of a number is indicated by trailing or leading zeroes:

```
Pref::floatFormat("f"):
7.0*10^21, 7.0/10^21
```

7.0 10<sup>21</sup>, 7.0 10<sup>-21</sup>

The mixed representation:

```
Pref::floatFormat("g"):
1e-10, 9.99e-11
```

0.0000000001, 9.99 10<sup>-11</sup>

```
2.0^36, 2.0^37
```

68719476744.0, 1.374389535 10<sup>11</sup>

Hexadecimal display is ignored in typeset output and expr2text:

```
Pref::floatFormat("h"):
12345.67890, 0.00012345;
expr2text(12345.67890, 0.00012345)
```

12345.6789, 0.00012345

"12345.6789, 0.00012345"

Hexadecimal display is used in the ASCII print output:

```
PRETTYPRINT := FALSE:
print(Plain, 12345.67890, 0.00012345);
PRETTYPRINT := TRUE:
```

3.039adcc63f141208@3, 8.1725b672ee34260@-4

The representation is reset to the default mode:

```
Pref::floatFormat(NIL):
```

## Parameters

**mode**

One of the character strings "e", "f", "g", "h", or "x"

## Return Values

Previously defined representation mode

## See Also

### **MuPAD Functions**

DIGITS | Pref::outputDigits | Pref::trailingZeroes | print

# Pref::fourierParameters

Specify parameters for Fourier and inverse Fourier transforms

## Syntax

`Pref::fourierParameters(c, s)`

`Pref::fourierParameters([c, s])`

`Pref::fourierParameters(NIL)`

`Pref::fourierParameters()`

## Description

`Pref::fourierParameters(c, s)`, or the equivalent call `Pref::fourierParameters([c, s])`, specifies parameters used by the `fourier` and `ifourier` functions when computing Fourier and inverse Fourier transforms. See “Example 1” on page 26-24 (Symbolic Math Toolbox).

The Fourier transform of the expression  $f = f(t)$  with respect to the variable  $t$  at the point  $w$  is defined as follows:

$$F(w) = c \int_{-\infty}^{\infty} f(t) e^{i s w t} dt$$

The inverse Fourier transform of the expression  $F = F(w)$  with respect to the variable  $w$  at the point  $t$  is defined as follows:

$$f(t) = \frac{|s|}{2 \pi c} \int_{-\infty}^{\infty} F(w) e^{-i s w t} dw$$

$c$  and  $s$  are the parameters of the Fourier transform controlled by `Pref::fourierParameters`.

By default,  $c = 1$  and  $s = -1$ . Other common choices for the parameter  $c$  are  $\frac{1}{2\pi}$  or

$\frac{1}{\sqrt{2\pi}}$ . Other common choices for the parameter  $s$  are  $1$ ,  $-2\pi$ , or  $2\pi$ .

`Pref::fourierParameters()` returns the current values of the Fourier parameters without changing them.

`Pref::fourierParameters(NIL)` restores the default settings  $c = 1$ ,  $s = -1$ .

`Pref::fourierParameters` also controls the parameters used by the `fourier::addpattern` and `ifourier::addpattern` functions. See “Example 2” on page 26-25 (Symbolic Math Toolbox).

## Environment Interactions

Changing Fourier parameters using `Pref::fourierParameters` can affect results returned by `fourier` and `ifourier` in the current MuPAD session.

## Examples

### Example 1

Compute the Fourier transform of this expression using the default values  $c = 1$ ,  $s = -1$  of the Fourier parameters:

```
assume(Re(a) > 0):
fourier(t*exp(-a*t^2), t, w)
```

$$-\frac{w\sqrt{\pi}e^{-\frac{w^2}{4a}}i}{2a^{3/2}}$$

Use `Pref::fourierParameters` to change the values of the Fourier parameters to  $c = 1$ ,  $s = 1$ . Then compute the Fourier transform of the same expression again:

```
Pref::fourierParameters(1, 1):
fourier(t*exp(-a*t^2), t, w)
```

$$\frac{w \sqrt{\pi} e^{-\frac{w^2}{4a}}}{2 a^{3/2}} i$$

Change the values of the Fourier parameters to  $\frac{1}{2\pi}$  and 1. Compute the Fourier transform using these values:

```
Pref::fourierParameters(1/(2*PI), 1):
fourier(t*exp(-a*t^2), t, w)
```

$$\frac{w e^{-\frac{w^2}{4a}}}{4 a^{3/2} \sqrt{\pi}} i$$

For further computations, restore the default values of the Fourier transform parameters:

```
Pref::fourierParameters(NIL):
```

## Example 2

Use the default values of the Fourier transform parameters:

```
Pref::fourierParameters()
```

```
[1, -1]
```

Add this new Fourier transform pattern for the function foo:

```
fourier::addpattern(foo(t), t, w, bar(w)):
fourier(foo(t), t, w)
```

```
bar(w)
```

The Fourier pair (`foo`, `bar`) is assumed to be valid for the current values of the Fourier parameters. When changing these parameters, you change the definition of the Fourier transform. Therefore, after changing Fourier parameters, the transform of `foo(t)` is not `bar(w)` anymore. The `fourier` function computes the result which is valid for the new parameters:

```
Pref::fourierParameters(c, s):  
fourier(foo(t), t, w)
```

$c \text{ bar}(-s w)$

Now restore the Fourier transform parameters to their default values 1 and -1:

```
Pref::fourierParameters(NIL):
```

## Parameters

**c**

Arithmetical expression (Symbolic Math Toolbox)

**s**

Arithmetical expression (Symbolic Math Toolbox)

## Return Values

List containing the previously set values of `c` and `s`

## See Also

### MuPAD Functions

`fourier` | `fourier::addpattern` | `ifourier` | `ifourier::addpattern`

# Pref::heavisideAtOrigin

Set value of Heaviside function at origin

## Syntax

```
Pref::heavisideAtOrigin(val)
```

```
Pref::heavisideAtOrigin(NIL)
```

```
Pref::heavisideAtOrigin()
```

## Description

`Pref::heavisideAtOrigin(val)` sets the value of the `heaviside` function at the origin and returns the old value. See “Example 1” on page 26-28 (Symbolic Math Toolbox). The default value of `heaviside` at the origin is  $1/2$ . Other common choices for `heaviside(0)` are 0 or 1. This preference can affect the output of functions that call `heaviside`.

`Pref::heavisideAtOrigin()` returns the current value of `heaviside(0)`.

`Pref::heavisideAtOrigin(NIL)` restores the default setting `heaviside(0) = 1/2`.

## Environment Interactions

Changing the value of `heaviside(0)` using `Pref::heavisideAtOrigin` can affect results returned by functions that call `heaviside`, such as `ztrans(heaviside(x),x,z)`.

## Examples

### Example 1

`Pref::heavisideAtOrigin` controls the value of the heaviside function at the origin. The default value is  $1/2$ . Other common choices are 0 or 1.

Return the value of `heaviside(0)` and `ztrans(heaviside(x),x,z)`.

```
heaviside(0);  
ztrans(heaviside(x),x,z)
```

$$\frac{1}{2}$$

$$\frac{1}{z-1} + \frac{1}{2}$$

Set `heaviside(0)` to 1 using `Pref::heavisideAtOrigin`. Store the old value returned to restore it later.

```
oldval := Pref::heavisideAtOrigin(1)
```

$$\frac{1}{2}$$

Check the new value of `heaviside(0)`. Find the Z-transform of `heaviside(x)` for this value.

```
heaviside(0);  
ztrans(heaviside(x),x,z)
```

$$1$$

$$\frac{1}{z-1} + 1$$

The output of `ztrans` is affected by the new value of `heaviside(0)`.



Restore the old value of `heavisideAtOrigin` using `oldval`.

```
Pref::heavisideAtOrigin(oldval):
```

Alternatively, restore the default value of `heavisideAtOrigin` by specifying the input as `NIL`.

```
Pref::heavisideAtOrigin(NIL):
```

## Parameters

**val**

Arithmetical expression (Symbolic Math Toolbox)

## Return Values

The previously set value of `val`.

## See Also

### MuPAD Functions

`Pref::fourierParameters` | `heaviside`

## Pref::`ignoreNoDebug`

Controls debugging of procedures

### Syntax

`Pref::ignoreNoDebug(TRUE)`

`Pref::ignoreNoDebug(FALSE)`

`Pref::ignoreNoDebug(NIL)`

`Pref::ignoreNoDebug()`

### Description

`Pref::ignoreNoDebug(TRUE)` allows debugging of procedures even if they have the option `noDebug` set.

`Pref::ignoreNoDebug()` returns the current value.

`Pref::ignoreNoDebug(NIL)` resets the default value, which is `FALSE`.

`Pref::ignoreNoDebug(FALSE)` resets the default value, which is `FALSE`.

### Return Values

Previously set value

### See Also

#### **MuPAD Domains**

`DOM_PROC`

**MuPAD Functions**  
debug

## Pref::keepOrder

Order of terms in sum outputs

### Syntax

`Pref::keepOrder(<Always>)`

`Pref::keepOrder(<DomainsOnly>)`

`Pref::keepOrder(<System>)`

`Pref::keepOrder(NIL)`

`Pref::keepOrder()`

### Description

`Pref::keepOrder` influences the output order of terms in sums.

Usually, the output system uses its own ordering of the terms in a sum to optimize the appearance of the output. This order may be different from the internal ordering of the sum. The output system prefers to re-order the terms such that the first term is positive.

Sometimes it is desirable to see the terms of a sum in the internal order. This can be achieved with `Pref::keepOrder(Always)`.

By default, the term order of polynomials and domain elements is left unchanged.

`Pref::keepOrder(NIL)` restores the default state, which is `DomainsOnly`.

`Pref::keepOrder()` returns the currently set value.

## Examples

### Example 1

Here we create a domain element  $e$ , an expression  $f$ , and a polynomial  $p$  containing sums. With the default setting `DomainsOnly`, only the output of the expression  $f$  is not in the internal order:

```
d := newDomain("d"): d::print := x -> extop(x):
e := new(d, b - a): f := b - a: p := poly(1 - x):
e, f, p
```

$$-a + b, b - a, \text{poly}(-x + 1, [x])$$

With the setting `Always`,  $e$ ,  $f$ , and  $p$  are all printed in the internal order:

```
Pref::keepOrder(Always):
e, f, p
```

$$-a + b, -a + b, \text{poly}(-x + 1, [x])$$

With the setting `System`, the output order differs from the internal ordering for  $e$ ,  $f$ , and  $p$ :

```
Pref::keepOrder(System):
e, f, p
```

$$b - a, b - a, \text{poly}(1 - x, [x])$$

`Pref::keepOrder(NIL)` restores the default state; `Pref::keepOrder()` returns the current setting:

```
Pref::keepOrder(NIL): Pref::keepOrder()
```

$$\text{DomainsOnly}$$

## Options

### Always

The output always corresponds to the internal order.

### DomainsOnly

In polynomials and domain elements, the ordering of terms corresponds to the internal order. Other sums may be re-ordered by the output system.

This is the default setting of `Pref::keepOrder`.

### System

The output order of terms in sums is determined by the output system and does not necessarily correspond to the internal order.

## Return Values

Previously defined value: `Always`, `DomainsOnly`, or `System`.

## See Also

### MuPAD Domains

`DOM_POLY` | `Dom::MultivariatePolynomial` | `Dom::Polynomial` |  
`Dom::UnivariatePolynomial`

### MuPAD Functions

`print`

# Pref::kernel

Version number of the presently used kernel

## Syntax

```
Pref::kernel()
```

```
Pref::kernel(<BitsInLong>)
```

```
Pref::kernel(<BuildNr>)
```

## Description

The version numbers of the kernel and the library may differ. `Pref::kernel` refers to the kernel, whereas the call `version()` returns the version number of the installed MuPAD library.

## Examples

### Example 1

Here the version numbers of kernel and library do not differ:

```
Pref::kernel() = version()
```

```
[8, 1, 0] = [8, 1, 0]
```

### Example 2

A 32-bit architecture:

```
Pref::kernel(BitsInLong)
```

32

### **Example 3**

At the time of this writing, kernels build number was 42703:

```
Pref::kernel(BuildNr)
```

42703

## **Options**

### **BitsInLong**

`Pref::kernel(BitsInLong)` returns the number of bits of a long integer number. On a 64-bit architecture it returns 64, otherwise 32.

### **BuildNr**

The kernel has an additional build number which enables the developers to identify the exact sources for this kernel.

## **Return Values**

Version number: a list of three nonnegative integers or a number.

## **See Also**

### **MuPAD Functions**

`buildnumber` | `version`



## Pref::maxMem

Set a memory limit for the session

### Syntax

Pref::maxMem(kbytes)

Pref::maxMem(NIL)

Pref::maxMem()

### Description

Pref::maxMem(kbytes) with kbytes greater than 0 sets a limit for the physically allocated memory on page 1-365 of the current MuPAD session. A computation exceeding this memory limit raises an error.

The physically allocated memory is the second of the values returned by bytes().

---

**Note** The memory limit is “soft” because the memory is checked only occasionally. Usually, more memory is actually used before the excess is detected. Cf. “Example 1” on page 26-38 (Symbolic Math Toolbox).

---

The call Pref::maxMem() returns the current value of the memory limit without changing it.

The call Pref::maxMem(NIL) switches off the memory watch dog.

## Examples

### Example 1

No computation should increase the memory usage of the current MuPAD session to more than a total of 10 megabytes:

```
Pref::maxMem(10 * unit::MByte):
```

The following loop creates larger and larger matrices until the memory limit is exceeded. Note that the current physical memory allocation returned by `bytes()[2]` is measured in bytes:

```
for n from 100 to 150 step 5 do
  A := linalg::vandermonde([x.j $ j=1..n]);
  print(n, ceil(bytes()[2]/1024)*unit::kByte);
end_for:
```

```
100, 7311 kByte
```

```
105, 9311 kByte
```

```
110, 9648 kByte
```

```
115, 10113 kByte
```

```
Error: Out of
memory [watchdog-memory];   Evaluating: linalg::vandermonde
```

```
Error: Out of memory. [watchdog-memory]
Evaluating: linalg::vandermonde
```

Note that the memory limit was exceeded when computing the  $115 \times 115$  Vandermonde matrix. However, because the memory consumption is measured only occasionally, this matrix was generated successfully without an error. Only in the next step, the memory watchdog recognizes excessive memory usage and aborts the computation of the  $120 \times 120$  Vandermonde matrix.

Pref::maxMem(NIL):  
delete A:

## Parameters

### kbytes

The memory limit in kBytes: a nonnegative integer or an expression using `unit::Byte`, `unit::kByte`, `unit::MByte`, or `unit::GByte`.

## Return Values

Previously defined memory limit: 0 or an expression involving `unit::MByte`.

## See Also

### MuPAD Functions

MAXDEPTH | Pref::maxTime | bytes

## Pref::maxTime

Time limit for computations

### Syntax

```
Pref::maxTime(seconds)
```

```
Pref::maxTime(NIL)
```

```
Pref::maxTime()
```

### Description

`Pref::maxTime(seconds)` with `seconds` greater than 0 sets a time limit for all following MuPAD instructions. Each computation not finished within the given time raises an error.

The call `Pref::maxTime()` returns the current value of the time limit without changing it.

The call `Pref::maxTime(NIL)` switches off the timer watch dog.

### Examples

#### Example 1

No computation should take more than 10 seconds:

```
Pref::maxTime(10 * unit::sec):
```

Note that `time` returns the CPU time in milliseconds. The following `while` loop is designed to run longer than 10 seconds:

```
TIME:= time():  
while time() - TIME < 20000 do null() end_while
```

Error: Execution time exceeded. [watchdog-time]

Pref::maxTime(NIL): delete TIME:

## Parameters

### seconds

The time limit in seconds: a nonnegative integer or an expression involving time units. on page 1-2196

## Return Values

Previously defined time limit: 0 or an expression involving `unit::sec`.

## See Also

### MuPAD Functions

Pref::maxMem | rtime | time | traperror

## Pref::output

Modify the screen output of objects

### Syntax

`Pref::output(f)`

`Pref::output(NIL)`

### Description

`Pref::output` allows to modify the screen output of objects returned by the MuPAD kernel.

When the MuPAD kernel returns a result  $x$ , say, of a computation, the function  $f$  is called before the result is printed to the screen. Instead of  $x$ , the return value  $f(x)$  is used as screen output of the computation.

Make sure that a user-defined output function  $f$  processes *arbitrary MuPAD objects*.

The call `Pref::output(NIL)` resets the output function to the identity map: the screen output coincides with the object returned by the computation. `NIL` is the default value of the output function.

### Examples

#### Example 1

All numbers of type `Type::Numeric` shall be displayed as floating point numbers. Since the kernel may return sequences on page 1-88 of objects, the output function may be called with an unknown number of parameters. It uses `map` to apply its functionality to all of its arguments. Whenever a numerical object of type `Type::Numeric` is encountered, it is replaced by a floating-point approximation:

```
f := proc(x)
begin
  if args(0) > 1 then
    return(map(args(), f))
  end_if;
  if testtype(x, Type::Numeric) then
    return(float(x))
  else return(x)
  end_if;
end_proc:
Pref::output(f):
```

```
4/9; sin(3); 4/9, sin(3), 1/2 + 17*I
```

```
0.4444444444
```

```
sin(3)
```

```
0.4444444444, sin(3), 0.5 + 17.0 i
```

We restore the standard mode:

```
Pref::output(NIL): delete f:
```

## Example 2

The procedure `generate::TeX` is applied to the result of a computation. The corresponding TeX code (a string) is displayed:

```
Pref::output(generate::TeX):
sqrt(x^2 - 1/x)
```

```
"\sqrt{x^2-\frac{1}{x}}"
```

We restore the standard mode:

```
Pref::output(NIL):
```

## **Parameters**

**f**

The “output function”: a procedure on page 1-1654

## **Return Values**

Previously defined “output function”, or NIL.

## **See Also**

### **MuPAD Functions**

`Pref::keepOrder` | `Pref::postInput` | `Pref::postOutput`



# Pref::outputDigits

Set the number of digits in floating-point outputs

## Syntax

```
Pref::outputDigits(n)
```

```
Pref::outputDigits(<UseDigits>)
```

```
Pref::outputDigits(<InternalPrecision>)
```

```
Pref::outputDigits()
```

## Description

`Pref::outputDigits(n)` sets the number of digits in outputs of floating-point numbers on page 7-23 to an integer *n*. This command does not set the precision for calculations. See “Example 1” on page 26-46 (Symbolic Math Toolbox).

`Pref::outputDigits(InternalPrecision)` sets the number of digits in floating-point outputs to settings MuPAD used when creating these floating-point numbers. If you use `Pref::outputDigits(InternalPrecision)`, the lengths of floating-point numbers in the same output region can differ because the numbers were created with different precision. See “Example 2” on page 26-46 (Symbolic Math Toolbox).

`Pref::outputDigits(UseDigits)` restores the setting to the number of digits previously set by `DIGITS`. The default value for `DIGITS` is 10. Suppose, you use internal precision for displaying numbers or explicitly specify a number of digits in outputs. If you want to switch back to the number of digits specified by `DIGITS`, use `Pref::outputDigits(UseDigits)`. See “Example 3” on page 26-47 (Symbolic Math Toolbox).

`Pref::outputDigits()` returns the current setting for the number of digits in outputs of floating-point numbers. This command does not change the setting.





## Parameters

**n**

An integer

## Return Values

Previously set value

## See Also

### **MuPAD Functions**

`DIGITS` | `Pref::floatFormat` | `float`

# Pref::postInput

Actions after input

## Syntax

`Pref::postInput(f)`

`Pref::postInput(NIL)`

`Pref::postInput()`

## Description

`Pref::postInput` allows to set user actions directly after input.

After entering any MuPAD command  $x$ , say, and sending this command to the kernel,  $f(x)$  is called before the kernel starts to process the input. This happens for any input until the post-input is switched off via the call `Pref::postInput(NIL)`.

The function  $f$  implicitly uses the option `hold`, i.e.,  $f$  sees the input command as entered and parsed without any evaluation.

$f$  cannot change the input command that is sent to the kernel for evaluation. However,  $f$  can store the input in some global variable for later processing, or some other actions can be performed.

`Pref::postInput()` returns the current value of the post-input function or `NIL`, respectively.

`Pref::postInput`, possibly in conjunction with `Pref::postOutput`, is useful for initializing variables to compute status information such as the execution time for the command that is to be executed. See “Example 2” on page 26-51 (Symbolic Math Toolbox).

## Examples

### Example 1

The post-input function sees the input as entered, i.e., before evaluation by the kernel:

```
Pref::postInput(proc() begin
  print(Unquoted, "input" = args())
end):
```

```
1 + 2
```

```
input = 1 + 2
```

```
3
```

```
1 + 2, x = sin(0.1)
```

```
input = (1 + 2, x = sin(0.1))
```

```
3, x = 0.09983341665
```

```
x := 1234; y := 5678
```

```
input = (x := 1234)
```

```
1234
```

```
input = (y := 5678)
```

```
5678
```

Post-input is switched off. This command calls the post-input function for the very last time:

```
Pref::postInput(NIL):
```

```
input = Pref::postInput(NIL)
```

```
delete x, y:
```

## Example 2

For any command, the run time is to be computed and displayed. The function declared in `Pref::postInput` sets a global timer value `TIME` after each input. After the output of the result, the function declared in `Pref::postOutput` compares the current time and the starting time `TIME`.

```
Pref::postInput(() -> (TIME:= time())):
Pref::postOutput(() -> "Time: ".expr2text((time() - TIME)*msec)):
```

```
int(cos(x)*exp(sin(x)), x)
```

$$e^{\sin(x)}$$

```
Time: 40 msec
```

$$e^{\sin(x)}$$

```
Time: 40 msec
```

```
Pref::postInput(NIL): Pref::postOutput(NIL):
delete TIME:
```

## Example 3

As another example of using `Pref::postInput` for storing information to influence the output, we combine it with `Pref::output` to include (a rendered version of) the input and the result:

```
Pref::postInput(() -> (LASTINPUT := args())):
Pref::output(() -> val(LASTINPUT) = args()):
```

This makes MuPAD write “input = result” to the screen, while leaving the history (accessible by %) intact:

```
int(x, x);  
sum((-1)^i/(2*i+1), i=0..infinity);  
sin(%)
```

$$\int x \, dx = \frac{x^2}{2}$$

$$\sum_{i=0}^{\infty} \frac{(-1)^i}{2i+1} = \frac{\pi}{4}$$

$$\sin(\%) = \frac{\sqrt{2}}{2}$$

## Parameters

**f**

The function to be executed after input: a procedure on page 1-1654. The default value of this function is NIL (no post-input).

## Return Values

Previously set post-input function.

## See Also

**MuPAD Functions**  
Pref::postOutput



# Pref::postOutput

Actions after output

## Syntax

```
Pref::postOutput(f)
```

```
Pref::postOutput(NIL)
```

```
Pref::postOutput()
```

## Description

After the result  $x$ , say, of a MuPAD command is printed on the screen,  $f(x)$  is called and executed before the next prompt for user input appears. This happens for any output until the post-output is switched off via `Pref::postOutput(NIL)`.

After the usual output of the result  $x$  of a MuPAD command, the return value of  $f(x)$  is printed on the screen with `PRETTYPRINT = FALSE`. However,  $f(x)$  does not return any value to the MuPAD session. It cannot be accessed via `last`.

`Pref::postOutput()` returns the current value of the post-output function or `NIL`, respectively.

`Pref::postOutput`, possibly in conjunction with `Pref::postInput`, can be used to produce status information after each output. One may think of timer informations, memory usage, result types etc.

## Examples

### Example 1

Here, `Pref::postOutput` is used to enumerate the output line and display the type of the result. It uses the global variable `LineNumber` which must be initialized before any

output is produced. The definition of the post-output operation as well as the initialization of the global variable can be done in the file "userinit.mu" which is read automatically during start-up.

```
Pref::postOutput(  
  proc()  
  begin  
    LineNumber:= LineNumber + 1;  
    "Out[" . expr2text(LineNumber). "]: "  
    "type = ".expr2text(op(map([args()], domtype)));  
  end_proc):  
LineNumber:= 0:  
  
int(x^5*exp(-x), x)
```

$$-e^{-x} (x^5 + 5x^4 + 20x^3 + 60x^2 + 120x + 120)$$

Out[1]: type = DOM\_EXPR

```
int(x^5*exp(-x), x = 0..infinity),  
numeric::int(x^5*exp(-x), x = 0..infinity)
```

120, 120.0

Out[2]: type = DOM\_INT, DOM\_FLOAT

The following print command returns the void object null() to the MuPAD session. The output of null() is suppressed:

```
print("print returns the void object")
```

"print returns the void object "

The following command is terminated by a semicolon to suppress the output. Consequently, no post-output is created, either.

```
x := sin(2):
```

Post-output is switched off:

```
Pref::postOutput(NIL): delete LineNumber, x:
```

## Example 2

For any command, the run time is to be computed and displayed. The function declared in `Pref::postInput` sets a global timer value `TIME` after each input. After the output of the result, the function declared in `Pref::postOutput` compares the current time and the starting time `TIME`. The current `TEXTWIDTH` is used to prepend some suitable whitespace via `stringlib::format` to flush right the timer information:

```
Pref::postInput(() -> (TIME:= time())):
Pref::postOutput(
  proc() begin
    stringlib::format("Time: ".expr2text(time() - TIME)." msec",
                      TEXTWIDTH-1, Right)
  end_proc):
int(x^10*exp(-x), x)
```

$$-e^{-x} (x^{10} + 10 x^9 + 90 x^8 + 720 x^7 + 5040 x^6 + 30240 x^5 + 151200 x^4 + 604800 x^3 + 1814400 x^2 + 3628800 x + 3628800)$$

Time: 84.005 msec

```
Pref::postInput(NIL): Pref::postOutput(NIL):
delete T, TIME:
```

## Example 3

The following post-output lists all identifiers with properties on page 1-265 in the result of the last MuPAD command. It extracts the indeterminates via `indets` and uses `property::hasprop` to query whether they have properties:

```
Pref::postOutput(
  proc()
  begin
    select(indets({args()}), property::hasprop);
    "identifiers with properties: " . expr2text(op(%)
  end_proc):
```

```
assume(0 < a < b): a + b + c
```

*a + b + c*

identifiers with properties: a, b

```
Pref::postOutput(NIL): delete a, b:
```

## Parameters

**f**

The function to be executed after output: a procedure on page 1-1654. The default value of this function is NIL (no post-output).

## Return Values

Previously set post-output function.

## See Also

**MuPAD Functions**  
Pref::postInput

# Pref::report

Informations during evaluation

## Syntax

`Pref::report(level)`

## Description

`Pref::report` controls the frequency of report messages of the MuPAD kernel during evaluation.

A kernel function displays frequently the three informations *memory used*, *memory reserved* and *evaluation time in seconds*.

The level `0` disables printing information. If `level` is `1`, about every hour a message will be printed. With `9` as argument the most reports will be printed. The frequency depends on the machine's speed.

A call of `Pref::report` without arguments returns the current value. The argument `NIL` resets the default value `0`.

## Examples

### Example 1

Frequently information:

```
Pref::report(9):
limit((1+1/n)^n,n=infinity)

[used=1612k,
reserved=1738k, seconds=1] [used=2716k, reserved=2856k, seconds=2]
                             exp(1)
```

Reset to no information:

`Pref::report(0):`

## Parameters

### level

An integer between 0 and 9, or NIL

## Return Values

Last defined level

## See Also

### MuPAD Functions

`Pref::callBack`

# Pref::trailingZeroes

Trailing zeroes when printing floating-point numbers

## Syntax

```
Pref::trailingZeroes(value)
```

```
Pref::trailingZeroes()
```

## Description

`Pref::trailingZeroes` determines, whether trailing zeroes will be appended, when floating-point numbers are printed.

If enabled (with argument `TRUE`), after the significant numbers of a floating-point number (behind the point) zeroes will be appended until the number of digits reaches the value of `DIGITS`.

A call of `Pref::trailingZeroes` without arguments will return the current value. The argument `NIL` will reset the default value, which is `FALSE`.

## Examples

### Example 1

By default, trailing zeroes will not be displayed:

```
DIGITS:= 10:  
1.4
```

```
1.4
```

Display of trailing zeroes will be enabled:

```
Pref::trailingZeroes(TRUE):  
1.4
```

```
1.400000000
```

The default mode is restored:

```
Pref::trailingZeroes(NIL):
```

## Parameters

**value**

TRUE, FALSE or NIL

## Return Values

Last defined value.

## See Also

### **MuPAD Functions**

DIGITS | Pref::floatFormat | print



# Pref::typeCheck

Type checking of formal parameters

## Syntax

```
Pref::typeCheck(Always | Interactive | None)
```

```
Pref::typeCheck(NIL)
```

```
Pref::typeCheck()
```

## Description

`Pref::typeCheck` determines the kind of type checking of procedure parameters.

The definition of a MuPAD procedure may contain formal parameters. There is a syntax to attach a type specification to these parameters. If and when type checking is enabled, the types of actual parameters are checked against the type specifications and an error is raised if a parameter does not meet the specification.

Type specifications are used as the second parameter of `testtype`. The most important ones are “Domain Types” (Symbolic Math Toolbox) and objects of the domain `Type` (Symbolic Math Toolbox). With `Type` (Symbolic Math Toolbox), user defined types can be easily added to the system to extend the type checking mechanism.

The arguments of `Pref::typeCheck` can be:

- **None**

No parameters are checked.

- **Interactive**

Parameters entered interactively are checked. This is the default.

- **Always**

All formal parameters are checked.

The default value `Interactive` means: When the user is calling a procedure `f`, its parameters will be checked, but none of the procedures called by the user called procedure `f` performs type checking.

A call of `Pref::typeCheck` without arguments returns the current value. The argument `NIL` resets the default value, which is `Interactive`.

## Examples

### Example 1

We define a procedure `f` expecting an identifier and an integer:

```
f:= proc(a : DOM_IDENT, b : DOM_INT)
  begin
    evalassign(a, b, 1)
  end_proc:
f(a, 2)
```

2

Now `a` has the value 2, but an identifier is expected:

```
f(a, 2)
```

```
Error: Invalid object '2'. Type of argument number 1 must be 'DOM_IDENT'.
Evaluating: f
```

```
delete a:
```

## Options

### Always

Parameter types are checked for every call.

## Interactive

Parameter types are checked for interactive calls, not for “inner” calls during the computation.

## None

No parameter type checks are performed by the MuPAD kernel. Explicit checks inside procedures still use the usual `testargs` mechanism.

## Return Values

Previously defined value

## Algorithms

The syntax to test parameters directly (without a test in the procedure body) is the formal parameter followed by a colon and then the type object: `proc(a : DOM_IDENT, b : Type : Integer)`. This means: `a` must be of the type `DOM_IDENT` and `b` must be of the type `Type : Integer`.

Note that you cannot use automatic type checking for arguments that are used for overloading inside the procedure.

The objects of the `Type` (Symbolic Math Toolbox) library are usually more general than the MuPAD kernel types.

## See Also

### MuPAD Domains

`DOM_PROC`

### MuPAD Functions

`args` | `domtype` | `hastype` | `proc` | `testargs` | `testtype` | `type`

## Pref::userOptions

Additional options when starting MuPAD

### Syntax

```
Pref::userOptions()
```

### Description

`Pref::userOptions()` returns additional options, given by the user when calling MuPAD.

When starting the MuPAD kernel with the flag "-U" the user can define options that can be used in the MuPAD session.

### Examples

#### Example 1

If you start MuPAD with the command `mupad -U "Hello World"`, `Pref::userOptions` returns the string "Hello World":

```
Pref::userOptions()
```

```
"Hello World"
```

#### Example 2

To define several user options one can use a separator between the strings. MuPAD is called with `mupad -U "myhome,/home/user/myhome,2"`:

```
Pref::userOptions()
```

```
"myhome,/home/user/myhome,2"
```

The following call splits the string into the three parts (to demonstrate, the string is written explicitly):

```
s := "myhome,/home/user/myhome,2":
opts := []:
ind := 0:
while (ind := stringlib::contains(s, ",", Index)) <> FALSE do
  opts := opts . [s[1 .. ind-1]];
  s := s[ind+1 .. length(s)]:
end_while:
opts := opts . [s]
```

```
["myhome", "/home/user/myhome", "2"]
```

```
delete s, opts, ind:
```

## Return Values

User defined options as strings

## Pref::`verboseRead`

Shows reading of files

### Syntax

```
Pref::verboseRead(value)
```

```
Pref::verboseRead()
```

### Description

With `Pref::verboseRead` the reading of library packages and files can be shown.

The arguments of `Pref::verboseRead` represent:

- `0`:  
no messages when reading files (default).
- `1`:  
message if a library packages will be read.
- `2`:  
messages if a package or any library function will be read.
- `NIL`:  
restore the default value `0`.

A call of `Pref::verboseRead` without arguments returns the current value.

## Examples

### Example 1

Show the reading of library packages:

```
reset():
Pref::verboseRead(1):
sin(x)

loading package 'Type' [mupad/share/lib/lib.tar#lib/]
0.8414709848
```

Show reading of all library files:

```
reset():
Pref::verboseRead(2):
sin(1.0)

reading file mupad/share/lib/lib.tar#lib/SPECFUNC/sin.mu
reading file mupad/share/lib/lib.tar#lib/SPECFUNC/sinh.mu reading
file mupad/share/lib/lib.tar#lib/STDLIB/infinity.mu loading package
'Type' [mupad/share/lib/lib.tar#lib/] reading file mupad/share/lib/lib.tar#lib/TYPE/Ar
0.8414709848
```

The default mode is restored:

```
Pref::verboseRead(NIL):
```

## Parameters

**value**

0, 1, 2, or NIL

## Return Values

Last defined value

## See Also

### **MuPAD Functions**

fread | prog::trace | read



# Pref::warnDeadProcEnv

Warnings about wrong usage of lexical scope

## Syntax

```
Pref::warnDeadProcEnv(TRUE)
```

```
Pref::warnDeadProcEnv(FALSE)
```

```
Pref::warnDeadProcEnv(NIL)
```

```
Pref::warnDeadProcEnv()
```

## Description

`Pref::warnDeadProcEnv()` returns the current setting.

`Pref::warnDeadProcEnv(TRUE)` switches on warnings about unreachable procedure environments.

`Pref::warnDeadProcEnv(FALSE)` switches warning messages off.

`Pref::warnDeadProcEnv(NIL)` will reset the default value, which is `FALSE`.

If a procedure is executed a *procedure environment* is created for this procedure. It contains the current values of formal parameters and local variables. On exit of the procedure this procedure environment is normally not needed any more and destroyed.

If a procedure returns a local procedure as its result, this local *procedure escapes its scope*. Usually this is no problem. Only if the escaping procedure contains references to formal parameters or local variables of the outer procedure these *variables escape their scope*. These variables can not be dereferenced since they reference values of a procedure environment of the outer procedure which does not exist any more.

Use option *escape* in the outer procedure in order to keep its procedure environment untouched.

## Environment Interactions

Allows or suppresses warning messages.

### Examples

#### Example 1

Here we write procedure `p` which returns a local procedure. The returned procedure adds the value of its argument `y` to the value of the argument `x` of the first procedure. The following naive implementation produces a strange output and, when the resulting procedure is called, a warning message and an error:

```
Pref::warnDeadProcEnv(FALSE):  
p := proc(x) begin y -> x + y end:  
f := p(1); f(2)
```

$y \rightarrow \text{DOM\_VAR}(1, 2) + y$

```
Warning:  
Uninitialized variable 'unknown' used. Evaluating: f
```

```
Error: Illegal operand. [_plus] Evaluating:  
f
```

If `Pref::warnDeadProcEnv` is set to `TRUE` MuPAD will print a warning message when the local procedure escapes its scope:

```
Pref::warnDeadProcEnv(TRUE):  
p := proc(x) begin y -> x + y end:  
f := p(1)
```

```
Warning:  
Found dead closure of procedure 'p'.
```

$y \rightarrow \text{DOM\_VAR}(1, 2) + y$

Use option *escape* in the outer procedure to prevent this warning. The returned procedure `f` will then work as expected:

```
p := proc(x) option escape; begin y -> x + y end;  
f := p(1); f(2)
```

$y \rightarrow x + y$

3

## Return Values

Previously set value

## See Also

**MuPAD Functions**

proc



# **prog - Programmer's Toolbox**

---

## prog::check

Checking objects

### Syntax

```
prog::check(object, <infolevel>, options)
```

### Description

The call `prog::check(object)` checks the MuPAD object `object`. `object` may be a procedure on page 7-45, a function environment on page 7-25, or a domain on page 7-8. One may also give a list of such objects.

If `ALL` is given as first parameter, all defined procedures, function environments and domains are checked (see `anames`).

`infolevel` determines the amount of information given while checking. The following values are useful:

- 1  
summarizing number of warnings per checked object, if at least one warning occurs (default)
- 2  
as 1, but a short message is printed even if no warning was produced
- 3  
summary of warnings per checked object
- 5  
displays each checked object, followed by individual warnings, followed by a summary and the number of warnings, if any.
- 10 ... 15  
additional outputs (for debugging/information)

options can be any of the described options.

With option `All`, all are checked. Without options, the set {`Domain`, `Global`, `Interface`, `Level`, `Local`, `Protect`, `Save`} is used.

---

**Note** The arguments of `hold` expressions are not checked.

---

## Examples

### Example 1

The following function contains a number of mistakes, some of which were actually legal in previous versions of MuPAD.

Lines 1 and 2 contains declarations of local variables. In line 4 an undeclared (global) variable `g` is used. Line 7 applies `level` to a local variable (the call simply returns the value of `X` in MuPAD 2.0). Line 10 contains an assignment to a formal parameter. This parameter will be overwritten and its old value lost:

```
f:= proc(X, Y)           // 1 Local
  local a, b;           // 2 Local
  begin                 // 3
    g:= proc(X)         // 4 Global
      option hold;     // 5
      begin             // 6
        a:= level(X, 2); // 7 Level
        a:= a + X       // 8
      end_proc;        // 9
    Y:= g(Y);          // 10 Assign, Global
  end_proc:
prog::check(f, 3)
```

Critical usage of 'level' on local variable ' [f]

Function 'level' applied to variables: {X} in [f, proc in 'f']

Global idents: {g} in [f]

Unused local variables: {b} in [f]

Warnings: 3 [f]

Only search for global variables, but give more messages:

```
prog::check(f, 5, Global)
```

```
Checking f (DOM_PROC)
```

```
Global variable 'g' in [f]
```

```
Global variable 'g' in [f]
```

```
Global idents: {g} in [f]
```

```
Warnings: 1 [f]
```

Now check everything:

```
prog::check(f, 5, All)
```

```
Checking f (DOM_PROC)
```

```
Global variable 'g' in [f]
```

```
Critical usage of 'level' on local variable ' [f]
```

```
Function 'level' applied to variables: {X} in [f, proc in 'f']
```

```
Procedure environment of [f] used by [f, proc in 'f']
```

```
Assignment to formal parameter 'Y' in [f].
```

```
Global variable 'g' in [f]
```

```
Global idents: {g} in [f]
```

```
Unused local variables: {b} in [f]
```

```
Unused formal parameters: {X} in [f]
```

```
Assignments to formal parameters: {Y} in [f]
```

```
Warnings: 8 [f]
```

Global variables declared with the option “save” on page 1-1654 are allowed:

```
f:= proc(X)                // 1 Local
    save g;                // 2 Save
    begin                  // 3
        g:= X
```



```
end_proc:  
prog::check(f, 2, Global, Save)
```

```
Warnings: 0 [f]
```

## Parameters

### **object**

Procedure, function environment or domain to check, the identifier `All`, or a list of objects

### **infolevel**

Positive integer that determines the completeness of messages

## Options

### **All**

Enables all known options

### **Global**

Report unknown global identifiers

### **Local**

Report unused local variables

These are variables that were declared by `local`, but never used in the procedure.

### **Localf**

Report unused local variables *and* unused formal parameters

The same as `Local`, but the same check is additionally performed for formal parameters of a procedure. Those are the argument names as given in the definition of the procedure.

**Assign**

Report assignments to formal parameters of procedures

Because a formal parameter will be overwritten, those assignments *could* indicate a programming error (however, not imperative).

**Level**

The application of `level` to local variables is reported. Starting with MuPAD 2.0, local variables are simply replaced by their values on evaluation and calling `level` on them does not have any effect.

**Domain**

Report undefined entries of domains (uses the slot "undefinedEntries")

**Interface**

Information about undefined entries of a domain interface are printed, i.e., entries in the domain interface, that are not defined as entries of the domain.

**Environment**

Information about assignments to environment variables of MuPAD are printed. These assignments could change the global behavior of MuPAD if the change is not undone (preferably using `save`, to catch error conditions).

**Protect**

Information about assignments to protected on page 1-1679 variables of MuPAD are printed.

**Save**

A message about a global identifier is suppressed, when the checked object is a procedure and the identifier is saved with option "save" on page 1-1654.

**Special**

Information about some special cases are printed. Currently, the only implemented special case is assignments to `HISTORY`.

## Escape

prog::check prints warnings about procedures which may require the option `escape`.

## Return Values

prog::check returns the void object `null()`. Output messages are printed on the screen.

## See Also

### MuPAD Functions

`debug` | `prog::getname` | `prog::init` | `prog::isGlobal` | `prog::trace`

## prog::exprlist

Convert an expression into a nested list

### Syntax

```
prog::exprlist(ex)
```

### Description

prog::exprlist returns a list that contains all operands of the expression ex. Each operand of type DOM\_EXPR is converted into a list, too.

The return value of prog::exprlist can be used directly as argument for adt::Tree resp. output::tree.

### Examples

#### Example 1

The example shows the nested list for the expression  $a + b*2 - d*(a + c)$ :

```
prog::exprlist(a + b*2 - d*(a + c))
```

```
[_plus, a, [_mult, b, 2], [_mult, d, [_plus, a, c], -1]]
```

The return value can be used to create and display a tree:

```
expose(adt::Tree(prog::exprlist(a + b*2 - d*(a + c))))
```

```
_plus  
|  
+-- a  
|
```



## prog::exprtree

Visualize an expression as tree

### Syntax

```
prog::exprtree(ex, <Quiet>)
```

### Description

`prog::exprtree(ex)` visualizes any MuPAD expression `ex` as tree.

Every expression in MuPAD is internally a tree. The operations are the nodes, and the operands are the leafs.

### Examples

#### Example 1

The example shows the structure of the expression  $a + b^2 - d*(a + c)$ :

```
prog::exprtree(a + b*2 - d*(a + c))
```

```
  _plus
  |
+-- a
  |
+-- _mult
  |   |
  |   +-- b
  |   |
  |   `-- 2
  |
  `-- _mult
      |
```

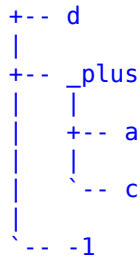

Tree1

Tree1 is the return value of type `adt::Tree`. This object can be exposed on page 1-688 or taken for other operations.

The option `Quiet` suppresses the output, only the tree is returned:

```
prog::exprtree(a + b*2 - d*(a + c), Quiet)
```

Tree2

## Parameters

**ex**

Expression to visualize

## Options

**Quiet**

With this option no output will be printed on screen. The return value of type `adt::Tree` represents the tree structure of `ex`.

## Return Values

Object of type `adt::Tree`

## See Also

### **MuPAD Functions**

`adt::Tree`



# prog::find

Find operands of objects

## Syntax

```
prog::find(obj, piece, <Depth = d>, <Type>)
```

## Description

`prog::find(obj, piece)` returns the position of the object `piece` in the MuPAD object `obj` as list. The list represents a “path” to the given object. With this list and the functions `op` and `subsop`, the object can directly be accessed.

A path to an object `piece` is a list that contains integers `i1, ..., in`.

The meaning is that `piece` is the `in`-th operand of the `(in - 1)`-st operand etc. of the `i1`-st operand of the given object `obj`.

Stated differently, `op(ex, [i1, ..., in]) = opr`.

If the searched object is containing several times, a sequence of lists is returned.

An empty list `[]` as path determines the object `obj` itself.

## Examples

### Example 1

The identifier `a` is the first operand of the expression:

```
prog::find(a + b + c, a)
```

```
[1]
```

The number 1 occurs several times:

```
prog::find(f(1, 1, 1), 1)
```

```
[1], [2], [3]
```

## Example 2

The identifier `a` is the first operand of the second operand of the first operand of the expression:

```
prog::find(b*(a - 1) + b*(x - 1), a)
```

```
[1, 2, 1]
```

The result of `prog::find` can be used to access the element with `op` or replace it with `subsop`:

```
op(b*(a - 1) + b*(x - 1), [1, 2, 1]);  
subsop(b*(a - 1) + b*(x - 1), [1, 2, 1] = A)
```

```
a
```

```
b (A - 1) + b (x - 1)
```

## Example 3

How many calls of `return` does `sin` contain?

```
nops([prog::find(sin, return)])
```

```
59
```

`sin` contains many `return` calls! However, `sin` is a function environment and the slots on page 1-1980 are examined, too. To examine only the main procedure, take the first operand of the function environment:

```
nops(prog::find(op(sin, 1), return))
```

24

## Example 4

prog::find can also find all objects of a given type:

```
nops(prog::find(sin, DOM_PROC, Type))
```

66

To find only the top level procedures, option `Depth` can be used:

```
nops(prog::find(sin, DOM_PROC, Type, Depth = 1))
```

14

## Example 5

prog::find works with tables and other containers, too:

```
T := table(1 = sin(x), 2 = cos(x), 3 = tan(x),
          4 = tan(y), 5 = sin(y), 6 = cos(y)):
prog::find(T, sin)
```

[1, 2, 0], [5, 2, 0]

```
prog::find(T, "cos", Type)
```

[2, 2], [6, 2]

## Example 6

In this example we show how to manipulate an existing function by substitution. We use `subsop` for the substitution and `prog::find` to get the path for the substitution. Here

we replace the  $\wedge$ -function by the function `mypower` which additionally counts the number of its calls:

```
f := x -> `+(x^j $ j = 1 .. random(10)()):
mypower := (b, e) -> (count := count + 1; b^e):
map([prog::find(f, `^`)],
    X -> (f := subsop(f, X = mypower))):
```

After calling the function `f` ten times in a loop, we see the resulting number of calls of  $\wedge$  in `count`:

```
count := 0:
for i from 1 to 10 do f(i); end:
count
```

48

## Parameters

### **obj**

Any MuPAD object

### **piece**

Any MuPAD object

## Options

### **Depth**

Option, specified as `Depth = d`

This option allows examining operands of the given object, that are domains, procedures and function environments, only with recursion depth `d`.

Option `Depth` can be used to find procedures, but not locally defined procedures inside the procedures that were found in the first step.

## Type

When the option `Type` is given, `prog::find` does not search positions `p` in `obj` such that `op(obj, p) = piece`, but rather those with `testtype(op(obj, p), piece) = TRUE`. Cf. “Example 4” on page 27-15 (Symbolic Math Toolbox).

## Return Values

List of numbers that determine the position of the given object inside of the given expression, or a sequence of lists, if the expression contains the object several times

## Algorithms

`prog::find` can be used to examine and manipulate complex MuPAD objects with `subsop`.

## See Also

### MuPAD Functions

`has` | `op` | `prog::expree` | `subsop`

## prog::getname

Name of an object

### Syntax

```
prog::getname(object)
```

### Description

`prog::getname(object)` returns the name of the MuPAD object `object`.

The return value is a string, irrespective of the type of the input.

Names can be extracted from procedures, identifiers, function environments, domains and their methods (and strings, of course). If no name can be extracted from an object, the string "(noname)" is returned.

For all other MuPAD objects the result of `expr2text(object)` is returned as name.

### Examples

#### Example 1

My own name:

```
prog::getname(prog::getname)
```

```
"prog::getname"
```

The name of a Domain:

```
prog::getname(Dom::ExpressionField())
```

```
"Dom::ExpressionField()"
```

The “name” of an arbitrary MuPAD object:

```
prog::getname(1)
```

```
"1"
```

```
prog::getname(a + 2*b)
```

```
"a + 2*b"
```

## Parameters

### **object**

Any MuPAD object

## Return Values

Name as string

## See Also

### **MuPAD Functions**

`expr2text` | `info` | `op` | `print` | `text2expr`

## prog::getOptions

Get and verify options within a procedure

### Syntax

```
prog::getOptions(n, arguments, allOptions, <ErrorOnUnexpected>, <optionTypes>)
```

### Description

`prog::getOptions` called within a procedure collects and verifies all options from the list of arguments of the calling procedure.

When you write your own procedure, `prog::getOptions` lets you embed the collection and verification of all options of the procedure. When a user calls your procedure, `prog::getOptions` scans all the arguments and provides a data structure that contains all option values. See “Example 1” on page 27-21 (Symbolic Math Toolbox).

The `prog::getOptions` function returns a list that contains a table of all valid options along with their values and a list of unexpected arguments. For expected options, `prog::getOptions` returns the following values:

If an option can have only TRUE or FALSE values, a user of your procedure can provide the option name, instead of providing an option-value pair. If a user provides an option without specifying its value, `prog::getOptions` returns the Boolean value TRUE for that option. See “Example 2” on page 27-22 (Symbolic Math Toolbox).

`prog::getOptions` returns a list with two components: a table of expected options and a list of unexpected arguments. You can access the components of that list separately by using the index operator (see `_index`). See “Example 3” on page 27-22 (Symbolic Math Toolbox).

By default, the `prog::getOptions` function does not error when it finds an unexpected argument. To switch to issuing errors on unexpected arguments, use the parameter `ErrorOnUnexpected`. See “Example 4” on page 27-23 (Symbolic Math Toolbox).

The procedure that includes `prog::getOptions` must accept the arguments in the following order: first nonoptional parameters, and then all options. The



`prog::getOptions` function lets you specify the number `n` of the argument from which the function starts verifying options. The `prog::getOptions` function assumes that the first `n - 1` arguments are parameters and, therefore, does not verify them. See “Example 5” on page 27-23 (Symbolic Math Toolbox).

The parameter `optionTypes` lets you specify acceptable types for the option values. You can specify acceptable types for some or all of the expected options provided in the `allOptions` table. See “Example 6” on page 27-24 (Symbolic Math Toolbox).

The first three parameters of `prog::getOptions` (`n`, `arguments`, and `allOptions`) are required. `ErrorOnUnexpected` and `optionTypes` are optional. You must provide the parameters of `prog::getOptions` using the order shown in the Calls section of this page. Therefore, if you want to use the fifth parameter `optionTypes`, you also must explicitly use the fourth parameter `ErrorOnUnexpected`.

The second parameter of the `prog::getOptions` function, `arguments`, is a list of all arguments of your procedure. `prog::getOptions` scans the arguments provided in that list. Although `prog::getOptions` accepts any list as a second argument, the calling procedure always must provide a list of all its arguments (both parameters and options) to avoid potential errors. The syntax `[ args() ]` provides a list of all arguments of the calling procedure. See “Example 7” on page 27-25 (Symbolic Math Toolbox).

## Examples

### Example 1

To embed the option collection and verification step into your procedure, call `prog::getOptions` function within that procedure. To test the behaviour of `prog::getOptions`, create a function `f` that calls `prog::getOptions` to scan and verify the arguments of `f`. For example, create the function `f` that accepts only one option `All`:

```
f := () -> prog::getOptions(1, [args()], table(All = TRUE));
```

`prog::getOptions` returns a list. The first entry of the list is a table containing all expected options and their values. The second entry is a list of unexpected arguments. For example the function call `f()` does not contain any unexpected arguments:

```
f();
```

```
[All|TRUE, []]
```

The function call `f(Unexpected)` contains the unexpected argument `Unexpected`:

```
f(Unexpected);
```

```
[All|TRUE, [Unexpected]]
```

## Example 2

When users call the procedure that includes `prog::getOptions`, they can specify new values for any of the valid options of that procedure. In this case, `prog::getOptions` returns the new values. If a user uses the option without specifying its value, `prog::getOptions` returns the Boolean value `TRUE` for that option. If a user does not explicitly use an expected option, `prog::getOptions` returns the default value of that option provided in the `allOptions` table. For example, in the function call `f(Proc = op, Warning)`, the `prog::getOptions` function returns the following values:

- If a user provides a value for the option, `prog::getOptions` returns that value.
- If a user does not use the option in a procedure call, `prog::getOptions` returns the default value for that option.

```
f := () -> prog::getOptions(1, [args()],  
                           table(All = FALSE,  
                                 Proc = id,  
                                 Warning = FALSE))[1]:  
f(Proc = op, Warning)
```

```
-----  
All | FALSE  
Proc | op  
Warning | TRUE
```

## Example 3

To access the table of expected options and the list of unexpected arguments separately, use the index operator (see `_index`):

```
f := () -> prog::getOptions(1, [args()],
                           table(All = TRUE))[1]:
g := () -> prog::getOptions(1, [args()],
                           table(All = TRUE))[2]:
ExpectedOptions = f(Unexpected);
UnexpectedOptions = g(Unexpected)
```

$$\text{ExpectedOptions} = \overline{\text{All}|\text{TRUE}}$$

$$\text{UnexpectedOptions} = [\text{Unexpected}]$$

## Example 4

When a user supplies unexpected arguments to your procedure, `prog::getOptions` can collect these arguments and return them as a list. Also, `prog::getOptions` can stop and issue an error when it finds the first unexpected argument. To issue an error instead of listing unexpected arguments, use `TRUE` as the fourth parameter of `prog::getOptions`:

```
f := () -> prog::getOptions(1, [args()], table(All = TRUE), TRUE):
f(Unexpected)
```

```
Error: Invalid argument number 1.
Evaluating: f
```

## Example 5

The `prog::getOptions` function does not distinguish parameters from options automatically. If some arguments of a procedure are parameters, exclude them from option verification. Otherwise, the `prog::getOptions` function lists those parameters as unexpected arguments. For example, `prog::getOptions` lists 1 and 2 as unexpected arguments of the function call `f(1, 2, All)`:

```
f := () -> prog::getOptions(1, [args()], table(All = TRUE))[2]:
UnexpectedOptions = f(1, 2, All);
```

$$\text{UnexpectedOptions} = [1, 2]$$

If you set the `prog::getOptions` function to error on unexpected arguments, it will error on the parameters too:

```
f := () -> prog::getOptions(1, [args()], table(All = TRUE), TRUE):  
f(1, 2, All);
```

```
Error: Invalid argument number 1.  
Evaluating: f
```

To exclude first `n` parameters of a function from option verification, provide the number `n + 1` as a first argument of `prog::getOptions`. In a function call, specify all `n` parameters before you specify options. For example, to avoid checking the first two arguments in the function call `f(1, 2, All)`, use the following syntax:

```
f := () -> prog::getOptions(3, [args()], table(All = TRUE))[2]:  
UnexpectedOptions = f(1, 2, All);
```

```
UnexpectedOptions = []
```

When you use `prog::getOptions`, you must provide all nonoptional parameters first, and then provide the options. The following syntax does not work because `prog::getOptions` assumes that the first two arguments in the function call `f(1, All, 2)` are parameters, and the number 2 is an option:

```
f := () -> prog::getOptions(3, [args()], table(All = TRUE), TRUE):  
f(1, All, 2);
```

```
Error: Invalid argument number 3.  
Evaluating: f
```

## Example 6

To specify acceptable types of the option values, use a table that contains acceptable options as indices and their expected types as entries. For example, specify that the `All` option must be of the type `DOM_BOOL`, and the `Proc` option must be of the type `Type::Function`:

```
f:= () -> prog::getOptions(1, [args()],  
                           table(All = TRUE, Proc = id),  
                           TRUE,
```

```

    table(All = DOM_BOOL,
          Proc = Type::Function)
    )[1]:

```

Now, options can have only values of the correct types:

```
f(All = FALSE, Proc = id)
```

All	FALSE
Proc	id

If you try to use a value of the wrong type, the function issues an error:

```
f(All = FALSE, Proc = 0)
```

```

Error: Invalid type of argument number 2.
Evaluating: f

```

Also, you can define and use a procedure for performing the type check. For arguments of the valid type, the procedure must return TRUE or an expression that can be evaluated to TRUE by the `bool` function:

```

f := () -> prog::getOptions(
    2, [args()],
    table(File = ""), TRUE,
    table(File = (X -> contains({DOM_STRING,
                                DOM_INT},
                                type(X))))
    )[1]:
f(FALSE, File = 0), f(TRUE, File = "test.log")

```

File	0	File	"test.log"
------	---	------	------------

## Example 7

Using arguments to separate options from parameters is not recommended because it can lead to errors. Always use the first parameter of `prog::getOptions` to specify how many parameters you have. Although `prog::getOptions` accepts any list as a second argument, the best practice is to use only `args()`. The following example demonstrates that using arguments to separate options from parameters can result in the wrong error

message. Although this error message correctly indicates that one of the options has a value of the wrong type, the index of the argument is wrong:

```
f := () -> prog::getOptions(1, [args(2..args(0))],
                           table(Option1 = TRUE),
                           TRUE,
                           table(Option1 = DOM_BOOL)):
f(x, Option1 = 1, Option2)
```

```
Error: Invalid type of argument number 1.
Evaluating: f
```

To get the correct error message for this example, use the first parameter of `prog::getOptions` to exclude `x` from option verification:

```
f := () -> prog::getOptions(2, [args()], table(Option1 = TRUE),
                           TRUE, table(Option1 = DOM_BOOL)):
f(x, Option1 = 1, Option2)
```

```
Error: Invalid type of argument number 2.
Evaluating: f
```

## Parameters

### **n**

A positive integer that specifies the number of the first option in the list of arguments. When calling the procedure, a user must provide all nonoptional parameters before the options.

### **arguments**

A list of all arguments of the procedure. Use `args()` to access all arguments.

### **allOptions**

A table that contains all acceptable options as indices and their default values as entries: `table(Option = defaultValue)`

## **ErrorOnUnexpected**

A Boolean constant TRUE or FALSE. If the value is TRUE, `prog::getOptions` issues an error when it finds an unexpected argument. If the value is FALSE, `prog::getOptions` collects all unexpected arguments and returns them as a list. By default, `ErrorOnUnexpected = FALSE`.

## **optionTypes**

A table that contains acceptable options as indices and their expected types as entries: `table(Option = optionType)`. Here `optionType` must be a valid second argument of the `testtype` function or a procedure that returns TRUE (or an expression that can be evaluated to TRUE by the `bool` function) for arguments of the valid type. If you want to specify `optionTypes`, you also must explicitly specify `ErrorOnUnexpected`.

## **Return Values**

List that contains a table and a list. The table contains all valid options of the calling procedure and their values. For expected options that are not specified in the procedure, the values are their default values. The list contains all unexpected arguments in the procedure.

## **See Also**

### **MuPAD Functions**

`testtype`

## prog::init

Loading objects

### Syntax

```
prog::init(object)
```

### Description

`prog::init(object)` initializes the MuPAD object `object`.

Almost all MuPAD objects (domains, procedures etc.) are loaded into memory at their first use. This mechanism saves a lot of memory and time while starting MuPAD. Most of the MuPAD objects are not needed in a given session and would only fill up the system.

This strategy is transparent with respect to the usage of MuPAD objects. On slower computers, you may notice a delay on the first use of a function or domain.

Using `Pref::verboseRead`, you can make MuPAD print information on files loaded automatically.

### Examples

#### Example 1

Initializing all objects from any additional MuPAD library increases the memory requirements. For example, you can initialize the object from the `linalg` (Symbolic Math Toolbox) library:

```
bytes()
```

```
522304, 815604, 2147483647
```

```
prog::init(linalg):
```



Check the memory usage again:

```
bytes()
```

```
15990660, 16507016, 2147483647
```

## Example 2

Using `Pref::verboseRead`, we obtain information on what is loaded by the system:

```
reset():
```

```
Pref::verboseRead(2):
```

```
prog::init(prog::trace)
```

```
loading package
```

```
'prog' [lib/] reading file lib/PROG/checkini.mu reading file lib/PROG/trace.mu
```

## Parameters

### object

MuPAD object to initialize or option `All`

## Options

### All

Initializing all MuPAD objects

With this option (instead of some MuPAD object), all MuPAD objects will be initialized.

## Return Values

`prog::init` returns the void object `null()`.

## See Also

### **MuPAD Functions**

Pref::verboseRead | prog::check

# prog::isGlobal

Information about reserved identifiers

## Syntax

```
prog::isGlobal(ident)
```

## Description

`prog::isGlobal(ident)` checks whether the identifier `ident` is “used by the system”. Here, “used by the system” means that `ident` is an environment variable (e.g., `PRETTYPRINT`), a system-wide constant (e.g., `PI` or `undefined`), an option (for some function call, e.g., `All`), or a system function (such as `sin`).

The most of those identifiers are protected (see `protect`).

## Examples

### Example 1

Assume you would like to use some identifiers as options for a new function you wrote. In this example, we will check the elements of the list `[All, Beta, Circle, D, eval, First]` for suitability. (Note that `eval` would not be a good choice, even if it was not a system function, because options should start with a capital letter.)

We define a test function which is mapped on page 1-1321 to the list and returns `FAIL`, if the tested object is not an identifier, `TRUE`, if the identifier is used by the system and `FALSE` otherwise:

```
LIST:= [All, Beta, Circle, D, eval, First]:
map(LIST, X -> if domtype(X) <> DOM_IDENT then
    X = FAIL
  else
    X = prog::isGlobal(X)
  end_if)
```

[All = TRUE, Beta = FALSE, Circle = FALSE, D = FAIL, eval = FAIL, First = TRUE]

The identifiers `All` and `First` can be used as options because they have already been protected by the system (actually, they are already used as options, which makes them a good choice), the identifiers `Beta` and `Circle` are free and one must only take care that they have no value if they will be used as options—they should be protected on page 1-1679 first. `D` and `eval` have values and cannot be used as options.

## Parameters

### `ident`

Identifier to check

## Return Values

`prog::isGlobal` return TRUE, if the given identifier is used by the system, otherwise FALSE.

## See Also

### **MuPAD Functions**

`anames` | `domtype` | `prog::check` | `type`

# prog::ntime

Hardware independent time unit

## Syntax

```
prog::ntime()
```

## Description

`prog::ntime()` returns a time unit that represents roughly the speed of the current machine *for typical library programs*.

`prog::ntime` can be used to perform timing tests of typical MuPAD library programs on different machines.

`prog::ntime` uses a mix of different operations to calculate the time factor.

One call to `prog::ntime` takes about 1.5 seconds.

A real timing value must be divided by the value of `prog::ntime`, to get a machine independent timing value.

## Examples

### Example 1

On this machine, a timing must be divided by the value of `prog::ntime`, then the timing is comparable with the timing of the same code on another machine, also divided by the value of `prog::ntime` on the other machine:

```
prog::ntime()
```

```
0.7052155095
```

## **Return Values**

Floating point number

## **See Also**

### **MuPAD Functions**

`prog::testinit` | `time`

# prog::profile

Display timing data of nested function calls

## Syntax

```
prog::profile(stmt)
```

## Description

`prog::profile(stmt)` evaluates the MuPAD statement `stmt` and displays timing data of all nested function calls, additionally a graph with the calling structure.

`prog::profile` measures and displays the time usage of *library functions*. Kernel functions are not measured. For every function called during the evaluation of `stmt`, `prog::profile` prints the time spent in this function and the number of calls.

`prog::profile` can be helpful in finding time critical functions and unnecessary nested function calls.

`stmt` could be reading a whole test file, too.

A trick to observe also kernel functions is to call `prog::trace` with the kernel function as argument. `prog::trace` takes a library wrapper procedure around the kernel function, that has the same name and can be found in the output of `prog::profile`, when the kernel function is used during the evaluation of `stmt`. The time use of the wrapper function is nearly zero.

The first part of the output is a table with the timing values for each procedure, the second part is a graph, that presents information about the dependences between all measured functions, when `stmt` is evaluated.

The table contains several columns that are described below.

Each row shows all data of one function (called “the function”), that was measured by `prog::profile`. There is one special entry: The first entry is called `procedure entry point`. It shows the sum of all functions and represents the evaluation of `stmt`.

- "percent usage of all"

the time spent in the function with respect to the whole time used for the evaluation of `stmt` (in percent)

- "time self per single call"

the value "time self" divided by the sum of all calls of the function (in milli seconds)

- "time self"

the whole time spent *in the body* of the function, i.e., the sum of all calls, without the time, used by all other measured functions called by the function (in milli seconds)

- "time children per single call"

the value "time children" divided by the sum of all calls of the function (in milli seconds)

- "time children"

the sum of *all time* (self and children) spent in all functions that are called by the function directly

- "calls/normal exit"

number of all calls of the function that leave the function without errors

- "calls/remember exit"

number of all calls of the function that return a remembered value by the kernel remember mechanism on page 1-1654 (and does not call the function body)

- "calls/errors"

number of all calls of the function that leave the function with an error

- ["[index] function name"]

the index of the function (assigned by `prog::profile`) and the name of the function

An index is assigned to each function, in descending order of time usage, to identify and find the function in the call graph that is described now.

The second part of the output of `prog::profile` is a dependence graph. It shows each function, their parents (functions that call the function directly), and their children



(functions that are called from the function directly), together with timing information and the number of calls.

Each part of the graph that is separated by horizontal lines of minus chars, belongs to one function. It contains several columns:

- "index"

the index, assigned unique to the function

- "%time"

the percentage of the function on the whole run time

- "self"

the sum of all times used by the function (in milli seconds)

- "children"

the sum of all times used by the children of the function (in milli seconds)

- "called"

the number of all calls of the function

- ["[index] name"]

the index and the name of the function

There are two kinds of entries: the function that belongs to the part has its index in the first column of the part, and in this column, only their name is printed.

All other functions (parents and children of the function) are only printed in this column with their index and name together, with small indentation for highlighting the function that belongs to the part.

The parents are located above the function itself, all children are written below the line with the function, the part belongs to.

For a more detailed explanation of the lines in a graph part see the first example.

## Examples

### Example 1

We define three functions `f`, `g` and `h`. `prog::profile` displays the time spent in each function and the number of calls to it:

```
f := proc()
  local t;
  begin
    t := time();
    while time() < 10 + t do nothing end_while
  end_proc;
g := proc()
  local t;
  begin
    f();
    t := time();
    while time() < 10 + t do nothing end_while;
    f()
  end_proc;
h := proc() begin g(), f(), g() end_proc;

prog::profile(h()):
```

```

percent usage of all | time self per
single call | | | time self | | | time
children per single call | | | calls/normal exit | | | time children
| | | | | | | calls/remember exit | | | |
| | | | | | | calls/errors | | | | |
| | | | [index] funct. name -----
100.0 | 70.0 | 70.0 | . | . | 1 | . | . | [0] | proc. entry pt.
-----
71.4 | 10.0 | 50.0 | . | . | 5 | . | . | [1] | f | 28.6 | 10.0
20.0 | 20.0 | 40.0 | 2 | . | . | [2] | g | . | . | . | 70.0
70.0 | 1 | . | . | [3] | h | | | | | | |
index | %time | self | children | called | [index] | name -----
[0] | 100.0 | 70 | 0 | 1 | | | proc. entry point
| | | 0 | 70 | 1 | [3] | h -----
| | | 40 | 0 | 4 | [2] | g
| | | 10 | 0 | 1 | [3] | h | [1] | 71.4
50 | 0 | 5 | f -----
```

```

    20      40      2      [3] h [2]
28.6      20      40      2 g
40      0      4 [1] f -----
[3]      0.0      0      70      1 h
    10      0      1 [1] f
20      40      2 [2] g -----
Time sum: 70 ms

```

(The output is shortened slightly, because the page is too small.)

The lines of the table above are described following:

```

percent usage of all | time self per
single call | | time self | | | time
children per single call | | calls/normal exit | | time children
| | | | | calls/remember exit | | |
| | | | | calls/errors | | |
| | | [index] funct. name -----
100.0 70.0 70.0 . . 1 . . [0] proc. entry pt.
-----

```

The whole function call takes 100 percent of the time (certainly), 70.0 milli seconds and is called once (the evaluation of stmt), without an error.

```

71.4 10.0 50.0 . . 5 . .
[1] f

```

Function f takes 71.4 percent of all evaluation time in its body. It uses 10.0 milli seconds per call on the average (in this case exactly), their children (if existing) uses no time measurable (because it has no children), and it is called 5 times and returns without errors. f has the index 1.

```

28.6 10.0 20.0 20.0 40.0 2 . .
[2] g

```

Function g takes 28.6 percent of the whole time that are 20.0 milli seconds, and 10.0 milli seconds on the average per call. Their children uses 20.0 milli seconds pre call on the average and 40.0 total, and g is called twice and returns without errors. g gets the index 2.

```

. . . 70.0 70.0 1 . .
[3] h

```

Function h uses nearly no evaluation time, their children uses 70.0 milli seconds on the average and 70.0 total, and h is called once and finished without errors. h gets the index 3.

The parts of the graph above are described following:

```

index      %time      self  children  called
[index] name -----
  [0]      100.0        70      0          1  proc entry point
                   0       70          1      [3] h -----

```

The whole function call takes 100 percent of the evaluation time (by definition), that are 70.0 milli seconds, and it is called once.

It calls once the function h with index [3] (as argument of prog::profile), and h uses 70.0 milli seconds of the time that are spent in the children of h, not in the body.

```

index      %time      self  children  called
[index] name -----
                   40      0          4      [2] g
          10      0          1      [3] h [1] 71.4
      50          0          5 f -----

```

Function f spends 71.4 percent of the whole evaluation time. It uses 50.0 milli seconds, their children uses no time measurable, and it is called 5 times.

f has two parents and no children.

f is called by its parent g 4 times and by h once.

f spends 40 milli seconds by itself (in its body), when it is called from g (the first line in the part of f), and f spends 10 milli seconds in its body, when it is called from h (the second line).

```

index      %time      self  children  called
[index] name -----
          28.6      20      20      40      2      [3] h [2]
      40          0          4      40      [1] f -----

```

Function g takes 28.6 percent of the whole time, 20 milli seconds in its body, and their children take 40 milli seconds. g is called twice.

g is called from h twice, and spends 20 ms in its body and 40 ms in its children.

g calls the function f four times, and f spend 40 ms in its body, when it is called from g.

```

index      %time      self  children      called
[index] name -----
  [3]      0.0        0      70          1 h
    10        40        0      1          [1] f
20         40        2      [2] g -----

```

Function h takes nearly no evaluation time, their children spends 70.0 milli seconds, and h is called once.

h calls the functions f and g directly, f once and g twice.

f uses 10 ms in its body, when it is called from h, and g uses 20 ms in its body and 40 ms in its children.

## Parameters

**stmt**

A MuPAD statement

## Return Values

Result of stmt

## Algorithms

The timings displayed by `prog::profile` are generated by the kernel.

The evaluation of `stmt` inside `prog::profile` takes partly substantially longer than evaluating `stmt` directly. This extra time does not influence the validity of the timings, i.e., if `prog::profile` reports f taking three times as long as g, then this is also the case when evaluating `stmt` directly.

## See Also

### **MuPAD Functions**

`prog::trace` | `time`

# prog::remember

Extended remember mechanism for procedures

## Syntax

```
prog::remember(f, <depends>, <PreventRecursion, <predef>>)
```

## Description

`prog::remember(f)` returns a modified copy of the procedure `f` that stores previously computed results and additional information in a remember table. When you call `f` with arguments that you already used in previous calls, `f` finds the results in its remember table and returns them immediately.

If you assign `f` to an identifier or a domain slot, you also must assign the copy returned by `prog::remember` to the same identifier or slot, for example, `f := prog::remember(f)`.

`f := prog::remember(f)` remembers results without context information, such as properties or the value of `DIGITS`. The first time you call `f` with any new combination of input parameters, the remember table of `f` stores ``input` -> `f(input)``. After that, when you call `f` with the same input parameters, it takes the result `f(input)` from the remember table instead of recomputing it. See “Example 1” on page 27-45 (Symbolic Math Toolbox).

`f := prog::remember(f, depends)` remembers results and additional context information. The dependency function `depends` lets you specify the context information to store along with computed results in the remember table and verify in each function call. See “Example 2” on page 27-45 (Symbolic Math Toolbox).

Typically, it is useful to store and verify properties of the input and the values of `DIGITS` and `ORDER`. To access properties of the input, use `property::depends`. This dependency function verifies all three values:

```
() -> [property::depends(args()), DIGITS, ORDER]
```

Another common problem is that an overloading function does not register when its overloading slot changes in some other function or domain. This dependency function that uses `slotAssignCounter` lets you avoid this problem:

```
() -> [property::depends, slotAssignCounter("foo")]
```

To combine all three tasks, use this dependency function:

```
() -> [property::depends(args()),  
      DIGITS, ORDER, slotAssignCounter("foo")]
```

The first time you call `f` with any new combination of input parameters, the remember table of `f` stores `[input, depends(input)] -> f(input)`. After that, when you call `f` with the same input parameters, it checks whether `depends(input)` returns the same value as before. If it does, then `f` takes the result `f(input)` from the remember table. Otherwise, it computes `f(input)` and adds the new values `[input, depends(input)] -> f(input)` to the remember table. The only exception to this rule is results computed with different values of `MAXEFFORT`. If in previous calls `f(input)` was computed with lower `MAXEFFORT`, then the new call with higher `MAXEFFORT` is evaluated and remembered results are replaced with the new ones.

If the dependency function is constant or returns the value that does not depend on the input, then the remember mechanism disregards context information.

You can call the modified procedure with the `Remember` option as the first argument, and one of these special options as the second argument:

- `Clear` clears the remember table of the procedure.
- `ClearPrevent` clears the remember table that prevents infinite recursions inside the procedure. For details about preventing infinite recursions, see the description of the `PreventRecursion` option.
- `Print` returns the remember table of the procedure.

For example, the call `f(Remember, Clear)` clears the remember table of `f`. Also see "Example 3" on page 27-47 (Symbolic Math Toolbox).



## Examples

### Example 1

Create this function:

```
f := X -> if X > 1 then f(X - 1)*f(X - 2) - f(X - 2) else 1 end_if:
```

Calling this function is time-consuming because the function calls itself recursively and evaluates every call:

```
f(20), time(f(20))
```

```
0, 3260.204
```

Using the remember mechanism eliminates these reevaluations. To enable the remember mechanism, use `prog::remember`:

```
f := prog::remember(f):
```

```
f(200), time(f(200))
```

```
0, 0.0
```

### Example 2

Create the procedure `pos` that checks if its parameter is positive:

```
pos := proc(x)
begin
  is(x > 0)
end_proc:
```

Enable the remember mechanism for `pos`:

```
pos := prog::remember(pos):
```

`pos` returns UNKNOWN for variable `a`:

```
pos(a)
```

## UNKNOWN

Now use `assume` to specify that variable `a` is positive:

```
assume(a > 0):
```

When you call `pos` for variable `a`, it finds the value of `pos(a)` in the remember table. In this case, the remember table does not store the context information, and therefore does not check for the new assumptions on variable `a`. It returns the remembered result, which is incorrect because of the new assumption:

```
pos(a)
```

## UNKNOWN

Calling `pos` for `a^3` returns the correct result because `pos(a^3)` is not in the remember table yet:

```
pos(a^3)
```

## TRUE

Assume that `a` is negative:

```
assume(a < 0):
```

Now both calls return incorrect values because the results are taken from the remember tables:

```
pos(a), pos(a^3)
```

## UNKNOWN, TRUE

To make the remember mechanism aware of the changes in assumptions, use `prog::remember` with the second argument `property::depends` as the dependency function:

```
unassume(a):  
pos := proc(x)
```

```

    begin
      is(x > 0)
    end_proc:
pos := prog::remember(pos, property::depends):
pos(a)

```

UNKNOWN

Now pos reacts properly to the new assumption:

```

assume(a > 0):
pos(a)

```

TRUE

pos also returns the correct result after you clear the assumption:

```

unassume(a):
pos(a)

```

UNKNOWN

### Example 3

Create the procedure pos and enable the remember mechanism for it:

```

pos := proc(x)
  begin
    is(x > 0)
  end_proc:
pos := prog::remember(pos, getprop):

```

Call pos for these parameters:

```

pos(a):
assume(b > a, _and):
pos(b):

```

After you call the procedure at least once, it creates the remember table. To see the remember table of a procedure, use the special option `Print`. The value  $10^6$  in the second column is the value of `MAXEFFORT` used during computations.

```
pos(Remember, Print)
```

$[\text{pos}(a), [\mathbf{C}, 0]]$	$[\text{UNKNOWN}, 1000000.0]$
$[\text{pos}(b), [(a, \infty), 0]]$	$[\text{UNKNOWN}, 1000000.0]$

To clear the remember table of a procedure and thus force the function to reevaluate all results, use the special option `Clear`:

```
pos(Remember, Clear):  
pos(b)
```

UNKNOWN

## Example 4

Create the procedure `deps` that collects all operands of the properties of a given expression, including the identifiers of assumed properties:

```
deps := proc(x)  
begin  
  if domtype(x) <> DOM_IDENT then  
    op(map(indets(x), deps))  
  else  
    x, deps(getprop(x))  
  end_if  
end_proc:
```

Set the following assumption. Note that now `deps` contains potentially infinite recursions because the property of `x` refers to `y`, and the property of `y` refers back to `x`:

```
assume(x > y):
```

```
deps(x)
```

Error: Recursive definition [See ?MAXDEPTH]

To prevent infinite recursions, use `prog::remember` with the `PreventRecursion` option:

```
deps := prog::remember(deps, PreventRecursion):  
deps(x)
```

$x, y, x$ 

To simplify the return value of `deps`, rewrite the function so that it returns a set of all identifiers:

```
deps := proc(x)
begin
  if domtype(x) <> DOM_IDENT then
    _union(op(map(indets(x), deps)))
  else
    {x} union deps(getprop(x))
  end_if
end_proc:
deps := prog::remember(deps, PreventRecursion):
deps(x)
```

 $\{x, y\} \cup x$ 

Now `deps` expects the return value to be a set. By default, when recursion is detected, the procedure returns the value of its input (which is not a set in this example). When preventing recursion in a procedure where the type of the input differs from the type of the return value, specify the value `predef` that the procedure returns when recursion is detected:

```
deps := proc(x)
begin
  if domtype(x) <> DOM_IDENT then
    _union(op(map(indets(x), deps)))
  else
    {x} union deps(getprop(x))
  end_if
end_proc:
deps := prog::remember(deps, PreventRecursion, () -> {args()}):
```

Here `predef` returns a set with the input as an operand:

```
deps(x)
```

 $\{x, y\}$

## Parameters

**f**

A procedure or function environment

**depends**

A procedure or expression

**predef**

A procedure or expression

## Options

### PreventRecursion

With this option, the procedure returned by `prog::remember` uses remembered information to prevent infinite recursion inside the procedure.

`f := prog::remember(f, PreventRecursion, predef )` stores the input parameters only during the function call. This approach lets you avoid reevaluating the same function call when the function calls itself recursively. Instead, it returns the input (by default) or the result of the call `predef(input)` (if you specify `predef`). If returning the input is not an appropriate result for the function call (for example, if the return value of `f` and the input are of different types), then you must specify the value `predef`. See “Example 4” on page 27-48 (Symbolic Math Toolbox).

At the end of the function call, all remembered values are discarded. If you call the function with the same input parameters again, the function call is evaluated with the same costs as before.

You can prevent recursion inside the function call and simultaneously use the remember mechanism outside the function call by using this syntax: `f := prog::remember(f, depends, PreventRecursion, predef )`. If you want to use the remember mechanism with the context information, specify the dependency function `depends` as usual. If you want to use the remember mechanism without the context information and prevent recursions inside a procedure, specify `depends` as a constant (or any function whose return value does not depend on the input). Note that if you omit the `depends`

function and just use the syntax `f := prog::remember(f, PreventRecursion, predef )`, then the remember mechanism does not work outside the function call. In this case, you only prevent recursions.

## Return Values

Modified procedure or function environment

## See Also

### MuPAD Functions

`proc` | `property::depends` | `slotAssignCounter`

## Topics

“Remember Mechanism” (Symbolic Math Toolbox)

## prog::sort

Sort objects by an index function

### Syntax

```
prog::sort(list, func, <Reverse>, <p1, p2, ...>)
```

### Description

`prog::sort(list, func)` applies the function `func` to any object of the list `list` and returns a list with the given objects sorted by the order of the indices calculated by `func`.

`func` is applied only once to any object in `list`.

If optional arguments are present, then the indices are computed from the objects `x` of `list` by `f(x, p1, p2, ...)`.

An alternative call to `prog::sort` is the call `sort(list, (X, Y) -> func(X) <= func(Y))`.

### Examples

#### Example 1

Sort a list of expressions by their length:

```
prog::sort([2*x, x - 4, sin(x), x + y + z], length)
```

```
[sin(x), 2 x, x + y + z, x - 4]
```

Sort a list of lists by the number of operands, with descending order:

```
prog::sort([[1,2,3],[4,2],[0 $ 10],[ ]], nops, Reverse)
```



```
[[0, 0, 0, 0, 0, 0, 0, 0, 0, 0], [1, 2, 3], [4, 2], []]
```

## Parameters

### **list**

A list of MuPAD objects

### **func**

A function that must return a numerical value, when applied to any object of the list

### **Reverse**

An option

### **p1, p2, ...**

Any MuPAD objects accepted by `func` as additional parameters

## Options

### **Reverse**

`prog::sort` compares the calculated indices in reverse order.

## Return Values

List with the same objects as the given list

## See Also

### **MuPAD Functions**

`sort` | `stringlib::order` | `sysorder`

## prog::tcov

Report on test coverage (passed program lines)

### Syntax

```
prog::tcov(Reset)
```

```
prog::tcov(<stmt>, Write = fname)
```

```
prog::tcov(Append = fname)
```

```
prog::tcov(<stmt>, Info, <Summary>, <Lines>, <Hidden>, <Unused>, <All>)
```

```
prog::tcov(<stmt>, Annotate, <Path = pname>, <Comment = comment>)
```

```
prog::tcov(<stmt>, Export = fname, <Annotate>, <Path = pname>, <Comment = comment>, <G
```

### Description

`prog::tcov` inspects the data on the statements executed in library code. MuPAD collects these data if you start the MuPAD engine with the option `-t`. To set different options for starting the MuPAD engine, use the **Arguments** field in the Engine dialog (Symbolic Math Toolbox).

You can use `prog::tcov` in two different modes:

- With a given first argument `stmt`, `prog::tcov` resets all tcov information, evaluates on page 1-242 (Symbolic Math Toolbox) the statement, and shows all debug node passes for this statement during the evaluation. `prog::tcov(stmt)` clears all information about the debug node passes of current session.
- Without the first argument `stmt`, `prog::tcov` shows the debug node pass information collected by the MuPAD engine during the whole session.

You can display the logged debug node passes on the screen or export the data to an HTML file. You also can save the data about the debug node passes to a file, which enables you to read or recover a whole session state later.

prog::tcov can produce annotated source files containing the information collected by prog::tcov and the MuPAD source code.

## Environment Interactions

prog::tcov can produce screen outputs.

If you use the Annotate option, prog::tcov creates new files. For some operating systems creating new files might require special permissions.

## Examples

### Example 1

To use prog::tcov, start the kernel in tcov mode with option -t.

The outputs in the following examples are cropped in this documentation.

The following example shows a short procedure created and called inside prog::tcov. The line numbers correspond to the ones in the Debugger:

```
f:=                // 1
proc(a, b)         // 2
begin              // 3
  if a > b then    // 4
    return(a)      // 5
  else             // 6
    return(f(b, a)) // 7
  end_if          // 8
end_proc:          // 9
```

prog::tcov returns all the lines passed during the evaluation of f:

```
prog::tcov(f(2, 1), Info, Lines)
```

```
File: /tmp/debug0.5932 Use index: 50%
Nodes: 2/4 (0 hidden) Passes: 2      Line      4,0:
1 pass      Line      5,0:      1 pass
```

```
prog::tcov(f(1, 2), Info, Lines)
```

```

File: /tmp/debug0.5932 Use index: 75%      Nodes:
3/4 (0 hidden)  Passes: 4      Line      4,0:  2 passes
      Line      5,0:  1 pass      Line      7,0:  1
pass

```

## Example 2

The following example shows the logging of passes during a session. Before running this example, define the function `f` from “Example 1” on page 27-55 (Symbolic Math Toolbox).

If you start the kernel with the option `-v`, the expose on page 1-688 command shows the debug nodes with pass information.

`prog::tcov(Reset)` resets all `tcov` information:

```

prog::tcov(Reset):
prog::tcov(Info)

```

```

SUMMARY  Files
: 1 in 1 libraries  Nodes      : 0/4 (0 hidden)  Use index : 0%
Passes    : 0 (~ 0.00 passes per all nodes)

```

If you call the function `f` twice, the number of passes doubles:

```

f(1, 2): f(1, 4): prog::tcov(Info)

```

```

File: /tmp/debug0.5932 Use index: 75%
Nodes: 3/4 (0 hidden)  Passes: 8      Line      4,0:
4 passes      Line      5,0:  2 passes      Line
7,0:  2 passes

```

To see the passes, expose on page 1-688 the function `f`:

```

expose(f)

```

```

proc(a, b)    name f;  begin      // /tmp/debug0.5932:4,0 [4 passes];
  if b < a then      // /tmp/debug0.5932:5,0 [2 passes];
    return(a)      else      // /tmp/debug0.5932:7,0 [2 passes];
    return(f(b, a))  end_if;   // /tmp/debug0.5932:9,0 [0 passes]
end_proc

```

You can write the `tcov` data to a data file:

```

prog::tcov(Write = "tcov_example.dat"):

```

To delete the information about the previous passes, use the Reset option:

```
prog::tcov(Reset):
prog::tcov(Info)
```

```
SUMMARY  Files
: 1 in 1 libraries  Nodes      : 0/4 (0 hidden)  Use index : 0%
Passes    : 0 (~ 0.00 passes per all nodes)
```

To retrieve the former state, use the Append option:

```
prog::tcov(Append = "tcov_example.dat"):
prog::tcov(Info, Summary)
```

```
SUMMARY
Files      : 1 in 1 libraries  Nodes      : 3/4 (0 hidden)  Use
index : 75%  Passes      : 8 (~ 2.00 passes per all nodes)
```

Also, you can use the Append option to add the passes:

```
prog::tcov(Append = "tcov_example.dat"):
prog::tcov(Info, Summary)
```

```
SUMMARY
Files      : 1 in 1 libraries  Nodes      : 3/4 (0 hidden)  Use
index : 75%  Passes      : 16 (~ 4.00 passes per all nodes)
```

### Example 3

The following example presents incomplete pieces of code. Note that you cannot execute this example without additional code lines.

Suppose, you have a source file with the following function:

```
1: f := proc(a, b)
2:   begin
3:     if a > b then
4:       return(a)
5:     elif a = b then return(0)
6:     else
7:       f(b, a)
8:     end_if
9:   end_proc:
```

Before executing this source file, read the commands. After reading commands, all the objects defined in the source file are available in the notebook. Calling the function `f` several times and creating the annotated source file, you get:

```
ff(2, 1): // passing lines 3 and 4
f(1, 1): // passing lines 3 and 5 twice
        // because line 5 has two debug nodes
f(1, 2): // passing lines 3, 5, and 7 and
        // recursively 3 and 4, leave via line 9
        // because the statement in line 7 has no return
prog::tcov(Annotate)
```

The annotated source file uses the same path as the source file and looks like this:

```
// Generated by prog::tcov session

1: f := proc(a, b)
2:   begin
3:4   if a > b then
4:2     return(a)
5:2   elif a = b then return(
5:1                                     0)
6:   else
7:1     f(b, a)
8:   end_if
9:1   end_proc:
```

Note that the line 5 contains two debug nodes and appears in two lines. The line splits where the second debug node starts.

For better readability of the annotated source files, use the HTML export.

## Parameters

### **stmt**

Any MuPAD statement or MuPAD expression

### **fname**

A file name given as a string

**pname**

A directory name given as a string

**comment**

Any string

## Options

**Reset**

Reset the number of passes at each debug node to 0.

**Write**

Option, specified as `Write = fname`

This option allows you to write the information about all debug node passes of the current session to the file `fname`. You can use this file for external analysis (see the Algorithms section) or to recover or merge the information collected by `prog::tcov` (see the Append option).

**Append**

Option, specified as `Append = fname`

Append all information about debug node passes from the file `fname` to the current session.

This option allows you to merge the data generated during several sessions.

**Info**

Display the information about debug node passes.

**Summary**

Display only a short summary.

**Lines**

Display each pass through a debug node.

**Unused**

Display all code lines with debug nodes, including unpassed ones.

**Hidden**

This option allows you to display the hidden debug nodes. A hidden debug node is a node in a procedure with the noDebug on page 1-1654 option.

**ALL**

Display unpassed and hidden debug nodes.

**Export**

Option, specified as `Export = fname`

This option allows you to display the debug node passes information in summary for all read source files and for all individual source files.

The information is ordered according to the names of the directories containing the source files. Directory names can be folded.

You can see the list of all the files of a library below each library name.

Each file name presents a link that points to the annotated source file.

You can select graphical indices. Each point leads to the related line in the annotated source file.

**Annotate**

This option allows you to rewrite each executed MuPAD source file `filename.mu` as `filename.tcov` with an annotation at the beginning of each line. The annotation contains the line number of a debug node and the number of passes of this line, followed by the source code.

In text mode the line containing several debug nodes splits so that each line contains one debug node (see "Example 3" on page 27-57 (Symbolic Math Toolbox)).



The new files have the extension '.tcov' instead of '.mu'. See also option `Path`.

If this option is used together with `Export`, `prog::tcov` creates the annotated source files as HTML files with the extension `.tcov.html`. The line colors depend on the passes.

### **Path**

Option, specified as `Path = pname`

This option allows you to specify a path `pname` to the annotated source files and the exported status file. If you do not specify the path, `prog::tcov` creates the files in the same directory where the source files are.

### **Comment**

Option, specified as `Comment = comment`

This option allows you to write the string `comment` on the first line of each annotated source file (see the option `Annotate`) or in the header of an exported HTML file (see the option `Export`).

### **Graphical**

Show a graphical index for each source file in an HTML export file.

## **Return Values**

`prog::tcov` returns the void object `null()` of type `DOM_NULL`.

## **Algorithms**

To be able to use the `prog::tcov` function, start the MuPAD engine with option `-t`. Use the *Arguments* field in the Engine dialog (Symbolic Math Toolbox) to set this option.

If you start the kernel using both options `-v` and `-t`, the function `expose` on page 1-688 shows information about the debug node and passes (see “Example 2” on page 27-56 (Symbolic Math Toolbox)).

The functionality of `prog::tcov` depends on the internal debugger. For details, see the help page for the `debug` command.

Some special considerations:

- If the MuPAD library is read from a tar archive (file `lib.tar`), `prog::tcov` excludes from inspection all the files from this archive. The output of `prog::tcov` also includes the call of `prog::tcov` itself and some other MuPAD utility function passes.
- `prog::tcov` counts only the lines containing a “debug node” on page 1-486.

When called with the option `Write` or the option `Append`, `prog::tcov` creates a data file using the following format: `"filename":fileindex:`. For each read MuPAD source file, "filename" is the name of the source file and fileindex is a numerical index. For temporary files, the index is negative:

- `-1:-1:`

The colon separates the first and the second parts:

- `fileindex:line:column:hidden:passes:unused:`

For each debug node, fileindex corresponds to the first part, line and column determine the start of the debug node in the source file, hidden is 1 for hidden nodes, otherwise 0, passes is the number of passes, unused is an empty and currently unused string.

## See Also

### MuPAD Functions

`debug` | `expose` | `prog::check` | `prog::profile` | `prog::trace`

## prog::test

Automatic comparing of calculation results

### Syntax

```
prog::test(stmt, res | TrapError = errnr, <Timeout = sec>, <message>, options)
prog::test(stmt)
```

### Description

`prog::test` works in two different modes: interactive and inside of test files.

In interactive mode a single call of `prog::test` can be used to compare two MuPAD statements.

The call `prog::test(stmt, res)` evaluates on page 1-242 (Symbolic Math Toolbox) both arguments `stmt` and `res`. When the evaluation leads to exactly the same MuPAD object and no Enhancement was requested, nothing is printed and `prog::test` returns the void object `null()`.

If the results are different, the test fails and a message is printed.

The additional arguments are described in the following part for using `prog::test` in test files.

Another mode is using `prog::test` inside of test files. A test file must start with `prog::testinit`. This function initializes the test file. Then you can write several tests using `prog::test`. The last statement in a test file must be `prog::testexit()`. You also can specify the name of the tested procedure by using `print(Unquoted, "testname")` after `prog::testinit`. This name does not affect the tested procedure itself. It only appears in the test reports generated by your test script.

The tests can be arbitrary MuPAD statements and `prog::test` statements. However, most of the functionality should be executed as argument of `prog::test`. Only initialization of variables should be performed outside of `prog::test` statements in a

test file, because `prog::test` traps every error (with the function `traperror`) and prints a specific error message.

---

**Note** If an error occurs outside of `prog::test`, reading of the test file is interrupted.

---

If no error occurs (as should be the default case), the results are compared and a message is printed, if they are different.

Timing information can be collected and compared that consider only the evaluation time of the first argument `stmt` of `prog::test` (see `prog::testinit`).

If a test fails, for example, the two first arguments of `prog::test` lead to different MuPAD objects, or if an enhancement request was given, `prog::test` prints a message. This message lists the following pieces of information:

- 1** The first line starts with the `Error in test` string and contains the name and a sequence number of the individual test.
- 2** The next three lines contain the input, the expected result, and the result actually observed.
- 3** For each of the options `Priority`, `Enhancement`, `Message`, `Developers`, and `BugId`, if the option has been set, a corresponding line will be printed. Note that `Message` can be set by simply providing a message string.

This information is followed by an empty blank line.

If only one argument is given, the argument is evaluated and compared with `TRUE`, i.e., `prog::test(ex)` is equivalent to `prog::test(ex, TRUE)`.

When a test is initialized with `prog::testinit` and ended by `prog::testexit`, a short message is printed with the following format:

```
Info: 20 test, 1 error, runtime factor 1.7 (expected 2.0)
```

The message contains the number of all tests performed (20), the number of errors (1), and two time factors: The first time factor is the based on the actual time of the test and the second time factor is the expected value given by `prog::testinit`.

# Examples

## Example 1

prog::test can be called interactively:

```
prog::test(1 + 1, 2):  
prog::test(is(2 > 1)):  
prog::test(sin(PI), 0, "check sin"):
```

These tests checked all right. In the next tests wrong results are tested against, to demonstrate the messages given by prog::test:

```
prog::test(1 + 2, 2):
```

```
Error in test 4
```

```
Input: 1 + 2
```

```
Expected: 2
```

```
Got:      3
```

```
Near line: 1
```

```
prog::test(is(x > 1)):
```

```
Error in test 5
```

```
Input: is(1 < x)
```

```
Expected: TRUE
```

```
Got:      UNKNOWN
```

```
Near line: 1
```

```
prog::test(sin(PI), PI, "check sin"):
```

```
Error in test 6
```

```
Input: sin(PI)
```

```
Expected: PI
```

```
Got:          0
Message: check sin
Near line: 1
```

## Example 2

A test file must contain calls to `prog::testinit` and `prog::testexit`. In the following file, we test a function defined in the same file, which is rather uncommon, obviously.

```
// test file "test.tst"
test:= (a, b) -> a^2 + 2*b^2 - a*b:
prog::testinit("test", 0.1):
print(Unquoted, "testname"):
prog::test(test(1, 4), 29, Message = "my first example"):
prog::test(test(3, -2), 24, "the second example"):
prog::test(error("test"), TrapError = 1028):
prog::testexit():
```

The first statement is only a comment. The second line contains an initialization of a test procedure called `test`. Then the test is initialized with `prog::testinit`.

After that three tests are performed: The first test is right, the second expected result is wrong, and the third test produces an error, but the expected result is this error, the error number returned by `traperror` is 1028 (user call of error).

The whole test takes nearly no time:

```
read("test.tst")
Info: memory limit is 256 MB
Error in test 2
Input: test(3, -2)
Expected: 24
Got:          23
Message: the second example
Near line: 4
```

```
Info: time used outside of 'prog::test' takes 100%
Info: 3 tests, 1 error, runtime factor 0.0 (expected 0.1)
Info: CPU time: 1.1 s
Info: Memory allocation 9026800 bytes [prog::testexit]
```

### Example 3

Most of the options accepted by `prog::test` are more or less directly placed in the output:

```
prog::test(1+1, 1, Baseline, Message(2)="well ...",
  Priority=Low, BugId="123-456")
Baseline Error in test 7
Input: 1 + 1
Expected: 1
Got:      2
Priority: Low
Message: well ...
BugId: 123-456
Near line: 2
```

### Example 4

To test that a certain call does not take longer than a specified number of seconds, use the option `Timeout`:

```
prog::test(prog::wait(5.0), null(), Timeout = 2)
```

### Example 5

In most cases, the actual and the expected result are simply compared for equality. Sometimes, however, this is not desirable, especially for floating-point results:

```
prog::test(float(PI), 3.1415926535897932385)
```

```
Error in test 8
```

```
Input: float(PI)
```

```
Expected: 3.141592654
```

```
Got:      3.141592654
```

```
Near line: 1
```

The problem here is that there are many floating-point values which are not identical, yet are displayed as such (unless you increase DIGITS far enough to see the difference). Using the option `Method`, you can provide a function to compare the values:

```
prog::test(float(PI), 3.1415926535897932385, Method = `~=`)
```

## Example 6

When implementing symbolic algorithms, there are often multiple correct and acceptable answers. In some cases, getting any of a certain set of solutions is fine. In these cases, using `Method = _in` is a reasonable way of writing tests (`_in` is the functional form of the `in` operator):

```
prog::test(int(ln(ln(a*x)^(1/2))), x),
  {
    x*ln(ln(a*x)^(1/2)) - Li(a*x)/(2*a),
    x*ln(ln(a*x))/2 - Li(a*x)/(2*a)
  },
  Method = _in,
  Timeout = 20)
```

Sometimes, however, while multiple results are acceptable, you are actually targeting for one particular output. For these cases, you can use `Enhancement` to set the golden goal:

```
prog::test((x^2+2*x+1)/(x+1),
  (x^2+2*x+1)/(x+1),
  Enhancement = x+1)
```

```
Enhancement request: 11
```

```
Input: (x^2 + 2*x + 1)/(x + 1)
```



Got:  $(x^2 + 2x + 1)/(x + 1)$

Requested:  $x + 1$

Near line: 3

If the enhancement request ever is fulfilled, the output changes:

```
prog::test(normal((x^2+2*x+1)/(x+1)),  
            (x^2+2*x+1)/(x+1),  
            Enhancement = x+1)
```

Enhancement done: 12

Input:  $\text{normal}((x^2 + 2x + 1)/(x + 1))$

Got:  $x + 1$

Requested:  $x + 1$

Near line: 3

Note that a test with an enhancement request is, first and foremost, still an ordinary test and behaves as such:

```
prog::test((x^2+x+1)/(x+1),  
            (x^2+2*x+1)/(x+1),  
            Enhancement = x+1)
```

Error in test 13

Input:  $(x^2 + x + 1)/(x + 1)$

Expected:  $(x^2 + 2x + 1)/(x + 1)$

Got:  $(x^2 + x + 1)/(x + 1)$

Near line: 3

## Parameters

### **stmt**

A MuPAD statement to test

### **res**

A MuPAD expression or statement that determines the expected result.

### **message**

A message (a string on page 7-53) that is displayed if the test fails - see option **Message** below

## Options

### **TrapError**

Option, specified as `TrapError = errnr`

Expect the test to throw an error. `errnr` must be the integer expected from the call `traperror(stmt)` or a list of an integer and a string, as returned by `getlasterror()`.

### **Method**

Option, specified as `Method = comp`

A method used to compare the actual and the expected result. Will be called with both expressions and must return `TRUE` or `FALSE`.

### **Timeout**

Option, specified as `Timeout = sec`

A timeout for the evaluation of the tests. Both the actual and the expected result are evaluated with this time limit. If the computation takes too long, `prog::test` behaves as if the command had resulted in a timeout error (error number 1320).

**Message**

Option, specified as `Message = message` or `Message(res1) = message`

Append a message (a string on page 7-53) to the output of `prog::test`. If `res1` is given, the message is given if the result of evaluating `stmt` is `res1`.

**Baseline**

Mark this test as failing in some sort of “baseline,” to differentiate new bugs (stemming from new code developments, regression failures) from bugs already present in some specific earlier version. This affects the output of `prog::test`.

**Enhancement**

Option, specified as `Enhancement = res1`

Request some other output than the one currently tested for. Semantically, a call of the form `prog::test(inp, out, Enhancement = out2)` means “check that the call `inp` results in the same thing as the call `out`, but note that we'd actually prefer to see `out2`.”

**ExpectedWarnings**

Option, specified as `ExpectedWarnings = list`

Gives a list of warnings the call should emit, as strings. Not emitting these warnings, or additional ones, is considered an error.

**High, Low, Medium, Priority**

Option, specified as `Priority = Low | Medium | High`

Denote the importance of this test. This will usually be a very subjective question and affects the output of `prog::test` only, to allow tools parsing the output displaying the problems of higher priority more prominently.

**Developers**

Option, specified as `Developers = devnames`

A string included in the output of `prog::test`, denoting the developers deemed responsible for the code tested. This is intended for post-processing tools.

**BugId**

Option, specified as `BugId = bugid`

Again, for the output of `prog::test`, include a reference to some bug tracking system. `bugid` can be any MuPAD object.

**Return Values**

`prog::test` returns the void object `null()`.

**See Also****MuPAD Functions**

`prog::testexit` | `prog::testinit` | `traperror`

# prog::testexit

Closing tests

## Syntax

```
prog::testexit()
```

## Description

prog::testexit closes automatic tests from test files and prints a short statistic about the test (see prog::test).

prog::testexit closes the last opened protocol file.

---

**Note** prog::testexit must be called before beginning of a new test with prog::testinit.

---

## Return Values

prog::testexit returns the void object null() and closes the last opened protocol file.

## See Also

### MuPAD Functions

prog::test | prog::testinit

## prog::testinit

Initialize tests

### Syntax

```
prog::testinit()
```

```
prog::testinit(string)
```

```
prog::testinit(expected_time, <All>)
```

```
prog::testinit(string, expected_time, <All>)
```

```
prog::testinit(arch = expected_time, ..., <All>)
```

```
prog::testinit(string, arch = expected_time, ..., <All>)
```

### Description

The function `prog::testinit` initializes automatic tests (see `prog::test`).

The second argument `expected_time` determines the time, that the test should need.

---

**Note** This time is not the real time, but a time factor that is given by `prog::testexit` at the end of a complete test.

---

This time factor is computed to be independent of the real speed of the used machine.

In general (without option `All`) the base for the time factor is the sum of all times on page 1-810 (Symbolic Math Toolbox) for the evaluation of the first arguments of each call of `prog::test`.

The time factor can be useful to detect differences of the run time of tests, e.g., when the system or programs where changed.

For tests which run time depends on the architecture of the computer, the expected test time factor can be given apart for each test system as equation `arch = time_factor`.

The string `arch` must be one of the results returned by the function `sysname`.  
`time_factor` is the time factor given by `prog::testexit` at the end of the complete test on the reference system.

## Examples

### Example 1

Initialize a test that should need a run time factor of 2.0:

```
prog::testinit("test1", 2.0):
```

Initialize a test that should need a run time factor of 2.8, where the time is measured between `prog::testinit` and `prog::testexit`:

```
prog::testinit("test2", 2.8, All):
```

Initialize a test that should need a run time factor of 12.0 on Linux and 15.5 on Windows:

```
prog::testinit("test3", "glnxa64" = 12.0, "win32" = 15.5):
```

## Parameters

### **string**

String: a test name

### **expected\_time**

Expected test time factor (see below) in seconds as floating point number

### **arch**

The computer architecture name as string (see `sysname`)

## Options

### All

The base for the time factor is the whole time between the command `prog::testinit` and `prog::testexit`.

## Return Values

`prog::testinit` returns the void object `null()`.

## See Also

### MuPAD Functions

`prog::test` | `prog::testexit`



# prog::trace

Observe functions

## Syntax

```
prog::trace(obj, <Recursive = FALSE>)  
prog::trace({obj1, obj2, ...}, <Recursive = FALSE>)  
prog::trace(options)
```

## Description

`prog::trace(obj)` manipulates the MuPAD object `obj` to observe entering and exiting this object.

---

**Note** `prog::trace` has a new syntax and a new set of options. The old syntax has been removed.

---

`prog::trace` lets you observe functions, domains, domain methods, and function environments. Use the `prog::trace` function for debugging. See “Example 1” on page 24-71 (Symbolic Math Toolbox).

`prog::trace` lets you specify a set of functions, domains, methods, or function environments that you want to observe. See “Example 2” on page 27-79 (Symbolic Math Toolbox).

`prog::trace` lets you observe the relations between calls to the traced objects.

To trace the object `obj`, use the function call `prog::trace(obj)`. After that call, every time the function call enters or exits the object `obj`, MuPAD prints a message and returns the arguments and the return value of that call. See “Example 3” on page 27-80 (Symbolic Math Toolbox).

`prog::trace` lets you observe a domain on page 7-8 or a function environment on page 7-25. When you call the `prog::trace` function for a domain, the function observes all

methods of the domain. When you call `prog::trace` for a function environment, it observes all slots of the function environment. To trace only particular methods (slots), provide a set of these methods (slots). See the `slot` help page for more details. See “Example 8” on page 27-84 (Symbolic Math Toolbox).

To prevent tracing of all slots of a function environment, set the value of the `Recursive` option to `FALSE`. See “Example 7” on page 27-83 (Symbolic Math Toolbox).

The function `prog::unttrace(obj)` terminates tracing of an object `obj`. Here `obj` is a function, a set of functions, a domain, a domain method, or a function environment. The function `prog::traced` detects whether the system currently traces a particular object.

## Examples

### Example 1

Define a function `f`, and observe this function:

```
f := x -> if x > 0 then x else -f(-x) end:  
prog::trace(f):  
f(-2)
```

```
enter f(-2)  
  enter f(2)  
  computed 2  
computed -2
```

-2

Change the function, and reassign the new function to `f`. Although you use the same function name (`f`), MuPAD does not trace the new function:

```
f := x -> if x > 0 then x else f(-x) end:  
f(-2)
```

2

To trace the new function, call `prog::trace` again. Now, the trace mechanism observes the updated function:

```
prog::trace(f):  
f(-2)  
  
enter f(-2)  
  enter f(2)  
  computed 2  
computed 2
```

2

For further computations, stop observation of the function:

```
prog::untrace(f)
```

## Example 2

If you want to trace more than one function, use a set to specify these functions in one function call:

```
prog::trace({sin, cos, exp}):  
sin(5*PI/2);  
cos(5*PI);  
exp(5)  
  
enter sin((5*PI)/2)  
  enter sin(PI/2)  
  remembered 1  
computed 1
```

1

```
enter cos(5*PI)  
  enter cos(PI)  
  remembered -1  
computed -1
```

-1

```
enter exp(5)
computed exp(5)
```

$e^5$

To stop observation of all functions, use `prog::untrace` without arguments:

```
prog::untrace()
```

### Example 3

Define a short function that calls itself recursively, and observe the calls:

```
fib:= proc(n)
  begin
    if n < 2 then
      n
    else
      fib(n - 1) + fib(n - 2)
    end_if
  end_proc:
prog::trace(fib):
fib(3)
```

```
enter fib(3)
  enter fib(2)
    enter fib(1)
      computed 1
    enter fib(0)
      computed 0
    computed 1
  enter fib(1)
    computed 1
  computed 2
```

2

To limit the number of the nested function calls displayed by `prog::trace`, use the `Depth` option. To specify the value of `Depth`, use a separate `prog::trace` function call:

```
prog::trace(fib):
prog::trace(Depth = 2);
fib(12)
```

```
enter fib(12)
  enter fib(11)
    computed 89
  enter fib(10)
    computed 55
  computed 144
```

144

The Depth option is independent of the fib procedure. Now, if you use prog::trace to trace any other procedure, prog::trace displays the nested calls to that procedure using Depth = 2. Remove this global option for further computations:

```
prog::untrace(fib):
prog::trace(Depth = 0)
```

## Example 4

To display memory usage, use the Mem option:

```
prog::trace(Mem):
prog::trace(sin):
sin(3/2*PI)

enter
remember::sin((3*PI)/2) [mem: 3267052]   enter remember::sin(PI/2)
[mem: 4033596]   remembered 1 [mem: 4033436] computed -1 [mem: 4033072]
-1
```

The Mem option is independent of the traced procedure. Now, if you use prog::trace to trace any other procedure, prog::trace displays memory usage in every step of that procedure. Remove this global option for further computations:

```
prog::untrace(sin):
prog::trace(Mem = FALSE)
```

## Example 5

The NoArgs option suppresses the output of arguments of traced objects:

```
prog::trace(linalg):
prog::trace(NoArgs);
linalg::eigenvalues(matrix([[1, 0, 0],
                           [0, -1, 2],
                           [0, 1, 1]]))

enter linalg::eigenvalues
  enter linalg::checkForFloats
  return
  enter linalg::charpoly
    enter linalg::charpolyBerkowitz
    return
  return
return
```

$\{1, \sqrt{3}, -\sqrt{3}\}$

The NoArgs option is independent of the traced procedure. Now, if you use `prog::trace` to trace any other procedure, `prog::trace` hides arguments in every step of that procedure. Remove this global option for further computations:

```
prog::untrace(linalg):
prog::trace(NoArgs = FALSE)
```

## Example 6

If you use the Parent option, `prog::trace` shows the name of the procedure that calls the traced object:

```
prog::trace(cos):
prog::trace(Parent):
f := x -> cos(2*x):
g := (x, y) -> f(x) + f(y):
g(3/2*PI, -3/2*PI)

enter cos(3*PI) (called from f)
  enter cos(PI) (called from cos)
  remembered -1
```

```

computed -1
enter cos(-3*PI) (called from f)
  enter cos(3*PI) (called from cos)
    remembered -1
  computed -1

```

-2

```

prog::trace(f):
prog::trace(g):
g(-PI, PI)

enter g(-PI, PI)
  enter f(-PI) (called from g)
    enter cos(-2*PI) (called from f)
      enter cos(2*PI) (called from cos)
        enter cos(0) (called from cos)
          remembered 1
        computed 1
      computed 1
    computed 1
  enter f(PI) (called from g)
    enter cos(2*PI) (called from f)
      remembered 1
    computed 1
  computed 2

```

2

The Parent option is independent of the traced procedures. Now, if you use `prog::trace` to trace any other object, `prog::trace` shows relations between calls to the traced objects. Remove this global option for further computations:

```

prog::untrace(cos):
prog::trace(Parent = FALSE)

```

## Example 7

By default, the `prog::trace` function traces all slots of a function environment. For example, trace the `besselJ` function and observe the following function call:

```
prog::trace(besselJ);
besselJ(1, 2.3)

enter besselJ(1, 2.3)
  enter besselJ::float(1, 2.3)
  computed 0.5398725326
computed 0.5398725326
```

0.5398725326

To omit tracing of all slots, set the value of the Recursive option to FALSE:

```
prog::untrace(besselJ);
prog::trace(besselJ, Recursive=FALSE);
besselJ(1, 4.5)
```

```
enter besselJ(1, 4.5)
computed -0.2310604319
```

-0.2310604319

For further computations, stop observation of the besselJ function:

```
prog::untrace(besselJ)
```

## Example 8

You can trace domains and domain methods. For example, create the following small domain:

```
T := newDomain("T"):
T::new := proc(h, m = 0) name T; begin new(T, h*60 + m) end:
T::intern := x -> [op(x) div 60, op(x) mod 60]:
T::print := x -> expr2text(T::intern(x)[1]).":".
  substring(expr2text(100 + T::intern(x)[2]), 2, 2):
T::_plus := () -> new(T, _plus(map(args(), op))):
T::expr := op:
T::_mult := () -> new(T, _mult(map(args(), expr))):
prog::trace(T):
T(1, 30) + T(0, 45)*T(1, 05)

enter T(1, 30)
computed 1:30
```



```

enter T(0, 45)
computed 0:45
enter T(1, 5)
computed 1:05
enter T::_mult(0:45, 1:05)
computed 48:45
enter T::_plus(1:30, 48:45)
computed 50:15

```

50:15

MuPAD does not trace the process of displaying traced outputs. Therefore, the `T::_intern` and `T::_print` methods do not appear in the traced outputs.

Now, trace the arithmetic methods only. When specifying the methods to trace, use their slot names, such as `slot(T, "_plus")` or `T::_plus`:

```

prog::untrace():
prog::trace({T::_plus, T::_mult}):
T(1, 30) + T(0, 45)*T(1, 05)

enter T::_mult(0:45, 1:05)
computed 48:45
enter T::_plus(1:30, 48:45)
computed 50:15

```

50:15

```
prog::untrace():
```

## Parameters

### obj

A MuPAD function, a domain, a method, or a function environment to observe. Specify methods by their `slot` names (strings).

**{obj<sub>1</sub>, obj<sub>2</sub>, ...}**

A set of MuPAD functions, domains, methods, or function environments to observe.

## Options

### Depth

Option, specified as `Depth = level`

Display nested function calls only up to the recursion depth `level`. Here `level` is a positive integer. After you set this option, all new and regenerated outputs for traced objects show the nested function calls only up to the specified recursion depth. See “Example 3” on page 27-80 (Symbolic Math Toolbox).

### Mem

Show the current memory usage. After you set this option, all new and regenerated outputs for traced objects show the information about the current memory usage. See “Example 4” on page 27-81 (Symbolic Math Toolbox).

### NoArgs

Do not show the arguments of calls to traced objects and the returned values. Without this option, all outputs for traced objects show the arguments and returned values for each call of a traced object. See “Example 5” on page 27-82 (Symbolic Math Toolbox).

### Parent

Show the name of the procedure that calls the traced object. After you set this option, all new and regenerated outputs for traced objects show the names of the procedures that call the traced objects. See “Example 6” on page 27-82 (Symbolic Math Toolbox).

### Recursive

Option, specified as `Recursive = FALSE`

Do not trace all slots of a function environment or domain. By default, `Recursive = TRUE`. See “Example 7” on page 27-83 (Symbolic Math Toolbox).

## Return Values

`prog:::trace` returns the void object `null()`.

## See Also

### MuPAD Functions

debug | prog::profile | prog::traced | prog::untrace

## prog::traced

Find traced functions

### Syntax

```
prog::traced(<obj>)
```

### Description

`prog::traced()` lists all traced functions.

`prog::traced(obj)` detects, whether the function `obj` is traced. If `obj` is a library or a function environment, then all methods will be checked. If no argument is given, all traced on page 27-77 functions will be displayed.

`prog::traced` determines whether a copy exists and whether the function has been manipulated the way `prog::trace` does.

### Examples

#### Example 1

The `sin` function is traced:

```
prog::trace(sin):  
prog::traced(sin)
```

TRUE

The `cos` function is not traced:

```
prog::traced(cos)
```

FALSE

## Parameters

**obj**

A MuPAD function, a function environment or a library

## Return Values

prog::traced returns the void object `null()`.

## See Also

### **MuPAD Functions**

prog::trace | prog::untrace

## prog::untrace

Terminates observation of functions

### Syntax

```
prog::untrace(obj)
```

```
prog::untrace()
```

### Description

`prog::untrace(obj)` terminates the observation of the MuPAD function `obj` performed by `prog::trace`.

`obj` can be a domain on page 7-8 or a function environment on page 7-25, too. Then all methods of the domain or function environment will be restored.

If no argument is given, all observed objects will be restored from observation.

### Examples

#### Example 1

The observation of a function will be terminated:

```
prog::trace(sin):  
sin(2)
```

```
enter sin(2)  
computed sin(2)
```

```
sin(2)
```

```
prog::untrace(sin):  
sin(2)
```

sin(2)

## Parameters

**obj**

The MuPAD function that is observed, or a domain or a function environment

## Return Values

prog::untrace returns the void object `null()`.

## See Also

### **MuPAD Functions**

debug | prog::profile | prog::trace

## prog::wait

Wait for a while

### Syntax

```
prog::wait(m)
```

```
prog::wait(s)
```

### Description

`prog::wait(m)` waits for `m` milli seconds.

`prog::wait(s)` waits for `s` seconds.

`prog::wait` uses the function `rtime` for time measurement.

### Examples

#### Example 1

Wait for 3 seconds:

```
prog::wait(3000)
```

Wait for 3 seconds again:

```
prog::wait(3.0)
```

The next example shows the difference between the system time on page 1-2153 and the CPU time on page 1-810 (Symbolic Math Toolbox) used by MuPAD:

```
time(prog::wait(2.5))
```

2040



In 2.5 seconds realtime the MuPAD process runs nearly two seconds.

## Example 2

Use `traperror` to limit the evaluation time:

```
traperror(prog::wait(100.0), 5): lasterror()
```

```
Error: Execution time exceeded.
```

## Parameters

**m**

Milli seconds to wait as positive integer

**s**

Seconds to wait as positive floating-point number

## Return Values

`prog::wait` returns the empty object `null()`.

## See Also

### MuPAD Functions

`rtime` | `time` | `traperror`



# **property - Properties and Assumptions**

---

## property::depends

Dependence table with all properties of an expression

### Syntax

```
property::depends(ex, ...)
```

### Description

`property::depends(...)` returns a table which contains all information about the properties of the whole input. This table can be used to determine any change of the properties of an expression.

The returned table is mainly used inside the MuPAD library, to ensure the validity of remembered results of the `remember` mechanism on page 27-43.

A MuPAD expression can have different properties at different times, without changing its value.

---

**Note** The kernel `remember` mechanism on page 1-1654 cannot determine the change of the properties and returns wrong results, when the result depends on the properties of the input.

---

In this case the extended `remember` mechanism provided by `prog::remember` should be used together with `property::depends`.

### Examples

#### Example 1

A compare of the dependence table at different times detects changes of the properties of an expression.

The first call to the defined function `has_changed` initializes the table `DEPENDS` that keeps the dependence information:

```
DEPENDS := table():
has_changed :=
  proc(ex)
  begin
    if not contains(DEPENDS, ex)
      or property::depends(ex) <> DEPENDS[ex] then
      DEPENDS[ex] := property::depends(ex);
      TRUE
    else
      FALSE
    end_if
  end_proc:
has_changed(sin(x*PI)):
```

The properties has not changed:

```
has_changed(sin(x*PI))
```

**FALSE**

Every change is detected:

```
assume(x, Type::Integer):
has_changed(sin(x*PI))
```

**TRUE**

```
assume(x, Type::PosInt):
has_changed(sin(x*PI))
```

**TRUE**

```
assume(x >= 0):
has_changed(sin(x*PI))
```

**TRUE**

```
unassume(x):  
has_changed(sin(x*PI))
```

TRUE

```
delete DEPENDS, has_changed:
```

## Example 2

The next example shows the problems with the kernel remember mechanism:

```
pos := proc(x)  
    option remember;  
    begin  
        is(x > 0)  
    end:  
pos(x)
```

UNKNOWN

The result UNKNOWN was stored for the input x and is returned, although the properties of x are changed:

```
assume(x > 0): pos(x);  
assume(x < 0): pos(x)
```

UNKNOWN

UNKNOWN

This problem can only be solved by the extended remember mechanism on page 27-43 together with `property::depends` (x still is less than zero):

```
pos := proc(x)  
    begin  
        is(x > 0)  
    end:  
pos := prog::remember(pos, property::depends):  
pos(x)
```

FALSE

After changing the properties of the input, the defined function recomputes the result:

```
assume(x > 0): pos(x);  
unassume(x): pos(x)
```

TRUE

UNKNOWN

## Parameters

**ex**

Any MuPAD expression

## Return Values

Table that can be compared with another dependence table

## See Also

### MuPAD Functions

assume | getprop | is | prog::remember

## property::hasprop

Does an object have properties?

### Syntax

```
property::hasprop(object)
```

```
property::hasprop()
```

### Description

`property::hasprop(object)` tests, whether the object has properties and returns TRUE if the object or any subexpression has a property, otherwise FALSE.

Compared with `getprop`, `property::hasprop` is a fast function and can be used to determine, whether an object has properties without using the slower functions `getprop` or `is`.

---

**Note** In some cases, the function `is` can derive some aspects without any defined property (see “Example 2” on page 28-7 (Symbolic Math Toolbox))!

---

### Examples

#### Example 1

Does the expression  $2*(x+1)$  have any properties?

```
property::hasprop(2*(x + 1))
```

```
FALSE
```

```
assume(x > 0):  
property::hasprop(2*(x + 1))
```



TRUE

```
getprop(2*(x + 1))
```

(2,  $\infty$ )

```
delete x:
```

## Example 2

property::hasprop returns FALSE, but is can determine an answer unequal to UNKNOWN:

```
property::hasprop(0 < x/(x + y) + y/(x + y))
```

FALSE

```
is(exp(x) = 0)
```

FALSE

## Parameters

**object**

Any MuPAD object

## Return Values

TRUE or FALSE

## See Also

### **MuPAD Functions**

assume | getprop | indets | is | unassume

# property::showprops

What assumptions are made?

## Syntax

```
property::showprops(object)
```

## Description

`property::showprops(object)` shows all assumptions set for identifiers in `object`. If no assumptions were set, the empty list is returned.

## Examples

### Example 1

```
assume(x > 0);  
property::showprops(x);
```

```
[0 < x]
```

```
assumeAlso(x < 1);  
property::showprops(x);
```

```
[0 < x, x < 1]
```

```
delete x:
```

## **Parameters**

### **object**

Any MuPAD object

## **Return Values**

List containing all assumptions.

## **See Also**

### **MuPAD Functions**

assume | getprop | unassume

# **solvelib - Datatypes and Utilities for the Solver**

---

## **solvelib::BasicSet**

Basic infinite sets

### **Syntax**

#### **Domain Creation**

```
solvelib::BasicSet(Dom::Integer)
```

```
solvelib::BasicSet(Dom::Rational)
```

```
solvelib::BasicSet(Dom::Real)
```

```
solvelib::BasicSet(Dom::Complex)
```

### **Description**

The domain `solvelib::BasicSet` comprises the four sets of integers, reals, rationals, and complex numbers, respectively.

The four basic sets are assigned to the identifiers `Z_`, `Q_`, `R_`, and `C_` during system initialization.

The set of positive integers, too, is assigned to the identifier `N_` during system initialization. It is not represented by a basic set but by the intersection of `Z_` and the interval `Dom::Interval([1], infinity)`.

### **Superdomain**

```
Dom::BaseDomain
```

### **Axioms**

```
Ax::canonicalRep
```

## Categories

Cat::Set

## Examples

### Example 1

The domain of basic sets know about the basic arithmetical and set-theoretic functions:

```
J:=Dom::Interval(3/2, 21/4):
Z_ intersect J
```

```
{2, 3, 4, 5}
```

## Methods

### Mathematical Methods

**contains** — Test whether some object is a member

```
contains(a, S)
```

Equivalently, `is(a in S)` may be used.

### Conversion Methods

**convert** — Convert a domain into a basic set

```
convert(d)
```

**set2prop** — Convert a set to a property

```
set2prop(S)
```

## See Also

### MuPAD Domains

C\_ | Dom::Interval | N\_ | Q\_ | R\_ | Z\_



# C\_

Complex numbers

## Description

C\_, or equivalently `solveLib::BasicSet(Dom::Complex)`, represents the set of complex numbers.

The four basic sets are assigned to the identifiers Z\_, Q\_, R\_, and C\_ during system initialization.

## Superdomain

`Dom::BaseDomain`

## Axioms

`Ax::canonicalRep`

## Categories

`Cat::Set`

## Methods

### Mathematical Methods

**contains** — Test whether some object is a member

`contains(a, S)`

Equivalently, `is(a in S)` may be used.

## Conversion Methods

**convert** — Convert a domain into a basic set

`convert(d)`

**set2prop** — Convert a set to a property

`set2prop(S)`

## See Also

### MuPAD Domains

`Dom::Interval | N_ | Q_ | R_ | Z_ | solvelib::BasicSet`

## R\_

Real numbers

### Description

R\_ or equivalently `solveLib::BasicSet(Dom::Real)`, represents the set of real numbers.

The four basic sets are assigned to the identifiers Z\_, Q\_, R\_, and C\_ during system initialization.

### Superdomain

`Dom::BaseDomain`

### Axioms

`Ax::canonicalRep`

### Categories

`Cat::Set`

### Methods

#### Mathematical Methods

**contains** — Test whether some object is a member

`contains(a, S)`

Equivalently, `is(a in S)` may be used.

## Conversion Methods

**convert** — Convert a domain into a basic set

`convert(d)`

**set2prop** — Convert a set to a property

`set2prop(S)`

## See Also

**MuPAD Domains**

`C_ | Dom::Interval | N_ | Q_ | Z_ | solvelib::BasicSet`

## Q\_

Rational numbers

### Description

Q\_, or equivalently `solveLib::BasicSet(Dom::Rational)`, represents the set of rational numbers.

The four basic sets are assigned to the identifiers Z\_, Q\_, R\_, and C\_ during system initialization.

### Superdomain

`Dom::BaseDomain`

### Axioms

`Ax::canonicalRep`

### Categories

`Cat::Set`

### Methods

#### Mathematical Methods

**contains** — Test whether some object is a member

`contains(a, S)`

Equivalently, `is(a in S)` may be used.

## Conversion Methods

**convert** — Convert a domain into a basic set

`convert(d)`

**set2prop** — Convert a set to a property

`set2prop(S)`

## See Also

**MuPAD Domains**

`C_ | Dom::Interval | N_ | R_ | Z_ | solvelib::BasicSet`

# Z\_

Integers

## Description

Z\_ or equivalently `solveLib::BasicSet(Dom::Integer)`, represents the set of integers.

The four basic sets are assigned to the identifiers Z\_, Q\_, R\_, and C\_ during system initialization.

The set of positive integers, too, is assigned to the identifier N\_ during system initialization. It is not represented by a basic set but by the intersection of Z\_ and the interval `Dom::Interval([1], infinity)`.

## Superdomain

`Dom::BaseDomain`

## Axioms

`Ax::canonicalRep`

## Categories

`Cat::Set`

## Examples

### Example 1

The domain of basic sets know about the basic arithmetical and set-theoretic functions:

```
J:=Dom::Interval(3/2, 21/4):  
Z_ intersect J
```

```
{2, 3, 4, 5}
```

## Methods

### Mathematical Methods

**contains** — Test whether some object is a member

```
contains(a, S)
```

Equivalently, `is(a in S)` may be used.

### Conversion Methods

**convert** — Convert a domain into a basic set

```
convert(d)
```

**set2prop** — Convert a set to a property

```
set2prop(S)
```



---

## See Also

### MuPAD Domains

C\_ | Dom::Interval | N\_ | Q\_ | R\_ | solvelib::BasicSet

## **N\_**

Positive integers

### **Description**

N\_ represents the set of positive integers.

The four basic sets are assigned to the identifiers Z\_, Q\_, R\_, and C\_ during system initialization.

The set of positive integers, too, is assigned to the identifier N\_ during system initialization. It is not represented by a basic set but by the intersection of Z\_ and the interval `Dom::Interval([1], infinity)`.

### **Superdomain**

`Dom::BaseDomain`

### **Axioms**

`Ax::canonicalRep`

### **Categories**

`Cat::Set`

## Methods

### Mathematical Methods

**contains** — Test whether some object is a member

`contains(a, S)`

Equivalently, `is(a in S)` may be used.

### Conversion Methods

**convert** — Convert a domain into a basic set

`convert(d)`

**set2prop** — Convert a set to a property

`set2prop(S)`

## See Also

### MuPAD Domains

`C_ | Dom::Interval | Q_ | R_ | Z_ | solvelib::BasicSet`

## **solvelib::cartesianPower**

Cartesian power of a set

### **Syntax**

#### **Domain Creation**

```
solvelib::cartesianPower()
```

```
solvelib::cartesianPower(S, n)
```

### **Description**

`solvelib::cartesianPower` is the domain of all cartesian powers of subsets of the complex numbers.

`solvelib::cartesianPower(S, n)` returns the set of all n-tuples of elements of S.

`solvelib::cartesianPower(S, n)` returns the n-fold cartesian product of S with itself, that is, the set of all vectors of length n whose components are elements of S.

S must represent a subset of the complex numbers; see `solve` for an overview of the different kinds of sets in MuPAD.

The set of one-tuples of elements of S consists of vectors and therefore differs from the set S in the same way as matrices of type `matrix` with one row and one column are different from numbers.

### **Superdomain**

```
Dom::BaseDomain
```

## Categories

Cat::Set

## Examples

### Example 1

A cartesian power of a finite set of numbers is a finite set of vectors:

```
A := solvelib::cartesianPower({1, 2, I}, 3)
```

$$\left\{ \begin{pmatrix} 1 \\ 1 \\ 1 \end{pmatrix}, \begin{pmatrix} 2 \\ 1 \\ 1 \end{pmatrix}, \begin{pmatrix} 1 \\ 2 \\ 1 \end{pmatrix}, \begin{pmatrix} 1 \\ 1 \\ 2 \end{pmatrix}, \begin{pmatrix} 2 \\ 2 \\ 1 \end{pmatrix}, \begin{pmatrix} 2 \\ 1 \\ 2 \end{pmatrix}, \begin{pmatrix} 1 \\ 2 \\ 2 \end{pmatrix}, \begin{pmatrix} 2 \\ 2 \\ 2 \end{pmatrix}, \begin{pmatrix} i \\ 1 \\ 1 \end{pmatrix}, \begin{pmatrix} 1 \\ i \\ 1 \end{pmatrix}, \begin{pmatrix} 1 \\ 1 \\ i \end{pmatrix}, \begin{pmatrix} i \\ 2 \\ 1 \end{pmatrix}, \begin{pmatrix} 2 \\ i \\ 1 \end{pmatrix}, \begin{pmatrix} 1 \\ 2 \\ i \end{pmatrix}, \begin{pmatrix} i \\ i \\ 1 \end{pmatrix}, \begin{pmatrix} 1 \\ i \\ 2 \end{pmatrix}, \begin{pmatrix} i \\ 2 \\ i \end{pmatrix}, \begin{pmatrix} 2 \\ i \\ i \end{pmatrix}, \begin{pmatrix} i \\ i \\ i \end{pmatrix} \right\}$$

We can select those vectors with all components real as follows:

```
A intersect solvelib::cartesianPower(R_, 3)
```

$$\left\{ \begin{pmatrix} 1 \\ 1 \\ 1 \end{pmatrix}, \begin{pmatrix} 2 \\ 1 \\ 1 \end{pmatrix}, \begin{pmatrix} 1 \\ 2 \\ 1 \end{pmatrix}, \begin{pmatrix} 1 \\ 1 \\ 2 \end{pmatrix}, \begin{pmatrix} 2 \\ 2 \\ 1 \end{pmatrix}, \begin{pmatrix} 2 \\ 1 \\ 2 \end{pmatrix}, \begin{pmatrix} 1 \\ 2 \\ 2 \end{pmatrix}, \begin{pmatrix} 2 \\ 2 \\ 2 \end{pmatrix} \right\}$$

### Example 2

Cartesian powers of the set of complex numbers may occur as the result of a call to solve if every n-tuple of complex numbers is a solution of the given system:

```
solve([x+y = x+y], [x, y], VectorFormat)
```

$C^2$

## Parameters

**S**

Set

**n**

Positive integer

## Methods

### Access Methods

**base** — Set S

base(A)

**dimension** — Exponent n

dimension(A)

### Technical Methods

**print** — Print a cartesian power

print(A)

# solvelib::cartesianProduct

Cartesian product of sets

## Syntax

```
solvelib::cartesianProduct(S, ...)
```

## Description

`solvelib::cartesianProduct(S, ...)` returns the cartesian product of its arguments.

The arguments may be sets of any type, consisting of complex numbers; the result is a set that consists of vectors, or a symbolic call to `solvelib::cartesianProduct`. See `solve` for an overview of the different kinds of sets in MuPAD.

## Examples

### Example 1

For finite sets, the result is similar to that of `combinat::cartesianProduct` but consists of vectors and not of lists:

```
S:= solvelib::cartesianProduct({1, 2}, {3, 4})
```

$$\left\{ \begin{pmatrix} 1 \\ 3 \end{pmatrix}, \begin{pmatrix} 2 \\ 3 \end{pmatrix}, \begin{pmatrix} 1 \\ 4 \end{pmatrix}, \begin{pmatrix} 2 \\ 4 \end{pmatrix} \right\}$$

```
solvelib::splitVectorSet(S)
```

$$[[1, 2], [3, 4]]$$

```
delete S:
```

## Example 2

For infinite sets, results of various types are possible, e.g.,  
`souvelib::VectorImageSet` or `souvelib::cartesianPower`:

```
souvelib::cartesianProduct(R_, R_)
```

$$\mathbb{R}^2$$

```
souvelib::cartesianProduct(PI*Z_, Z_)
```

$$\left\{ \begin{pmatrix} \pi k \\ l \end{pmatrix} \mid k \in \mathbb{Z}, l \in \mathbb{Z} \right\}$$

## Parameters

**S**

Set of complex numbers

## Return Values

Set

## See Also

### MuPAD Functions

`combinat::cartesianProduct` | `solve` | `souvelib::cartesianPower` |  
`souvelib::splitVectorSet`



# solvelib::conditionalSort

Possible sortings of a list depending on parameters

## Syntax

```
solvelib::conditionalSort(l)
```

## Description

`solvelib::conditionalSort(l)` sorts the list `l` in ascending order. Unlike for `sort`, only the usual order on the real numbers and not the internal order (see `sysorder`) is used. `solvelib::conditionalSort` does a case analysis if list elements contain indeterminates.

`solvelib::conditionalSort` invokes the inequality solver to get simple conditions in the case analysis. The ability of `solvelib::conditionalSort` to recognize sortings as impossible is thus limited by the ability of the inequality solver to recognize an inequality as unsolvable. See “Example 3” on page 29-22 (Symbolic Math Toolbox).

Only expressions representing real numbers can be sorted. It is an error if non-real numbers occur in the list; it is implicitly assumed that all parameters take on only such values that cause all list elements to be real.

Sorting is unstable, i.e. equal elements may be placed in any order in the resulting list; these cases may be listed separately in the case analysis.

The usual simplifications for piecewise defined objects are applied, e.g., equalities that can be derived from a condition are applied (by substitution) to the list.

## Environment Interactions

`solvelib::conditionalSort` takes into account the assumptions on all occurring identifiers.

## Examples

### Example 1

In the simplest case, sorting a two-element list  $[a, b]$  just amounts to solving the inequality  $a \leq b$  w.r.t. all occurring parameters.

```
souvelib::conditionalSort([x,x^2])
```

$$\begin{cases} [x, x^2] & \text{if } 0 < x(x-1) \\ [x^2, x] & \text{if } x(x-1) \leq 0 \end{cases}$$

### Example 2

If, by implicit or explicit assumptions on the parameters, no different sortings can occur, the result is just a list.

According to the implicit assumption that all list elements are real,  $x$  must be nonnegative.

```
souvelib::conditionalSort([sqrt(x), -3])
```

$$[-3, \sqrt{x}]$$

### Example 3

Sometimes cases are not recognized as impossible.

```
assume(x>5): souvelib::conditionalSort([x,gamma(x)])
```

$$\begin{cases} [x, \Gamma(x)] & \text{if } x < \Gamma(x) \\ [\Gamma(x), x] & \text{if } \Gamma(x) \leq x \end{cases}$$

## Parameters

$\mathcal{L}$

List of arithmetical expressions

## Return Values

List if the sorting is the same for all possible parameter values; or an object of type `piecewise` if some case analysis is necessary.

## Algorithms

The complexity of sorting a list of  $n$  elements is up to  $n!$ .

## See Also

**MuPAD Functions**  
`piecewise` | `sort`

## **solvelib::getElement**

Get one element of a set

### **Syntax**

```
solvelib::getElement(S, <Random>)
```

### **Description**

`solvelib::getElement(S)` returns an element of `S`.

`S` can be a set of any type; see `solve` for an overview of all sets.

`solvelib::getElement` returns the value `FAIL` if:

- `S` is the empty set
- the solver cannot find any element of the set due to the solver's limitations
- the solver cannot compute the first element of a set. You can use the `Random` option to check a random element of a set instead of the first element
- the answer depends on a case analysis on some parameter

With the option `Random`, the probability to get any particular element of a set is:

- Roughly equal for the elements of a finite set
- Proportional to the multiplicities for the elements of a finite multiset of type `Dom::Multiset`
- Unspecified for the elements of an infinite set. Practically, the same result does not occur twice for infinite sets.

## Examples

### Example 1

If  $S$  is a finite set, the solver returns just one of the elements:

```
solvelib::getElement({2, 7, a})
```

2

### Example 2

For image sets, the solver replaces every parameter by a constant:

```
S:=Dom::ImageSet(k*PI, k, solvelib::BasicSet(Dom::Integer))
```

$$\{\pi k \mid k \in \mathbb{Z}\}$$

```
solvelib::getElement(S)
```

0

### Example 3

If the set is empty, the solver cannot find any element:

```
solvelib::getElement({})
```

FAIL

`solvelib::getElement` might fail to find an element of a set although that set is not empty.

```
solvelib::getElement(solve(exp(x) + cos(x) = x^2,x))
```

FAIL

## Example 4

Without the option `Random`, `souvelib::getElement` always produces the same result for a set:

```
souvelib::getElement({$1..5}) $i=1..5
```

```
1, 1, 1, 1, 1
```

With the option `Random`, the returned element varies randomly from call to call:

```
souvelib::getElement({$1..5}, Random) $i=1..15
```

```
2, 1, 3, 4, 2, 4, 1, 4, 2, 5, 1, 4, 3, 1, 5
```

The distribution of the returned values is close to the uniform distribution. For multisets, the multiplicity of elements is taken into account:

```
souvelib::getElement(Dom::Multiset(1$4, 2$2), Random) $i=1..18
```

```
1, 1, 1, 1, 2, 1, 1, 1, 1, 1, 1, 1, 1, 2, 1, 2, 1, 1
```

## Example 5

For the following set parametrized by integers, the solver fails to find an element. This is because the solver tries only the first parameter-value pair  $k = 0$  for which the result is undefined. After that the solver does not try any other parameter-value pairs:

```
souvelib::getElement(1/Z_)
```

```
FAIL
```

For the sets with the undefined first element, you can get the result calling the solver with the option `Random`:

```
souvelib::getElement(1/Z_, Random)
```

```
 $\frac{1}{902}$ 
```

## Parameters

S

Any set

## Options

### Random

Returns a random element of a set. Without this option, `solvelib::getElement(S)` always returns the same element.

## Return Values

`solvelib::getElement` returns a MuPAD object representing an element of S, or FAIL if no element could be determined.

## Overloaded By

S

## See Also

### MuPAD Functions

`solve`

## **solvelib::isEmpty**

Predicate expressing the emptiness of a set

### **Syntax**

```
solvelib::isEmpty(S)
```

### **Description**

`solvelib::isEmpty(S)` returns a boolean expression that is equivalent to the statement that  $S$  is the empty set.

Since functions operating on boolean expressions like `assume`, `is`, or `solve` cannot handle equations involving sets, it is not possible to pass the expression  $S=\{\}$  to them. `solvelib::isEmpty(S)` helps to get around this problem, as it tries to express the emptiness of  $S$  in an equivalent way that can be handled by the aforementioned functions. If no suitable equivalent expression is found, the unevaluated call to `solvelib::isEmpty` is returned.

$S$  may be a set of any type; see `solve` for an enumeration of the various types of sets.

The `solvelib::isEmpty` function always returns Boolean expressions, even if the function cannot resolve an expression. See “Example 4” on page 29-29 (Symbolic Math Toolbox).

### **Examples**

#### **Example 1**

The emptiness of a `DOM_SET` can be decided immediately:

```
solvelib::isEmpty({a, b}), solvelib::isEmpty({})
```

**FALSE, TRUE**



## Example 2

The intersection of a finite set with any other set is empty if and only if none of the elements of the finite set is in the other set:

```
solvelib::isEmpty({a, b} intersect Z_)
```

$$a \notin \mathbb{Z} \wedge b \notin \mathbb{Z}$$

## Example 3

The output of solve can be entered directly into solvelib::isEmpty:

```
solvelib::isEmpty(solve(a*x=b, x))
```

$$a = 0 \wedge b \neq 0$$

## Example 4

Sometimes, no simpler equivalent expression can be found:

```
result := solvelib::isEmpty(solve(x^2 = sin(x), x))
```

$$\text{solvelib::isEmpty}(\text{solve}(x^2 - \sin(x) = 0, x))$$

The returned expression is a Boolean expression:

```
testtype(result, Type::Boolean)
```

TRUE

## Parameters

**s**

Any set

## **Return Values**

Boolean expression

## **Overloaded By**

S

## **See Also**

### **MuPAD Functions**

assume | is | solve

# solvelib::isFinite

Test whether a set is finite

## Syntax

```
solvelib::isFinite(S)
```

## Description

`solvelib::isFinite(S)` returns `TRUE`, `FALSE`, or `UNKNOWN` depending on whether `S` is finite, infinite, or the question could not be settled.

`S` may be a set of any type; see `solve` for an enumeration of the various types of sets.

## Examples

### Example 1

A `DOM_SET` is always finite:

```
solvelib::isFinite({2,5})
```

`TRUE`

### Example 2

The set of integers is infinite.

```
solvelib::isFinite(Z_)
```

`FALSE`

## **Parameters**

S

Any set

## **Return Values**

Boolean value

## **Overloaded By**

S

## **See Also**

**MuPAD Functions**

solve

# solvelib::pdioe

Solve polynomial Diophantine equations

## Syntax

```
solvelib::pdioe(a, b, c)
```

```
solvelib::pdioe(aexpr, bexpr, cexpr, x)
```

## Description

`solvelib::pdioe(a, b, c)` returns polynomials  $u$  and  $v$  that satisfy the equation  $au + bv = c$ .

`solvelib::pdioe(aexpr, bexpr, cexpr, x)` does the same after converting the arguments into univariate polynomials  $a$ ,  $b$ ,  $c$  in the variable  $x$ .

The coefficient ring of the polynomials  $a$ ,  $b$ , and  $c$  must be either `Expr`, or `IntMod(p)` for some prime  $p$ , or a domain belonging to the category `Cat::Field`.

## Examples

### Example 1

If expressions are passed as arguments, a fourth argument must be provided:

```
solvelib::pdioe(x,
  13*x + 22*x^2 + 18*x^3 + 7*x^4 + x^5 + 3,
  x^2 + 1,
  x)
```

$$-\frac{x^4}{3} - \frac{7x^3}{3} - 6x^2 - \frac{19x}{3} - \frac{13}{3}, \frac{1}{3}$$

## Example 2

$x$  is not a multiple of the gcd of  $x + 1$  and  $x^2 - 1$ . Hence the equation  $u(x + 1) + v(x^2 - 1) = x$  has no solution for  $u$  and  $v$ :

```
solverlib::pdioe(x + 1, x^2 - 1, x, x)
```

FAIL

## Example 3

If the arguments are polynomials, the fourth argument may be omitted:

```
solverlib::pdioe(poly(a + 1, [a]),  
                 poly(a^2 + 1, [a]),  
                 poly(a - 1, [a]))
```

$\text{poly}(a, [a]), \text{poly}(-1, [a])$

## Parameters

**x**

Identifier or indexed identifier

**a, b, c**

Univariate polynomials

**aexpr, bexpr, cexpr**

Polynomial expressions

## Return Values

If the equation is solvable, `solvelib::pdioe` returns an expression sequence consisting of two operands of the same type as the input (expressions or polynomials). If the equation has no solution, `solvelib::pdioe` returns FAIL.

## See Also

### MuPAD Functions

`solve`

## `solverlib::preImage`

Preimage of a set under a mapping

### Syntax

```
solverlib::preImage(a, x, S)
```

### Description

`solverlib::preImage(a, x, S)` returns the set of all numbers  $y$  such that substituting  $y$  for  $x$  in  $a$  gives an element of  $S$ .

$S$  can be a set of any type (finite or infinite).

### Examples

#### Example 1

In case of a finite set  $S$ , the preimage of  $S$  is just the union of all sets `solve(a=s, x)`, where  $s$  ranges over the elements of  $S$ .

```
solverlib::preImage(x^2+2, x, {11, 15});
```

```
{-3, 3, sqrt(13), -sqrt(13)}
```

Note that computing this set may take a long time for large finite sets:

```
time(solverlib::preImage(x, x,  
    Z_ intersect Dom::Interval(0, 1000000)))
```

```
14657
```



## Example 2

For intervals, the preimage is usually an interval or a union of intervals.

```
solvelib::preImage(x^2+2, x, Dom::Interval(3..7));
```

$$(1, \sqrt{5}) \cup (-\sqrt{5}, -1)$$

## Parameters

**a**

Arithmetic expression

**x**

Identifier

**S**

Set

## Return Values

Set

## See Also

**MuPAD Functions**

solve

## `solverlib::splitVectorSet`

Factor a set of vectors into a cartesian product

### Syntax

```
solverlib::splitVectorSet(S)
```

### Description

`solverlib::splitVectorSet(S)` returns a list  $S_1, \dots, S_n$  of sets of complex numbers such that  $S$  is the cartesian product of the  $S_i$ , or FAIL if such factorization could not be found.

The set  $S$  may be finite or infinite, of any type.

### Examples

#### Example 1

We split a finite set of vectors into its factors:

```
solverlib::splitVectorSet({[1, 2], [1, 3], [0, 2], [0, 3]})
```

```
[[{0, 1}, {2, 3}]]
```

The following set cannot be written as a cartesian product:

```
solverlib::splitVectorSet({[1, 2], [0, 2], [0, 3]})
```

```
FAIL
```

## Example 2

Infinite sets can also be handled:

```
S:= Dom::ImageSet([k*PI, l*PI+2], [k, l], [Z_, Z_])
```

$$\left\{ \left( \begin{array}{c} \pi k \\ \pi l + 2 \end{array} \right) \mid k \in \mathbb{Z}, l \in \mathbb{Z} \right\}$$

```
solvelib::splitVectorSet(S)
```

$$[\{\pi k \mid k \in \mathbb{Z}\}, \{\pi k + 2 \mid k \in \mathbb{Z}\}]$$

```
delete S:
```

## Parameters

**S**

Set of vectors

## Return Values

List of type DOM\_LIST, or FAIL

## See Also

**MuPAD Functions**

solve

## `solveLib::Union`

Union of a system of sets

### Syntax

```
solveLib::Union(set, param, paramset)
```

```
solveLib::Union(set, paramlist, vectorset)
```

### Description

`solveLib::Union (set, paramlist, vectorset)` returns the set of all objects that can be obtained by replacing, in some element of `set`, the list of free parameters `paramlist` by an element of `vectorset`.

`set` may be a set of any type; it need not depend on the parameter `param`, and it may also contain other free parameters.

`paramset` may be a set of any type and may depend on some free parameters. See “Example 1” on page 29-40 (Symbolic Math Toolbox).

If `paramset` is empty, the result is the empty set. Overloading has no effect in this case.

`vectorset` may be a set of any type, consisting of vectors whose dimension equals the number of variables in `paramlist`.

### Examples

#### Example 1

We compute the set of all numbers that are equal to  $k + 1$  or  $k + 3$  for  $k = 2$ ,  $k = 4$ , or  $k = l$ , where  $l$  is a free parameter.

```
solveLib::Union({k+1, k+3}, k, {2,4,l});
```

$$\{3, 5, 7, l+1, l+3\}$$

## Example 2

In the same way, we can let a pair of parameters range over a set of pairs:

```
solvelib::Union(Dom::ImageSet(PI*k + exp(x) + y, k, Z_),
               [x, y], {[3, 2], [1, 4]})
```

$$\{e^{\pi k+4} \mid k \in \mathbb{Z}\} \cup \{e^{\pi k+2} \mid k \in \mathbb{Z}\}$$

## Parameters

### set

Set of any type

### param

Identifier

### paramset

Set of any type

### paramlist

List of identifiers

### vectorset

Set of vectors

## Return Values

`solvelib::Union` returns a set of any type; see `solve` for an overview of the different types of sets. It may also return the unevaluated call if the union could not be computed.

## **Overloaded By**

set

## **See Also**

### **MuPAD Functions**

solve

# solvelib::VectorImageSet

Domain of set of vectors that are images of sets under mappings

## Syntax

### Domain Creation

```
solvelib::VectorImageSet()
```

### Element Creation

```
solvelib::VectorImageSet(v, x, S)
```

```
Dom::ImageSet(v, [x1, ...], [S1, ...])
```

## Description

### Domain Creation

`solvelib::VectorImageSet` is the domain of all sets of vectors of complex numbers that can be written as the set of all values taken on by some mapping, i.e., sets of the

form  $\{[f_1(x_1, \dots, x_n), \dots, f_m(x_1, \dots, x_n)] \mid x_i \in S_i\}$  for some complex-valued functions  $f_j$  and some sets  $S_1, \dots, S_n$  of complex numbers.

Sets of this type are used by `solve` to express solutions of systems of equations like

$\{[k\pi, z] \mid k \in \mathbb{Z}, z \in \mathbb{C}\}$ .

### Element Creation

`solvelib::VectorImageSet(v, x, S)` represents the set of all vectors that can be obtained by substituting some element of  $S$  for  $x$  in the vector  $v$ .

`souvelib::VectorImageSet(v, [x1, ...], [S1, ...])` represents the set of all values that can be obtained by substituting, for each  $i$ , the identifier  $x_i$  by some element of  $S_i$  in the vector  $v$ .

## Superdomain

`Dom::ImageSet`

## Categories

`Cat::Set`

## Examples

### Example 1

We create a set of two-dimensional vectors:

```
S:= Dom::ImageSet([k*PI, k*I*PI], k, Z_)
```

$$\left\{ \begin{pmatrix} \pi k \\ \pi k i \end{pmatrix} \mid k \in \mathbb{Z} \right\}$$

Since this is a set of vectors, a `souvelib::VectorImageSet` is created automatically:

```
type(S)
```

`DomImageSet`

Set-theoretic operations (union, intersection, set difference) may be applied to  $S$ :

```
S intersect {[0, 0], [1, 1]}, S minus S
```

`{[0, 0]}, ∅`



delete S:

## Parameters

**v**

List or matrix

**x**

Identifier or indexed identifier

**S**

Set of any type



# stats - Statistics

---

## stats::betaCDF

Cumulative distribution function of the beta distribution

### Syntax

```
stats::betaCDF(a, b)
```

### Description

`stats::betaCDF(a, b)` returns a procedure representing the cumulative distribution function

$$x \rightarrow \begin{cases} 0 & \text{if } x \leq 0 \\ \frac{1}{\beta(a, b)} \int_0^x t^{a-1} (1-t)^{b-1} dt & \text{if } 0 < x \wedge x < 1 \\ 1 & \text{if } x \geq 1 \end{cases}$$

of the beta distribution with shape parameters  $a > 0$ ,  $b > 0$ .

The procedure `f := stats::betaCDF(a, b)` can be called in the form `f(x)` with an arithmetical expression  $x$ . The return value of `f(x)` is either a floating-point number or a symbolic expression:

- If  $x$  can be converted to a real floating-point number and  $a$  and  $b$  can be converted to positive floating-point numbers, then the return value `f(x)` is a floating-point number.
- For numerical values  $x \leq 0$  and  $x \geq 1$ , the floating-point numbers `0.0`, respectively `1.0`, are returned even if  $a$  and  $b$  are symbolic quantities.
- The call `f(-infinity)` returns `0.0`; the call `f(infinity)` return `1.0`.
- In all other cases, `f(x)` returns the symbolic call `stats::betaCDF(a, b)(x)`.

Numerical values of  $a$  and  $b$  are only accepted if they are positive.

## Environment Interactions

The function is sensitive to the environment variable DIGITS which determines the numerical working precision.

## Examples

### Example 1

We evaluate the cumulative distribution function with  $a = 5$  and  $b = 7$  at various points:

```
f := stats::betaCDF(5, 7):
f(-infinity), f(-PI), f(1/sqrt(10)), f(0.75), f(1), f(infinity)
```

```
0.0, 0.0, 0.247351489, 0.9924387932, 1.0, 1.0
```

Nonpositive numerical values of  $a$  or  $b$  lead to an error:

```
stats::betaCDF(-5, 7)(0.75)
```

```
Error: First shape parameter must be positive. [stats::betaCDF]
```

```
Error:
the first shape parameter must be positive [stats::betaCDF]
```

```
delete f:
```

### Example 2

For symbolic arguments, symbolic calls of `stats::betaCDF` are returned, unless  $x \leq 0$  or  $x \geq 1$  can be decided:

```
f := stats::betaCDF(a, b):
f(-2), f(0), f(1/3), f(0.4), f(1), f(PI), f(x)
```

```
0.0, 0.0, stats::betaCDF(a, b)(1/3), stats::betaCDF(a, b)(0.4), 1.0, 1.0,
```

```
stats::betaCDF(a, b)(x)
```

When positive real numbers are assigned to  $a$  and  $b$ , the call  $f(x)$  returns a floating-point number if  $x$  is numerical:

```
a := 2: b := PI:  
f(-2), f(1/3), f(0.4), f(PI)  
  
0.0, 0.4272662874, 0.5465772418, 1.0
```

```
delete f, a, b:
```

## Parameters

**a, b**

The shape parameters of the beta distribution: arithmetical expressions (Symbolic Math Toolbox) representing positive real values.

## Return Values

procedure on page 1-1654.

## See Also

### MuPAD Functions

stats::betaPDF | stats::betaQuantile | stats::betaRandom

# stats::betaPDF

Probability density function of the beta distribution

## Syntax

`stats::betaPDF(a, b)`

## Description

`stats::betaPDF(a, b)` returns a procedure representing the probability density function

$$x \rightarrow \begin{cases} \frac{x^{a-1} (1-x)^{b-1}}{\beta(a, b)} & \text{if } x > 0 \wedge x < 1 \\ 0 & \text{if } x \leq 0 \vee x \geq 1 \end{cases}$$

of the beta distribution with shape parameters  $a > 0$  and  $b > 0$

The procedure `f := stats::betaPDF(a, b)` can be called in the form `f(x)` with an arithmetical expression `x`. The return value of `f(x)` is either a floating-point number or a symbolic expression:

- If `x` is a real floating-point number and `a` and `b` can be converted to positive floating-point numbers, then `f(x)` returns a floating-point number.
- If `0 < x < 1` can be decided, the expression `x^(a-1)*(1-x)^(b-1)/beta(a, b)` is returned. If `x ≤ 0` or `x ≥ 1` can be decided, then `0`, respectively `0.0`, is returned.
- The calls `f(-infinity)` and `f(infinity)` return `0`.
- In all other cases, `f(x)` returns the symbolic call `stats::betaPDF(a, b)(x)`.

Numerical values of `a` and `b` are only accepted if they are positive.

## Environment Interactions

The function is sensitive to the environment variable `DIGITS` which determines the numerical working precision. The procedure returned by `stats::betaPDF` reacts to properties of its argument.

### Examples

#### Example 1

We evaluate the probability density function with  $a = 3$  and  $b = 4$  at various points:

```
f := stats::betaPDF(3, 4):  
f(-infinity), f(-1), f(1/2), f(0.7), f(infinity)
```

0, 0,  $\frac{15}{8}$ , 0.7938, 0

```
delete f:
```

#### Example 2

If  $x$  is a symbolic object without properties, then it cannot be decided whether  $0 < x < 1$  holds. A symbolic function call is returned:

```
f := stats::betaPDF(a, b): f(x)
```

$\text{stats::betaPDF}(a, b)(x)$

With suitable properties, an explicit expression is returned:

```
assume(0 < x < 1): f(x)
```

$$\frac{x^{a-1} (1-x)^{b-1}}{\beta(a, b)}$$

```
assume(x > 1): f(x)
```



0

`unassume(x): delete f:`

## Parameters

**a, b**

The shape parameters of the beta distribution: arithmetical expressions (Symbolic Math Toolbox) representing positive real values.

## Return Values

procedure on page 1-1654.

## See Also

### MuPAD Functions

`stats::betaCDF | stats::betaQuantile | stats::betaRandom`

## stats::betaQuantile

Quantile function of the beta distribution

### Syntax

```
stats::betaQuantile(a, b)
```

### Description

`stats::betaQuantile(a, b)` returns a procedure representing the quantile function (inverse) of the cumulative distribution function `stats::betaCDF(a, b)`. For  $0 \leq x \leq 1$ , the solution of `stats::betaCDF(a, b)(y) = x` is given by  $y = \text{stats::betaQuantile}(a, b)(x)$ .

The procedure `f := stats::betaQuantile(a, b)` can be called in the form `f(x)` with an arithmetical expression `x`. The return value of `f(x)` is either a floating-point number, or a symbolic expression:

- If `a` and `b` can be converted to positive floating-point numbers and `x` is a real number between 0 and 1, then the return value `f(x)` is a floating-point number between 0.0 and 1.0 approximating the real solution `y` of `stats::betaCDF(a, b)(y) = x`.
- `f(0)`, `f(0.0)`, `f(1)`, and `f(1.0)` produce 0, 0.0, 1, and 1.0, respectively, for all values of `a` and `b`.
- In all other cases, `f(x)` returns the symbolic call `stats::betaQuantile(a, b)(x)`.

Numerical values of `a` and `b` are only accepted if they are positive.

### Environment Interactions

The function is sensitive to the environment variable `DIGITS` which determines the numerical working precision.

## Examples

### Example 1

We evaluate the quantile function with  $a = \pi$  and  $b = 11$  at the point  $x = \frac{9}{10}$ :

```
f := stats::betaQuantile(PI, 11): f(9/10)
```

```
0.368643722
```

The value  $f(x)$  satisfies  $\text{stats::betaCDF}(\pi, 11)(f(x)) = x$ :

```
stats::betaCDF(PI, 11)(f(0.98765))
```

```
0.98765
```

```
delete f:
```

### Example 2

For symbolic arguments, symbolic calls are returned:

```
f := stats::betaQuantile(a, b): f(x), f(0.9)
```

```
stats::betaQuantile(a, b)(x), stats::betaQuantile(a, b)(0.9)
```

If  $a, b$  evaluate to real numbers and  $x$  to a real number between 0 and 1, then the call  $f(x)$  produces a float:

```
a := 17: b := 6: f(0.9)
```

```
0.8499783131
```

Numerical values for  $x$  are only accepted if  $0 \leq x \leq 1$ :

```
f(2)
```

Error: Argument x must be between 0 and 1. [f]

delete f, a, b:

## Parameters

**a, b**

The shape parameters of the beta distribution: arithmetical expressions (Symbolic Math Toolbox) representing positive real values.

## Return Values

procedure on page 1-1654.

## See Also

### **MuPAD Functions**

stats::betaCDF | stats::betaPDF | stats::betaRandom

## stats::betaRandom

Generate a random number generator for beta deviates

### Syntax

```
stats::betaRandom(a, b, <Seed = n>)
```

### Description

`stats::betaRandom(a, b)` returns a procedure that produces beta on page 30-2 deviates (random numbers) with shape parameters  $a > 0$ ,  $b > 0$ .

The procedure `f := stats::betaRandom(a, b)` can be called in the form `f()`. The return value of `f()` is either a floating-point number or a symbolic expression:

- If `a` and `b` can be converted to positive floating-point numbers, then `f()` returns a random floating-point number between `0.0` and `1.0`.
- In all other cases, `f()` return the symbolic call `stats::betaRandom(a, b)()`.

Numerical values of `a` and `b` are only accepted if they are positive.

The values  $X = f()$  are distributed randomly according to the beta distribution with parameters `a` and `b`. For any  $0 \leq x \leq 1$ , the probability that  $X \leq x$  is given by

$$\frac{1}{\beta(a, b)} \int_0^x t^{a-1} (1-t)^{b-1} dt$$

Without the option `Seed = n`, an initial seed is chosen internally. This initial seed is set to a default value when MuPAD is started. Thus, each time MuPAD is started or re-initialized with the `reset` function, random generators produce the same sequences of numbers.

---

**Note** In contrast to the function `random`, the generators produced by `stats::betaRandom` do not react to the environment variable `SEED`.

---

For efficiency, it is recommended to produce sequences of  $K$  random numbers via

```
f := stats::betaRandom(a, b): f() $ k = 1..K;
```

rather than by

```
stats::betaRandom(a, b)() $ k = 1..K;
```

The latter call produces a sequence of generators each of which is called once. Also note that

```
stats::betaRandom(a, b, Seed = n)() $ k = 1..K;
```

does not produce a random sequence, because a sequence of freshly initialized generators would be created each of them producing the same number.

## Environment Interactions

The function is sensitive to the environment variable `DIGITS` which determines the numerical working precision.

## Examples

### Example 1

We generate beta deviates with parameters  $a = 2$  and  $b = \frac{3}{4}$ :

```
f := stats::betaRandom(2, 3/4): f() $ k = 1..4
```

```
0.9454511844, 0.8615078721, 0.121495159, 0.379420364
```

```
delete f:
```

### Example 2

With symbolic parameters, no random floating-point numbers can be produced:

```
f := stats::betaRandom(a, b): f()
```

```
stats::betaRandom(a, b)()
```

When a and b evaluate to positive real numbers, the generator starts to produce random numbers:

```
a := 1: b := 2: f() $ k = 1..4
```

```
0.1700845647, 0.1490672548, 0.6022714953, 0.2217977725
```

```
delete f, a, b:
```

### Example 3

We use the option Seed = s to reproduce a sequence of random numbers:

```
f := stats::betaRandom(1, 3, Seed = 1): f() $ k = 1..4
```

```
0.07584461034, 0.6146360615, 0.2188856232, 0.1020817554
```

```
g := stats::betaRandom(1, 3, Seed = 1): g() $ k = 1..4
```

```
0.07584461034, 0.6146360615, 0.2188856232, 0.1020817554
```

```
f() = g(), f() = g()
```

```
0.3303369551 = 0.3303369551, 0.1975445744 = 0.1975445744
```

```
delete f, g:
```

## Parameters

**a, b**

The shape parameters of the beta distribution on page 30-2: arithmetical expressions (Symbolic Math Toolbox) representing positive real values.

## Options

### Seed

Option, specified as `Seed = n`

Initializes the random generator with the integer seed  $n$ .  $n$  can also be the option `CurrentTime`, to make the seed depend on the current time.

This option serves for generating generators that return predictable sequences of pseudo-random numbers. The generator is initialized with the seed  $n$  which may be an arbitrary integer. Several generators with the same initial seed produce the same sequence of numbers.

When this option is used, the shape parameters  $a$  and  $b$  must be convertible to positive floating-point numbers at the time when the random generator is generated.

## Return Values

procedure on page 1-1654.

## Algorithms

The implemented algorithm for the computation of the beta deviates uses gamma on page 30-236 deviates  $x$ ,  $y$  to produce a beta deviate  $x/(x + y)$ . For more information see: D. Knuth, *Seminumerical Algorithms* (1998), Vol. 2, p. 134.

## See Also

### MuPAD Functions

`stats::betaCDF` | `stats::betaPDF` | `stats::betaQuantile`



## stats::binomialCDF

The (discrete) cumulative distribution function of the binomial distribution

### Syntax

```
stats::binomialCDF(n, p)
```

### Description

stats::binomialCDF(n, p) returns a procedure representing the (discrete) cumulative distribution function

$$x \rightarrow \begin{cases} 0 & \text{if } x < 0 \\ \sum_{i=0}^{\lfloor x \rfloor} \binom{n}{i} p^i (1-p)^{n-i} & \text{if } x \geq 0 \wedge x < 1 \\ 1 & \text{if } x \geq 1 \end{cases}$$

of the binomial distribution with “trial parameter”  $n$  and “probability parameter”  $p$ .

The procedure `f := stats::binomialCDF(n, p)` can be called in the form `f(x)` with an arithmetical expression  $x$ . The return value of `f(x)` is either a floating-point number, an exact numerical value, or a symbolic expression:

- If  $x$  is a numerical real value and  $n$  is a positive integer, then an explicit value is returned. If  $p$  is a numerical value satisfying  $0 \leq p \wedge p \leq 1$ , this is a numerical value. Otherwise, it is a symbolic expression in  $p$ .
- If  $x$  is a numerical value with  $x < 0$ , then  $0$ , respectively  $0.0$ , is returned for any value of  $n$  and  $p$ .
- For symbolic values of  $n$ , explicit results are returned if  $x$  is a numerical value with  $x < 2$ .
- For symbolic values of  $n$ , explicit results are returned if  $n - x$  is a numerical value with  $n - x \leq 2$ .

- If  $n - x$  is a numerical value with  $n - x \leq 0$ , then 1, respectively  $1.0$ , is returned for any value of  $n$  and  $p$ .
- In all other cases,  $f(x)$  returns the symbolic call `binomialCDF(n, p)(x)`.

Numerical values for  $n$  are only accepted if they are positive integers.

Numerical values for  $p$  are only accepted if they satisfy  $0 \leq p \leq 1$ .

If  $x$  is a real floating-point number, the result is a floating number provided  $n$  and  $p$  are numerical values. If  $x$  is an exact numerical value, the result is an exact number.

---

**Note** Note that for large  $n$ , floating-point results are computed much faster than exact results. If floating-point approximations are desired, pass a floating-point number  $x$  to the procedure generated by `stats::binomialCDF!`

---

## Environment Interactions

The function is sensitive to the environment variable `DIGITS` which determines the numerical working precision.

## Examples

### Example 1

We evaluate the distribution function with  $n = 20$  and  $p = \frac{3}{4}$  at various points:

```
f := stats::binomialCDF(5, 3/4):  
f(-1), f(2), f(PI), f(5), f(6)
```

$0, \frac{53}{512}, \frac{47}{128}, 1, 1$

```
f(-1.2), f(2.0), f(float(PI)), f(5.5)
```

$0.0, 0.103515625, 0.3671875, 1.0$

```
delete f:
```

## Example 2

We use symbolic arguments:

```
f := stats::binomialCDF(n, p): f(x), f(8), f(8.0)
```

```
stats::binomialCDF(n, p)(x), stats::binomialCDF(n, p)(8), stats::binomialCDF(n, p)(8.0)
```

When numerical values are assigned to  $n$  and  $p$ , the function  $f$  starts to produce explicit results if the argument is numerical:

```
n := 3: p := 1/3:
f(2), f(2.5), f(PI +1), f(4.0)
```

```
 $\frac{26}{27}$ , 0.962962963, 1, 1.0
```

```
delete f, n, p:
```

## Example 3

If  $n$  and  $x$  are numerical, symbolic expressions are returned for symbolic values of  $p$ :

```
f := stats::binomialCDF(3, p):
f(-1), f(0), f(3/2), f(1 + sqrt(3)), f(2.999), f(3)
```

```
0,  $-(p-1)^3$ ,  $3 p (p-1)^2 - (p-1)^3$ ,  $1 - p^3$ ,  $1.0 - 1.0 p^3$ , 1
```

```
delete f:
```

## Parameters

**n**

The “trial parameter”: an arithmetical expression (Symbolic Math Toolbox) representing a positive integer

**p**

The “probability parameter”: an arithmetical expression (Symbolic Math Toolbox) representing a real number  $0 \leq p \leq 1$ .

## **Return Values**

procedure on page 1-1654.

## **See Also**

### **MuPAD Functions**

`stats::binomialPF` | `stats::binomialQuantile` | `stats::binomialRandom`

# stats::binomialPF

Probability function of the binomial distribution

## Syntax

```
stats::binomialPF(n, p)
```

## Description

stats::binomialPF(n, p) returns a procedure representing the probability function

$$x \rightarrow \binom{n}{x} p^x (1-p)^{n-x}$$

for  $x=0, 1, \dots, n$  of the binomial distribution with “trial parameter”  $n$  and “probability parameter”  $p$ .

The procedure `f := stats::binomialPF(n, p)` can be called in the form `f(x)` with arithmetical expressions  $x$ . The return value of `f(x)` is either a floating-point number, an exact numerical value, or a symbolic expression:

- If  $x$  is a non-integer numerical value, `f(x)` returns `0` or `0.0`, respectively.
- If  $x$  is an integer or the floating point equivalent of an integer and  $n$  is a positive integer, then an explicit value is returned. If  $p$  is a numerical value satisfying  $0 \leq p \leq 1$ , this is a numerical value. Otherwise, it is a symbolic expression in `p`.

For symbolic values of  $n$ , explicit results are returned if  $x$  is a numerical value with  $x < 2$ .

- For symbolic values of  $n$ , explicit results are returned if  $n - x$  is a numerical value with  $n - x < 2$ .
- In all other cases, `f(x)` returns the symbolic call `stats::binomialPF(n, p)(x)`.

Numerical values for  $n$  are only accepted if they are positive integers.

Numerical values for  $p$  are only accepted if they satisfy  $0 \leq p \leq 1$ .

If  $x$  is a floating-point number, the result is a floating number provided  $n$  and  $p$  are numerical values. If  $x$  is an exact value, the result is an exact number.

Note that for large  $n$ , floating-point results are computed much faster than exact results. If floating-point approximations are desired, pass a floating-point number  $x$  to the procedure created by `stats::binomialPF`.

## Environment Interactions

The function is sensitive to the environment variable `DIGITS` which determines the numerical working precision.

## Examples

### Example 1

We compute the probability function with  $n = 3$  and  $p = \frac{3}{4}$  at various points:

```
f := stats::binomialPF(3, 3/4):  
f(-1/2), f(0), f(1/2), f(1), f(7/4), f(2), f(3), f(4)
```

```
0, 1/64, 0, 9/64, 0, 27/64, 27/64, 0
```

```
f(-0.2), f(0.0), f(0.7), f(1.0), f(2.0), f(2.7), f(3.0), f(4.0)
```

```
0.0, 0.015625, 0.0, 0.140625, 0.421875, 0.0, 0.421875, 0.0
```

```
delete f:
```

### Example 2

We use symbolic arguments:

```
f := stats::binomialPF(n, p): f(x), f(8), f(8.0)
```

```
stats::binomialPF(n, p)(x), stats::binomialPF(n, p)(8), stats::binomialPF(n, p)(8.0)
```

When real numbers are assigned to  $n$  and  $p$ , the function  $f$  starts to produce explicit results if the argument is numerical:

```
n := 3: p := 1/3:
f(0), f(1), f(2.0), f(3.5), f(4)
```

```
 $\frac{8}{27}, \frac{4}{9}, 0.2222222222, 0.0, 0$ 
```

```
delete f, n, p, x:
```

### Example 3

If  $n$  and  $x$  are numerical, symbolic expressions are returned for symbolic values of  $p$ :

```
f := stats::binomialPF(3, p):
f(-1), f(0), f(3/2), f(2), f(3)
```

```
 $0, -(p-1)^3, 0, -3 p^2 (p-1), p^3$ 
```

```
delete f:
```

## Parameters

### **n**

The “trial parameter”: an arithmetical expression (Symbolic Math Toolbox) representing a positive integer

### **p**

The “probability parameter”: an arithmetical expression (Symbolic Math Toolbox) representing a real number  $0 \leq p \leq 1$ .

## **Return Values**

procedure on page 1-1654.

## **See Also**

### **MuPAD Functions**

`stats::binomialCDF` | `stats::binomialQuantile` | `stats::binomialRandom`



# stats::binomialQuantile

Quantile function of the binomial distribution

## Syntax

```
stats::binomialQuantile(n, p)
```

## Description

`stats::binomialQuantile(n, p)` returns a procedure representing the quantile function (discrete inverse) of the cumulative distribution function `stats::binomialCDF(n, p)`. For  $0 \leq x \leq 1$ , the quantile value  $k = \text{stats::binomialQuantile}(n, p)(x)$  satisfies

$$\text{stats::binomialCDF}(n, p)(k-1) < x \wedge x \leq \text{stats::binomialCDF}(n, p)(k)$$

The procedure `f := stats::binomialQuantile(n, p)` can be called in the form `f(x)` with arithmetical expressions  $x$ . The return value of `f(x)` is either a natural number between 0 and  $n$ , or a symbolic expression:

- If  $n$  is a positive integer,  $p$  a real number satisfying  $0 \leq p \leq 1$ , and  $x$  a real number satisfying  $0 \leq x \leq 1$ , then `f(x)` returns an integer between 0 and  $n$ .
- If  $p = 0$ , then `f(x)` returns 0 for any values of  $n$  and  $x$ .
- If  $p = 1$ , then `f(x)` returns  $n$  for any values of  $n$  and  $x$ .
- For  $p \neq 1$ , the call `f(0)` returns 0 for any value of  $n$ .
- For  $p \neq 0$ , the call `f(1)` returns  $n$  for any value of  $n$ .
- In all other cases, `f(x)` returns the symbolic call `stats::binomialQuantile(n, p)(x)`.

Numerical values for  $n$  are only accepted if they are positive integers.

Numerical values for  $p$  are only accepted if they satisfy  $0 \leq p \leq 1$ .

If floating-point arguments are passed to the quantile function `f`, the result is computed with floating-point arithmetic. This is faster than using exact arithmetic, but the result is

subject to internal round-off errors. In particular, round-off may be significant for arguments  $x$  close to 1. Cf. “Example 3” on page 30-25 (Symbolic Math Toolbox).

## Environment Interactions

The function is sensitive to the environment variable DIGITS which determines the numerical working precision.

## Examples

### Example 1

We evaluate the quantile function with  $n = 30$  and  $p = \frac{1}{3}$  at some points:

```
f := stats::binomialQuantile(30, 1/3):  
f(0), f((2/3)^30), f(PI/10), f(0.5), f(1 - 1/10^10)
```

```
0, 0, 9, 10, 27
```

The quantile value  $f(x)$  satisfies

```
stats::binomialCDF(n, p)(f(x) - 1) < x & x ≤ stats::binomialCDF(n, p)(f(x)) :
```

```
x := 0.7: f(x)
```

```
11
```

```
stats::binomialCDF(30, 1/3)(float(f(x) - 1)), x,  
stats::binomialCDF(30, 1/3)(float(f(x)))
```

```
0.5847595988, 0.7, 0.7238643653
```

```
delete f, x:
```

## Example 2

We use symbolic arguments:

```
f := stats::binomialQuantile(n, p): f(x), f(9/10)
```

$$\text{stats::binomialQuantile}(n, p)(x), \text{stats::binomialQuantile}(n, p)\left(\frac{9}{10}\right)$$

When  $n$  and  $p$  evaluate to suitable numbers, the function  $f$  starts to produce quantile values:

```
n := 80: p := 1/10:
f(1/2), f(999/1000), f(1 - 1/10^10), f(1 - 1/10^80)
```

$$8, 17, 29, 79$$

```
delete f, n, p:
```

## Example 3

If floating-point arguments are passed to the quantile function, the result is computed with floating-point arithmetic. This is faster than using exact arithmetic, but the result is subject to internal round-off errors:

```
f := stats::binomialQuantile(1000, 1/30):
f(1 - 1/10^16) <> f(float(1 - 1/10^16))
```

$$89 \neq 88$$

```
delete f:
```

## Parameters

**n**

The “trial parameter”: an arithmetical expression (Symbolic Math Toolbox) representing a positive integer

**p**

The “probability parameter”: an arithmetical expression (Symbolic Math Toolbox) representing a real number  $0 \leq p \leq 1$ .

## Return Values

procedure on page 1-1654.

## See Also

### MuPAD Functions

`stats::binomialCDF` | `stats::binomialPF` | `stats::binomialRandom`

# stats::binomialRandom

Generate a random number generator for binomial deviates

## Syntax

```
stats::binomialRandom(n, p, <Seed = s>)
```

## Description

`stats::binomialRandom(n, p)` returns a procedure that produces binomial on page 30-15-deviates (random numbers) with trial parameter  $n$  and probability parameter  $p$ .

The procedure `f := stats::binomialRandom(n, p)` can be called in the form `f()`. The return value of `f()` is an integer between 0 and  $n$  or a symbolic expression:

- If  $n$  is a positive integer and  $p$  is a real value satisfying  $0 \leq p \leq 1$ , then `f()` returns an integer between 0 and  $n$ .
- If  $p = 0$  or  $p = 0.0$ , then `f()` returns 0 for any value of  $n$ .
- If  $p = 1$  or  $p = 1.0$ , then `f()` returns  $n$  for any value of  $n$ .

In all other cases, `f()` return the symbolic call `stats::binomialRandom(n, p)()`.

Numerical values for  $n$  are only accepted if they are positive integers.

Numerical values for  $p$  are only accepted if they satisfy  $0 \leq p \leq 1$ .

The values  $X = f()$  are distributed randomly according to the binomial distribution with trial parameter  $n$  and probability parameter  $p$ . For any  $x \in [0, 1]$ , the probability of  $X \leq x$  is given by

$$\sum_{i=0}^{\lfloor x \rfloor} \binom{n}{i} p^i (1-p)^{n-i}$$

Without the option `Seed = s`, an initial seed is chosen internally. This initial seed is set to a default value when MuPAD is started. Thus, each time MuPAD is started or re-initialized with the `reset` function, random generators produce the same sequences of numbers.

---

**Note** With this option, the parameters `n` and `p` must evaluate to suitable numerical values at the time, when the generator is created.

---

---

**Note** In contrast to the function `random`, the generators produced by `stats::binomialRandom` do not react to the environment variable `SEED`.

---

For efficiency, it is recommended to produce sequences of  $K$  random numbers via

```
f := stats::binomialRandom(n, p): f() $k = 1..K;
```

rather than by

```
stats::binomialRandom(n, p)() $k = 1..K;
```

The latter call produces a sequence of generators each of which is called once. Also note that

```
stats::binomialRandom(n, p, Seed = s)() $k = 1..K;
```

does not produce a random sequence, because a sequence of freshly initialized generators would be created each of them producing the same number.

## Environment Interactions

The function is sensitive to the environment variable `DIGITS` which determines the numerical working precision.

## Examples

### Example 1

We generate binomial deviates with parameters  $n = 80$  and  $p = \frac{1}{7}$ :

```
f := stats::binomialRandom(80, 1/7): f() $ k = 1..10
```

```
9, 9, 16, 11, 8, 5, 11, 13, 14, 12
```

```
delete f:
```

## Example 2

With symbolic parameters, no random numbers can be produced:

```
f := stats::binomialRandom(n, p): f()
```

```
stats::binomialRandom(n, p)()
```

When  $n$  and  $p$  evaluate to suitable numbers, the generator starts to produce random numbers:

```
n := 200: p := 1/PI: f() $ k= 1..10
```

```
79, 69, 69, 64, 77, 70, 80, 66, 62, 69
```

```
delete f, n, p:
```

## Example 3

We use the option `Seed = s` to reproduce a sequence of random numbers:

```
f := stats::binomialRandom(70, 7/8, Seed = 1): f() $ k = 1..10
```

```
63, 65, 60, 65, 60, 57, 58, 63, 57, 61
```

```
g := stats::binomialRandom(70, 7/8, Seed = 1): g() $ k = 1..10
```

```
63, 65, 60, 65, 60, 57, 58, 63, 57, 61
```

```
f() = g(), f() = g()
```

61 = 61, 63 = 63

delete f, g:

## Parameters

**n**

The “trial parameter”: an arithmetical expression (Symbolic Math Toolbox) representing a positive integer

**p**

The “probability parameter”: an arithmetical expression (Symbolic Math Toolbox) representing a real number  $0 \leq p \leq 1$ .

## Options

**Seed**

Option, specified as `Seed = s`

Initializes the random generator with the integer seed `s`. `s` can also be the option `CurrentTime`, to make the seed depend on the current time.

This option serves for generating generators that return predictable sequences of pseudo-random numbers. The generator is initialized with the seed `s` which may be an arbitrary integer. Several generators with the same initial seed produce the same sequence of numbers.

When this option is used, the parameters `n` and `p` must be numerical values at the time when the random generator is generated.

## Return Values

procedure on page 1-1654.



## See Also

### MuPAD Functions

stats::binomialCDF | stats::binomialPF | stats::binomialQuantile

## stats::calc

Apply functions to a sample

### Syntax

```
stats::calc(s, c, f1, f2, ...)
```

```
stats::calc(s, [c1, c2, ...], f1, f2, ...)
```

### Description

`stats::calc` applies functions to columns of the sample `s`.

In a call such as `stats::calc(s, c, f1)` the function `f1` is applied to the elements of the column `c` of `s`. This generates a new column which is appended to `s`. If present, the next function `f2` is applied to the new sample etc. Thus, a call of `stats::calc` with `m` functions appends `m` new columns to `s`.

Each function must accept exactly one parameter.

In a call such as `stats::calc(s, [c1, c2, ...], f1)` the *i*-th element of the new column is given by `f1(si, c1, si, c2, ...)`.

Each function must accept as many parameters as specified by the second argument of `stats::calc`.

### Examples

#### Example 1

We create a sample of three rows and three columns:

```
stats::sample([[1, a1, b1], [2, a2, b2], [3, a3, b3]])
```

```
1 a1 b1
```

```
2 a2 b2
3 a3 b3
```

We add and multiply the elements of the columns 2 and 3 by applying the system functions `_plus` and `_mult`:

```
stats::calc(%, [2, 3], _plus, _mult)
```

```
1 a1 b1 a1 + b1 a1*b1
2 a2 b2 a2 + b2 a2*b2
3 a3 b3 a3 + b3 a3*b3
```

The following call maps each element of the second column of the original sample to its fourth power:

```
stats::calc(%2, 2, x -> x^4)
```

```
1 a1 b1 a1^4
2 a2 b2 a2^4
3 a3 b3 a3^4
```

The following call computes the mean values of the rows of the last sample:

```
stats::calc(%, [1, 2, 3, 4],
             (x1, x2, x3, x4) -> (x1 + x2 + x3 + x4)/4)
```

```
1 a1 b1 a1^4 a1^4/4 + a1/4 + b1/4 + 1/4
2 a2 b2 a2^4 a2^4/4 + a2/4 + b2/4 + 1/2
3 a3 b3 a3^4 a3^4/4 + a3/4 + b3/4 + 3/4
```

The same is achieved by the following call:

```
stats::calc(%2, [1, 2, 3, 4], stats::mean)
```

```
1 a1 b1 a1^4 a1^4/4 + a1/4 + b1/4 + 1/4
2 a2 b2 a2^4 a2^4/4 + a2/4 + b2/4 + 1/2
3 a3 b3 a3^4 a3^4/4 + a3/4 + b3/4 + 3/4
```

## Parameters

**s**

A sample of domain type `stats::sample`

**c, c<sub>1</sub>, c<sub>2</sub>, ...**

Positive integers representing column indices of the sample

**f<sub>1</sub>, f<sub>2</sub>, ...**

Procedures

## Return Values

Sample of domain type `stats::sample`.

## See Also

**MuPAD Functions**  
`stats::tabulate`

## stats::cauchyCDF

Cumulative distribution function of the Cauchy distribution

### Syntax

```
stats::cauchyCDF(a, b)
```

### Description

`stats::cauchyCDF(a, b)` returns a procedure representing the cumulative distribution function

$$x \rightarrow \frac{1}{\pi} \arctan\left(\frac{x-a}{b}\right) + \frac{1}{2}$$

of the Cauchy distribution with median  $a$  and scale parameter  $b > 0$ .

The procedure `f := stats::cauchyCDF(a, b)` can be called in the form `f(x)` with arithmetical expressions  $x$ . The return value of `f(x)` is either a floating-point number or a symbolic expression:

- If  $x$  is a floating-point number and  $a$  and  $b$  can be converted to suitable floating-point numbers, then `f(x)` returns a floating-point number.
- In all other cases, the symbolic expression  $\arctan((x - a)/b)/\text{PI} + 1/2$  is returned.

Numerical values of  $a$  and  $b$  are only accepted if they are real and  $b$  is positive.

### Environment Interactions

The function is sensitive to the environment variable `DIGITS` which determines the numerical working precision.

## Examples

### Example 1

We evaluate the cumulative distribution function with  $a = 2$  and  $b = \frac{3}{4}$  at various points:

```
f := stats::cauchyCDF(2, 3/4):
f(-infinity), f(-10), f(0.8), f(2), f(10.0^4), f(infinity)
```

$$0, \frac{1}{2} - \frac{\arctan(16)}{\pi}, 0.1778076845, \frac{1}{2}, 0.999976122, 1$$

```
delete f, x:
```

### Example 2

We use symbolic arguments:

```
f := stats::cauchyCDF(a, b):
f(x), f(sqrt(2)), f(0.9)
```

$$\frac{1}{2} - \frac{\arctan\left(\frac{a-x}{b}\right)}{\pi}, \frac{1}{2} - \frac{\arctan\left(\frac{a-\sqrt{2}}{b}\right)}{\pi}, \frac{1}{2} - \frac{\arctan\left(\frac{a-0.9}{b}\right)}{\pi}$$

When numbers are assigned to  $a$  and  $b$ , the function  $f$  starts to produce corresponding numerical values:

```
a := PI:
b := 1/8:
f(sqrt(2)), f(0.9)
```

$$\frac{1}{2} - \frac{\arctan(8\pi - 8\sqrt{2})}{\pi}, 0.01773184344$$

## Parameters

**a**

The median: an arithmetical expression (Symbolic Math Toolbox) representing a real value

**b**

The scale parameter: an arithmetical expression representing a positive real value

## Return Values

procedure on page 1-1654.

## See Also

### **MuPAD Functions**

stats::cauchyPDF | stats::cauchyQuantile | stats::cauchyRandom

## stats::cauchyPDF

Probability density function of the Cauchy distribution

### Syntax

```
stats::cauchyPDF(a, b)
```

### Description

`stats::cauchyPDF(a, b)` returns a procedure representing the probability density function

$$x \rightarrow \frac{b}{\pi} \frac{1}{(x-a)^2 + b^2}$$

of the Cauchy distribution with median  $a$  and scale parameter  $b > 0$ .

The procedure `f := stats::cauchyPDF(a, b)` can be called in the form `f(x)` with arithmetical expressions  $x$ . The return value of `f(x)` is either a floating-point number or a symbolic expression:

- If  $x$  is a floating-point number and  $a$  and  $b$  can be converted to suitable floating-point numbers, then `f(x)` returns a floating-point number.
- In all other cases, the symbolic expression  $b/\pi * 1/((x-a)^2 + b^2)$  is returned.

Numerical values of  $a$  and  $b$  are only accepted if they are real and  $b$  is positive.

### Environment Interactions

The function is sensitive to the environment variable `DIGITS` which determines the numerical working precision.



## Examples

### Example 1

We calculate the Cauchy density with  $a = 2$  and  $b = \frac{3}{4}$  at various points:

```
f := stats::cauchyPDF(2, 3/4):
f(-infinity), f(9/10), f(0.9), f(2), f(infinity)
```

$$0, \frac{300}{709 \pi}, 0.1346868348, \frac{4}{3 \pi}, 0$$

```
delete f:
```

### Example 2

We use symbolic arguments:

```
f := stats::cauchyPDF(a, b):
f(x), f(2), f(2.0)
```

$$\frac{b}{\pi (b^2 + (a-x)^2)}, \frac{b}{\pi ((a-2)^2 + b^2)}, \frac{b}{\pi ((a-2.0)^2 + b^2)}$$

When  $a$  and  $b$  evaluate to numbers, the function  $f$  starts to produce numerical values:

```
a := PI:
b := 1/8:
f(2), f(2.0)
```

$$\frac{1}{8 \pi ((\pi - 2)^2 + \frac{1}{64})}, 0.03016906448$$

```
delete f, a, b:
```

## Parameters

**a**

The median: an arithmetical expression (Symbolic Math Toolbox) representing a real value

**b**

The scale parameter: an arithmetical expression (Symbolic Math Toolbox) representing a positive real value

## Return Values

procedure on page 1-1654.

## See Also

### **MuPAD Functions**

`stats::cauchyCDF` | `stats::cauchyQuantile` | `stats::cauchyRandom`

# stats::cauchyQuantile

Quantile function of the Cauchy distribution

## Syntax

```
stats::cauchyQuantile(a, b)
```

## Description

`stats::cauchyQuantile(a, b)` returns a procedure representing the quantile function (inverse) of the cumulative distribution function `stats::cauchyCDF(a, b)`: for  $0 \leq x \leq 1$ , the solution of  $stats::cauchyCDF(a, b)(y) = x$  is given by  $y = stats::cauchyQuantile(a, b)(x)$ .

The procedure `f := stats::cauchyQuantile(a, b)` can be called in the form `f(x)` with arithmetical expressions `x`. The return value of `f(x)` is either a floating-point number,  $\pm\infty$  or a symbolic expression:

If `x` is a floating-point number between 0 and 1 and `a` and `b` can be converted to suitable floating-point numbers, then `f(x)` returns a floating-point number approximating the real solution `y` of  $stats::cauchyCDF(a, b)(y) = x$ .

For any value of `a` and `b`, the calls `f(0)` and `f(0.0)` produce  $-\infty$ . The calls `f(1)` and `f(1.0)` produce *infinity*.

In all other cases, the symbolic expression `a + b*tan(PI*(x - 1/2))` is returned.

Numerical values of `a` and `b` are only accepted, if they are real and `b` is positive.

## Environment Interactions

The function is sensitive to the environment variable `DIGITS` which determines the numerical working precision.

## Examples

### Example 1

We evaluate the quantile function with  $a = 2$  and  $b = \frac{3}{4}$  at various points:

```
f := stats::cauchyQuantile(2, 3/4):  
f(0), f(4/5), f(0.8), f(1)
```

$$-\infty, \frac{3\sqrt{5}\sqrt{2\sqrt{5}+5}}{20} + 2, 3.03228644, \infty$$

```
delete f:
```

### Example 2

We use symbolic arguments:

```
f := stats::cauchyQuantile(a, b):  
f(0), f(x), f(1/sqrt(2)), f(0.9), f(1)
```

$$-\infty, a + b \tan\left(\pi\left(x - \frac{1}{2}\right)\right), a + b \tan\left(\pi\left(\frac{\sqrt{2}}{2} - \frac{1}{2}\right)\right), a + b \tan(0.4\pi), \infty$$

When numbers are assigned to  $a$  and  $b$ , the function  $f$  starts to produce numerical values when called with arguments between 0 and 1:

```
a := PI: b := 1/8:  
f(0), f(1/sqrt(2)), f(0.9), f(1)
```

$$-\infty, \pi + \frac{\tan\left(\pi\left(\frac{\sqrt{2}}{2} - \frac{1}{2}\right)\right)}{8}, 3.526303096, \infty$$

## Parameters

**a**

The median: an arithmetical expression (Symbolic Math Toolbox) representing a real value

**b**

The scale parameter: an arithmetical expression (Symbolic Math Toolbox) representing a positive real value

## Return Values

procedure on page 1-1654.

## See Also

### MuPAD Functions

stats::cauchyCDF | stats::cauchyPDF | stats::cauchyRandom

## stats::cauchyRandom

Generate a random number generator for Cauchy deviates

### Syntax

```
stats::cauchyRandom(a, b, <Seed = n>)
```

### Description

`stats::cauchyRandom(a, b)` returns a procedure that produces Cauchy on page 30-35 deviates (random numbers) with median  $a$  and scale parameter  $b > 0$ .

The procedure `f := stats::cauchyRandom(a, b)` can be called in the form `f()`. The return value of `f()` is either a floating-point number or a symbolic expression:

If  $a$  can be converted to a real floating point number and  $b$  to a positive real floating point number, then `f()` returns a real floating point number.

In all other cases, `f()` returns the symbolic call `stats::cauchyRandom(a, b)()`.

Numerical values of  $a$  and  $b$  are only accepted, if they are real and  $b$  is positive.

The values  $X = f()$  are distributed randomly according to the the Cauchy distribution with parameters  $a$  and  $b$ . For any real  $x$ , the probability that  $X \leq x$  is given by

$$\frac{1}{\pi} \arctan\left(\frac{x-a}{b}\right) + \frac{1}{2}.$$

Without the option `Seed = n`, an initial seed is chosen internally. This initial seed is set to a default value when MuPAD is started. Thus, each time MuPAD is started or re-initialized with the `reset` function, random generators produce the same sequences of numbers.

---

**Note** In contrast to the function `random`, the generators produced by `stats::cauchyRandom` do not react to the environment variable `SEED`.

---

For efficiency, it is recommended to produce sequences of  $K$  random numbers via

```
f := stats::cauchyRandom(a, b): f() $ k = 1..K;
```

rather than by

```
stats::cauchyRandom(a, b)() $k = 1..K;
```

The latter call produces a sequence of generators each of which is called once. Also note that

```
stats::cauchyRandom(a, b, Seed = n)() $ k = 1..K;
```

does not produce a random sequence, because a sequence of freshly initialized generators would be created each of them producing the same number.

## Environment Interactions

The function is sensitive to the environment variable `DIGITS` which determines the numerical working precision.

## Examples

### Example 1

We generate Cauchy deviates with parameters  $a = 2$  and  $b = \frac{3}{4}$ :

```
f := stats::cauchyRandom(2, 3/4): f() $ k = 1..4
```

```
1.340284406, 3.277664042, 0.5634392829, 48.01912393
```

```
delete f:
```

### Example 2

With symbolic parameters, no random floating-point numbers can be produced:

```
f := stats::cauchyRandom(a, b): f()
```

```
stats::cauchyRandom(a, b)()
```

When  $a$  and  $b$  evaluate to suitable real numbers, the generator starts to produce random numbers:

```
a := -PI: b := 1/2: f() $ k = 1..4
```

```
-3.592915903, -3.928568815, -3.217434162, -2.82696038
```

```
delete f, a, b:
```

### Example 3

We use the option `Seed = n` to reproduce a sequence of random numbers:

```
f := stats::cauchyRandom(PI, 3, Seed = 1): f() $ k = 1..4
```

```
3.786179405, 7.050017894, -4.775376375, -1.791650747
```

```
g := stats::cauchyRandom(PI, 3, Seed = 1): g() $ k = 1..4
```

```
3.786179405, 7.050017894, -4.775376375, -1.791650747
```

```
f() = g(), f() = g()
```

```
8.362838563 = 8.362838563, -302.9342996 = -302.9342996
```

```
delete f, g:
```

## Parameters

**a**

The median: an arithmetical expression (Symbolic Math Toolbox) representing a real value



**b**

The scale parameter: an arithmetical expression (Symbolic Math Toolbox) representing a positive real value

## Options

### Seed

Option, specified as `Seed = n`

Initializes the random generator with the integer seed `n`. `n` can also be the option `CurrentTime`, to make the seed depend on the current time.

This option serves for generating generators that return predictable sequences of pseudo-random numbers. The generator is initialized with the seed `n` which may be an arbitrary integer. Several generators with the same initial seed produce the same sequence of numbers.

When this option is used, the parameters `a` and `b` must be convertible to suitable floating-point numbers at the time when the random generator is generated.

## Return Values

procedure on page 1-1654.

## Algorithms

The implemented algorithm for the computation of the Cauchy deviates uses the quantile function of the Cauchy distribution applied to uniformly distributed random numbers between 0 and 1.

## See Also

### MuPAD Functions

`stats::cauchyCDF` | `stats::cauchyPDF` | `stats::cauchyQuantile`

# stats::chisquareCDF

Cumulative distribution function of the chi-square distribution

## Syntax

```
stats::chisquareCDF(m)
```

## Description

`stats::chisquareCDF(m)` returns a procedure representing the cumulative distribution function

$$x \rightarrow \begin{cases} \int_0^x \frac{t^{\frac{m}{2}-1} e^{-\frac{t}{2}}}{2^{m/2} \Gamma(\frac{m}{2})} dt & \text{if } x > 0 \\ 0 & \text{if } x \leq 0 \end{cases}$$

of the chi-square distribution with mean  $m > 0$ .

The procedure `f := stats::chisquareCDF(m)` can be called in the form `f(x)` with an arithmetical expression  $x$ . The return value of `f(x)` is either a floating-point number or a symbolic expression:

If  $x \leq 0$  can be decided, then `f(x)` returns 0. If  $x > 0$  can be decided, then `f(x)` returns

$$\text{the value } 1 - \frac{\Gamma(\frac{m}{2}, \frac{x}{2})}{\Gamma(\frac{m}{2})}.$$

If  $x$  is a floating-point number and  $m$  can be converted to a positive floating-point number, then these values are returned as floating-point numbers. Otherwise, symbolic expressions are returned.

The function `f` reacts to properties of identifiers set via `assume`. If  $x$  is a symbolic expression with the property  $x \leq 0$  or  $x \geq 0$ , the corresponding values are returned.

$f(x)$  returns the symbolic call `stats::chisquareCDF(m)(x)` if neither  $x \leq 0$  nor  $x > 0$  can be decided.

Numerical values for  $m$  are only accepted if they are real and positive.

Note that, for large  $m$ , exact results may be costly to compute. If floating-point values are desired, it is recommended to pass floating-point arguments  $x$  to  $f$  rather than to compute exact results  $f(x)$  and convert them via `float`. Cf. "Example 4" on page 30-52 (Symbolic Math Toolbox).

## Environment Interactions

The function is sensitive to the environment variable `DIGITS` which determines the numerical working precision.

## Examples

### Example 1

We evaluate the cumulative distribution function with mean  $m = 2$  at various points:

```
f := stats::chisquareCDF(2):  
f(-infinity), f(-3), f(1/2), f(0.5), f(PI), f(infinity)
```

```
0, 0, 1 - e-1/4, 0.2211992169, 1 - e-π/2, 1
```

```
delete f:
```

### Example 2

If  $x$  is a symbolic object without properties, then it cannot be decided whether  $x \geq 0$  holds. A symbolic function call is returned:

```
f := stats::chisquareCDF(m):  
f(x)
```

```
stats::chisquareCDF(m)(x)
```

With suitable properties, it can be decided whether  $x \geq 0$  holds. An explicit expression is returned:

```
assume(0 <= x):
f(x)
```

$$1 - \frac{\Gamma\left(\frac{m}{2}, \frac{x}{2}\right)}{\Gamma\left(\frac{m}{2}\right)}$$

For integer values of  $m$ , the special function `igamma` can be expressed in terms of more elementary functions:

```
m := 6:
f(x)
```

$$1 - \frac{e^{-\frac{x}{2}} \left(\frac{x^2}{4} + x + 2\right)}{2}$$

```
m := 5:
f(x)
```

$$1 - \frac{4 \left( \frac{3 \sqrt{\pi} \operatorname{erfc}\left(\sqrt{\frac{x}{2}}\right)}{4} + e^{-\frac{x}{2}} \left( \frac{3 \sqrt{\frac{x}{2}}}{2} + \left(\frac{x}{2}\right)^{3/2} \right) \right)}{3 \sqrt{\pi}}$$

```
unassume(x): delete f, m:
```

### Example 3

We use a symbolic mean  $m$ :

```
f := stats::chisquareCDF(m):
f(3), f(3.0)
```

$$1 - \frac{\Gamma(\frac{m}{2}, \frac{3}{2})}{\Gamma(\frac{m}{2})}, 1.0 - \frac{1.0 \Gamma(0.5 m, 1.5)}{\Gamma(0.5 m)}$$

When a numerical value is assigned to  $m$ , the function  $f$  starts to produce numerical values:

```
m := PI:  
f(3), f(3.0)
```

$$1 - \frac{\Gamma(\frac{\pi}{2}, \frac{3}{2})}{\Gamma(\frac{\pi}{2})}, 0.5840678031$$

```
delete f, m:
```

## Example 4

We consider a chi-square distribution with large mean  $m = 1000$ :

```
f := stats::chisquareCDF(1000):
```

For floating-point approximations, one should not compute an exact result and convert it via `float`. For large mean  $m$ , it is faster to pass a floating-point argument to  $f$ . The following call takes some time, because an exact computation of the huge integer  $\text{gamma}(m/2) = \text{gamma}(500) = 499!$  is involved:

```
float(f(1023))
```

0.7003071959

The following call is much faster:

```
f(float(1023))
```

0.7003071959

```
delete f:
```

## Parameters

**m**

The mean: an arithmetical expression (Symbolic Math Toolbox) representing a positive real value

## Return Values

procedure on page 1-1654.

## See Also

### **MuPAD Functions**

gamma | igamma | stats::chisquarePDF | stats::chisquareQuantile | stats::chisquareRandom

## stats::chisquarePDF

Probability density function of the chi-square distribution

### Syntax

```
stats::chisquarePDF(m)
```

### Description

stats::chisquarePDF(m) returns a procedure representing the probability density function

$$x \rightarrow \begin{cases} \frac{x^{\frac{m}{2}-1} e^{-\frac{x}{2}}}{2^{m/2} \Gamma(\frac{m}{2})} & \text{if } x > 0 \\ 0 & \text{if } x \leq 0 \end{cases}$$

of the chi-square distribution with mean  $m > 0$ .

The procedure `f := stats::chisquarePDF(m)` can be called in the form `f(x)` with an arithmetical expression  $x$ . The return value of `f(x)` is either a floating-point number or a symbolic expression:

If  $x \leq 0$  can be decided, then `f(x)` returns 0. If  $x > 0$  can be decided, then `f(x)` returns

$$\text{the value } \frac{x^{\frac{m}{2}-1} e^{-\frac{x}{2}}}{2^{m/2} \Gamma(\frac{m}{2})}.$$

If  $x$  is a floating-point number and  $m$  can be converted to a positive floating-point number, then these values are returned as floating-point numbers. Otherwise, symbolic expressions are returned.



The function `f` reacts to properties of identifiers set via `assume`. If  $x$  is a symbolic expression with the property  $x \leq 0$  or  $x \geq 0$ , the corresponding values are returned.

`f(x)` returns the symbolic call `stats::chisquarePDF(m)(x)` if neither  $x \leq 0$  nor  $x > 0$  can be decided,

Numerical values of  $m$  are only accepted if they are positive.

Note that, for large  $m$ , exact results may be costly to compute. If floating-point values are desired, it is recommended to pass floating-point arguments  $x$  to `f` rather than to compute exact results `f(x)` and convert them via `float`. Cf. “Example 4” on page 30-56 (Symbolic Math Toolbox).

## Environment Interactions

The function is sensitive to the environment variable `DIGITS` which determines the numerical working precision.

## Examples

### Example 1

We evaluate the probability density function with  $m = 2$  at various points:

```
f := stats::chisquarePDF(2):
f(-infinity), f(-PI), f(1/2), f(0.5), f(PI), f(infinity)
```

$$0, 0, \frac{e^{-\frac{1}{4}}}{2}, 0.3894003915, \frac{e^{-\frac{\pi}{2}}}{2}, 0$$

```
delete f:
```

### Example 2

If  $x$  is a symbolic object without properties, then it cannot be decided whether  $x \geq 0$  holds. A symbolic function call is returned:

```
f := stats::chisquarePDF(m): f(x)
```

```
stats::chisquarePDF(m)(x)
```

With suitable properties, it can be decided whether  $x \geq 0$  holds. An explicit expression is returned:

```
assume(0 <= x): f(x)
```

$$\frac{x^{\frac{m}{2}-1} e^{-\frac{x}{2}}}{2^{m/2} \Gamma(\frac{m}{2})}$$

```
unassume(x): delete f:
```

### Example 3

We use symbolic a symbolic mean m:

```
f := stats::chisquarePDF(m): f(x)
```

```
stats::chisquarePDF(m)(x)
```

When a numerical value is assigned to m, the function f starts to produce numerical values:

```
m := PI: f(3), f(3.0)
```

$$\frac{3^{\frac{\pi}{2}-1} e^{-\frac{3}{2}}}{2^{\pi/2} \Gamma(\frac{\pi}{2})}, 0.1578981008$$

```
delete f, m:
```

### Example 4

We consider a chi-square distribution with large mean  $m = 1000$ :

```
f := stats::chisquarePDF(1000):
```

For floating-point approximations, one should not compute an exact result and convert it via `float`. For large mean  $m$ , it is faster to pass a floating-point argument to `f`. The following call takes some time, because an exact computation of the huge integer  $\text{gamma}(m/2) = \text{gamma}(500) = 499!$  is involved:

```
float(f(1023))
```

```
0.00765380452
```

The following call is much faster:

```
f(float(1023))
```

```
0.00765380452
```

```
delete f:
```

## Parameters

**m**

The mean: an arithmetical expression (Symbolic Math Toolbox) representing a positive real value

## Return Values

procedure on page 1-1654.

## See Also

### MuPAD Functions

`gamma` | `stats::chisquareCDF` | `stats::chisquareQuantile` |  
`stats::chisquareRandom`

## stats::chisquareQuantile

Quantile function of the chi-square distribution

### Syntax

```
stats::chisquareQuantile(m)
```

### Description

`stats::chisquareQuantile(m)` returns a procedure representing the quantile function (inverse) of the cumulative distribution function `stats::chisquareCDF(m)`. For  $0 \leq x \leq 1$ , the solution of  $stats::chisquareCDF(m)(y) = x$  is given by  $y = stats::chisquareQuantile(m)(x)$ .

The procedure `f := stats::chisquareQuantile(m)` can be called in the form `f(x)` with an arithmetical expression `x`. The return value of `f(x)` is either a floating-point number, *infinity*, or a symbolic expression:

If `x` is a real number between 0 and 1 and `m` can be converted to a positive floating-point number, then `f(x)` returns a positive floating-point number approximating the solution `y` of  $stats::chisquareCDF(m)(y) = x$ .

The calls `f(0)` and `f(0.0)` produce `0.0` for all values of `m`.

The calls `f(1)` and `f(1.0)` produce *infinity* for all values of `m`.

In all other cases, `f(x)` returns the symbolic call `stats::chisquareQuantile(m)(x)`.

Numerical values of `m` are only accepted if they are real and positive.

### Environment Interactions

The function is sensitive to the environment variable `DIGITS` which determines the numerical working precision.

## Examples

### Example 1

We evaluate the quantile function with  $m = \pi$  at various points:

```
f := stats::chisquareQuantile(PI):
f(0), f(1/10), f(0.5), f(1 - 10^(-10)), f(1)
```

```
0.0, 0.6469867417, 2.505845123, 50.00263604, ∞
```

The value  $f(x)$  satisfies  $\text{stats::chisquareCDF}(PI)(f(x)) = x$ :

Der Wert  $f(x)$  erfüllt  $\text{stats::chisquareCDF}(PI)(f(x)) = x$ :

```
stats::chisquareCDF(PI)(f(0.987654))
```

```
0.987654
```

```
delete f:
```

### Example 2

We use symbolic arguments:

```
f := stats::chisquareQuantile(m): f(x), f(9/10)
```

```
stats::chisquareQuantile(m)(x), stats::chisquareQuantile(m)( $\frac{9}{10}$ )
```

When a positive real value is assigned to  $m$ , the function  $f$  starts to produce floating-point values:

```
m := PI + 1: f(0.999), f(1 - sqrt(2)/10^5)
```

```
18.76468483, 28.07485542
```

Numerical values for  $x$  are only accepted if  $0 \leq x \leq 1$ :

```
f(2)
```

```
Error: Argument x must be between 0 and 1. [f]
```

```
delete f, m:
```

## Parameters

**m**

The mean: an arithmetical expression (Symbolic Math Toolbox) representing a positive real value

## Return Values

procedure on page 1-1654.

## See Also

### MuPAD Functions

`stats::chisquareCDF` | `stats::chisquarePDF` | `stats::chisquareRandom`

# stats::chisquareRandom

Generate a random number generator for chi-square deviates

## Syntax

stats::chisquareRandom(m, <Seed = n>)

## Description

stats::chisquareRandom(m) returns a procedure that produces chi-square on page 30-49 deviates (random numbers) with mean  $m > 0$ .

The procedure  $f := \text{stats::chisquareRandom}(m)$  can be called in the form  $f()$ . The return value of  $f()$  is either a floating-point number or a symbolic expression:

If  $m$  can be converted to a positive floating point number, then  $f()$  returns a nonnegative floating point number.

In all other cases, stats::chisquareRandom(m)() is returned symbolically.

A numerical value of  $m$  is only accepted if it is positive.

The values  $X = f()$  are distributed randomly according to the cumulative distribution function of the chi-square distribution with mean  $m$ . For any  $x \geq 0$ , the probability that  $X \leq x$  is given by

$$\frac{1}{\Gamma\left(\frac{m}{2}\right) 2^{m/2}} \int_0^x t^{\frac{m}{2}-1} e^{-\frac{t}{2}} dt$$

Without the option Seed = n, an initial seed is chosen internally. This initial seed is set to a default value when MuPAD is started. Thus, each time MuPAD is started or re-initialized with the reset function, random generators produce the same sequences of numbers.

---

**Note** In contrast to the function `random`, the generators produced by `stats::chisquareRandom` do not react to the environment variable `SEED`.

---

For efficiency, it is recommended to produce sequences of  $K$  random numbers via

```
f := stats::chisquareRandom(m): f() $k = 1..K;
```

rather than by

```
stats::chisquareRandom(m)() $k = 1..K;
```

The latter call produces a sequence of generators each of which is called once. Also note that

```
stats::chisquareRandom(m, Seed = n)() $k = 1..K;
```

does not produce a random sequence, because a sequence of freshly initialized generators would be created each of them producing the same number.

## Environment Interactions

The function is sensitive to the environment variable `DIGITS` which determines the numerical working precision.

## Examples

### Example 1

We generate chi-square deviates with mean  $m = 12$ :

```
f := stats::chisquareRandom(12): f() $ k = 1..4
```

```
17.54103319, 13.4630887, 17.34866815, 4.820644436
```

```
delete f:
```



## Example 2

With symbolic parameters, no random floating-point numbers can be produced:

```
f := stats::chisquareRandom(m): f()
```

```
stats::chisquareRandom(m)()
```

When  $m$  evaluates to a positive real number, the generator starts to produce random numbers:

```
m := PI: f() $ k = 1..4
```

```
1.557180623, 0.3840766601, 0.5560473903, 3.185747198
```

```
delete f, m:
```

## Example 3

We use the option `Seed = n` to reproduce a sequence of random numbers:

```
f := stats::chisquareRandom(70, Seed = 1): f() $ k = 1..4
```

```
55.24812677, 78.10283482, 68.16283459, 80.01866787
```

```
g := stats::chisquareRandom(70, Seed = 1): g() $ k = 1..4
```

```
55.24812677, 78.10283482, 68.16283459, 80.01866787
```

```
f() = g(), f() = g()
```

```
94.28358259 = 94.28358259, 57.54456 = 57.54456
```

```
delete f, g:
```

## Parameters

**m**

The mean: an arithmetical expression (Symbolic Math Toolbox) representing a positive real value

## Options

### Seed

Option, specified as `Seed = n`

Initializes the random generator with the integer seed `n`. `n` can also be the option `CurrentTime`, to make the seed depend on the current time.

This option serves for generating generators that return predictable sequences of pseudo-random numbers. The generator is initialized with the seed `n` which may be an arbitrary integer. Several generators with the same initial seed produce the same sequence of numbers.

When this option is used, the mean `m` must be convertible to a positive floating-point number at the time when the random generator is generated.

## Return Values

procedure on page 1-1654.

## Algorithms

The implemented algorithm for the computation of the chi-square deviates uses a gamma on page 30-236 deviate `x` with shape parameters `m/2` and `2`. For more information see: D. Knuth, *Seminumerical Algorithms* (1998), Vol. 2, p. 135.

## See Also

### MuPAD Functions

[stats::chisquareCDF](#) | [stats::chisquarePDF](#) | [stats::chisquareQuantile](#)

## stats::col

Select and rearrange columns of a sample

### Syntax

```
stats::col(s, c1, <c2, ...>)
```

```
stats::col(s, c1 .. c2, <c3 .. c4, ...>)
```

### Description

`stats::col(s, ...)` creates a new sample from selected columns of the sample `s`.

`stats::col` is useful for selecting columns of interest or for rearranging columns.

The columns of `s` specified by the remaining arguments of `stats::col` are used to build a new sample. The new sample contains the columns of `s` in the order specified by the call to `stats::col`. Columns can be duplicated by specifying the column index more than once.

## Examples

### Example 1

The following sample contains columns for “gender”, “age”, “height”, the “number of yellow socks” and “eye color” of a person:

```
stats::sample([["m", 26, 180, 3, "blue"],  
              ["f", 22, 160, 0, "brown"],  
              ["f", 48, 155, 2, "green"],  
              ["m", 30, 172, 1, "brown"]])
```

```
"m" 26 180 3 "blue"  
"f" 22 160 0 "brown"
```

```
"f" 48 155 2 "green"
"m" 30 172 1 "brown"
```

Since nobody is really interested in the yellow socks, we create a new sample without that column:

```
stats::col(%, 1..3, 5)
```

```
"m" 26 180 "blue"
"f" 22 160 "brown"
"f" 48 155 "green"
"m" 30 172 "brown"
```

We can use `stats::col` to rearrange the sample. As an illustrating example, we duplicate the first column:

```
stats::col(%, 1, 3, 2, 1, 4)
```

```
"m" 180 26 "m" "blue"
"f" 160 22 "f" "brown"
"f" 155 48 "f" "green"
"m" 172 30 "m" "brown"
```

## Parameters

**s**

A sample of domain type `stats::sample`.

**c<sub>1</sub>, c<sub>2</sub>, ...**

Positive integers representing column indices of the sample `s`. A range `c1 .. c2` represents all columns from `c1` through `c2`.

## Return Values

Sample of domain type `stats::sample`.

## See Also

### MuPAD Functions

`stats::concatCol` | `stats::concatRow` | `stats::row`

# stats::concatCol

Concatenate samples column-wise

## Syntax

```
stats::concatCol(s1, s2, <s3, ...>)
```

## Description

`stats::concatCol(s1, s2, ...)` creates a new sample consisting of the columns of the samples `s1`, `s2` etc.

If the samples `s1`, `s2` etc. have different numbers of rows, then the number of rows in the resulting sample is given by the “shortest” sample with the minimal number of rows. Elements below this row in “longer” samples are ignored.

## Examples

### Example 1

We create two samples:

```
s1 := stats::sample([[a1, a2], [b1, b2]]);  
s2 := stats::sample([[a3, a4], [b3, b4]])
```

```
a1 a2  
b1 b2
```

```
a3 a4  
b3 b4
```

Concatenation of the columns yields:

```
stats::concatCol(s1, s2)
```

```
a1 a2 a3 a4  
b1 b2 b3 b4
```

```
delete s1, s2:
```

## Example 2

The following sample contains columns for “gender”, “age” and “height” of a person:

```
stats::sample([["m", 26, 180], ["f", 22, 160],  
              ["f", 48, 155], ["m", 30, 172]])
```

```
"m" 26 180  
"f" 22 160  
"f" 48 155  
"m" 30 172
```

We append a further column “nationality”, specified by a list:

```
stats::concatCol(%, ["German", "French", "Italian",  
                    "British", "German"])
```

```
"m" 26 180 "German"  
"f" 22 160 "French"  
"f" 48 155 "Italian"  
"m" 30 172 "British"
```

## Parameters

$s_1, s_2, \dots$

Samples of domain type `stats::sample`. Alternatively, lists may be entered, which are treated as columns of a sample.

## Return Values

Sample of domain type `stats::sample`.



## See Also

### MuPAD Functions

stats::col | stats::concatRow | stats::row

## stats::concatRow

Concatenate samples row-wise

### Syntax

```
stats::concatRow(s1, s2, <s3, ...>)
```

### Description

`stats::concatRow(s1, s2, ...)` creates a new sample consisting of the rows of the samples `s1`, `s2` etc.

All samples must have the same number of columns.

### Examples

#### Example 1

We create a small sample:

```
stats::sample([[123, g], [442, f]])
```

```
123 g  
442 f
```

A list is concatenated to the sample as a row:

```
stats::concatRow(%, [x, y])
```

```
123 g  
442 f  
  x y
```

## Example 2

The following samples contain columns for “gender” and “age”:

```
s1 := stats::sample(["f", 36], ["m", 25]);  
s2 := stats::sample(["m", 26], ["f", 22])
```

```
"f" 36  
"m" 25
```

```
"m" 26  
"f" 22
```

We build a larger sample:

```
stats::concatRow(s1, s2)
```

```
"f" 36  
"m" 25  
"m" 26  
"f" 22
```

```
delete s1, s2:
```

## Parameters

**s<sub>1</sub>, s<sub>2</sub>, ...**

Samples of domain type `stats::sample`. Alternatively, lists may be entered, which are treated as rows of a sample.

## Return Values

Sample of domain type `stats::sample`.

## See Also

### MuPAD Functions

`stats::col` | `stats::concatCol` | `stats::row`

# stats::correlation

Correlation between data samples

## Syntax

```
stats::correlation([x1, x2, ...], [y1, y2, ...], <BravaisPearson | Fechner>)
```

```
stats::correlation([[x1, y1], [x2, y2], ...], <BravaisPearson | Fechner>)
```

```
stats::correlation(s, <c1, c2>, <BravaisPearson | Fechner>)
```

```
stats::correlation(s, <[c1, c2]>, <BravaisPearson | Fechner>)
```

```
stats::correlation(s1, <c1>, s2, <c2>, <BravaisPearson | Fechner>)
```

## Description

stats::correlation([x<sub>1</sub>, x<sub>2</sub>, ...], [y<sub>1</sub>, y<sub>2</sub>, ...]) returns the linear (Bravais-Pearson) correlation coefficient

$$\frac{\sum_i (x_i(y_i - \bar{y}) - \bar{x}(y_i - \bar{y}))}{\sqrt{(\sum_i (x_i - \bar{x})^2) (\sum_i (y_i - \bar{y})^2)}}$$

where  $\bar{x}$  and  $\bar{y}$  are the means on page 30-346 of the data  $x_i$  and  $y_i$ .

stats::correlation([x<sub>1</sub>, x<sub>2</sub>, ...], [y<sub>1</sub>, y<sub>2</sub>, ...], Fechner) returns the Fechner

correlation  $\frac{2}{n} \left( \sum_{i=1}^n v_i \right) - 1$ , where  $n$  is the sample size. The number  $v_i$  is 1, if  $x_i - \bar{x}$  and  $y_i - \bar{y}$  have the same sign or are both 0. It is  $\frac{1}{2}$ , if either  $x_i - \bar{x}$  or  $y_i - \bar{y}$  is 0. Otherwise,  $v_i = 0$ .

Both the Bravais-Pearson correlation as well as the Fechner correlation are numbers between -1 and 1.

The Bravais-Pearson correlation is close to 1 if the data pairs  $x_i, y_i$  are approximately related by a 'positive' linear relation (i.e.,  $y_i \approx a x_i + b$  with some positive coefficient  $a$ ). It is close to -1 if there is a 'negative' linear relation (with some negative coefficient  $a$ ).

Correlation coefficients close to 0 correspond to non-linear relations or to unrelated data, respectively.

If the input data are floating-point numbers, the sums defining the Bravais-Pearson correlation are computed in a numerically stable way. If a floating-point result is desired, it is recommended to make sure that all input data are floats.

The Fechner correlation is always returned as a rational number.

The column indices  $c_1, c_2$  are optional if the data are given by a `stats::sample` object `s` containing only two non-string data columns. If the data are provided by two samples  $s_1, s_2$ , the column indices are optional for samples containing only one non-string data column.

---

**Note** The Fechner correlation should not be computed for symbolic data. This may lead to unexpected results, if the sign of symbolic parameters cannot be determined.

---

External statistical data stored in an ASCII file can be imported into a MuPAD session via `import::readdata`. In particular, see Example 1 of the corresponding help page on page 13-11.

## Examples

### Example 1

We compute the correlation of samples passed as lists:

```
X := [7, 33/7, 3, 5, 2]: Y := [3, 5, 1, 7, 2]:  
stats::correlation(X, Y)
```

$$\frac{147 \sqrt{26506}}{53012}$$

Alternatively, the data may be passed as a list of data pairs:

```
stats::correlation([[7, 3], [33/7, 5], [3, 1], [5, 7], [2, 2]])
```

$$\frac{147 \sqrt{26506}}{53012}$$

If all data are floating-point numbers, the result is a float:

```
stats::correlation(float(X), float(Y))
```

```
0.4514558056
```

The Fechner correlation of the data is always returned as a rational number:

```
stats::correlation(X, Y, Fechner),
stats::correlation(float(X), float(Y), Fechner)
```

$$\frac{3}{5}, \frac{3}{5}$$

The following exact result indicates an exact linear between the data pairs:

```
stats::correlation([0, 1, 2, 3], [7, 5, 3, 1])
```

```
-1
```

Indeed, there is the 'negative' linear relation  $y = 7 - 2x$  between the data pairs.

```
delete X, Y:
```

## Example 2

We create a sample of type `stats::sample`:

```
s := stats::sample([[1.0, 2.4, 3.0],
                    [7.0, 4.8, 4.0],
                    [3.3, 3.0, 5.0]])
```

```
1.0 2.4 3.0
```

```
7.0 4.8 4.0
3.3 3.0 5.0
```

We compute the correlation between the data of the first and the third column in several equivalent ways:

```
stats::correlation(s, 1, 3),
stats::correlation(s, [1, 3]),
stats::correlation(s, 1, s, 3)
```

```
0.3799015783, 0.3799015783, 0.3799015783
```

```
stats::correlation(s, 1, 3, Fechner),
stats::correlation(s, [1, 3], Fechner),
stats::correlation(s, 1, s, 3, Fechner)
```

```
0, 0, 0
```

```
delete s:
```

### Example 3

With symbolic data, the Bravais-Pearson correlation is returned as a symbolic expression:

```
stats::correlation([x1, x2], [y1, y2])
```

$$\frac{x1 y1 + x2 y2 - 2 \left(\frac{x1}{2} + \frac{x2}{2}\right) \left(\frac{y1}{2} + \frac{y2}{2}\right)}{\sqrt{\left(x1^2 - 2 \left(\frac{x1}{2} + \frac{x2}{2}\right)^2 + x2^2\right) \left(y1^2 - 2 \left(\frac{y1}{2} + \frac{y2}{2}\right)^2 + y2^2\right)}}$$

```
simplify(%)
```

$$\frac{(x1 - x2) (y1 - y2)}{\sqrt{(x1 - x2)^2 (y1 - y2)^2}}$$



## Parameters

$x_1, y_1, x_2, y_2, \dots$

The statistical data: arithmetical expressions (Symbolic Math Toolbox). The number of data  $x_i$  must coincide with the number of data  $y_i$ .

$s, s_1, s_2$

Samples of type stats::sample on page 30-413

$c_1, c_2$

Column indices: positive integers. Column  $c_1$  of  $s$  or  $s_1$ , respectively, provides the data  $x_i$ . Column  $c_2$  of  $s$  or  $s_2$ , respectively, provides the data  $y_i$ .

**mode**

Either BravaisPearson or Fechner. The default is the linear (Bravais-Pearson) correlation.

## Options

**BravaisPearson, Fechner**

Linear (Bravais-Pearson) or Fechner's correlation coefficient. Bravais-Pearson coefficient is the default, but may in some cases where the data is not normally distributed be less useful than Fechner's correlation.

## Return Values

The Bravais-Pearson correlation is returned as an arithmetical expression (Symbolic Math Toolbox). FAIL is returned if the variance of one of the data samples vanishes (the Bravais-Pearson correlation does not exist).

The Fechner correlation is returned as a rational number.

FAIL is returned if the data samples are empty.

## See Also

### **MuPAD Functions**

`stats::correlationMatrix` | `stats::covariance` | `stats::stdev`

### **MuPAD Graphical Primitives**

`plot::Scatterplot`

# stats::correlationMatrix

Compute the correlation matrix associated with a covariance matrix

## Syntax

```
stats::correlationMatrix(cov)
```

## Description

`stats::correlationMatrix(cov)` returns to correlation matrix `cor` of the variance-covariance matrix `cov`. It is given by:

$$\text{cor}_{i,j} = \frac{\text{cov}_{i,j}}{\sqrt{\text{cov}_{i,i}} \sqrt{\text{cov}_{j,j}}}$$

A covariance matrix  $C$  should be positive (semi-)definite and hence satisfies  $|C_{ij}|^2 \leq C_{ii} C_{jj}$  for all indices  $i, j$ . Consequently, the absolute values of the entries of the corresponding correlation matrix do not exceed 1.

With the option `CovarianceMatrix`, the routine `stats::reg` returns the variance-covariance matrix of the fit parameters in a regression analysis. The corresponding correlation matrix of the fit parameters is computed conveniently by applying `stats::correlationMatrix` to this matrix. Cf. “Example 2” on page 30-82 (Symbolic Math Toolbox).

## Examples

### Example 1

We generate a positive definite matrix that may serve as a covariance matrix:

```
A := matrix([[4, -3, 2], [-1, 2, 1], [0, 1, 1]]):
cov := A*linalg::transpose(A)
```

$$\begin{pmatrix} 29 & -8 & -1 \\ -8 & 6 & 3 \\ -1 & 3 & 2 \end{pmatrix}$$

The corresponding correlation matrix is:

```
stats::correlationMatrix(cov)
```

$$\begin{pmatrix} 1 & -\frac{4\sqrt{6}\sqrt{29}}{87} & -\frac{\sqrt{2}\sqrt{29}}{58} \\ -\frac{4\sqrt{6}\sqrt{29}}{87} & 1 & \frac{\sqrt{2}\sqrt{6}}{4} \\ -\frac{\sqrt{2}\sqrt{29}}{58} & \frac{\sqrt{2}\sqrt{6}}{4} & 1 \end{pmatrix}$$

If the input matrix consists of floating-point data, the result is a matrix of floats:

```
stats::correlationMatrix(float(cov))
```

$$\begin{pmatrix} 1.0 & -0.6064784349 & -0.1313064329 \\ -0.6064784349 & 1.0 & 0.8660254038 \\ -0.1313064329 & 0.8660254038 & 1.0 \end{pmatrix}$$

```
delete A, cov:
```

## Example 2

We consider a covariance matrix arising in a non-linear regression problem. The model function  $y = a + b \cos(x - c)$  is to be fit to the following randomized data:

```
r := stats::uniformRandom(-0.1, 0.1):
xdata := [i $i = 1..100]:
ydata := [1 + 2*cos(x - 3) + r() $ x in xdata]:
```

By construction, the variance of the  $y$  values is the variance of the uniformly distributed random data on the interval  $[-0.1, 0.1]$  generated by the random generator  $r$ . This

variance is  $\sigma^2 = \frac{1}{300}$ . We use `stats::reg` to obtain estimates of the fit parameters  $a, b, c$

of the model. Appropriate weights for the regression are given by  $\frac{1}{n} = 300$ . The option `CovarianceMatrix` makes `stats::reg` include the covariance matrix `cov` of the fit parameters in its return list:

```
weights := [300 $ i = 1..100]:
DIGITS:= 4:
[abc, chisquare, cov] :=
  stats::reg(xdata, ydata, weights, a + b*cos(x - c),
            [x], [a, b, c], StartingValues = [1, 2, 3],
            CovarianceMatrix)
```

$$\left[ [1.004, 1.998, 3.0], 107.4, \begin{pmatrix} 0.00003334 & -0.0000003414 & -0.00000006749 \\ -0.0000003414 & 0.00006697 & 0.0000001379 \\ -0.00000006749 & 0.0000001379 & 0.00001663 \end{pmatrix} \right]$$

The correlation matrix of the parameters  $a$ ,  $b$ ,  $c$  is obtained via `stats::correlationMatrix` applied to the covariance matrix `cov` returned by `stats::reg`:

```
stats::correlationMatrix(cov)
```

$$\begin{pmatrix} 1.0 & -0.007226 & -0.002866 \\ -0.007226 & 1.0 & 0.004132 \\ -0.002866 & 0.004132 & 1.0 \end{pmatrix}$$

```
delete r, xdata, ydata, weights, DIGITS, abc, chisquare, cov:
```

## Parameters

### `cov`

The covariance matrix: a square matrix of category `Cat::Matrix`, or an array on page 7-2.

## Return Values

Matrix of the same dimension and type as the input matrix `cov`. `FAIL` is returned if at least one of the diagonal elements of the input matrix `cov` is zero.

## See Also

### MuPAD Functions

`stats::correlation` | `stats::covariance` | `stats::reg` | `stats::stdev`

# stats::covariance

Covariance of data samples

## Syntax

```
stats::covariance([x1, x2, ...], [y1, y2, ...], <Sample | Population>)
```

```
stats::covariance([[x1, y1], [x2, y2], ...], <Sample | Population>)
```

```
stats::covariance(s, <c1, c2>, <Sample | Population>)
```

```
stats::covariance(s, <[c1, c2]>, <Sample | Population>)
```

```
stats::covariance(s1, <c1>, s2, <c2>, <Sample | Population>)
```

## Description

stats::covariance([x<sub>1</sub>, x<sub>2</sub>, ..., x<sub>n</sub>], [y<sub>1</sub>, y<sub>2</sub>, ..., y<sub>n</sub>]) returns the covariance

$$\frac{1}{n-1} \left( \sum_{i=1}^n (x_i - \bar{x}) (y_i - \bar{y}) \right) = \frac{1}{n-1} \left( \sum_{i=1}^n x_i y_i \right) - \frac{n}{n-1} \bar{x} \bar{y}$$

where  $\bar{x}$  and  $\bar{y}$  are the arithmetic means on page 30-346 of the data  $x_i$  and  $y_i$ , respectively.

stats::covariance([x<sub>1</sub>, x<sub>2</sub>, ..., x<sub>n</sub>], [y<sub>1</sub>, y<sub>2</sub>, ..., y<sub>n</sub>], Population) returns

$$\frac{1}{n} \left( \sum_{i=1}^n (x_i - \bar{x}) (y_i - \bar{y}) \right) = \frac{1}{n} \left( \sum_{i=1}^n x_i y_i \right) - \bar{x} \bar{y}$$

If the input data are floating-point numbers, the sums defining the covariance are computed in a numerically stable way. If a floating point result is desired, it is recommended to make sure that all input data are floats.

For exact input data, exact symbolic expressions are returned.

The column indices  $c_1, c_2$  are optional if the data are given by a `stats::sample` object `s` containing only two non-string data columns. If the data are provided by two samples  $s_1, s_2$ , the column indices are optional for samples containing only one non-string data column.

External statistical data stored in an ASCII file can be imported into a MuPAD session via `import::readdata`. In particular, see Example 1 of the corresponding help page on page 13-11.

## Examples

### Example 1

We compute the covariance of samples passed as lists:

```
X := [2, 33/7, 21/9, PI]: Y := [3, 5, 1, 7]:  
stats::covariance(X, Y)
```

$$\pi - \frac{10}{7}$$

Alternatively, the data may be passed as a list of data pairs:

```
stats::covariance([[2, 3], [33/7, 5], [21/9, 1], [PI, 7]])
```

$$\pi - \frac{10}{7}$$

If all data are floating-point numbers, the result is a float:

```
stats::covariance(float(X), float(Y))
```

$$1.713021225$$

```
delete X, Y:
```



## Example 2

We create a sample of type `stats::sample`:

```
s := stats::sample([[1.0, 2.4, 3.0],
                   [7.0, 4.8, 4.0],
                   [3.3, 3.0, 5.0]])
```

```
1.0  2.4  3.0
7.0  4.8  4.0
3.3  3.0  5.0
```

We compute the covariance of the first column and the third column in several equivalent ways:

```
stats::covariance(s, 1, 3),
stats::covariance(s, [1, 3]),
stats::covariance(s, 1, s, 3)
```

```
1.15, 1.15, 1.15
```

```
delete s:
```

## Example 3

The covariance of symbolic data is returned as a symbolic expression:

```
stats::covariance([x1, x2], [y1, y2])
```

$$x1 y1 + x2 y2 - 2 \left( \frac{x1}{2} + \frac{x2}{2} \right) \left( \frac{y1}{2} + \frac{y2}{2} \right)$$

```
expand(%)
```

$$\frac{x1 y1}{2} - \frac{x1 y2}{2} - \frac{x2 y1}{2} + \frac{x2 y2}{2}$$

## Parameters

$x_1, y_1, x_2, y_2, \dots$

The statistical data: arithmetical expressions (Symbolic Math Toolbox). The number of data  $x_i$  must coincide with the number of data  $y_i$ .

$s, s_1, s_2$

Samples of type `stats::sample` on page 30-413

$c_1, c_2$

Column indices: positive integers. Column  $c_1$  of  $s$  or  $s_1$ , respectively, provides the data  $x_i$ . Column  $c_2$  of  $s$  or  $s_2$ , respectively, provides the data  $y_i$ .

## Options

### Sample

The data are regarded as a “sample”, not as a full population. This is the default.

### Population

The data are regarded as the whole population, not as a sample.

## Return Values

arithmetical expression (Symbolic Math Toolbox).

## See Also

### MuPAD Functions

`stats::correlation` | `stats::correlationMatrix` | `stats::stdev`

# stats::cutoff

Discard outliers

## Syntax

```
stats::cutoff([x1, x2, ...],  $\alpha$ )
```

```
stats::cutoff([[x11, x12, ...], [x21, x22, ...], ...],  $\alpha$ , i)
```

```
stats::cutoff(s,  $\alpha$ , i)
```

## Description

`stats::cutoff([x1, x2, ...],  $\alpha$ )` returns those elements of  $[x_1, x_2, \dots]$  larger than the  $\alpha$  quantile and smaller than the  $1 - \alpha$  quantile of this list.

`stats::cutoff([[x11, x12, ...], [x21, x22, ...], ...],  $\alpha$ , i)` and `stats::cutoff(stats::sample([[x11, x12, ...], [x21, x22, ...], ...]),  $\alpha$ , i)` works on the  $i$ -th entries of the input rows.

Measurement data often contains “outliers,” sample points rather far outside the range containing the majority of the points. While expected both from theory and experience, these outliers, for small or medium-sized samples, tend to distort statistical data, such as the mean on page 30-346 value.

One of the standard methods dealing with this problem for (real) continuous scales is discarding the outliers. `stats::cutoff` discards all data points below or above a given quantile.

## Examples

### Example 1

Create a normally distributed sample, slightly contaminated:

```
r := stats::normalRandom(0, 1, Seed=2):  
data := [r() $ i = 1..300, 100*r() $ i = 1..2]:
```

The two extra points distort the data significantly:

```
plot(plot::Histogram2d(data, Cells=20))
```

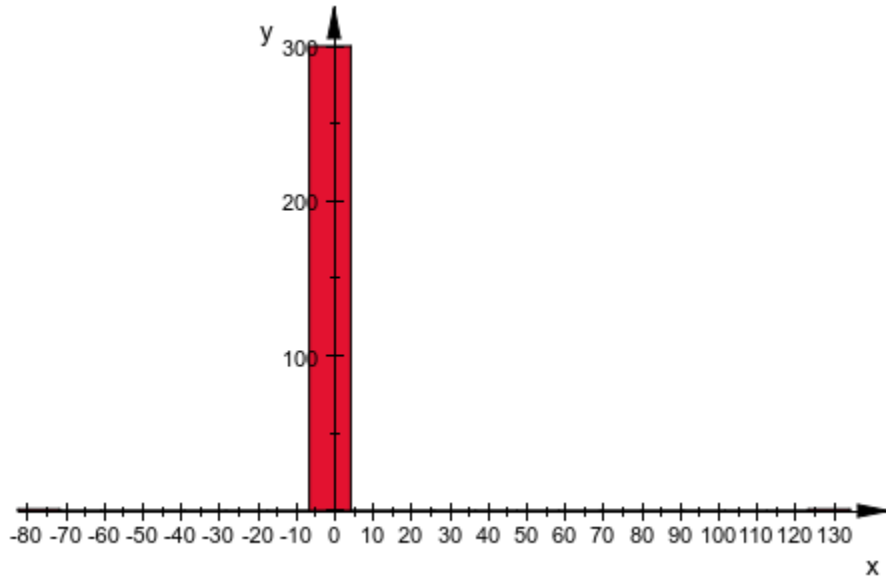

Using `stats::cutoff` removes this noise and the image shows more detail:

```
plot(plot::Histogram2d(stats::cutoff(data, 1/100), Cells=20))
```

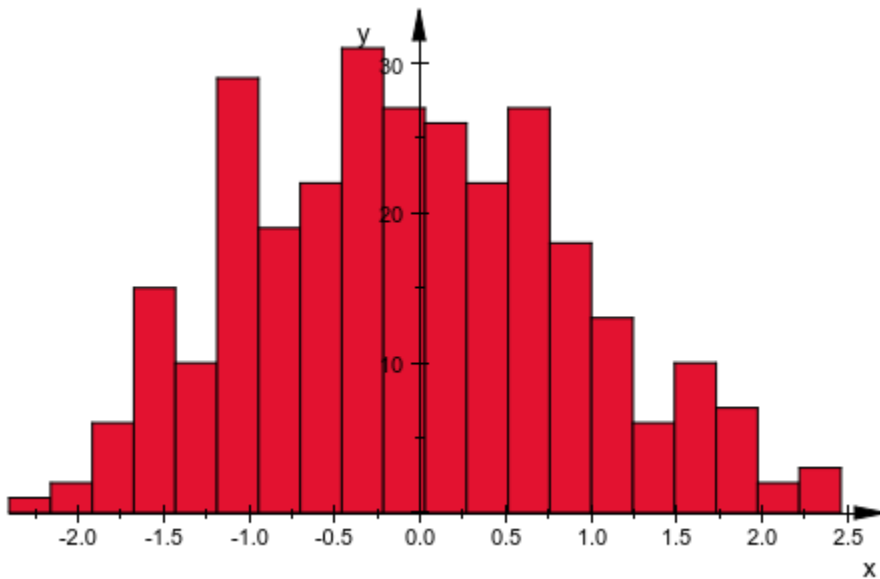

`stats::cutoff` reduces the standard deviation of the sample. Keeping in mind that the standard deviation of the random number generator is 1, compute that of the data in its various forms:

```
stats::stdev(data),
stats::stdev(stats::cutoff(data, 1/20))
```

9.133931298, 0.8142529511

## Parameters

$x_1, x_2, x_{11}, \dots$

Statistical data: arithmetical expressions (Symbolic Math Toolbox). The data to filter on must be real-valued.

**s**

Sample of type `stats::sample`

**$\alpha$** 

Cutoff parameter: a real-valued expression  $0 \leq \alpha \leq \frac{1}{2}$ .

 **$i$** 

Column index: positive integer. The nested list or the sample is filtered on its  $i$ -th column.

## Return Values

The input data with outliers being removed.

## See Also

### MuPAD Functions

`stats::sample` | `stats::winsorize`

## Topics

“Handle Outliers” (Symbolic Math Toolbox)

# stats::winsorize

Clamp (winsorize) extremal values

## Syntax

```
stats::winsorize([x1, x2, ...],  $\alpha$ )
```

```
stats::winsorize([[x11, x12, ...], [x21, x22, ...], ...],  $\alpha$ , i)
```

```
stats::winsorize(s,  $\alpha$ , i)
```

## Description

`stats::winsorize([x1, x2, ...],  $\alpha$ )` returns a copy of  $[x_1, x_2, \dots]$  in which all entries smaller than the  $\alpha$  quantile are replaced by this value and likewise for all entries larger than the  $1 - \alpha$  quantile.

`stats::winsorize([[x11, x12, ...], [x21, x22, ...], ...],  $\alpha$ , i)` and `stats::winsorize(stats::sample([[x11, x12, ...], [x21, x22, ...], ...]),  $\alpha$ , i)` works on the  $i$ -th entries of the input rows.

Measurement data often contains “outliers,” sample points rather far outside the range containing the majority of the points. While expected both from theory and experience, these outliers, for small or medium-sized samples, tend to distort statistical data such as the mean on page 30-346 value.

One of the standard methods dealing with this problem for (real) continuous scales is clamping the outliers. `stats::winsorize` sets all data points below or above a given quantile to these quantiles. This operation is named after its inventor, Charles P. Winsor.

## Examples

### Example 1

Create a normally distributed sample, slightly contaminated:

```
r := stats::normalRandom(0, 1, Seed=2):  
data := [r() $ i = 1..300, 100*r() $ i = 1..2]:
```

The two extra points distort the data significantly:

```
plot(plot::Histogram2d(data, Cells=20))
```

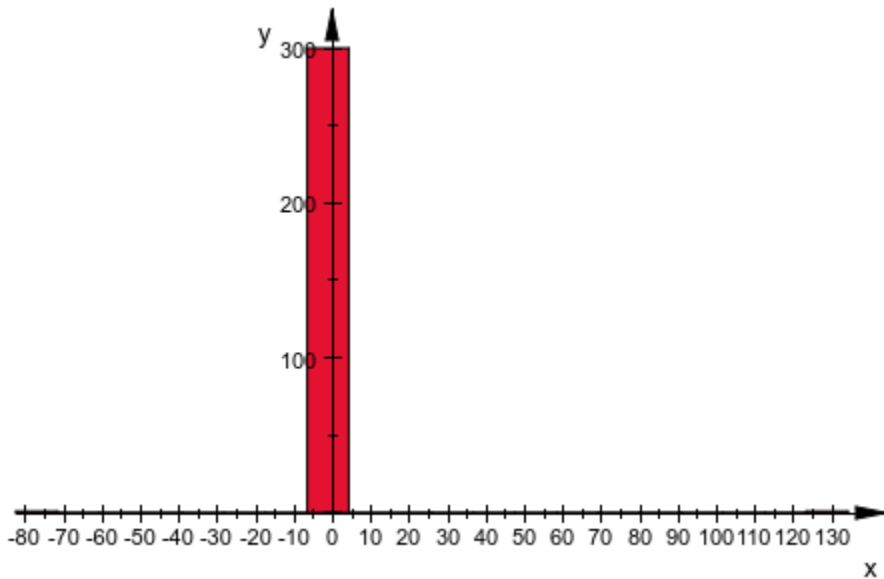

Using either `stats::winsorize` removes this noise and the image shows more detail:

```
plot(plot::Histogram2d(stats::winsorize(data, 1/100), Cells=20))
```



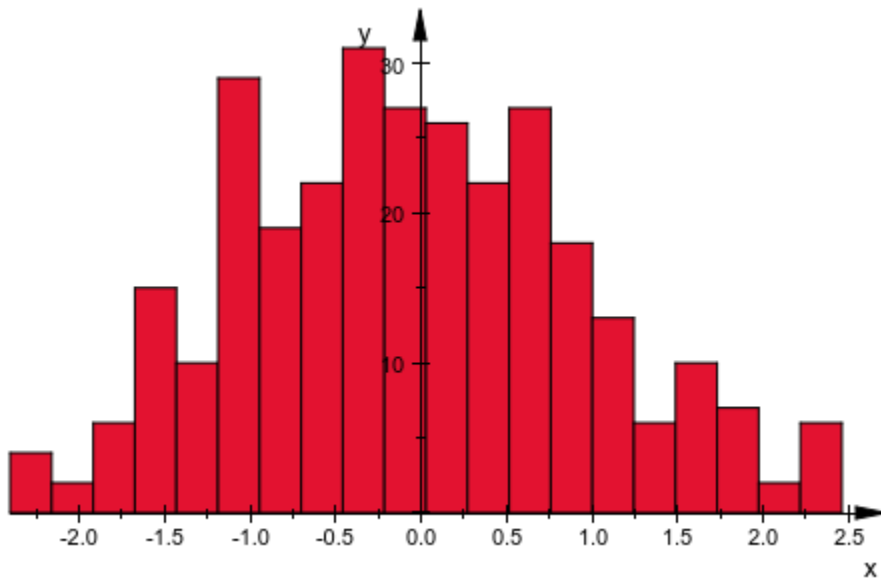

Both `stats::winsorize` reduces the standard deviation of the sample. Keeping in mind that the standard deviation of the random number generator is 1, compute that of the data in its various forms:

```
stats::stdev(data),
stats::stdev(stats::winsorize(data, 1/20))
```

```
9.133931298, 0.9276576788
```

## Parameters

$x_1, x_2, x_{11}, \dots$

Statistical data: arithmetical expressions (Symbolic Math Toolbox). The data to filter on must be real-valued.

**s**

Sample of type `stats::sample`

**$\alpha$** 

Cutoff parameter: a real-valued expression  $0 \leq \alpha \leq \frac{1}{2}$ .

 **$i$** 

Column index: positive integer. The nested list or the sample is winsorized on its  $i$ -th column.

## Return Values

The input data with outliers being replaced by the values of quantiles.

## See Also

### MuPAD Functions

`stats::cutoff` | `stats::sample`

## Topics

“Handle Outliers” (Symbolic Math Toolbox)

# stats::csGOFT

Classical chi-square goodness-of-fit test

## Syntax

```
stats::csGOFT(x1, x2, ..., [[a1, b1], [a2, b2], ...], CDF = f | PDF = f | PF = f)
```

```
stats::csGOFT([x1, x2, ...], [[a1, b1], [a2, b2], ...], CDF = f | PDF = f | PF = f)
```

```
stats::csGOFT(s, <c>, [[a1, b1], [a2, b2], ...], CDF = f | PDF = f | PF = f)
```

## Description

`stats::csGOFT(data, cells, CDF = f)` applies the classical chi-square goodness-of-fit test for the null hypothesis: “the data are  $f$ -distributed”.

The chi-square goodness-of-fit test divides the real line into  $k$  intervals  $c_i = (a_i, b_i]$  ('the cells'). It computes the number of data  $x_j$  falling into the cells  $c_i$  and compares these 'empirical cell frequencies' with the 'expected cell frequencies'  $n p_i$ , where  $n$  is the sample size and  $p_i = Pr(a_i < x \leq b_i)$  are the 'cell probabilities' of a random variable with the hypothesized distribution specified by  $X = f$ .

All data  $x_1, x_2$  etc. must be convertible to real floating-point numbers. The data do not have to be sorted on input: `stats::csGOFT` automatically converts the data to floats and sorts them internally.

External statistical data stored in an ASCII file can be imported into a MuPAD session via `import::readdata`. In particular, see Example 1 of the corresponding help page on page 13-11.

Finite cell boundaries  $a_i, b_i$  must be convertible to real floating-point numbers satisfying  $a_1 < b_1 \leq a_2 < b_2 \leq a_3 < \dots$ . They define *semiopen* intervals  $c_i = (a_i, b_i]$ .

When the hypothesized distribution  $f$  is specified as a cumulative distribution function (CDF =  $f$ ), the left boundary of the first cell and the right boundary of the last cell are ignored. They are replaced by  $-\infty$  and *infinity*, respectively, i.e., the cell partitioning

$$(-\infty, b_1], (a_2, b_2], \dots, (a_{k-1}, b_{k-1}], (a_k, \infty)$$

is used internally.

The cells must be disjoint. Their union must cover the support area of the distribution, i.e., the 'cell probabilities'  $p_i = Pr(a_i < x \leq b_i)$  must add up to 1 for a random variable  $x$  with the hypothesized distribution given by  $f$ . For continuous distributions, adjacent cells with  $b_1 = a_2, b_2 = a_3, \dots$  are appropriate.

You may use  $a_1 = -\infty$  and  $b_k = \infty$  for distributions supported on the entire real line.

---

**Note** The cells must be chosen such that no cell probability  $p_i$  vanishes!

---

See the 'Background' section of this help page for recommendations on the cell partitioning. In particular, the use of equiprobable cells (with constant  $p_i$ ) is recommended. For convenience, a utility function `stats::equiprobableCells` is provided to generate such cells. See "Example 1" on page 30-100 (Symbolic Math Toolbox), "Example 3" on page 30-103 (Symbolic Math Toolbox), and "Example 4" on page 30-106 (Symbolic Math Toolbox).

The distribution the data are tested for is specified by the equation  $X = f$ , where  $X$  is one of the flags CDF, PDF or PF.

For efficiency, it is recommended to specify a cumulative distribution function (CDF =  $f$ ).

The function  $f$  can be a procedure provided by the MuPAD `stats` library. Specifications such as `CDF = stats::normalCDF(m, v)` or `CDF = stats::poissonCDF(m)` with suitable numerical values of  $m, v$  are possible and recommended.

Distributions that are not provided by the `stats`-package can be implemented easily by the user. A user defined procedure  $f$  can implement any distribution function. In the CDF case, `stats::csGOFT` calls  $f$  with the boundary values  $a_i, b_i$  of the cells to compute the cell probabilities via  $p_i = f(b_i) - f(a_i)$  (automatically setting  $f(a_1) = 0$  and  $f(b_k) = 1$ ).

The function  $f$  must return a numerical real value between 0 and 1. See "Example 5" on page 30-107 (Symbolic Math Toolbox) and "Example 6" on page 30-108 (Symbolic Math Toolbox).

Alternatively, the function `f` can be specified by a univariate arithmetical expression  $g(x)$  depending on a symbolic variable  $x$ . It is interpreted as the function  $f: x \rightarrow g(x)$ . Cf. “Example 6” on page 30-108 (Symbolic Math Toolbox).

See the ‘Background’ section of this help page for further information on the specification of the distribution via  $\text{CDF} = f$ ,  $\text{PDF} = f$  or  $\text{PF} = f$ .

The call `stats::csGOF(data, cells, X = f)` returns the list [ $PValue = p$ ,  $StatValue = s$ ,  $MinimalExpectedCellFrequency = m$ ]:

- $s$  is the observed value of the chi-square statistic

$$s = \sum_{i=1}^k \frac{(y_i - n p_i)^2}{n p_i},$$

where  $n$  is the sample size,  $k$  is the number of cells,  $y_i$  is the observed cell frequency of the data (i.e.,  $y_i$  is the number of data  $x_j$  falling into the cell  $c_i$ ), and  $p_i$  is the cell probability corresponding to the hypothesized distribution  $f$ .

- $p$  is the observed significance level of the chi-square statistic with  $k - 1$  degrees of freedom, i.e.,  $p = 1 - \text{stats::chisquareCDF}(k - 1)(s)$
- $m = \min(n p_i, i = 1..k)$  is the minimum of the expected cell frequencies  $n p_i$ . This information is provided by the test to make sure that the boundary conditions for a “reasonable” cell partitioning are met (see the “Background” section of this help page).

The most relevant information returned by `stats::csGOF` is the observed significance level  $PValue = p$ . It has to be interpreted in the following way: Under the null hypothesis, the chi-square statistic

$$S = \sum_{i=1}^k \frac{(y_i - n p_i)^2}{n p_i}$$

is approximately chi-square distributed (for large samples):

$$\Pr(S \leq s) = \text{stats::chisquareCDF}(k - 1)(s).$$

Under the null hypothesis, the probability  $p = Pr(S > s)$  should not be small, where  $s$  is the value of the statistic attained by the sample.

Specifically,  $p = Pr(S > s) \geq \alpha$  should hold for a given significance level  $0 < \alpha < 1$ . If this condition is violated, the hypothesis may be rejected at level  $\alpha$ .

Thus, if the PValue (observed significance level)  $p = Pr(S > s)$  satisfies  $p < \alpha$ , the sample leading to the observed value  $s$  of the statistic  $S$  represents an unlikely event, and the null hypothesis may be rejected at level  $\alpha$ .

On the other hand, values of  $p$  close to 1 should raise suspicion about the randomness of the data: they indicate a fit that is *too good*.

## Environment Interactions

The function is sensitive to the environment variable DIGITS which determines the numerical working precision.

## Examples

### Example 1

We consider random data that should be normally distributed with mean 15 and variance 2:

```
f := stats::normalRandom(15, 2, Seed = 0):  
data := [f() $ i = 1..1000]:
```

According to the recommendations in the 'Background' section of this help page, the number of cells should be approximately  $2n^{2/5} \approx 31.7$ , where  $n = 1000$  is the sample size.

We wish to use 32 cells that are equiprobable with respect to the hypothesized normal distribution. We estimate the mean  $m$  and the variance  $v$  of the data:

```
[m, v] := [stats::mean(data), stats::variance(data, Sample)]
```

```
[14.94011963, 2.014256118]
```

The utility function `stats::equiprobableCells` is used to compute an equiprobable cell partitioning via the quantile function of the normal distribution with the empirical parameters:

```
cells := stats::equiprobableCells(32, stats::normalQuantile(m, v)):
stats::csGOF(data, cells, CDF = stats::normalCDF(m, v))
```

[PValue = 0.6359912784, StatValue = 27.712, MinimalExpectedCellFrequency = 31.25]

The observed significance level **0.635...** attained by the sample is not small. Hence, one should not reject the hypothesis that the sample is normally distributed with mean **14.94...** and variance **2.014...**

In the following, we impurify the sample by appending some uniformly distributed numbers. A new equiprobable cell partitioning appropriate for the new data is computed:

```
r := stats::uniformRandom(10, 20, Seed = 0):
data := append(data, r() $ 40):
[m, v] := [stats::mean(data), stats::variance(data, Sample)]:
k := round(2*nops(data)^(2/5)):
cells := stats::equiprobableCells(k, stats::normalQuantile(m, v)):
stats::csGOF(data, cells, CDF = stats::normalCDF(m, v))
```

[PValue = 0.007653320709, StatValue = 53.29230769,  
MinimalExpectedCellFrequency = 32.5]

The impure data may be rejected as a normally distributed sample at levels as small as **0.0076...**

```
delete f, data, m, v, k, cells, r:
```

## Example 2

We create a sample of random data that should be binomially distributed with trial parameter 70 and probability parameter  $\frac{1}{2}$ :

```
r := stats::binomialRandom(70, 1/2, Seed = 123):
data := [r() $ k = 1..1000]:
```

With the expectation value of 35 and the standard deviation of  $\sqrt{70} \approx 4.18$  of this distribution, we expect most of the data to have values between 30 and 40. Thus, a cell partitioning consisting of 12 cells corresponding to the intervals

$(0, 30], (30, 31], (31, 32], \dots, (39, 40], (40, 70]$

should be appropriate. Note that all cells are interpreted as the intervals  $(a_i, b_i]$ , i.e., the left boundary is not included in the interval. Strictly speaking, the value 0 is not covered by these cells. However, with a CDF specification, `stats::csGOF` ignores the leftmost boundary and replaces it by `-infinity`. Thus, the union of the cells does cover all integers 0, ..., 70 that can be attained by the hypothesized binomial distribution with 'trial parameter' 70:

```
cells := [[0, 30], [i, i + 1] $ i = 30..39, [40, 70]]
```

```
[[0, 30], [30, 31], [31, 32], [32, 33], [33, 34], [34, 35], [35, 36], [36, 37], [37, 38],
 [38, 39], [39, 40], [40, 70]]
```

We apply the  $\chi^2$  test with various specifications of the binomial distribution. They all produce the same result. However, the first call using a CDF specification is the most efficient (fastest) call:

```
stats::csGOF(data, cells, CDF = stats::binomialCDF(70, 1/2));
```

```
[PValue = 0.4810610726, StatValue = 10.55729362,
 MinimalExpectedCellFrequency = 46.88135939]
```

```
stats::csGOF(data, cells, PF = stats::binomialPF(70, 1/2));
```

```
[PValue = 0.4810610726, StatValue = 10.55729362,
 MinimalExpectedCellFrequency = 46.88135939]
```

```
f := binomial(70, x)*(1/2)^x*(1/2)^(70 - x):
stats::csGOF(data, cells, PF = f)
```

```
[PValue = 0.4810610726, StatValue = 10.55729362,
 MinimalExpectedCellFrequency = 46.88135939]
```



The observed significance level **0.481...** indicates that the data pass the test well.

Next, we do the sample by appending the value 35 forty times:

```
data := data . [35 $ 40]:
stats::csGOFT(data, cells, CDF = stats::binomialCDF(70, 1/2));
```

```
[PValue = 0.0098099163, StatValue = 24.78215227,
 MinimalExpectedCellFrequency = 48.75661376]
```

Now, the data may be rejected as a binomial sample with the specified parameters at levels as small as **0.0098...**

```
delete r, data, cells, f:
```

### Example 3

We test data that purport to be a sample of beta distributed numbers with scale parameters 3 and 2. Since beta deviates attain values between 0 and 1, we choose an equidistant cell partitioning of the interval [0, 1] consisting of 10 cells. Various equivalent calls to `stats::csGOFT` are demonstrated:

```
r := stats::betaRandom(3, 2, Seed = 1):
data := [r() $ i = 1..100]:
cells := [(i - 1)/10, i/10] $ i = 1..10:
stats::csGOFT(data, cells, CDF = stats::betaCDF(3, 2));
stats::csGOFT(data, cells, CDF = (x -> stats::betaCDF(3, 2)(x)))
```

```
[PValue = 0.7329969624, StatValue = 6.068961653, MinimalExpectedCellFrequency = 0.37]
```

```
[PValue = 0.7329969624, StatValue = 6.068961653, MinimalExpectedCellFrequency = 0.37]
```

Alternatively, the beta distribution may be passed by a PDF specification. This, however, is less efficient than the CDF specification used before:

```
stats::csGOFT(data, cells, PDF = stats::betaPDF(3, 2));
stats::csGOFT(data, cells, PDF = (x -> stats::betaPDF(3, 2)(x)));
```

```
[PValue = 0.7329969624, StatValue = 6.068961653, MinimalExpectedCellFrequency = 0.37]
```

[PValue = 0.7329969624, StatValue = 6.068961653, MinimalExpectedCellFrequency = 0.37]

The observed significance level 0.732... is not small. Hence, this test does not indicate that the data should be rejected as a beta distributed sample with the specified parameters. Note, however, that the minimal expected cell frequency given by the third element of the returned list is rather small. This indicates that the cell partitioning is not very fortunate. We investigate the expected cell frequencies by computing  $n p_i = n (f(b_i) - f(a_i))$ , where  $f$  is the cumulative distribution function of the beta distribution and  $n$  is the sample size:

```
f := stats::betaCDF(3, 2):
map(cells, cell -> 100*(f(cell[2]) - f(cell[1])))
```

[0.37, 2.35, 5.65, 9.55, 13.33, 16.27, 17.65, 16.75, 12.85, 5.23]

These values show that the first two or three cells should be joined to a single cell. We modify the cell partitioning by joining the first three and the last two cells:

```
cells := [[0, 3/10], [(i - 1)/10, i/10] $ i = 4..8, [8/10, 1]]
```

$\left[ \left[ 0, \frac{3}{10} \right], \left[ \frac{3}{10}, \frac{2}{5} \right], \left[ \frac{2}{5}, \frac{1}{2} \right], \left[ \frac{1}{2}, \frac{3}{5} \right], \left[ \frac{3}{5}, \frac{7}{10} \right], \left[ \frac{7}{10}, \frac{4}{5} \right], \left[ \frac{4}{5}, 1 \right] \right]$

For this cell partitioning, the expected frequencies in a random sample of size 100 are sufficiently large for all cells:

```
map(cells, cell -> 100*(f(cell[2]) - f(cell[1])))
```

[8.37, 9.55, 13.33, 16.27, 17.65, 16.75, 18.08]

We apply another  $\chi^2$  test with this improved partitioning:

```
stats::csGOF(data, cells, CDF = f)
```

[PValue = 0.9023533657, StatValue = 2.180685972, MinimalExpectedCellFrequency = 8.37]

Again, with the observed significance level **0.902...**, the test does not give any hint that the data are not beta distributed with the specified parameters.

Now, we test whether the data can be regarded as being normally distributed. First, we estimate the parameters (mean and variance) required for the normal distribution:

```
[m, v] := [stats::mean(data), stats::variance(data, Sample)]
```

```
[0.6101560142, 0.03595065085]
```

The cell partitioning used before was a partitioning of the interval  $[0, 1]$ , because beta deviates attain values in this interval. Now we construct a partitioning of 7 equiprobable cells using the quantile function of the normal distribution:

```
k := 7:
cells := stats::equiprobableCells(7, stats::normalQuantile(m, v))
```

```
[[-∞, 0.4077376304], [0.4077376304, 0.5028484001], [0.5028484001, 0.5760244864],
 [0.5760244864, 0.6442875419], [0.6442875419, 0.7174636283],
 [0.7174636283, 0.8125743979], [0.8125743979, ∞]]
```

Indeed, these cells are equiprobable:

```
f := stats::normalCDF(m, v):
map(cells, cell -> f(cell[2]) - f(cell[1]))
```

```
[0.1428571429, 0.1428571429, 0.1428571429, 0.1428571429, 0.1428571429,
 0.1428571429, 0.1428571429]
```

We test for normality with the estimated mean and variance:

```
stats::csGOF(data, cells, CDF = f)
```

```
[PValue = 0.7118124259, StatValue = 3.74, MinimalExpectedCellFrequency = 14.28571429]
```

With the observed significance level of **0.711...**, the data should not be rejected as a normally distributed sample. We note that the nonparametric Shapiro-Wilk test implemented in `stats::swGOF` does detect nonnormality of the sample:

```
stats::swGOF(data)
```

```
[PValue = 0.04753801335, StatValue = 0.97429647]
```

With the observed significance level of **0.0475...**, normality can be rejected at levels as low as **0.0475...**

```
delete r, data, cells, f, m, v, k, boundaries:
```

## Example 4

We demonstrate the use of samples of type `stats::sample`. We create a sample consisting of one string column and two non-string columns:

```
s := stats::sample(  
  [ ["1996", 1242, 156], ["1997", 1353, 162], ["1998", 1142, 168],  
    ["1999", 1201, 182], ["2001", 1201, 190], ["2001", 1201, 190],  
    ["2001", 1201, 205], ["2001", 1201, 210], ["2001", 1201, 220],  
    ["2001", 1201, 213], ["2001", 1201, 236], ["2001", 1201, 260],  
    ["2001", 1201, 198], ["2001", 1201, 236], ["2001", 1201, 245],  
    ["2001", 1201, 188], ["2001", 1201, 177], ["2001", 1201, 233],  
    ["2001", 1201, 270] ] )
```

```
"1996" 1242 156  
"1997" 1353 162  
"1998" 1142 168  
"1999" 1201 182  
"2001" 1201 190  
"2001" 1201 190  
"2001" 1201 205  
"2001" 1201 210  
"2001" 1201 220  
"2001" 1201 213  
"2001" 1201 236  
"2001" 1201 260  
"2001" 1201 198  
"2001" 1201 236  
"2001" 1201 245  
"2001" 1201 188  
"2001" 1201 177
```

```
"2001" 1201 233
"2001" 1201 270
```

We consider the data in the third column. The mean and the variance of these data are computed:

```
[m, v] := float([stats::mean(s, 3),
                 stats::variance(s, 3, Sample)])
```

```
[207.3157895, 1082.672515]
```

We check whether the data of the third column are normally distributed with the empirical mean and variance computed above. We compute an appropriate cell partitioning in the same way as explained in “Example 1” on page 30-100 (Symbolic Math Toolbox):

```
samplesize := s::dom::size(s):
k := round(2*samplesize^(2/5)):
cells := stats::equiprobableCells(k, stats::normalQuantile(m, v)):
stats::csGOF(s, 3, cells, CDF = stats::normalCDF(m, v))
```

```
[PValue = 0.9100131461, StatValue = 1.526315789,
 MinimalExpectedCellFrequency = 3.166666667]
```

Thus, the data pass the test.

```
delete s, m, v, samplesize, k, cells:
```

## Example 5

We demonstrate how user-defined distribution functions can be used. A die is rolled 60 times. The following frequencies of the scores 1, 2, ..., 6 are observed:

```

          score | 1 | 2 | 3
| 4 | 5 | 6 | -----+-----+-----+-----+-----+
frequency | 7 | 16 | 8 | 17 | 3 | 9
```

We test the null hypothesis that the dice is fair. Under this hypothesis, the variable  $X$  given by the score of a single roll attains the values 1 through 6 with constant probability

1. Presently, the stats-package does not provide a discrete uniform distribution, so we implement a corresponding cumulative discrete distribution function  $f$ :

```
f := proc(x)
begin
  if x < 0 then
    0
  elif x <= 6 then
    trunc(x)/6
  else 1
  end_if;
end_proc;
```

We create the data representing the 60 rolls:

```
data := [ 1 $ 7, 2 $ 16, 3 $ 8, 4 $ 17, 5 $ 3, 6 $ 9]:
```

We choose a collection of cells, each of which contains exactly one of the integers 1, ..., 6:

Wir wählen sodann eine Zellzerlegung, so dass jede Zelle genau eine der ganzen Zahlen 1, ..., 6 enthält:

```
cells := [[i - 1/2, i + 1/2] $ i = 1..6]
```

```
[[[1/2, 3/2], [3/2, 5/2], [5/2, 7/2], [7/2, 9/2], [9/2, 11/2], [11/2, 13/2]]]
```

```
stats::csGOF(data, cells, CDF = f)
```

```
[PValue = 0.01125197903, StatValue = 14.8, MinimalExpectedCellFrequency = 10.0]
```

At a significance level as small as **0.011...**, the null hypothesis 'the dice is fair' should be rejected.

```
delete f, data, cells:
```

## Example 6

We give a further demonstration of user-defined distribution functions. The following procedure represents the cumulative distribution function  $f: x \rightarrow \Pr(X \leq x) = x^2$  of a

variable  $X$  supported on the interval  $[0, 1]$ . It will be called with values from the cell boundaries and must return numerical values between 0 and 1:

```
f := proc(x)
  begin
    if x <= 0 then return(0)
    elif x <= 1 then return(x^2)
    else return(1)
    end_if
  end_proc:
```

We test the hypothesis that the following data are  $f$ -distributed. The cells form an equidistant partitioning of the interval  $[0, 1]$ :

```
data := [sqrt(frandon()) $ i = 1..10^3]:
k := 10:
cells := [(i - 1)/k, i/k] $ i = 1..k):
stats::csGOF(data, cells, CDF = f)
```

[PValue = 0.5637573509, StatValue = 7.708606165, MinimalExpectedCellFrequency = 10.0]

The test does not disqualify the sample as being  $f$ -distributed. Indeed, for a uniform deviate  $Y$  on the interval  $[0, 1]$  (as produced by `f random`), the cumulative distribution function of  $\sqrt{Y}$  is indeed given by  $f$ .

We note that the previous function yields the correct CDF values for all real arguments.

The chosen cell partitioning indicates that only values from the interval  $(0, 1]$  are considered. Since `stats::csGOF` just evaluates the CDF on the cell boundaries to compute the cell probability of the cell  $(a, b]$  by  $f(b) - f(a)$ , it suffices to restrict  $f$  to the interval  $(0, 1]$ . Hence, for the chosen cells, the symbolic expression  $f = x^2$  can also be used to specify the distribution:

```
stats::csGOF(data, cells, CDF = x^2)
```

[PValue = 0.5637573509, StatValue = 7.708606165, MinimalExpectedCellFrequency = 10.0]

```
delete f, data, k, cells:
```

## Parameters

$x_1, x_2, \dots$

The statistical data: real numerical values

**s**

A sample of domain type `stats::sample`

**c**

An integer representing a column index of the sample `s`. This column provides the data  $x_1, x_2$  etc. There is no need to specify a column `c` if the sample has only one column.

$a_1, b_1, a_2, b_2, \dots$

Cell boundaries: real numbers satisfying  $a_1 < b_1 \leq a_2 < b_2 \leq a_3 < \dots$ . Also  $\pm\infty$  is admitted as a cell boundary. At least 3 cells have to be specified.

**f**

A procedure representing the hypothesized distribution: either a cumulative distribution function (CDF = `f`), a probability density function (PDF = `f`), or a (discrete) probability function (PF = `f`). Typically, `f` is one of the distribution functions of the `stats` package such as `stats::normalCDF(m, v)` etc. Instead of a procedure, also an arithmetical expression (Symbolic Math Toolbox) in some indeterminate `x` may be specified which will be interpreted as a function of `x`.

## Options

**CDF, PDF, PF**

This determines how the procedure `f` is interpreted by `stats::csGOFT`.

## Return Values

a list of three equations



[PValue = p, StatValue = s, MinimalExpectedCellFrequency = m]

with floating-point values p, s, m. See the “Details” section below for the interpretation of these values.

## Algorithms

In R.B. D'Agostino and M.A. Stephens, “Goodness-Of-Fit Techniques”, Marcel Dekker, 1986, p. 70-71, one finds the following recommendations for choosing the cell partitioning:

- The number of cells used should be approximately  $2 n^{2/5}$ , where  $n$  is the sample size.
- The cells should have equal probabilities  $p_i$  under the hypothesized distribution.
- With equiprobable cells, the average of the expected cell frequencies  $n p_i$  should be at least 1 when testing at the significance level  $\alpha = 0.05$ . For  $\alpha = 0.01$ , the average expected cell frequency should be at least 2. When cells are not approximately equiprobable, the average expected cell frequency for the significance levels above should be doubled. For example, the average expected cell frequency at the significance level  $\alpha = 0.01$  should be at least 4.

The distribution function  $f$  passed to `stats::csGOF` via  $X = f$  is only used to compute the cell probabilities  $p_i = Pr(a_i < x \leq b_i)$  of the cells  $c_i = (a_i, b_i]$ .

A cumulative distribution function  $f$  specified by `CDF = f` is used to compute the cell probabilities via  $p_i = f(b_i) - f(a_i)$ .

A probability density function  $f$  specified via `PDF = f` is used to compute the cell probabilities via numerical integration:  $p_i = \text{numeric::int}(f(x), x = a_i.. b_i)$ . This is rather expensive!

A discrete probability function specified via `PF = f` is used to compute the cell

probabilities via the summation  $p_i = \sum_{x=|a_i|+1}^{b_i} f(x)$ .

---

**Note** Thus, with the specification `PF = f`, the distribution is implicitly supposed to be supported on the integers in the cells  $c_i = (a_i, b_i]$ . Do not use `PF = f` if the discrete

probability function is not supported on the integers! Use CDF = f with an appropriate (discrete) cumulative distribution function instead!

---

With the specification  $\text{PF} = f$ , the value  $-\infty$  is not admitted for the left boundary  $a_1$  of the first cell  $c_1 = \text{Intval}([a_1], [b_1])$ .

## See Also

### MuPAD Functions

`stats::equiprobableCells` | `stats::ksGOF` | `stats::swGOF` | `stats::tTest`

## stats::empiricalCDF

Empirical (discrete) cumulative distribution function of a finite data sample

### Syntax

```
stats::empiricalCDF(x1, x2, ...)
```

```
stats::empiricalCDF([x1, x2, ...])
```

```
stats::empiricalCDF(s, c)
```

### Description

`stats::empiricalCDF(x1, x2, ..., xn)` returns a procedure representing the

empirical (discrete) cumulative distribution function  $x \rightarrow \frac{1}{n} |\{i \mid x_i \leq x\}|$  (the relative frequency of data elements  $x_i$  less than or equal to  $x$ ).

All data  $x_1, x_2, \dots$  must be convertible to real floating-point numbers.

The procedure `f := stats::empiricalCDF(x1, x2, ...)` can be called in the form `f(x)` with an arithmetical expression  $x$ .

If  $x$  is a numerical value, `f(x)` returns a rational number from the interval  $[0, 1]$ .

The call `f(-infinity)` produces 0; the call `f(infinity)` produces 1.

Otherwise, if  $x$  is a symbolic expression that cannot be converted to a real floating-point number, `f(x)` returns the symbolic call `stats::empiricalCDF([x1, x2, ...])(x)` with the data  $x_1, x_2, \dots$  in ascending order.

For a sample of size  $n$ , the call `f := stats::empiricalCDF(x1, x2, ...)` needs a run time of  $O(n \ln(n))$  due to internal sorting of the data. Each call to `f` needs a run time of  $O(\ln(n))$ . If several evaluations of the distribution function are needed, a calling sequence such as

```
f := stats::empiricalCDF(x1, x2, ...); f(a1); f(a2); dots
```

is more efficient than

```
stats::empiricalCDF(x1, x2, ...)(a1);
```

```
stats::empiricalCDF(x1, x2, ...)(a2);
```

dots.

`stats::empiricalCDF` is generalized by `stats::finiteCDF`, which allows to specify different probabilities for the elements of the sample. The call

```
stats::empiricalCDF([x1, ..., xn])
```

 corresponds to 

```
stats::finiteCDF([x1, dots, xn], [1/n, dots, 1/n])
```

.

Further, `stats::finiteCDF` does not only allow numerical values  $x_1, x_2, \dots$ , but arbitrary MuPAD objects.

## Environment Interactions

The function is sensitive to the environment variable `DIGITS` which determines the numerical working precision. Note, however, that this function is implemented with option `remember`. After the first call it does not react to changes of `DIGITS` unless the input parameters are changed.

## Examples

### Example 1

We evaluate the empirical distribution function of the data  $-1, 0, 2.3, \text{PI}, 8$  at various points:

```
f := stats::empiricalCDF(-1, 0, 2.3, PI, 8):  
f(-infinity), f(-3), f(2.4), f(PI), f(10), f(infinity)
```

$0, 0, \frac{3}{5}, \frac{4}{5}, 1, 1$

Alternatively, the data may be passed as a list:

```
f := stats::empiricalCDF([-1, 0, 2.3, PI, 8]):
f(-infinity), f(-3), f(2.4), f(PI), f(10), f(infinity)
```

$$0, 0, \frac{3}{5}, \frac{4}{5}, 1, 1$$

```
delete f:
```

## Example 2

We use a symbolic argument. In the symbolic return value, the input data appear as a sorted list:

```
stats::empiricalCDF(PI, -3, 25, PI, 4/3)(x)
```

$$\text{stats::empiricalCDF}\left(\left[-3, \frac{4}{3}, \pi, \pi, 25\right]\right)(x)$$

## Example 3

We create a sample on page 30-413 consisting of one string column and two non-string columns:

```
s := stats::sample(
  [{"1996", 1242, PI - 1/2}, {"1997", 1353, PI + 0.3},
   {"1998", 1142, PI + 0.5}, {"1999", 1201, PI - 1},
   {"2001", 1201, PI}])
```

```
"1996" 1242 PI - 1/2
"1997" 1353 PI + 0.3
"1998" 1142 PI + 0.5
"1999" 1201 PI - 1
"2001" 1201 PI
```

We compute values of the empirical distributions of the data in the second and third column, respectively:

```
f2 := stats::empiricalCDF(s, 2): f2(1000), f2(1200), f2(1201)
```

$$0, \frac{1}{5}, \frac{3}{5}$$

```
f3 := stats::empiricalCDF(s, 3): f3(0.7), f3(3), f3(PI), f3(4)
```

```
0,  $\frac{2}{5}$ ,  $\frac{3}{5}$ , 1
```

```
delete s, f2, f3:
```

## Parameters

$x_1, x_2, \dots$

The statistical data: real numerical values

**s**

A sample of domain type `stats::sample`

**c**

A column index of the sample `s`: a positive integer. This column provides the data  $x_1, x_2$  etc. There is no need to specify a column number `c` if the sample has only one non-string column.

## Return Values

procedure on page 1-1654.

## See Also

### MuPAD Functions

`stats::empiricalPF` | `stats::empiricalQuantile` | `stats::empiricalRandom` |  
`stats::finiteCDF` | `stats::finitePF` | `stats::finiteQuantile` |  
`stats::finiteRandom`

# stats::empiricalPF

Probability function of a finite data sample

## Syntax

```
stats::empiricalPF(x1, x2, ...)
```

```
stats::empiricalPF([x1, x2, ...])
```

```
stats::empiricalPF(n, <c>)
```

```
stats::empiricalPF(n, <[c]>)
```

## Description

stats::empiricalPF([x<sub>1</sub>, x<sub>2</sub>, ..., x<sub>n</sub>]) returns a procedure representing the probability function

$$x \rightarrow \begin{cases} \frac{1}{n} & \text{if } x = x_i \\ 0 & \text{otherwise} \end{cases}$$

of the sample given by the data x<sub>1</sub>, x<sub>2</sub>, ...

The procedure `f := stats::empiricalPF([x1, x2, ...])` can be called in the form `f(x)` with an arithmetical expression `x` or sets of lists of such expressions.

If `x` is a numerical expression that is contained in the data x<sub>1</sub>, x<sub>2</sub>, ..., then the corresponding probability value  $\frac{1}{n}$  is returned ( $n$  is the size of the sample).

If `x` is a numerical expression that is not contained in the data x<sub>1</sub>, x<sub>2</sub>, ..., then 0 is returned.

If `x` is a symbolic expression that cannot be converted to a real floating-point number, `f(x)` returns the symbolic call `stats::empiricalPF([x1, x2, ...])(x)` with the data x<sub>1</sub>, x<sub>2</sub>, ... in ascending order.

If  $x$  is a set, the sum of the probability values of its elements is returned.

If  $x$  is a list, it is treated like a set (i.e., duplicate entries in  $x$  are eliminated). The sum of the probability values of the elements in  $x$  is returned.

Duplicate data elements are automatically combined to a single data element, adding up the corresponding probability values. Cf. "Example 4" on page 30-120 (Symbolic Math Toolbox).

`stats::empiricalPF` is generalized by `stats::finitePF`, which allows to specify different probabilities for the elements of the sample. The call `stats::empiricalPF([x_1, dots, x_n], [1/n, dots, 1/n])` corresponds to `stats::empiricalPF([x_1, ..., x_n])`.

Further, `stats::finitePF` does not only allow numerical values  $x_1, x_2, \dots$ , but arbitrary MuPAD objects.

## Examples

### Example 1

We demonstrate the basic usage of this function:

```
f := stats::empiricalPF(1, 3, PI, 4.0):  
f(0), f(1), f(1.0), f(3), f(PI), f(float(PI)), f(4), f(4.0)
```

$$0, \frac{1}{4}, 0, \frac{1}{4}, \frac{1}{4}, 0, 0, \frac{1}{4}$$

Alternatively, the data may be passed as a list:

```
f := stats::empiricalPF(1, 3, PI, 4.0):  
f(0), f(1), f(1.0), f(3), f(PI), f(float(PI)), f(4), f(4.0)
```

$$0, \frac{1}{4}, 0, \frac{1}{4}, \frac{1}{4}, 0, 0, \frac{1}{4}$$

A symbolic value of the argument in  $f$  leads to a symbolic return value:

```
f(x)
```



```
stats::empiricalPF([1, 3, π, 4.0])(x)
```

Symbolic data are not accepted:

```
stats::empiricalPF(1, 3, x, 4.0):
```

```
Error: Unable to convert some of the data to floating-point numbers. [stats::empiricalPF]
```

```
delete f:
```

## Example 2

We create a sample of type `stats::sample` consisting of one string column and two non-string columns:

```
s := stats::sample(
  ["1996", 1242, 2/5],
  ["1997", 1353, 0.1],
  ["1998", 1142, 0.2],
  ["1999", 1201, 0.2],
  ["2001", 1201, 0.1])
```

```
"1996" 1242 2/5
"1997" 1353 0.1
"1998" 1142 0.2
"1999" 1201 0.2
"2001" 1201 0.1
```

We use the data in the first and third column:

```
f := stats::empiricalPF(s, 2):
f(1242), f(1353), f(1200), f(1201)
```

$$\frac{1}{5}, \frac{1}{5}, 0, \frac{2}{5}$$

```
delete s, f:
```

### Example 3

We consider a fair die:

```
f:= stats::empiricalPF([1, 2, 3, 4, 5, 6]):
```

What is the probability that tossing the die produces a score more than or equal to 4?

```
f({4, 5, 6})
```

$$\frac{1}{2}$$

```
delete f:
```

### Example 4

Duplicate data elements are automatically combined to a single data element, adding up the corresponding probability values:

```
f:= stats::empiricalPF([1, 2, 1, 1, 2]):  
f(1), f(2)
```

$$\frac{3}{5}, \frac{2}{5}$$

```
delete f:
```

## Parameters

$x_1, x_2, \dots$

The statistical data: real numerical values

**s**

A sample of domain type `stats::sample`

**c**

A column index of the sample **s**: a positive integer. This column provides the data  $x_1$ ,  $x_2$  etc. There is no need to specify a column number **c** if the sample has only one non-string column.

## Return Values

procedure on page 1-1654.

## See Also

### MuPAD Functions

stats::empiricalCDF | stats::empiricalQuantile | stats::empiricalRandom  
| stats::finiteCDF | stats::finitePF | stats::finiteQuantile |  
stats::finiteRandom

## stats::empiricalQuantile

Quantile function of the empirical distribution

### Syntax

```
stats::empiricalQuantile(x1, x2, ...)  
stats::empiricalQuantile([x1, x2, ...])  
stats::empiricalQuantile(s, c)
```

### Description

`stats::empiricalQuantile(x1, x2, ...)` returns a procedure representing the quantile function of the data  $x_1, x_2$  etc. It is the (discrete) inverse of the empirical cumulative distribution function `stats::empiricalCDF(x1, x2, ...)`. For  $0 \leq x \leq 1$ , the  $x$ -quantile  $y = \text{stats::empiricalQuantile}(x_1, x_2, \dots)(x)$  is the smallest of the data elements  $x_1, x_2, \dots$  satisfying

$$\text{stats::empiricalCDF}(x_1, x_2, \dots)(y) \geq x$$

All data  $x_1, x_2, \dots$  must be convertible to real floating-point numbers. The data do not have to be sorted on input.

The procedure `f := stats::empiricalQuantile(x1, x2, ...)` can be called in the form `f(x)` or `f(x, Averaged)` with an arithmetical expression  $x$ .

If  $x$  is a real number satisfying  $0 \leq x \leq 1$ , then `f(x)` returns one of the data elements; `f(x, Averaged)` uses interpolation of adjacent data elements:

The  $x$ -quantile of  $n$  sorted values  $x_1 \leq \dots \leq x_n$  is computed as follows.

- `f(x)` returns  $x_k$  with  $k = \text{ceil}(n \cdot x)$ .
- `f(x, Averaged)` returns  $x_k$  with  $k = \text{ceil}(n \cdot x)$  if  $n \cdot x$  is not an integer. Otherwise,

it returns  $\frac{x_k + x_{k+1}}{2}$ .

If  $x$  is a symbolic expression that cannot be converted to a real floating-point number,  $f(x, \text{<Averaged>})$  returns the symbolic call `stats::empiricalQuantile([x1, x2, ...])(x, <Averaged>)` with the data  $x_1, x_2, \dots$  in ascending order.

Numerical values of  $x$  are only accepted if  $0 \leq x \leq 1$ .

$y = \text{stats::empiricalQuantile}(x_1, x_2, \dots)(x)$  satisfies

$$\text{stats::empiricalCDF}(x_1, x_2, \dots)(z) < x \leq \text{stats::empiricalCDF}(x_1, x_2, \dots)(y)$$

for all data elements  $z$  in the sample satisfying  $z < y$ .

For a sample of size  $n$ , the call  $f := \text{stats::empiricalQuantile}(x_1, x_2, \dots)$  needs a run time of  $O(n \ln(n))$  due to internal sorting of the data. The costs of a call to  $f$  are essentially dependent of  $n$ . If several evaluations of the quantile function are needed, a calling sequence such as

```
f := stats::empiricalQuantile(x1, x2, ...); f(a1); f(a2); dots
```

is more efficient than

```
stats::empiricalQuantile(x1, x2, ...)(a1);
```

```
stats::empiricalQuantile(x1, x2, ...)(a2);
```

```
dots.
```

The  $\frac{1}{2}$ -quantile is called “median”. The function `stats::median` implements this special quantile.

`stats::empiricalQuantile` is generalized by `stats::finiteQuantile`, which allows to specify different probabilities for the elements of the sample. The call `stats::empiricalQuantile([x1, ..., xn])` corresponds to `stats::finiteQuantile([x1, dots, xn], [1/n, dots, 1/n])`.

Further, `stats::finiteQuantile` does not only allow numerical values  $x_1, x_2, \dots$ , but arbitrary MuPAD objects.

## Environment Interactions

The function is sensitive to the environment variable DIGITS which determines the numerical working precision. Note, however, that this function is implemented with option remember. After the first call it does not react to changes of DIGITS unless the input parameters are changed.

## Examples

### Example 1

We compute various quantiles of the data -1, 0, 0, 2.3, PI, PI, 8:

```
f := stats::empiricalQuantile(-1, 0, 0, 2.3, PI, PI, 8):  
f(0), f(0.1), f(3/10), f(0.5), f(1/sqrt(2)), f(99/100), f(1)
```

$-1, -1, 0, 2.3, \pi, 8, 8$

Alternatively, the data may be passed as a list:

```
f := stats::empiricalQuantile([-1, 0, 2.3, PI, 8]):  
f(0), f(0.1), f(3/10), f(0.5), f(1/sqrt(2)), f(99/100), f(1)
```

$-1, -1, 0, 2.3, \pi, 8, 8$

```
delete f:
```

### Example 2

We use a symbolic argument. In the symbolic return value, the input data appear as a sorted list:

```
f := stats::empiricalQuantile(3, 25, PI, 4/3): f(x)
```

$\text{stats::empiricalQuantile}\left(\left[\frac{4}{3}, 3, \pi, 25\right]\right)(x)$

Numerical values for  $x$  are only accepted if  $0 \leq x \leq 1$ :

```
f(0.5)
```

```
3
```

```
f(2)
```

```
Error: Argument x must be between 0 and 1. [f]
```

```
delete f:
```

### Example 3

We create a sample of type `stats::sample` consisting of one string column and two non-string columns:

```
s := stats::sample(
  ["1996", 1242, PI - 1/2], ["1997", 1353, PI + 0.3],
  ["1998", 1142, PI + 0.5], ["1999", 1201, PI - 1/3],
  ["2001", 1201, PI + 0.5])
```

```
"1996" 1242 PI - 1/2
"1997" 1353 PI + 0.3
"1998" 1142 PI + 0.5
"1999" 1201 PI - 1/3
"2001" 1201 PI + 0.5
```

We compute quantile values of the data in the second and third column, respectively:

```
f2 := stats::empiricalQuantile(s, 2):
f2(0.1), f2(1/4), f2(0.7), f2(99/100)
```

```
1142, 1201, 1242, 1353
```

```
f3 := stats::empiricalQuantile(s, 3):
f3(0.1), f3(1/4), f3(0.7), f3(99/100)
```

```
 $\pi - \frac{1}{2}, \pi - \frac{1}{3}, \pi + 0.5, \pi + 0.5$ 
```

delete s, f2, f3:

## Parameters

$x_1, x_2, \dots$

The statistical data: real numerical values

**s**

A sample of domain type `stats::sample`

**c**

A column index of the sample **s**: a positive integer. This column provides the data  $x_1, x_2$  etc. There is no need to specify a column number **c** if the sample has only one non-string column.

## Return Values

procedure on page 1-1654.

## See Also

### MuPAD Functions

`stats::empiricalCDF` | `stats::empiricalPF` | `stats::empiricalRandom` |  
`stats::finiteCDF` | `stats::finitePF` | `stats::finiteQuantile` |  
`stats::finiteRandom` | `stats::median`



## stats::empiricalRandom

Generate a random generator for uniformly distributed elements of a data sample

### Syntax

```
stats::empiricalRandom(x1, x2, ..., <Seed = n>)  
stats::empiricalRandom([x1, x2, ...], <Seed = n>)  
stats::empiricalRandom(n, <c>, <Seed = n>)  
stats::empiricalRandom(n, <[c]>, <Seed = n>)
```

### Description

stats::empiricalRandom([x<sub>1</sub>, x<sub>2</sub>, ..., x<sub>n</sub>]) returns a procedure that picks out random elements from the data x<sub>1</sub>, x<sub>2</sub> etc.

All data x<sub>1</sub>, x<sub>2</sub>, ... must be convertible to real floating-point numbers.

The procedure `f := stats::empiricalRandom([x1, x2, ...])` can be called in the form `f()`. The call `f()` returns one of the data elements x<sub>1</sub>, x<sub>2</sub>, ...

The values produced by `f()` are distributed randomly. Each element of the sample is chosen with the same probability.

Without the option `Seed = n`, an initial seed is chosen internally. This initial seed is set to a default value when MuPAD is started. Thus, each time MuPAD is started or re-initialized with the `reset` function, random generators produce the same sequences of numbers.

---

**Note** In contrast to the function `random`, the generators produced by `stats::empiricalRandom` do not react to the environment variable `SEED`.

---

For efficiency, it is recommended to produce sequences of  $K$  random elements via

```
f := stats::empiricalRandom([x1, x2, ...]):
```

```
f() $k = 1..K;
```

rather than by

```
stats::empiricalRandom([x_1, x_2, dots])() $k = 1..K;
```

The latter call produces a sequence of generators each of which is called once. Also note that

```
stats::empiricalRandom([x_1, x_2, dots], Seed = s)() $k = 1..K;
```

does not produce a random sequence, because a sequence of freshly initialized generators would be created each of them producing the same number.

`stats::empiricalRandom` is generalized by `stats::finiteRandom`, which allows to specify different probabilities for the elements of the sample. The call `stats::empiricalRandom([x1, ..., xn])` corresponds to `stats::finiteRandom([x1, dots, xn], [1/n, dots, 1/n])`.

Further, `stats::finiteRandom` does not only allow numerical values  $x_1, x_2, \dots$ , but arbitrary MuPAD objects.

## Examples

### Example 1

We pick out random elements of some data:

```
f := stats::empiricalRandom(1, 7, 4, PI, Seed = 234):  
f(), f(), f(), f(), f(), f(), f(), f(), f()
```

```
1, 1, π, 7, 7, π, π, 7, 7
```

Alternatively, the data may be passed as a list:

```
f := stats::empiricalRandom([1, 7, 4, PI], Seed = 234):  
f(), f(), f(), f(), f(), f(), f(), f(), f()
```

```
1, 1, π, 7, 7, π, π, 7, 7
```

Symbolic data are not accepted:

```
stats::empiricalRandom(1, 7, 4, x):
```

```
Error: Unable to convert some of the data to floating-point numbers. [stats::empiricalR
```

```
delete f:
```

## Example 2

We create a sample of type `stats::sample` consisting of one string column and two non-string columns:

```
s := stats::sample(
  ["1996", 1242, 2/5],
  ["1997", 1353, 0.1],
  ["1998", 1142, 0.2],
  ["1999", 1201, 0.2],
  ["2001", 1201, 0.1])
```

```
"1996" 1242 2/5
"1997" 1353 0.1
"1998" 1142 0.2
"1999" 1201 0.2
"2001" 1201 0.1
```

We pick random values using the data in the second and third column, respectively:

```
f := stats::empiricalRandom(s, 2, Seed = 12345):
f(), f(), f(), f(), f(), f(), f()
```

```
1353, 1142, 1142, 1201, 1142, 1142, 1353
```

```
f := stats::empiricalRandom(s, 3, Seed = 12345):
f(), f(), f(), f(), f(), f(), f()
```

```
2/5, 0.1, 0.1, 0.1, 0.1, 0.1, 2/5
```

```
delete s, f:
```

### Example 3

We toss a fair die:

```
f := stats::empiricalRandom([1, 2, 3, 4, 5, 6], Seed = 12345):  
f(), f(), f(), f(), f(), f(), f(), f(), f(), f()
```

```
5, 1, 2, 3, 1, 1, 6, 3, 1, 2
```

We toss the die 6000 times and count the frequencies of the scores 1 through 6:

```
t := [f() $ k = 1..6000]:  
i = nops(select(t, _equal, i)) $ i = 1..6
```

```
1 = 982, 2 = 1006, 3 = 911, 4 = 1037, 5 = 1021, 6 = 1043
```

The routine `stats::finiteRandom` allows to model a loaded die:

```
f := stats::finiteRandom(  
  [[1, 0.1],  
   [2, 0.1],  
   [3, 0.1],  
   [4, 0.1],  
   [5, 0.1],  
   [6, 0.5]],  
  Seed = 12345):  
t := [f() $ k = 1..6000]:  
i = nops(select(t, _equal, i)) $ i = 1..6
```

```
1 = 572, 2 = 611, 3 = 614, 4 = 548, 5 = 554, 6 = 3101
```

```
delete f, t:
```

### Parameters

$x_1, x_2, \dots$

The statistical data: real numerical values

**s**

A sample of domain type `stats::sample`

**c**

A column index of the sample `s`: a positive integer. This column provides the data  $x_1, x_2$  etc. There is no need to specify a column number `c` if the sample has only one non-string column.

## Options

**Seed**

Option, specified as `Seed = n`

Initializes the random generator with the integer seed `n`. `n` can also be the option `currentTime`, to make the seed depend on the current time.

This option serves for generating generators that return predictable sequences of pseudo-random values. The generator is initialized with the seed `n` which may be an arbitrary integer. Several generators with the same initial seed produce the same sequence of values.

## Return Values

procedure on page 1-1654.

## See Also

**MuPAD Functions**

`stats::empiricalCDF` | `stats::empiricalPF` | `stats::empiricalQuantile` |  
`stats::finiteCDF` | `stats::finitePF` | `stats::finiteQuantile` |  
`stats::finiteRandom` | `stats::median`

## stats::equiprobableCells

Divide the real line into equiprobable intervals

### Syntax

```
stats::equiprobableCells(k, q, <NoWarning>)
```

### Description

`stats::equiprobableCells` is a utility function for the classical chi-square test implemented by `stats::csGOF`. The call `stats::equiprobableCells(k, q)` creates a list of intervals (“cells”) that are equiprobable with respect to the statistical distribution corresponding to the quantile function `q`.

The chi-square goodness-of-fit test on page 30-97 needs a cell partitioning of the real line to compare the empirical frequencies of data falling into the cells with the expected frequencies corresponding to a hypothesized statistical distribution. It is recommended to use equiprobable cells in this test. `stats::equiprobableCells` is a utility function to compute such a partitioning.

The cell boundaries  $b_i$  of the returned cell partitioning  $[[b_0, b_1], \dots, [b_{k-1}, b_k]]$  are

computed via  $b_i = \text{float}\left(q\left(\text{float}\left(\frac{i}{k}\right)\right)\right)$ . Mathematically, each cell  $[b_{i-1}, b_i]$  corresponds to a semi-open interval  $\left(b_{i-1}, b_i\right]$ .

If `q` is the quantile function of a *continuous* statistical distribution, all cells have the same

cell probability  $\Pr\left(b_{i-1} < x \leq b_i\right) = \frac{1}{k}$ .

The function `q` can be a quantile procedure provided by the MuPAD `stats`-library.

Quantile functions not provided by the `stats`-package can be implemented easily by the user. A user defined quantile procedure `q` can correspond to any statistical distribution. Quantile functions must accept one numerical floating-point parameter `x` satisfying  $0.0 \leq x \leq 1.0$ . The call `q(x)` must produce a real value. In particular, the return values `q(0.0) = -infinity` and `q(1.0) = infinity` are allowed.

Quantile functions must be monotonically increasing. `stats::equiprobableCells`

issues warnings if the computed quantile values  $b_i = \text{float}\left(q\left(\text{float}\left(\frac{i}{k}\right)\right)\right)$  are not real or  $\pm\infty$ , or if these values do not increase monotonically.

`stats::equiprobableCells` also accepts quantile functions of *discrete* distributions such as `stats::empiricalQuantile(data)` or `stats::binomialQuantile(n, p)`.

---

**Note** Note, however, that in general, there are no equiprobable cell partitionings for discrete distributions. Consequently, equiprobability of the cells returned by `stats::equiprobableCells` is not guaranteed if  $q$  is not a continuous function.

---

In particular, it may happen for large  $k$ , that  $q\left(\frac{i-1}{k}\right)$  coincides with  $q\left(\frac{i}{k}\right)$ , i.e., the corresponding cell is empty. This will always happen, when  $k$  exceeds the number of possible discrete values the random variable can attain.

In such a case, a warning is issued. Passing such a cell partitioning to `stats::csGOF` raises an error.

Further to the examples on this help page, see also the examples on the help page of `stats::csGOF`.

## Environment Interactions

The function is sensitive to the environment variable `DIGITS` which determines the numerical working precision.

## Examples

### Example 1

We divide the real line into 4 intervals that are equiprobable with respect to the standard normal distribution on page 30-364:

```
k:= 4: q := stats::normalQuantile(0, 1):
cells := stats::equiprobableCells(k, q)
```

```
[[-∞, -0.6744897502], [-0.6744897502, 0.0], [0.0, 0.6744897502], [0.6744897502, ∞]]
```

We check equiprobability by applying the function `stats::normalCDF(0, 1)` to the cell boundaries:

```
cdf := stats::normalCDF(0, 1):  
p := map(cells, map, cdf)
```

```
[[0, 0.25], [0.25, 0.5], [0.5, 0.75], [0.75, 1]]
```

The cell probabilities are given by the differences of the CDF function applied to the cell boundaries:

```
(p[i][2] - p[i][1]) $ i = 1..k
```

```
0.25, 0.25, 0.25, 0.25
```

We use these cells for a chi-square test on page 30-97 for normality of some random data:

```
r := stats::normalRandom(0, 1, Seed = 0):  
data := [r() $ i = 1..1000]:  
stats::csGOF(data, cells, CDF = cdf)
```

```
[PValue = 0.8398775533, StatValue = 0.84, MinimalExpectedCellFrequency = 250.0]
```

With the observed significance level **0.839...**, the data pass this test well. We experiment with other equiprobable cell partitionings:

```
for k in [20, 30, 40, 50] do  
  cells := stats::equiprobableCells(k, q);  
  print(stats::csGOF(data, cells, CDF = cdf));  
end_for:
```

```
[PValue = 0.1798122173, StatValue = 24.44, MinimalExpectedCellFrequency = 50.0]
```

```
[PValue = 0.713000696, StatValue = 24.32, MinimalExpectedCellFrequency = 33.33333333]
```



```
[PValue = 0.7039429342, StatValue = 33.84, MinimalExpectedCellFrequency = 25.0]
```

```
[PValue = 0.932574698, StatValue = 35.1, MinimalExpectedCellFrequency = 20.0]
```

```
delete k, cells, p, cdf, r, data:
```

## Example 2

We create a sample of 1000 random integers between 0 and 100:

```
SEED := 10^2: r := random(0 .. 100):
data := [r() $ i = 1..1000]:
```

We construct an 'equiprobable' cell partitioning of 10 cells using the (discrete) empirical distribution on page 30-113 of the data. I.e., each of the following cells should contain approximately the same number of data from the random sample:

```
k := 10:
quantile := stats::empiricalQuantile(data):
cells := stats::equiprobableCells(k, quantile)
```

```
[[0.0, 9.0], [9.0, 19.0], [19.0, 31.0], [31.0, 38.0], [38.0, 49.0], [49.0, 59.0], [59.0, 69.0],
[69.0, 78.0], [78.0, 91.0], [91.0, 100.0]]
```

For discrete distributions, 'equiprobability' can only be achieved approximately. We compute the cell probabilities with respect to the empirical cumulative distribution function (CDF), by subtracting the CDF value of the left boundary from the CDF value of the right boundary:

```
cdf := stats::empiricalCDF(data):
map(cells, cell -> cdf(cell[2]) - cdf(cell[1]))
```

```
[ 12/125, 99/1000, 14/125, 89/1000, 51/500, 103/1000, 103/1000, 23/250, 21/200, 93/1000 ]
```

The actual empirical frequency of the data in each cell is the cell probability times the sample size (1000):

```
map(cells, cell -> 1000*(cdf(cell[2]) - cdf(cell[1])))
```

[96, 99, 112, 89, 102, 103, 103, 92, 105, 93]

When computing the probability of the cell  $[b[i-1], b[i]]$  via  $cdf(b_i) - cdf(b_{i-1})$ , the cell is regarded as the semiopen interval  $(b_{i-1}, b_i]$  mathematically. For this reason, the data points 0 contained in the sample are not counted, and the cell frequencies do not quite add up to the sample size:

```
_plus(op(%))
```

994

For the Symbol::chi^2 test on page 30-97, this does not matter because it replaces the left boundary of the first cell by `-infinity`, anyway. With an observed significance level of `0.161...`, the data pass the test for a uniform distribution at levels as high as `0.161...`:

```
stats::csG0FT(data, cells, CDF = stats::uniformCDF(0, 100))
```

[PValue = 0.1619543558, StatValue = 13.01443112, MinimalExpectedCellFrequency = 70.0]

We test whether the data fit a normal distribution on page 30-364 with the empirical mean on page 30-346 and variance on page 30-480:

```
[m, v] := [stats::mean(data), stats::variance(data)];  
stats::csG0FT(data, cells, CDF = stats::normalCDF(m, v))
```

$\left[ \frac{9863}{200}, \frac{1221413}{1480} \right]$

[PValue = 0.00000000207226197, StatValue = 59.0175707,  
MinimalExpectedCellFrequency = 65.3983756]

With the observed significance level `0.00000000207...`, the hypothesis of a normal distribution clearly has to be rejected.

```
delete r, data, k, quantile, cells, cdf, m, v:
```

### Example 3

We consider a binomial distribution with `trial parameter'  $n = 100$  and `probability parameter'  $p = \frac{1}{2}$ . It is the distribution of the number of successes in  $n = 100$  independent Bernoulli experiments, each with success probability  $p = \frac{1}{2}$ . This random variable can attain the discrete values 0, 1, ..., 100. We create a cell partitioning of 4 cells:

```
n := 100: p := 1/2:
quantile := stats::binomialQuantile(n, p):
cells := stats::equiprobableCells(4, quantile)
```

```
[[0.0, 47.0], [47.0, 50.0], [50.0, 53.0], [53.0, 100.0]]
```

Because of discreteness, an exact equiprobable cell partitioning does not exist. We compute the expected cell frequencies in the same way as in the previous example:

```
cdf := stats::binomialCDF(n, p):
map(cells, cell -> n*(cdf(cell[2]) - cdf(cell[1])))
```

```
[30.86497068, 23.11449119, 21.81461745, 24.20592068]
```

We create a random sample and apply the `Symbol::chi^2` test on page 30-97:

```
r := stats::binomialRandom(n, p, Seed = 123):
data := [r() $ i = 1..100]:
stats::csGOFT(data, cells, CDF = cdf)
```

```
[PValue = 0.3394635837, StatValue = 3.359377148,
MinimalExpectedCellFrequency = 21.81461745]
```

The observed significance level **0.339...** is not small, i.e., the data pass the test well.

The `trial parameter'  $n = 100$  is large enough for the binomial distribution to be approximated by a normal distribution with mean  $np$  and variance  $np(1 - p)$ . The data pass the test for a normal distribution, too:

```
cdf := stats::normalCDF(n*p, n*p*(1 - p)):
stats::csGOFTest(data, cells, CDF = cdf)
```

```
[PValue = 0.1547938521, StatValue = 5.243756673,
MinimalExpectedCellFrequency = 22.57468822]
```

We repeat the test with another cell partitioning:

```
quantile := stats::normalQuantile(n*p, n*p*(1 - p)):
cells := stats::equiprobableCells(4, quantile)
```

```
[[-∞, 46.62755125], [46.62755125, 50.0], [50.0, 53.37244875], [53.37244875, ∞]]
```

```
stats::csGOFTest(data, cells, CDF = cdf)
```

```
[PValue = 0.1422716505, StatValue = 5.44, MinimalExpectedCellFrequency = 25.0]
```

```
delete k, quantile, cells, cdf, r, data:
```

## Example 4

We demonstrate user-defined quantile functions. We consider the following distribution of a random variable  $X$  supported on the interval  $[0, 1]$ :

$$\Pr(X \leq x) = \begin{cases} 0 & \text{if } x < 0 \\ x^2 & \text{if } 0 \leq x \leq 1 \\ 1 & \text{if } x > 1 \end{cases}$$

The quantile function  $q$  is given by  $q(x) = \sqrt{x}$  for  $0 \leq x \leq 1$ :

```
quantile := x -> sqrt(x):
```

We test the hypothesis that the following data are distributed as defined above.

```
cells := stats::equiprobableCells(6, quantile)
```

```
[[0.0, 0.4082482905], [0.4082482905, 0.5773502692], [0.5773502692, 0.7071067812],
 [0.7071067812, 0.8164965809], [0.8164965809, 0.9128709292], [0.9128709292, 1.0]]
```

```
data := [sqrt(frandom()) $ i = 1..10^3]:
cdf := proc(x)
  begin
    if x <= 0 then return(0)
    elif x <= 1 then return(x^2)
    else return(1)
    end_if
  end_proc:
stats::csG0FT(data, cells, CDF = cdf)
```

```
[PValue = 0.2230310886, StatValue = 6.968, MinimalExpectedCellFrequency = 166.6666667]
```

The data pass the test well. In fact, for a uniform deviate  $Y$  on the interval  $[0, 1]$  (as produced by `frandom`), the cumulative distribution function of  $\sqrt{Y}$  is indeed given by *cdf*.

```
delete quantile, cells, data, cdf:
```

## Parameters

**k**

The number of cells: a positive integer

**q**

A procedure on page 1-1654 representing a quantile function of a statistical distribution. Typically, *q* is one of the quantile functions of the `stats`-package such as `stats::normalQuantile(m, v)`, `stats::empiricalQuantile(data)` etc. Alternatively, user defined procedures may be passed if the `stats`-package does not provide a suitable quantile function.

## Options

### NoWarning

`stats::equiprobableCells` issues warnings if the computed cell partitioning is not suitable for `stats::csG0FT`. These warnings may be switched off with this option.

## Return Values

List of  $k$  "cells"

$$\left[ [b_0, b_1], [b_1, b_2], \dots, [b_{k-1}, b_k] \right]$$

with floating-point values  $b_i = q\left(\frac{i}{k}\right)$ ,  $i = 0, \dots, k$ . This 'cell partitioning' is suitable as input parameter for `stats::csG0FT`.

## See Also

### MuPAD Functions

`stats::csG0FT`

# stats::erlangCDF

Cumulative distribution function of the Erlang distribution

## Syntax

```
stats::erlangCDF(a, b)
```

## Description

`stats::erlangCDF(a, b)` returns a procedure representing the cumulative distribution function

$$x \rightarrow \begin{cases} \frac{b^a}{\Gamma(a)} \int_0^x t^{a-1} e^{-tb} dt & \text{if } x > 0 \\ 0 & \text{if } x \leq 0 \end{cases}$$

of the Erlang distribution with shape parameter  $a > 0$  and scale parameter  $b > 0$ .

The procedure `f := stats::erlangCDF(a, b)` can be called in the form `f(x)` with an arithmetical expression  $x$ . The return value of `f(x)` is either a floating-point number or a symbolic expression:

If  $x \leq 0$  can be decided, then `f(x)` returns 0. If  $x \geq 0$  can be decided, then `f(x)` returns

the value  $1 - \frac{\Gamma(a, x b)}{\Gamma(a)}$ .

If  $x$  is a floating-point number and both  $a$  and  $b$  can be converted to positive floating-point numbers, then these values are returned as floating-point numbers. Otherwise, symbolic expressions are returned.

The function `f` reacts to properties of identifiers set via `assume`. If  $x$  is a symbolic expression with the property  $x \leq 0$  or  $x \geq 0$ , the corresponding values are returned.

The call `f(-infinity)` returns 0.

The call `f( infinity )` returns 1.

`f(x)` returns the symbolic call `stats::erlangCDF(a, b)(x)` if neither  $x \leq 0$  nor  $x \geq 0$  can be decided.

Numerical values for `a` and `b` are only accepted if they are real and positive.

Note that, for large  $a$ , exact results may be costly to compute. If floating-point values are desired, it is recommended to pass floating-point arguments  $x$  to `f` rather than to compute exact results `f(x)` and convert them via `float`. Cf. "Example 4" on page 30-144 (Symbolic Math Toolbox).

Note that  $\text{stats::erlangCDF}(a, b) = \text{stats::gammaCDF}\left(a, \frac{1}{b}\right)$ .

## Environment Interactions

The function is sensitive to the environment variable `DIGITS` which determines the numerical working precision. The procedure generated by `stats::erlangCDF` reacts to properties of identifiers set via `assume`.

## Examples

### Example 1

We evaluate the cumulative probability function with  $a = 2$  and  $b = 1$  at various points:

```
f := stats::erlangCDF(2, 1):  
f(-infinity), f(-3), f(0.5), f(2/3), f(PI), f(infinity)
```

```
0, 0, 0.09020401043, 1 -  $\frac{5 e^{-\frac{2}{3}}}{3}$ , 1 -  $e^{-\pi} (\pi + 1)$ , 1
```

```
delete f:
```



## Example 2

If  $x$  is a symbolic object without properties, then it cannot be decided whether  $x \geq 0$  holds. A symbolic function call is returned:

```
f := stats::erlangCDF(a, b): f(x)
```

$$\text{stats::erlangCDF}(a, b)(x)$$

With suitable properties, it can be decided whether  $x \geq 0$  holds. An explicit expression is returned:

```
assume(0 <= x): f(x)
```

$$1 - \frac{\Gamma(a, b x)}{\Gamma(a)}$$

```
unassume(x): delete f:
```

## Example 3

We use symbolic arguments:

```
f := stats::erlangCDF(a, b): f(3), f(3.0)
```

$$1 - \frac{\Gamma(a, 3 b)}{\Gamma(a)}, 1.0 - \frac{1.0 \Gamma(a, 3.0 b)}{\Gamma(a)}$$

When numerical values are assigned to  $a$  and  $b$ , the function  $f$  starts to produce numerical values:

```
a := 2: b := 4: f(3), f(3.0)
```

$$1 - 13 e^{-12}, 0.9999201252$$

```
delete f, a, b:
```

## Example 4

We consider an Erlang distribution with large shape parameter:

```
f := stats::erlangCDF(2000, 2):
```

For floating-point approximations, one should not compute an exact result and convert it via `float`. For large shape parameter, it is faster to pass a floating-point argument to `f`. The following call takes some time, because an exact computation of the huge integer  $\Gamma(2000) = 1999!$  is involved:

```
float(f(1010))
```

```
0.6747900654
```

The following call is much faster:

```
f(float(1010))
```

```
0.6747900654
```

```
delete f:
```

## Parameters

**a**

The shape parameter: an arithmetical expression (Symbolic Math Toolbox) representing a positive real value

**b**

The scale parameter: an arithmetical expression (Symbolic Math Toolbox) representing a positive real value

## Return Values

procedure on page 1-1654.

## See Also

### MuPAD Functions

gamma | igamma | stats::erlangPDF | stats::erlangQuantile |  
stats::erlangRandom | stats::gammaCDF | stats::gammaPDF |  
stats::gammaQuantile | stats::gammaRandom

## stats::erlangPDF

Probability density function of the Erlang distribution

### Syntax

stats::erlangPDF(a, b)

### Description

stats::erlangPDF(a, b) returns a procedure representing the probability density function

$$x \rightarrow \begin{cases} \frac{b^a}{\Gamma(a)} x^{a-1} e^{-x/b} & \text{if } x > 0 \\ 0 & \text{if } x \leq 0 \end{cases}$$

of the Erlang distribution with shape parameter  $a > 0$  and scale parameter  $b > 0$ .

The procedure `f := stats::erlangPDF(a, b)` can be called in the form `f(x)` with an arithmetical expression `x`. The return value of `f(x)` is either a floating-point number or a symbolic expression:

If  $x \leq 0$  can be decided, then `f(x)` returns 0. If  $x > 0$  can be decided, then `f(x)` returns

the value  $\frac{x^{a-1} b^a}{\Gamma(a) e^{x/b}}$ .

If `x` is a floating-point number and both `a` and `b` can be converted to positive floating-point numbers, then these values are returned as floating-point numbers. Otherwise, symbolic expressions are returned.

The function `f` reacts to properties of identifiers set via `assume`. If `x` is a symbolic expression with the property  $x \leq 0$  or  $x > 0$ , the corresponding values are returned.

`f(-infinity)` and `f(infinity)` return 0.

$f(x)$  returns the symbolic call `stats::erlangPDF(a, b)(x)` if neither  $x \leq 0$  nor  $x > 0$  can be decided.

Numerical values for  $a$  and  $b$  are only accepted if they are real and positive.

Note that, for large  $a$ , exact results may be costly to compute. If floating-point values are desired, it is recommended to pass floating-point arguments  $x$  to  $f$  rather than to compute exact results  $f(x)$  and convert them via `float`. Cf. “Example 4” on page 30-148 (Symbolic Math Toolbox).

Note that  $\text{stats::erlangPDF}(a, b) = \text{stats::gammaPDF}\left(a, \frac{1}{b}\right)$ .

## Environment Interactions

The function is sensitive to the environment variable `DIGITS` which determines the numerical working precision. The procedure generated by `stats::erlangPDF` reacts to properties of identifiers set via `assume`.

## Examples

### Example 1

We evaluate the probability density function with  $a = 2$  and  $b = 1$  at various points:

```
f := stats::erlangPDF(2, 1):
f(-infinity), f(-PI), f(1/2), f(0.5), f(PI), f(infinity)
```

$$0, 0, \frac{e^{-\frac{1}{2}}}{2}, 0.3032653299, \pi e^{-\pi}, 0$$

```
delete f:
```

### Example 2

If  $x$  is a symbolic object without properties, then it cannot be decided whether  $x > 0$  holds. A symbolic function call is returned:

```
f := stats::erlangPDF(a, b): f(x)
```

```
stats::erlangPDF(a, b)(x)
```

With suitable properties, it can be decided whether  $x > 0$  holds. An explicit expression is returned:

```
assume(0 < x): f(x)
```

$$\frac{b^a x^{a-1} e^{-bx}}{\Gamma(a)}$$

```
unassume(x): delete f:
```

### Example 3

We use symbolic arguments:

```
f := stats::erlangPDF(a, b): f(x), f(3)
```

```
stats::erlangPDF(a, b)(x),  $\frac{3^{a-1} b^a e^{-3b}}{\Gamma(a)}$ 
```

When numerical values are assigned to **a** and **b**, the function **f** starts to produce numerical values:

```
a := 2: b := 1: f(3), f(3.0)
```

```
 $3 e^{-3}$ , 0.1493612051
```

```
delete f, a, b:
```

### Example 4

We consider an Erlang distribution with large shape parameter:

```
f := stats::erlangPDF(2000, 1):
```

For floating-point approximations, one should not compute an exact result and convert it via `float`. For large shape parameter, it is faster to pass a floating-point argument to `f`. The following call takes some time, because an exact computation of the huge integer  $\Gamma(2000) = 1999!$  is involved:

```
float(f(2010))
```

```
0.008657442277
```

The following call is much faster:

```
f(float(2010))
```

```
0.008657442277
```

```
delete f:
```

## Parameters

### **a**

The shape parameter: an arithmetical expression (Symbolic Math Toolbox) representing a positive real value

### **b**

The scale parameter: an arithmetical expression (Symbolic Math Toolbox) representing a positive real value

## Return Values

procedure on page 1-1654.

## See Also

### **MuPAD Functions**

gamma | stats::erlangCDF | stats::erlangQuantile | stats::erlangRandom |  
stats::gammaCDF | stats::gammaPDF | stats::gammaQuantile |  
stats::gammaRandom



# stats::erlangQuantile

Quantile function of the Erlang distribution

## Syntax

```
stats::erlangQuantile(a, b)
```

## Description

`stats::erlangQuantile(a, b)` returns a procedure representing the quantile function (inverse) of the cumulative distribution function `stats::erlangCDF(a, b)`. For  $0 \leq x \leq 1$ , the solution of  $\text{stats::erlangCDF}(a, b)(y) = x$  is given by

$$y = \text{stats::erlangQuantile}(a, b)(x)$$

The procedure `f := stats::erlangQuantile(a, b)` can be called in the form `f(x)` with an arithmetical expression `x`. The return value of `f(x)` is either a floating-point number, *infinity*, or a symbolic expression:

If `x` is a real number between 0 and 1 and `a` and `b` can be converted to positive floating-point numbers, then `f(x)` returns a positive floating-point number approximating the solution `y` of  $\text{stats::erlangCDF}(a, b)(y) = x$ .

The calls `f(0)` and `f(0.0)` produce `0.0` for all values of `a` and `b`.

The calls `f(1)` and `f(1.0)` produce *infinity* for all values of `a` and `b`.

In all other cases, `f(x)` returns the symbolic call `stats::erlangQuantile(a, b)(x)`.

Numerical values of `x` are only accepted if  $0 \leq x \leq 1$ .

Numerical values of `a` and `b` are only accepted if they are real and positive.

Note that  $\text{stats::erlangQuantile}(a, b) = \text{stats::gammaQuantile}\left(a, \frac{1}{b}\right)$ .

## Environment Interactions

The function is sensitive to the environment variable DIGITS which determines the numerical working precision.

### Examples

#### Example 1

We evaluate the quantile function with  $a = \pi$  and  $b = 11$  at various points:

```
f := stats::erlangQuantile(PI, 1/11):  
f(0), f(1/10), f(0.5), f(1 - 10^(-10)), f(1)  
  
0.0, 13.08489993, 30.96813726, 324.7230043, ∞
```

The value  $f(x)$  satisfies  $\text{stats::erlangCDF}(\pi, 1/11)(f(x)) = x$ :

```
stats::erlangCDF(PI, 1/11)(f(0.987654))  
  
0.987654
```

```
delete f:
```

#### Example 2

We use symbolic arguments:

```
f := stats::erlangQuantile(a, b): f(x), f(9/10)  
  
stats::erlangQuantile(a, b)(x), stats::erlangQuantile(a, b)( $\frac{9}{10}$ )
```

When positive real values are assigned to  $a$  and  $b$ , the function  $f$  starts to produce floating-point values:

```
a := 17: b := 1/6: f(0.999), f(1 - sqrt(2)/10^5)
```

195.7416524, 240.0294477

Numerical values for  $x$  are only accepted if  $0 \leq x \leq 1$ :

f(0.5)

100.0071221

f(2)

Error: Argument  $x$  must be between 0 and 1. [f]

delete f, a, b:

## Parameters

### **a**

The shape parameter: an arithmetical expression (Symbolic Math Toolbox) representing a positive real value

### **b**

The scale parameter: an arithmetical expression (Symbolic Math Toolbox) representing a positive real value

## Return Values

procedure on page 1-1654.

## See Also

### **MuPAD Functions**

`stats::erlangCDF` | `stats::erlangPDF` | `stats::erlangRandom` |  
`stats::gammaCDF` | `stats::gammaPDF` | `stats::gammaQuantile` |  
`stats::gammaRandom`

# stats::erlangRandom

Generate a random number generator for Erlang deviates

## Syntax

stats::erlangRandom(a, b, <Seed = n>)

## Description

stats::erlangRandom(a, b) returns a procedure that produces Erlang on page 30-141 deviates (random numbers) with shape parameter  $a > 0$  and scale parameter  $b > 0$ .

The procedure  $f := \text{stats::erlangRandom}(a, b)$  can be called in the form  $f()$ . The return value of  $f()$  is either a floating-point number or a symbolic expression:

If  $a$  and  $b$  can be converted to positive floating-point numbers, then  $f()$  returns a nonnegative floating-point number.

In all other cases,  $\text{stats::erlangRandom}(a, b)()$  is returned symbolically.

Numerical values of  $a$  and  $b$  are only accepted if they are real and positive.

The values  $X = f()$  are distributed randomly according to the cumulative distribution function of the Erlang distribution with parameters  $a$  and  $b$ . For any  $0 \leq x$ , the probability that  $X \leq x$  is given by

$$\frac{b^a}{\Gamma(a)} \int_0^x t^{a-1} e^{-tb} dt$$

Without the option `Seed = n`, an initial seed is chosen internally. This initial seed is set to a default value when MuPAD is started. Thus, each time MuPAD is started or re-initialized with the `reset` function, random generators produce the same sequences of numbers.

---

**Note** In contrast to the function `random`, the generators produced by `stats::erlangRandom` do not react to the environment variable `SEED`.

---

For efficiency, it is recommended to produce sequences of  $K$  random numbers via

```
f := stats::erlangRandom(a, b): f() $k = 1..K;
```

rather than by

```
stats::erlangRandom(a, b)() $k = 1..K;
```

The latter call produces a sequence of generators each of which is called once. Also note that

```
stats::erlangRandom(a, b, Seed = n)() $k = 1..K;
```

does not produce a random sequence, because a sequence of freshly initialized generators would be created each of them producing the same number.

Note that `stats::erlangRandom(a, b) = stats::gammaRandom(a, 1/b)`.

## Environment Interactions

The function is sensitive to the environment variable `DIGITS` which determines the numerical working precision.

## Examples

### Example 1

We generate Erlang deviates with parameters  $a = 2$  and  $b = \frac{3}{4}$ :

```
f := stats::erlangRandom(2, 3/4): f() $ k = 1..4
```

```
3.958784095, 3.891811185, 6.046842446, 3.142485711
```

```
delete f:
```

## Example 2

With symbolic parameters, no random floating-point numbers can be produced:

```
f := stats::erlangRandom(a, b): f()
```

```
stats::erlangRandom(a, b)()
```

When positive real numbers are assigned to *a* and *b*, the function *f* starts to produce random floating point numbers:

```
a := PI: b := 1/8: f() $ k = 1..4
```

```
19.74371462, 12.37357049, 13.40137346, 29.97534861
```

```
delete f, a, b:
```

## Example 3

We use the option *Seed = n* to reproduce a sequence of random numbers:

```
f := stats::erlangRandom(PI, 3, Seed = 1): f() $ k = 1..4
```

```
0.125771079, 1.179788536, 0.7213738523, 1.268143263
```

```
g := stats::erlangRandom(PI, 3, Seed = 1): g() $ k = 1..4
```

```
0.125771079, 1.179788536, 0.7213738523, 1.268143263
```

```
f() = g(), f() = g()
```

```
1.926015116 = 1.926015116, 1.1178812 = 1.1178812
```

```
delete f, g:
```

## Parameters

### **a**

The shape parameter: an arithmetical expression (Symbolic Math Toolbox) representing a positive real value

### **b**

The scale parameter: an arithmetical expression (Symbolic Math Toolbox) representing a positive real value

## Options

### **Seed**

Option, specified as `Seed = n`

Initializes the random generator with the integer seed `n`. `n` can also be the option `CurrentTime`, to make the seed depend on the current time.

This option serves for generating generators that return predictable sequences of pseudo-random numbers. The generator is initialized with the seed `n` which may be an arbitrary integer. Several generators with the same initial seed produce the same sequence of numbers.

When this option is used, the parameters `a` and `b` must be convertible to positive floating-point numbers at the time when the random generator is generated.

## Return Values

procedure on page 1-1654.



## See Also

### MuPAD Functions

stats::erlangCDF | stats::erlangPDF | stats::erlangQuantile |  
stats::gammaCDF | stats::gammaPDF | stats::gammaQuantile |  
stats::gammaRandom

## stats::exponentialCDF

Cumulative distribution function of the exponential distribution

### Syntax

```
stats::exponentialCDF(a, b)
```

### Description

`stats::exponentialCDF(a, b)` returns a procedure representing the cumulative distribution function

$$x \rightarrow \begin{cases} 1 - e^{-b(x-a)} & \text{if } x > a \\ 0 & \text{if } x \leq a \end{cases}$$

of the exponential distribution with real location parameter  $a$  and scale parameter  $b > 0$ .

The procedure `f := stats::exponentialCDF(a, b)` can be called in the form `f(x)` with an arithmetical expression  $x$ . The return value of `f(x)` is either a floating-point number or a symbolic expression:

If  $x \leq a$  can be decided, then `f(x)` returns 0. If  $x > a$  can be decided, then `f(x)` returns the value  $1 - e^{-b(x-a)}$ .

If  $x$  is a floating-point number and both  $a$  and  $b$  can be converted to floating-point numbers, then these values are returned as floating-point numbers. Otherwise, symbolic expressions are returned.

The function `f` reacts to properties of identifiers set via `assume`. If  $x$  is a symbolic expression with the property  $x \leq a$  or  $x > a$ , the corresponding values are returned.

`f(x)` returns the symbolic call `stats::exponentialCDF(a, b)(x)` if neither  $x \leq a$  nor  $x > a$  can be decided.

Numerical values for  $a$  and  $b$  are only accepted if they are real and  $b$  is positive.

## Environment Interactions

The function is sensitive to the environment variable DIGITS which determines the numerical working precision.

## Examples

### Example 1

We evaluate the cumulative distribution function with  $a = 0$  and  $b = 1$  at various points:

```
f := stats::exponentialCDF(0, 1):
f(-infinity), f(-PI), f(1/2), f(0.5), f(PI), f(infinity)
```

```
0, 0, 1 - e-1/2, 0.3934693403, 1 - e-π, 1
```

```
delete f:
```

### Example 2

If  $a$  or  $x$  are symbolic objects without properties, then it cannot be decided whether  $x \geq a$  holds. A symbolic function call is returned:

```
f := stats::exponentialCDF(a, b): f(x)
```

```
stats::exponentialCDF(a, b)(x)
```

With suitable properties, it can be decided whether  $x \geq a$  holds. An explicit expression is returned:

```
assume(a <= x): f(x)
```

```
1 - eb(a-x)
```

Note that `assume(a <= x)` attached properties both to `a` and `x`. When cleaning up, the properties have to be removed separately for `a` and `x` via `unassume`:

```
unassume(a): unassume(x): delete f:
```

### Example 3

We use symbolic arguments:

```
f := stats::exponentialCDF(a, b): f(x)
```

```
stats::exponentialCDF(a, b)(x)
```

When numerical values are assigned to `a` and `b`, the function `f` starts to produce numerical values:

```
a := 0: b := 2: f(3), f(3.0)
```

```
1 - e-6, 0.9975212478
```

```
delete f, a, b:
```

## Parameters

**a**

The location parameter: an arithmetical expression (Symbolic Math Toolbox) representing a real value

**b**

The scale parameter: an arithmetical expression (Symbolic Math Toolbox) representing a positive real value

## Return Values

procedure on page 1-1654.

## See Also

### MuPAD Functions

exp | stats::exponentialPDF | stats::exponentialQuantile |  
stats::exponentialRandom

## stats::exponentialPDF

Probability density function of the exponential distribution

### Syntax

```
stats::exponentialPDF(a, b)
```

### Description

stats::exponentialPDF(a, b) returns a procedure representing the probability density function

$$x \rightarrow \begin{cases} b e^{-b(x-a)} & \text{if } x \geq a \\ 0 & \text{if } x < a \end{cases}$$

of the exponential distribution with real location parameter  $a$  and scale parameter  $b > 0$ .

The procedure `f := stats::exponentialPDF(a, b)` can be called in the form `f(x)` with an arithmetical expression  $x$ . The return value of `f(x)` is either a floating-point number or a symbolic expression:

If  $x < a$  can be decided, then `f(x)` returns 0. If  $x \geq a$  can be decided, then `f(x)` returns the value  $b e^{b(a-x)}$ .

If  $x$  is a floating-point number and both  $a$  and  $b$  can be converted to floating-point numbers, then these values are returned as floating-point numbers. Otherwise, symbolic expressions are returned.

The function `f` reacts to properties of identifiers set via `assume`. If  $x$  is a symbolic expression with the property  $x < a$  or  $x \geq a$ , the corresponding values are returned.

`f(x)` returns the symbolic call `stats::exponentialPDF(a, b)(x)` if neither  $x < a$  nor  $x \geq a$  can be decided.

Numerical values for  $a$  and  $b$  are only accepted if they are real and  $b$  is positive.

## Environment Interactions

The function is sensitive to the environment variable DIGITS which determines the numerical working precision.

## Examples

### Example 1

We evaluate the probability density function with  $a = 0$  and  $b = 1$  at various points:

```
f := stats::exponentialPDF(0, 1):
f(-infinity), f(-PI), f(1/2), f(0.5), f(PI), f(infinity)
```

```
0, 0, e-1/2, 0.6065306597, e-π, 0
```

```
delete f:
```

### Example 2

If  $a$  or  $x$  are symbolic objects without properties, then it cannot be decided whether  $x \geq a$  holds. A symbolic function call is returned:

```
f := stats::exponentialPDF(a, b): f(x)
```

```
stats::exponentialPDF(a, b)(x)
```

With suitable properties, it can be decided whether  $x \geq a$  holds. An explicit expression is returned:

```
assume(a <= x): f(x)
```

```
b eb(a-x)
```

Note that `assume(a <= x)` attached properties both to `a` and `x`. When cleaning up, the properties have to be removed separately for `a` and `x` via `unassume`:

```
unassume(a): unassume(x): delete f:
```

### Example 3

We use symbolic arguments:

```
f := stats::exponentialPDF(a, b): f(x)
```

```
stats::exponentialPDF(a, b)(x)
```

When numerical values are assigned to `a` and `b`, the function `f` starts to produce numerical values:

```
a := 0: b := 2: f(3), f(3.0)
```

```
2 e-6, 0.004957504353
```

```
delete f, a, b:
```

## Parameters

**a**

The location parameter: an arithmetical expression (Symbolic Math Toolbox) representing a real value

**b**

The scale parameter: an arithmetical expression (Symbolic Math Toolbox) representing a positive real value

## Return Values

procedure on page 1-1654.



## See Also

### MuPAD Functions

stats::exponentialCDF | stats::exponentialQuantile |  
stats::exponentialRandom

## stats::exponentialQuantile

Quantile function of the exponential distribution

### Syntax

```
stats::exponentialQuantile(a, b)
```

### Description

`stats::exponentialQuantile(a, b)` returns a procedure representing the quantile function (inverse)

$$x \rightarrow a - \frac{\ln(1-x)}{b}$$

of the cumulative distribution function `stats::exponentialCDF(a, b)`. For  $0 \leq x \leq 1$ , the solution of `stats::exponentialCDF(a, b)(y) = x` is given by

$$y = \text{stats::exponentialQuantile}(a, b)(x)$$

The procedure `f := stats::exponentialQuantile(a, b)` can be called in the form `f(x)` with an arithmetical expression `x`. The return value of `f(x)` is either a floating-point number, `infinity`, or a symbolic expression:

If `x` is a real floating-point number between 0 and 1 and `a` and `b` can be converted to suitable real floating-point numbers, then `f(x)` returns a floating-point number.

The calls `f(1)` and `f(1.0)` produce `infinity`.

In all other cases, `f(x)` returns the symbolic expression `a - ln(1-x)/b`.

Numerical values of `x` are only accepted if  $0 \leq x \leq 1$ .

Numerical values of `a` and `b` are only accepted if they are real and `b` is positive.

## Environment Interactions

The function is sensitive to the environment variable DIGITS, which determines the numerical working precision.

## Examples

### Example 1

We evaluate the quantile function with  $a = 2$  and  $b = 3$  at various points:

```
f := stats::exponentialQuantile(2, 3):
f(0), f(1/10), f(0.5), f(1 - 10^(-10)), f(1)
```

$$2, 2 - \frac{\ln(\frac{9}{10})}{3}, 2.23104906, \frac{\ln(10000000000)}{3} + 2, \infty$$

The value  $f(x)$  satisfies  $\text{stats::exponentialCDF}(2, 3)(f(x)) = x$ :

```
stats::exponentialCDF(2, 3)(f(0.987654))
```

```
0.987654
```

```
delete f:
```

### Example 2

We use symbolic arguments:

```
f := stats::exponentialQuantile(a, b): f(x), f(1/3), f(0.4)
```

$$a - \frac{\ln(1-x)}{b}, a - \frac{\ln(\frac{2}{3})}{b}, a + \frac{0.5108256238}{b}$$

When suitable numerical values are assigned to  $a$  and  $b$ , the function  $f$  starts to produce numerical values:

```
a := 7: b := 1/8: f(0.999), f(999/1000)
```

```
62.26204223, 8 ln(1000) + 7
```

Numerical values for  $x$  are only accepted if  $0 \leq x \leq 1$ :

```
f(0.5)
```

```
12.54517744
```

```
f(2)
```

```
Error: Argument x must be between 0 and 1. [f]
```

```
delete f, a, b:
```

## Parameters

**a**

The location parameter: an arithmetical expression (Symbolic Math Toolbox) representing a real value

**b**

The scale parameter: an arithmetical expression (Symbolic Math Toolbox) representing a positive real value

## Return Values

procedure on page 1-1654.

## See Also

### MuPAD Functions

stats::exponentialCDF | stats::exponentialPDF |  
stats::exponentialRandom

## stats::exponentialRandom

Generate a random number generator for exponential deviates

### Syntax

```
stats::exponentialRandom(a, b, <Seed = n>)
```

### Description

`stats::exponentialRandom(a, b)` returns a procedure that produces exponential on page 30-160 deviates (random numbers) with real location parameter  $a$  and scale parameter  $b > 0$ .

The procedure `f := stats::exponentialRandom(a, b)` can be called in the form `f()`. The return value of `f()` is either a floating-point number or a symbolic expression:

If  $a$  can be converted to a real floating point number and  $b$  to a positive floating-point number, then `f()` returns nonnegative floating-point number.

In all other cases, `stats::exponentialRandom(a, b)()` is returned symbolically.

Numerical values of  $a$  and  $b$  are only accepted if they are real and  $b$  is positive.

The values  $X = f()$  are distributed randomly according to the cumulative distribution function of the exponential distribution with parameters  $a$  and  $b$ . For real  $x \geq a$ , the probability that  $X \leq x$  is given by

$$1 - \frac{1}{e^{b(-a+x)}}$$

Without the option `Seed = n`, an initial seed is chosen internally. This initial seed is set to a default value when MuPAD is started. Thus, each time MuPAD is started or re-initialized with the `reset` function, random generators produce the same sequences of numbers.

---

**Note** In contrast to the function `random`, the generators produced by `stats::exponentialRandom` do not react to the environment variable `SEED`.

---

For efficiency, it is recommended to produce sequences of  $K$  random numbers via

```
f := stats::exponentialRandom(a, b): f() $k = 1..K;
```

rather than by

```
stats::exponentialRandom(a, b)() $k = 1..K;
```

The latter call produces a sequence of generators each of which is called once. Also note that

```
stats::exponentialRandom(a, b, Seed = n)() $k = 1..K;
```

does not produce a random sequence, because a sequence of freshly initialized generators would be created each of them producing the same number.

## Environment Interactions

The function is sensitive to the environment variable `DIGITS` which determines the numerical working precision.

## Examples

### Example 1

We generate exponential deviates with parameters  $a = 2$  and  $b = \frac{3}{4}$ :

```
f := stats::exponentialRandom(2, 3/4): f() $ k = 1..4
```

```
3.744010213, 2.246774327, 4.501726533, 2.006934293
```

```
delete f:
```

## Example 2

With symbolic parameters, no random floating-point numbers can be produced:

```
f := stats::exponentialRandom(a, b): f()
```

```
stats::exponentialRandom(a, b)()
```

When  $a$  and  $b$  evaluate to suitable real numbers,  $f$  starts to produce random floating-point numbers:

```
a := PI: b := 1/8: f() $ k = 1..4
```

```
13.72746104, 16.8526844, 9.492707582, 6.241235276
```

```
delete f, a, b:
```

## Example 3

We use the option `Seed = n` to reproduce a sequence of random numbers:

```
f := stats::exponentialRandom(PI, 1/2, Seed = 1): f() $ k = 1..4
```

```
4.275085081, 3.608946643, 7.462091361, 6.63997707
```

```
g := stats::exponentialRandom(PI, 1/2, Seed = 1): g() $ k = 1..4
```

```
4.275085081, 3.608946643, 7.462091361, 6.63997707
```

```
f() = g(), f() = g()
```

```
3.504644667 = 3.504644667, 14.68155806 = 14.68155806
```

```
delete f, g:
```



## Parameters

### **a**

The location parameter: an arithmetical expression (Symbolic Math Toolbox) representing a real value

### **b**

The scale parameter: an arithmetical expression (Symbolic Math Toolbox) representing a positive real value

## Options

### **Seed**

Option, specified as `Seed = n`

Initializes the random generator with the integer seed `n`. `n` can also be the option `CurrentTime`, to make the seed depend on the current time.

This option serves for generating generators that return predictable sequences of pseudo-random numbers. The generator is initialized with the seed `n` which may be an arbitrary integer. Several generators with the same initial seed produce the same sequence of numbers.

When this option is used, the parameters `a` and `b` must be convertible to suitable floating-point numbers at the time when the random generator is generated.

## Return Values

procedure on page 1-1654.

## Algorithms

The implemented algorithm for the computation of the exponential deviates uses the quantile function of the exponential distribution applied to uniformly distributed random numbers between 0 and 1.

## See Also

### **MuPAD Functions**

`stats::exponentialCDF` | `stats::exponentialPDF` |  
`stats::exponentialQuantile`

## stats::fCDF

Cumulative distribution function of Fisher's f-distribution (fratio distribution)

### Syntax

stats::fCDF(a, b)

### Description

stats::fCDF(a, b) returns a procedure representing the cumulative distribution function

$$x \rightarrow \begin{cases} \frac{\left(\frac{a}{b}\right)^{a/2}}{\beta\left(\frac{a}{2}, \frac{b}{2}\right)} \int_0^x \frac{t^{\frac{a}{2}-1}}{\left(\frac{at}{b}+1\right)^{\frac{a}{2}+\frac{b}{2}}} dt & \text{if } x > 0 \\ 0 & \text{if } x \leq 0 \end{cases}$$

of Fisher's f-distribution with shape parameters  $a > 0, b > 0$ .

The procedure `f:=stats::fCDF(a, b)` can be called in the form `f(x)` with an arithmetical expression `x`. The return value of `f(x)` is either a floating-point number or a symbolic expression:

If `x` can be converted to a real floating point number and the shape parameters can be converted to positive floating-point numbers, then `f(x)` returns a floating point number between 0.0 and 1.0.

For all values of `a` and `b`, the call `f(x)` returns `0.0` if `x` is a nonpositive numerical value or a symbolic expression with the property on page 1-265  $x \leq 0$ .

The call `f(- infinity )` returns 0.0.

The call `f( infinity )` returns 1.0.

In all other cases, `f(x)` returns the symbolic call `stats::fCDF(a, b)(x)`.

Numerical values for  $a$  and  $b$  are only accepted if they are real and positive.

## Environment Interactions

The function is sensitive to the environment variable DIGITS which determines the numerical working precision. It reacts to properties of identifiers set via `assume`.

## Examples

### Example 1

We evaluate the cumulative distribution function with  $a = 2$  and  $b = 1$  at various points:

```
f := stats::fCDF(2, 1):  
f(-infinity), f(-3), f(0.5), f(2/3), f(PI), f(infinity)
```

```
0.0, 0.0, 0.2928932188, 0.3453463293, 0.629456397, 1.0
```

```
delete f:
```

### Example 2

If  $x$  is a symbolic object without properties, then it cannot be decided whether  $x \leq 0$  holds. A symbolic function call is returned:

```
f := stats::fCDF(a, b): f(x)
```

```
stats::fCDF(a, b)(x)
```

With suitable properties, it can be decided whether  $x \leq 0$  holds. The value 0.0 is returned:

```
assume(x <= 0): f(x)
```

```
0.0
```

MuPAD does not provide a special function to represent the cumulative distribution function for positive arguments. A symbolic call is returned:

```
assume(x > 0): f(x)
```

```
stats::fCDF(a, b)(x)
```

```
unassume(x): delete f:
```

### Example 3

We use symbolic arguments:

```
f := stats::fCDF(a, b): f(x), f(2)
```

```
stats::fCDF(a, b)(x), stats::fCDF(a, b)(2)
```

When numerical values are assigned to **a** and **b**, the function **f** starts to produce floating-point numbers for numerical arguments:

```
a := 2: b := 1: f(2)
```

```
0.5527864045
```

```
delete f, a, b:
```

## Parameters

**a, b**

The shape parameters: arithmetical expressions (Symbolic Math Toolbox) representing positive real values

## Return Values

procedure on page 1-1654.

## See Also

### MuPAD Functions

`stats::fPDF` | `stats::fQuantile` | `stats::fRandom`

## stats::fPDF

Probability density function of Fisher's f-distribution (fratio distribution)

### Syntax

`stats::fPDF(a, b)`

### Description

`stats::fPDF(a, b)` returns a procedure representing the probability density function

$$x \rightarrow \begin{cases} \frac{\left(\frac{a}{b}\right)^{a/2} x^{\frac{a}{2}-1}}{\beta\left(\frac{a}{2}, \frac{b}{2}\right)} & \text{if } x > 0 \\ \left(\frac{ax}{b} + 1\right)^{\frac{a}{2} + \frac{b}{2}} & \\ 0 & \text{if } x \leq 0 \end{cases}$$

of Fisher's f-distribution with shape parameters  $a > 0$ ,  $b > 0$ .

The procedure `f:=stats::fPDF(a, b)` can be called in the form `f(x)` with an arithmetical expression  $x$ . The return value of `f(x)` is either a floating-point number or a symbolic expression:

If  $x \leq 0$  can be decided, then `f(x)` returns 0. If  $x > 0$  can be decided, then `f(x)` returns the value

$$\frac{\left(\frac{a}{b}\right)^{a/2} x^{\frac{a}{2}-1}}{\beta\left(\frac{a}{2}, \frac{b}{2}\right) \left(\frac{ax}{b} + 1\right)^{\frac{a}{2} + \frac{b}{2}}}$$

If  $x$  is a floating-point number and both  $a$  and  $b$  can be converted to positive floating-point numbers, then these values are returned as floating-point numbers. Otherwise, symbolic expressions are returned.

The function `f` reacts to properties of identifiers set via `assume`. If  $x$  is a symbolic expression with the property  $x \leq 0$  or  $x \geq 0$ , the corresponding values are returned.

`f(-infinity)` and `f(infinity)` return 0.

`f(x)` returns the symbolic call `stats::fPDF(a, b)(x)` if neither  $x \leq 0$  nor  $x > 0$  can be decided.

Numerical values for  $a$  and  $b$  are only accepted if they are real and positive.

## Environment Interactions

The function is sensitive to the environment variable `DIGITS` which determines the numerical working precision. It reacts to properties of identifiers set via `assume`.

## Examples

### Example 1

We evaluate the probability density function with  $a = 2$  and  $b = 4$  at various points:

```
f := stats::fPDF(2, 4):  
f(-infinity), f(-PI), f(1/2), f(0.5), f(PI), f(infinity)
```

$0, 0, \frac{64}{125}, 0.512, \frac{1}{(\frac{\pi}{2} + 1)^3}, 0$

```
delete f:
```

### Example 2

If  $x$  is a symbolic object without properties, then it cannot be decided whether  $x \geq 0$  holds. A symbolic function call is returned:



```
f := stats::fPDF(a, b): f(x)
```

```
stats::fPDF(a, b)(x)
```

With suitable properties, it can be decided whether  $x \geq 0$  holds. An explicit expression is returned:

```
assume(0 <= x): f(x)
```

$$\frac{x^{\frac{a}{2}-1} \left(\frac{a}{b}\right)^{a/2}}{\left(\frac{ax}{b} + 1\right)^{\frac{a}{2} + \frac{b}{2}} \beta\left(\frac{a}{2}, \frac{b}{2}\right)}$$

```
unassume(x): delete f:
```

### Example 3

We use symbolic arguments:

```
f := stats::fPDF(a, b): f(x)
```

```
stats::fPDF(a, b)(x)
```

When numerical values are assigned to **a** and **b**, the function **f** starts to produce numerical values:

```
a := 2: b := 1: f(3), f(3.0)
```

$$\frac{\sqrt{7}}{49}, 0.05399492472$$

```
delete f, a, b:
```

## Parameters

**a, b**

The shape parameters: arithmetical expressions (Symbolic Math Toolbox) representing positive real values

## Return Values

procedure on page 1-1654.

## See Also

### **MuPAD Functions**

`stats::fCDF` | `stats::fQuantile` | `stats::fRandom`

# stats::fQuantile

Quantile function of Fisher's f-distribution (fratio distribution)

## Syntax

```
stats::fQuantile(a, b)
```

## Description

`stats::fQuantile(a, b)` returns a procedure representing the quantile function (inverse) of the cumulative distribution function `stats::fCDF(a, b)`. For  $0 \leq x \leq 1$ , the solution of  $stats::fCDF(a, b)(y) = x$  is given by  $y = stats::fQuantile(a, b)(x)$ .

The procedure `f:=stats::fQuantile(a, b)` can be called in the form `f(x)` with arithmetical expressions `x`. The return value of `f(x)` is either a floating-point number, *infinity*, or a symbolic expression:

If `x` is a real number between 0 and 1 and `a` and `b` can be converted to positive floating-point numbers, then `f(x)` returns a positive floating-point number approximating the solution `y` of  $stats::fCDF(a, b)(y) = x$ .

The calls `f(0)` and `f(0.0)` produce 0.0 for all values of `a` and `b`.

The calls `f(1)` and `f(1.0)` produce *infinity* for all values of `a` and `b`.

In all other cases, `f(x)` returns the symbolic call `stats::fQuantile(a, b)(x)`.

Numerical values of `x` are only accepted if  $0 \leq x \leq 1$ .

Numerical values of `a` and `b` are only accepted if they are real and positive.

## Environment Interactions

The function is sensitive to the environment variable `DIGITS` which determines the numerical working precision. The procedure generated by `stats::fQuantile` is sensitive to properties of identifiers, which can be set via `assume`.

## Examples

### Example 1

We evaluate the quantile function with  $a = \pi$  and  $b = 11$  at various points:

```
f := stats::fQuantile(PI, 11):  
f(0), f(1/10), f(0.5), f(1 - 10^(-10)), f(1)
```

```
0.0, 0.2017865341, 0.8492236618, 280.937214, ∞
```

The value  $f(x)$  satisfies  $\text{stats}::\text{fCDF}(\pi, 11)(f(x)) = x$ :

```
stats::fCDF(PI, 11)(f(0.987654321))
```

```
0.987654321
```

```
delete f:
```

### Example 2

We use symbolic arguments:

```
f := stats::fQuantile(a, b): f(x), f(9/10)
```

```
stats::fQuantile(a, b)(x), stats::fQuantile(a, b)( $\frac{9}{10}$ )
```

When positive real values are assigned to  $a$  and  $b$ , the function  $f$  starts to produce floating-point values:

```
a := 17: b := 6: f(0.999), f(1 - sqrt(2)/10^5)
```

```
17.35343418, 75.00107347
```

Numerical values for  $x$  are only accepted if  $0 \leq x \leq 1$ :

```
f(0.5)
```

1.077968248

f(2)

Error: Argument x must be between 0 and 1. [f]

delete f, a, b:

## Parameters

**a, b**

The shape parameters: arithmetical expressions (Symbolic Math Toolbox) representing positive real values

## Return Values

procedure on page 1-1654.

## See Also

### MuPAD Functions

stats::fCDF | stats::fPDF | stats::fRandom

## stats::fRandom

Generate a random number generator for Fisher's f-deviates (fratio deviates)

### Syntax

`stats::fRandom(a, b, <Seed = n>)`

### Description

`stats::fRandom(a, b)` returns a procedure that produces  $f$  on page 30-177-deviates (random numbers) with shape parameters  $a > 0, b > 0$ .

The procedure `f:=stats::fRandom(a, b)` can be called in the form `f()`. The return value of `f()` is either a floating-point number or a symbolic expression:

If  $a$  and  $b$  can be converted to positive floating-point numbers, then `f()` returns a positive floating-point number.

In all other cases, `stats::fRandom(a, b)()` is returned symbolically.

Numerical values of  $a$  and  $b$  are only accepted if they are real and positive.

The values  $X = f()$  are distributed randomly according to the cumulative distribution function of the f-distribution with shape parameters  $a$  and  $b$ . For  $0 \leq x$ , the probability that  $X \leq x$  is given by

$$\frac{\left(\frac{a}{b}\right)^{a/2}}{\beta\left(\frac{a}{2}, \frac{b}{2}\right)} \int_0^x \frac{t^{a/2-1}}{\left(\frac{at}{b} + 1\right)^{\frac{a}{2} + \frac{b}{2}}} dt$$

Without the option `Seed = n`, an initial seed is chosen internally. This initial seed is set to a default value when MuPAD is started. Thus, each time MuPAD is started or re-initialized with the `reset` function, random generators produce the same sequences of numbers.

---

**Note** In contrast to the function `random`, the generators produced by `stats::fRandom` do not react to the environment variable `SEED`.

---

For efficiency, it is recommended to produce sequences of  $K$  random numbers via

```
f := stats::fRandom(a, b): f() $k = 1..K;
```

rather than by

```
stats::fRandom(a, b)() $k = 1..K;
```

The latter call produces a sequence of generators each of which is called once. Also note that

```
stats::fRandom(a, Seed = n)() $k = 1..K;
```

does not produce a random sequence, because a sequence of freshly initialized generators would be created each of them producing the same number.

## Environment Interactions

The function is sensitive to the environment variable `DIGITS` which determines the numerical working precision.

## Examples

### Example 1

We generate  $f$ -deviates with shape parameters  $a = 2$  and  $b = \frac{3}{4}$ :

```
f := stats::fRandom(2, 3/4): f() $ k = 1..4
```

```
0.06381499229, 4.951243823, 4.433412266, 2.189546079
```

```
delete f:
```

## Example 2

With symbolic parameters, no random floating-point numbers can be produced:

```
f := stats::fRandom(a, b): f()  
  
stats::fRandom(a, b())
```

When the shape parameters evaluate to positive real numbers, f starts to produce random floating-point numbers:

```
a := PI: b := 8: f()  
  
1.641736211
```

```
delete f, a, b:
```

## Example 3

We use the option Seed = n to reproduce a sequence of random numbers:

```
f := stats::fRandom(4, 5, Seed = 1): f() $ k = 1..4  
  
0.002660717454, 1.586532187, 0.6498965358, 0.8953358537  
  
g := stats::fRandom(4, 5, Seed = 1): g() $ k = 1..4  
  
0.002660717454, 1.586532187, 0.6498965358, 0.8953358537  
  
f() = g(), f() = g()  
  
1.672785971 = 1.672785971, 0.5207718594 = 0.5207718594  
  
delete f, g:
```



## Parameters

**a, b**

The shape parameters: arithmetical expressions (Symbolic Math Toolbox) representing positive real values

## Options

**Seed**

Option, specified as `Seed = n`

Initializes the random generator with the integer seed `n`. `n` can also be the option `CurrentTime`, to make the seed depend on the current time.

This option serves for generating generators that return predictable sequences of pseudo-random numbers. The generator is initialized with the seed `n` which may be an arbitrary integer. Several generators with the same initial seed produce the same sequence of numbers.

When this option is used, the shape parameters `a` and `b` must be convertible to positive floating-point numbers at the time when the random generator is generated.

## Return Values

procedure on page 1-1654.

## Algorithms

The implemented algorithm uses independent gamma on page 30-236 deviates `X` and `Y` to produce an f-deviate  $\frac{b}{a} \frac{X}{Y}$ . For more information see: D. Knuth, Seminumerical Algorithms (1998), Vol. 2, p. 135.

## See Also

### MuPAD Functions

`stats::fCDF` | `stats::fPDF` | `stats::fQuantile`

# stats::finiteCDF

Cumulative distribution function of a finite sample space

## Syntax

```
stats::finiteCDF([x1, x2, ...], [p1, p2, ...])
```

```
stats::finiteCDF([[x1, p1], [x2, p2], ...])
```

```
stats::finiteCDF(s, <c1, c2>)
```

```
stats::finiteCDF(s, <[c1, c2]>)
```

## Description

stats::finiteCDF([x<sub>1</sub>, x<sub>2</sub>, ..., x<sub>n</sub>], [p<sub>1</sub>, p<sub>2</sub>, ..., p<sub>n</sub>]) returns a procedure

representing the cumulative distribution function  $x \rightarrow \sum_{i=1}^k p_i$  of the finite sample space consisting of the data elements x<sub>1</sub>, ..., x<sub>n</sub> with the probabilities p<sub>1</sub>, ..., p<sub>n</sub>. Here,

$k = |\{j \mid x_j \leq x\}|$ , i.e., x<sub>k</sub> is the largest element of the data sample less or equal to x (the data elements are assumed to be ordered: x<sub>1</sub> < x<sub>2</sub> < x<sub>3</sub> etc.)

The procedure `f := stats::finiteCDF([x1, x2, ...], [p1, p2, ...])` can be called in the form `f(x)` with an arithmetical expression `x`.

If `x` is a numerical value and the data elements x<sub>1</sub>, x<sub>2</sub>, ... are all numerical, then `f(x)` returns an arithmetical expression (the sum of the probabilities of all data elements smaller or equal to `x`).

The call `f(- infinity )` produces 0; the call `f( infinity )` produces 1.

Otherwise, if `x` is a symbolic expression that cannot be converted to a real floating-point number or if the data x<sub>1</sub>, x<sub>2</sub>, ... contain elements that cannot be converted to real floating-point numbers, then `f(x)` returns the symbolic call `stats::finiteCDF([x1, x2, ...], [p1, p2, ...])(x)` with the data x<sub>1</sub>, x<sub>2</sub>, ... in ascending order.

If all probability values  $p_1, p_2, \dots$  are numerical, they must add up to 1. Otherwise, an error is raised.

Duplicate data elements are automatically combined to a single data element, adding up the corresponding probability values. Cf. "Example 5" on page 30-196 (Symbolic Math Toolbox).

The data elements  $x_1, x_2, \dots$  are assumed to be in ascending order:  $x_1 < x_2 < \dots$ . If all data elements are numerical, they are re-ordered automatically, if they are not ascending. If the data contain symbolic elements that cannot be converted to floating-point numbers, the ordering is assumed implicitly.

`stats::finiteCDF` generalizes `stats::empiricalCDF`, which assumes equiprobable data. For numerical data  $x_1, x_2, \dots$ , the call `stats::finiteCDF([x_1, dots, x_n], [1/n, dots, 1/n])` corresponds to `stats::empiricalCDF([x_1, ..., x_n])`.

## Environment Interactions

The function is sensitive to the environment variable `DIGITS` which determines the numerical working precision. Note, however, that this function is implemented with option `remember`. After the first call it does not react to changes of `DIGITS` unless the input parameters are changed.

## Examples

### Example 1

We evaluate the finite distribution function of some numerical data at various points:

```
f := stats::finiteCDF([1, 0, 2.3, PI], [p1, p0, 0.2, 0.3]):  
f(-infinity), f(0.1), f(2.3), f(PI), f(10), f(infinity)
```

```
0, p0, p0 + p1 + 0.2, p0 + p1 + 0.5, p0 + p1 + 0.5, 1
```

Alternatively, the data may be passed as a list:

```
f := stats::finiteCDF([[1, p1], [0, p0], [2.3, 0.2], [PI, 0.3]]):  
f(-infinity), f(0.1), f(2.3), f(PI), f(10), f(infinity)
```

```
0, p0, p0 + p1 + 0.2, p0 + p1 + 0.5, p0 + p1 + 0.5, 1
```

```
delete f:
```

## Example 2

We use symbolic arguments. In the symbolic return value, the input data appear as a sorted list:

```
stats::finiteCDF([3, 4, PI], [0.2, 0.5, 0.3])(x)
```

```
stats::finiteCDF([3,  $\pi$ , 4], [0.2, 0.3, 0.5])(x)
```

If the data contain symbolic elements, the return value is again a symbolic call:

```
stats::finiteCDF([3, x, PI], [0.2, 0.5, 0.3])(0.7)
```

```
stats::finiteCDF([3, x,  $\pi$ ], [0.2, 0.5, 0.3])(0.7)
```

## Example 3

We create a sample on page 30-413 consisting of one string column and two non-string columns:

```
s := stats::sample(
  [{"1996", 1242, 2/5},
   {"1997", 1353, 0.1},
   {"1998", 1142, 0.2},
   {"1999", 1201, 0.2},
   {"2001", 1201, 0.1}])
```

```
"1996" 1242 2/5
"1997" 1353 0.1
"1998" 1142 0.2
"1999" 1201 0.2
"2001" 1201 0.1
```

We compute values of the finite distributions of the data in the second and third column:

```
f := stats::finiteCDF(s, 2, 3):  
f(1000), f(1200), f(1201)
```

```
0, 0.2, 0.5
```

```
delete s, f:
```

### Example 4

If numerical probability values are given, they must add up to 1:

```
f := stats::finiteCDF([Head, TAIL], [0.45, 0.54]):
```

```
Error: Probabilities do not add up to 1. [stats::finiteCDF]
```

Symbolic probability values are not checked for consistency:

```
f := stats::finiteCDF([Head, TAIL], [0.45, p]):  
f(x)
```

```
stats::finiteCDF([Head, TAIL], [0.45, p])(x)
```

However, when the probabilities are set to numerical values, they are checked:

```
p:= 0.7: f(x)
```

```
Error: Probabilities do not add up to 1. [f]
```

```
delete f, p:
```

### Example 5

Duplicate data elements are automatically combined to a single data element, adding up the corresponding probability values:

```
f:= stats::finiteCDF([x1, x2, x1, x2], [0.1, 0.2, 0.3, 0.4]):  
f(3)
```

```
stats::finiteCDF([x1, x2], [0.4, 0.6])(3)
```

```
x1 := 1: x2 := 3: f(2)
```

```
0.4
```

```
delete f, x1, x2:
```

## Parameters

**$x_1, x_2, \dots$**

The statistical data: arbitrary MuPAD objects

**$p_1, p_2, \dots$**

Probability values: arithmetical expressions

**$s$**

A sample of domain type `stats::sample`

**$c_1, c_2$**

Column indices of the sample  $s$ : positive integers. Column  $c_1$  provides the data  $x_1, x_2$  etc. Column  $c_2$  provides the data  $p_1, p_2$  etc. There is no need to specify column numbers if the sample has only two columns.

## Return Values

procedure on page 1-1654.

## See Also

### MuPAD Functions

`stats::empiricalCDF` | `stats::empiricalPF` | `stats::empiricalQuantile` |  
`stats::empiricalRandom` | `stats::finitePF` | `stats::finiteQuantile` |  
`stats::finiteRandom`

## stats::finitePF

Probability function of a finite sample space

### Syntax

```
stats::finitePF([x1, x2, ...], [p1, p2, ...])
```

```
stats::finitePF([[x1, p1], [x2, p2], ...])
```

```
stats::finitePF(n, <c1, c2>)
```

```
stats::finitePF(n, <[c1, c2]>)
```

### Description

`stats::finitePF([x1, x2, ..., xn], [p1, p2, ..., pn])` returns a procedure representing the probability function

$$x \rightarrow \begin{cases} p_i & \text{if } x = x_i \\ 0 & \text{otherwise} \end{cases}$$

of the sample space given by the data  $x_1, x_2, \dots$  with the probabilities  $p_1, p_2, \dots$

The procedure `f := stats::finitePF([x1, x2, ...], [p1, p2, ...])` can be called in the form `f(x)` with an arithmetical expression  $x$  or sets of lists of such expressions.

If  $x$  is an expression that is contained in the data  $x_1, x_2, \dots$ , then the corresponding probability value is returned.

If  $x$  is an expression that is not contained in the data  $x_1, x_2, \dots$ , then  $0$  is returned.

If  $x$  is a set, the sum of the probability values of its elements is returned.

If  $x$  is a list, it is treated like a set (i.e., duplicate entries in  $x$  are eliminated). The sum of the probability values of the elements in  $x$  is returned.



If all probability values  $p_1, p_2, \dots$  are numerical, they must add up to 1. Otherwise, an error is raised. Cf. “Example 4” on page 30-200 (Symbolic Math Toolbox).

Duplicate data elements are automatically combined to a single data element, adding up the corresponding probability values. Cf. “Example 5” on page 30-201 (Symbolic Math Toolbox).

`stats::finitePF` generalizes `stats::empiricalPF`, which assumes equiprobable data. For numerical data  $x_1, x_2, \dots$ , the call `stats::finitePF([x_1, dots, x_n], [1/n, dots, 1/n])` corresponds to `stats::empiricalPF([x_1, ..., x_n])`.

## Examples

### Example 1

We demonstrate the basic usage of this function:

```
f := stats::finitePF([1, x, y, PI], [1/4, px, py, 0.25]):
f(0), f(1), f(1.0), f(x), f(y), f(PI), f(float(PI)), f(10)
```

$0, \frac{1}{4}, 0, px, py, 0.25, 0, 0$

Alternatively, the data may be passed as a list:

```
f := stats::finitePF([[1, 1/4], [x, px], [y, py], [PI, 0.25]]):
f(0), f(1), f(1.0), f(x), f(y), f(PI), f(float(PI)), f(10)
```

$0, \frac{1}{4}, 0, px, py, 0.25, 0, 0$

```
delete f:
```

### Example 2

We create a sample of type `stats::sample` consisting of one string column and two non-string columns:

```
s := stats::sample(
    ["1996", 1242, 2/5],
```

```
["1997", 1353, 0.1],  
["1998", 1142, 0.2],  
["1999", 1201, 0.2],  
["2001", 1201, 0.1])
```

```
"1996" 1242 2/5  
"1997" 1353 0.1  
"1998" 1142 0.2  
"1999" 1201 0.2  
"2001" 1201 0.1
```

We use the data in the first and third column:

```
f := stats::finitePF(s, 1, 3):  
f("1995"), f("1998"), f("2000"), f("2001")
```

```
0, 0.2, 0, 0.1
```

```
delete s, f:
```

### Example 3

We consider a loaded die:

```
f:= stats::finitePF([1, 2, 3, 4, 5, 6],  
                    [0.1, 0.1, 0.1, 0.2, 0.2, 0.3]):
```

What is the probability that tossing the die produces a score more than or equal to 4?

```
f({4, 5, 6})
```

```
0.7
```

```
delete f:
```

### Example 4

The probability values must add up to 1:

```
stats::finitePF([Head, TAIL], [0.45, 0.54]):
```

Error: Probabilities do not add up to 1. [stats::finitePF]

## Example 5

Duplicate data elements are automatically combined to a single data element, adding up the corresponding probability values:

```
f:= stats::finitePF([x1, x2, x1, x2], [0.1, 0.2, 0.3, 0.4]):  
f(x1), f(x2)
```

```
0.4, 0.6
```

```
delete f:
```

## Parameters

$x_1, x_2, \dots$

The statistical data: arbitrary MuPAD objects

$p_1, p_2, \dots$

Probability values: arithmetical expressions

$s$

A sample of domain type `stats::sample`

$c_1, c_2$

Column indices of the sample  $s$ : positive integers. Column  $c_1$  provides the data  $x_1, x_2$  etc. Column  $c_2$  provides the data  $p_1, p_2$  etc. There is no need to specify column numbers if the sample has only two columns.

## Return Values

procedure on page 1-1654.

## See Also

### **MuPAD Functions**

`stats::empiricalCDF` | `stats::empiricalPF` | `stats::empiricalQuantile` |  
`stats::empiricalRandom` | `stats::finiteCDF` | `stats::finiteQuantile` |  
`stats::finiteRandom`

# stats::finiteQuantile

Quantile function of a finite sample space

## Syntax

```
stats::finiteQuantile([x1, x2, ...], [p1, p2, ...])
```

```
stats::finiteQuantile([[x1, p1], [x2, p2], ...])
```

```
stats::finiteQuantile(s, <c1, c2>)
```

```
stats::finiteQuantile(s, <[c1, c2]>)
```

## Description

`stats::finiteQuantile([x1, x2, ..., xn], [p1, p2, ..., pn])` returns a procedure representing the quantile function of the data  $x_1, x_2$  etc. with the probabilities  $p_1, p_2$  etc. It is the (discrete) inverse of the cumulative distribution function

`stats::finiteCDF([x1, x2, ...], [p1, p2, ...])`. For  $0 \leq x \leq 1$ , the  $x$ -quantile  $y = \text{stats::finiteQuantile}([x_1, x_2, \dots], [p_1, p_2, \dots])(x)$  is the smallest of the data elements  $x_1, x_2, \dots$  satisfying

$$\text{stats::finiteCDF}([x_1, x_2, \dots], [p_1, p_2, \dots])(y) \geq x$$

(The data elements are assumed to be ordered:  $x_1 < x_2 < x_3$  etc.)

The procedure `f := stats::finiteQuantile([x1, x2, ...], [p1, p2, ...])` can be called in the form `f(x)` with an arithmetical expression  $x$ .

If  $x$  is a real number satisfying  $0 \leq x \leq 1$  and all probability values  $p_1, p_2, \dots$  are numerical, then `f(x)` returns one of the data elements  $x_1, x_2, \dots$

Otherwise, if  $x$  is a symbolic expression that cannot be converted to a real floating-point number or if the probabilities  $p_1, p_2, \dots$  contain elements that cannot be converted to real floating-point numbers, then `f(x)` returns the symbolic call

`stats::finiteQuantile([x1, x2, ...], [p1, p2, ...])(x)` with the data  $x_1, x_2, \dots$  in ascending order.

Numerical values of  $x$  are only accepted if  $0 \leq x \leq 1$ .

If all probability values  $p_1, p_2, \dots$  are numerical, they must add up to 1. Otherwise, an error is raised.

Duplicate data elements are automatically combined to a single data element, adding up the corresponding probability values. Cf. "Example 5" on page 30-207 (Symbolic Math Toolbox).

$y = \text{stats::finiteQuantile}([x_1, x_2, \dots], [p_1, p_2, \dots])(x)$  satisfies

$$\text{stats::finiteCDF}([x_1, x_2, \dots], [p_1, p_2, \dots])(x_i) < x \leq$$

$$\text{stats::finiteCDF}([x_1, x_2, \dots], [p_1, p_2, \dots])(y)$$

for all data elements  $x_i$  in the sample satisfying  $x_i < y$ .

The data elements  $x_1, x_2, \dots$  are assumed to be in ascending order:  $x_1 < x_2 < \dots$ . If all data elements are numerical, they are re-ordered automatically, if they are not ascending. If the data contain symbolic elements that cannot be converted to floating-point numbers, the ordering is assumed implicitly.

`stats::finiteQuantile` generalizes `stats::empiricalQuantile`, which assumes equiprobable data. For numerical data  $x_1, x_2, \dots$ , the call `stats::finiteQuantile([x_1, dots, x_n], [1/n, dots, 1/n])` corresponds to `stats::empiricalQuantile([x_1, ..., x_n])`.

## Environment Interactions

The function is sensitive to the environment variable `DIGITS` which determines the numerical working precision. Note, however, that this function is implemented with option `remember`. After the first call it does not react to changes of `DIGITS` unless the input parameters are changed.

## Examples

### Example 1

We compute various quantiles of some numerical data:

```
f := stats::finiteQuantile([1, x, y, PI],
                          [1/4, 3/8, 1/4, 1/8]):
f(0), f(0.1), f(3/10), f(0.5), f(1/sqrt(2)), f(99/100), f(1)
```

1, 1, x, x, y,  $\pi$ ,  $\pi$

Alternatively, the data may be passed as a list:

```
f := stats::finiteQuantile([[1, 1/4], [x, 3/8],
                          [y, 1/4], [PI, 1/8]]):
f(0), f(0.1), f(3/10), f(0.5), f(1/sqrt(2)), f(99/100), f(1)
```

1, 1, x, x, y,  $\pi$ ,  $\pi$

delete f:

### Example 2

We use symbolic arguments. In the symbolic return value, the input data appear as a sorted list:

```
f:= stats::finiteQuantile([3, 4, PI], [0.2, 0.5, 0.3]):
f(x)
```

stats::finiteQuantile([3,  $\pi$ , 4], [0.2, 0.3, 0.5])(x)

Numerical values for  $x$  are only accepted if  $0 \leq x \leq 1$ :

f(0.5)

$\pi$

```
f(2)
```

```
Error: Argument x must be between 0 and 1. [f]
```

```
delete f:
```

### Example 3

We create a sample of type `stats::sample` consisting of one string column and two non-string columns:

```
s := stats::sample(
  [["1996", 1242, 2/5],
   ["1997", 1353, 0.1],
   ["1998", 1142, 0.2],
   ["1999", 1201, 0.2],
   ["2001", 1201, 0.1]])
```

```
"1996" 1242 2/5
"1997" 1353 0.1
"1998" 1142 0.2
"1999" 1201 0.2
"2001" 1201 0.1
```

We compute quantile values of the data in the second and third column:

```
f := stats::finiteQuantile(s, 2, 3):
f(0.1), f(1/4), f(0.7), f(99/100)
```

```
1142, 1201, 1242, 1353
```

```
delete s, f:
```

### Example 4

If numerical probability values are given, they must add up to 1:

```
f := stats::finiteQuantile([Head, TAIL], [0.45, 0.54]):
```

```
Error: Probabilities do not add up to 1. [stats::finiteQuantile]
```



Symbolic probability values are not checked for consistency:

```
f := stats::finiteQuantile([Head, TAIL], [0.45, p]):
f(x)
```

```
stats::finiteQuantile([Head, TAIL], [0.45, p])(x)
```

However, when the probabilities are set to numerical values, they are checked:

```
p := 0.7: f(x)
```

```
Error: Probabilities do not add up to 1. [f]
```

```
delete f, p:
```

## Example 5

Duplicate data elements are automatically combined to a single data element, adding up the corresponding probability values:

```
f := stats::finiteQuantile([x1, x2, x1, x2], [p1, p2, 0.3, 0.4]):
f(0.5)
```

```
stats::finiteQuantile([x1, x2], [p1 + 0.3, p2 + 0.4])(0.5)
```

```
p1 := 0.1: p2 := 0.2: f(0.5)
```

```
x2
```

```
delete f, p1, p2:
```

## Parameters

$x_1, x_2, \dots$

The statistical data: arbitrary MuPAD objects

**$p_1, p_2, \dots$**

Probability values: arithmetical expressions

**s**

A sample of domain type `stats::sample`

**$c_1, c_2$**

Column indices of the sample `s`: positive integers. Column  $c_1$  provides the data  $x_1, x_2$  etc. Column  $c_2$  provides the data  $p_1, p_2$  etc. There is no need to specify column numbers if the sample has only two columns.

## Return Values

procedure on page 1-1654.

## See Also

### MuPAD Functions

`stats::empiricalCDF` | `stats::empiricalPF` | `stats::empiricalQuantile` |  
`stats::empiricalRandom` | `stats::finiteCDF` | `stats::finitePF` |  
`stats::finiteRandom` | `stats::median`

## stats::finiteRandom

Generate a random generator for elements of a finite sample space

### Syntax

```
stats::finiteRandom([x1, x2, ...], [p1, p2, ...], <Seed = n>)
```

```
stats::finiteRandom([[x1, p1], [x2, p2], ...], <Seed = n>)
```

```
stats::finiteRandom(n, <c1, c2>, <Seed = n>)
```

```
stats::finiteRandom(n, <[c1, c2]>, <Seed = n>)
```

### Description

`stats::finiteRandom([x1, x2, ..., xn], [p1, p2, ..., pn])` returns a procedure that picks out random elements from the data  $x_1, x_2$  etc. The chances of picking out elements are given by the probabilities  $p_1, p_2$  etc.

The procedure `f := stats::finiteRandom([x1, x2, ...], [p1, p2, ...])` can be called in the form `f()`. The call `f()` returns one of the data elements  $x_1, x_2, \dots$

The values  $X = f()$  are distributed randomly according to the discrete distribution function of the sample space, i.e., the probability of  $X \leq x$  is given by `stats::finiteCDF([x1, x2, ...], [p1, p2, ...])(x)`.

All probability values  $p_1, p_2, \dots$  must be convertible to floating-point numbers. They must add up to 1.

Without the option `Seed = n`, an initial seed is chosen internally. This initial seed is set to a default value when MuPAD is started. Thus, each time MuPAD is started or re-initialized with the `reset` function, random generators produce the same sequences of numbers.

---

**Note** In contrast to the function `random`, the generators produced by `stats::finiteRandom` do not react to the environment variable `SEED`.

---

For efficiency, it is recommended to produce sequences of  $K$  random numbers via

```
f := stats::finiteRandom([x1, x2, ...], [p1, p2, ...]):  
f() $k = 1..K;
```

rather than by

```
stats::finiteRandom([x1, x2, dots], [p1, p2, dots])() $k = 1..K;
```

The latter call produces a sequence of generators each of which is called once. Also note that

```
stats::finiteRandom([x1, x2, dots], [p1, p2, dots], Seed = s)()  
$k = 1..K;
```

does not produce a random sequence, because a sequence of freshly initialized generators would be created each of them producing the same number.

`stats::finiteRandom` generalizes `stats::empiricalRandom`, which assumes equiprobable data. For numerical data  $x_1, x_2, \dots$ , the call `stats::finiteRandom([x1, dots, xn], [1/n, dots, 1/n])` corresponds to `stats::empiricalRandom([x1, ..., xn])`.

## Examples

### Example 1

We pick out random elements of some data:

```
f := stats::finiteRandom([1, x, y, PI],  
                        [1/4, 3/8, 1/4, 1/8],  
                        Seed = 234):  
f(), f(), f(), f(), f(), f(), f(), f(), f()
```

1, 1, x, y, y, x, x, y,  $\pi$

Alternatively, the data may be passed as a list:

```
f := stats::finiteRandom([[1, 1/4], [x, 3/8],  
                        [y, 1/4], [PI, 1/8]],
```

```

                                Seed = 234):
f(), f(), f(), f(), f(), f(), f(), f(), f()

```

```

1, 1, x, y, y, x, x, y, π

```

```

delete f:

```

## Example 2

We create a sample of type `stats::sample` consisting of one string column and two non-string columns:

```

s := stats::sample(
  [["1996", 1242, 2/5],
   ["1997", 1353, 0.1],
   ["1998", 1142, 0.2],
   ["1999", 1201, 0.2],
   ["2001", 1201, 0.1]])

```

```

"1996" 1242 2/5
"1997" 1353 0.1
"1998" 1142 0.2
"1999" 1201 0.2
"2001" 1201 0.1

```

We pick random values using the data in the first and third column:

```

f := stats::finiteRandom(s, 1, 3, Seed = 123):
f(), f(), f(), f(), f(), f(), f()

```

```

"1996", "1998", "1997", "1996", "1998", "1996", "1996"

```

```

delete s, f:

```

## Example 3

We toss a loaded coin:

```

f := stats::finiteRandom([Head, Tail], [0.4, 0.6], Seed = 123):
f(), f(), f(), f(), f(), f(), f(), f(), f(), f()

```

Head, Tail, Tail, Head, Tail, Head, Head, Tail, Head, Tail

We toss the coin 10000 times and count the number of Heads and Tails:

```
t := [f() $ k = 1..10^4]:
NumberOfHeads = nops(select(t, _equal, Head)),
NumberOfTails = nops(select(t, _equal, Tail))
```

NumberOfHeads = 3975, NumberOfTails = 6025

```
delete f, t:
```

## Example 4

The probability values must add up to 1:

```
stats::finiteRandom([Head, TAIL], [0.45, 0.54]):
```

```
Error: Probabilities do not add up to 1. [stats::finiteRandom]
```

## Parameters

$x_1, x_2, \dots$

The statistical data: arbitrary MuPAD objects

$p_1, p_2, \dots$

Probability values: real numerical values

$s$

A sample of domain type `stats::sample`

$c_1, c_2$

Column indices of the sample  $s$ : positive integers. Column  $c_1$  provides the data  $x_1, x_2$  etc. Column  $c_2$  provides the data  $p_1, p_2$  etc. There is no need to specify column numbers if the sample has only two columns.

## Options

### Seed

Option, specified as `Seed = n`

Initializes the random generator with the integer seed `n`. `n` can also be the option `currentTime`, to make the seed depend on the current time.

This option serves for generating generators that return predictable sequences of pseudo-random values. The generator is initialized with the seed `n` which may be an arbitrary integer. Several generators with the same initial seed produce the same sequence of values.

## Return Values

procedure on page 1-1654.

## Algorithms

The random values are chosen by applying the quantile function to uniformly distributed random numbers between 0 and 1.

## See Also

### MuPAD Functions

`stats::empiricalCDF` | `stats::empiricalPF` | `stats::empiricalQuantile` |  
`stats::empiricalRandom` | `stats::finiteCDF` | `stats::finitePF` |  
`stats::finiteQuantile` | `stats::median`

## stats::frequency

Tally numerical data into classes and count frequencies

### Syntax

```
stats::frequency(data, <ClassesClosed = Left | Right>)
```

```
stats::frequency(data, n, <ClassesClosed = Left | Right>)
```

```
stats::frequency(data, [n], <ClassesClosed = Left | Right>)
```

```
stats::frequency(data, [a1 .. b1, a2 .. b2, ...], <ClassesClosed = Left | Right>)
```

```
stats::frequency(data, [[a1, b1], [a2, b2], ...], <ClassesClosed = Left | Right>)
```

```
stats::frequency(data, Classes = n, <ClassesClosed = Left | Right>)
```

```
stats::frequency(data, Classes = [n], <ClassesClosed = Left | Right>)
```

```
stats::frequency(data, Classes = [a1 .. b1, a2 .. b2, ...], <ClassesClosed = Left | Right>)
```

```
stats::frequency(data, Classes = [[a1, b1], [a2, b2], ...], <ClassesClosed = Left | Right>)
```

```
stats::frequency(data, Cells = n, <CellsClosed = Left | Right>)
```

```
stats::frequency(data, Cells = [n], <CellsClosed = Left | Right>)
```

```
stats::frequency(data, Cells = [a1 .. b1, a2 .. b2, ...], <CellsClosed = Left | Right>)
```

```
stats::frequency(data, Cells = [[a1, b1], [a2, b2], ...], <CellsClosed = Left | Right>)
```

### Description

`stats::frequency(data, [[a1, b1], [a2, b2], ...])` tallies numerical data into different classes given by semiopen intervals  $(a_i, b_i]$ . It counts how many data elements fall into each class.

All data elements must be real numerical values. Exact numerical values such as  $\pi$ ,  $\sqrt{3}$  etc. are allowed if they can be converted to real floating-point numbers via `float`. An



error is raised if symbolic data are found that cannot be converted to real floating point numbers.

---

**Note** Note that `stats::frequency` is fast if all data elements are integers on page 7-31, rational numbers on page 7-48, or floating point numbers on page 7-23. Exact numerical values such as  $\pi$ ,  $\sqrt{3}$  etc. are processed, but have a noticeable impact on the efficiency of `stats::frequency`.

---

Data given by an array, a table etc. are internally treated like a list containing all operands of the data container. In particular, all rows and columns of arrays, matrices and `stats::sample` objects are taken into account. A `stats::sample` object must not contain any text entries.

For the specification of the classes, `stats::frequency` accepts either a single positive integer (or, equivalently, a list of one positive integer), or a list of classes given as ranges on page 1-16 or lists of two elements.

A single integer  $n$  in the specification `Classes= n` or `Classes= [n]` is interpreted as “subdivide the range from  $\min(data)$  to  $\max(data)$  into  $n$  classes of equal size”. The left border of the first class is set to  $-\infty$ .

The classes may be specified directly as in `Classes = [[a1, b1], [a2, b2], ...]` or `Classes=[a_1..b_1, a_2..b_2, dots]`.

---

**Note** With the default setting `ClassesClosed = Right`, the  $i$ -th class is the *semi-open* interval  $(a_i, b_i]$ , i.e., a datum  $x$  is tallied into the  $i$ -th class if  $a_i < x \leq b_i$  is satisfied.

With `ClassesClosed = Left`, the  $i$ -th class is the semi-open interval  $[a_i, b_i)$ , i.e., a datum  $x$  is tallied into the  $i$ -th class if  $a_i \leq x < b_i$  is satisfied.

---

The class boundaries must be numerical real values satisfying  $a_1 \leq b_1 \leq a_2 \leq b_2 \leq a_3 \leq \dots$ . In most applications,  $b_1 = a_2$ ,  $b_2 = a_3$  etc. is appropriate.

Exact values such as  $\pi$ ,  $\sqrt{3}$  etc. are accepted and processed.

The classes need not cover the entire data range. Data are ignored if they do not fall into one of the specified classes.

If giving classes directly, the leftmost border may be  $-\infty$  and the rightmost border may be *infinity*.

## Examples

### Example 1

We split the following data into 10 classes of equal size (default). The first class covers the values from  $-\infty$  to 2:

```
data := [0, 1, 2, PI, 4, 5, 6, 7, 7.1, 20]:  
T := stats::frequency(data)
```

```
1 | [[-∞, 2], 3, [0, 1, 2]]  
2 | [[2, 4], 2, [π, 4]]  
3 | [[4, 6], 2, [5, 6]]  
4 | [[6, 8], 2, [7, 7.1]]  
5 | [[8, 10], 0, []]  
6 | [[10, 12], 0, []]  
7 | [[12, 14], 0, []]  
8 | [[14, 16], 0, []]  
9 | [[16, 18], 0, []]  
10 | [[18, 20], 1, [20]]
```

We split the information on the classes into 3 separate tables:

```
TheClasses = map(T, op, 1)
```

```

      1 | [-∞, 2]
      2 | [2, 4]
      3 | [4, 6]
      4 | [6, 8]
TheClasses = 5 | [8, 10]
      6 | [10, 12]
      7 | [12, 14]
      8 | [14, 16]
      9 | [16, 18]
     10 | [18, 20]

```

```
TheFrequencies = map(T, op, 2)
```

```

      1 | 3
      2 | 2
      3 | 2
      4 | 2
TheFrequencies = 5 | 0
      6 | 0
      7 | 0
      8 | 0
      9 | 0
     10 | 1

```

```
TheValues = map(T, op, 3)
```

```
TheValues =
```

1	[0, 1, 2]
2	[ $\pi$ , 4]
3	[5, 6]
4	[7, 7.1]
5	□
6	□
7	□
8	□
9	□
10	[20]

The classes are specified explicitly:

```
classes:= [[0, 5], [5, 10], [10, 20]]:  
stats::frequency(data, classes)
```

```
1 | [[0, 5], 5, [1, 2,  $\pi$ , 4, 5]]  
2 | [[5, 10], 3, [6, 7, 7.1]]  
3 | [[10, 20], 1, [20]]
```

Note that the value 0 is not tallied into any of the classes (the first class represents the semi-open interval  $(0, 5]$ ! In order to include all values, we use  $\pm\infty$  as class boundaries:

```
classes:= [[-infinity, 5], [5, 10], [10, infinity]]:  
stats::frequency(data, classes)
```

```
1 | [[ $-\infty$ , 5], 6, [0, 1, 2,  $\pi$ , 4, 5]]  
2 | [[5, 10], 3, [6, 7, 7.1]]  
3 | [[10,  $\infty$ ], 1, [20]]
```

```
delete data, T, classes:
```

## Example 2

We demonstrate the difference between the options `ClassesClosed = Left` and `ClassesClosed = Right`. In the first case, the value 1 is tallied into the second class:

```
stats::frequency([0, 1, 2], Classes = [-infinity..1, 1..infinity],
                  ClassesClosed = Left)
```

1	$[-\infty, 1]$ , 1, [0]
2	$[1, \infty]$ , 2, [1, 2]

With `ClassesClosed = Right`, the value 1 is tallied into the first class:

```
stats::frequency([0, 1, 2], Classes = [-infinity..1, 1..infinity],
                  ClassesClosed = Right)
```

1	$[-\infty, 1]$ , 2, [0, 1]
2	$[1, \infty]$ , 1, [2]

The default setting is `ClassesClosed = Right`:

```
stats::frequency([0, 1, 2], Classes = [-infinity..1, 1..infinity])
```

1	$[-\infty, 1]$ , 2, [0, 1]
2	$[1, \infty]$ , 1, [2]

## Example 3

We create a sample of 1000 normally distributed data points:

```
X := stats::normalRandom(0, 10):
data := [X() $ i = 1..1000]:
```

These data are tallied into 5 different classes of equal width:

```
T := stats::frequency(data, 5):
```

We determine the number of data values in each class:

```
for i from 1 to 5 do
  print(Class = T[i][1], NumberOfElements = T[i][2]);
end_for:
```

Class =  $[-\infty, -5.982260368]$ , NumberOfElements = 23

Class =  $[-5.982260368, -1.635193057]$ , NumberOfElements = 300

Class =  $[-1.635193057, 2.711874254]$ , NumberOfElements = 485

Class =  $[2.711874254, 7.058941565]$ , NumberOfElements = 182

Class =  $[7.058941565, 11.40600888]$ , NumberOfElements = 10

We determine the outliers of the data sample by collecting the values smaller than - 9 and the values larger than 10:

```
classes := [[-infinity, -9], [10, infinity]]:
T := stats::frequency(data, classes):
```

```
1 |  $[-\infty, -9]$ , 2,  $[-10.32932768, -9.707360153]$ 
2 |  $[10, \infty]$ , 1,  $[11.40600888]$ 
```

```
delete X, data, T, i, classes:
```

## Parameters

### data

The statistical data: a list on page 7-41, a set on page 7-50, a table on page 1-2103, an array on page 1-2103, a matrix on page 1-1340, or an object of type `stats::sample` containing numerical real data values

**n**

The number of classes (cells): a positive integer. If not specified,  $n = 10$  is used.

**a<sub>1</sub>, b<sub>1</sub>, a<sub>2</sub>, ...**

The class boundaries: real numerical values satisfying

$$a_1 \leq b_1 \leq a_2 \leq b_2 \leq \dots$$

Also  $\pm\infty$  are allowed as class boundaries.

## Return Values

table on page 1-2103 is returned with integer indices from 1 through the number of classes. The  $i$ -th entry of the table  $T = \text{stats::frequency}(\text{data}, \dots)$  is the list  $T[i] = [[a_i, b_i], n_i, [v_1, v_2, \dots]]$ , where  $[a_i, b_i]$  is the  $i$ -th class,  $n_i$  is the number of data falling in this class, and  $[v_1, v_2, \dots]$  is the sorted list of all data in this class (i.e.,  $a_i < v_j \leq b_i$  for all  $j$  from 1 through  $n_i$ ).

## See Also

### MuPAD Functions

stats::mean | stats::stdev

### MuPAD Graphical Primitives

plot::Histogram2d

## stats::gammaCDF

Cumulative distribution function of the gamma distribution

### Syntax

```
stats::gammaCDF(a, b)
```

### Description

stats::gammaCDF(a, b) returns a procedure representing the cumulative distribution function

$$x \rightarrow \begin{cases} \frac{1}{b^a \Gamma(a)} \int_0^x t^{a-1} e^{-\frac{t}{b}} dt & \text{if } x > 0 \\ 0 & \text{if } x \leq 0 \end{cases}$$

of the gamma distribution with shape parameter  $a > 0$  and scale parameter  $b > 0$ .

The procedure `f:=stats::gammaCDF(a, b)` can be called in the form `f(x)` with an arithmetical expression  $x$ . The return value of `f(x)` is either a floating-point number or a symbolic expression:

If  $x \leq 0$  can be decided, then `f(x)` returns 0. If  $x \geq 0$  can be decided, then `f(x)` returns

the value  $1 - \frac{\Gamma(a, \frac{x}{b})}{\Gamma(a)}$ .

If  $x$  is a floating-point number and both  $a$  and  $b$  can be converted to positive floating-point numbers, then these values are returned as floating-point numbers. Otherwise, symbolic expressions are returned.

The function `f` reacts to properties of identifiers set via `assume`. If  $x$  is a symbolic expression with the property  $x \leq 0$  or  $x \geq 0$ , the corresponding values are returned.

The call `f(-infinity)` returns 0.



The call `f( infinity )` returns 1.

`f(x)` returns the symbolic call `stats::gammaCDF(a, b)(x)` if neither  $x \leq 0$  nor  $x \geq 0$  can be decided.

Numerical values for `a` and `b` are only accepted if they are real and positive.

Note that, for large  $a$ , exact results may be costly to compute. If floating-point values are desired, it is recommended to pass floating-point arguments  $x$  to `f` rather than to compute exact results `f(x)` and convert them via `float`. Cf. “Example 4” on page 30-225 (Symbolic Math Toolbox).

Note that  $\text{stats::gammaCDF}(a, b) = \text{stats::erlangCDF}\left(a, \frac{1}{b}\right)$ .

## Environment Interactions

The function is sensitive to the environment variable `DIGITS` which determines the numerical working precision. The procedure generated by `stats::gammaCDF` reacts to properties of identifiers set via `assume`.

## Examples

### Example 1

We evaluate the cumulative distribution function with  $a = 2$  and  $b = 1$  at various points:

```
f := stats::gammaCDF(2, 1):
f(-infinity), f(-3), f(0.5), f(2/3), f(PI), f(infinity)
```

$$0, 0, 0.09020401043, 1 - \frac{5 e^{-\frac{2}{3}}}{3}, 1 - e^{-\pi} (\pi + 1), 1$$

```
delete f:
```

## Example 2

If  $x$  is a symbolic object without properties, then it cannot be decided whether  $x \geq 0$  holds. A symbolic function call is returned:

```
f := stats::gammaCDF(a, b): f(x)
```

```
stats::gammaCDF(a, b)(x)
```

With suitable properties, it can be decided whether  $x \geq 0$  holds. An explicit expression is returned:

```
assume(0 <= x): f(x)
```

$$1 - \frac{\Gamma(a, \frac{x}{b})}{\Gamma(a)}$$

```
unassume(x): delete f:
```

## Example 3

We use symbolic arguments:

```
f := stats::gammaCDF(a, b): f(x)
```

```
stats::gammaCDF(a, b)(x)
```

When numerical values are assigned to  $a$  and  $b$ , the function  $f$  starts to produce numerical values:

```
a := 2: b := 4: f(3), f(3.0)
```

$$1 - \frac{7 e^{-\frac{3}{4}}}{4}, 0.1733585327$$

```
delete f, a, b:
```

## Example 4

We consider a gamma distribution with large shape parameter:

```
f := stats::gammaCDF(2000, 2):
```

For floating-point approximations, one should not compute an exact result and convert it via `float`. For large shape parameter, it is faster to pass a floating-point argument to `f`. The following call takes some time, because an exact computation of the huge integer  $\Gamma(2000) = 1999!$  is involved:

```
float(f(4010))
```

```
0.5474266776
```

The following call is much faster:

```
f(float(4010))
```

```
0.5474266776
```

```
delete f:
```

## Parameters

**a**

The shape parameter: an arithmetical expression (Symbolic Math Toolbox) representing a positive real value

**b**

The scale parameter: an arithmetical expression (Symbolic Math Toolbox) representing a positive real value

## Return Values

procedure on page 1-1654.

## See Also

### **MuPAD Functions**

gamma | igamma | stats::erlangCDF | stats::erlangPDF |  
stats::erlangQuantile | stats::erlangRandom | stats::gammaPDF |  
stats::gammaQuantile | stats::gammaRandom

# stats::gammaPDF

Probability density function of the gamma distribution

## Syntax

`stats::gammaPDF(a, b)`

## Description

`stats::gammaPDF(a, b)` returns a procedure representing the probability density function

$$x \rightarrow \begin{cases} \frac{1}{b^a \Gamma(a)} x^{a-1} e^{-\frac{x}{b}} & \text{if } x > 0 \\ 0 & \text{if } x \leq 0 \end{cases}$$

of the gamma distribution with shape parameter  $a > 0$  and scale parameter  $b > 0$ .

The procedure `f:=stats::gammaPDF(a, b)` can be called in the form `f(x)` with an arithmetical expression  $x$ . The return value of `f(x)` is either a floating-point number or a symbolic expression:

If  $x \leq 0$  can be decided, then `f(x)` returns 0. If  $x > 0$  can be decided, then `f(x)` returns

the value  $\frac{x^{a-1}}{b^a \Gamma(a)} e^{-x/b}$ .

If  $x$  is a floating-point number and both  $a$  and  $b$  can be converted to positive floating-point numbers, then these values are returned as floating-point numbers. Otherwise, symbolic expressions are returned.

The function `f` reacts to properties of identifiers set via `assume`. If  $x$  is a symbolic expression with the property  $x \leq 0$  or  $x \geq 0$ , the corresponding values are returned.

`f(-infinity)` and `f(infinity)` return 0.

$f(x)$  returns the symbolic call `stats::gammaPDF(a, b)(x)` if neither  $x \leq 0$  nor  $x > 0$  can be decided.

Numerical values for  $a$  and  $b$  are only accepted if they are real and positive.

Note that, for large  $a$ , exact results may be costly to compute. If floating-point values are desired, it is recommended to pass floating-point arguments  $x$  to  $f$  rather than to compute exact results  $f(x)$  and convert them via `float`. Cf. “Example 4” on page 30-230 (Symbolic Math Toolbox).

Note that  $\text{stats::gammaPDF}(a, b) = \text{stats::erlangPDF}\left(a, \frac{1}{b}\right)$ .

## Environment Interactions

The function is sensitive to the environment variable `DIGITS` which determines the numerical working precision. The procedure generated by `stats::gammaPDF` reacts to properties of identifiers set via `assume`.

## Examples

### Example 1

We evaluate the probability density function with  $a = 2$  and  $b = 1$  at various points:

```
f := stats::gammaPDF(2, 1):  
f(-infinity), f(-PI), f(1/2), f(0.5), f(PI), f(infinity)
```

$0, 0, \frac{e^{-\frac{1}{2}}}{2}, 0.3032653299, \pi e^{-\pi}, 0$

```
delete f:
```

### Example 2

If  $x$  is a symbolic object without properties, then it cannot be decided whether  $x \geq 0$  holds. A symbolic function call is returned:

```
f := stats::gammaPDF(a, b): f(x)
```

$$\text{stats::gammaPDF}(a, b)(x)$$

With suitable properties, it can be decided whether  $x \geq 0$  holds. An explicit expression is returned:

```
assume(0 < x): f(x)
```

$$\frac{x^{a-1} e^{-\frac{x}{b}}}{b^a \Gamma(a)}$$

```
unassume(x): delete f:
```

### Example 3

We use symbolic arguments:

```
f := stats::gammaPDF(a, b): f(x), f(3)
```

$$\text{stats::gammaPDF}(a, b)(x), \frac{3^{a-1} e^{-\frac{3}{b}}}{b^a \Gamma(a)}$$

When numerical values are assigned to  $a$  and  $b$ , the function  $f$  starts to produce numerical results:

```
a := 2: b := 4: f(3), f(3.0)
```

$$\frac{3 e^{-\frac{3}{4}}}{16}, 0.08856872864$$

```
delete a, b, f:
```

## Example 4

We consider a gamma distribution with large shape parameter:

```
f := stats::gammaPDF(2000, 2):
```

For floating-point approximations, one should not compute an exact result and convert it via `float`. For large shape parameter, it is faster to pass a floating-point argument to `f`. The following call takes some time, because an exact computation of the huge integer  $\Gamma(2000) = 1999!$  is involved:

```
float(f(4050))
```

```
0.00377271215
```

The following call is much faster:

```
f(float(4050))
```

```
0.00377271215
```

```
delete f:
```

## Parameters

### a

The shape parameter: an arithmetical expression (Symbolic Math Toolbox) representing a positive real value

### b

The scale parameter: an arithmetical expression (Symbolic Math Toolbox) representing a positive real value

## Return Values

procedure on page 1-1654.



## See Also

### MuPAD Functions

gamma | igamma | stats::erlangCDF | stats::erlangPDF |  
stats::erlangQuantile | stats::erlangRandom | stats::gammaCDF |  
stats::gammaQuantile | stats::gammaRandom

## stats::gammaQuantile

Quantile function of the gamma distribution

### Syntax

```
stats::gammaQuantile(a, b)
```

### Description

`stats::gammaQuantile(a, b)` returns a procedure representing the quantile function (inverse) of the cumulative distribution function `stats::gammaCDF(a, b)`. For  $0 \leq x \leq 1$ , the solution of `stats::gammaCDF(a, b)(y) = x` is given by  $y = \text{stats::gammaQuantile}(a, b)(x)$ .

The procedure `f:=stats::gammaQuantile(a, b)` can be called in the form `f(x)` with arithmetical expressions `x`. The return value of `f(x)` is either a floating-point number, *infinity*, or a symbolic expression:

If `x` is a real number between 0 and 1 and `a` and `b` can be converted to positive floating-point numbers, then `f(x)` returns a positive floating-point number approximating the solution `y` of `stats::gammaCDF(a, b)(y) = x`.

The calls `f(0)` and `f(0.0)` produce 0.0 for all values of `a` and `b`.

The calls `f(1)` and `f(1.0)` produce *infinity* for all values of `m`.

In all other cases, `f(x)` returns the symbolic call `stats::gammaQuantile(a, b)(x)`.

Numerical values of `x` are only accepted if  $0 \leq x \leq 1$ .

Numerical values of `a` and `b` are only accepted if they are real and positive.

Note that  $\text{stats::gammaQuantile}(a, b) = \text{stats::erlangQuantile}\left(a, \frac{1}{b}\right)$ .

## Environment Interactions

The function is sensitive to the environment variable DIGITS which determines the numerical working precision.

## Examples

### Example 1

We evaluate the quantile function with  $a = \pi$  and  $b = 11$  at various points:

```
f := stats::gammaQuantile(PI, 11):
f(0), f(1/10), f(0.5), f(1 - 10^(-10)), f(1)

0.0, 13.08489993, 30.96813726, 324.7230043, ∞
```

The value  $f(x)$  satisfies  $\text{stats::gammaCDF}(\pi, 11)(f(x)) = x$ :

```
stats::gammaCDF(PI, 11)(f(0.987654))

0.987654
```

delete f:

### Example 2

We use symbolic arguments:

```
f := stats::gammaQuantile(a, b): f(x), f(9/10)

stats::gammaQuantile(a, b)(x), stats::gammaQuantile(a, b)(9/10)
```

When positive real values are assigned to  $a$  and  $b$ , the function  $f$  starts to produce floating-point values:

```
a := 17: b := 6: f(0.999), f(1 - sqrt(2)/10^5)
```

195.7416524, 240.0294477

Numerical values for  $x$  are only accepted if  $0 \leq x \leq 1$ :

`f(0.5)`

100.0071221

`f(2)`

Error: Argument  $x$  must be between 0 and 1. [f]

delete `f`, `a`, `b`:

## Parameters

### **a**

The shape parameter: an arithmetical expression (Symbolic Math Toolbox) representing a positive real value

### **b**

The scale parameter: an arithmetical expression (Symbolic Math Toolbox) representing a positive real value

## Return Values

procedure on page 1-1654.

## See Also

### MuPAD Functions

stats::erlangCDF | stats::erlangPDF | stats::erlangQuantile |  
stats::erlangRandom | stats::gammaCDF | stats::gammaPDF |  
stats::gammaRandom

## stats::gammaRandom

Generate a random number generator for gamma deviates

### Syntax

```
stats::gammaRandom(a, b, <Seed = n>)
```

### Description

`stats::gammaRandom(a, b)` returns a procedure that produces gamma on page 30-222 deviates (random numbers) with shape parameter  $a > 0$  and scale parameter  $b > 0$ .

The procedure `f:=stats::gammaRandom(a, b)` can be called in the form `f()`. The return value of `f()` is either a floating-point number or a symbolic expression:

If  $a$  and  $b$  can be converted to positive floating-point numbers, then `f()` returns a nonnegative floating-point number.

In all other cases, `stats::gammaRandom(a, b)()` is returned symbolically.

Numerical values of  $a$  and  $b$  are only accepted if they are real and positive.

The values  $X = f()$  are distributed randomly according to the cumulative distribution function of the gamma distribution with parameters  $a$  and  $b$ . For any  $0 \leq x$ , the probability that  $X \leq x$  is given by

$$\frac{1}{b^a \Gamma(a)} \int_0^x t^{a-1} e^{-bt} dt$$

Without the option `Seed = n`, an initial seed is chosen internally. This initial seed is set to a default value when MuPAD is started. Thus, each time MuPAD is started or re-initialized with the `reset` function, random generators produce the same sequences of numbers.

---

**Note** In contrast to the function `random`, the generators produced by `stats::gammaRandom` do not react to the environment variable `SEED`.

---

For efficiency, it is recommended to produce sequences of  $K$  random numbers via

```
f := stats::gammaRandom(a, b): f() $k = 1..K;
```

rather than by

```
stats::gammaRandom(a, b)() $k = 1..K;
```

The latter call produces a sequence of generators each of which is called once. Also note that

```
stats::gammaRandom(a, b, Seed = n)() $k = 1..K;
```

does not produce a random sequence, because a sequence of freshly initialized generators would be created each of them producing the same number.

Note that  $\text{stats::gammaRandom}(a, b) = \text{stats::erlangRandom}\left(a, \frac{1}{b}\right)$ .

## Environment Interactions

The function is sensitive to the environment variable `DIGITS` which determines the numerical working precision.

## Examples

### Example 1

We generate gamma deviates with parameters  $a = 2$  and  $b = \frac{4}{3}$ :

```
f := stats::gammaRandom(2, 4/3): f() $ k = 1..4
```

```
3.958784095, 3.891811185, 6.046842446, 3.142485711
```

```
delete f:
```

## Example 2

With symbolic parameters, no random floating-point numbers can be produced:

```
f := stats::gammaRandom(a, b): f()
```

```
stats::gammaRandom(a, b)()
```

When  $a$  and  $b$  evaluate to positive real numbers, the result is evaluated to a real floating point number:

```
a := PI: b := 8: f() $ k = 1..4
```

```
19.74371462, 12.37357049, 13.40137346, 29.97534861
```

```
delete f, a, b:
```

## Example 3

We use the option `Seed = n` to reproduce a sequence of random numbers:

```
f := stats::gammaRandom(PI, 1/3, Seed = 10^3): f() $ k = 1..4
```

```
0.3631090007, 0.8803177461, 0.9712460319, 1.740056499
```

```
g := stats::gammaRandom(PI, 1/3, Seed = 10^3): g() $ k = 1..4
```

```
0.3631090007, 0.8803177461, 0.9712460319, 1.740056499
```

```
f() = g(), f() = g()
```

```
1.561212345 = 1.561212345, 0.4650866732 = 0.4650866732
```

```
delete f:
```



## Parameters

### **a**

The shape parameter: an arithmetical expression (Symbolic Math Toolbox) representing a positive real value

### **b**

The scale parameter: an arithmetical expression (Symbolic Math Toolbox) representing a positive real value

## Options

### **Seed**

Option, specified as `Seed = n`

Initializes the random generator with the integer seed `n`. `n` can also be the option `CurrentTime`, to make the seed depend on the current time.

This option serves for generating generators that return predictable sequences of pseudo-random numbers. The generator is initialized with the seed `n` which may be an arbitrary integer. Several generators with the same initial seed produce the same sequence of numbers.

When this option is used, the parameters `a` and `b` must be convertible to positive floating-point numbers at the time when the random generator is generated.

## Return Values

procedure on page 1-1654.

## Algorithms

The implemented algorithm for the computation of gamma deviates uses a rejection method applied to uniform random numbers. For more information see: D. Knuth, *Seminumerical Algorithms* (1998), Vol. 2, pp. 133.

## See Also

### **MuPAD Functions**

`stats::erlangCDF` | `stats::erlangPDF` | `stats::erlangQuantile` |  
`stats::erlangRandom` | `stats::gammaCDF` | `stats::gammaPDF` |  
`stats::gammaQuantile`

# stats::geometricMean

Geometric mean of a data sample

## Syntax

```
stats::geometricMean(x1, x2, ...)
```

```
stats::geometricMean([x1, x2, ...])
```

```
stats::geometricMean(s, <c>)
```

## Description

`stats::geometricMean(x1, x2, ..., xn)` returns the geometric mean  $(x_1 x_2 \dots x_n)^{1/n}$  of the data  $x_i$ .

The column index `c` is optional, if the data are given by a `stats::sample` object containing only one non-string column. Cf. “Example 3” on page 30-242 (Symbolic Math Toolbox).

External statistical data stored in an ASCII file can be imported into a MuPAD session via `import::readdata`. In particular, see Example 1 of the corresponding help page on page 13-11.

## Examples

### Example 1

We calculate the geometric mean of three values:

```
stats::geometricMean(a, b, c)
```

$$(a \ b \ c)^{1/3}$$

Alternatively, the data may be passed as a list:

```
stats::geometricMean([2, 3, 5])
```

$30^{1/3}$

## Example 2

We create a sample:

```
stats::sample([[a1, b1, c1], [a2, b2, c2]])
```

```
a1 b1 c1  
a2 b2 c2
```

The geometric mean of the second column is:

```
stats::geometricMean(%, 2)
```

$\sqrt{b1 b2}$

## Example 3

We create a sample consisting of one string column and one non-string column:

```
stats::sample(["1996", 1242], ["1997", 1353], ["1998", 1142])
```

```
"1996" 1242  
"1997" 1353  
"1998" 1142
```

We compute the geometric mean of the second column. In this case this column does not have to be specified, since it is the only non-string column in the sample:

```
float(stats::geometricMean(%))
```

1242.68722

## Parameters

$x_1, x_2, \dots$

The statistical data: arithmetical expressions. (Symbolic Math Toolbox)

**s**

A sample of domain type `stats::sample`.

**c**

An integer representing a column index of the sample `s`. This column provides the data `x1, x2` etc.

## Return Values

arithmetical expression. (Symbolic Math Toolbox)

## See Also

### MuPAD Functions

`stats::harmonicMean` | `stats::mean` | `stats::median` | `stats::modal` |  
`stats::quadraticMean` | `stats::stdev` | `stats::variance`

## stats::geometricCDF

The (discrete) cumulative distribution function of the geometric distribution

### Syntax

```
stats::geometricCDF(p)
```

### Description

stats::geometricCDF(p) returns a procedure representing the (discrete) cumulative distribution function

$$x \rightarrow \begin{cases} 0 & \text{if } x < 1 \\ 1 - (1 - p)^{\lfloor x \rfloor} & \text{if } x \geq 1 \end{cases}$$

of the geometric distribution with 'probability parameter'  $p$ .

The procedure `f:=stats::geometricCDF(p)` can be called in the form `f(x)` with an arithmetical expression  $x$ . The return value of `f(x)` is either a number or a symbolic expression:

If  $x < 1$  can be decided, then `f(x)` returns 0. If  $x \geq 1$  can be decided, then `f(x)` returns the value  $1 - (1 - p)^{\lfloor x \rfloor}$ .

If  $x$  is a floating-point number and  $p$  can be converted to a floating-point number, then these values are returned as floating-point numbers. Otherwise, symbolic expressions are returned.

The function `f` reacts to properties of identifiers set via `assume`. If  $x$  is a symbolic expression with the property  $x < 1$  or  $x \geq 1$ , the corresponding values are returned.

`f(x)` returns the symbolic call `stats::geometricCDF(p)(x)` if neither  $x < 1$  nor  $x \geq 1$  can be decided.

If  $p = 0$  or  $p = 0.0$ , then  $f(x)$  returns 0 or 0.0, respectively, for any value of  $x$ .

Numerical values for  $p$  are only accepted if they satisfy  $0 \leq p \leq 1$ .

If  $x$  is a real floating-point number,  $f(x)$  produces a floating number provided  $p$  is a numerical value. If  $x$  is an exact numerical value, no internal floating-point conversion of the parameter  $p$  is attempted.

## Environment Interactions

The function is sensitive to the environment variable DIGITS which determines the numerical working precision.

## Examples

### Example 1

We evaluate the distribution function with  $p = \frac{1}{3}$  at various points:

```
f := stats::geometricCDF(1/3):
f(-PI) = f(float(-PI)), f(1) = f(1.0), f(103/10) = f(10.3)
```

$$0 = 0.0, \frac{1}{3} = 0.3333333333, \frac{58025}{59049} = 0.9826584701$$

```
delete f:
```

### Example 2

If  $x$  is a symbolic object without properties, then it cannot be decided whether  $x \geq 1$  holds. A symbolic function call is returned:

```
f := stats::geometricCDF(p): f(x)
```

```
stats::geometricCDF(p)(x)
```

With suitable properties, it can be decided whether  $x \geq 1$  holds. An explicit expression is returned:

```
assume(1 <= x): f(x)
```

$$1 - (1 - p)^{\lfloor x \rfloor}$$

```
unassume(x): delete f:
```

### Example 3

We use symbolic arguments:

```
f := stats::geometricCDF(p): f(x)
```

$$\text{stats::geometricCDF}(p)(x)$$

If  $x$  is a numerical value, symbolic expressions in  $p$  are returned:

```
f(-1), f(1), f(5/2), f(PI)
```

$$0, p, 1 - (p - 1)^2, (p - 1)^3 + 1$$

When numerical values are assigned to  $p$ , the function  $f$  starts to produce numbers if the argument is numerical:

```
p := 1/3: f(-1), f(1), f(5/2), f(PI)
```

$$0, \frac{1}{3}, \frac{5}{9}, \frac{19}{27}$$

```
delete f, p:
```



## Parameters

**p**

The 'probability parameter': an arithmetical expression (Symbolic Math Toolbox) representing a real number  $0 \leq p \leq 1$ .

## Return Values

procedure on page 1-1654.

## Algorithms

The geometric distribution describes the number of Bernoulli trials with success probability  $p$  up to and including the first success.

## See Also

### **MuPAD Functions**

stats::geometricPF | stats::geometricQuantile | stats::geometricRandom

## stats::geometricPF

Probability function of the geometric distribution

### Syntax

```
stats::geometricPF(p)
```

### Description

stats::geometricPF(p) returns a procedure representing the probability function

$$x \rightarrow p(1-p)^{x-1}$$

for  $x = 1, 2, 3, \dots$  of the geometric distribution with 'probability parameter'  $p$ .

The procedure `f:=stats::geometricPF(p)` can be called in the form `f(x)` with an arithmetical expression  $x$ . The return value of `f(x)` is either a number or a symbolic expression:

If  $x$  is a non-integer numerical value, `f(x)` returns 0 or 0.0, respectively.

If  $x$  is a positive integer or the floating point equivalent of such an integer, then an explicit value is returned.

In all other cases, `f(x)` returns the symbolic call `stats::geometricPF(n,p)(x)`.

Numerical values for  $p$  are only accepted if they satisfy  $0 \leq p \leq 1$ .

If  $x$  is a floating-point number, the result is a floating-point number provided  $p$  can be converted to a floating-point number between 0.0 and 1.0. If  $x$  is an exact numerical value, no internal floating point conversion of the parameter  $p$  is attempted.

## Environment Interactions

The function is sensitive to the environment variable DIGITS which determines the numerical working precision.

## Examples

### Example 1

We calculate the geometric probability with  $p = \frac{1}{8}$  at various points:

```
f := stats::geometricPF(1/8):
f(-1), f(0.5), f(1), f(3/2), f(3) = f(float(3))
```

$$0, 0.0, \frac{1}{8}, 0, \frac{49}{512} = 0.095703125$$

```
delete f:
```

### Example 2

We use symbolic arguments:

```
f := stats::geometricPF(p): f(x)
```

```
stats::geometricPF(p)(x)
```

If  $x$  is a numerical value, symbolic expressions in  $p$  are returned:

```
f(17/2), f(8), f(9.0), f(9.2)
```

$$0, -p(p-1)^7, p(1.0-1.0p)^{8.0}, 0.0$$

When numerical values are assigned to  $p$ , the function  $f$  starts to produce numbers if the argument is numerical:

```
p := 1/3: f(17/2), f(8), f(9.0), f(9.2)
```

0,  $\frac{128}{6561}$ , 0.01300614744, 0.0

delete f, p:

## Parameters

**p**

The 'probability parameter': an arithmetical expression (Symbolic Math Toolbox) representing a real number  $0 \leq p \leq 1$ .

## Return Values

procedure on page 1-1654.

## See Also

### MuPAD Functions

stats::geometricCDF | stats::geometricQuantile | stats::geometricRandom

# stats::geometricQuantile

Quantile function of the geometric distribution

## Syntax

`stats::geometricQuantile(p)`

## Description

`stats::geometricQuantile(p)` returns a procedure representing the quantile function (discrete inverse) of the cumulative distribution function `stats::geometricCDF(p)`. For  $0 \leq x \leq 1$ ,  $k = \text{stats::geometricQuantile}(p)(x)$  is the smallest positive integer satisfying

$$\text{stats::geometricCDF}(p)(k) = 1 - (1 - p)^k \geq x$$

The procedure `f:=stats::geometricQuantile(p)` can be called in the form `f(x)` with an arithmetical expression  $x$ . The return value of the call `f(x)` is either a positive integer, *infinity*, or a symbolic expression:

If  $p$  is a real number satisfying  $0 < p \leq 1$  and  $x$  is a real number satisfying  $0 \leq x < 1$ , then `f(x)` returns a positive integer.

If  $p = 0$ , then `f(x)` returns *infinity* for any  $x$ .

If  $p = 1$ , then `f(x)` returns 1 for any  $x$ .

If  $p \neq 0$ , then `f(0)` and `f(0.0)` return 1.

If  $p \neq 1$ , then `f(1)` and `f(1.0)` return *infinity*.

In all other cases, `f(x)` returns the symbolic call `stats::geometricQuantile(p)(x)`.

Numerical values for  $p$  are only accepted if they satisfy  $0 \leq p \leq 1$ .

If floating-point arguments are passed to the quantile function `f`, the result is computed with floating-point arithmetic. This is faster than using exact arithmetic, but the result is

subject to internal round-off errors. In particular, round-off may be significant for arguments  $x$  close to 1. Cf. “Example 3” on page 30-253 (Symbolic Math Toolbox).

Finite quantile values  $k = \text{stats}::\text{geometricQuantile}(p)(x)$  satisfy

$$\text{stats}::\text{geometricCDF}(p)(k - 1) < x \leq \text{stats}::\text{geometricCDF}(p)(k)$$

## Environment Interactions

The function is sensitive to the environment variable DIGITS which determines the numerical working precision.

## Examples

### Example 1

We evaluate the quantile function with  $p = \frac{1}{\pi}$  at various points:

```
f := stats::geometricQuantile(1/PI):  
f(0), f(1/20), f(PI/6), f(0.7), f(1-1/10^10), f(1)
```

```
1, 1, 2, 4, 61, ∞
```

The value  $f(x)$  satisfies

$$\text{stats}::\text{geometricCDF}(p)(f(x) - 1) < x \leq \text{stats}::\text{geometricCDF}(p)(f(x))$$

```
x := 0.98: k := f(x)
```

```
11
```

```
float(stats::geometricCDF(1/PI)(k - 1)), x,  
float(stats::geometricCDF(1/PI)(k))
```

```
0.9783294488, 0.98, 0.9852273995
```

```
delete f, x, k:
```

## Example 2

We use symbolic arguments:

```
f := stats::geometricQuantile(p): f(x), f(9/10)
```

$$\text{stats::geometricQuantile}(p)(x), \text{stats::geometricQuantile}(p)\left(\frac{9}{10}\right)$$

When  $p$  evaluates to a suitable real number, the function  $f$  starts to produce quantile values:

```
p := 1/sqrt(2):
f(1/2), f(999/1000), f(1 - 1/10^10), f(1 - 1/10^80)
```

$$1, 6, 19, 151$$

```
delete f, p:
```

## Example 3

If floating-point arguments are passed to the quantile function, the result is computed with floating-point arithmetic. This is faster than using exact arithmetic, but the result is subject to internal round-off errors:

```
f := stats::geometricQuantile(1/123):
f(1 - 1/10^19) <> f(float(1 - 1/10^19))
```

$$5360 \neq \infty$$

```
delete f:
```

## Parameters

**p**

The “probability parameter”: an arithmetical expression (Symbolic Math Toolbox) representing a real number  $0 \leq p \leq 1$ .

## Return Values

procedure on page 1-1654.

## See Also

### **MuPAD Functions**

`stats::geometricCDF` | `stats::geometricPF` | `stats::geometricRandom`



# stats::geometricRandom

Generate a random number generator for geometric deviates

## Syntax

```
stats::geometricRandom(p, <Seed = s>)
```

## Description

`stats::geometricRandom(p)` returns a procedure that produces geometric on page 30-244 deviates (random numbers) with 'probability parameter'  $p$ .

The procedure `f:=stats::geometricRandom(p)` can be called in the form `f()`. The return value of `f()` is a positive integer if  $p$  is a real number satisfying  $0 \leq p \leq 1$ .

Otherwise, `stats::geometricRandom(p)()` is returned symbolically.

Numerical values for  $p$  are only accepted if they satisfy  $0 \leq p \leq 1$ .

The values  $X = f()$  are distributed randomly according to the discrete distribution function of the geometric distribution with parameter  $p$ , i.e., for  $1 \leq x$ , the probability of  $X \leq x$  is given by  $1 - (1 - p)^x$ .

Without the option `Seed = s`, an initial seed is chosen internally. This initial seed is set to a default value when MuPAD is started. Thus, each time MuPAD is started or re-initialized with the `reset` function, random generators produce the same sequences of numbers.

---

**Note** With this option, the parameter  $p$  must evaluate to a numerical value at the time, when the generator is created.

---

---

**Note** In contrast to the function `random`, the generators produced by `stats::geometricRandom` do not react to the environment variable `SEED`.

---

For efficiency, it is recommended to produce sequences of  $K$  random numbers via

```
f := stats::geometricRandom(p): f() $k = 1..K;
```

rather than by

```
stats::geometricRandom(p)() $k = 1..K;
```

The latter call produces a sequence of generators each of which is called once. Also note that

```
stats::geometricRandom(p, Seed = s)() $k = 1..K;
```

does not produce a random sequence, because a sequence of freshly initialized generators would be created each of them producing the same number.

## Environment Interactions

The function is sensitive to the environment variable DIGITS which determines the numerical working precision.

## Examples

### Example 1

We generate geometric deviates with  $p = \frac{1}{3}$ :

```
f := stats::geometricRandom(1/3): f() $ k = 1..10
```

```
4, 1, 5, 1, 4, 5, 2, 1, 3, 1
```

```
delete f:
```

### Example 2

With symbolic parameters, no random floating-point numbers can be produced:

```
f := stats::geometricRandom(p): f()
```

```
stats::geometricRandom(p)()
```

When  $p$  evaluates to a real number between 0 and 1, the generator starts to produce random numbers:

```
p := 1/sqrt(70): f(), f(), f()
```

```
3, 6, 2
```

```
delete f, p:
```

### Example 3

We use the option `Seed = s` to reproduce a sequence of random numbers:

```
f := stats::geometricRandom(1/10, Seed = 1): f() $ k = 1..10
```

```
6, 3, 21, 17, 2, 55, 7, 16, 26, 11
```

```
g := stats::geometricRandom(1/10, Seed = 1): g() $ k = 1..10
```

```
6, 3, 21, 17, 2, 55, 7, 16, 26, 11
```

```
f() = g(), f() = g()
```

```
9 = 9, 8 = 8
```

```
delete f, g:
```

## Parameters

### **p**

The “probability parameter”: an arithmetical expression (Symbolic Math Toolbox) representing a real number  $0 \leq p \leq 1$ .

## Options

### Seed

Option, specified as `Seed = s`

Initializes the random generator with the integer seed `s`. `s` can also be the option `CurrentTime`, to make the seed depend on the current time.

This option serves for generating generators that return predictable sequences of pseudo-random numbers. The generator is initialized with the seed `s` which may be an arbitrary integer. Several generators with the same initial seed produce the same sequence of numbers.

When this option is used, the parameter `p` must be convertible to a floating-point number between 0.0 and 1.0 at the time when the random generator is generated.

## Return Values

procedure on page 1-1654.

## See Also

### MuPAD Functions

`stats::geometricCDF` | `stats::geometricPF` | `stats::geometricQuantile`

# stats::harmonicMean

Harmonic mean of a data sample

## Syntax

```
stats::harmonicMean(x1, x2, ...)
```

```
stats::harmonicMean([x1, x2, ...])
```

```
stats::harmonicMean(s, <c>)
```

## Description

stats::harmonicMean(x<sub>1</sub>, x<sub>2</sub>, ..., x<sub>n</sub>) returns the harmonic mean  $\frac{1}{\left(\frac{1}{n} \left(\sum_i \frac{1}{x_i}\right)\right)}$  of the data x<sub>i</sub>.

The column index c is optional, if the data are given by a stats::sample object containing only one non-string column. Cf. "Example 3" on page 30-260 (Symbolic Math Toolbox).

External statistical data stored in an ASCII file can be imported into a MuPAD session via import::readdata. In particular, see Example 1 of the corresponding help page on page 13-11.

## Examples

### Example 1

We calculate the harmonic mean of three values:

```
stats::harmonicMean(a, b, c)
```

$$\frac{3}{\frac{1}{a} + \frac{1}{b} + \frac{1}{c}}$$

Alternatively, data may be passed as a list:

```
stats::harmonicMean([2, 3, 5])
```

$$\frac{90}{31}$$

## Example 2

We create a sample:

```
stats::sample([[a1, b1, c1], [a2, b2, c2]])
```

```
a1 b1 c1  
a2 b2 c2
```

The harmonic mean of the second column is:

```
stats::harmonicMean(%, 2)
```

$$\frac{2}{\frac{1}{b1} + \frac{1}{b2}}$$

## Example 3

We create a sample consisting of one string column and one non-string column:

```
stats::sample(["1996", 1242], ["1997", 1353], ["1998", 1142])
```

```
"1996" 1242  
"1997" 1353  
"1998" 1142
```

We compute the harmonic mean of the second column. In this case this column does not have to be specified, since it is the only non-string column:

```
float(stats::harmonicMean(%))
```

```
1239.71654
```

## Parameters

$x_1, x_2, \dots$

The statistical data: arithmetical expressions. (Symbolic Math Toolbox)

**s**

A sample of domain type `stats::sample`.

**c**

An integer representing a column index of the sample *s*. This column provides the data  $x_1, x_2$  etc.

## Return Values

arithmetical expression. (Symbolic Math Toolbox) FAIL is returned, if one of the data values is zero (the harmonic mean does not exist).

## See Also

### MuPAD Functions

`stats::geometricMean` | `stats::mean` | `stats::median` | `stats::modal` |  
`stats::quadraticMean` | `stats::stdev` | `stats::variance`

## stats::hodrickPrescottFilter

The Hodrick-Prescott filter

### Syntax

```
stats::hodrickPrescottFilter([x1, x2, ...], p)
```

```
stats::hodrickPrescottFilter(s, <c>, p)
```

### Description

`stats::hodrickPrescottFilter([x1, x2, ...], p)` returns a list of data from which cyclic variations of the time series given by the input data  $x_1, x_2$  etc. are eliminated using the Hodrick-Prescott filter process.

The Hodrick-Prescott filter scheme tries to split a time series consisting of the data  $x_1, x_2$  etc. into a “trend” that is approximately linear in time plus a “cyclic” contribution. The data returned by `stats::hodrickPrescottFilter` describe the trend. The cyclic part  $c$  may be computed by

```
x := [x1, x2, ...]:
```

```
y := stats::HodrickPrescottFilter(x, p):
```

```
c := zip(x, y, _subtract):
```

Thus,  $x_i = y_i + c_i$ .

Large values of the penalty parameter  $p$  lead to smooth straight trend curves. Cf. “Example 5” on page 30-267 (Symbolic Math Toolbox).

If the data are provided by a `stats::sample` object containing only one non-string column, the column index  $c$  is optional. Cf. “Example 3” on page 30-264 (Symbolic Math Toolbox).



External statistical data stored in an ASCII file can be imported into a MuPAD session via `import::readdata`. In particular, see Example 1 of the corresponding help page on page 13-11.

## Examples

### Example 1

We apply the Hodrick-Prescott filter to some data. The result shows an obvious trend towards increasing data values:

```
stats::hodrickPrescottFilter([1, 2, 3, 2, 3, 4, 3, 4, 5], 10)
```

```
[1.356447588, 1.819582682, 2.247073017, 2.621315566, 3.0, 3.378684434, 3.752926983,
4.180417318, 4.643552412]
```

### Example 2

We create a sample:

```
s := stats::sample([[i + frandom() - 0.5, -i + frandom() - 0.5]
                    $ i = 1..10])
```

```
0.7703581656 -0.6689628213
1.653156516 -1.505187219
2.766272902 -3.319835772
3.952083055 -3.821218044
4.854984926 -4.818141187
6.221918655 -6.026170226
7.288981492 -7.288474164
8.355687175 -8.455102606
9.379160127 -8.580615152
10.23505742 -9.712454973
```

The Hodrick-Prescott filter process applied to the data in the first column yields:

```
p := 10:
stats::hodrickPrescottFilter(s, 1, p)
```

```
[0.7163345093, 1.721715792, 2.781120731, 3.880013706, 4.989011271, 6.150799324,  
7.274037423, 8.338504453, 9.338923372, 10.28719986]
```

```
stats::hodrickPrescottFilter(s, 2, p)
```

```
[-0.6351055566, -1.760720308, -2.903263691, -3.951897795, -5.004070747,  
-6.091890803, -7.154501435, -8.098185826, -8.896213527, -9.700312476]
```

```
delete s, p:
```

### Example 3

We create a sample consisting of one string column and one non-string column:

```
s := stats::sample([["1996", 1242],  
                    ["1997", 1353],  
                    ["1998", 1142],  
                    ["1999", 1255],  
                    ["2000", 1417],  
                    ["2001", 1312],  
                    ["2002", 1440],  
                    ["2003", 1422],  
                    ["2004", 1470]  
                    ])
```

```
"1996" 1242  
"1997" 1353  
"1998" 1142  
"1999" 1255  
"2000" 1417  
"2001" 1312  
"2002" 1440  
"2003" 1422  
"2004" 1470
```

We apply the Hodrick-Prescott filter to the second column. In this case, this column needs not be specified, since it is the only non-string column:

```
y := stats::hodrickPrescottFilter(s, 10)
```

```
[1239.848378, 1255.015604, 1270.397993, 1296.009146, 1329.022865, 1362.512038,
 1398.347268, 1433.347951, 1468.498758]
```

We convert this list to a sample object:

```
y := stats::sample(y)
```

```
1239.848378
1255.015604
1270.397993
1296.009146
1329.022865
1362.512038
1398.347268
1433.347951
1468.498758
```

We create a new sample consisting of the filtered data:

```
stats::concatCol(stats::col(s, 1), y)
```

```
"1996" 1239.848378
"1997" 1255.015604
"1998" 1270.397993
"1999" 1296.009146
"2000" 1329.022865
"2001" 1362.512038
"2002" 1398.347268
"2003" 1433.347951
"2004" 1468.498758
```

```
delete s, y:
```

## Example 4

We model monthly data with a decaying trend of  $\frac{1}{1+0.01*i}$ , where  $i$  is the index of the month. These trend data are obscured by cyclic contributions and random noise:

```
monthlyData:= i ->
  ( 1/(1 + 0.01*i) // the trend
```

```

+ 0.7*cos(i * 1.12*2*float(PI)) // cycle
+ 0.3*sin(i * 2.04*4*float(PI)) // cycle
+ 0.2*cos(i * 1.01*6*float(PI)) // cycle
+ 2.3*frandom() // random noise
):

```

We provide monthly data for 10 years, i.e., 120 months. The cyclic contributions and the noise are eliminated from the time series by the Hodrick-Prescott filter process:

```

n := 120:
x := [monthlyData(i) $ i = 1..n]:
trend := stats::hodrickPrescottFilter(x, 10^5):
cycle := zip(x, trend, _subtract):

```

We visualize the splitting of the time series (black) into the approximately linear trend contribution (red) plus the cyclic part (blue):

```

plot(
  plot::Listplot([[i, x[i]] $ i = 1..n], Color = RGB::Black),
  plot::Listplot([[i, trend[i]] $ i = 1..n], Color = RGB::Red),
  plot::Listplot([[i, cycle[i]] $ i = 1..n], Color = RGB::Blue)
)

```

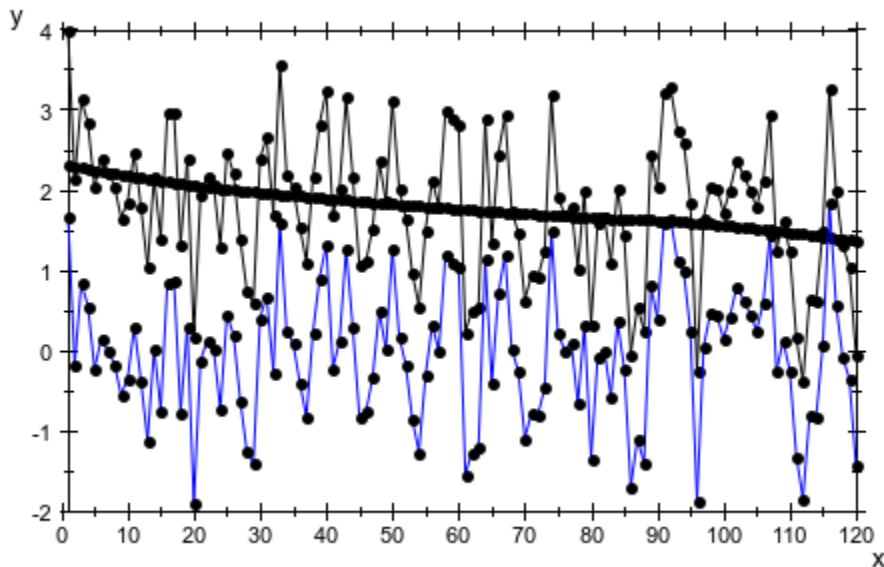

We use a scatterplot to visualize a linear regression of the unfiltered data. The regression line is in good accordance with the trend line above:

```
plot(plot::Scatterplot([[i, x[i]] $ i = 1..n]))
```

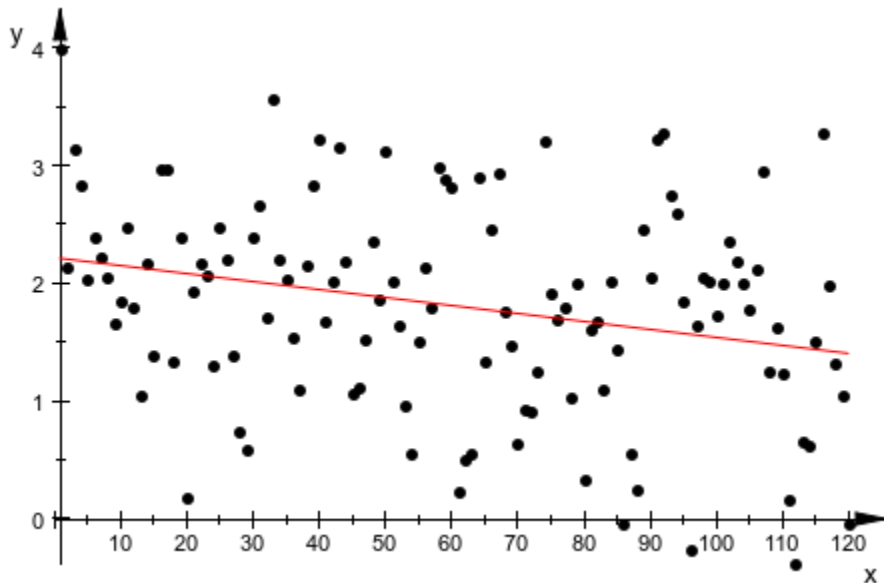

```
delete monthlyData, n, x, trend, cycle:
```

## Example 5

We demonstrate the effect of the penalty parameter  $p$  by an animated plot:

```
delete p:
n := 100:
data := [1/(1 + 0.01*i) + frandom() $ i = 1..n]:
for i from 0 to 30 step 1/5 do
  trend := stats::hodrickPrescottFilter(data, 10^(0.2*i));
  L[i] := plot::Listplot([[i, trend[i]] $ i = 1..n],
    Color = RGB::Red, VisibleFromTo = i .. i + 0.2);
  T[i] := plot::Text2d(expr2text(p = 10^(0.2*i)), [70, 1.7],
    VisibleFromTo = i .. i + 0.2);
end_for:
```

```
plot(plot::Listplot([[i, data[i]] $ i = 1..n], Color=RGB::Black),
      L[i] $ i = 0..30 step 1/5, T[i] $ i = 0..30 step 1/5)
```

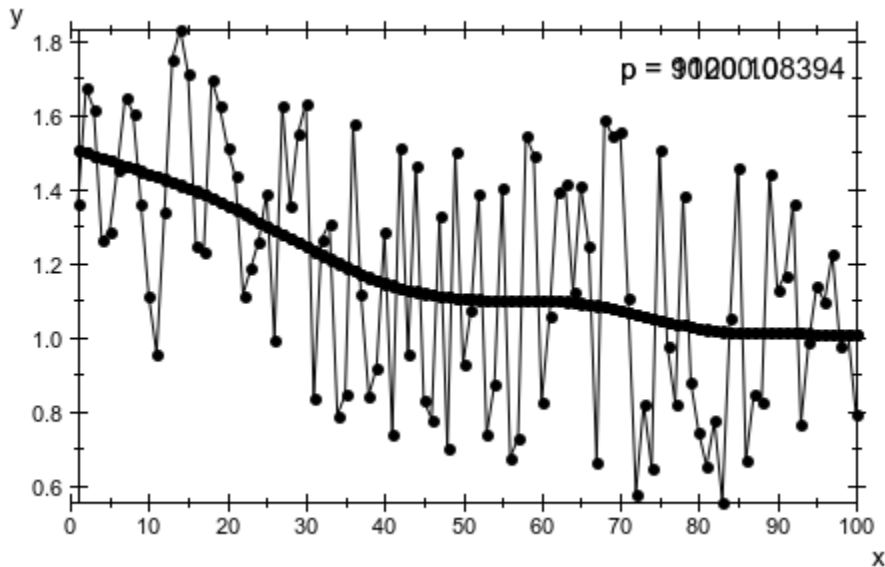

Large penalty parameters  $p$  result in trend curves that are close to a straight line. This is not always the desired information. The following animation features a time series with a parabolic trend curve obscured by random noise. Too large values of  $p$  produce a trend curve that just displays the mean of the data:

```
data := [8*frandom() + 5 - (i - 50)^2/100 $ i = 1..n]:
for i from 0 to 50 do
  trend := stats::hodrickPrescottFilter(data, 10^(0.2*i));
  L[i] := plot::Listplot([[i, trend[i]] $ i = 1..n],
    Color = RGB::Red,
    VisibleFromTo = i/5 .. (i + 1)/5);
  T[i] := plot::Text2d(expr2text(p = 10^(0.2*i)), [50, -5],
    VisibleFromTo = i/5 .. (i + 1)/5);
end_for:
plot(plot::Listplot([[i, data[i]] $ i = 1..n], Color=RGB::Black),
      L[i] $ i = 0..50, T[i] $ i = 0..50)
```

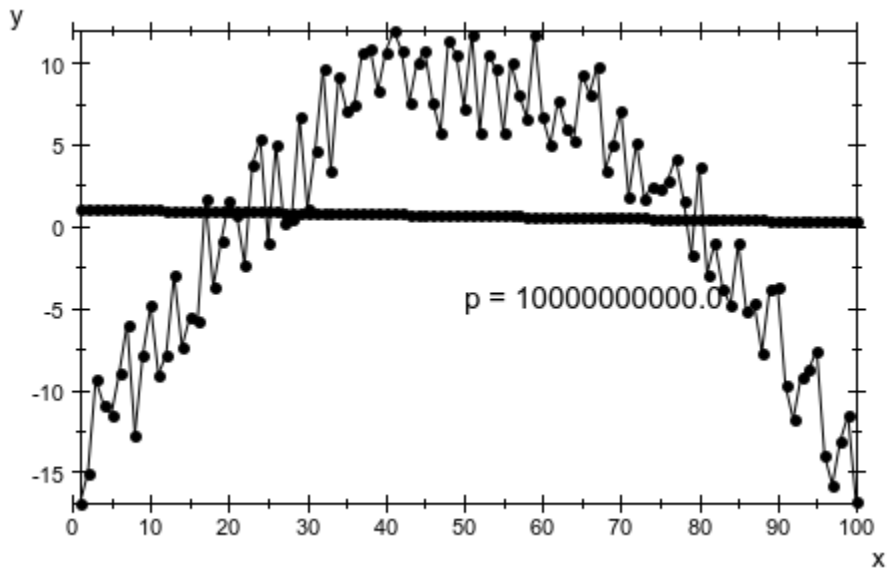

delete n, data, i, trend, L, T:

## Parameters

$x_1, x_2, \dots$

The statistical data (time series): arithmetical expressions (Symbolic Math Toolbox).

**s**

A sample of domain type `stats::sample`.

**c**

An integer representing a column index of the sample *s*. This column provides the data  $x_1, x_2$  etc.

**p**

The penalty parameter of the Hodrick-Prescott scheme: a real positive numerical value.

If the data  $x_1, x_2$  etc. represent monthly measurements, the literature recommends values of  $p$  between 1000 and 1400.

If the data represent quarterly measurements, values of  $p$  around 1600 are recommended.

If the data represent yearly measurements, values of  $p$  between 6 and 14 are recommended.

## Return Values

List of floating-point data.

## References

Robert Hodrick and Edward C. Prescott, "Postwar U.S. Business Cycles: An Empirical Investigation." *Journal of Money, Credit and Banking*, 1997.

Maravall, Agustin and Ana del Rio, "Time Aggregation and the Hodrick-Prescott Filter", Banco de Espana, 2001.

## See Also

### MuPAD Functions

`stats::linReg` | `stats::reg`

### MuPAD Graphical Primitives

`plot::Listplot` | `plot::Scatterplot`



# stats::hypergeometricCDF

The (discrete) cumulative probability function of the hypergeometric distribution

## Syntax

stats::hypergeometricCDF(N, X, n)

## Description

stats::hypergeometricCDF(N, X, n) returns a procedure representing the probability function

$$x \rightarrow \begin{cases} 0 & \text{if } x < \max(0, n + X - N) \\ \sum_{i=\max(0, n+X-N)}^{\lfloor x \rfloor} \frac{\binom{X}{i} \binom{N-X}{n-i}}{\binom{N}{n}} & \text{if } \max(0, n + X - N) \leq x \leq \min(n, X) \\ 1 & \text{if } x > \min(n, X) \end{cases}$$

of the hypergeometric distribution with “population size” N, “success population size” X and “sample size” n.

The procedure `f:=stats::hypergeometricCDF(N, X, n)` can be called in the form `f(x)` with arithmetical expressions `x`. The return value of `f(x)` is either a floating-point number, an exact numerical value, or a symbolic expression:

If `x` is an integer, a rational or a floating point number, while N is a positive integer and both X and n are nonnegative integers, then an explicit numerical value is returned.

The function `f` reacts to properties of identifiers set via `assume`.

If any of the parameters is symbolic with properties as follows, then 0, 1 or a symbolic result is returned:

If  $x < \max(0, n + X - N)$ , then  $f(x) = 0$ .

If  $x \geq \min(n, X)$ , then  $f(x) = 1$ .

If  $X = N$ , then  $f(x) = 0$  for  $x < n$  and  $f(x) = 1$  for  $x \geq n$ .

If  $n = N$ , then  $f(x) = 0$  for  $x < X$  and  $f(x) = 1$  for  $x \geq X$ .

If  $X = N - 1$ , then  $f(x) = 0$  for  $x < n - 1$ ,  $f(x) = \frac{n}{N}$  for  $n - 1 \leq x < n$  and  $f(x) = 1$  for  $x \geq n$ .

If  $n = N - 1$ , then  $f(x) = 0$  for  $x < X - 1$ ,  $f(x) = \frac{X}{N}$  for  $X - 1 \leq x < X$  and  $f(x) = 1$  for  $x \geq X$ .

If  $X = 1$ , then  $f(x) = \frac{N-n}{N}$  for  $0 \leq x < 1$  and  $f(x) = 1$  for  $x \geq 1$ .

If  $n = 1$ , then  $f(x) = \frac{N-X}{N}$  for  $0 \leq x < 1$  and  $f(x) = 1$  for  $x \geq 1$ .

If  $X = 0$  or  $n = 0$ , then  $f(x) = 1$  for  $x \geq 0$ .

If  $x$  and all parameters but  $N$  are numerical and the assumption on  $N$  is `assume(N > X)`, then symbolic values are returned.

$f(x)$  returns the symbolic call `stats::hypergeometricCDF(N, X, n)(x)` in all other cases.

Numerical values for  $N$  are only accepted if they are positive integers.

Numerical values for  $X$  are only accepted if they are nonnegative integers.

Numerical values for  $n$  are only accepted if they are nonnegative integers.

---

**Note** If  $x$  is a floating-point number, the result is a floating number provided  $N$ ,  $X$  and  $n$  are numerical values. If  $x$  is an exact value, the result is a rational number.

---

Note that for large numbers, floating-point results are computed much faster than exact results. If floating-point approximations are desired, pass a floating-point number  $x$  to `stats::hypergeometricCDF`.

## Environment Interactions

The function is sensitive to the environment variable DIGITS which determines the numerical working precision.

## Examples

### Example 1

We compute the distribution function with  $N = 20$ ,  $X = 4$  and  $n = 3$  at various points:

```
f := stats::hypergeometricCDF(20, 4, 3):
f(-1), f(0), f(1/2), f(1), f(2), f(PI), f(5)
```

```
0, 28/57, 28/57, 52/57, 284/285, 1, 1
```

```
f(-infinity), f(infinity)
```

```
0, 1
```

```
f(-0.2), f(0.0), f(0.7), f(1.0), f(float(PI)), f(4.0)
```

```
0.0, 0.4912280702, 0.4912280702, 0.9122807018, 1.0, 1.0
```

```
delete f:
```

### Example 2

We use symbolic arguments:

```
f := stats::hypergeometricCDF(N, X, n): f(x), f(8), f(8.0)
```

```
stats::hypergeometricCDF(N, X, n)(x), stats::hypergeometricCDF(N, X, n)(8),
stats::hypergeometricCDF(N, X, n)(8.0)
```

When real numbers are assigned to  $N$ ,  $X$  and  $n$ , the function  $f$  starts to produce explicit results if the argument is numerical:

```
N := 15: X := 6: n := 5:  
f(0), f(1), f(2.0), f(3.5), f(4)
```

$$\frac{6}{143}, \frac{42}{143}, 0.7132867133, 0.953046953, \frac{999}{1001}$$

```
delete f, N, X, n:
```

### Example 3

If one or more parameters are symbolic, usually a symbolic call is returned. Some combinations of symbolic and numeric values for  $N$ ,  $X$ ,  $n$  and  $x$ , however, may yield symbolic or numeric results:

```
f := stats::hypergeometricCDF(N, X, n):  
X := 1:  
f(-1), f(0), f(1/2), f(0.5), f(3/2), f(2.0)
```

$$0, \frac{N-n}{N}, \frac{N-n}{N}, \frac{N-1.0n}{N}, 1, 1.0$$

```
X := N - 1:  
f(1), f(n-1), f(n)
```

$$\text{stats::hypergeometricCDF}(N, N-1, n)(1), \frac{n}{N}, 1$$

```
delete X:
```

### Example 4

If  $x$  and all parameters but  $N$  are numerical and  $N$  is assumed to be greater than  $X$ , a symbolic expression is returned:

```
X := 6:  
assume(N > X):  
f := stats::hypergeometricCDF(N, X, 5):  
f(1), f(2), f(3)
```

$$1 - \frac{15N + 20 \binom{N-6}{2} + 15 \binom{N-6}{3} - 84}{\binom{N}{5}}, 1 - \frac{15N + 20 \binom{N-6}{2} - 84}{\binom{N}{5}}, 1 - \frac{15N - 84}{\binom{N}{5}}$$

delete f, N, X:

## Parameters

**N**

The “population size”: an arithmetical expression (Symbolic Math Toolbox) representing a positive integer

**X**

The “success population size”: an arithmetical expression (Symbolic Math Toolbox) representing a nonnegative integer

**n**

The “sample size”: an arithmetical expression (Symbolic Math Toolbox) representing a nonnegative integer

## Return Values

procedure on page 1-1654.

## See Also

### MuPAD Functions

stats::hypergeometricPF | stats::hypergeometricQuantile |  
stats::hypergeometricRandom

## stats::hypergeometricPF

Probability function of the hypergeometric distribution

### Syntax

stats::hypergeometricPF(N, X, n)

### Description

stats::hypergeometricPF(N, X, n) returns a procedure representing the probability function

$$x \rightarrow \frac{\binom{X}{x} \binom{N-X}{n-x}}{\binom{N}{n}}$$

for  $x \in \mathbb{N} \cap [\max(0, n + X - N), \min(n, X)]$  of the hypergeometric distribution with “population size”  $N$ , “success population size”  $X$  and “sample size”  $n$ .

The procedure `f:=stats::hypergeometricPF(N, X, n)` can be called in the form `f(x)` with arithmetical expressions  $x$ . The return value of `f(x)` is either a floating-point number, an exact numerical value, or a symbolic expression:

If  $x$  is a noninteger numerical value, `f(x)` returns 0 or 0.0, respectively.

If  $x$  is an integer or the floating-point equivalent of an integer, while  $N$  is a positive integer and both  $X$  and  $n$  are nonnegative integers, then an explicit numerical value is returned.

The function `f` reacts to properties of identifiers set via `assume`.

If any of the parameters is symbolic with properties as follows, then 0, 1 or a symbolic result is returned:

If  $X = N$ , then  $f(x) = 1$  for  $x = n$  and  $f(x) = 0$  for  $x \neq n$ . If  $n = N$ , then  $f(x) = 1$  for  $x = X$  and  $f(x) = 0$  for  $x \neq X$ .

If  $X = N - 1$ , then  $f(x) = \frac{N-n}{N}$  for  $x = n$ ,  $f(x) = \frac{n}{N}$  for  $x = n - 1$  and  $f(x) = 0$  for  $x \neq n, n - 1$ .

If  $n = N - 1$ , then  $f(x) = \frac{N-X}{N}$  for  $x = X$ ,  $f(x) = \frac{X}{N}$  for  $x = X - 1$  and  $f(x) = 0$  for  $x \neq X, X - 1$ .

If  $X = 1$ , then  $f(x) = \frac{N-n}{N}$  for  $x = 0$ ,  $f(x) = \frac{n}{N}$  for  $x = 1$  and  $f(x) = 0$  for  $x \neq 0, 1$ .

If  $n = 1$ , then  $f(x) = \frac{N-X}{N}$  for  $x = 0$ ,  $f(x) = \frac{X}{N}$  for  $x = 1$  and  $f(x) = 0$  for  $x \neq 0, 1$ .

If  $X = 0$  or  $n = 0$ , then  $f(x) = 1$  for  $x = 0$  and  $f(x) = 0$  for  $x \neq 0$ .

If  $x$  and all parameters but  $N$  are numerical and the assumption on  $N$  is `assume(N > X)`, then symbolic values are returned.

$f(x)$  returns the symbolic call `stats::hypergeometricPF(N, X, n)(x)` in all other cases.

Numerical values for  $N$  are only accepted if they are positive integers.

Numerical values for  $X$  are only accepted if they are nonnegative integers.

Numerical values for  $n$  are only accepted if they are nonnegative integers.

---

**Note** If  $x$  is a floating-point number, the result is a floating number provided  $N$ ,  $X$  and  $n$  are numerical values. If  $x$  is an exact value, the result is a rational number.

---

Note that for large numbers, floating-point results are computed much faster than exact results. If floating-point approximations are desired, pass a floating-point number  $x$  to `stats::hypergeometricPF`.

## Environment Interactions

The function is sensitive to the environment variable `DIGITS` which determines the numerical working precision.

## Examples

### Example 1

We compute the probability function with  $N = 20$ ,  $X = 4$  and  $n = 3$  at various points:

```
f := stats::hypergeometricPF(20, 4, 3):  
f(-infinity), f(0), f(1/2), f(1), f(2), f(4), f(infinity)
```

```
0,  $\frac{28}{57}$ , 0,  $\frac{8}{19}$ ,  $\frac{8}{95}$ , 0, 0
```

```
f(-0.2), f(0.0), f(0.7), f(1.0), f(2.0), f(2.7), f(3.0), f(4.0)
```

```
0.0, 0.4912280702, 0.0, 0.4210526316, 0.08421052632, 0.0, 0.00350877193, 0.0
```

```
delete f:
```

### Example 2

We use symbolic arguments:

```
f := stats::hypergeometricPF(N, X, n): f(x), f(8), f(8.0)
```

```
stats::hypergeometricPF(N, X, n)(x), stats::hypergeometricPF(N, X, n)(8),  
stats::hypergeometricPF(N, X, n)(8.0)
```

When real numbers are assigned to  $N$ ,  $X$  and  $n$ , the function  $f$  starts to produce explicit results if the argument is numerical:

```
N := 15: X := 6: n := 5:  
f(0), f(1), f(2.0), f(3.5), f(4)
```

```
 $\frac{6}{143}$ ,  $\frac{36}{143}$ , 0.4195804196, 0.0,  $\frac{45}{1001}$ 
```

```
delete f, N, X, n, x:
```



### Example 3

If one or more parameters are symbolic, usually a symbolic call is returned. Some combinations of symbolic and numeric values for  $N$ ,  $X$ ,  $n$  and  $x$ , however, may yield symbolic or numeric results:

```
f := stats::hypergeometricPF(N, X, n):
X := 1:
f(-1), f(0), f(1), f(3/2), f(2), f(3)
```

$$0, \frac{N-n}{N}, \frac{n}{N}, 0, 0, 0$$

```
X := N:
f(-1), f(n), f(n + 1)
```

$$0, 1, 0$$

```
delete f, X:
```

### Example 4

If  $x$  and all parameters but  $N$  are numerical and  $N$  is assumed to be greater than  $X$ , a symbolic expression is returned:

```
X := 6:
assume(N > X):
f := stats::hypergeometricPF(N, X, 5):
f(2), f(4), f(5.0)
```

$$\frac{15 \binom{N-6}{3}}{\binom{N}{5}}, \frac{15 N - 90}{\binom{N}{5}}, \frac{6.0}{\binom{N}{5.0}}$$

```
delete f, N, X:
```

## Parameters

### **N**

The “population size”: an arithmetical expression (Symbolic Math Toolbox) representing a positive integer

### **X**

The “success population size”: an arithmetical expression (Symbolic Math Toolbox) representing a nonnegative integer

### **n**

The “sample size”: an arithmetical expression (Symbolic Math Toolbox) representing a nonnegative integer

## Return Values

procedure on page 1-1654.

## See Also

### **MuPAD Functions**

`stats::hypergeometricCDF` | `stats::hypergeometricQuantile` |  
`stats::hypergeometricRandom`

# stats::hypergeometricQuantile

Quantile function of the hypergeometric distribution

## Syntax

`stats::hypergeometricQuantile(N, X, n)`

## Description

`stats::hypergeometricQuantile(N, X, n)` returns a procedure representing the quantile function (discrete inverse) of the cumulative distribution function

`stats::hypergeometricCDF(N, X, n)`. For  $0 \leq x \leq 1$ ,  $k =$

`stats::hypergeometricQuantile(N, X, n)(x)` is the smallest nonnegative integer satisfying

$$\text{stats::hypergeometricCDF}(N, X, n)(k) = \sum_{i=0}^k \frac{\binom{X}{i} \binom{N-X}{n-i}}{\binom{N}{n}} \geq x$$

The procedure `f:=stats::hypergeometricQuantile(N, X, n)` can be called in the form `f(x)` with arithmetical expressions  $x$ . The return value of `f(x)` is either a natural number between 0 and  $\min(X, n)$ , or a symbolic expression:

If  $x$  is a real number satisfying  $0 \leq x \leq 1$ , while  $N$  is a positive integer and both  $X$  and  $n$  are nonnegative integers, then an explicit numerical value is returned.

The function `f` reacts to properties of identifiers set via `assume`.

If any of the parameters is symbolic, then in some cases a symbolic result will be returned:

0 will be returned if either any of  $x$ ,  $n$  or  $X$  is zero or if  $n = 1$  and  $x \leq \frac{N-X}{N}$  or if  $X = 1$  and

$$x \leq \frac{N-n}{N}.$$

1 will be returned if  $n = 1$  and  $x > \frac{N-X}{N}$  or if  $X = 1$  and  $x > \frac{N-n}{N}$ .

$n$  will be returned if  $X = N - 1$  and  $x > \frac{n}{N}$  or if  $X = N$  and  $x > 0$ .

$X$  will be returned if  $n = N - 1$  and  $x > \frac{X}{N}$  or if  $n = N$  and  $x > 0$ .

$n - 1$  will be returned if  $X = N - 1$  and  $x = \frac{n}{N}$  provided that  $n$  is symbolic, whereas  $X - 1$  will be returned if  $n = N - 1$  and  $x = \frac{X}{N}$  provided that  $X$  is symbolic.

Finally  $\min(X, n)$  will be returned if  $x = 1$ .

The symbolic call `stats::hypergeometricQuantile(N, X, n)(x)` is returned by `f(x)` in all other cases.

Numerical values for  $N$  are only accepted if they are positive integers.

Numerical values for  $X$  are only accepted if they are nonnegative integers.

Numerical values for  $n$  are only accepted if they are nonnegative integers.

If  $x$  is a floating-point number, the result is a floating number provided  $N$ ,  $X$  and  $n$  are numerical values. If  $x$  is an exact value, the result is a rational number.

---

**Note** Note that if floating-point arguments are passed to the quantile function  $f$ , the result is computed with floating-point arithmetic. This is faster than using exact arithmetic, but the result is subject to internal round-off errors. In particular, round-off may be significant for arguments  $x$  close to 1. Cf. "Example 4" on page 30-285 (Symbolic Math Toolbox).

---

The quantile value  $k = \text{stats::hypergeometricQuantile}(N, X, n)(x)$  satisfies

$$\text{cdf}(k-1) < x \leq \text{cdf}(k),$$

where  $\text{cdf} = \text{stats::hypergeometricCDF}(N, X, n)$ .

## Environment Interactions

The function is sensitive to the environment variable DIGITS which determines the numerical working precision.

## Examples

### Example 1

We evaluate the quantile function with  $N = 50$ ,  $X = 30$  and  $n = 10$  at some points:

```
f := stats::hypergeometricQuantile(50, 30, 10):
f(0), f((2/3)^30), f(PI/10), f(0.5), f(1 - 1/10^10)
```

```
0, 0, 5, 6.0, 10
```

With  $cdf = stats::hypergeometricCDF(N, X, n)$ , the quantile value  $f(x)$  satisfies the inequalities  $cdf(f(x) - 1) < x \leq cdf(f(x))$ :

```
x := 0.7: f(x)
```

```
7.0
```

```
stats::hypergeometricCDF(50, 30, 10)(float(f(x) - 1)), x,
stats::hypergeometricCDF(50, 30, 10)(float(f(x)))
```

```
0.6350317132, 0.7, 0.8609613426
```

```
delete f, x:
```

### Example 2

We use symbolic arguments:

```
f := stats::hypergeometricQuantile(N, X, n): f(x), f(9/10)
```

```
stats::hypergeometricQuantile(N, X, n)(x), stats::hypergeometricQuantile(N, X, n)( $\frac{9}{10}$ )
```

When  $N$ ,  $X$  and  $n$  evaluate to suitable numbers, the function  $f$  starts to produce quantile values:

```
N := 500: X := 80: n := 18:  
f(1/2), f(999/1000), f(1 - 1/10^10), f(1 - 1/10^80)
```

```
3, 8, 15, 18
```

```
delete f, N, X, n:
```

### Example 3

If one or more parameters are symbolic, usually a symbolic call is returned. Some combinations of symbolic and numeric values for  $N$ ,  $X$ ,  $n$  and  $x$ , however, may yield symbolic or numeric results:

```
f := stats::hypergeometricQuantile(N, X, n):  
f(0), f(1)
```

```
0, min(X, n)
```

```
X := N - 1:  
f(n/N), f(7/10)
```

```
n - 1, stats::hypergeometricQuantile(N, N - 1, n)( $\frac{7}{10}$ )
```

```
assume(x > n/N):  
f(0.5), f(x)
```

```
stats::hypergeometricQuantile(N, N - 1, n)(0.5), n
```

```
delete f, X, x:
```

## Example 4

If floating-point arguments are passed to the quantile function, the result is computed with floating-point arithmetic. This is faster than using exact arithmetic, but the result is subject to internal round-off errors:

```
f := stats::hypergeometricQuantile(10000, 2000, 30):  
f(1 - 1/10^18) <> f(float(1 - 1/10^18))
```

```
28 ≠ 27.0
```

```
delete f:
```

## Parameters

**N**

The “population size”: an arithmetical expression (Symbolic Math Toolbox) representing a positive integer

**X**

The “success population size”: an arithmetical expression (Symbolic Math Toolbox) representing a nonnegative integer

**n**

The “sample size”: an arithmetical expression (Symbolic Math Toolbox) representing a nonnegative integer

## Return Values

procedure on page 1-1654.

## See Also

### **MuPAD Functions**

`stats::hypergeometricCDF` | `stats::hypergeometricPF` |  
`stats::hypergeometricRandom`



## stats::hypergeometricRandom

Generate a random number generator for hypergeometric deviates

### Syntax

```
stats::hypergeometricRandom(N, X, n, <Seed = s>)
```

### Description

`stats::hypergeometricRandom(N, X, n)` returns a procedure that produces hypergeometric on page 30-271-deviates (random numbers) with population size  $N$ , success population size  $X$  and sample size  $n$ .

The procedure `f:=stats::hypergeometricRandom(N, X, n)` can be called in the form `f()`.

The return value of `f(x)` is either an integer between  $\max(0, X + n - N)$  and  $\min(X, n)$  or a symbolic expression:

If  $N$  is a positive integer and both  $X$  and  $n$  are nonnegative integers, then an explicit numerical value is returned.

If any of the parameters is symbolic, then in some cases numerical or symbolic result will be returned:

0 will be returned if either  $n$  or  $X$  is zero,  $n$  will be returned if  $N = X$  and  $X$  will be returned if  $N = n$ .

The symbolic call `stats::hypergeometricRandom(N, X, n)()` is returned in all other cases.

Numerical values for  $N$  are only accepted if they are positive integers.

Numerical values for  $X$  and  $n$  are only accepted if they are integers that satisfy  $0 \leq X, n \leq N$ .

The values  $R = f()$  are distributed randomly according to the hypergeometric distribution with population size  $N$ , success population size  $X$  and sample size  $n$ .

For any  $\max(0, X + n - N) \leq x \leq \min(X, n)$ , the probability of  $R \leq x$  is given by

$$\sum_{i=\max(0, n+X-N)}^{\lfloor x \rfloor} \frac{\binom{X}{i} \binom{N-X}{n-i}}{\binom{N}{n}}$$

Without the option `Seed = s`, an initial seed is chosen internally. This initial seed is set to a default value when MuPAD is started. Thus, each time MuPAD is started or re-initialized with the `reset` function, random generators produce the same sequences of numbers.

---

**Note** With this option, the parameters  $N$ ,  $X$  and  $n$  must evaluate to suitable numerical values at the time, when the generator is created.

---



---

**Note** In contrast to the function `random`, the generators produced by `stats::hypergeometricRandom` do not react to the environment variable `SEED`.

---

For efficiency, it is recommended to produce sequences of  $K$  random numbers via

```
f := stats::hypergeometricRandom(N, X, n): f() $k = 1..K;
```

rather than by

```
stats::hypergeometricRandom(N, X, n)() $k = 1..K;
```

The latter call produces a sequence of generators each of which is called once. Also note that

```
stats::hypergeometricRandom(N, X, n, Seed = s)() $k = 1..K;
```

does not produce a random sequence, because a sequence of freshly initialized generators would be created each of them producing the same number.

## Environment Interactions

The function is sensitive to the environment variable DIGITS which determines the numerical working precision.

## Examples

### Example 1

We generate hypergeometric deviates with parameters  $N = 100$ ,  $X = 30$ , and  $n = 7$ :

```
f := stats::hypergeometricRandom(100, 30, 7): f() $ k = 1..10
```

```
2, 2, 6, 2, 2, 3, 0, 3, 4, 4
```

```
delete f:
```

### Example 2

With symbolic parameters, no random numbers can be produced:

```
f := stats::hypergeometricRandom(N, X, n): f()
```

```
stats::hypergeometricRandom(N, X, n)()
```

When  $N$ ,  $X$  and  $n$  evaluate to suitable numbers, the generator starts to produce random numbers:

```
N := 200: X := 80: n := 20: f() $ k= 1..10
```

```
6, 4, 12, 5, 10, 5, 11, 5, 9, 7
```

```
delete f, N, X, n:
```

### Example 3

We use the option `Seed = s` to reproduce a sequence of random numbers:

```
f := stats::hypergeometricRandom(500, 100, 50, Seed = 1):  
f() $ k = 1..10
```

```
6, 10, 4, 13, 8, 5, 12, 12, 11, 11
```

```
g := stats::hypergeometricRandom(500, 100, 50, Seed = 1):  
g() $ k = 1..10
```

```
6, 10, 4, 13, 8, 5, 12, 12, 11, 11
```

```
f() = g(), f() = g()
```

```
5 = 5, 10 = 10
```

```
delete f, g:
```

## Parameters

### N

The “population size”: an arithmetical expression (Symbolic Math Toolbox) representing a positive integer

### X

The “success population size”: an arithmetical expression (Symbolic Math Toolbox) representing a nonnegative integer

### n

The “sample size”: an arithmetical expression (Symbolic Math Toolbox) representing a nonnegative integer

## Options

### Seed

Option, specified as `Seed = s`

Initializes the random generator with the integer seed `s`. `s` can also be the option `currentTime`, to make the seed depend on the current time.

This option serves for generating generators that return predictable sequences of pseudo-random numbers. The generator is initialized with the seed `s` which may be an arbitrary integer. Several generators with the same initial seed produce the same sequence of numbers.

When this option is used, the parameters `N`, `X` and `n` must be numerical values at the time when the random generator is generated.

## Return Values

procedure on page 1-1654.

## See Also

### MuPAD Functions

`stats::hypergeometricCDF` | `stats::hypergeometricPF` |  
`stats::hypergeometricQuantile`

## stats::ksGOF

The Kolmogorov-Smirnov goodness-of-fit test

### Syntax

```
stats::ksGOF(x1, x2, ..., CDF = f)
```

```
stats::ksGOF([x1, x2, ...], CDF = f)
```

```
stats::ksGOF(s, <c>, CDF = f)
```

### Description

`stats::ksGOF([x1, x2, ...], CDF = f)` applies the Kolmogorov-Smirnov goodness-of-fit test for the null hypothesis: “x<sub>1</sub>, x<sub>2</sub>, ... is an f-distributed sample”.

External statistical data stored in an ASCII file can be imported into a MuPAD session via `import::readdata`. In particular, see Example 1 of the corresponding help page on page 13-11.

An error is raised if any of the data cannot be converted to a real floating-point number.

Let  $y_1, \dots, y_n$  be the input data  $x_1, \dots, x_n$  arranged in ascending order. `stats::ksGOF` returns the list

[PValue1 = p1, StatValue1 = K1, PValue2 = p2, StatValue2 = K2]

containing the following information:

1

K1 is the Kolmogorov-Smirnov statistic  $\sqrt{n} \max\left(\left\{\frac{j}{n} - f(y_j) \mid 1 \leq j \leq n\right\}\right)$ .

2

p1 is the observed significance level  $e^{-2K1^2} \left(1 - \frac{2K1}{3\sqrt{n}} + \frac{2K1^2}{3n} - \frac{4K1^4}{9n}\right)$  of the statistic K1.

3

$K_2$  is the Kolmogorov-Smirnov statistic  $\sqrt{n} \max\left(\left\{f(y_j) - \frac{j-1}{n} \mid 1 \leq j \leq n\right\}\right)$ .

4

$p_2$  is the observed significance level  $e^{-2K_2^2} \left(1 - \frac{2K_2}{3\sqrt{n}} + \frac{2K_2^2}{3n} - \frac{4K_2^4}{9n}\right)$  of the statistic  $K_2$ .

For the Kolmogorov-Smirnov statistic  $K$  corresponding to  $K_1$  or  $K_2$ , respectively, the observed significance levels  $p_1$ ,  $p_2$  are computed by an asymptotic approximation of the exact probability

$$\Pr(K > k) = \frac{k}{n^{\frac{n-1}{2}}} \left( \sum_{i=1}^{\lfloor \sqrt{n}k \rfloor} \binom{n}{i} \left( (i - \sqrt{n}k)^i (\sqrt{n}k + n - i)^{n-i-1} \right) \right)$$

For large  $n$ , these probabilities are approximated by

$$e^{-2k^2} \left( 1 - \frac{2k}{3\sqrt{n}} + \frac{2k^2}{3n} - \frac{4k^4}{9n} \right)$$

Thus, the observed significance levels returned by `stats::ksGOF` approximate the exact probabilities for large  $n$ . Roughly speaking, for  $n = 10$ , the 3 leading digits of  $p_1$ ,  $p_2$  correspond to the exact probabilities. For  $n = 100$ , the 4 leading digits of  $p_1$ ,  $p_2$  correspond to the exact probabilities. For  $n = 1000$ , the 6 leading digits of  $p_1$ ,  $p_2$  correspond to the exact probabilities.

The observed significance level `PValue1 = p1` returned by `stats::ksGOF` has to be interpreted in the following way:

Under the null hypothesis, the probability  $p_1 = \Pr(K > K_1)$  should not be small.

Specifically,  $p_1 = \Pr(K > K_1) \geq \alpha$  should hold for a given significance level  $0 < \alpha < 1$ . If this condition is violated, the hypothesis may be rejected at level  $\alpha$ .

Thus, if the observed significance level  $p_1 = \Pr(K > K_1)$  satisfies  $p_1 < \alpha$ , the sample leading to the value  $K_1$  of the statistic  $K$  represents an unlikely event and the null hypotheses may be rejected at level  $\alpha$ .

The corresponding interpretation holds for `PValue2 = p2`: if  $p_2 = \Pr(K > K_2)$  satisfies  $p_2 < \alpha$ , the null hypotheses may be rejected at level  $\alpha$ .

Note that *both* observed significance levels  $p_1$ ,  $p_2$  must be sufficiently large to make the data pass the test. The null hypothesis may be rejected at level  $\alpha$  if any of the two values is smaller than  $\alpha$ .

If  $p_1$  and  $p_2$  are both close to 1, this should raise suspicion about the randomness of the data: they indicate a fit that is *too good*.

Distributions that are not provided by the `stats`-package can be implemented easily by the user. A user defined procedure  $f$  can implement any cumulative distribution function; `stats::ksGOF` calls  $f(x)$  with real floating-point arguments from the data sample. The function  $f$  must return a numerical real value between 0 and 1. Cf. "Example 3" on page 30-296 (Symbolic Math Toolbox).

## Environment Interactions

The function is sensitive to the environment variable `DIGITS` which determines the numerical working precision.

## Examples

### Example 1

We create a sample of 1000 normally distributed random numbers:

```
r := stats::normalRandom(0, 1, Seed = 123):  
data := [r() $ i = 1 .. 1000]:
```

We test whether these data are indeed normally distributed with mean 0 and variance 1. We pass the corresponding cumulative distribution function `stats::normalCDF(0, 1)` to `stats::ksGOF`:

```
stats::ksGOF(data, CDF = stats::normalCDF(0, 1))
```

```
[PValue1 = 0.722852785, StatValue1 = 0.397634617, PValue2 = 0.2073651285,  
StatValue2 = 0.8816932145]
```

The result shows that the data can be accepted as a sample of normally distributed numbers: both observed significance levels `0.722...` and `0.207...` are not small.



Next, we inject some further data into the sample:

```
data := data . [frandom() $ i = 1..100]:
stats::ksGOF(data, CDF = stats::normalCDF(0, 1))
```

```
[PValue1 = 0.7520868926, StatValue1 = 0.3724682725, PValue2 = 0.00006540335794,
  StatValue2 = 2.188978212]
```

Now, the data should not be accepted as a sample of normal deviates with mean 0 and variance 1, because the second observed significance level `PValue2` is very small.

```
delete r, data:
```

## Example 2

We create a sample on page 30-413 consisting of one string column and two non-string columns:

```
s := stats::sample(
  [{"1996", 1242, PI - 1/2}, {"1997", 1353, PI + 0.3},
   {"1998", 1142, PI + 0.5}, {"1999", 1201, PI - 1},
   {"2001", 1201, PI}])
```

```
"1996" 1242 PI - 1/2
"1997" 1353 PI + 0.3
"1998" 1142 PI + 0.5
"1999" 1201 PI - 1
"2001" 1201 PI
```

We consider the data in the third column. The mean and the variance of these data are computed:

```
[m, v] := [stats::mean(s, 3), stats::variance(s, 3)]
```

```
[ $\pi - 0.14$ , 0.373]
```

We check whether the data of the 3rd column are normally distributed with the mean and variance computed above:

```
stats::ksGOF(s, 3, CDF = stats::normalCDF(m, v))
```

```
[PValue1 = 0.7366062033, StatValue1 = 0.3294603834, PValue2 = 0.6216810571,  
StatValue2 = 0.4263183582]
```

Both observed significance levels **0.736...** and **0.621...** returned by the test are not small. There is no reason to reject the null hypothesis that the data are normally distributed.

```
delete s, m, v:
```

### Example 3

We demonstrate how user-defined distribution functions can be used. The following function represents the cumulative distribution function  $Pr(X \leq x) = x^2$  of a variable  $X$  supported on the interval  $[0, 1]$ . It will be called with floating-point arguments  $x$  and must return numerical values between 0 and 1:

```
f := proc(x)  
begin  
  if x <= 0 then return(0)  
  elif x < 1 then return(x^2)  
  else return(1)  
  end_if  
end_proc:
```

We test the hypothesis that the following data are  $f$ -distributed:

```
data := [sqrt(frandon()) $ k = 1..10^2]:  
stats::ksG0FT(data, CDF = f)
```

```
[PValue1 = 0.366526126, StatValue1 = 0.692353403, PValue2 = 0.8844815733,  
StatValue2 = 0.2318684139]
```

At a given significance level of 0.1, say, the hypothesis should not be rejected: both observed significance levels  $p_1 = 0.366...$  and  $p_2 = 0.884...$  exceed 0.1.

```
delete f, data:
```

## Parameters

$x_1, x_2, \dots$

The statistical data: real numerical values

**f**

A procedure on page 1-1654 representing a cumulative distribution function. Typically, one of the distribution functions of the stats-package such as `stats::normalCDF(n, v)` etc.

**s**

A sample of domain type `stats::sample`

**c**

An integer representing a column index of the sample `s`. This column provides the data `x1, x2` etc. There is no need to specify a column number `c` if the sample has only one column.

## Return Values

List with four equations [`PValue1 = p1`, `StatValue1 = K1`, `PValue2 = p2`, `StatValue2 = K2`], with floating-point values `p1`, `K1`, `p2`, `K2`. See the “Details” section below for the interpretation of these values.

## References

D. E. Knuth, *The Art of Computer Programming, Vol 2: Seminumerical Algorithms*, pp. 48. Addison-Wesley (1998).

## See Also

### MuPAD Functions

`stats::csGOF` | `stats::sample` | `stats::swGOF` | `stats::tTest`

## stats::kurtosis

Kurtosis (excess) of a data sample

### Syntax

```
stats::kurtosis(x1, x2, ...)
```

```
stats::kurtosis([x1, x2, ...])
```

```
stats::kurtosis(s, <c>)
```

### Description

`stats::kurtosis(x1, x2, ..., xn)` returns the kurtosis (the coefficient of excess)

$$\frac{\frac{1}{n} \left( \sum_{i=1}^n (x_i - \bar{x})^4 \right)}{\left( \frac{1}{n} \left( \sum_{i=1}^n (x_i - \bar{x})^2 \right) \right)^2} - 3$$

where  $\bar{x}$  is the mean on page 30-346 of the data  $x_i$ .

The kurtosis measures whether a distribution is “flat” or “peaked”. For normally distributed data, the kurtosis is zero. If the distribution function of the data has a flatter top than the normal distribution, then the kurtosis is negative. The kurtosis is positive, if the distribution function has a high peak compared to the normal distribution.

The column index `c` is optional, if the data are given by a `stats::sample` object containing only one non-string column. Cf. “Example 3” on page 30-300 (Symbolic Math Toolbox).

External statistical data stored in an ASCII file can be imported into a MuPAD session via `import::readdata`. In particular, see Example 1 of the corresponding help page on page 13-11.

## Examples

### Example 1

We calculate the kurtosis of some values:

```
stats::kurtosis(0, 7, 7, 6, 6, 6, 5, 5, 4, 1)
```

$$-\frac{74146}{271441}$$

Alternatively, data may be passed as a list:

```
stats::kurtosis([2, 2, 4, 6, 8, 10, 10])
```

$$-\frac{85}{54}$$

### Example 2

We create a sample:

```
stats::sample([[a, 5, 8], [b, 3, 7], [c, d, 0]])
```

```
a 5 8
b 3 7
c d 0
```

The kurtosis of the second column is:

```
stats::kurtosis(%, 2)
```

$$\frac{3 \left(\frac{d}{3} - \frac{1}{3}\right)^4 + 3 \left(\frac{d}{3} - \frac{7}{3}\right)^4 + 3 \left(\frac{2d}{3} - \frac{8}{3}\right)^4}{\left(\left(\frac{d}{3} - \frac{1}{3}\right)^2 + \left(\frac{d}{3} - \frac{7}{3}\right)^2 + \left(\frac{2d}{3} - \frac{8}{3}\right)^2\right)^2} - 3$$

### Example 3

We create a sample consisting of one string column and one non-string column:

```
stats::sample(["1996", 1242], ["1997", 1353], ["1998", 1142])
```

```
"1996" 1242  
"1997" 1353  
"1998" 1142
```

We compute the kurtosis of the second column. In this case this column does not have to be specified, since it is the only non-string column:

```
stats::kurtosis(%)
```

$$-\frac{3}{2}$$

## Parameters

$x_1, x_2, \dots$

The statistical data: arithmetical expressions. (Symbolic Math Toolbox)

**s**

A sample of domain type `stats::sample`.

**c**

An integer representing a column index of the sample `s`. This column provides the data `x1, x2` etc.

## Return Values

Arithmetical expression. FAIL is returned, if the kurtosis does not exist.

## See Also

### MuPAD Functions

stats::obliquity

## stats::linReg

Linear regression (least squares fit)

### Syntax

```
stats::linReg([x1, x2, ...], [y1, y2, ...], <[w1, w2, ...]>, <CovarianceMatrix>)
```

```
stats::linReg([[x1, y1, <w1>], [x2, y2, <w2>], ...], <CovarianceMatrix>)
```

```
stats::linReg(s, <cx, cy, <cw>>, <CovarianceMatrix>)
```

```
stats::linReg(s, <[cx, cy, <cw>]>, <CovarianceMatrix>)
```

### Description

`stats::linReg([x1, x2, ...], [y1, y2, ...], [w1, w2, ...])` computes the least squares estimators  $a, b$  of a linear relation  $y_i = a + b x_i$  between the data pairs  $(x_i, y_i)$  by minimizing

$$\chi^2 = \sum_i w_i |y_i - a - b x_i|^2$$

A linear relation  $y_i = a + b x_i + e_i$  between the data pairs  $(x_i, y_i)$  is assumed.

The column indices `cx, cy` are optional if the data are given by a `stats::sample` object containing only two non-string columns. Cf. “Example 2” on page 30-304 (Symbolic Math Toolbox).

Multivariate linear regression and non-linear regression is provided by `stats::reg`.

External statistical data stored in an ASCII file can be imported into a MuPAD session via `import::readdata`. In particular, see Example 1 of the corresponding help page on page 13-11.



## Examples

### Example 1

We calculate the least square estimators of four pairs of values given in two lists. Note that there is a linear relation  $y = 1 + 2x$  between the entries of the lists. The minimized quadratic deviation is 0 indicating a perfect fit:

```
stats::linReg([0, 1, 2, 3], [1, 3, 5, 7])
```

```
[[1, 2], 0]
```

Alternatively, data may be specified by a list of pairs:

```
stats::linReg([[1, 1.0], [2, 1.2], [3, 1.3], [4, 1.5]])
```

```
[[0.85, 0.16], 0.002]
```

We assume that the variable  $y$  in the previous example is Poissonian, i.e. that the measurements  $(y_i) = (1.0, 1.2, 1.3, 1.5)$  have errors given by the standard deviation

$\sigma(y_i) = \sqrt{y_i}$ . We provide corresponding weights  $w_i = \frac{1}{\sigma(y_i)} = \frac{1}{\sqrt{y_i}}$  and estimate confidence intervals for the least squares estimators by using the option `CovarianceMatrix`:

```
stats::linReg([[1, 1.0, 1/1.0], [2, 1.2, 1/1.2],
               [3, 1.3, 1/1.3], [4, 1.5, 1/1.5]], CovarianceMatrix)
```

```
[ [0.8491476359, 0.1601801222], 0.001608234159, ( 1.650048247  -0.5751045352 )
  [ -0.5751045352  0.2460598263 ] ]
```

The square roots of the diagonal elements of the covariance matrix provide standard deviations for the estimated parameters:

```
sqrt(%[3][1,1]), sqrt(%[3][2,2])
```

```
1.284542038, 0.4960441778
```

Thus, we obtain the estimates  $a \pm \sigma(a) = 0.849 \pm 1.28$ ,  $b \pm \sigma(b) = 0.16 \pm 0.496$ .

## Example 2

We create a sample consisting of one string column and two non-string columns:

```
stats::sample(["1", 0, 0], ["2", 10, 15], ["3", 20, 30])
```

```
"1"  0  0  
"2" 10 15  
"3" 20 30
```

The least square estimators are calculated using the data columns 2 and 3. In this example there are only two non-string columns, so the column indices do not have to be specified:

```
stats::linReg(%)
```

```
[[0, 3/2], 0]
```

## Example 3

We create a sample consisting of three data columns:

```
stats::sample([1, 0, 0], [2, 10, 15], [3, 20, 30])
```

```
1  0  0  
2 10 15  
3 20 30
```

We compute the least square estimators for the data pairs given by the first and the second column:

```
stats::linReg(%, 1, 2)
```

```
[[ -10, 10], 0]
```

## Example 4

We create a sample of three columns containing symbolic data:

```
stats::sample([[x, y, 0], [2, 4, 15], [3, 20, 30]])
```

```
x  y  0
2  4 15
3 20 30
```

We compute the symbolic least square estimators for the data pairs given by the first and the second column. Here we specify these columns by a list of column indices:

```
map(stats::linReg(%, [1, 2], CovarianceMatrix), normal)
```

$$\left[ \left[ -\frac{68x - 13y + 5xy - 24x^2 + 28}{\sigma_2}, -\frac{24x + 5y - 2xy - 84}{\sigma_2} \right], \frac{256x^2 - 32xy - 896x + y^2 + 56y + 784}{\sigma_2}, \left( \begin{array}{cc} \frac{x^2 + 13}{\sigma_2} & \sigma_1 \\ \sigma_1 & \frac{3}{\sigma_2} \end{array} \right) \right]$$

where

$$\sigma_1 = -\frac{x+5}{\sigma_2}$$

$$\sigma_2 = 2(x^2 - 5x + 7)$$

## Example 5

We create data  $(x_i, y_i)$  with a randomized relation  $y_i = a + b x_i$ :

```
DIGITS := 5:
r := stats::normalRandom(0, 5):
```

```
X := [i $ i = 0..100]:
Y := [12 + 17*x + r() $ x in X]:
```

By construction, the variances  $\sigma(y_i)^2$  for the data  $y_i$  in the list  $Y$  is 5. We use the weights

$w_i = \frac{1}{\sigma(y_i)^2} = \frac{1}{5}$  for all data:

```
W := [1/5 $ i = 0..100]:
[ab, chisquared, C]:= stats::linReg(X, Y, W, CovarianceMatrix)
```

$$\left[ [12.065, 16.998], 87.997, \begin{pmatrix} \frac{335}{1717} & -\frac{5}{1717} \\ -\frac{5}{1717} & \frac{1}{17170} \end{pmatrix} \right]$$

The standard deviations of the estimators  $a, b$  are the square roots of the diagonal elements of  $C$ :

```
sqrt(float(C[1,1])), sqrt(float(C[2,2]))
```

```
0.44171, 0.0076316
```

Thus, the estimate for  $a$  is  $a \pm \sigma(a) \approx 11.93 \pm 0.44$ , the estimate for  $b$  is  $b \pm \sigma(b) \approx 17.003 \pm 0.0076$ .

```
delete r, X, Y, W, ab, chisquared, C:
```

## Parameters

$x_1, x_2, \dots$

Statistical data: arithmetical expressions

$y_1, y_2, \dots$

Statistical data: arithmetical expressions

$w_1, w_2, \dots$

Weights: arithmetical expressions. If no weights are provided,  $w_1 = w_2 = \dots = 1$  is used.

**s**

A sample of domain type `stats::sample`.

**cx, cy, cw**

Integers representing column indices of the sample `s`. Column `cx` provides the data  $x_1, x_2, \dots$ , column `cy` provides the data  $y_1, y_2, \dots$ . Column `cw`, if present, provides the weights  $w_1, w_2, \dots$ . If no index for the weights is provided,  $w_1 = w_2 = \dots = 1$  is used.

## Options

**CovarianceMatrix**

Changes the return value from `[[a, b], chisquared]` to `[[a, b], chisquared, C]`, where `C` is the covariance matrix

$$\begin{pmatrix} \sigma(a)^2 & \text{cov}(a, b) \\ \text{cov}(a, b) & \sigma(b)^2 \end{pmatrix}$$

Of the estimators  $a, b$ .

With this option, information on confidence intervals for the least squares estimators are provided. In particular, the return value includes the covariance matrix

$$\begin{pmatrix} \sigma(a)^2 & \text{cov}(a, b) \\ \text{cov}(a, b) & \sigma(b)^2 \end{pmatrix}$$

Of type `Dom::Matrix()`. Assuming that the data  $(y_i)$  are randomly perturbed with stochastic variations  $\sigma(y_i)^2$ , the quadratic error to be minimized is

$$\chi^2 = \sum_I w_i |y_i - a - b x_i|^2$$

With

$$w_i = \frac{1}{\sigma(y_i)^2}$$

The covariance matrix of the least squares estimators is given by

$$\sigma(a)^2 = \frac{\sum_i w_i x_i^2}{(\sum_i w_i) \left( \sum_i w_i x_i^2 \right) - (\sum_i w_i x_i)^2},$$

$$\sigma(b)^2 = \frac{\sum_i w_i}{(\sum_i w_i) \left( \sum_i w_i x_i^2 \right) - (\sum_i w_i x_i)^2},$$

$$\text{cov}(a, b) = \frac{\sum_i w_i x_i}{(\sum_i w_i) \left( \sum_i w_i x_i^2 \right) - (\sum_i w_i x_i)^2}.$$

## Return Values

Without the option `CovarianceMatrix`, a list `[[a, b], chisquared]` is returned. The arithmetical expressions  $a$  and  $b$  are estimators of the the offset and the slope of the linear relation. The arithmetical expression `chisquared` is the quadratic deviation

$$\chi^2 = \sum_i w_i |y_i - a - b x_i|^2,$$

where  $a, b$  are the optimized estimators.

With the option `CovarianceMatrix`, a list `[[a, b], chisquared, C]` is returned. The matrix on page 1-1340 C is the covariance matrix of the optimized estimators  $a$  and  $b$ .

FAIL is returned if the estimators  $a$  and  $b$  do not exist.

## References

P.R. Bevington and D.K. Robinson, "Data Reduction and Error Analysis for The Physical Sciences", McGraw-Hill, New York, 1992.

## See Also

### MuPAD Functions

`stats::reg` | `stats::sample`

### MuPAD Graphical Primitives

`plot::Scatterplot`

## stats::logisticCDF

Cumulative distribution function of the logistic distribution

### Syntax

```
stats::logisticCDF(m, s)
```

### Description

`stats::logisticCDF(m, s)` returns a procedure representing the cumulative distribution function

$$x \rightarrow \frac{1}{2} \left( 1 + \tanh \left( \frac{\pi (x - m)}{2 \sqrt{3} s} \right) \right)$$

of the logistic distribution with mean  $m$  and standard deviation  $s > 0$  as a procedure.

The procedure `f := stats::logisticCDF(m, s)` can be called in the form `f(x)` with an arithmetical expression  $x$ . The return value of `f(x)` is either a floating-point number or a symbolic expression:

If  $x$  is a floating-point number and  $m$  and  $s$  can be converted to floating-point numbers, then `f(x)` returns a floating-point number between 0.0 and 1.0.

The call `f(-infinity)` returns 0; the call `f(infinity)` returns 1.

In all other cases, the expression `1/2*(1 + tanh(PI*(x - m)/(2*sqrt(3)*s))` is returned symbolically.

Numerical values for  $m$  and  $s$  are only accepted if they are real and  $s$  is positive.



## Environment Interactions

The function is sensitive to the environment variable DIGITS which determines the numerical working precision.

## Examples

### Example 1

We evaluate the cumulative distribution function with  $m = 0$  and  $s = 1$  at various points:

```
f := stats::logisticCDF(0, 1):
f(-infinity), f(-3), f(0.5), f(2/3), f(PI), f(infinity)
```

$$0, \frac{1}{2} - \frac{\tanh\left(\frac{\pi\sqrt{3}}{2}\right)}{2}, 0.7123653231, \frac{\tanh\left(\frac{\pi\sqrt{3}}{9}\right)}{2} + \frac{1}{2}, \frac{\tanh\left(\frac{\sqrt{3}\pi^2}{6}\right)}{2} + \frac{1}{2}, 1$$

```
delete f:
```

### Example 2

We use symbolic arguments:

```
f := stats::logisticCDF(m, s): f(x)
```

$$\frac{1}{2} - \frac{\tanh\left(\frac{\pi\sqrt{3}(m-x)}{6s}\right)}{2}$$

When numerical values are assigned to  $m$  and  $s$ , the function  $f$  starts to produce numerical values:

```
m := 0: s := 1: f(3), f(3.0)
```

$$\frac{\tanh\left(\frac{\pi\sqrt{3}}{2}\right)}{2} + \frac{1}{2}, 0.995685277$$

delete f, m, s:

## Parameters

**m**

The mean: an arithmetical expression (Symbolic Math Toolbox) representing a real value

**s**

The standard deviation: an arithmetical expression (Symbolic Math Toolbox) representing a positive real value

## Return Values

procedure on page 1-1654.

## See Also

### **MuPAD Functions**

stats::logisticPDF | stats::logisticQuantile | stats::logisticRandom

## stats::logisticPDF

Probability density function of the logistic distribution

### Syntax

```
stats::logisticPDF(m, s)
```

### Description

`stats::logisticPDF(m, s)` returns the probability density function

$$x \rightarrow \frac{\pi}{4 s \sqrt{3}} \operatorname{sech}\left(\frac{\pi (x - m)}{4 \sqrt{3} s}\right)^2$$

of the logistic distribution with mean  $m$  and standard deviation  $s > 0$ .

The procedure `f := stats::logisticPDF(m, s)` can be called in the form `f(x)` with an arithmetical expression  $x$ . The return value of `f(x)` is either a floating-point number or a symbolic expression:

If  $x$  is a floating-point number and  $m$  and  $s$  can be converted to floating-point numbers, then `f(x)` returns a positive floating-point number.

`f(infinity)` and `f(-infinity)` return 0.

In all other cases, the expression  $\frac{\pi}{4 s \sqrt{3}} \operatorname{sech}\left(\frac{\pi (x - m)}{4 \sqrt{3} s}\right)^2$  is returned symbolically.

Numerical values for  $m$  and  $s$  are only accepted if they are real and  $s$  is positive.

### Environment Interactions

The function is sensitive to the environment variable `DIGITS` which determines the numerical working precision.

## Examples

### Example 1

We evaluate the probability density function with  $m = 0$  and  $s = 1$  at various points:

```
f := stats::logisticPDF(0, 1): f(1/2), f(0.5), f(x)
```

$$\frac{\pi \sqrt{3}}{12 \cosh\left(\frac{\pi \sqrt{3}}{12}\right)^2}, 0.3716492483, \frac{\pi \sqrt{3}}{12 \cosh\left(\frac{\pi \sqrt{3} x}{6}\right)^2}$$

```
delete f:
```

### Example 2

We use symbolic arguments:

```
f := stats::logisticPDF(m, s): f(x), f(3)
```

$$\frac{\pi \sqrt{3}}{12 s \cosh\left(\frac{\pi \sqrt{3} (m-x)}{6 s}\right)^2}, \frac{\pi \sqrt{3}}{12 s \cosh\left(\frac{\pi \sqrt{3} (m-3)}{6 s}\right)^2}$$

When numerical values are assigned to  $m$  and  $s$ , the function  $f$  starts to produce numerical values:

```
m := 0: s := 1: f(3), f(3.0)
```

$$\frac{\pi \sqrt{3}}{12 \cosh\left(\frac{\pi \sqrt{3}}{2}\right)^2}, 0.007792274633$$

```
delete f, m, s:
```

## Parameters

**m**

The mean: an arithmetical expression (Symbolic Math Toolbox) representing a real value

**s**

The standard deviation: an arithmetical expression (Symbolic Math Toolbox) representing a positive real value

## Return Values

procedure on page 1-1654.

## See Also

### **MuPAD Functions**

stats::logisticCDF | stats::logisticQuantile | stats::logisticRandom

## stats::logisticQuantile

Quantile function of the logistic distribution

### Syntax

```
stats::logisticQuantile(m, s)
```

### Description

stats::logisticQuantile(m, s) returns a procedure representing the quantile function (inverse)

$$x \rightarrow m + \frac{\sqrt{3} s}{\pi} \ln\left(\frac{x}{1-x}\right)$$

of the cumulative distribution function stats::logisticCDF(m, s). For  $0 \leq x \leq 1$ , the solution of stats::logisticCDF(m, s)(y) = x is given by

$$y = \text{stats::logisticQuantile}(m, s)(x)$$

The procedure `f := stats::logisticQuantile(m, s)` can be called in the form `f(x)` with an arithmetical expression `x`. The return value of `f(x)` is either a floating-point number, `±infinity`, or a symbolic expression:

The call `f(x)` returns a real floating-point number if `x` is a floating-point number between `0.0` and `1.0`, `m` can be converted to a real floating-point number, and `s` can be converted to a positive real floating-point number.

The calls `f(0)` and `f(0.0)` produce `-infinity`; the calls `f(1)` and `f(1.0)` produce `infinity`.

In all other cases, the symbolic expression `m + sqrt(3)*s*ln(x/(1-x))/PI` is returned.

Numerical values of `x` are only accepted if  $0 \leq x \leq 1$ .

Numerical values of  $m$  and  $s$  are only accepted if they are real and  $s$  is positive.

## Environment Interactions

The function is sensitive to the environment variable DIGITS which determines the numerical working precision.

## Examples

### Example 1

We evaluate the quantile function with mean  $m = 0$  and standard deviation  $s = 1$  at various points:

```
f := stats::logisticQuantile(0, 1):
f(0), f(1/10), f(0.7), f(0.999999999), f(1)
```

$$-\infty, -\frac{\sqrt{3} \ln(9)}{\pi}, 0.4671397935, 11.42533526, \infty$$

The value  $f(x)$  satisfies  $\text{stats::logisticCDF}(0, 1)(f(x)) = x$ :

```
stats::logisticCDF(0, 1)(f(0.987654321))
```

$$0.987654321$$

```
delete f:
```

### Example 2

We use symbolic arguments:

```
f := stats::logisticQuantile(m, s): f(x), f(1/3), f(0.4)
```

$$m + \frac{\sqrt{3} s \ln\left(-\frac{x}{x-1}\right)}{\pi}, m - \frac{\sqrt{3} s \ln(2)}{\pi}, m - 0.2235446302 s$$

When suitable numerical values are assigned to  $a$  and  $b$ , the function  $f$  starts to produce numerical values:

```
m := 0: s := 1: f(0.999), f(999/1000)
```

$$3.807893483, \frac{\sqrt{3} \ln(999)}{\pi}$$

Numerical values for  $x$  are only accepted if  $0 \leq x \leq 1$ :

```
f(0.5)
```

```
0.0
```

```
f(2)
```

```
Error: Argument x must be between 0 and 1. [f]
```

```
delete f, m, s:
```

## Parameters

**m**

The mean: an arithmetical expression (Symbolic Math Toolbox) representing a real value

**s**

The standard deviation: an arithmetical expression (Symbolic Math Toolbox) representing a positive real value

## Return Values

procedure on page 1-1654.



## See Also

### MuPAD Functions

stats::logisticCDF | stats::logisticPDF | stats::logisticRandom

## stats::logisticRandom

Generate a random number generator for logistic deviates

### Syntax

```
stats::logisticRandom(m, s, <Seed = s>)
```

### Description

`stats::logisticRandom(m, s)` returns a procedure that produces logistic on page 30-310 deviates (random numbers) with mean  $m$  and standard deviation  $b > 0$ .

The procedure `f := stats::logisticRandom(m, s)` can be called in the form `f()`. The return value of `f()` is either a floating-point number or a symbolic expression:

If  $m$  can be converted to a floating-point number and  $s$  can be converted to a positive floating point number, then `f(x)` returns a real floating point number.

Otherwise, `stats::logisticRandom(m, s)()` is returned symbolically.

Numerical values of  $m$  and  $s$  are only accepted if they are real and  $s$  is positive.

The values  $X = f()$  are distributed randomly according to the logistic distribution with mean  $m$  and standard deviation  $s$ . For any real  $x$ , the probability that  $X \leq x$  is given by

$$\frac{1 + \tanh\left(\frac{\pi(x-m)}{2\sqrt{3}s}\right)}{2}$$

Without the option `Seed = s`, an initial seed is chosen internally. This initial seed is set to a default value when MuPAD is started. Thus, each time MuPAD is started or re-initialized with the `reset` function, random generators produce the same sequences of numbers.

---

**Note** In contrast to the function `random`, the generators produced by `stats::logisticRandom` do not react to the environment variable `SEED`.

---

For efficiency, it is recommended to produce sequences of  $K$  random numbers via

```
f := stats::logisticRandom(m, s): f() $k = 1..K;
```

rather than by

```
stats::logisticRandom(m, s)() $k = 1..K;
```

The latter call produces a sequence of generators each of which is called once. Also note that

```
stats::logisticRandom(m, s, Seed = n)() $k = 1..K;
```

does not produce a random sequence, because a sequence of freshly initialized generators would be created each of them producing the same number.

## Environment Interactions

The function is sensitive to the environment variable DIGITS which determines the numerical working precision.

## Examples

### Example 1

We generate logistic deviates with mean  $m = 0$  and standard deviation  $s = 1$ :

```
f := stats::logisticRandom(0, 1): f() $ k = 1..4
```

```
      -0.5473627217, 0.8782646344, -0.9428030153, 2.897981396
```

```
delete f:
```

### Example 2

With symbolic parameters, no random floating-point numbers can be produced:

```
f := stats::logisticRandom(m, s): f()
```

```
stats::logisticRandom(m, s)()
```

When numbers are assigned to  $m$  and  $s$ , the function  $f$  starts to produce random floating point numbers:

```
m := PI: s := 1/8: f() $ k = 1..4
```

```
3.071738219, 3.037168533, 3.128342993, 3.193154296
```

```
delete f, m, s:
```

### Example 3

We use the option `Seed = s` to reproduce a sequence of random numbers:

```
f := stats::logisticRandom(PI, 3, Seed = 1): f() $ k = 1..4
```

```
3.590026186, 5.349173335, -0.228813398, 0.5644575096
```

```
g := stats::logisticRandom(PI, 3, Seed = 1): g() $ k = 1..4
```

```
3.590026186, 5.349173335, -0.228813398, 0.5644575096
```

```
f() = g(), f() = g()
```

```
5.811492258 = 5.811492258, -6.396713726 = -6.396713726
```

```
delete f, g:
```

## Parameters

**m**

The mean: an arithmetical expression (Symbolic Math Toolbox) representing a real value

**s**

The standard deviation: an arithmetical expression (Symbolic Math Toolbox) representing a positive real value

## Options

### Seed

Option, specified as `Seed = s`

Initializes the random generator with the integer seed `s`. `s` can also be the option `CurrentTime`, to make the seed depend on the current time.

This option serves for generating generators that return predictable sequences of pseudo-random numbers. The generator is initialized with the seed `s` which may be an arbitrary integer. Several generators with the same initial seed produce the same sequence of numbers.

When this option is used, the parameters `m` and `s` must be convertible to floating-point numbers at the time when the random generator is generated.

## Return Values

procedure on page 1-1654.

## Algorithms

The implemented algorithm for the computation of the logistic deviates uses the quantile function of the logistic distribution applied to uniformly distributed random numbers on the interval `[0, 1)`.

## See Also

### MuPAD Functions

`stats::logisticCDF` | `stats::logisticPDF` | `stats::logisticQuantile`

# stats::lognormalCDF

Cumulative distribution function of the log-normal distribution

## Syntax

`stats::lognormalCDF(m, v)`

## Description

`stats::lognormalCDF(m, v)` returns a procedure representing the cumulative distribution function

$$x \rightarrow \frac{1}{\sqrt{2\pi v}} \int_{-\infty}^x e^{-\frac{\ln(t-m)^2}{2v}} dt$$

of the log-normal distribution with location parameter  $m$  and shape parameter  $v$ .

A random variable  $X$  is log-normally distributed if  $\ln(X)$  is a normally distributed variable. The “location parameter”  $m$  of  $X$  is the mean of  $\ln(X)$  and the “shape parameter”  $v$  is the variance of  $\ln(X)$ .

The procedure `f := stats::lognormalCDF(m, v)` can be called in the form `f(x)`

with an arithmetical expression  $x$ . The value  $\frac{1}{2} + \frac{\operatorname{erf}\left(\frac{\ln(x)-m}{\sqrt{2v^3}}\right)}{2}$  is returned.

If  $x$  is a floating-point number and both  $m$  and  $v$  can be converted to floating-point numbers, this value is returned as a floating-point number. Otherwise, a symbolic expression is returned.

Numerical values for  $m$  and  $v$  are only accepted if they are real and  $v$  is positive.

## Environment Interactions

The function is sensitive to the environment variable DIGITS which determines the numerical working precision.

### Examples

#### Example 1

We evaluate the CDF of a lognormal distribution for some arbitrary parameter values:

```
f := stats::lognormalCDF(1/2, 3/4):
f(0.1), f(10.3)
```

```
0.0006057758986, 0.9828096232
```

```
delete f:
```

#### Example 2

We use symbolic arguments:

```
f := stats::lognormalCDF(m, v):
f(3), f(x)
```

$$\frac{1}{2} - \frac{\operatorname{erf}\left(\frac{\sqrt{2}(m - \ln(3))}{2\sqrt{v}}\right)}{2}, \frac{1}{2} - \frac{\operatorname{erf}\left(\frac{\sqrt{2}(m - \ln(x))}{2\sqrt{v}}\right)}{2}$$

When numerical values are assigned to  $m$  and  $v$ , the function  $f$  starts to produce numerical values:

```
m := 4: v := PI:
f(3), f(3.0)
```

$$\frac{\operatorname{erf}\left(\frac{\sqrt{2}(\ln(3) - 4)}{2\sqrt{\pi}}\right)}{2} + \frac{1}{2}, 0.05082226366$$



```
delete f, m, v:
```

### Example 3

From the definition of “lognormal” above it is clear that the probability of  $X < 0$  is zero for  $X$  lognormally distributed:

```
plotfunc2d(stats::lognormalCDF(0,1))
```

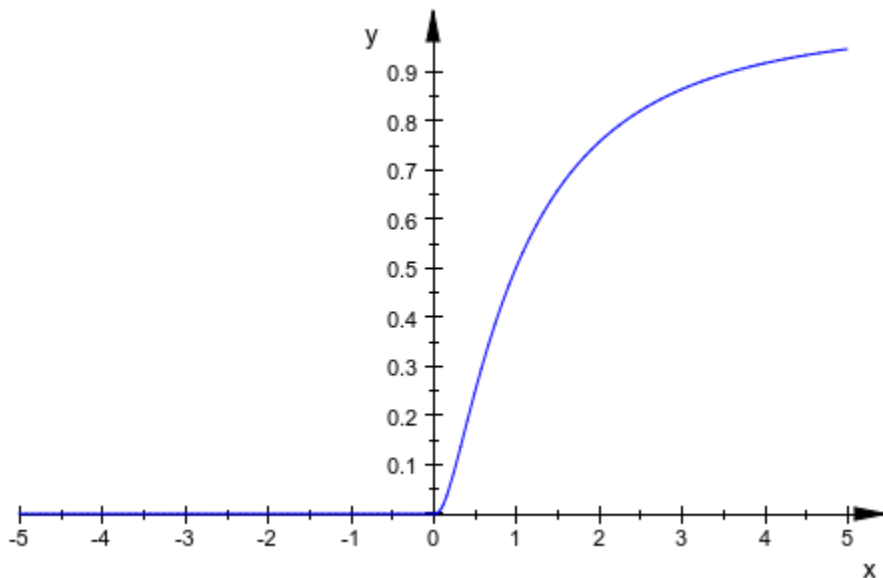

The following plot shows the influence of the shape parameter on the shape of the lognormal distribution:

```
f03 := stats::lognormalCDF(0, 0.3):
f1 := stats::lognormalCDF(0, 1):
f3 := stats::lognormalCDF(0, 3):
f9 := stats::lognormalCDF(0, 9):
plotfunc2d(f03, f1, f3, f9, x = 0..10)
```

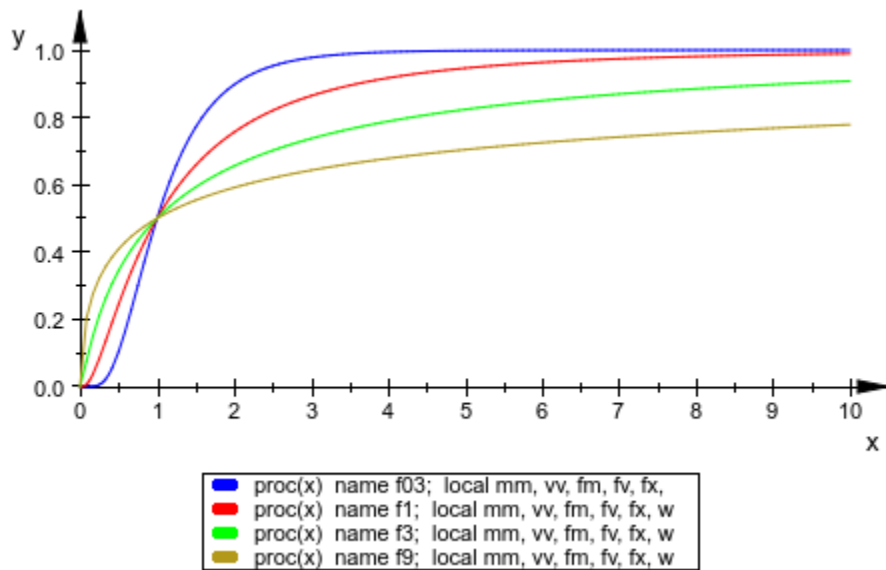

As for the normal distribution, a larger value of the shape parameter stretches the lognormal distribution, also changing its shape in the process:

```
plotfunc2d(stats::lognormalCDF(m, 1)$ m = 0..2 step .1,  
           LegendVisible = FALSE)
```

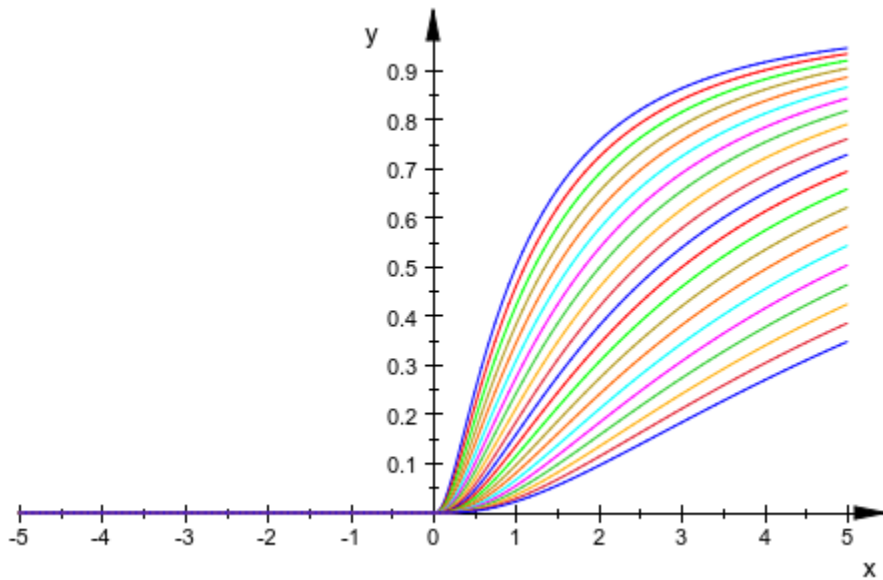

## Parameters

**m**

The location parameter: an arithmetical expression (Symbolic Math Toolbox) representing a real value

**v**

The shape parameter: an arithmetical expression (Symbolic Math Toolbox) representing a positive real value

## Return Values

procedure on page 1-1654.

## See Also

### MuPAD Functions

erf | stats::lognormalPDF | stats::lognormalQuantile |  
stats::lognormalRandom | stats::normalCDF

# stats::lognormalPDF

Probability density function of the log-normal distribution

## Syntax

`stats::lognormalPDF(m, v)`

## Description

`stats::lognormalPDF(m, v)` returns a procedure representing the probability density function

$$x \rightarrow e^{-\frac{(\ln(x)-m)^2}{2v}} / \sqrt{2\pi vx}$$

of the lognormal distribution with location parameter  $m$  and shape parameter  $v$ .

A random variable  $X$  is log-normally distributed if  $\ln(X)$  is a normally distributed variable. The “location parameter”  $m$  of  $X$  is the mean of  $\ln(X)$  and the “shape parameter”  $v$  is the variance of  $\ln(X)$ .

The procedure `f := stats::lognormalPDF(m, v)` can be called in the form `f(x)`

with an arithmetical expression  $x$ . The value  $e^{-\frac{(\ln(x)-m)^2}{2v}} / \sqrt{2\pi vx}$  is returned.

If  $x$  is a floating-point number and both  $m$  and  $v$  can be converted to floating-point numbers, this value is returned as a floating-point number. Otherwise, a symbolic expression is returned.

Numerical values for  $m$  and  $v$  are only accepted if they are real and  $v$  is positive.

## Environment Interactions

The function is sensitive to the environment variable DIGITS which determines the numerical working precision.

## Examples

### Example 1

We compute the probability density with location parameter  $m = 2$  and shape parameter  $v = 4$  at various points:

```
f := stats::lognormalPDF(2, 4):
f(-infinity), f(-3), f(2.0), f(PI), f(infinity)
```

$$0, 0, 0.08056298881, \frac{\sqrt{2} e^{-\frac{(\ln(\pi)-2)^2}{8}}}{4 \pi^{3/2}}, 0$$

```
delete f:
```

### Example 2

We use symbolic arguments:

```
f := stats::lognormalPDF(m, v):
f(x), f(0.4)
```

$$\frac{\sqrt{2} e^{-\frac{(m-\ln(x))^2}{2v}}}{2 \sqrt{v} x \sqrt{\pi}}, \frac{1.25 \sqrt{2} e^{-\frac{(m+0.9162907319)^2}{2v}}}{\sqrt{v} \sqrt{\pi}}$$

When numerical values are assigned to  $m$  and  $v$ , the function  $f$  starts to produce numerical values:

```
m := PI: v := 2:
f(3), f(3.0)
```

$$\frac{e^{-\frac{(\pi - \ln(3))^2}{4}}}{6\sqrt{\pi}}, 0.03312170057$$

```
delete f, m, v:
```

### Example 3

The following plot shows the influence of the shape parameter on the log-normal distribution:

```
plotfunc2d(stats::lognormalPDF(1, 0.25)(x),
  stats::lognormalPDF(1, 0.5)(x),
  stats::lognormalPDF(1, 1)(x),
  stats::lognormalPDF(1, 2)(x),
  stats::lognormalPDF(1, 4)(x),
  stats::lognormalPDF(1, 8)(x),
  x = -0.5 .. 4, ViewingBoxYRange = 0 .. 1.1,
  LegendVisible = FALSE)
```

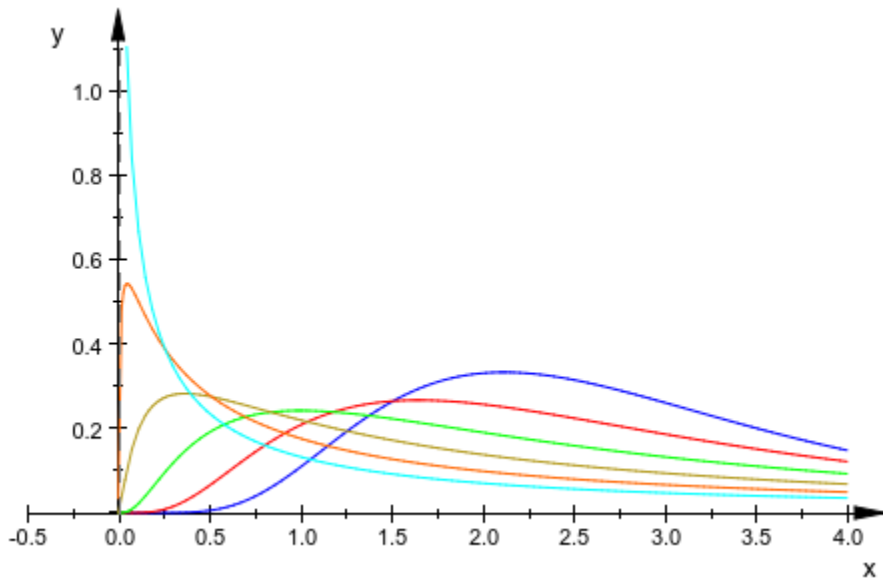

Due to its logarithmic influence, the location parameter changes the shape of the distribution, too:

```
plotfunc2d(stats::lognormalPDF(m, 0.5)(x) $ m = 0.5..2 step 0.5,  
           x = -0.5 ..4, ViewingBoxYRange = 0 .. 0.5,  
           LegendVisible = FALSE)
```



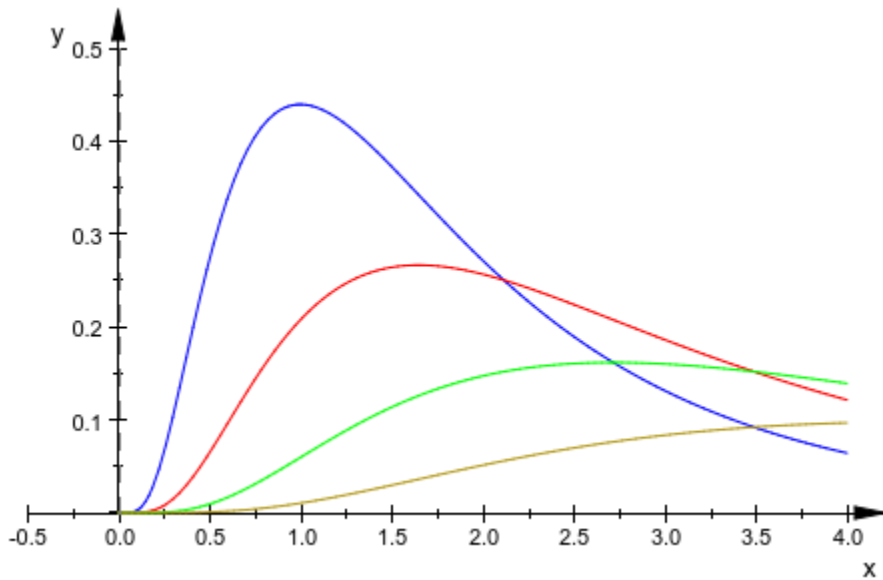

## Parameters

**m**

The location parameter: an arithmetical expression (Symbolic Math Toolbox) representing a real value

**v**

The shape parameter: an arithmetical expression (Symbolic Math Toolbox) representing a positive real value

## Return Values

procedure on page 1-1654.

## See Also

### MuPAD Functions

exp | stats::lognormalCDF | stats::lognormalQuantile |  
stats::lognormalRandom | stats::normalPDF

# stats::lognormalQuantile

Quantile function of the log-normal distribution

## Syntax

```
stats::lognormalQuantile(m, v)
```

## Description

`stats::lognormalQuantile(m, v)` returns a procedure representing the quantile function (inverse) of the cumulative distribution function `stats::lognormalCDF(m, v)` of the log-normal distribution with location parameter  $m$  and shape parameter  $v > 0$ : For  $0 \leq x \leq 1$ , the solution of `stats::lognormalCDF(m, v)(y) = x` is given by  $y = \text{stats::lognormalQuantile}(m, v)(x)$ .

The procedure `f := stats::lognormalQuantile(m, v)` can be called in the form `f(x)` with an arithmetical expression  $x$ . The return value of `f(x)` is either a floating-point number, 0, infinity, or a symbolic expression:

If  $x$  is a real number between 0 and 1 and both  $m$  and  $v$  can be converted to floating-point numbers, then `f(x)` returns a real floating-point number approximating the solution  $y$  of `stats::lognormalCDF(m, v)(y) = x`.

The call `f(0)` returns 0.

The calls `f(1)` and `f(1.0)` produce infinity for all values of  $m$  and  $v$ .

In all other cases, `f(x)` returns the symbolic call `stats::lognormalQuantile(m, v)(x)`.

Numerical values for  $m$  and  $v$  are only accepted if they are real and  $v$  is positive.

## Environment Interactions

The function is sensitive to the environment variable DIGITS which determines the numerical working precision.

## Examples

### Example 1

We evaluate the quantile function with location parameter  $m = \pi$  and shape parameter  $v = 11$  at various points:

```
f := stats::lognormalQuantile(PI, 11):  
f(0), f(1/10), f(0.5), f(1 - 10^(-10)), f(1)  
  
0, 0.3299437681, 23.14069263, 33666650688.0, ∞
```

The value  $f(x)$  satisfies  $\text{stats::lognormalCDF}(PI, 11)(f(x)) = x$ :

```
stats::lognormalCDF(PI, 11)(f(0.987654))  
  
0.987654
```

```
delete f:
```

### Example 2

We use symbolic arguments:

```
f := stats::lognormalQuantile(m, v):  
f(x), f(9/10)  
  
stats::lognormalQuantile(m, v)(x), stats::lognormalQuantile(m, v)( $\frac{9}{10}$ )
```

When numerical values are assigned to  $m$  and  $v$ , the function  $f$  starts to produce floating-point values:

```
m := 17: v := 6:  
f(9/10), f(0.999)
```

```
557597210.5, 46816069055.0
```

Numerical values for  $x$  are only accepted if  $0 \leq x \leq 1$ :

```
f(0.5)
```

```
24154952.75
```

```
f(2)
```

```
Error: Argument x must be between 0 and 1. [f]
```

```
delete f, m, v:
```

## Parameters

**m**

The location parameter: an arithmetical expression (Symbolic Math Toolbox) representing a real value

**v**

The shape parameter: an arithmetical expression (Symbolic Math Toolbox) representing a positive real value

## Return Values

procedure on page 1-1654.

## See Also

### MuPAD Functions

`stats::lognormalCDF` | `stats::lognormalPDF` | `stats::lognormalRandom`

# stats::lognormalRandom

Generate a random number generator for log-normal deviates

## Syntax

stats::lognormalRandom(*m*, *v*, <Seed = *s*>)

## Description

stats::normalRandom(*m*, *v*) returns a procedure that produces lognormal on page 30-325 deviates (random numbers) with location parameter *m* and shape parameter *v* > 0.

A random variable *X* is log-normally distributed if  $\ln(X)$  is a normally distributed variable. The “location parameter” *m* of *X* is the mean of  $\ln(X)$  and the “shape parameter” *v* is the variance of  $\ln(X)$ .

The procedure `f := stats::lognormalRandom(m, v)` can be called in the form `f()`. The return value of `f()` is either a floating-point number or a symbolic expression:

If *m* and *v* can be converted to floating-point numbers, `f()` returns a real floating point number. Otherwise, the symbolic call `stats::lognormalRandom(m, v)()` is returned.

Numerical values of *m* and *v* are only accepted if they are real and *v* is positive.

The values  $X = f()$  are distributed randomly according to the cumulative distribution function of the log-normal distribution with parameters *m* and *v*. For any real *x*, the probability that  $X \leq x$  is given by

$$\frac{1}{2} + \frac{\operatorname{erf}\left(\frac{\ln(x)-m}{\sqrt{2v^3}}\right)}{2}$$

Without the option `Seed = s`, an initial seed is chosen internally. This initial seed is set to a default value when MuPAD is started. Thus, each time MuPAD is started or re-initialized with the `reset` function, random generators produce the same sequences of numbers.

---

**Note** In contrast to the function `random`, the generators produced by `stats::normalRandom` do not react to the environment variable `SEED`.

---

For efficiency, it is recommended to produce sequences of  $K$  random numbers via `f := stats::lognormalRandom(m, v): f() $k = 1..K` rather than by `stats::lognormalRandom(m, v)() $k = 1..K`. The latter call produces a sequence of generators each of which is called once. Also note that `stats::lognormalRandom(m, v, Seed = n)() $k = 1..K` does not produce a random sequence, because a sequence of freshly initialized generators would be created each of them producing the same number.

## Environment Interactions

The function is sensitive to the environment variable `DIGITS` which determines the numerical working precision.

## Examples

### Example 1

We generate log-normal deviates with location parameter 2 and shape parameter  $\frac{3}{4}$ :

```
f := stats::normalRandom(2, 3/4):  
f() $ k = 1..4
```

```
1.541231663, 1.506864857, 1.553005641, 1.055326957
```

```
delete f:
```

### Example 2

With symbolic parameters, no random floating-point numbers can be produced:

```
f := stats::lognormalRandom(m, v):  
f()
```



```
stats::lognormalRandom(m, v)()
```

When  $m$  and  $v$  evaluate to real numbers, `f` starts to produce random floating point numbers:

```
m := PI/10: v := 1/8:
f() $ k = 1..4
```

```
2.57120706, 1.714950915, 1.747513452, 1.543972889
```

```
delete f, m, v:
```

### Example 3

We use the option `Seed = s` to reproduce a sequence of random numbers:

```
f := stats::lognormalRandom(1, 3, Seed = 1):
f() $ k = 1..4
```

```
2.745783212, 0.566509847, 0.8352884053, 6.981716268
```

```
g := stats::lognormalRandom(1, 3, Seed = 1):
g() $ k = 1..4
```

```
2.745783212, 0.566509847, 0.8352884053, 6.981716268
```

```
f() = g(), f() = g()
```

```
2.891620861 = 2.891620861, 0.547178586 = 0.547178586
```

```
delete f, g:
```

## Parameters

**m**

The location parameter: an arithmetical expression (Symbolic Math Toolbox) representing a real value

**v**

The shape parameter: an arithmetical expression (Symbolic Math Toolbox) representing a positive real value

## Options

### Seed

Option, specified as `Seed = s`

Initializes the random generator with the integer seed `s`. `s` can also be the option `CurrentTime`, to make the seed depend on the current time.

This option serves for generating generators that return predictable sequences of pseudo-random numbers. The generator is initialized with the seed `s` which may be an arbitrary integer. Several generators with the same initial seed produce the same sequence of numbers.

When this option is used, the parameters `m` and `v` must be convertible to suitable floating-point numbers at the time when the random generator is generated.

## Return Values

procedure on page 1-1654.

## Algorithms

The implementation uses `stats::normalRandom`.

## See Also

### MuPAD Functions

stats::lognormalCDF | stats::lognormalPDF | stats::lognormalQuantile

## stats::mean

Arithmetic mean of a data sample

### Syntax

```
stats::mean(x1, x2, ...)
```

```
stats::mean([x1, x2, ...])
```

```
stats::mean(s, <c>)
```

### Description

`stats::mean(x1, x2, ..., xn)` returns the arithmetic mean  $\frac{1}{n} \left( \sum_{i=1}^n x_i \right)$  of the data  $x_i$ .

The column index `c` is optional if the data are given by a `stats::sample` object containing only one non-string column. Cf. “Example 3” on page 30-347 (Symbolic Math Toolbox).

External statistical data stored in an ASCII file can be imported into a MuPAD session via `import::readdata`. In particular, see Example 1 of the corresponding help page on page 13-11.

### Examples

#### Example 1

We calculate the arithmetic mean of three values:

```
stats::mean(a, b, c)
```

$$\frac{a}{3} + \frac{b}{3} + \frac{c}{3}$$

Alternatively, data may be passed as a list:

```
stats::mean([2, 3, 5])
```

$$\frac{10}{3}$$

## Example 2

We create a sample:

```
stats::sample([[a1, b1, c1], [a2, b2, c2]])
```

```
a1 b1 c1  
a2 b2 c2
```

The arithmetic mean of the second column is:

```
stats::mean(%, 2)
```

$$\frac{b1}{2} + \frac{b2}{2}$$

## Example 3

We create a sample consisting of one string column and one non-string column:

```
stats::sample(["1996", 1242], ["1997", 1353], ["1998", 1142])
```

```
"1996" 1242  
"1997" 1353  
"1998" 1142
```

We compute the arithmetic mean of the second column. In this case, this column does not have to be specified, since it is the only non-string column:

```
float(stats::mean(%))
```

```
1245.666667
```

## Parameters

$x_1, x_2, \dots$

The statistical data: arithmetical expressions (Symbolic Math Toolbox).

**s**

A sample of domain type `stats::sample`.

**c**

An integer representing a column index of the sample `s`. This column provides the data `x1, x2` etc.

## Return Values

Arithmetical expression.

## See Also

### MuPAD Functions

`stats::geometricMean` | `stats::harmonicMean` | `stats::median` | `stats::modal`  
| `stats::quadraticMean` | `stats::stdev` | `stats::variance`

## stats::meandev

Mean deviation of a data sample

### Syntax

```
stats::meandev(x1, x2, ...)
```

```
stats::meandev([x1, x2, ...])
```

```
stats::meandev(s, <c>)
```

### Description

stats::meandev( x<sub>1</sub>, x<sub>2</sub>, ..., x<sub>n</sub>) returns the mean deviation

$$\frac{1}{n} \left( \sum_{i=1}^n |x_i - \bar{x}| \right),$$

where  $\bar{x}$  is the mean on page 30-346 of the data  $x_i$ .

If all data are floating-point numbers, a float is returned. For symbolic data, the mean is returned as a symbolic expression.

The column index *c* is optional if the data are given by a stats::sample object containing only one non-string column.

External statistical data stored in an ASCII file can be imported into a MuPAD session via import::readdata. In particular, see Example 1 of the corresponding help page on page 13-11.

## Examples

### Example 1

We calculate the mean deviation of some data:

```
stats::meandev(2, 33/7, PI)
```

$$\frac{104}{63} - \frac{2\pi}{9}$$

Alternatively, the data may be passed as a list:

```
data:= [2, 33/7, PI]: stats::meandev(data)
```

$$\frac{104}{63} - \frac{2\pi}{9}$$

If all data are floating-point numbers, the result is a float:

```
stats::meandev(float(data))
```

```
0.95266195
```

```
delete data:
```

### Example 2

We create a sample of type `stats::sample`:

```
s := stats::sample([[22, 4, 1], [9, 8/3, 1], [2.0, 3, x]])
```

```
22   4   1  
9   8/3 1  
2.0  3   x
```

The mean deviations of the columns are computed:

```
stats::meandev(s, 1), stats::meandev(s, 2), stats::meandev(s, 3)
```



$$7.333333333, \frac{14}{27}, \frac{2 \left| \frac{x}{3} - \frac{1}{3} \right|}{3} + \frac{\left| \frac{2x}{3} - \frac{2}{3} \right|}{3}$$

delete s:

### Example 3

With symbolic arguments, the mean deviation is returned as a symbolic expression:

`stats::meandev(x1, x2, x3)`

$$\frac{\left| \frac{x_1}{3} + \frac{x_2}{3} - \frac{2x_3}{3} \right|}{3} + \frac{\left| \frac{x_1}{3} - \frac{2x_2}{3} + \frac{x_3}{3} \right|}{3} + \frac{\left| \frac{x_2}{3} - \frac{2x_1}{3} + \frac{x_3}{3} \right|}{3}$$

## Parameters

$x_1, x_2, \dots$

The statistical data: arithmetical expressions (Symbolic Math Toolbox)

**s**

A sample of domain type stats::sample on page 30-413

**c**

A column index of the sample s: a positive integer. This column provides the data  $x_1, x_2$  etc.

## Return Values

arithmetical expression (Symbolic Math Toolbox).

## See Also

### MuPAD Functions

`stats::moment` | `stats::stdev` | `stats::variance`

# stats::median

Median value of a data sample

## Syntax

```
stats::median(x1, x2, ..., <Averaged>)
```

```
stats::median([x1, x2, ...], <Averaged>)
```

```
stats::median(s, <c>, <Averaged>)
```

## Description

`stats::median(x1, x2, ...)` returns the median of the data  $x_i$ .

The median of  $n$  sorted values  $x_1 \leq \dots \leq x_n$  is  $x_{\lceil \frac{n}{2} \rceil}$ .

The averaged median of  $n$  sorted values  $x_1 \leq \dots \leq x_n$  is  $\frac{(x_{\lceil \frac{n}{2} \rceil} + x_{\lceil \frac{n+1}{2} \rceil})}{2}$ .

For odd  $n$ , both the median and the averaged median coincide with the element  $x_{\frac{(n+1)}{2}}$  of the sorted data list. For even  $n$ , the median is  $x_{\frac{n}{2}}$ , whilst the averaged median is

$$\frac{(x_{\frac{n}{2}} + x_{\frac{(n+2)}{2}})}{2}.$$

The median coincides with the  $\frac{1}{2}$ -quantile of the data: the calls `stats::median(data <Averaged>)` and `stats::empiricalQuantile(data)(1/2 <Averaged>)` are equivalent. See the help page of `stats::empiricalQuantile` for details on the parameters specifying the data.

The column index  $c$  is optional if the data are given by a `stats::sample` object containing only one non-string column. Cf. “Example 3” on page 30-355 (Symbolic Math Toolbox).

External statistical data stored in an ASCII file can be imported into a MuPAD session via `import::readdata`. In particular, see Example 1 of the corresponding help page on page 13-11.

## Examples

### Example 1

We calculate the median of a sequence of five values:

```
stats::median(3, 8, 5, 9/2, 11)
```

5

Alternatively, data may be passed as a list:

```
stats::median([2, 7, 3, 9/2, 11, 12]),  
stats::median([2, 7, 3, 9/2, 11, 12], Averaged)
```

$\frac{9}{2}, \frac{23}{4}$

### Example 2

We create a sample:

```
stats::sample([[4, 7, 5], [3, 6, 17], [8, 2, 2]])
```

```
4 7 5  
3 6 17  
8 2 2
```

The median of the second column is 6:

```
stats::median(%, 2)
```

```
6
```

### Example 3

We create a sample consisting of one string column and one non-string column:

```
stats::sample([["1996", 1242], ["1997", 1353], ["1998", 1142]])
```

```
"1996" 1242  
"1997" 1353  
"1998" 1142
```

The median of the second column is calculated. In this case, there is no need to specify the index of the column, since it is the only non-string data column in the sample:

```
stats::median(%)
```

```
1242
```

## Parameters

$x_1, x_2, \dots$

The statistical data: real numerical values.

**s**

A sample of domain type `stats::sample`

**c**

A column index of the sample `s`: a positive integer. This column provides the data `x1`, `x2` etc.

## Options

### Averaged

Return the averaged median value

## Return Values

arithmetical expression (Symbolic Math Toolbox). FAIL is returned if the data sample is empty.

## See Also

### MuPAD Functions

`stats::empiricalQuantile` | `stats::geometricMean` | `stats::harmonicMean` |  
`stats::mean` | `stats::modal` | `stats::quadraticMean` | `stats::stdev` |  
`stats::variance`

# stats::modal

Modal (most frequent) value(s) in a data sample

## Syntax

```
stats::modal(x1, x2, ...)
```

```
stats::modal([x1, x2, ...])
```

```
stats::modal(s, <c>)
```

## Description

`stats::modal(x1, x2, ...)` returns the most frequent value(s) of the data  $x_i$ .

The column index `c` is optional, if the data are given by a `stats::sample` object containing only one non-string column. Cf. “Example 3” on page 30-358 (Symbolic Math Toolbox).

External statistical data stored in an ASCII file can be imported into a MuPAD session via `import::readdata`. In particular, see Example 1 of the corresponding help page on page 13-11.

## Examples

### Example 1

We calculate the modal value of a data sequence:

```
stats::modal(2, a, b, c, b, 10, 12, 2, b)
```

```
[b], 3
```

Alternatively, data may be passed as a list:

```
stats::modal([a, a, a, b, c, b, 10, 12, 2, b])
```

```
[a, b], 3
```

## Example 2

We create a sample containing “age” and “gender”:

```
stats::sample([[32, "f"], [25, "m"], [40, "f"], [23, "f"]])
```

```
32 "f"  
25 "m"  
40 "f"  
23 "f"
```

The modal value of the second column (the most frequent “gender”) is calculated:

```
stats::modal(%, 2)
```

```
["f"], 3
```

## Example 3

We create a sample consisting of only one column:

```
stats::sample([4, 6, 2, 6, 8, 3, 2, 1, 7, 9, 3, 6, 5, 1, 6, 8]):
```

The modal value of these data is calculated. In this case, the column does not have to be specified, since there is only one column:

```
stats::modal(%)
```

```
[6], 4
```



## Parameters

$x_1, x_2, \dots$

The statistical data: arithmetical expressions. (Symbolic Math Toolbox)

**s**

A sample of domain type `stats::sample`.

**c**

An integer representing a column index of the sample `s`. This column provides the data `x1, x2` etc.

## Return Values

Sequence consisting of a list and an integer. The list contains the most frequent element(s) in the data, the integer specifies the number of occurrences. E.g., the result `[x5, x10], 21` means that `x5` and `x10` are the most frequent data items, each occurring 21 times.

## See Also

### MuPAD Functions

`stats::empiricalQuantile` | `stats::geometricMean` | `stats::harmonicMean` |  
`stats::mean` | `stats::median` | `stats::quadraticMean` | `stats::stdev` |  
`stats::variance`

## stats::moment

The K-th moment of a data sample

### Syntax

```
stats::moment(k, X, x1, x2, ...)
```

```
stats::moment(k, X, [x1, x2, ...])
```

```
stats::moment(k, X, s, <c>)
```

### Description

`stats::moment(k, X, [x1, x2, ..., xn])` returns the k-th moment

$$\frac{1}{n} \left( \sum_{i=1}^n (x_i - X)^k \right)$$

of the data  $x_i$  centered around  $X$ .

If  $k$  is an integer, rational or float, and all data  $X, x_1, x_2, \dots$  are floating-point numbers, then the moment is returned as a floating-point number. For symbolic data, a symbolic expression is returned.

The column index  $c$  is optional if the data are given by a `stats::sample` object containing only one non-string column.

External statistical data stored in an ASCII file can be imported into a MuPAD session via `import::readdata`. In particular, see Example 1 of the corresponding help page on page 13-11.

## Environment Interactions

The function is sensitive to the environment variable DIGITS which determines the numerical working precision.

## Examples

### Example 1

We calculate the third moment of some data centered around 0:

```
stats::moment(3, 0, 2, 33/7, 21/9, PI)
```

$$\frac{\pi^3}{4} + \frac{290509}{9261}$$

Alternatively, the data may be passed as a list:

```
data := [2, 33/7, 21/9, PI]: stats::moment(3, 0, data)
```

$$\frac{\pi^3}{4} + \frac{290509}{9261}$$

If all data are floating-point numbers, the result is a float:

```
data := float(data): stats::moment(3, 0, data)
```

39.12064378

We use stats::moment to compute the variance on page 30-480 of the data:

```
m := stats::mean(data):
stats::moment(2, m, data) = stats::variance(data, Population)
```

1.098579542 = 1.098579542

```
delete data, m:
```

## Example 2

We create a sample of type `stats::sample`:

```
s := stats::sample([[22, 4, 1], [9, 8/3, 1], [0.1, 2, 3]])
```

```
22    4    1
 9   8/3  1
0.1   2    3
```

The fourth moment around a symbolic center  $X$  is computed for all columns in the sample:

```
stats::moment(4, X, s, i) $ i = 1..3
```

$$\frac{(X-9)^4}{3} + \frac{(X-22)^4}{3} + \frac{(X-0.1)^4}{3}, \frac{(X-2)^4}{3} + \frac{(X-4)^4}{3} + \frac{(X-\frac{8}{3})^4}{3},$$

$$\frac{2(X-1)^4}{3} + \frac{(X-3)^4}{3}$$

```
delete s:
```

## Example 3

For symbolic arguments, the moment is returned as a symbolic expression:

```
stats::moment(k, X, [x1, x2, x3, x4])
```

$$\frac{(x1-X)^k}{4} + \frac{(x2-X)^k}{4} + \frac{(x3-X)^k}{4} + \frac{(x4-X)^k}{4}$$

## Parameters

**k**

An arithmetical expression (Symbolic Math Toolbox)

**X**

The center: an arithmetical expression (Symbolic Math Toolbox)

 **$x_1, x_2, \dots$** 

The statistical data: arithmetical expressions (Symbolic Math Toolbox)

**s**

A sample of domain type stats::sample on page 30-413

**c**

A column index of the sample s: a positive integer. This column provides the data  $x_1, x_2, \dots$

## Return Values

arithmetical expression (Symbolic Math Toolbox).

## See Also

### MuPAD Functions

stats::quadraticMean | stats::variance

## stats::normalCDF

Cumulative distribution function of the normal distribution

### Syntax

```
stats::normalCDF(m, v)
```

### Description

`stats::normalCDF(m, v)` returns a procedure representing the cumulative distribution function

$$x \rightarrow \frac{1}{\sqrt{2\pi v}} \int_{-\infty}^x e^{-\frac{(t-m)^2}{2v}} dt$$

of the normal distribution with mean  $m$  and variance  $v$ .

The procedure `f := stats::normalCDF(m, v)` can be called in the form `f(x)` with an arithmetical expression  $x$ . The value  $1/2 + 1/2 * \text{erf}((x - m)/\text{sqrt}(2*v))$  is returned.

If  $x$  is a floating-point number and both  $m$  and  $v$  can be converted to floating-point numbers, this value is returned as a floating-point number. Otherwise, a symbolic expression is returned.

Numerical values for  $m$  and  $v$  are only accepted if they are real and  $v$  is positive.

### Environment Interactions

The function is sensitive to the environment variable `DIGITS` which determines the numerical working precision.

## Examples

### Example 1

We evaluate the cumulative distribution function with mean  $m = 2$  and variance  $v = \frac{3}{4}$  at various points:

```
f := stats::normalCDF(2, 3/4):
f(-infinity), f(-3), f(PI), f(infinity)
```

$$0, \frac{1}{2} - \frac{\operatorname{erf}\left(\frac{5\sqrt{2}\sqrt{3}}{3}\right)}{2}, \frac{\operatorname{erf}\left(\frac{\sqrt{2}\sqrt{3}(\pi-2)}{3}\right)}{2} + \frac{1}{2}, 1$$

```
f(-100.0), f(-3.0), f(float(PI)), f(10.0), f(100.0)
```

$$1.833507721 \cdot 10^{-3015}, 0.000000003882018269, 0.9062812543, 1.0, 1.0$$

```
delete f:
```

### Example 2

We use symbolic arguments:

```
f := stats::normalCDF(m, v): f(3), f(x)
```

$$\frac{1}{2} - \frac{\operatorname{erf}\left(\frac{\sqrt{2}(m-3)}{2\sqrt{v}}\right)}{2}, \frac{1}{2} - \frac{\operatorname{erf}\left(\frac{\sqrt{2}(m-x)}{2\sqrt{v}}\right)}{2}$$

When numerical values are assigned to  $m$  and  $v$ , the function  $f$  starts to produce numerical values:

```
m := 4: v := PI: f(3), f(3.0)
```

$$\frac{1}{2} - \frac{\operatorname{erf}\left(\frac{\sqrt{2}}{2\sqrt{\pi}}\right)}{2}, 0.286312558$$

delete f, m, v:

## Parameters

**m**

The mean: an arithmetical expression (Symbolic Math Toolbox) representing a real value

**v**

The variance: an arithmetical expression (Symbolic Math Toolbox) representing a positive real value

## Return Values

procedure on page 1-1654.

## See Also

### **MuPAD Functions**

erf | stats::normalPDF | stats::normalQuantile | stats::normalRandom



# stats::normalPDF

Probability density function of the normal distribution

## Syntax

```
stats::normalPDF(m, v)
```

## Description

`stats::normalPDF(m, v)` returns a procedure representing the probability density function

$$x \rightarrow \frac{1}{\sqrt{2\pi v}} \exp\left(-\frac{(x-m)^2}{2v}\right)$$

of the normal distribution with mean  $m$  and variance  $v$ .

The procedure `f := stats::normalPDF(m, v)` can be called in the form `f(x)` with an arithmetical expression  $x$ . The value  $\exp(-(x - m)^2/(2*v))/\sqrt{2*PI*v}$  is returned.

If  $x$  is a floating-point number and both  $m$  and  $v$  can be converted to floating-point numbers, this value is returned as a floating-point number. Otherwise, a symbolic expression is returned.

Numerical values for  $m$  and  $v$  are only accepted if they are real and  $v$  is positive.

## Environment Interactions

The function is sensitive to the environment variable `DIGITS` which determines the numerical working precision.

## Examples

### Example 1

We compute the probability density with mean  $m = 2$  and variance  $v = 4$  at various points:

```
f := stats::normalPDF(2, 4):  
f(-infinity), f(-3), f(2.0), f(PI), f(infinity)
```

$$0, \frac{\sqrt{2} e^{-\frac{25}{8}}}{4 \sqrt{\pi}}, 0.1994711402, \frac{\sqrt{2} e^{-\frac{(\pi-2)^2}{8}}}{4 \sqrt{\pi}}, 0$$

```
delete f:
```

### Example 2

We use symbolic arguments:

```
f := stats::normalPDF(m, v): f(x), f(0.4)
```

$$\frac{\sqrt{2} e^{-\frac{(m-x)^2}{2v}}}{2 \sqrt{v} \sqrt{\pi}}, \frac{\sqrt{2} e^{-\frac{(m-0.4)^2}{2v}}}{2 \sqrt{v} \sqrt{\pi}}$$

When numerical values are assigned to  $m$  and  $v$ , the function  $f$  starts to produce numerical values:

```
m := PI: v := 2: f(3), f(3.0)
```

$$\frac{e^{-\frac{(\pi-3)^2}{4}}}{2 \sqrt{\pi}}, 0.2806844362$$

```
delete f, m, v:
```

## Parameters

**m**

The mean: an arithmetical expression (Symbolic Math Toolbox) representing a real value

**v**

The variance: an arithmetical expression (Symbolic Math Toolbox) representing a positive real value

## Return Values

procedure on page 1-1654.

## See Also

### **MuPAD Functions**

`exp` | `stats::normalCDF` | `stats::normalQuantile` | `stats::normalRandom`

## stats::normalQuantile

Quantile function of the normal distribution

### Syntax

```
stats::normalQuantile(m, v)
```

### Description

`stats::normalQuantile(m, v)` returns a procedure representing the quantile function (inverse) of the cumulative distribution function `stats::normalCDF(m, v)` of the normal distribution with mean  $m$  and variance  $v > 0$ : For  $0 \leq x \leq 1$ , the solution of  $stats::normalCDF(m, v)(y) = x$  is given by  $y = stats::normalQuantile(m, v)(x)$ .

The procedure `f := stats::normalQuantile(m, v)` can be called in the form `f(x)` with an arithmetical expression  $x$ . The return value of `f(x)` is either a floating-point number, `±infinity`, or a symbolic expression:

If  $x$  is a real number between 0 and 1 and both  $m$  and  $v$  can be converted to floating-point numbers, then `f(x)` returns a real floating-point number approximating the solution  $y$  of  $stats::normalCDF(m, v)(y) = x$ .

The calls `f(0)` and `f(0.0)` produce `-infinity` for all values of  $m$  and  $v$ .

The calls `f(1)` and `f(1.0)` produce `infinity` for all values of  $m$  and  $v$ .

In all other cases, `f(x)` returns the symbolic call `stats::normalQuantile(m, v)(x)`.

Numerical values for  $m$  and  $v$  are only accepted if they are real and  $v$  is positive.

### Environment Interactions

The function is sensitive to the environment variable `DIGITS` which determines the numerical working precision.

## Examples

### Example 1

We evaluate the quantile function with mean  $m = \pi$  and variance  $v = 11$  at various points:

```
f := stats::normalQuantile(PI, 11):
f(0), f(1/10), f(0.5), f(1 - 10^(-10)), f(1)

-∞, -1.108833039, 3.141592654, 24.23977359, ∞
```

The value  $f(x)$  satisfies  $\text{stats::normalCDF}(\pi, 11)(f(x)) = x$ :

```
stats::normalCDF(PI, 11)(f(0.987654))

0.987654
```

delete f:

### Example 2

We use symbolic arguments:

```
f := stats::normalQuantile(m, v): f(x), f(9/10)

stats::normalQuantile(m, v)(x), stats::normalQuantile(m, v)(9/10)
```

When numerical values are assigned to  $m$  and  $v$ , the function  $f$  starts to produce floating-point values:

```
m := 17: v := 6: f(9/10), f(0.999)

20.13914741, 24.56949234
```

Numerical values for  $x$  are only accepted if  $0 \leq x \leq 1$ :

```
f(0.5)
```

## 17.0

f(2)

Error: Argument x must be between 0 and 1. [f]

delete f, m, v:

## Parameters

**m**

The mean: an arithmetical expression (Symbolic Math Toolbox) representing a real value

**v**

The variance: an arithmetical expression (Symbolic Math Toolbox) representing a positive real value

## Return Values

procedure on page 1-1654.

## See Also

### MuPAD Functions

stats::normalCDF | stats::normalPDF | stats::normalRandom

# stats::normalRandom

Generate a random number generator for normal deviates

## Syntax

stats::normalRandom(*m*, *v*, <Seed = *s*>)

## Description

stats::normalRandom(*m*, *v*) returns a procedure that produces normal on page 30-364 deviates (random numbers) with mean *m* and variance  $v > 0$ .

The procedure `f := stats::normalRandom(m, v)` can be called in the form `f()`. The return value of `f()` is either a floating-point number or a symbolic expression:

If *m* and *v* can be converted to floating-point numbers, `f()` returns a real floating point number. Otherwise, the symbolic call `stats::normalRandom(m, v)()` is returned.

Numerical values of *m* and *v* are only accepted if they are real and *v* is positive.

The values  $X = f()$  are distributed randomly according to the cumulative distribution function of the normal distribution with parameters *m* and *v*. For any real *x*, the probability that  $X \leq x$  is given by

$$\frac{1}{\sqrt{2\pi v}} \int_{-\infty}^x e^{-\frac{(t-m)^2}{2v}} dt$$

Without the option `Seed = s`, an initial seed is chosen internally. This initial seed is set to a default value when MuPAD is started. Thus, each time MuPAD is started or re-initialized with the `reset` function, random generators produce the same sequences of numbers.

---

**Note** In contrast to the function `random`, the generators produced by `stats::normalRandom` do not react to the environment variable `SEED`.

---

For efficiency, it is recommended to produce sequences of  $K$  random numbers via

```
f := stats::normalRandom(m, v): f() $k = 1..K;
```

rather than by

```
stats::normalRandom(m, v)() $k = 1..K;
```

The latter call produces a sequence of generators each of which is called once. Also note that

```
stats::normalRandom(m, v, Seed = n)() $k = 1..K;
```

does not produce a random sequence, because a sequence of freshly initialized generators would be created each of them producing the same number.

## Environment Interactions

The function is sensitive to the environment variable DIGITS which determines the numerical working precision.

## Examples

### Example 1

We generate normal deviates with mean 2 and variance  $\frac{3}{4}$ :

```
f := stats::normalRandom(2, 3/4): f() $ k = 1..4
```

```
1.541231663, 1.506864857, 1.553005641, 1.055326957
```

```
delete f:
```

### Example 2

With symbolic parameters, no random floating-point numbers can be produced:



```
f := stats::normalRandom(m, v): f()
```

```
stats::normalRandom(m, v)()
```

When  $m$  and  $v$  evaluate to real numbers,  $f$  starts to produce random floating point numbers:

```
m := PI: v := 1/8: f() $ k = 1..4
```

```
3.77180885, 3.366817847, 3.385627281, 3.261792281
```

```
delete f, m, v:
```

### Example 3

We use the option `Seed = s` to reproduce a sequence of random numbers:

```
f := stats::normalRandom(PI, 3, Seed = 1): f() $ k = 1..4
```

```
3.151659011, 1.573331837, 1.961614435, 4.084887424
```

```
g := stats::normalRandom(PI, 3, Seed = 1): g() $ k = 1..4
```

```
3.151659011, 1.573331837, 1.961614435, 4.084887424
```

```
f() = g(), f() = g()
```

```
3.20340985 = 3.20340985, 1.538612606 = 1.538612606
```

```
delete f, g:
```

## Parameters

**m**

The mean: an arithmetical expression (Symbolic Math Toolbox) representing a real value

**v**

The variance: an arithmetical expression (Symbolic Math Toolbox) representing a positive real value

## Options

### Seed

Option, specified as `Seed = s`

Initializes the random generator with the integer seed `s`. `s` can also be the option `CurrentTime`, to make the seed depend on the current time.

This option serves for generating generators that return predictable sequences of pseudo-random numbers. The generator is initialized with the seed `s` which may be an arbitrary integer. Several generators with the same initial seed produce the same sequence of numbers.

When this option is used, the parameters `m` and `v` must be convertible to suitable floating-point numbers at the time when the random generator is generated.

## Return Values

procedure on page 1-1654.

## Algorithms

The implemented algorithm for the computation of the normal deviates uses the Box-Mueller method. For more information see: D. Knuth, *Seminumerical Algorithms* (1998), Vol. 2, pp. 122.

## See Also

### MuPAD Functions

stats::normalCDF | stats::normalPDF | stats::normalQuantile

## stats::obliquity

Obliquity (skewness) of a data sample

### Syntax

```
stats::obliquity(x1, x2, ...)
```

```
stats::obliquity([x1, x2, ...])
```

```
stats::obliquity(s, <c>)
```

### Description

*stats::obliquity*(x<sub>1</sub>, x<sub>2</sub>, ..., x<sub>n</sub>) returns the obliquity (skewness)

$$\frac{\frac{1}{n} \left( \sum_{i=1}^n (x_i - \bar{x})^3 \right)}{\left( \frac{1}{n} \left( \sum_{i=1}^n (x_i - \bar{x})^2 \right) \right)^{3/2}},$$

where  $\bar{x}$  is the mean on page 30-346 of the data  $x_i$ .

The obliquity is a measure for the symmetry of a distribution. It is zero, if the distribution of the data is symmetric around the mean. Positive values indicate that the distribution function has a “longer tail” to the right of the mean than to the left. Negative values indicate a “longer tail” to the left.

The column index *c* is optional, if the data are given by a `stats::sample` object containing only one non-string column. Cf. “Example 3” on page 30-379 (Symbolic Math Toolbox).

External statistical data stored in an ASCII file can be imported into a MuPAD session via `import::readdata`. In particular, see Example 1 of the corresponding help page on page 13-11.

## Examples

### Example 1

We calculate the obliquity of a data sequence:

```
float(stats::obliquity(0, 7, 7, 6, 6, 6, 5, 5, 4, 1))
-1.041368312
```

Alternatively, data may be passed as a list:

```
stats::obliquity([2, 2, 4, 6, 8, 10, 10])
0
```

### Example 2

We create a sample:

```
stats::sample([[a, 5, 8], [b, 3, 7], [c, d, 0]])

a 5 8
b 3 7
c d 0
```

The obliquity of the second column is:

```
stats::obliquity(%, 2)
```

$$-\frac{\sqrt{3} \left( \left( \frac{d}{3} - \frac{1}{3} \right)^3 + \left( \frac{d}{3} - \frac{7}{3} \right)^3 - \left( \frac{2d}{3} - \frac{8}{3} \right)^3 \right)}{\left( \left( \frac{d}{3} - \frac{1}{3} \right)^2 + \left( \frac{d}{3} - \frac{7}{3} \right)^2 + \left( \frac{2d}{3} - \frac{8}{3} \right)^2 \right)^{3/2}}$$

### Example 3

We create a sample consisting of one string column and one non-string column:

```
stats::sample(["1996", 1242], ["1997", 1353], ["1998", 1142])
```

```
"1996" 1242  
"1997" 1353  
"1998" 1142
```

We compute the obliquity of the second column. In this case this column does not have to be specified, since it is the only non-string column:

```
float(stats::obliquity(%))
```

```
0.06374333648
```

## Parameters

$x_1, x_2, \dots$

The statistical data: arithmetical expressions. (Symbolic Math Toolbox)

**s**

A sample of domain type `stats::sample`.

**c**

An integer representing a column index of the sample `s`. This column provides the data `x1, x2` etc.

## Return Values

Arithmetical expression. FAIL is returned, if the obliquity does not exist.

## See Also

**MuPAD Functions**  
`stats::kurtosis`

## stats::poissonCDF

The (discrete) cumulative distribution function of the Poisson distribution

### Syntax

```
stats::poissonCDF(m)
```

### Description

`stats::poissonCDF(m)` returns a procedure representing the (discrete) cumulative distribution function

$$x \rightarrow \begin{cases} 0 & \text{if } x < 0 \\ \sum_{i=0}^{\lfloor x \rfloor} \frac{m^i e^{-m}}{i!} & \text{if } x \geq 0 \end{cases}$$

of the Poisson distribution with mean  $m$ .

The procedure `f := stats::poissonCDF(m)` can be called in the form `f(x)` with arithmetical expressions  $x$ . The return value of `f(x)` is either a floating-point number, an exact numerical value, or a symbolic expression:

If  $x$  is a numerical real value, then an explicit value is returned. It is a floating-point number if  $x$  is a floating-point number and  $m$  can be converted to a positive real float. Otherwise, an exact expression is returned.

If  $x$  is a numerical value  $< 0$ , then  $0$ , respectively  $0.0$ , is returned for any value of  $m$ .

For symbolic values of  $x$ , `f(x)` returns the symbolic call `stats::poissonCDF(m)(x)`.

Numerical values for  $m$  are only accepted if they are nonnegative.

If  $x$  is a real floating-point number, the result is a floating number provided  $m$  is a nonnegative numerical value. If both  $x$  and  $m$  are exact numerical values, the result is an exact number.

**Note** Note that for large  $m$ , floating-point results are computed much faster than exact results. If floating-point approximations are desired, pass a floating-point number  $x$  to `stats::poissonCDF`!

---

## Environment Interactions

The function is sensitive to the environment variable DIGITS which determines the numerical working precision.

## Examples

### Example 1

We evaluate the distribution function with  $m = \frac{1}{2}$  at various points:

```
f := stats::poissonCDF(1/2):  
f(-PI) = f(float(-PI)), f(0) = f(0.0), f(4) = f(4.0)
```

$$0 = 0.0, e^{-\frac{1}{2}} = 0.6065306597, \frac{211 e^{-\frac{1}{2}}}{128} = 0.9998278844$$

```
delete f:
```

### Example 2

We use symbolic arguments. If  $x$  is symbolic, a symbolic call is returned:

```
f := stats::poissonCDF(m): f(x)
```

```
stats::poissonCDF(m)(x)
```

If  $x$  is a numerical value, symbolic expressions in  $m$  are returned:

```
f(-1), f(0), f(5/2), f(PI)
```



$$0, e^{-m}, e^{-m} \left( \frac{m^2}{2} + m + 1 \right), e^{-m} \left( \frac{m^3}{6} + \frac{m^2}{2} + m + 1 \right)$$

When numerical values are assigned to  $m$ , the function  $f$  starts to produce explicit results if the argument is numerical:

```
m := 3: f(-1), f(0), f(5/2), f(PI)
```

$$0, e^{-3}, \frac{17 e^{-3}}{2}, 13 e^{-3}$$

```
delete f, m:
```

## Parameters

**m**

The mean: an arithmetical expression (Symbolic Math Toolbox) representing a nonnegative real number

## Return Values

procedure on page 1-1654.

## See Also

### MuPAD Functions

stats::poissonPF | stats::poissonQuantile | stats::poissonRandom

## stats::poissonPF

Probability function of the Poisson distribution

### Syntax

```
stats::poissonPF(m)
```

### Description

stats::poissonPF(m) returns a procedure representing the probability function

$$x \rightarrow \frac{m^x}{e^m x!}$$

of the Poisson distribution with mean  $m$ .

The procedure `f := stats::poissonPF(m)` can be called in the form `f(x)` with arithmetical expressions  $x$ . The return value of `f(x)` is either a floating-point number, an exact numerical value, or a symbolic expression:

If  $x$  is a non-integer numerical value, `f(x)` returns `0` or `0.0`, respectively.

If  $x$  is an integer or the floating-point equivalent of an integer, then an explicit value is returned.

In all other cases, `f(x)` returns the symbolic call `stats::poissonPF(n,p)(x)`.

Numerical values for  $m$  are only accepted if they are nonnegative.

If  $x$  is a floating-point number, the result is a floating-point number provided  $m$  is a nonnegative numerical value. If both  $x$  and  $m$  are exact values then the result is an exact number.

Note that for large  $m$ , floating-point results are computed much faster than exact results. If floating-point approximations are desired, pass a floating-point number  $x$  to the procedure generated by `stats::poissonPF`.

## Environment Interactions

The function is sensitive to the environment variable DIGITS which determines the numerical working precision.

## Examples

### Example 1

We calculate the Poisson probability with  $m = 8$  at various points:

```
f := stats::poissonPF(8):
f(-1), f(-1.0), f(0), f(1/2), f(1), f(3/2), f(3) = f(float(3))
```

$$0, 0.0, e^{-8}, 0, 8 e^{-8}, 0, \frac{256 e^{-8}}{3} = 0.02862614425$$

```
delete f:
```

### Example 2

We use symbolic arguments:

```
f := stats::poissonPF(m): f(x)
```

```
stats::poissonPF(m)(x)
```

If  $x$  is a numerical value, symbolic expressions in  $m$  are returned:

```
f(8), f(17/2), f(9.0), f(9.2)
```

$$\frac{m^8 e^{-m}}{40320}, 0, 0.000002755731922 m^{9.0} e^{-1.0 m}, 0.0$$

When numerical values are assigned to  $m$ , the function  $f$  starts to produce numbers if the argument is numerical:

```
m := 3: f(8), f(17/2), f(9.0), f(9.2)
```

```
 $\frac{729 e^{-3}}{4480}$ , 0, 0.002700503932, 0.0
```

```
delete f, m:
```

## Parameters

**m**

The mean: an arithmetical expression (Symbolic Math Toolbox) representing a nonnegative real number

## Return Values

procedure on page 1-1654.

## See Also

### MuPAD Functions

stats::poissonCDF | stats::poissonQuantile | stats::poissonRandom

# stats::poissonQuantile

Quantile function of the Poisson distribution

## Syntax

```
stats::poissonQuantile(m)
```

## Description

`stats::poissonQuantile(m)` returns a procedure representing the quantile function (discrete inverse) of the cumulative distribution function `stats::poissonCDF(m)`. For  $0 \leq x \leq 1$ ,  $k = \text{stats::poissonQuantile}(m)(x)$  is the smallest nonnegative integer satisfying

$$\text{stats::poissonCDF}(m)(k) = \sum_{i=0}^k \frac{m^i}{i!} \geq x$$

The procedure `f := stats::poissonQuantile(m)` can be called in the form `f(x)` with an arithmetical expression `x`. The return value of the call `f(x)` is either a nonnegative integer, `infinity`, or a symbolic expression:

If  $m$  is a nonnegative real number and  $x$  a real number satisfying  $0 \leq x < 1$ , then `f(x)` returns a nonnegative integer.

If  $m = 0$ , then `f(x)` returns `0` for any  $x$ .

If  $m \neq 0$ , then `f(1)` and `f(1.0)` return `infinity`.

In all other cases, `f(x)` returns the symbolic call `stats::poissonQuantile(m)(x)`.

Numerical values for  $m$  are only accepted if they are positive.

If floating-point arguments are passed to the quantile function `f`, the result is computed with floating-point arithmetic. This is faster than using exact arithmetic, but the result is

subject to internal round-off errors. In particular, round-off may be significant for arguments  $x$  close to 1. Cf. “Example 3” on page 30-389 (Symbolic Math Toolbox).

Finite quantile values  $k = \text{stats}::\text{poissonQuantile}(m)(x)$  satisfy

$$\text{stats}::\text{poissonCDF}(m)(k-1) < x \leq \text{stats}::\text{poissonCDF}(m)(k)$$

## Environment Interactions

The function is sensitive to the environment variable DIGITS which determines the numerical working precision.

## Examples

### Example 1

We evaluate the quantile function with  $m = \pi$  at various points:

```
f := stats::poissonQuantile(PI):  
f(0), f(1/20), f(0.3), f(PI/6), f(0.7), f(1-1/10^10), f(1)
```

```
0, 1, 2, 3, 4, 20, ∞
```

The value  $f(x)$  satisfies

$$\text{stats}::\text{poissonCDF}(\pi)(f(x)-1) < x \leq \text{stats}::\text{poissonCDF}(\pi)(f(x))$$

```
x := 0.98: k := f(x)
```

```
7
```

```
float(stats::poissonCDF(PI)(k-1)), x,  
float(stats::poissonCDF(PI)(k))
```

```
0.9588410737, 0.98, 0.9847376421
```

```
delete f, x, k:
```

## Example 2

We use symbolic arguments:

```
f := stats::poissonQuantile(m): f(x), f(9/10)
```

$$\text{stats::poissonQuantile}(m)(x), \text{stats::poissonQuantile}(m)\left(\frac{9}{10}\right)$$

When  $m$  evaluates to a positive real number, the function  $f$  starts to produce quantile values:

```
m := 17:
f(1/2), f(999/1000), f(1 - 1/10^10), f(1 - 1/10^80)
```

$$17, 31, 49, 144$$

```
delete f, m:
```

## Example 3

If floating-point arguments are passed to the quantile function, the result is computed with floating-point arithmetic. This is faster than using exact arithmetic, but the result is subject to internal round-off errors:

```
f := stats::poissonQuantile(123):
f(1 - 1/10^19) <> f(float(1 - 1/10^19))
```

$$236 \neq \infty$$

```
delete f:
```

## Parameters

**m**

The mean: a arithmetical expression (Symbolic Math Toolbox) representing a nonnegative real number

## Return Values

procedure on page 1-1654.

## See Also

### **MuPAD Functions**

`stats::poissonCDF` | `stats::poissonPF` | `stats::poissonRandom`



# stats::poissonRandom

Generate a random number generator for Poisson deviates

## Syntax

```
stats::poissonRandom(m, <Seed = s>)
```

## Description

`stats::poissonRandom(m)` returns a procedure that produces poisson on page 30-381-deviates (random numbers) with mean  $m$ .

The procedure `f := stats::poissonRandom(m)` can be called in the form `f()`. The return value of `f()` is a nonnegative integer if  $m$  is a nonnegative numerical value.

Otherwise, `stats::poissonRandom(m)()` is returned symbolically.

Numerical values for  $m$  are only accepted if they are nonnegative.

The values  $X = f()$  are distributed randomly according to the discrete distribution function of the Poisson distribution with mean  $m$ , i.e., for  $0 \leq x$ , the probability of  $X \leq x$  is given by

$$\sum_{i=0}^{\lfloor x \rfloor} \frac{m^i}{e^m i!}$$

Without the option `Seed = s`, an initial seed is chosen internally. This initial seed is set to a default value when MuPAD is started. Thus, each time MuPAD is started or re-initialized with the `reset` function, random generators produce the same sequences of numbers.

---

**Note** With this option, the mean  $m$  must evaluate to a nonnegative numerical value at the time, when the generator is created.

---

---

**Note** In contrast to the function `random`, the generators produced by `stats::poissonRandom` do not react to the environment variable `SEED`.

---

For efficiency, it is recommended to produce sequences of  $K$  random numbers via

```
f := stats::poissonRandom(m): f() $k = 1..K;
```

rather than by

```
stats::poissonRandom(m)() $k = 1..K;
```

The latter call produces a sequence of generators each of which is called once. Also note that

```
stats::poissonRandom(m, Seed = s)() $k = 1..K;
```

does not produce a random sequence, because a sequence of freshly initialized generators would be created each of them producing the same number.

## Environment Interactions

The function is sensitive to the environment variable `DIGITS` which determines the numerical working precision.

## Examples

### Example 1

We generate Poisson deviates with mean  $m = 80$ :

```
f := stats::poissonRandom(80): f() $ k = 1..10
```

```
69, 105, 77, 81, 71, 79, 86, 77, 87, 97
```

```
delete f:
```

## Example 2

With symbolic parameters, no random floating-point numbers can be produced:

```
f := stats::poissonRandom(m): f()

stats::poissonRandom(m)()
```

When  $m$  evaluates to a positive real number, the generator starts to produce random numbers:

```
m := 80: f(), f(), f()

89, 76, 82
```

```
delete f, m:
```

## Example 3

We use the option `Seed = s` to reproduce a sequence of random numbers:

```
f := stats::poissonRandom(12, Seed = 1): f() $ k = 1..10

12, 15, 8, 9, 15, 4, 12, 9, 7, 10
```

```
g := stats::poissonRandom(12, Seed = 1): g() $ k = 1..10

12, 15, 8, 9, 15, 4, 12, 9, 7, 10
```

```
f() = g(), f() = g()

11 = 11, 11 = 11
```

```
delete f, g:
```

## Parameters

**m**

The mean: an arithmetical expression (Symbolic Math Toolbox) representing a nonnegative real number

## Options

### Seed

Option, specified as `Seed = s`

Initializes the random generator with the integer seed `s`. `s` can also be the option `CurrentTime`, to make the seed depend on the current time.

This option serves for generating generators that return predictable sequences of pseudo-random numbers. The generator is initialized with the seed `s` which may be an arbitrary integer. Several generators with the same initial seed produce the same sequence of numbers.

When this option is used, the mean `m` must be convertible to a positive floating-point number at the time when the random generator is generated.

## Return Values

procedure on page 1-1654.

## See Also

### MuPAD Functions

`stats::poissonCDF` | `stats::poissonPF` | `stats::poissonQuantile`

# stats::quadraticMean

Quadratic mean of a data sample

## Syntax

```
stats::quadraticMean(x1, x2, ...)
```

```
stats::quadraticMean([x1, x2, ...])
```

```
stats::quadraticMean(s, <c>)
```

## Description

`stats::quadraticMean(x1, x2, ..., xn)` returns the quadratic mean

$$\sqrt{\frac{1}{n} \left( \sum_{i=1}^n x_i^2 \right)}$$

of the data  $x_i$ .

The column index `c` is optional, if the data are given by a `stats::sample` object containing only one non-string column. Cf. “Example 3” on page 30-396 (Symbolic Math Toolbox).

External statistical data stored in an ASCII file can be imported into a MuPAD session via `import::readdata`. In particular, see Example 1 of the corresponding help page on page 13-11.

## Examples

### Example 1

We calculate the quadratic mean of three values:

```
stats::quadraticMean(a, b, c)
```

$$\sqrt{\frac{a^2}{3} + \frac{b^2}{3} + \frac{c^2}{3}}$$

Alternatively, data may be passed as a list:

```
stats::quadraticMean([2, 3, 5])
```

$$\frac{\sqrt{3} \sqrt{38}}{3}$$

## Example 2

We create a sample:

```
stats::sample([[a1, b1, c1], [a2, b2, c2]])
```

```
a1 b1 c1  
a2 b2 c2
```

The quadratic mean of the second column is:

```
stats::quadraticMean(%, 2)
```

$$\sqrt{\frac{b1^2}{2} + \frac{b2^2}{2}}$$

## Example 3

We create a sample consisting of one string column and one non-string column:

```
stats::sample([["1996", 1242], ["1997", 1353], ["1998", 1142]])
```

```
"1996" 1242  
"1997" 1353  
"1998" 1142
```

We compute the quadratic mean of the second column. In this case this column does not have to be specified, since it is the only non-string column:

```
float(stats::quadraticMean(%))
```

```
1248.644198
```

## Parameters

$x_1, x_2, \dots$

The statistical data: arithmetical expressions. (Symbolic Math Toolbox)

**s**

A sample of domain type `stats::sample`.

**c**

An integer representing a column index of the sample `s`. This column provides the data `x1, x2` etc.

## Return Values

arithmetical expression. (Symbolic Math Toolbox)

## See Also

### MuPAD Functions

`stats::geometricMean` | `stats::harmonicMean` | `stats::mean` | `stats::median` | `stats::modal` | `stats::stdev` | `stats::variance`

## stats::reg

Regression (general linear and nonlinear least squares fit)

### Syntax

```
stats::reg([x1, 1, ..., xk, 1], ..., [x1, m, ..., xk, m], [y1, ..., yk], <[w1, ..., wk]>, f, [x1, ..., xm], [p1, ..., pn], <StartingValues = [p1(θ), ..., pn(θ)]>)
stats::reg([ [x1, 1, ..., x1, m, y1, <w1> ], ..., [xk, 1, ..., xk, m, yk, <wk> ] ], f, [x1, ..., xm], [p1, ..., pn], <StartingValues = [p1(θ), ..., pn(θ)]>)
stats::reg(s, c1, ..., cm, cy, <cw>, f, [x1, ..., xm], [p1, ..., pn], <StartingValues = [p1(θ), ..., pn(θ)]>)
stats::reg(s, [c1, ..., cm], cy, <cw>, f, [x1, ..., xm], [p1, ..., pn], <StartingValues = [p1(θ), ..., pn(θ)]>)
```

### Description

Consider a “model function”  $f$  with  $n$  parameters  $p_1, \dots, p_n$  relating a dependent variable  $y$  and  $m$  independent variables  $x_1, \dots, x_m$ :  $y = f(x_1, \dots, x_m, p_1, \dots, p_n)$ . Given  $k$  different measurements  $x_{1j}, \dots, x_{kj}$  for the independent variables  $x_j$  and corresponding measurements  $y_1, \dots, y_k$  for the dependent variable  $y$ , one fits the parameters  $p_1, \dots, p_n$  by minimizing the “weighted quadratic deviation” (“chi-squared”)

$$\chi^2(p_1, \dots, p_n) = \sum_{i=1}^k w_i |y_i - f(x_{i1}, \dots, x_{im}, p_1, \dots, p_n)|^2$$

`stats::reg(..data.., f, [x.1, ... , x.m], [p.1, ... , p.n], [w.1, ... , w.n])` computes numerical approximations of the fit parameters  $p_1, \dots, p_n$ .

All data must be convertible to real or complex floating-point values via `float`.

The number of measurements  $k$  must not be less than the number  $n$  of parameters  $p_i$ .

The model function  $f$  may be non-linear in the independent variables  $x_i$  and the fit parameters  $p_i$ . E.g., a model function such as  $p_1 + p_2 * x_1^2 + \exp(p_3 + p_4 * x_2)$  with the independent variables  $x_1, x_2$  and the fit parameters  $p_1, p_2, p_3, p_4$  is accepted.



Note that the fitting of model functions with a non-linear dependence on the parameters  $p_i$  is much more costly than a linear regression, where the  $p_i$  enter linearly. The functional dependence of the model function on the variables  $x_i$  is of no relevance.

---

**Note** There are rare cases where the implemented algorithm converges to a local minimum rather than to a global minimum. In particular, this problem may arise when the model involves periodic functions. It is recommended to provide suitable starting values for the fit parameters in this case. Cf. “Example 4” on page 30-401 (Symbolic Math Toolbox).

---

External statistical data stored in an ASCII file can be imported into a MuPAD session via `import::readdata`. In particular, see Example 1 of the corresponding help page on page 13-11.

## Environment Interactions

The function is sensitive to the environment variable `DIGITS`, which determines the numerical working precision.

## Examples

### Example 1

We fit a linear function  $y = p_1 + p_2 x_1$  to four data pairs  $(x_{it}, y_i)$  given by two lists:

```
stats::reg([0, 1, 2, 3], [1, 3, 5, 7],
           p1 + p2*x1, [x1], [p1, p2])
```

```
[[1.0, 2.0], 0.0]
```

The parameter values  $p_1 = 1.0$ ,  $p_2 = 2.0$  provide a perfect fit: up to numerical round-off, the quadratic deviation vanishes.

## Example 2

We fit an exponential function  $y = a e^{bx}$  to five data pairs  $(x_i, y_i)$ . Weights are used to decrease the influence of the “exceptional pair”  $(x, y) = (5.0, 6.5 \times 10^6)$  on the fit:

```
stats::reg([[1.1, 54, 1], [1.2, 73, 1], [1.3, 98, 1],  
           [1.4, 133, 1], [5.0, 6.5*10^6, 10^(-4)]],  
          a*exp(b*x), [x], [a, b])
```

```
[[1.992321622, 2.999602426], 0.2001899629]
```

## Example 3

We create a sample with four columns. The first column is a counter labeling the measurements. This column is of no further relevance here. The second and third column provide measured data of two variables  $x_1$  and  $x_2$ , respectively. The last column provides corresponding measurements of a dependent variable.

```
s := stats::sample([[1, 0, 0, 1.1], [2, 0, 1, 5.4],  
                  [3, 1, 1, 8.5], [4, 1, 2, 18.5],  
                  [5, 2, 1, 15.0], [6, 2, 2, 24.8]])
```

```
1 0 0 1.1  
2 0 1 5.4  
3 1 1 8.5  
4 1 2 18.5  
5 2 1 15.0  
6 2 2 24.8
```

First, we try to model the data provided by the columns 2, 3, 4 by a function that is linear in the variables  $x_1, x_2$ . We specify the data columns by a list of column indices:

```
stats::reg(s, [2, 3, 4], p1 + p2*x1 + p3*x2,  
          [x1, x2], [p1, p2, p3])
```

```
[[−0.9568181818, 4.688636364, 7.272727273], 15.23613636]
```

The quadratic deviation is rather large, indicating that a linear function is inappropriate to fit the data. Next, we extend the model and consider a polynomial fit function of degree

2. This is still a linear regression problem, because the fit parameters enter the model function linearly. We specify the data columns by a sequence of column indices:

```
stats::reg(s, 2, 3, 4,
           p1 + p2*x1 + p3*x2 + p4*x1^2 + p5*x2^2,
           [x1, x2], [p1, p2, p3, p4, p5])
```

```
[[1.1, 1.525, 1.5, 1.625, 2.8], 0.01]
```

Finally, we include a further term  $p_6*x_1*x_2$  in the model, obtaining a perfect fit:

```
stats::reg(s, 2, 3, 4,
           p1 + p2*x1 + p3*x2 + p4*x1^2 + p5*x2^2 + p6*x1*x2,
           [x1, x2], [p1, p2, p3, p4, p5, p6])
```

```
[[1.1, 1.6, 1.35, 1.7, 2.95, -0.2], 1.796307589 10-27]
```

```
delete s:
```

## Example 4

We create a sample of two columns:

```
s := stats::sample([[1, -1.44], [2, -0.82],
                   [3, 0.97], [4, 1.37]])
```

```
1  -1.44
2  -0.82
3   0.97
4   1.37
```

The data are to be modeled by a function of the form  $y = p_1 \sin(p_2 x)$ , where the first column contains measurements of  $x$  and the second column contains corresponding data for  $y$ . Note that in this example there is no need to specify column indices, because the sample contains only two columns:

```
stats::reg(s, a*sin(b*x), [x], [a, b])
```

```
[[-1.499812823, 1.281963381], 0.00001255632629]
```

Fitting a periodic function may be problematic. We provide starting values for the fit parameters and obtain a quite different set of parameters approximating the data with the same quality:

```
stats::reg(s, a*sin(b*x), [x], [a, b], StartingValues = [2, 5])  
  
[[1.499812823, 5.001221926], 0.00001255632629]
```

```
delete s:
```

## Example 5

The blood sugar level  $y$  (in mmol/L) of a diabetic is measured over a period of 10 days with 5 measurements per day at  $x_1 = 7$  (o'clock a.m.),  $x_1 = 12$  (noon),  $x_1 = 15$  (afternoon),  $x_1 = 19$  (before dinner), and  $x_1 = 23$  (bed time). These are the measurements:

```
Y:= //hour: 7    12    15    19    23  
  [ [ 7.2, 5.5, 6.8, 5.4, 6.0], // day 1  
    [ 6.3, 5.0, 5.5, 5.8, 4.9], // day 2  
    [ 6.5, 6.3, 4.8, 4.5, 5.0], // day 3  
    [ 4.3, 5.2, 4.3, 4.7, 4.0], // day 4  
    [ 7.1, 7.2, 6.7, 7.2, 5.5], // day 5  
    [ 5.8, 5.5, 4.9, 5.0, 6.2], // day 6  
    [ 6.2, 4.8, 5.0, 5.2, 5.3], // day 7  
    [ 4.8, 5.8, 5.7, 6.2, 5.0], // day 8  
    [ 5.2, 3.8, 4.8, 5.8, 4.7], // day 9  
    [ 5.8, 4.7, 5.0, 6.5, 6.3] // day 10  
  ]:
```

We have a total of 50 measurements. Each measurement is a triple  $[x_1, x_2, y]$ , where  $x_1$  is the hour of the day,  $x_2$  is the day number, and  $y$  is the blood sugar level:

```
data:= ([ [ 7, x2, Y[x2][1]],  
          [12, x2, Y[x2][2]],  
          [15, x2, Y[x2][3]],  
          [19, x2, Y[x2][4]],  
          [23, x2, Y[x2][5]]  
        ) $ x2 = 1 .. 10):
```

We model the blood sugar  $y$  as a function of the hour of the day  $x_1$  and the day number  $x_2$  (trying to detect a general tendency). We assume a periodic dependence on  $x_1$  with a period of 24 hours:

```
y := y0 + a*x2 + b*sin(2*PI/24*x1 + c):
```

A least squares fit of the given data leads to the following parameters  $y_0$ ,  $a$ ,  $b$ ,  $c$ :

```
[y0abc, residue]:= stats::reg(data, y, [x1, x2], [y0, a, b, c]):
[y0, a, b, c]:= y0abc
```

```
[5.809945498, -0.04618181818, 0.2055298076, 0.07751988162]
```

The average blood sugar level is  $y_0 = 5.8\dots$  with an improvement of  $a = -0.046\dots$  per day. The amplitude of the daily variation of  $y$  is  $b = 0.205\dots$ . We visualize the measurements  $Y$  by a `plot::Matrixplot`. The least squares fit of our model function  $y$  is added as a function graph:

```
plot(plot::Matrixplot(Y, x1 = 0..24, x2 = 1..10),
      plot::Function3d(y, x1 = 0..24, x2 = 1..10,
                      Color = RGB::Green))
```

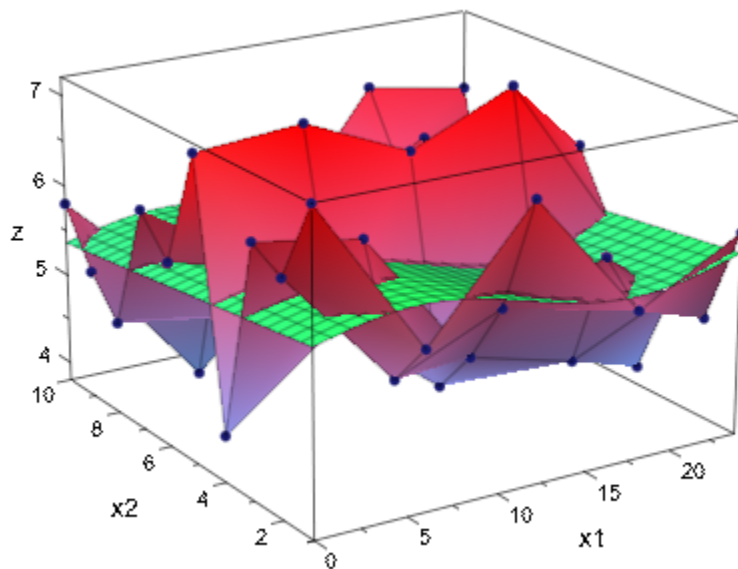

```
delete Y, data, y, y0abc, y0, a, b, c, residue:
```

## Example 6

We consider a decaying radioactive source, whose activity  $N$  (“counts”) is measured at

intervals of 1 second. The physical model for the decay is  $N(t) = \frac{N_0}{e^{t/\tau}}$ , where  $N(t)$  is the count rate at time  $t$ ,  $N_0$  is the base rate at time  $t = 0$  and  $\tau$  is the lifetime of the radioactive source. Instead of taking data from an actual physical experiment, we create artificial data with a base rate  $N_0 = 100$  and a lifetime  $\tau = 300$ :

```
T := [i $ i= 0 .. 100]:
N := [100*exp(-t/300) $ t in T]:
```

By construction, we obtain a perfect fit when estimating the parameters  $N_0$  and  $\tau$  of the model:

```
stats::reg(T, N, N0*exp(-t/tau), [t], [N0, tau]);
```

```
[100.0, 300.0], 1.133987551 10-30]
```

We perturb the data:

```
N := [stats::poissonRandom(n)() $ n in N]:
```

Since the data  $n_i$  in  $N$  are Poissonian, their standard deviation is the square root of their mean:  $\sigma(n_i) \approx \sqrt{n_i}$ . Thus, suitable weights for a least squares estimation of the

parameters are given by  $w_i = \frac{1}{\sigma(n_i)^2} = \frac{1}{n_i}$ :

```
W := [1/n $ n in N]:
```

With these weights, a least squares fit of the model parameters  $N_0$  and  $\tau$  is computed. The option `CovarianceMatrix` is used to get information on confidence intervals for the parameters:

```
[p, chisquared, C] :=
  stats::reg(T, N, W, N0*exp(-t/tau), [t], [N0, tau],
    CovarianceMatrix)
```

$$\left[ [95.43096895, 309.3571484], 87.4642626, \begin{pmatrix} 3.998386217 & -61.38541859 \\ -61.38541859 & 1302.650416 \end{pmatrix} \right]$$

The square roots of the diagonal elements of the covariance matrix provides the statistical standard deviations of the fit parameters:

```
sqrt(float(C[1,1])), sqrt(float(C[2,2]))
```

```
1.999596513, 36.0922487
```

Thus, the estimate for the base rate  $N_0$  is  $N_0 \pm \sigma(N_0) \approx 95.4 \pm 2.0$ , the estimate for the lifetime  $\tau$  is  $\tau \pm \sigma(\tau) \approx 309.4 \pm 36.1$ . The correlation matrix of the fit parameters is obtained from the covariance matrix via `stats::correlationMatrix`:

```
stats::correlationMatrix(C)
```

$$\begin{pmatrix} 1.0 & -0.8505677452 \\ -0.8505677452 & 1.0 \end{pmatrix}$$

```
delete T, N, W, p, chisquared, C:
```

## Parameters

$\mathbf{x}_1, \dots, \mathbf{x}_k, \mathbf{m}$

Numerical sample data for the independent variables. The entry  $x_{i,j}$  represents the  $i$ -th measurement of the independent variable  $x_j$ .

$\mathbf{y}_1, \dots, \mathbf{y}_k$

Numerical sample data for the dependent variable. The entry  $y_i$  represents the  $i$ -th measurement of the dependent variable.

**$w_1, \dots, w_k$** 

Weight factors: positive real numerical values. The entry  $w_i$  is used as a weight for the data  $x_{i,1}, \dots, x_{i,m}, y_i$  of the  $i$ -th measurement. If no weights are provided, then  $w_i = 1$  is used.

**f**

The model function: an arithmetical expression representing a function of the independent variables  $x_1, \dots, x_m$  and the fit parameters  $p_1, \dots, p_n$ . The expression must not contain any symbolic objects apart from  $x_1, \dots, x_m, p_1, \dots, p_n$ .

 **$x_1, \dots, x_m$** 

The independent variables: identifiers on page 7-29 or indexed identifiers on page 1-1017.

 **$p_1, \dots, p_n$** 

The fit parameters: identifiers or indexed identifiers.

 **$p_1(\theta), \dots, p_n(\theta)$** 

The user can assist the internal numerical search by providing numerical starting values  $p_i(0)$  for the fit parameters  $p_i$ . These should be reasonably close to the optimal fit values. The starting values  $p_i(0) = 1.0$  are used if no starting values are provided by the user.

**s**

A sample of domain type `stats::sample` containing the data  $x_{i,j}$  for the independent variables, the data  $y_i$  for the dependent variable and, optionally, the weights  $w_i$ .

**cy**

A positive integer representing a column index of the sample `s`. This column provides the measurements  $y_i$  for the dependent variable.

**cw**

A positive integer representing a column index of the sample `s`. This column provides the weight factors  $w_i$ .



## Options

### StartingValues

Option, specified as `StartingValues = [p1(0), ..., pn(0)]`

Positive integers representing column indices of the sample  $s$ . Column  $p_j$  provides the measurements  $x_{i,j}$  for the independent variable  $x_j$ .

If the model function depends linearly on the fit parameters  $p_j$  ("linear regression"), then the optimized parameters are the solution of a linear system of equations. In this case there is no need to provide starting values for a numerical search. In fact, initial values provided by the user are ignored.

If the model function depends non-linearly on the fit parameters  $p_j$  ("non-linear regression"), then the optimized fitting parameters are the solution of a non-linear optimization problem. There is no guarantee that the internal search for a numerical solution will succeed. It is recommended to assist the internal solver by providing reasonably good estimates for the optimal fit parameters.

### CovarianceMatrix

Changes the return value from  $[[p_1, \dots, p_n], \chi^2]$  to  $[[p_1, \dots, p_n], \chi^2, C]$ , where  $C$  is the covariance matrix of the estimators  $p_i$  given by  $C_{i,i} = \sigma(p_i)^2$  and  $C_{i,j} = \text{cov}(p_i, p_j)$  for  $i \neq j$ .

With this option, information on confidence intervals for the least squares estimators  $p_i$  are provided. In particular, the return value includes the covariance matrix  $C$  of type `Dom: :Matrix()`. This matrix provides the variances  $C_{ii} = \sigma(p_i)^2$  of the least squares estimators  $p_i$  and their covariances  $C_{ij} = \text{cov}(p_i, p_j)$ . The covariance matrix is defined via its inverse

$$\left(\frac{1}{C}\right)_{i,j} = \frac{\frac{\partial}{\partial p_j} \frac{\partial}{\partial p_i} \chi^2}{2}$$

Where

$$\chi^2(p_1, \dots, p_n) = \sum_{i=1}^k w_i |y_i - f(x_{i1}, \dots, x_{in}, p_1, \dots, p_n)|^2$$

The covariance matrix of the least squares estimators only has a statistical meaning if the stochastic variances  $\sigma(y_i)^2$  of the measurements  $y_i$  are known. These variances are to be

included in the computation by choosing the weights  $w_i = \frac{1}{\sigma(y_i)^2}$ . Cf. “Example 6” on page 30-404 (Symbolic Math Toolbox).

The function `stats::correlationMatrix` serves for converting the covariance matrix to the corresponding correlation matrix. See “Example 6” on page 30-404 (Symbolic Math Toolbox)

## Return Values

Without the option `CovarianceMatrix`, a list  $[[p_1, \dots, p_n], \chi^2]$  is returned. It contains the optimized fit parameters  $p_i$  minimizing the quadratic deviation. The minimized value of this deviation is given by  $\chi^2$ , it indicates the quality of the fit.

With the option `CovarianceMatrix`, a list  $[[p_1, \dots, p_n], \chi^2, C]$  is returned. The  $n \times n$  matrix on page 1-1340 C is the covariance matrix of the fit parameters.

All returned data are floating-point values. FAIL is returned if a least square fit of the data is not possible with the given model function or if the internal numerical search failed.

## References

P.R. Bevington and D.K. Robinson, “Data Reduction and Error Analysis for The Physical Sciences”, McGraw-Hill, New York, 1992.

## Algorithms

`stats::reg` uses a Marquardt-Levenberg gradient expansion algorithm. Searching for the minimum of  $\chi^2(p_1, \dots, p_n)$ , the algorithm does not simply follow the negative gradient, but the diagonal terms of the curvature matrix are increased by a factor that is optimized in each step of the search.

## See Also

### MuPAD Functions

stats::correlationMatrix | stats::linReg | stats::sample

## stats::row

Select and re-arrange rows of a sample

### Syntax

```
stats::row(s, r1, <r2, ...>)
```

```
stats::row(s, r1 .. r2, <r3 .. r4, ...>)
```

### Description

`stats::row(s, ..)` creates a new sample from selected rows of the sample `s`.

`stats::row` is useful for selecting rows of interest or for re-arranging rows.

The rows of `s` specified by the remaining arguments of `stats::row` are used to build a new sample. The new sample contains the rows of `s` in the order specified by the call to `stats::row`. Rows can be duplicated by specifying the row index more than once.

### Examples

#### Example 1

The following sample represents the “population” of a small town:

```
stats::sample([["1990", 10564], ["1991", 10956],  
              ["1992", 11007], ["1993", 11123],  
              ["1994", 11400], ["1995", 11645]])
```

```
"1990" 10564  
"1991" 10956  
"1992" 11007  
"1993" 11123  
"1994" 11400  
"1995" 11645
```

We are only interested in the years 1990, 1991, 1992 and 1995. We create a new sample containing the rows of interest:

```
stats::row(%, 1..3, 6)
```

```
"1990" 10564  
"1991" 10956  
"1992" 11007  
"1995" 11645
```

We reorder the sample:

```
stats::row(%, 4, 3, 2, 1)
```

```
"1995" 11645  
"1992" 11007  
"1991" 10956  
"1990" 10564
```

## Parameters

**s**

A sample of domain type `stats::sample`.

**$r_1, r_2, \dots$**

Positive integers representing row indices of the sample `s`. A range  $r_1..r_2$  represents all rows from  $r_1$  through  $r_2$ .

## Return Values

Sample of domain type `stats::sample`.

## See Also

### MuPAD Functions

`stats::col` | `stats::concatCol` | `stats::concatRow` | `stats::selectRow`

# stats::sample

Domain of statistical samples

## Syntax

```
stats::sample([[a1, 1, a1, 2, ...], [a2, 1, a2, 2, ...], ...])
```

```
stats::sample([a1, 1, a2, 1, ...])
```

## Description

*sample* represents a collection of statistical data, organized as a matrix. Usually, each row refers to an individual of the population described by the sample. Each column represents an attribute.

`stats::sample( [[a1, 1, ..., a1, n], ..., [am, 1, ..., am, n]] )` creates a sample with  $m$  rows and  $n$  columns,  $a_{i,j}$  being the entry in the  $i$ -th row,  $j$ -th column.

`stats::sample( [a1, 1, ..., am, 1] )` creates a sample with  $m$  rows and one column.

Each row  $[a_{i, 1}, \dots, a_{i, n}]$  must contain the same number of entries.

Elements of domain type `DOM_COMPLEX`, `DOM_EXPR`, `DOM_FLOAT`, `DOM_IDENT`, `DOM_INT`, or `DOM_RAT` are regarded as “data” and are stored in a sample as on input. All other types of input parameters are converted to strings (`DOM_STRING`).

If one element in a column is a string or is converted to a string, then all elements of that column are converted to strings.

This produces two kinds of columns: data columns and string columns.

## Superdomain

`Dom::BaseDomain`

## Axioms

`Ax::canonicalRep`

## Categories

`Cat::Set`

## Examples

### Example 1

A sample is created from a list of rows:

```
stats::sample([[5, a], [b, 7.534], [7/4, c+d]])
```

```
5      a
b 7.534
7/4 c + d
```

For a sample with only one column one can use a flat list instead of a list of rows:

```
stats::sample([5, 3, 8])
```

```
5
3
8
```

### Example 2

The following input creates a small sample with columns for “gender”, “age” and “height”, respectively:

```
stats::sample([["m", 26, 180], ["f", 22, 160],
               ["f", 48, 155], ["m", 30, 172]])
```

```
"m" 26 180
```



```
"f" 22 160
"f" 48 155
"m" 30 172
```

Note that all entries in a column are automatically converted to strings, if one entry of that column is a string:

```
stats::sample([[m, 26, 180], [f, 22, 160],
               ["f", 48, 155], [m, 30, 172]])
```

```
"m" 26 180
"f" 22 160
"f" 48 155
"m" 30 172
```

### Example 3

The functions `float`, `has`, `map`, `nops`, `op`, and `subsop` are overloaded to work on samples as on lists of lists:

```
s := stats::sample([[a, 1], [b, 2], [c, 3]])
```

```
a 1
b 2
c 3
```

```
float(s), has(s, a), map(s, list -> [list[1], list[2]^2]),
nops(s), subsop(s, 1 = [d, 4]), op(s, [1, 2])
```

```
a 1.0          a 1          d 4
b 2.0 , TRUE, b 4 , 3, b 2 , 1
c 3.0          c 9          c 3
```

Indexing works like on arrays:

```
s[1, 2] := x : s
```

```
a x
b 2
c 3
```

delete s:

## Example 4

The dot operator may be used to concatenate samples and lists (regarded a samples with one row):

```
s := stats::sample([[1, a], [2, b]]): s.[X, Y].s
```

```
1 a
2 b
X Y
1 a
2 b
```

delete s:

## Parameters

$a_{1, 1}, a_{1, 2}, \dots$

Arithmetical expressions or strings.

## Methods

### Mathematical Methods

**equal** — Test for equality

```
equal(s1, s2)
```

### Conversion Methods

**convert** — Convert a list to a sample

```
convert(x)
```

**convert\_to** — Convert a sample to a list of lists

convert\_to(s, T)

**expr** — Convert a sample to a list of lists of expressions

expr(s)

## Access Methods

**size** — Return the number of rows

size(s)

**col2list** — Return a particular column as a list

col2list(s, c, ...)

**append** — Append a row

append(s, row)

**\_concat** — Create a sample from the rows of several samples

\_concat(s, s1, ...)

**delCol** — Delete one or more columns

delCol(s, c)

**delRow** — Delete one or more rows

delRow(s, r)

**float** — Map the float function to all entries

float(s)

**has** — Test for the occurrence of elements

has(s, e)

If *e* is a list or a set, then this method tests, whether at least one of its elements is among the entries of *s*.

**`_index` — Return a particular entry**

`_index(s, i, j)`

Indexed calls such as `s[i, j]` call this method.

**`set_index` — Assign a new value to an entry**

`set_index(s, i, j, x)`

This method is called by indexed assignments of the form `s[i, j] := x`.

**`map` — Map a function to the rows**

`map(s, f)`

**`nops` — Number of rows**

`nops(s)`

**`op` — Get the operands (rows)**

`op(s, i)`

`op(s, [i, j])`

**`subsop` — Replace a row**

`subsop(s, i = newrow, ...)`

**`row2list` — Return a particular row as a list**

`row2list(s, r, ...)`

## Technical Methods

**`print` — Output**

`print(s)`

**fastprint — Fast output**

fastprint(s)

## stats::sample2list

Convert a sample to a list of lists

### Syntax

```
stats::sample2list(s)
```

### Description

`stats::sample2list(s)` converts the sample on page 30-413 `s` to a list of lists.

The sub-lists of the list returned by `stats::sample2list(s)` are the rows of the sample `s`.

### Examples

#### Example 1

First we create a sample from a list of lists:

```
stats::sample([[123, s, 1/2], [442, s, -1/2], [322, p, -1/2]])
```

```
123 s 1/2  
442 s -1/2  
322 p -1/2
```

The input list may be recovered by `stats::sample2list`:

```
stats::sample2list(%)
```

```
[[ [123, s, 1/2], [442, s, -1/2], [322, p, -1/2] ]]
```

## Parameters

**s**

A sample of domain type `stats::sample`.

## Return Values

List of lists.

## See Also

### **MuPAD Functions**

`stats::unzipCol` | `stats::zipCol`

## stats::selectRow

Select rows of a sample

### Syntax

```
stats::selectRow(s, c, x, <Not>)
```

```
stats::selectRow(s, [c1, c2, ...], [x1, x2, ...], <Not>)
```

### Description

`stats::selectRow(s, ...)` selects rows of the sample `s` having specific entries in specific places.

`stats::selectRow(s, c, x)` returns a sample consisting of all rows in `s`, which contain the data element `x` at the position `c`.

`stats::selectRow(s, [c1, c2, ...], [x1, x2, ...])` returns a sample consisting of all rows in `s`, which contain the data element `x1` at the position `c1` *and* `x2` at the position `c2` etc. There must be as many positions `c1, c2, ...` as data elements `x1, x2, ...`

### Examples

#### Example 1

We create a sample with two columns:

```
stats::sample([[a, 5], [c, 1], [a, 2], [b, 3]])
```

```
a 5  
c 1  
a 2  
b 3
```

We select all rows with `a` as their first entry:



```
stats::selectRow(%, 1, a)
```

```
a 5
a 2
```

## Example 2

We create a sample containing income and costs in the years 1997 and 1998:

```
stats::sample([[123, "costs", "97"], [442, "income", "98"],
               [11, "costs", "98"], [623, "income", "97"]])
```

```
123 "costs" "97"
442 "income" "98"
 11 "costs" "98"
623 "income" "97"
```

We select the row which has "income" in the second and "97" in the third column:

```
stats::selectRow(%, [2, 3], ["income", "97"])
```

```
623 "income" "97"
```

We select the remaining rows:

```
stats::selectRow(%2, [2, 3], ["income", "97"], Not)
```

```
123 "costs" "97"
442 "income" "98"
 11 "costs" "98"
```

## Parameters

**s**

A sample of domain type `stats::sample`.

**c**, **c<sub>1</sub>**, **c<sub>2</sub>**, ...

Integers representing column indices of the sample **s**.

**x**, **x<sub>1</sub>**, **x<sub>2</sub>**, ...

Arithmetical expressions.

## Options

**Not**

Causes `stats::selectRow` to select those rows which do *not* have the specified entries.

## Return Values

Sample of domain type `stats::sample`.

## See Also

**MuPAD Functions**

`stats::row`

# stats::sortSample

Sort the rows of a sample

## Syntax

```
stats::sortSample(s)
```

```
stats::sortSample(s, c1, c2, ...)
```

```
stats::sortSample(s, [c1, c2, ...])
```

## Description

`stats::sortSample(s, ...)` sorts the rows of the sample `s`.

The sorting of rows only uses the entries of the specified columns. First, rows are sorted according to the elements of the first specified column. Those rows with identical elements in the first specified column are then ordered according to the elements in the second specified column etc.

If no columns are specified, then column 1 is used for sorting. In case of a tie, column 2 is used etc.

Numbers are sorted numerically, strings are sorted lexicographically. Identifiers are sorted according to the strategy used by the MuPAD `sort` command. Numbers come first, identifiers second.

## Examples

### Example 1

We create a sample with one column and sort it:

```
stats::sortSample(stats::sample([x, g2, 3, g1, 8/5, 2]))
```

```
8/5
 2
 3
g1
g2
x
```

## Example 2

We create a sample with two columns:

```
stats::sample([[b, 2], [a, 5], [a, 2], [c, 1], [b, 3]])
```

```
b 2
a 5
a 2
c 1
b 3
```

Note the different sorting priorities specified by the column indices:

```
stats::sortSample(%, 1), stats::sortSample(%, 2),
stats::sortSample(%, 1, 2), stats::sortSample(%, 2, 1)
```

```
a 2   c 1   a 2   c 1
a 5   a 2   a 5   a 2
b 3   , b 2 , b 2 , b 2
b 2   b 3   b 3   b 3
c 1   a 5   c 1   a 5
```

## Example 3

We create a sample containing income and costs in the years 1997 and 1998:

```
stats::sample([[123, "costs", "97"], [720, "income", "98"],
               [623, "income", "97"], [150, "costs", "98"]])
```

```
123 "costs" "97"
720 "income" "98"
```

```
623 "income" "97"  
150 "costs"  "98"
```

We sort according to the year (third column):

```
stats::sortSample(%, 3)
```

```
623 "income" "97"  
123 "costs"  "97"  
150 "costs"  "98"  
720 "income" "98"
```

We sort with priority on the year. Items of the same year are then sorted lexicographically (“costs” before “income”):

```
stats::sortSample(%2, 3, 2)
```

```
123 "costs"  "97"  
623 "income" "97"  
150 "costs"  "98"  
720 "income" "98"
```

## Parameters

**s**

A sample of domain type `stats::sample`.

**c<sub>1</sub>, c<sub>2</sub>, ...**

Integers representing column indices of the sample `s`.

## Return Values

Sample of domain type `stats::sample`.

## See Also

### **MuPAD Functions**

`stats::selectRow`

## stats::stdev

Standard deviation of a data sample

### Syntax

```
stats::stdev(x1, x2, ..., <Sample | Population>)
```

```
stats::stdev([x1, x2, ...], <Sample | Population>)
```

```
stats::stdev(s, <c>, <Sample | Population>)
```

### Description

stats::stdev( x<sub>1</sub>, x<sub>2</sub>, ..., x<sub>n</sub>) returns the standard deviation

$$\sqrt{\frac{1}{n-1} \left( \sum_{i=1}^n (x_i - \bar{x})^2 \right)},$$

where  $\bar{x}$  is the arithmetic mean of the data  $x_i$ .

stats::stdev( x<sub>1</sub>, x<sub>2</sub>, ..., x<sub>n</sub>, Population) returns

$$\sqrt{\frac{1}{n} \left( \sum_{i=1}^n (x_i - \bar{x})^2 \right)}.$$

The standard deviation is the square root of the variance on page 30-480.

The column index `c` is optional, if the data are given by a `stats::sample` object containing only one non-string column. Cf. “Example 3” on page 30-430 (Symbolic Math Toolbox).

External statistical data stored in an ASCII file can be imported into a MuPAD session via `import::readdata`. In particular, see Example 1 of the corresponding help page on page 13-11.

## Examples

### Example 1

We calculate the standard deviation of three values:

```
stats::stdev(2, 3, 5)
```

$$\frac{\sqrt{3} \sqrt{7}}{3}$$

Alternatively, the data may be passed as a list:

```
stats::stdev([2, 3, 5])
```

$$\frac{\sqrt{3} \sqrt{7}}{3}$$

### Example 2

We create a sample:

```
stats::sample([[a1, b1, c1], [a2, b2, c2]])
```

```
a1 b1 c1  
a2 b2 c2
```

The standard deviation of the second column is:

```
expand(stats::stdev(%, 2))
```

$$\sqrt{2} \sqrt{\frac{b1^2}{4} - \frac{b1 b2}{2} + \frac{b2^2}{4}}$$

### Example 3

We create a sample consisting of one string column and one non-string column:



```
stats::sample(["1996", 1242], ["1997", 1353], ["1998", 1142])
```

```
"1996" 1242  
"1997" 1353  
"1998" 1142
```

We compute the standard deviation of the second column. In this case this column does not have to be specified, since it is the only non-string column:

```
float(stats::stdev(%))
```

```
105.5477775
```

We repeat the computation with the option Population:

```
float(stats::stdev(%2, Population))
```

```
86.17939945
```

## Parameters

$x_1, x_2, \dots$

The statistical data: arithmetical expressions (Symbolic Math Toolbox)

**s**

A sample of domain type stats::sample

**c**

An integer representing a column index of the sample s. This column provides the data  $x_1, x_2$  etc.

## Options

### Population, Sample

With `Sample`, the data are regarded as a “sample”, not as a full population. The default is `Sample`.

## Return Values

Arithmetical expression.

## See Also

### MuPAD Functions

`stats::geometricMean` | `stats::harmonicMean` | `stats::mean` | `stats::median` |  
`stats::modal` | `stats::quadraticMean` | `stats::variance`

## stats::swGOF

The Shapiro-Wilk goodness-of-fit test for normality

### Syntax

```
stats::swGOF(x1, x2, ...)
```

```
stats::swGOF([x1, x2, ...])
```

```
stats::swGOF(s, <c>)
```

### Description

`stats::swGOF([x1, x2, ...])` applies the Shapiro-Wilk goodness-of-fit test for the null hypothesis: “the data  $x_1, x_2, \dots$  are normally distributed (with unknown mean and variance)”. The sample size must not be larger than 5000 and not smaller than 3.

External statistical data stored in an ASCII file can be imported into a MuPAD session via `import::readdata`. In particular, see Example 1 of the corresponding help page on page 13-11.

An error is raised by `stats::swGOF` if any of the data cannot be converted to a real floating-point number or if the sample size is too large or too small.

Let  $y_1, \dots, y_n$  be the input data  $x_1, \dots, x_n$  arranged in ascending order. `stats::swGOF` returns the list [PValue =  $p$ , StatValue =  $w$ ] containing the following information:

- $w$  is the attained value of the Shapiro-Wilk statistic

$$W = \frac{\left(\sum_{i=1}^n a_i y_i\right)^2}{n S^2} = \frac{\left(\sum_{i=1}^{\lfloor \frac{n}{2} \rfloor} a_{n+1-i} (y_{n+1-i} - y_i)\right)^2}{n S^2}$$

Here, the  $a_i$  are the Shapiro-Wilk coefficients, and  $S^2$  is the statistical variance on page 30-480 of the sample.

- $p$  is the observed significance level of the Shapiro-Wilk statistic  $W$ .

The observed significance level `PValue = p` returned by `stats::swGOF` has to be interpreted in the following way: If  $p$  is smaller than a given significance level  $\alpha < 1$ , the null hypothesis may be rejected at level  $\alpha$ . If  $p$  is larger than  $\alpha$ , the null hypothesis should not be rejected at level  $\alpha$ .

## Environment Interactions

The function is sensitive to the environment variable `DIGITS` which determines the numerical working precision.

## Examples

### Example 1

We test a list of random data that purport to be a sample of normally distributed numbers:

```
f := stats::normalRandom(0, 1, Seed = 123):  
data := [f() $ i = 1..400]:  
stats::swGOF(data)
```

```
[PValue = 0.4902802259, StatValue = 0.9963301659]
```

The observed significance level `0.490...` is not small. Consequently, one should not reject the null hypothesis that the data are normally distributed.

Next, we dote the data with some uniformly continuous deviates on page 1-807:

```
impuredata := data . [frandom() $ i = 1..101]:  
stats::swGOF(impuredata)
```

```
[PValue = 0.00001713272044, StatValue = 0.9833725964]
```

The dotted data may be rejected as a sample of normal deviates at significance levels as small as `0.000017...`

```
delete f, data, impuredata:
```

## Example 2

We create a sample on page 30-413 consisting of one string column and two non-string columns:

```
s := stats::sample(
  [{"1996", 1242, PI - 1/2},
   {"1997", 1353, PI + 0.3},
   {"1998", 1142, PI + 0.5},
   {"1999", 1201, PI - 1},
   {"2001", 1201, PI}
])
```

```
"1996" 1242 PI - 1/2
"1997" 1353 PI + 0.3
"1998" 1142 PI + 0.5
"1999" 1201 PI - 1
"2001" 1201 PI
```

We check whether the data of the third column are normally distributed:

```
stats::swGOF(s, 3)
```

```
[PValue = 0.7314967372, StatValue = 0.9492034961]
```

The observed significance level returned by the test is not small: the test does not indicate that the data are not normally distributed.

```
delete s:
```

## Parameters

$x_1, x_2, \dots$

The statistical data: real numerical values

**s**

A sample of domain type `stats::sample`

**c**

An integer representing a column index of the sample `s`. This column provides the data  $x_1$ ,  $x_2$  etc. There is no need to specify a column number `c` if the sample has only one column.

## Return Values

List of two equations [`PValue = p`, `StatValue = w`] with floating-point values `p` and `w`. See the `Details' section below for the interpretation of these values.

## Algorithms

The implemented algorithm for the computation of the Shapiro-Wilk coefficients, the Shapiro-Wilk statistic and the observed significance level is based on: Patrick Royston, "Algorithm AS R94", Applied Statistics, Vol.44, No.4 (1995).

Following Royston, the Shapiro-Wilk coefficients  $a_i$  are computed by an approximation of

$$a = \frac{M}{V \left( \left( \frac{M^T}{V} \right) \left( \frac{M}{V} \right) \right)}$$

where  $M$  denotes the expected values of standard normal order statistic for a sample,  $V$  is the corresponding covariance matrix, and  $M^T$  is the transpose of  $M$ .

## See Also

### MuPAD Functions

`stats::csGOFT` | `stats::ksGOFT` | `stats::tTest`

# stats::tabulate

Statistics of duplicate rows in a sample

## Syntax

```
stats::tabulate(s)
```

```
stats::tabulate(s, c1, c2, ..., <f>)
```

```
stats::tabulate(s, c1 .. c2, c3 .. c4, ..., <f>)
```

```
stats::tabulate(s, [c1, f1], [c2, f2], ...)
```

```
stats::tabulate(s, [c1, c2, ..., f1], [c3, c4, ..., f2], ...)
```

## Description

`stats::tabulate(s)` eliminates duplicate rows in the sample `s` and appends a column containing the multiplicities.

`stats::tabulate( s, c1, c2, ..., f )` combines all rows that are identical except for entries in the specified columns `c1, c2` etc. The function `f` is applied to these columns, its result replaces the values in these columns.

`stats::tabulate( s, [c1, f1], [c2, f2], ... )` combines all rows that are identical except for entries in the columns `c1, c2` etc. The functions `f1, f2` etc. are applied to these columns, the results replace the values in these columns.

`stats::tabulate` regards rows as duplicates if they have identical entries in the columns that are *not* specified.

With `stats::tabulate( s, c1, c2, ..., f )` the function `f` is applied to the entries of the duplicate rows in the specified columns. Duplicates are eliminated and replaced by a single instance of the row, the result of `f` is inserted into the corresponding columns.

The function `f` must accept as many parameters as there are duplicates. Typical applications involve functions such as `stats::mean` which accept arbitrarily many arguments.

E.g., with `stats::mean` duplicate rows are replaced by a single row, in which the entries of the columns  $c_1, c_2$  etc. are replaced by the mean values of the corresponding entries of the duplicates.

If no function `f` is specified, then the default function `_plus` is used.

If column indices are specified more than once, extra columns with the result of the specified function are inserted into the sample.

Consecutive columns may be specified by ranges on page 1-16. E.g., the call `stats::tabulate(s, c[1]..c[2], dots, f)` is a short hand notation for `stats::tabulate(s, c_1, c_1 + 1, ..., c_2, ..., f)`.

With `stats::tabulate(s, [c1, f1], [c2, f2], ...)` pairs of columns and corresponding procedures are specified. Again, rows are regarded as duplicates if they have identical entries in the columns that are *not* specified. Duplicates are eliminated and replaced by a single instance of the row, the result of  $f_1$  is inserted in column  $c_1$ , the result of  $f_2$  is inserted in column  $c_2$  etc.

If column indices are specified more than once, then extra columns with the result of the specified functions are inserted into the sample.

With `stats::tabulate(s, [c1, c2, ..., f1], ...)` it is possible to apply functions that act on several columns. The procedure  $f_1$  has to accept a sequence of lists (each representing a column). The specified columns are replaced by a single column containing the result of  $f_1$ . If column indices are specified more than once, then extra columns with the result of the specified function(s) are inserted into the sample. See “Example 2” on page 30-439 (Symbolic Math Toolbox) and “Example 3” on page 30-440 (Symbolic Math Toolbox).

## Examples

### Example 1

We create a sample:

```
s := stats::sample([[a, A, 1], [a, A, 1], [a, A, 2],  
                  [b, B, 5], [b, B, 10]])
```

```
a  A  1
```



```
a A 1
a A 2
b B 5
b B 10
```

Duplicate rows of the sample are counted. There are four unique rows, one occurring twice:

```
stats::tabulate(s)
```

```
a A 1 2
a A 2 1
b B 5 1
b B 10 1
```

In the following call, rows are regarded as duplicates if the entries in the first two columns coincide. We compute the mean value of the third entry of the duplicates:

```
stats::tabulate(s, 3, stats::mean)
```

```
a A 4/3
b B 15/2
```

We compute both the mean and the standard deviation of the data in the third column for the sub-samples labeled `a A' and `b B' by the first two columns:

```
stats::tabulate(s, [3, stats::mean], [3, stats::stdev])
```

```
a A 4/3 3^(1/2)/3
b B 15/2 (5*2^(1/2))/2
```

```
delete s:
```

## Example 2

We create a sample containing columns for “gender”, “age” and “size”:

```
s := stats::sample(["f", 25, 166], ["m", 30, 180],
                  ["f", 54, 160], ["m", 40, 170],
                  ["f", 34, 170], ["m", 20, 172]])
```

```
"f" 25 166
```

```
"m" 30 180
"f" 54 160
"m" 40 170
"f" 34 170
"m" 20 172
```

We use `stats::mean` on the second and third column to calculate the average “age” and “size” of each gender:

```
stats::tabulate(s, 2..3, float@stats::mean)
```

```
"f" 37.66666667 165.3333333
"m"          30.0          174.0
```

With the next call both the mean and the standard deviation of “age” and “size” for each gender are inserted into the sample.

```
stats::tabulate(s,
  [2, float@stats::mean], [2, float@stats::stdev],
  [3, float@stats::mean], [3, float@stats::stdev])
```

```
"f" 37.66666667 14.84362939 165.3333333 5.033222957
"m"          30.0          10.0          174.0 5.291502622
```

We compute the Bravais-Pearson correlation coefficient between “age” and “size” for each gender:

```
stats::tabulate(s, [2, 3, float@stats::correlation])
```

```
"f" -0.7540135991
"m" -0.1889822365
```

```
delete s:
```

### Example 3

We create a sample:

```
s := stats::sample([[a, x1, 1, 2], [b, x2, 2, 4],
                   [b, x1, 2, 4], [e, x2, 3, 5.5]])
```

```
a x1 1 2
```

```
b x2 2 4
b x1 2 4
e x2 3 5.5
```

We regard rows with the same entry in the second column as “of the same kind”. We tabulate the sample using different functions on the remaining columns:

```
stats::tabulate(s, [1, _plus], [3, _mult], [4, stats::mean])
```

```
a + b x1 2 3
b + e x2 6 4.75
```

One can apply customized procedures. In the following we define the procedure `plussmult`, which sums up the elements of two lists (representing columns) and then multiplies the sums.

```
plussmult := proc(x, y) begin _plus(op(x))*_plus(op(y)) end_proc:
```

This procedure is then used to combine the first and the third column. Simultaneously, the mean and the standard deviation of the fourth column is inserted into the sample.

```
stats::tabulate(s, [1, 3, plussmult], [4, stats::mean],
                [4, stats::stdev])
```

```
3*a + 3*b x1 3 2^(1/2)
5*b + 5*e x2 4.75 1.060660172
```

```
delete plussmult, s:
```

## Parameters

**s**

A sample of domain type `stats::sample`

**c<sub>1</sub>, c<sub>2</sub>, ...**

Integers representing column indices of the sample `s`

**f, f<sub>1</sub>, f<sub>2</sub>, ...**

Procedures

## **Return Values**

Sample of domain type `stats::sample`.

## **See Also**

### **MuPAD Functions**

`stats::calc`

## stats::tCDF

Cumulative distribution function of Student's t-distribution

### Syntax

`stats::tCDF(a)`

### Description

`stats::tCDF(a)` returns a procedure representing the cumulative distribution function

$$x \rightarrow \frac{\Gamma\left(\frac{a+1}{2}\right)}{\Gamma\left(\frac{a}{2}\right) \sqrt{a} \pi} \int_{-\infty}^x \frac{1}{\left(1 + \frac{t^2}{a}\right)^{\frac{a+1}{2}}} dt$$

of Student's t-distribution with shape parameter ('degrees of freedom')  $a > 0$ .

The procedure `f := stats::tCDF(a)` can be called in the form `f(x)` with an arithmetical expression  $x$ . The return value of `f(x)` is either a floating-point number or a symbolic expression:

If  $a$  can be converted to a positive floating point number  $x$  is a real number, the return value `f(x)` is a floating-point number.

`f(infinity)` produces `0.0`; `f(-infinity)` produces `1.0`.

In all other cases, `f(x)` returns the symbolic call `stats::tCDF(a)(x)`.

The procedure `f := stats::tCDF(a)` can also be called in the form `f(x, Symbolic)` with arithmetical expressions  $x$ .

If  $a$  is a positive integer, explicit symbolic expressions in  $x$  are returned. Otherwise, the function behaves as if called without the option `Symbolic`. Cf. "Example 3" on page 30-445 (Symbolic Math Toolbox).

Numerical values of  $a$  are only accepted if they are positive.

## Environment Interactions

The function is sensitive to the environment variable DIGITS which determines the numerical working precision.

## Examples

### Example 1

We evaluate the cumulative distribution function with  $a = \frac{3}{4}$  at various points:

```
f := stats::tCDF(3/4):  
f(-infinity), f(-4), f(0), f(1/2), f(0.75), f(PI), f(infinity)  
  
0.0, 0.1085580939, 0.5, 0.6374082038, 0.689341961, 0.8707365121, 1.0
```

Nonpositive numerical values of the shape parameter lead to an error:

```
stats::tCDF(-1)(0.75)  
  
Error: Shape parameter must be positive. [stats::tCDF]  
delete f:
```

### Example 2

We use symbolic arguments:

```
f := stats::tCDF(a): f(x), f(1/3), f(0.4)  
  
stats::tCDF(a)(x), stats::tCDF(a)( $\frac{1}{3}$ ), stats::tCDF(a)(0.4)
```

When a positive real number is assigned to  $a$ , the call  $f(x)$  returns a floating-point number if  $x$  is numerical:

```
a := sqrt(10): f(PI)
```

```
0.9759846335
```

```
delete f, a:
```

### Example 3

We demonstrate the option `Symbolic`. Without this option, the CDF function only produces explicit results if both  $a$  and  $x$  are numerical values:

```
stats::tCDF(3)(x)
```

```
stats::tCDF(3)(x)
```

If the shape parameter is a positive integer, an explicit symbolic representation of the  $t$ -distribution exists for any  $x$ :

```
f := stats::tCDF(3): f(x, Symbolic)
```

$$\frac{\arctan\left(\frac{\sqrt{3}x}{3}\right)}{\pi} + \frac{\sqrt{3}x}{3\left(\frac{\pi x^2}{3} + \pi\right)} + \frac{1}{2}$$

No internal floating-point conversions occur even if all input parameters are exact numerical values:

```
f(sqrt(2), Symbolic) = f(sqrt(2))
```

$$\frac{\arctan\left(\frac{\sqrt{2}\sqrt{3}}{3}\right)}{\pi} + \frac{\sqrt{2}\sqrt{3}}{5\pi} + \frac{1}{2} = 0.8738922518$$

If the shape parameter is not a positive integer, the option `Symbolic` has no effect. The function  $f$  behaves as if called without this option:

```
f := stats::tCDF(PI):  
f(sqrt(2), Symbolic) = f(sqrt(2))
```

```
0.8758345238 = 0.8758345238
```

```
f := stats::tCDF(PI):  
f(x, Symbolic)
```

```
stats::tCDF( $\pi$ )(x, Symbolic)
```

```
delete f:
```

## Parameters

**a**

The shape parameter: an arithmetical expression (Symbolic Math Toolbox) representing a positive real value

## Return Values

procedure on page 1-1654.

## See Also

### MuPAD Functions

stats::tPDF | stats::tQuantile | stats::tRandom



## stats::tPDF

Probability density function of Student's t-distribution

### Syntax

stats::tPDF(a)

### Description

stats::tPDF(a) returns a procedure representing the probability density function

$$x \rightarrow \frac{\frac{\Gamma\left(\frac{a+1}{2}\right)}{\Gamma\left(\frac{a}{2}\right) \sqrt{a\pi}}}{\left(\frac{x^2}{a} + 1\right)^{\frac{a}{2} + \frac{1}{2}}}$$

of Student's t-distribution with shape parameter ('degrees of freedom')  $a > 0$ .

The procedure `f := stats::tPDF(a)` can be called in the form `f(x)` with an arithmetical expression `x`. The return value of `f(x)` is either a floating-point number or a symbolic expression:

If `x` is a floating-point number and `a` can be converted to a floating-point number, then `f(x)` returns a floating-point number.

`f(infinity)` and `f(-infinity)` produce the result `0.0`.

In all other cases, the expression  $\frac{\Gamma\left(\frac{a+1}{2}\right)}{\Gamma\left(\frac{a}{2}\right) \sqrt{a} \sqrt{\pi}}$  is returned.

If floating-point results are desired, call `f(x)` with a floating-point value `x`.

Numerical values for  $a$  are only accepted if they are real and positive.

## Examples

### Example 1

We evaluate the probability density function with  $a = \frac{3}{4}$  at various points:

```
f := stats::tPDF(3/4):
f(-infinity), f(-PI), f(1/2), f(0.5), f(3), f(infinity)
```

$$0.0, \frac{2\sqrt{3}\Gamma(\frac{7}{8})}{3\sqrt{\pi}\Gamma(\frac{3}{8})\left(\frac{4\pi^2}{3}+1\right)^{7/8}}, \frac{3^{3/8}4^{1/8}\Gamma(\frac{7}{8})}{2\sqrt{\pi}\Gamma(\frac{3}{8})}, 0.232826673, \frac{2\sqrt{3}13^{1/8}\Gamma(\frac{7}{8})}{39\sqrt{\pi}\Gamma(\frac{3}{8})}, 0.0$$

```
delete f:
```

### Example 2

We use symbolic arguments:

```
f := stats::tPDF(a): f(x), f(0.3)
```

$$\frac{\Gamma(\frac{a}{2}+\frac{1}{2})}{\sqrt{a}\sqrt{\pi}\Gamma(\frac{a}{2})\left(\frac{x^2}{a}+1\right)^{\frac{a}{2}+\frac{1}{2}}}, \frac{0.5641895835\Gamma(\frac{a}{2}+\frac{1}{2})}{\sqrt{a}\Gamma(\frac{a}{2})\left(\frac{0.09}{a}+1\right)^{\frac{a}{2}+\frac{1}{2}}}$$

When numerical values are assigned to  $a$ , the function  $f$  starts to produce floating-point values for floating-point arguments:

```
a := PI: f(0.3)
```

```
0.347916859
```

```
delete f, a:
```

## Parameters

**a**

The shape parameter: an arithmetical expression (Symbolic Math Toolbox) representing a positive real value

## Return Values

procedure on page 1-1654.

## See Also

### **MuPAD Functions**

stats::tCDF | stats::tQuantile | stats::tRandom

## stats::tQuantile

Quantile function of Student's t-distribution

### Syntax

```
stats::tQuantile(a)
```

### Description

`stats::tQuantile(a)` returns a procedure representing the quantile function (inverse) of the cumulative distribution function `stats::tCDF(a)`. For  $0 \leq x \leq 1$ , the solution of  $stats::tCDF(a)(y) = x$  is given by  $y = stats::tQuantile(a)(x)$ .

The procedure `f := stats::tQuantile(a)` can be called in the form `f(x)` with an arithmetical expression `x`. The return value of `f(x)` is either a floating-point number, `±infinity`, or a symbolic expression:

If `x` is a real number between 0 and 1 and the shape parameter `a` can be converted to a positive real floating-point number, then `f(x)` returns a real floating-point number approximating the solution `y` of  $stats::tCDF(a)(y) = x$ .

The calls `f(1/2)` and `f(0.5)` produce `0.0` for all values of `a`.

The calls `f(0)` and `f(0.0)` produce `-infinity` for all values of `a`.

The calls `f(1)` and `f(1.0)` produce `infinity` for all values of `a`.

In all other cases, `f(x)` returns the symbolic call `stats::tQuantile(a)(x)`.

Numerical values of `x` are only accepted if  $0 \leq x \leq 1$ .

Numerical values of the shape parameter `a` are only accepted if they are real and positive.

## Environment Interactions

The function is sensitive to the environment variable DIGITS which determines the numerical working precision.

## Examples

### Example 1

We evaluate the quantile function with  $a = \pi$  at various points:

```
f := stats::tQuantile(PI):
f(0), f(1/10), f(0.5), f(1 - 10^(-10)), f(1)
```

```
−∞, −1.618021174, 0.0, 1639.390923, ∞
```

The value  $f(x)$  satisfies  $\text{stats::tCDF}(PI)(f(x)) = x$ :

```
stats::tCDF(PI)(f(0.987654))
```

```
0.987654
```

```
delete f:
```

### Example 2

We use symbolic arguments:

```
f := stats::tQuantile(a): f(x), f(9/10)
```

```
stats::tQuantile(a)(x), stats::tQuantile(a)( $\frac{9}{10}$ )
```

When a positive real value is assigned to the shape parameter  $a$ , the function  $f$  starts to produce floating-point values:

```
a := 17: f(0.999), f(1 - sqrt(2)/10^5)
```

3.64576738, 5.65913443

Numerical values for  $x$  are only accepted if  $0 \leq x \leq 1$ :

`f(0.5)`

0.0

`f(2)`

Error: Argument  $x$  must be between 0 and 1. [f]

delete f, a:

## Parameters

**a**

The shape parameter: an arithmetical expression (Symbolic Math Toolbox) representing a positive real value

## Return Values

procedure on page 1-1654.

## See Also

### MuPAD Functions

`stats::tCDF` | `stats::tPDF` | `stats::tRandom`

## stats::tRandom

Generate a random number generator for Student deviates (t-deviates)

### Syntax

```
stats::tRandom(a, <Seed = s>)
```

### Description

`stats::tRandom(a)` returns a procedure that produces  $t$  on page 30-443-deviates (random numbers) with shape parameter ('degrees of freedom')  $a > 0$ .

The procedure `f := stats::tRandom(a)` can be called in the form `f()`. The return value of `f()` is either a floating-point number or a symbolic expression:

If  $a$  can be converted to a positive floating point number, then `f()` returns a real floating point number.

In all other cases, `stats::tRandom(a)` is returned symbolically.

Numerical values of  $a$  are only accepted if they are real and positive.

The values  $X = f()$  are distributed randomly according to the cumulative distribution function of the  $t$ -distribution with shape parameter  $a$ . For any real  $x$ , the probability that  $X \leq x$  is given by

$$\frac{\Gamma\left(\frac{a+1}{2}\right)}{\Gamma\left(\frac{a}{2}\right) \sqrt{a\pi}} \int_{-\infty}^x \frac{1}{\left(1 + \frac{t^2}{a}\right)^{\frac{a+1}{2}}} dt$$

Without the option `Seed = s`, an initial seed is chosen internally. This initial seed is set to a default value when MuPAD is started. Thus, each time MuPAD is started or re-initialized with the `reset` function, random generators produce the same sequences of numbers.

**Note** In contrast to the function `random`, the generators produced by `stats::tRandom` do not react to the environment variable `SEED`.

---

For efficiency, it is recommended to produce sequences of  $K$  random numbers via

```
f := stats::tRandom(a): f() $k = 1..K;
```

rather than by

```
stats::tRandom(a)() $k = 1..K;
```

The latter call produces a sequence of generators each of which is called once. Also note that

```
stats::tRandom(a, Seed = n)() $k = 1..K;
```

does not produce a random sequence, because a sequence of freshly initialized generators would be created each of them producing the same number.

## Environment Interactions

The function is sensitive to the environment variable `DIGITS` which determines the numerical working precision.

## Examples

### Example 1

We generate  $t$ -deviates with shape parameter  $a = 23$ :

```
f := stats::tRandom(23): f() $ k = 1..4
```

```
      -0.4417960021, 0.8951424894, 1.291568047, -0.8938637441
```

```
delete f:
```



## Example 2

With symbolic parameters, no random floating-point numbers can be produced:

```
f := stats::tRandom(a): f()
```

```
stats::tRandom(a)()
```

When the shape parameter  $a$  evaluates to a positive real number,  $f$  starts to produce random floating-point numbers:

```
a := sqrt(99): f() $ k = 1..4
```

```
0.2115095721, 0.3326980658, 0.6483250281, 4.341741815
```

```
delete f, a:
```

## Example 3

We use the option `Seed = s` to reproduce a sequence of random numbers:

```
f := stats::tRandom(PI, Seed = 1): f() $ k = 1..4
```

```
0.006866430292, -1.483500533, -0.6688788771, 0.4017860587
```

```
g := stats::tRandom(PI, Seed = 1): g() $ k = 1..4
```

```
0.006866430292, -1.483500533, -0.6688788771, 0.4017860587
```

```
f() = g(), f() = g()
```

```
0.03860593782 = 0.03860593782, -1.259521158 = -1.259521158
```

```
delete f, g:
```

## Parameters

**a**

The shape parameter: an arithmetical expression (Symbolic Math Toolbox) representing a positive real value

## Options

**Seed**

Option, specified as `Seed = s`

Initializes the random generator with the integer seed `s`. `s` can also be the option `CurrentTime`, to make the seed depend on the current time.

This option serves for generating generators that return predictable sequences of pseudo-random numbers. The generator is initialized with the seed `s` which may be an arbitrary integer. Several generators with the same initial seed produce the same sequence of numbers.

When this option is used, the shape parameter `a` must be convertible to a positive floating-point number at the time when the random generator is generated.

## Return Values

procedure on page 1-1654.

## Algorithms

The implemented algorithm for the computation of the t-deviates uses a gamma on page 30-236 deviate `X` with shape parameter `a/2` and a normal on page 30-373 deviate `Y` to arrive at a t-deviate `X/sqrt(Y/a)`. For more information see: D. Knuth, *Seminumerical Algorithms* (1998), Vol. 2, p. 135.

## See Also

### MuPAD Functions

stats::tCDF | stats::tPDF | stats::tQuantile

## stats::tTest

T-test for a mean

### Syntax

```
stats::tTest(x1, x2, ..., m, <Normal>)
```

```
stats::tTest([x1, x2, ...], m, <Normal>)
```

```
stats::tTest(s, <c>, m, <Normal>)
```

### Description

`stats::tTest( [x1, x2, ...], m )` tests the null hypothesis: “the true mean of the data  $x_i$  is larger than  $m$ ”.

`stats::tTest` accepts numerical data as well as symbolic data.

If all data are real floating-point numbers, the returned values `p` and `t` are floating-point numbers.

If `m` is a floating-point number, the sample data are converted to floating-point numbers automatically.

For a sample  $x_1, x_2, \dots$  of size  $n$ , `stats::tTest` computes  $t = \sqrt{\frac{n}{v}}(X - m)$ , where

$$X = \frac{1}{n} \left( \sum_{i=1}^n x_i \right)$$

is the empirical mean of the data and

$$v = \frac{1}{n-1} \left( \sum_{i=1}^n (x_i - X)^2 \right)$$

is the empirical variance.

`stats::tTest(data, m)` returns the list [PValue =  $p$ , StatValue =  $t$ ], where the observed significance level  $p$  is computed as  $p = \text{stats::tCDF}(n - 1)(t)$ .

`stats::tTest(data, m, Normal)` returns the list [PValue =  $p$ , StatValue =  $t$ ], where the observed significance level  $p$  is computed as  $p = \text{stats::normalCDF}(\theta, 1)(t)$ . For large  $n$ , this is an approximation of  $\text{stats::tCDF}(n - 1)(t)$ .

Intuitively,  $p$  corresponds to the “probability” that the true mean of the data (the expectation value of the underlying distribution) is larger than  $m$ .

The most relevant information returned by `stats::tTest` is the observed significance level PValue =  $p$ . It has to be interpreted in the following way:

The t-test may be used as a one-tailed test of the null hypothesis: “the true mean of the data is larger than  $m$ ”. In this case, the null hypothesis may be rejected at level  $\alpha$  if the observed significance level  $p$  satisfies  $p < \alpha$ .

Alternatively, the t-test may also be used as a one-tailed test of the null hypothesis: “the true mean of the data is smaller than  $m$ ”. In this case, the null hypothesis may be rejected at level  $\alpha$  if the observed “significance level”  $p$  satisfies  $p > 1 - \alpha$ .

Alternatively, the t-test may also be used as a two-tailed test of the null hypothesis: “the true mean of the data is  $m$ ”. If the observed “significance level”  $p$  returned by

`stats::tTest` satisfies either  $p < \frac{\alpha}{2}$  or  $p > 1 - \frac{\alpha}{2}$  for some given level  $0 < \alpha < 1$ , this null hypothesis may be rejected at level  $\alpha$ .

External statistical data stored in an ASCII file can be imported into a MuPAD session via `import::readdata`. In particular, see Example 1 of the corresponding help page on page 13-11.

## Environment Interactions

The function is sensitive to the environment variable DIGITS which determines the numerical working precision.

## Examples

### Example 1

10 experiments produced the values 1, -2, 3, -4, 5, -6, 7, -8, 9, 10, which are assumed to be normally distributed with unknown mean and variance. The empirical mean of the sample data is 1.5. There is only a small probability  $p = 0.057\dots$  that the true mean is larger than 5.0:

```
data := [1, -2, 3, -4, 5, -6, 7, -8, 9, 10]:  
stats::tTest(data, 5.0)
```

```
[PValue = 0.05756660092, StatValue = -1.743955077]
```

We compare this result with the observed significance level computed via a standard normal distribution:

```
stats::tTest(data, 5.0, Normal)
```

```
[PValue = 0.04058346175, StatValue = -1.743955077]
```

The approximation of the observed significance level  $p$  by the standard normal distribution is rather poor because of the small sample size. Next, we consider a larger sample. The true mean of the random data should be 10:

```
r := stats::normalRandom(10, 12, Seed = 0):  
data := [r() $ i = 1..100]:  
stats::tTest(data, 10);
```

```
[PValue = 0.2129644942, StatValue = -0.7994751641]
```

```
stats::tTest(data, 10, Normal)
```

```
[PValue = 0.212007471, StatValue = -0.7994751641]
```

With the observed significance level of  $p = 0.212\dots$ , the data are not disqualified as having the true mean 10. For samples of this size, the normal distribution approximates the t-distribution well.

delete data, r:

## Parameters

$x_1, x_2, \dots$

The statistical data: arithmetical expressions (Symbolic Math Toolbox)

**m**

The estimate for the true mean of the data: an arithmetical expression

**s**

A sample of domain type `stats::sample`.

**c**

An integer representing a column index of the sample *s*. This column provides the data  $x_1, x_2$  etc. There is no need to specify a column number *c* if the sample has only one non-string column.

## Options

**Normal**

Compute the observed significance level by a standard normal distribution instead of a t-distribution.

## Return Values

a list of two equations [`PValue = p`, `StatValue = t`] with numerical values *p* and *t*. See the 'Details' section below for the interpretation of these values.

If the variance of the data vanishes, FAIL is returned.

## Algorithms

If the data are normally distributed with expectation value ('true mean')  $\mu$ , the variable

$T = \sqrt{n} (X - \mu)$  is t-distributed with  $n - 1$  degrees of freedom. The probability of the event that  $T$  attains values not larger than  $t$  is  $Pr(T \leq t) = \text{stats}::\text{tCDF}(n - 1)(t)$ .

## See Also

### MuPAD Functions

`stats::csGOFT` | `stats::ksGOFT` | `stats::mean` | `stats::normalCDF` |  
`stats::stdev` | `stats::swGOFT` | `stats::tCDF`



# stats::uniformCDF

Cumulative distribution function of the uniform distribution

## Syntax

```
stats::uniformCDF(a, b)
```

## Description

`stats::uniformCDF(a, b)` returns a procedure representing the cumulative distribution function

$$x \rightarrow \frac{x-a}{b-a}$$

of the uniform distribution on the interval  $[a, b]$ .

The procedure `f := stats::uniformCDF(a, b)` can be called in the form `f(x)` with an arithmetical expression `x`. The return value of `f(x)` is either a floating-point number or a symbolic expression:

If `x < a` can be decided, then `f(x)` returns 0. If `x > b` can be decided, then `f(x)` returns the value 1. If `a ≤ x` and `x ≤ b` can be decided, then `f(x)` returns the value  $(x - a) / (b - a)$ .

If `x` is a real floating-point number and both `a` and `b` can be converted to real floating-point numbers, then these values are returned as floating-point numbers. Otherwise, symbolic expressions are returned.

The function `f` reacts to properties of identifiers set via `assume`. If `x` is a symbolic expression with the property `x ≤ a`, or `x ≥ b`, or `a ≤ x` and `x ≤ b`, then the corresponding values are returned.

`f(x)` returns the symbolic call `stats::uniformCDF(a, b)(x)` if it cannot be decided whether `x` lies in the interval  $[a, b]$ .

Numerical values for  $a$  and  $b$  are only accepted if they are real and  $a \leq b$ .

## Environment Interactions

The function is sensitive to the environment variable DIGITS which determines the numerical working precision.

## Examples

### Example 1

We evaluate the cumulative distribution function on the interval  $[-3, 2\pi]$  at various points:

```
f := stats::uniformCDF(-3, 2*PI):  
f(-infinity), f(-3), f(0.5), f(2/3), f(3.0), f(PI), f(infinity)
```

$0, 0, 0.3770257605, \frac{11}{3(2\pi+3)}, 0.6463298751, \frac{\pi+3}{2\pi+3}, 1$

```
delete f:
```

### Example 2

If  $x$  is a symbolic object without properties, then it cannot be decided whether  $a \leq x \leq b$  holds. A symbolic function call is returned:

```
f := stats::uniformCDF(a, b): f(x)
```

$stats::uniformCDF(a, b)(x)$

With suitable properties, it can be decided whether  $a \leq x \leq b$  holds. An explicit expression is returned:

```
assume(x < a): f(x)
```

0

Note that `assume(x < a)` attached properties both to `a` and `x`. With the next call, we overwrite the property attached to `x`. However, the property attached to `a` has to be 'unassumed' on page 1-2192 as well to avoid inconsistent assumptions  $x < a$  and  $x > b$ :

```
unassume(a): assume(x > b): f(x)
```

1

```
assume(a <= x <= b): f(x)
```

$$\frac{a-x}{a-b}$$

```
assume(b > a): f(a + (b - a)/3)
```

$$\frac{1}{3}$$

```
unassume(x): unassume(a): unassume(b): delete f:
```

### Example 3

We use symbolic arguments:

```
f := stats::uniformCDF(a, b): f(3), f(3.0)
```

```
stats::uniformCDF(a, b)(3), stats::uniformCDF(a, b)(3.0)
```

When numerical values are assigned to `a` and `b`, the function `f` starts to produce numerical values:

```
a := 0: b := PI: f(3), f(3.0)
```

```
 $\frac{3}{\pi}$ , 0.9549296586
```

delete f, a, b:

## Parameters

**a, b**

arithmetical expressions (Symbolic Math Toolbox) representing real values;  $a \leq b$  is assumed.

## Return Values

procedure on page 1-1654.

## See Also

### MuPAD Functions

`stats::uniformPDF` | `stats::uniformQuantile` | `stats::uniformRandom`

# stats::uniformPDF

Probability density function of the uniform distribution

## Syntax

```
stats::uniformPDF(a, b)
```

## Description

`stats::uniformPDF(a, b)` returns a procedure representing the probability density function

$$x \rightarrow \frac{1}{b-a}$$

of the uniform distribution on the interval  $[a, b]$ .

The procedure `f := stats::uniformPDF(a, b)` can be called in the form `f(x)` with an arithmetical expression `x`. The return value of `f(x)` is either a floating-point number or a symbolic expression:

If  $x < a$  or  $x > b$  can be decided, then `f(x)` returns 0. If  $a \leq x$  and  $x \leq b$  can be decided, then `f(x)` returns the value  $1/(b - a)$ .

If `x` is a real floating-point number and both `a` and `b` can be converted to real floating-point numbers, then these values are returned as floating-point numbers. Otherwise, symbolic expressions are returned.

The function `f` reacts to properties of identifiers set via `assume`. If `x` is a symbolic expression with the property  $x < a$ , or  $x > b$ , or  $a \leq x$  and  $x \leq b$ , then the corresponding values are returned.

`f(x)` returns the symbolic call `stats::uniformPDF(a, b)(x)` if it cannot be decided whether `x` lies in the interval  $[a, b]$ .

Numerical values for `a` and `b` are only accepted if they are real and  $a \leq b$ .

## Environment Interactions

The function is sensitive to the environment variable DIGITS which determines the numerical working precision.

## Examples

### Example 1

We evaluate the probability density function on the interval  $[-3, 2\pi]$  at various points:

```
f := stats::uniformPDF(-3, 2*PI):  
f(-infinity), f(-PI), f(-3.0), f(1/2), f(0.5), f(PI), f(infinity)
```

```
0, 0, 0.1077216458,  $\frac{1}{2\pi+3}$ , 0.1077216458,  $\frac{1}{2\pi+3}$ , 0
```

```
delete f:
```

### Example 2

If  $x$  is a symbolic object without properties, then it cannot be decided whether  $a \leq x \leq b$  hold. A symbolic function call is returned:

```
f := stats::uniformPDF(a, b): f(x)
```

```
stats::uniformPDF(a, b)(x)
```

With suitable properties, it can be decided whether  $a \leq x \leq b$  holds. An explicit expression is returned:

```
assume(x < a): f(x)
```

```
0
```

Note that `assume(x < a)` attached properties both to `a` and `x`. With the next call, we overwrite the property attached to `x`. However, the property attached to `a` has to be 'unassumed' on page 1-2192 as well to avoid inconsistent assumptions  $x < a$  and  $x > b$ :

```
unassume(a): assume(x > b): f(x)
```

```
0
```

```
assume(a <= x <= b): f(x)
```

```
 $-\frac{1}{a-b}$ 
```

```
assume(b > a): f(a + (b - a)/3)
```

```
 $-\frac{1}{a-b}$ 
```

```
unassume(x): unassume(a): unassume(b): delete f:
```

### Example 3

We use symbolic arguments:

```
f := stats::uniformPDF(a, b): f(x)
```

```
stats::uniformPDF(a, b)(x)
```

When numerical values are assigned to `a` and `b`, the function `f` starts to produce numerical values:

```
a := 0: b := PI: f(3), f(3.0)
```

```
 $\frac{1}{\pi}$ , 0.3183098862
```

```
delete f, a, b:
```

## Parameters

**a, b**

arithmetical expressions (Symbolic Math Toolbox) representing real values;  $a \leq b$  is assumed.

## Return Values

procedure on page 1-1654.

## See Also

### **MuPAD Functions**

`stats::uniformCDF` | `stats::uniformQuantile` | `stats::uniformRandom`



# stats::uniformQuantile

Quantile function of the uniform distribution

## Syntax

```
stats::uniformQuantile(a, b)
```

## Description

`stats::uniformQuantile(a, b)` returns a procedure representing the quantile function (inverse) of the cumulative distribution function `stats::uniformCDF(a, b)` of the uniform distribution on the interval  $[a, b]$ . For  $0 \leq x \leq 1$ , the quantile function is given by  $x \rightarrow a + x(b - a)$ .

The procedure `f := stats::uniformQuantile(a, b)` can be called in the form `f(x)` with an arithmetical expression `x`. The return value of `f(x)` is either a floating-point number or a symbolic expression:

If `x` is a real number between 0 and 1 and `a` and `b` can be converted to floating-point numbers, then `f(x)` returns the value  $a + x(b - a)$  as a floating-point number. Otherwise, this value is returned as a symbolic expression.

Numerical values of `x` are only accepted if  $0 \leq x \leq 1$ .

Numerical values for `a` and `b` are only accepted if they are real and  $a \leq b$ .

## Environment Interactions

The function is sensitive to the environment variable `DIGITS` which determines the numerical working precision.

## Examples

### Example 1

We evaluate the quantile function over the interval  $\left[2, \frac{11}{4}\right]$  at various points:

```
f := stats::uniformQuantile(2, 11/4):  
f(0), f(1/10), f(0.5), f(1 - 10^(-5)), f(1)
```

```
2,  $\frac{83}{40}$ , 2.375,  $\frac{1099997}{400000}$ ,  $\frac{11}{4}$ 
```

```
delete f:
```

### Example 2

We use symbolic arguments:

```
f := stats::uniformQuantile(a, b): f(x), f(9/10)
```

```
 $a - x(a - b), \frac{a}{10} + \frac{9b}{10}$ 
```

When positive real values are assigned to a and b, the function f starts to produce numerical values:

```
a := 3: b := 11/2: f(0.999), f(1 - sqrt(2)/10^5)
```

```
5.4975,  $\frac{11}{2} - \frac{\sqrt{2}}{40000}$ 
```

```
delete f, a, b:
```

## Parameters

**a, b**

arithmetical expressions (Symbolic Math Toolbox) representing real values;  $a \leq b$  is assumed.

## Return Values

procedure on page 1-1654.

## See Also

### **MuPAD Functions**

stats::uniformCDF | stats::uniformPDF | stats::uniformRandom

## stats::uniformRandom

Generate a random number generator for uniformly continuous deviates

### Syntax

```
stats::uniformRandom(a, b, <Seed = s>)
```

### Description

`stats::uniformRandom(a, b)` returns a procedure that produces uniformly continuous on page 30-463 deviates (random numbers) on the interval  $[a, b)$ .

The procedure `f := stats::uniformRandom(a, b)` can be called in the form `f()`. The return value of `f()` is either a floating-point number or a symbolic expression:

If `a` and `b` can be converted to floating-point numbers, then `f()` returns a floating point number between `a` and `b`.

In all other cases, `stats::uniformRandom(a, b)()` is returned symbolically.

Numerical values of `a` and `b` are only accepted if they are real and  $a \leq b$ .

The values  $X = f()$  are distributed randomly according to the cumulative distribution function of the uniform distribution on the interval  $[a, b)$ . For any  $a \leq x \leq b$ , the

probability that  $X \leq x$  is given by  $\frac{(x-a)}{(b-a)}$ .

Without the option `Seed = s`, an initial seed is chosen internally. This initial seed is set to a default value when MuPAD is started. Thus, each time MuPAD is started or re-initialized with the `reset` function, random generators produce the same sequences of numbers.

---

**Note** In contrast to the function `random`, the generators produced by `stats::uniformRandom` do not react to the environment variable `SEED`.

---

For efficiency, it is recommended to produce sequences of  $K$  random numbers via `f := stats::uniformRandom(a, b): f() $ k = 1..K` rather than by `stats::uniformRandom(a, b)() $ k = 1..K`. The latter call produces a sequence of generators each of which is called once. Also note that

```
stats::uniformRandom(a, b, Seed = n)() $k = 1..K;
```

does not produce a random sequence, because a sequence of freshly initialized generators would be created each of them producing the same number.

## Environment Interactions

The function is sensitive to the environment variable `DIGITS` which determines the numerical working precision.

## Examples

### Example 1

We generate uniform deviates on the interval  $[2, 7)$ :

```
f := stats::uniformRandom(2, 7): f() $ k = 1..4
      3.351790828, 6.155185894, 2.76578258, 6.974063904
```

```
delete f:
```

### Example 2

With symbolic parameters, no random floating-point numbers can be produced:

```
f := stats::uniformRandom(a, b): f()
      stats::uniformRandom(a, b)()
```

When  $a$  and  $b$  evaluate to real numbers,  $f$  starts to produce random floating point numbers:

```
a := PI: b := 10: f() $ k = 1..4
```

```
4.967800682, 4.377232316, 6.242162399, 7.796955809
```

```
delete f, a, b:
```

### Example 3

We use the option `Seed = s` to reproduce a sequence of random numbers:

```
f := stats::uniformRandom(0, 10, Seed = 10^3): f() $ k = 1..4
```

```
8.633422729, 0.1225672185, 6.622938516, 5.069443372
```

```
g := stats::uniformRandom(0, 10, Seed = 10^3): g() $ k = 1..4
```

```
8.633422729, 0.1225672185, 6.622938516, 5.069443372
```

```
f() = g(), f() = g()
```

```
0.6809567809 = 0.6809567809, 0.0395345751 = 0.0395345751
```

```
delete f, g:
```

## Parameters

**a, b**

arithmetical expressions (Symbolic Math Toolbox) representing real values;  $a \leq b$  is assumed.

## Options

### Seed

Option, specified as `Seed = s`

Initializes the random generator with the integer seed `s`. `s` can also be the option `currentTime`, to make the seed depend on the current time.

This option serves for generating generators that return predictable sequences of pseudo-random numbers. The generator is initialized with the seed `s` which may be an arbitrary integer. Several generators with the same initial seed produce the same sequence of numbers.

When this option is used, the parameters `a` and `b` must be convertible to floating-point numbers at the time when the random generator is generated.

## Return Values

procedure on page 1-1654.

## Algorithms

Uniform deviates on the interval  $[a, b)$  are produced via `a + (b - a)*frandom()`.

## See Also

### MuPAD Functions

`frandom` | `random` | `stats::uniformCDF` | `stats::uniformPDF` |  
`stats::uniformQuantile`

## stats::unzipCol

Extract columns from a list of lists

### Syntax

```
stats::unzipCol(list)
```

### Description

`stats::unzipCol` extracts the columns of a matrix structure encoded by a list of lists.

`stats::unzipCol` treats a list of lists like a list of rows of a `stats::sample` and extracts the columns. In conjunction with `stats::sample2list` it is useful for extracting the columns of a `stats::sample`.

`stats::unzipCol` is the inverse of `stats::zipCol`.

### Examples

#### Example 1

We extract the columns from a list of rows representing a matrix structure:

```
stats::unzipCol([[a11, a12], [a21, a22], [a31, a32]])
```

```
[a11, a21, a31], [a12, a22, a32]
```

#### Example 2

A list of rows is used to create a sample:

```
stats::sample([[123, s, 1/2], [442, s, -1/2], [322, p, -1/2]])
```



```
123 s 1/2
442 s -1/2
322 p -1/2
```

We re-convert the sample to a list of lists:

```
stats::sample2list(%)
```

```
[[123, s, 1/2], [442, s, -1/2], [322, p, -1/2]]
```

Finally, we extract the columns:

```
stats::unzipCol(%)
```

```
[123, 442, 322], [s, s, p], [1/2, -1/2, -1/2]
```

## Parameters

### list

A list of lists.

## Return Values

Sequence of lists to be regarded as columns.

## See Also

### MuPAD Functions

stats::col | stats::sample2list | stats::zipCol

## stats::variance

Variance of a data sample

### Syntax

```
stats::variance(x1, x2, ..., <Sample | Population>)
```

```
stats::variance([x1, x2, ...], <Sample | Population>)
```

```
stats::variance(s, <c>, <Sample | Population>)
```

### Description

stats::variance( x<sub>1</sub>, x<sub>2</sub>, ..., x<sub>n</sub>) returns the variance

$$\frac{1}{n-1} \left( \sum_{i=1}^n (x_i - \bar{x})^2 \right),$$

where  $\bar{x}$  is the arithmetic mean of the data  $x_i$ .

stats::variance( x<sub>1</sub>, x<sub>2</sub>, ..., x<sub>n</sub>, Population) returns

$$\frac{1}{n} \left( \sum_{i=1}^n (x_i - \bar{x})^2 \right).$$

The variance is the square of the standard deviation on page 30-429.

The column index *c* is optional, if the data are given by a `stats::sample` object containing only one non-string column. Cf. "Example 3" on page 30-481 (Symbolic Math Toolbox).

External statistical data stored in an ASCII file can be imported into a MuPAD session via `import::readdata`. In particular, see Example 1 of the corresponding help page on page 13-11.

## Examples

### Example 1

We calculate the variance of three values:

```
stats::variance(2, 3, 5)
```

$$\frac{7}{3}$$

Alternatively, the data may be passed as a list:

```
stats::variance([2, 3, 5])
```

$$\frac{7}{3}$$

### Example 2

We create a sample:

```
stats::sample([[a1, b1, c1], [a2, b2, c2]])
```

```
a1 b1 c1
a2 b2 c2
```

The variance of the second column is:

```
expand(stats::variance(%, 2))
```

$$\frac{b1^2}{2} - b1 b2 + \frac{b2^2}{2}$$

### Example 3

We create a sample consisting of one string column and one non-string column:

```
stats::sample(["1996", 1242], ["1997", 1353], ["1998", 1142]))
```

```
"1996" 1242  
"1997" 1353  
"1998" 1142
```

We compute the variance of the second column. In this case this column does not have to be specified, since it is the only non-string column:

```
float(stats::variance(%))
```

```
11140.33333
```

We repeat the computation with the option `Population`:

```
float(stats::variance(%2, Population))
```

```
7426.888889
```

## Parameters

$x_1, x_2, \dots$

The statistical data: arithmetical expressions (Symbolic Math Toolbox)

**s**

A sample of domain type `stats::sample`

**c**

An integer representing a column index of the sample `s`. This column provides the data  $x_1, x_2, \dots$

## Options

### Population, Sample

With `Sample`, the data are regarded as a “sample”, not as a full population. The default is `Sample`.

## Return Values

Arithmetical expression.

## See Also

### MuPAD Functions

`stats::geometricMean` | `stats::harmonicMean` | `stats::mean` | `stats::median` |  
`stats::modal` | `stats::quadraticMean` | `stats::stdev`

## stats::weibullCDF

Cumulative distribution function of the Weibull distribution

### Syntax

```
stats::weibullCDF(a, b)
```

### Description

`stats::weibullCDF(a, b)` returns a procedure representing the cumulative distribution function

$$x \rightarrow 1 - e^{-\left(\frac{x}{b}\right)^a}$$

of the Weibull distribution with shape parameter  $a > 0$  and scale parameter  $b > 0$ .

The procedure `f := stats::weibullCDF(a, b)` can be called in the form `f(x)` with an arithmetical expression  $x$ . The return value of `f(x)` is either a floating-point number or a symbolic expression:

If  $x \leq 0$  can be decided, then `f(x)` returns  $0$ . If  $x \geq 0$  can be decided, then `f(x)` returns the value  $1 - \exp(-(x/b)^a)$ .

If  $x$  is a floating-point number and both  $a$  and  $b$  can be converted to positive floating-point numbers, then these values are returned as floating-point numbers. Otherwise, symbolic expressions are returned.

The function `f` reacts to properties of identifiers set via `assume`. If  $x$  is a symbolic expression with the property  $x \leq 0$  or  $x \geq 0$ , the corresponding values are returned.

The call `f(-infinity)` returns  $0$ .

The call `f(infinity)` returns  $1$ .

`f(x)` returns the symbolic call `stats::weibullCDF(a, b)(x)` if neither  $x \leq 0$  nor  $x \geq 0$  can be decided.

Numerical values for  $a$  and  $b$  are only accepted if they are real and positive.

## Environment Interactions

The function is sensitive to the environment variable DIGITS which determines the numerical working precision. The procedure generated by `stats::weibullCDF` reacts to properties of identifiers set via `assume`.

## Examples

### Example 1

We evaluate the cumulative distribution function with  $a = 2$  and  $b = 1$  at various points:

```
f := stats::weibullCDF(2, 1):
f(-infinity), f(-3), f(0.5), f(2/3), f(PI), f(infinity)
```

$$0, 0, 0.2211992169, 1 - e^{-\frac{4}{9}}, 1 - e^{-\pi^2}, 1$$

```
delete f:
```

### Example 2

If  $x$  is a symbolic object without properties, then it cannot be decided whether  $x \geq 0$  holds. A symbolic function call is returned:

```
f := stats::weibullCDF(a, b): f(x)
```

$$\text{stats::weibullCDF}(a, b)(x)$$

With suitable properties, it can be decided whether  $x \geq 0$  holds. An explicit expression is returned:

```
assume(0 < x): f(x)
```

$$1 - e^{-\left(\frac{x}{b}\right)^a}$$

```
unassume(x): delete f:
```

### Example 3

We use symbolic arguments:

```
f := stats::weibullCDF(a, b): f(x)
```

$$\text{stats::weibullCDF}(a, b)(x)$$

When numerical values are assigned to **a** and **b**, the function **f** starts to produce numerical values:

```
a := 2: b := 1: f(3), f(3.0)
```

$$1 - e^{-9}, 0.9998765902$$

```
delete f, a, b:
```

## Parameters

### **a**

The shape parameter: an arithmetical expression (Symbolic Math Toolbox) representing a positive real value

### **b**

The scale parameter: an arithmetical expression (Symbolic Math Toolbox) representing a positive real value



## Return Values

procedure on page 1-1654.

## See Also

### MuPAD Functions

stats::weibullPDF | stats::weibullQuantile | stats::weibullRandom

## stats::weibullPDF

Probability density function of the Weibull distribution

### Syntax

```
stats::weibullPDF(a, b)
```

### Description

stats::weibullPDF(a, b) returns a procedure representing the probability density function

$$x \rightarrow \frac{ax^{a-1} e^{-\left(\frac{x}{b}\right)^a}}{b^a}$$

of the Weibull distribution with shape parameter  $a > 0$  and scale parameter  $b > 0$ .

The procedure `f := stats::weibullPDF(a, b)` can be called in the form `f(x)` with an arithmetical expression `x`. The return value of `f(x)` is either a floating-point number or a symbolic expression:

If  $x \leq 0$  can be decided, then `f(x)` returns  $\emptyset$ . If  $x > 0$  can be decided, then `f(x)` returns

the value  $\frac{ax^{a-1} e^{-\left(\frac{x}{b}\right)^a}}{b^a}$ .

If `x` is a floating-point number and both `a` and `b` can be converted to positive floating-point numbers, then these values are returned as floating-point numbers. Otherwise, symbolic expressions are returned.

The function `f` reacts to properties of identifiers set via `assume`. If `x` is a symbolic expression with the property  $x \leq 0$  or  $x > 0$ , the corresponding values are returned.

`f(-infinity)` and `f(infinity)` return  $\emptyset$ .

$f(x)$  returns the symbolic call `stats::weibullPDF(a, b)(x)` if neither  $x \leq 0$  nor  $x > 0$  can be decided.

Numerical values for  $a$  and  $b$  are only accepted if they are real and positive.

## Environment Interactions

The function is sensitive to the environment variable `DIGITS` which determines the numerical working precision. The procedure generated by `stats::weibullPDF` reacts to properties of identifiers set via `assume`.

## Examples

### Example 1

We evaluate the probability density function with  $a = 2$  and  $b = 1$  at various points:

```
f := stats::weibullPDF(2, 1): f(1/5), f(0.5), f(-1), f(x)
```

$$\frac{2 e^{-\frac{1}{25}}}{5}, 0.7788007831, 0, \text{stats::weibullPDF}(2, 1)(x)$$

```
delete f:
```

### Example 2

If  $x$  is a symbolic object without properties, then it cannot be decided whether  $x > 0$  holds. A symbolic function call is returned:

```
f := stats::weibullPDF(a, b): f(x)
```

$$\text{stats::weibullPDF}(a, b)(x)$$

With suitable properties, it can be decided whether  $x > 0$  holds. An explicit expression is returned:

```
assume(0 < x): f(x)
```

$$\frac{a x^{a-1} e^{-\left(\frac{x}{b}\right)^a}}{b^a}$$

```
unassume(x): delete f:
```

### Example 3

We use symbolic arguments:

```
f := stats::weibullPDF(a, b): f(x), f(3)
```

$$\text{stats::weibullPDF}(a, b)(x), \frac{3^{a-1} a e^{-\left(\frac{3}{b}\right)^a}}{b^a}$$

When numerical values are assigned to **a** and **b**, the function **f** starts to produce numerical values:

```
a := 2: b := 1: f(3), f(3.0)
```

$$6 e^{-9}, 0.0007404588245$$

```
delete f, a, b:
```

## Parameters

### **a**

The shape parameter: an arithmetical expression (Symbolic Math Toolbox) representing a positive real value

### **b**

The scale parameter: an arithmetical expression (Symbolic Math Toolbox) representing a positive real value

## Return Values

procedure on page 1-1654.

## See Also

### MuPAD Functions

stats::weibullCDF | stats::weibullQuantile | stats::weibullRandom

## stats::weibullQuantile

Quantile function of the Weibull distribution

### Syntax

```
stats::weibullQuantile(a, b)
```

### Description

`stats::weibullQuantile(a, b)` returns a procedure representing the quantile function (inverse)

$$x \rightarrow b (-\ln(1-x))^{1/a}$$

of the cumulative distribution function `stats::weibullCDF(a, b)`. For  $0 \leq x \leq 1$ , the solution of `stats::weibullCDF(a, b)(y) = x` is given by

$$y = \text{stats::weibullQuantile}(a, b)(x)$$

The procedure `f := stats::weibullQuantile(a, b)` can be called in the form `f(x)` with an arithmetical expression `x`. The return value of `f(x)` is either a floating-point number, `infinity`, or a symbolic expression:

If `x` is a real float point number between 0 and 1 and `a` and `b` can be converted to positive floating-point numbers, then `f(x)` returns a floating-point number.

The calls `f(1)` and `f(1.0)` produce `infinity`.

In all other cases, `f(x)` returns the symbolic expression `a - ln(1 - x)/b`.

Numerical values of `x` are only accepted if  $0 \leq x \leq 1$ .

Numerical values of `a` and `b` are only accepted if they are real and positive.

## Environment Interactions

The function is sensitive to the environment variable DIGITS which determines the numerical working precision.

## Examples

### Example 1

We evaluate the quantile function with  $a = 2$  and  $b = \frac{3}{4}$  at various points:

```
f := stats::weibullQuantile(2, 3/4):
f(0), f(1/10), f(0.5), f(1 - 10^(-10)), f(1)
```

$$0, \frac{3 \sqrt{-\ln\left(\frac{9}{10}\right)}}{4}, 0.6244159584, \frac{3 \sqrt{\ln(10000000000)}}{4}, \infty$$

The value  $f(x)$  satisfies  $\text{stats::weibullCDF}(2, 3)(f(x)) = x$ :

```
stats::weibullCDF(2, 3/4)(f(0.987654321))
```

```
0.987654321
```

```
delete f:
```

### Example 2

We use symbolic arguments:

```
f := stats::weibullQuantile(a, b): f(x), f(1/PI), f(0.99)
```

$$b (-\ln(1-x))^{1/a}, b \left(-\ln\left(1 - \frac{1}{\pi}\right)\right)^{1/a}, 4.605170186^{1/a} b$$

When suitable numerical values are assigned to  $a$  and  $b$ , the function  $f$  starts to produce numerical values:

```
a := 7: b := 1/8: f(0.999), f(999/1000)
```

```
0.1647461562,  $\frac{\ln(1000)^{1/7}}{8}$ 
```

Numerical values for  $x$  are only accepted if  $0 \leq x \leq 1$ :

```
f(0.5)
```

```
0.1186235162
```

```
f(2)
```

```
Error: Argument x must be between 0 and 1. [f]
```

```
delete f, a, b:
```

## Parameters

### **a**

The shape parameter: an arithmetical expression (Symbolic Math Toolbox) representing a positive real value

### **b**

The scale parameter: an arithmetical expression (Symbolic Math Toolbox) representing a positive real value

## Return Values

procedure on page 1-1654.



## See Also

### MuPAD Functions

stats::weibullCDF | stats::weibullPDF | stats::weibullRandom

## stats::weibullRandom

Generate a random number generator for Weibull deviates

### Syntax

stats::weibullRandom(a, b, <Seed = s>)

### Description

stats::weibullRandom(a, b) returns a procedure that produces Weibull on page 30-484 deviates (random numbers) with shape parameter  $a > 0$  and scale parameter  $b > 0$ .

The procedure  $f := \text{stats::weibullRandom}(a, b)$  can be called in the form  $f()$ . The return value of  $f()$  is either a floating-point number or a symbolic expression:

If  $a$  and  $b$  can be converted to positive floating-point numbers, then  $f()$  returns a nonnegative floating-point number.

In all other cases,  $\text{stats::weibullRandom}(a, b)()$  is returned symbolically.

Numerical values of  $a$  and  $b$  are only accepted if they are real and positive.

The values  $X = f()$  are distributed randomly according to the cumulative distribution function of the Weibull distribution with parameters  $a$  and  $b$ . For any  $0 \leq x$ , the

probability that  $X \leq x$  is given by  $1 - \frac{1}{\left(\frac{x}{b}\right)^a}$ .

Without the option `Seed = s`, an initial seed is chosen internally. This initial seed is set to a default value when MuPAD is started. Thus, each time MuPAD is started or re-initialized with the `reset` function, random generators produce the same sequences of numbers.

---

**Note** In contrast to the function `random`, the generators produced by `stats::weibullRandom` do not react to the environment variable `SEED`.

---

For efficiency, it is recommended to produce sequences of  $K$  random numbers via

```
f := stats::weibullRandom(a, b): f() $k = 1..K;
```

rather than by

```
stats::weibullRandom(a, b)() $k = 1..K;
```

The latter call produces a sequence of generators each of which is called once. Also note that

```
stats::weibullRandom(a, b, Seed = n)() $k = 1..K;
```

does not produce a random sequence, because a sequence of freshly initialized generators would be created each of them producing the same number.

## Environment Interactions

The function is sensitive to the environment variable DIGITS which determines the numerical working precision.

## Examples

### Example 1

We generate Weibull deviates with parameters  $a = 2$  and  $b = \frac{3}{4}$ :

```
f := stats::weibullRandom(2, 3/4): f() $ k = 1..4
```

```
0.8577612188, 0.3226575883, 1.027334357, 0.05408701056
```

```
delete f:
```

### Example 2

With symbolic parameters, no random floating-point numbers can be produced:

```
f := stats::weibullRandom(a, b): f()
```

```
stats::weibullRandom(a, b)()
```

When positive real numbers are assigned to **a** and **b**, the function **f** starts to produce random floating point numbers:

```
a := PI: b := 1/8: f() $ k = 1..4
```

```
0.1366558143, 0.148384594, 0.1161455634, 0.09243509442
```

```
delete f, a, b:
```

### Example 3

We use the option **Seed = s** to reproduce a sequence of random numbers:

```
f := stats::weibullRandom(PI, 3, Seed = 1): f() $ k = 1..4
```

```
2.503931345, 1.888623862, 3.833514832, 3.584419593
```

```
g := stats::weibullRandom(PI, 3, Seed = 1): g() $ k = 1..4
```

```
2.503931345, 1.888623862, 3.833514832, 3.584419593
```

```
f() = g(), f() = g()
```

```
1.742746285 = 1.742746285, 5.240957365 = 5.240957365
```

```
delete f, g:
```

## Parameters

**a**

The shape parameter: an arithmetical expression (Symbolic Math Toolbox) representing a positive real value

**b**

The scale parameter: an arithmetical expression (Symbolic Math Toolbox) representing a positive real value

## Options

### Seed

Option, specified as `Seed = s`

Initializes the random generator with the integer seed `s`. `s` can also be the option `CurrentTime`, to make the seed depend on the current time.

This option serves for generating generators that return predictable sequences of pseudo-random numbers. The generator is initialized with the seed `s` which may be an arbitrary integer. Several generators with the same initial seed produce the same sequence of numbers.

When this option is used, the parameters `a` and `b` must be convertible to positive floating-point numbers at the time when the random generator is generated.

## Return Values

procedure on page 1-1654.

## Algorithms

The implemented algorithm for the computation of the Weibull deviates uses the quantile function of the Weibull distribution applied to uniformly distributed random numbers on the interval `[0, 1)`.

## See Also

### MuPAD Functions

`stats::weibullCDF` | `stats::weibullPDF` | `stats::weibullQuantile`

# stats::zipCol

Convert a sequence of columns to a list of lists

## Syntax

```
stats::zipCol(column1, column2, ...)
```

## Description

`stats::zipCol(...)` converts a sequence of columns to a format suitable for creating a `stats::sample`.

`stats::zipCol` is useful for converting column data given in lists to a list of lists accepted by `stats::sample`.

`stats::zipCol` is the inverse of `stats::unzipCol`.

## Examples

### Example 1

We convert a single column to a nested list:

```
stats::zipCol([a, b, c])
```

```
[[a], [b], [c]]
```

This list is accepted by `stats::sample`:

```
stats::sample(%)
```

```
a  
b  
c
```

## Example 2

We build a sample consisting of two columns:

```
column1 := [122, 442, 322]: column2 := [s, s, p]:  
stats::zipCol(column1, column2)
```

```
[[122, s], [442, s], [322, p]]
```

```
stats::sample(%)
```

```
122 s  
442 s  
322 p
```

## Parameters

`column1, column2, ...`

Lists.

## Return Values

List of lists.

## See Also

### MuPAD Functions

`stats::sample2list` | `stats::unzipCol`



# **stringlib - Manipulating Strings**

---

# stringlib::collapseWhitespace

Collapse whitespace in strings

## Syntax

```
stringlib::collapseWhitespace(string)
```

## Description

`stringlib::collapseWhitespace(string)` replaces each whitespace sequence in `string` by one space.

The characters " " (space), "\n" (newline), "\t" (tabulator) and "\r" (return) are called whitespace.

`stringlib::collapseWhitespace(string)` replaces all whitespace characters by one space and following all sequences of spaces by one space in `string`.

When `string` contains no whitespace or only single space characters, the string is returned without changes.

`stringlib::collapseWhitespace` is a function of the system kernel.

## Examples

### Example 1

In the following examples all whitespace is collapsed:

```
stringlib::collapseWhitespace("      ")
```

```
" "
```

```
stringlib::collapseWhitespace("MuPAD is nice.")
```

```
"MuPAD is nice."
```

```
stringlib::collapseWhitespace("      ")
" "
```

In this example no whitespace can be collapsed:

```
stringlib::collapseWhitespace(""),
stringlib::collapseWhitespace("12345"),
stringlib::collapseWhitespace("MuPAD is nice.")

"", "12345", "MuPAD is nice."
```

## Example 2

`stringlib::collapseWhitespace` can be useful for output MuPAD code. The procedure is only an example:

```
f:= proc(x) local y; begin y:= 2*x; x + y end

proc f(x) ... end

print(f)

proc f(x) ... end

expr2text(f)

"proc(x) name f; local y;begin y := 2*x; x + yend_proc"

stringlib::collapseWhitespace(%)

"proc(x) name f; local y; begin y := 2*x; x + y end_proc"
```

## Parameters

**string**

Any MuPAD string

## Return Values

Given string with collapsed whitespace

## See Also

### **MuPAD Functions**

`stringlib::remove` | `stringlib::subs` | `subs`

# stringlib::contains

Test for substring

## Syntax

```
stringlib::contains(string1, string2, options)
```

## Description

`stringlib::contains(string1, string2)` checks, whether `string1` contains another string `string2`.

## Examples

### Example 1

If called without options, `stringlib::contains` simply returns TRUE or FALSE.

```
stringlib::contains("abcdeabcdeabcde", "bc")
```

TRUE

```
stringlib::contains("abcdeabcdeabcde", "cb")
```

FALSE

```
stringlib::contains("abcdeabcdeabcde", "bc", Index)
```

2

```
stringlib::contains("abcdeabcdeabcde", "cb", Index)
```

FALSE

```
stringlib::contains("abcdeabcdeabcde", "bc", IndexList)
```

[2, 7, 12]

```
stringlib::contains("abcdeabcdeabcde", "cb", IndexList)
```

[]

## Example 2

The following call does *not* return [1, 2] because the first matching substring has not ended when the second begins.

```
stringlib::contains("aaa", "aa", IndexList)
```

[1]

## Parameters

**string1, string2**

Non empty string

## Options

### Index

Causes the first index position at which `string2` appears in `string1` to be returned as integer. The return value is FALSE, if `string2` occurs nowhere in `string1`.

### **IndexList**

Causes the list of all positions at which `string2` appears in `string1` to be returned. The returned list is empty if `string2` occurs nowhere in `string1`.

An occurrence of `string2` is not detected if overlapped by the tail of a previously detected occurrence. See “Example 2” on page 31-6 (Symbolic Math Toolbox).

### **Return Values**

TRUE, an integer, or a list of integers that determines the position (if an option is given), when `string1` contains `string2`, otherwise FALSE or an empty list.

### **See Also**

#### **MuPAD Functions**

`contains` | `stringlib::pos` | `strmatch`

## stringlib::format

Formatting a string

### Syntax

```
stringlib::format(string1, width, <Left | Center | Right>, <fill_char>)
```

### Description

`stringlib::format` adjusts the length of a string.

If `width` is less than the length of the given string `string1`, the substring consisting of the first `width` characters of `string1` is returned.

If `width` exceeds the length of `string1`, the given string will be filled with the necessary number of spaces or the optional `fill_char`. These are inserted at the end in case of left alignment, or at the beginning in case of right alignment. In case of centering, the same number of filling characters is placed at the beginning and at the end, but one more is placed at the end if their total number is odd.

If `alignment` is not given, left alignment is used by default.

### Examples

#### Example 1

By default, a string of length 5 is adjusted to length 10 by inserting five space characters at the end. Since white spaces are collapsed in typesetting output, we use `print`:

```
print(Plain, stringlib::format("abcde", 10))
```

```
"abcde    "
```

In the case of centering, three spaces are inserted at the end and two at the beginning.



```
print(Plain, stringlib::format("abcde", 10, Center))
```

```
" abcde "
```

Instead of the space character, also any other character may be used as a filling character.

```
stringlib::format("abcde", 10, Right, ".")
```

```
".....abcde"
```

```
stringlib::format("abcde", 10, ".")
```

```
"abcde....."
```

## Parameters

### **string1**

String

### **width**

Integer that determines the length of the returned string

### **fill\_char**

One-character string to fill up the result string

## Options

### **Left**

Determines that the string will be aligned left

### **Center**

Determines that the string will be centered

### **Right**

Determines that the string will be aligned right

## **Return Values**

String of length `width` containing the given string

## **See Also**

### **MuPAD Functions**

`stringlib::formatf`

# stringlib::formatf

Convert a floating-point number to a string

## Syntax

```
stringlib::formatf(f, digits, <strlength>)
```

## Description

`stringlib::formatf(f, d)` converts the floating point number `f` into a string after rounding it to `d` digits after the decimal point.

If `d` is a positive integer, a rounded fixed-point representation with `d` digits after the decimal point is returned. If `d` is zero, then a rounded fixed-point representation with one zero after the decimal point is returned. If `d` is negative, then `f` is rounded to `-d` digits before the decimal point and a fixed-point representation with one zero after the decimal point is returned.

The representation of a negative number starts with the sign and no additional spaces. The representation of a nonnegative number starts with a single space character.

If a third argument is specified, then the string returned consists of exactly `strlength` characters. If the converted number `f` requires less room, then it is padded on the left with spaces. If the converted number `f` requires more room, then the last characters are truncated.

## Examples

### Example 1

Convert the number 123.456 with two characters after the point into a string. Since white spaces are collapsed in typesetting output, we use `print`:

```
print(Plain, stringlib::formatf(123.456, 2))
```

```
" 123.46"
```

The same for -123.456:

```
print(Plain, stringlib::formatf(-123.456, 2))
```

```
"-123.46"
```

Convert the number 123.456 with two characters after the point into a string of the length 10:

```
print(Plain, stringlib::formatf(123.456, 2, 10))
```

```
"   123.46"
```

If the string should only have the length 3, the whole number does not fit into the string:

```
print(Plain, stringlib::formatf(123.456, 2, 3))
```

```
" 12"
```

Rounding to no number after point:

```
print(Plain, stringlib::formatf(123.456, 0))
```

```
" 123.0"
```

Rounding to one number in front of point:

```
print(Plain, stringlib::formatf(123.456, -1))
```

```
" 120.0"
```

## Parameters

**f**

Floating point number

**digits**

Integer which determines the precision of the number

**strlength**

Integer which determines the length of the returned string

**Return Values**

stringlib::formatf returns a string.

**See Also****MuPAD Functions**

stringlib::format

## stringlib::formatTime

Textual description of a time length

### Syntax

```
stringlib::formatTime(t)
```

### Description

`stringlib::formatTime` returns a textual description such as “5 minutes, 20 seconds” of a time value such as `320 * unit::sec` given as its argument.

When given an integer or floating-point number, `stringlib::formatTime` interprets it as milliseconds, for compatibility with `time`. Cf. “Example 2” on page 31-15 (Symbolic Math Toolbox).

`stringlib::formatTime` rounds its input to only use two types of unit, cf. “Example 1” on page 31-14 (Symbolic Math Toolbox).

### Examples

#### Example 1

`stringlib::formatTime` takes a time description and renders it as English text:

```
stringlib::formatTime(1234*unit::sec)
```

```
"20 minutes, 34.0 seconds"
```

Excessive precision is avoided:

```
stringlib::formatTime(12345678*unit::sec)
```

"4 months, 3.26 weeks"

## Example 2

`time` and `rtime` return integers interpreted as milliseconds. `stringlib::formatTime` thus interprets integers (and, for consistency, floating-point numbers) as milliseconds:

```
stringlib::formatTime(1)
```

"0.001 seconds"

```
stringlib::formatTime(rtime(system("sleep 2")))
```

"2.411 seconds"

## Parameters

**t**

The time to convert: An integer or floating-point value (regarded as milliseconds) or an expression involving time units on page 1-2196.

## Return Values

string on page 7-53.

## See Also

**MuPAD Functions**

`rtime` | `time`

## stringlib::lower

Convert to lower-case

### Syntax

```
stringlib::lower(string1)
```

### Description

`stringlib::lower(string1)` converts each upper-case letter in the string `string1` to lower-case. All other characters remains unchanged.

If the string contains no upper-case letters, the given string is returned unchanged.

### Examples

#### Example 1

Convert a string to lower-case:

```
stringlib::lower("MuPAD"),  
stringlib::lower("Mupad"),  
stringlib::lower("MUPAD"),  
stringlib::lower("mupad")
```

```
"mupad", "mupad", "mupad", "mupad"
```

#### Example 2

Compare strings not case sensitive:

```
str_eq:= (str1, str2) ->  
    bool(stringlib::lower(str1) = stringlib::lower(str2)):  
str_eq("MuPAD", "mupad"), str_eq("Mupad", "MUPAD")
```



TRUE, TRUE

## Parameters

**string1**

Any string

## Return Values

String

## See Also

### **MuPAD Functions**

stringlib::format | stringlib::upper

## stringlib::maskMeta

Mask regular expression special characters

### Syntax

```
stringlib::maskMeta(str)
```

### Description

`stringlib::maskMeta(str)` generates a regular expression (for use with `strmatch`) that matches exactly the string `str`.

As of MuPAD version 3.2, `strmatch` uses regular expression matching. To search for some verbatim substring therefore requires “escaping” special characters such as `*` or `()`. `stringlib::maskMeta` performs this task.

### Examples

#### Example 1

Trying to find "a+b" in the string "a+b+c" via `strmatch` fails due to the special nature of "+" in regular expressions, but, for almost the same reason, "a\*b" is found:

```
strmatch("a+b+c", "a+b"),  
strmatch("a+b+c", "a*b")
```

**FALSE, TRUE**

Using `stringlib::maskMeta`, we lose the ability of using regular expressions, but can easily search for verbatim strings:

```
strmatch("a+b+c", stringlib::maskMeta("a+b")),  
strmatch("a+b+c", stringlib::maskMeta("a*b"))
```

TRUE, FALSE

The output of `stringlib::maskMeta` is just another string, so combinations with other strings (containing regular expression meta-characters) is possible:

```
strmatch("a+b+c", "^".stringlib::maskMeta("a+b")),  
strmatch("a+b+c", "^".stringlib::maskMeta("b+c"))
```

TRUE, FALSE

## Parameters

**str**

Non empty string

## Return Values

String

## See Also

**MuPAD Functions**

`stringlib::pos` | `stringlib::subs` | `strmatch`

## stringlib::order

Sorting procedure for Sort

### Syntax

```
stringlib::order(options)
```

### Description

`stringlib::order()` returns a procedure that compares two strings and returns `TRUE` when they are in lexicographical order, otherwise `FALSE`. This procedure can be used as the second argument of `sort`.

### Examples

#### Example 1

Sort strings in lexicographical order:

```
sort(["ab", "a", "abc", "B", "ba", "Ca", "bB", "bb"],  
     stringlib::order())
```

```
["B", "Ca", "a", "ab", "abc", "bB", "ba", "bb"]
```

Sort strings in lexicographical order without case sensitivity:

```
sort(["ab", "a", "abc", "B", "ba", "Ca", "bB", "bb"],  
     stringlib::order(Nocase))
```

```
["a", "ab", "abc", "B", "ba", "bb", "bB", "Ca"]
```

Sort strings in reverse lexicographical order:

```
sort(["ab", "a", "abc", "B", "ba", "Ca", "bB", "bb"],  
     stringlib::order(Reverse))
```

```
["bb", "ba", "bB", "abc", "ab", "a", "Ca", "B"]
```

Sort strings in reverse lexicographical order without case sensitivity:

```
sort(["ab", "a", "abc", "B", "ba", "Ca", "bB", "bb"],  
     stringlib::order(ReverseNocase))
```

```
["Ca", "bB", "bb", "ba", "B", "abc", "ab", "a"]
```

## Options

### Lexicographical

Return a procedure that yields TRUE when the two given strings are in lexicographical order.

### Nocase

Return a procedure that yields TRUE when the two given strings are in lexicographical order without case sensitivity.

### Reverse

Return a procedure that yields TRUE when the two given strings are in reverse lexicographical order.

### ReverseNocase

Return a procedure that yields TRUE when the two given strings are in reverse lexicographical order without case sensitivity.

## Return Values

Procedure that can be used as second argument of sort

## See Also

### MuPAD Functions

sort

# stringlib::pos

Position of a substring

## Syntax

```
stringlib::pos(string1, string2, <pos>)
```

## Description

`stringlib::pos` returns the position of a substring in a string.

The third optional argument must be less than the length of `string1`.

If `string1` does not contain `string2`, then FAIL will be returned.

## Examples

### Example 1

In case of several occurrences of the substring, the position of the first is returned.

```
stringlib::pos("abcdeabcdeabcde", "bc")
```

2

### Example 2

If a starting point for the search is given, `stringlib::pos` returns the first position at which the substring occurs after that starting point.

```
stringlib::pos("abcdeabcdeabcde", "bc", 5)
```

7

### Example 3

The result is FAIL if the substring does not occur at all or after the given starting point.

```
stringlib::pos("abcdeabcdeabcde", "bc", 14)
```

FAIL

### Parameters

**string1, string2**

Non empty string

**pos**

Integer that determines the first position to search

### Return Values

Integer that determines the position or FAIL.

### See Also

**MuPAD Functions**

length | stringlib::contains



# stringlib::random

Create a random string

## Syntax

```
stringlib::random(<l>, <characters>, options)
```

## Description

`stringlib::random()` returns a random string of the default length 7.

`stringlib::random(l)` with a number or a range `l` returns a random string with length `l` or length in the given range. When the prefix and/or suffix is longer than the given length, `stringlib::random` raises an error message.

`stringlib::random(characters)` with a given list oder set of characters builds the random string of the given characters. When the characters are strings, they are used as single characters, however, the length is exceeded.

`stringlib::random(l, characters)` is a combination of the both last calls. When both parameters are given, the order is significant.

`stringlib` defines the lists `stringlib::lowerLetters`, `stringlib::upperLetters`, `stringlib::digits` and `stringlib::punctuation` with the characters lower letters, upper letters, digits and punctuation.

## Examples

### Example 1

Create a random string of the default length 7:

```
stringlib::random()
```

"jaR<2oH"

Create a random string of the length 3:

```
stringlib::random(3)
```

"uRT"

Create a random string of the length 2 only of digits:

```
stringlib::random(2, stringlib::digits)
```

"53"

Create a random string of the length 3 only of digits with prefix "+":

```
stringlib::random(3, stringlib::digits, Prefix = "+")
```

"+70"

Create a random string of the length 5 only of digits with suffix ".0":

```
stringlib::random(5, stringlib::digits, Suffix = ".0")
```

"456.0"

Create a random strings of the length 3 to 8 only of letters:

```
stringlib::random(3..8, stringlib::lowerLetters.  
                    stringlib::upperLetters) $ k = 1..5
```

"BDkkIz", "zkkvYp", "mFobeC", "Vxsjuk", "HHTJbWh"

Create a random string of the length 2 to 8 with letters and casual a punctuation:

```
stringlib::random(2..8, (stringlib::lowerLetters.  
                    stringlib::upperLetters $ 4).  
                    stringlib::punctuation) $ k = 1..12
```

```
"<v|v|<a", "rF xvu", "GUHEBR", "fP", "dlqxr", "wO"Md", "RdFdRlqH", "nv)", "Bo",
  "HGaiqPt&", "AqnF", "do"
```

Create a random string of the length 6 to 8 with letters and equivalent punctuation:

```
stringlib::random(6..8, (stringlib::lowerLetters.
  stringlib::upperLetters).
  (stringlib::punctuation $ 2)) $ k = 1..10
```

```
"n^iY)E", "=|_?sZ", "{i^(Gh>h", "/A+#}/", "L-DM&G-U", "(^JzNL;", "ZH;%i",
  ")t^[^}T", "-v*Es=Z>", "\:AdF{R"
```

Create random names of the length 4 to 6:

```
stringlib::random(4..6, Name) $ k = 1..12
```

```
"pbg1", "A98HWb", "eAaR1", "ve_6", "rtxoi", "Iwaw", "Td8cQR", "PASudJ", "a4AN",
  "d2ixaC", "DvLXzh", "yTMCa5"
```

Create a random password of the length 8 to 10, but without some special characters:

```
EX := {"\\", "\'", "|", "'", "?", "*", "[", "]"}:
stringlib::random(8..10, Exclude = EX)
```

```
"NRpjhuRkc"
```

## Parameters

**l**

The length of the returned string: a nonnegative integer or a range of nonnegative integers

**characters**

A list or set of characters

**options**

Any of the described options

## Options

**Exclude**

Option, specified as `Exclude = characters`

The returned string does not contain characters given in the set or list `characters`.

**Name**

The returned string is a valid MuPAD object name.

**Prefix**

Option, specified as `Prefix = string`

Adds `string` in front of each random string. The length of the returned string is the given length or the default length including the prefix.

**Suffix**

Option, specified as `Suffix = string`

Appends `string` to each random string. The length of the returned string is the given length or the default length including the suffix.

## Return Values

Random string of the given length or the default length including the prefix resp. suffix.

## See Also

### **MuPAD Functions**

SEED | random | stringlib::lower | stringlib::upper | substring

## stringlib::readText

Read text file

### Syntax

```
stringlib::readText(filename)
```

```
stringlib::readText(filename, String, <NoNL>)
```

```
stringlib::readText(filename, String, <Separator = string>)
```

```
stringlib::readText(..., <Encoding = "encodingValue">)
```

### Description

`stringlib::readText(filename)` reads all lines of the text file with name "filename" and returns a list of strings, one string per line. The linebreaks are not included at the end of each string. The file must be a text file, otherwise the file cannot be read.

`stringlib::readText(filename, Encoding = "encodingValue")` uses the specified encoding to read the file. For the supported encodings, see "Options" on page 31-32 (Symbolic Math Toolbox). You can use this option with the previously specified syntaxes.

### Examples

#### Example 1

First create a text file that can be read:

```
fprint(Unquoted, Text, "test.txt",  
      "This file contains three lines.\n",  
      "// this line is a MuPAD comment\n",  
      ".....\n");
```

By default, `stringlib::readText` returns a list of all lines:

```
stringlib::readText("test.txt")
```

```
["This file contains three lines.", "// this line is a MuPAD comment", ".....", ""]
```

Because the third line was ended by a newline, the file contains four lines, the last line is empty.

The file can be read as *one* string:

```
stringlib::readText("test.txt", String)
```

```
"This file contains three lines// this line is a MuPAD comment....."
```

When the newlines should be removed, option `NoNL` can be used:

```
stringlib::readText("test.txt", String, NoNL)
```

```
"This file contains three lines// this line is a MuPAD comment....."
```

Otherwise the newlines can be replaced by another separator:

```
stringlib::readText("test.txt", String, Separator = " ;; ")
```

```
"This file contains three lines. ;; // this line is a MuPAD comment ;; ..... ;; "
```

## Example 2

To specify the encoding to read data, use `Encoding`. The `Encoding` option applies only to text files that are opened using a file name and not a file descriptor. Open a file and write strings in the encoding "UTF-8":

```
fprint(Unquoted, Text, Encoding="UTF-8", "readtext_test",
      "File to test stringlib::readText\n",
      "Testing to encode characters such as abcäöü");
```

Specify the encoding to read the file:

```
stringlib::readText("readtext_test", Encoding="UTF-8")
```

```
["File to test stringlib::readText", "Testing to encode characters such as abcäöü"]
```

If you do not specify an encoding, the default system encoding is used. Thus, your output might vary from that shown next. Characters unrecognized by the default system encoding are replaced by the default substitution character for that encoding:

```
stringlib::readText("readtext_test")
```

```
["File to test stringlib::readText", "Testing to encode characters such as abc?????"]
```

## Parameters

### **filename**

The name of a file as string

### **string**

Any string

## Options

### **String**

With this option, `stringlib::readText` returns *one* string that contains all contents of the read file, including the line breaks as separator of the lines.

### **NoNL**

With option `NoNL`, the returned string does not contain the linebreaks between the lines.

### **Separator**

Option, specified as `Separator = string`



This option causes `stringlib::readText` to separate all lines by `string` instead of the line break `"\n"`.

## Encoding

This option lets you specify the character encoding to use. The allowed encodings are:

"Big5"	"ISO-8859-1"	"windows-932"
"EUC-JP"	"ISO-8859-2"	"windows-936"
"GBK"	"ISO-8859-3"	"windows-949"
"KSC_5601"	"ISO-8859-4"	"windows-950"
"Macintosh"	"ISO-8859-9"	"windows-1250"
"Shift_JIS"	"ISO-8859-13"	"windows-1251"
"US-ASCII"	"ISO-8859-15"	"windows-1252"
"UTF-8"		"windows-1253"
		"windows-1254"
		"windows-1257"

The default encoding is system dependent. If you specify the encoding incorrectly, characters might read incorrectly. Characters unrecognized by the encoding are replaced by the default substitution character for the specified encoding.

Encodings not listed here can be specified but might not produce correct results.

## Return Values

List of strings, or one string

## See Also

### MuPAD Functions

`fprint` | `ftextinput` | `stringlib::subs`

## stringlib::remove

Delete substrings

### Syntax

```
stringlib::remove(string1, string2, <First>)
```

### Description

With `stringlib::remove`, a substring can be deleted from another string.

After `string2` has been found, the search for further occurrences of it continues after its last letter; hence only the first of several overlapping occurrences is detected. See “Example 3” on page 31-35 (Symbolic Math Toolbox).

### Examples

#### Example 1

By default, out of several occurrences of the given substring *all* are removed.

```
stringlib::remove("abcdeabcdeabcde", "bc")
```

```
"adeadeade"
```

#### Example 2

Using the option `First` causes `stringlib::remove` to remove only the first occurrence of the given substring.

```
stringlib::remove("abcdeabcdeabcde", "bc", First)
```

```
"adeabcdeabcde"
```

### Example 3

In the following example, the given substring occurs twice, where both instances of it do overlap. Only the first occurrence is removed.

```
stringlib::remove("aaa", "aa")
```

```
"a"
```

### Parameters

**string1, string2**

Non empty string

### Options

**First**

Determines that only the first appearance of `string2` in `string1` will be deleted

### Return Values

Given string without the deleted parts

### See Also

**MuPAD Functions**

`delete` | `stringlib::subs` | `stringlib::subsop`

## stringlib::split

Split a string

### Syntax

```
stringlib::split(string, <separator>)
```

### Description

`stringlib::split(string, separator)` splits `string` in all parts separated by the string given as `separator`, that is not included in the returned strings.

If no separator is given, a single space is used as separator.

A returned part can be the empty string.

When the given string does not contain the separator, a list with the unchanged string is returned.

### Examples

#### Example 1

The given string is splitted into the numbers separated by comma:

```
stringlib::split("1,2,3,4,5", ",")
```

```
["1", "2", "3", "4", "5"]
```

In the next example is the separator a comma followed by a space:

```
stringlib::split("1, 2, 3, 4, 5", ", ")
```

```
["1", "2", "3", "4", "5"]
```

Without separator a single space is used as separator:

```
stringlib::split("1, 2, 3, 4, 5")
```

```
["1,", "2,", "3,", "4,", "5"]
```

## Example 2

The parts can be empty strings - five empty strings separated by four single spaces:

```
stringlib::split("   ", " ")
```

```
["", "", "", "", ""]
```

The following string (five spaces) consists of two empty strings and a single space separated by two double spaces:

```
stringlib::split("     ", "  ")
```

```
["", "", " "]
```

## Example 3

When the string does not contain the separator, a list with the unchanged string is returned:

```
stringlib::split("1,2,3,4,5", ".")
```

```
["1,2,3,4,5"]
```

## Parameters

### **string, separator**

Any non-empty MuPAD string

## Return Values

List of all parts of `string` without all parts separator; the string itself, if `string` does not contain separator.

## See Also

### MuPAD Functions

`stringlib::collapseWhitespace` | `stringlib::contains` | `strmatch` | `substring`

# stringlib::subs

Substitution in a string

## Syntax

```
stringlib::subs(string, substring = replacement, <First>)
```

## Description

`stringlib::subs` substitutes a substring by another string.

By default, every occurrence of the string `substring` in `string` is replaced by `replacement`. The option `First` causes only the first appearance of `substring` to be replaced.

The result is not searched again for instances of `substring`. See “Example 3” on page 31-40 (Symbolic Math Toolbox).

Among several overlapping occurrences of `substring`, the leftmost one is replaced.

## Examples

### Example 1

The string replacement may be empty.

```
stringlib::subs("abcdeabcdeabcde", "bc" = "")
```

```
"adeadeade"
```

### Example 2

Every `substring` is replaced unless the option `First` is given.

```
stringlib::subs("abcdeabcdeabcde", "bc" = "xxx")
```

```
"axxxdeaxxxdeaxxxde"
```

```
stringlib::subs("abcdeabcdeabcde", "bc" = "xxx", First)
```

```
"axxxdeabcdeabcde"
```

### Example 3

The substitution may produce a new instance of `substring`, but this one is not replaced.

```
stringlib::subs("aab", "ab"="b")
```

```
"ab"
```

### Example 4

Collapse all whitespace in strings (see `stringlib::collapseWhitespace`):

```
f := proc(x) local y; begin y := 2*x; x + y end_proc:  
string := expr2text(f)
```

```
"proc(x) name f; local y;begin y := 2*x; x + yend_proc"
```

```
string := stringlib::subs(string, "\n" = " "):  
string := stringlib::subs(string, " " = " "):  
string := stringlib::subs(string, " " = " ")
```

```
"proc(x) name f; local y; begin y := 2*x; x + y end_proc"
```



## Parameters

### **string**

Non empty string

### **substring**

Non empty string that should be replaced

### **replacement**

Any string that replaced substring

## Options

### **First**

Determines that only the first appearance of substring in string will be replaced

## Return Values

Given string with substring replaced by replacement

## See Also

### **MuPAD Functions**

stringlib::pos | stringlib::remove | stringlib::subsop | subs

## stringlib::subsop

Substitution in a string

### Syntax

```
stringlib::subsop(string, index = replacement)
```

### Description

`stringlib::subsop` removes one or more characters at a given position and inserts another substring at that position instead.

The char with index `index` in `string` (if `index` is an integer) or the range of chars (if `index` is a range of integers) is removed. Instead `replacement` is inserted at that position. The inserted string need not have the same length.

### Examples

#### Example 1

Delete the first character:

```
stringlib::subsop("abcdeabcdeabcde", 1 = "")
```

```
"bcdeabcdeabcde"
```

The 2nd to 3rd character will be replaced by "xxx":

```
stringlib::subsop("abcdeabcdeabcde", 2..3 = "xxx")
```

```
"axxxdeabcdeabcde"
```

Delete the characters 2 to 11:

```
stringlib::subsop("abcdeabcdeabcde", 2..11 = "")
```

```
"abcde"
```

## Parameters

### **string**

Non empty string

### **index**

Integer or range of integers that determines the chars to be replaced

### **replacement**

Any string to replace the given char or range

## Return Values

Given string with the replacement

## See Also

### **MuPAD Functions**

`stringlib::pos` | `stringlib::remove` | `stringlib::subs` | `subsop`

## stringlib::upper

Convert to upper-case

### Syntax

```
stringlib::upper(string1)
```

### Description

`stringlib::upper(string1)` converts each lower-case letter in the string `string1` to upper-case. All other characters remains unchanged.

If the string contains no lower-case letters, the given string is returned unchanged.

### Examples

#### Example 1

Convert a string to upper-case:

```
stringlib::upper("MuPAD"),  
stringlib::upper("Mupad"),  
stringlib::upper("MUPAD"),  
stringlib::upper("mupad")
```

```
"MUPAD", "MUPAD", "MUPAD", "MUPAD"
```

#### Example 2

Compare strings not case sensitive:

```
str_eq:= (str1, str2) ->  
    bool(stringlib::upper(str1) = stringlib::upper(str2)):  
str_eq("MuPAD", "mupad"), str_eq("Mupad", "MUPAD")
```

TRUE, TRUE

## Parameters

**string1**

Any string

## Return Values

String

## See Also

### **MuPAD Functions**

stringlib::format | stringlib::lower

## stringlib::validIdent

Validate identifier name

### Syntax

```
stringlib::validIdent(string)
```

### Description

`stringlib::validIdent(string)` returns TRUE, when `string` is a valid identifier on page 7-29 name, otherwise FALSE.

A valid identifier name in MuPAD must follow the rules:

- The first character must be a letter or the character "\_".
- All following characters must be letters or digits or the character "\_".
- An identifier consists of at least one character up to 512 characters.

Names in backticks ` are not determined as valid names.

### Examples

#### Example 1

The example splits a set of names into valid identifier names and invalid identifier names:

```
split({"a", "1", "_111", "____", "A0b.C", "MuPAD", "1ABCDE", "xyz00"},  
      stringlib::validIdent)
```

```
[{"MuPAD", "_111", "____", "a", "xyz00"}, {"1", "1ABCDE", "A0b.C"}, ∅]
```

stringlib::random called with option Name returns always valid identifier names. The function map applies stringlib::validIdent to each of the 1000 generated random names:

```
map({stringlib::random(1..10, Name) $ k = 1..1000},  
    stringlib::validIdent)
```

```
{TRUE}
```

## Parameters

**string**

A string

## Return Values

TRUE or FALSE

## See Also

### MuPAD Functions

domtype | stringlib::random





# Symbol - Typesetting Symbols

---

## Symbol::accentPrime

Adds a prime accent to an identifier

### Syntax

```
Symbol::accentPrime(a)
```

### Description

Creates a new identifier with a prime accent, such as  $a'$ .

### Examples

#### Example 1

Symbol::accentPrime adds a “prime” to an identifier:

```
Symbol::accentPrime(x) = x + f(x)
```

$$x' = x + f(x)$$

### Parameters

**a**

An identifier

## Return Values

Identifier

## Symbol::accentAsterisk

Adds an asterisk accent to an identifier

### Syntax

```
Symbol::accentAsterisk(a)
```

### Description

Creates a new identifier with an asterisk accent, such as  $a^*$ .

### Examples

#### Example 1

Asterisk accents are often used to denote special values:

```
f(Symbol::accentAsterisk(x)) = 0
```

$$f(x^*) = 0$$

### Parameters

**a**

An identifier

## Return Values

Identifier

## Symbol::accentTilde

Adds a tilde accent to an identifier

### Syntax

```
Symbol::accentTilde(a)
```

### Description

Creates a new identifier with a tilde accent, such as  $\tilde{a}$ .

### Examples

#### Example 1

The most common use of the tilde accent is to denote an approximation:

```
x = Symbol::accentTilde(x) + O(h^2)
```

$$x = \tilde{x} + O(h^2)$$

### Parameters

**a**

An identifier

## **Return Values**

Identifier

## Symbol::accentHat

Adds a hat accent to an identifier

### Syntax

```
Symbol::accentHat(a)
```

### Description

Creates a new identifier with a hat accent, such as  $\hat{a}$ .

### Examples

#### Example 1

One of the common uses of the hat (or circumflex) accents is to denote Laplace transforms:

```
f = sin(x) ==> Symbol::accentHat(f)  
= laplace(sin(x), x, t)
```

$$f = \sin(x) \Rightarrow \hat{f} = \frac{1}{t^2 + 1}$$

### Parameters

**a**

An identifier



## Return Values

Identifier

## Symbol::accentRightArrow

Adds a right arrow accent to an identifier

### Syntax

```
Symbol::accentRightArrow(a)
```

### Description

Creates a new identifier with a right arrow accent, such as  $\vec{a}$ .

### Examples

#### Example 1

Arrow accents are usually used to denote vectors:

```
Symbol::accentRightArrow(b)  
= matrix([1, 2, Symbol::dots, n])
```

$$\vec{b} = \begin{pmatrix} 1 \\ 2 \\ \dots \\ n \end{pmatrix}$$

To denote  $\vec{0}$ , the null vector, start with the *identifier* 0:

```
Symbol::accentRightArrow(`0`)
```

$$\vec{0}$$

## **Parameters**

**a**

An identifier

## **Return Values**

Identifier

## Symbol::accentDot

Adds a dot accent to an identifier

### Syntax

```
Symbol::accentDot(a)
```

### Description

Creates a new identifier with a dot accent, such as  $\dot{a}$ .

### Examples

#### Example 1

In physics, a dot accent is often used as a shorthand for the derivative with respect to time:

```
Symbol::accentDot(y) =  
- Symbol::omega^2 * sin(x)
```

$$\dot{y} = -\omega^2 \sin(x)$$

### Parameters

**a**

An identifier

## Return Values

Identifier

## Symbol::accentDoubleDot

Adds a double dot accent to an identifier

### Syntax

```
Symbol::accentDoubleDot(a)
```

### Description

Creates a new identifier with a double dot accent, such as  $a''$ .

### Examples

#### Example 1

In physics, the double dot accent usually denotes the second derivative with respect to time:

```
Symbol::accentDoubleDot(x) = -x
```

$$\ddot{x} = -x$$

### Parameters

**a**

An identifier

## Return Values

Identifier

## Symbol::accentTripleDot

Adds a triple dot accent to an identifier

### Syntax

```
Symbol::accentTripleDot(a)
```

### Description

Creates a new identifier with a triple dot accent, such as  $\ddot{a}$ .

### Examples

#### Example 1

Triple dots, where used, usually denote the third derivative with respect to time:

```
Symbol::accentTripleDot(x)(t) = diff(x(t), t$3)
```

$$\ddot{x}(t) = \frac{\partial^3}{\partial t^3} x(t)$$

### Parameters

**a**

An identifier



## Return Values

Identifier

## Symbol::accentOverBar

Adds an overbar to an identifier

### Syntax

Symbol::accentOverBar(a)

### Description

Creates a new identifier with an overbar, such as  $\bar{a}$ .

### Examples

#### Example 1

The overbar is used in statistics to denote the arithmetical mean of an observable quantity:

`Symbol::accentOverBar(x) = sum(x[i], i=1..n)/n`

$$\bar{x} = \frac{\sum_{i=1}^n x_i}{n}$$

### Parameters

**a**

An identifier

## Return Values

Identifier

## Symbol::accentUnderBar

Adds an underbar to an identifier

### Syntax

`Symbol::accentUnderBar(a)`

### Description

Creates a new identifier with an underbar, such as a.

### Examples

#### Example 1

One of the areas where the underbar is used frequently is interval analysis, where an interval is usually given as follows:

```
x = [Symbol::accentUnderBar(x),  
     Symbol::accentOverBar(x)]
```

$$x = [\underline{x}, \overline{x}]$$

### Parameters

**a**

An identifier

## **Return Values**

Identifier

## Symbol::new

Functional access to symbols

## Syntax

`Symbol(x)`

## Description

`Symbol::new(symname)` or simply `Symbol(symname)` creates the typesetting symbol corresponding to `symname`.

The typesetting symbols can be accessed in two different ways: Most symbols can be input by typing `Symbol::symname`, where `symname` is taken from the lists in the introduction. For some symbol names (such as `not` or `I`), this is not possible in the MuPAD language. What is possible in any case is to invoke `Symbol` as a function, taking a string representation as its argument, as in `Symbol("not")`.

## Examples

### Example 1

The symbols accessed via `Symbol` can be used like ordinary identifiers:

```
Symbol::heartsuit in  
  {Symbol::heartsuit, Symbol::spades}
```

```
♥ ∈ {♥, ♠}
```

```
expand((Symbol::alpha + Symbol::beta)^4);
```

```

$$\alpha^4 + 4\alpha^3\beta + 6\alpha^2\beta^2 + 4\alpha\beta^3 + \beta^4$$

```

Some symbol names are MuPAD keywords and can not be accessed via slot calls. They can be given as function calls:

```
Symbol("minus"), Symbol("div"), Symbol("in"),  
Symbol("and"), Symbol("subset"), Symbol("NIL"),  
Symbol("UNKNOWN"), Symbol("FAIL"), Symbol("E"),  
Symbol("I"), Symbol("not")
```

```
-, /, ε, ^, ⊂, Nil, unknown, Fail, E, I, ¬
```

## Parameters

**symname**

A symbol name: a string

## Return Values

identifier on page 7-29

## See Also

**MuPAD Functions**

print

## Symbol::subScript

Combines two expressions to a new subscripted identifier

### Syntax

Symbol::subScript(a, b)

### Description

Creates a new subscripted identifier, such as  $a_b$ . If the arguments are not yet identifiers, they are first converted into identifiers.

You can also use `_`, `^`, `$`, `{`, and `}` to create arguments with superscripts and subscripts. For these arguments a new superscripted identifier appears on top of the existing ones:

$a^{b^c}$  or  $a^{b^d}_e$ .

### Examples

#### Example 1

Even if  $X1$  and  $X2$  look identical, only  $X1$  is an identifier whereas  $X2$  is an `_index`-expression:

```
X1 := Symbol::subScript(x, 1): X2 := x[1]:  
X1, X2;  domtype(X1), domtype(X2)
```

$x_1, x_1$

DOM\_IDENT, DOM\_EXPR

Pre-scripts are possible by subscripting the empty identifier ```` and appending an identifier:



```
Symbol::subScript(``, 1).x
```

$${}_1x$$

## Example 2

You can use the nested form of the function:

```
Symbol::subScript(x, Symbol::subScript(i, j))
```

$$x_{ij}$$

## Example 3

Use `Symbol::subSuperScript` or `$` to create an expression with both sub- and superscript properly aligned one above the other:

```
Symbol::subSuperScript(a,b,c)
```

$$a_b^c$$

If you use the shortcut `$`, put the expression in single quotation marks:

```
`a$bc`
```

$$a_b^c$$

If you use `a_b^c`, it creates the subscripted expression `a_b` and then attaches the superscript `c` to that expression. In this case, the letters `b` and `c` do not appear one above the other.

```
a_b^c
```

$$a_b^c$$

The same happens when you use a nested call to `Symbol::subScript` and `Symbol::superScript`:

```
Symbol::superScript(Symbol::subScript(a, b), c)
```

$$a_b^c$$

### Example 4

If you want to create identifiers in which the five special characters (`_`, `^`, `$`, `{`, `}`) appear explicitly, use string arguments:

```
Symbol::subScript("a", "b_c")
```

$$a_{b\_c}$$

## Parameters

**a, b**

Arbitrary expressions

## Return Values

Identifier

## See Also

### MuPAD Functions

`Symbol::subSuperScript` | `Symbol::superScript`

# Symbol::subSuperScript

Combines three expressions to a new combined sub- and superscripted identifier

## Syntax

`Symbol::subSuperScript(a, b, c)`

## Description

Creates a new combined sub- and superscripted identifier, such as  $a_b^c$ . If the arguments are not yet identifiers, they are first converted into identifiers.

You can also use `_`, `^`, `$`, `{`, and `}` to create arguments with superscript and subscript. For these arguments a new indexed identifier appears on top of the existing ones:  $a_b^c$  or  $a_b^c$ .

## Examples

### Example 1

Input of an identifier with sub- and superscript:

```
X1 := Symbol::subSuperScript(x, 1, 2):
X1, domtype(X1)
```

$x_1^2$ , DOM\_IDENT

Pre-scripts are possible by subsuperscripting the empty identifier ```` and appending an identifier:

```
Symbol::subSuperScript(``, 1, 2).X
```

$${}^2_1X$$

And at last scripts all around X:

```
Symbol::subSuperScript(``, 1, 2).Symbol::subSuperScript(X, 3, 4)
```

$${}^2_1X_3^4$$

## Example 2

You can use the nested form of the function:

```
Symbol::subSuperScript(x, a, Symbol::subSuperScript(b, i, j))
```

$$x_a^{b_i^j}$$

## Example 3

Use `Symbol::subSuperScript` or `$` to create an expression with both sub- and superscript properly aligned one above the other:

```
Symbol::subSuperScript(a,b,c)
```

$$a_b^c$$

If you use the shortcut `$`, put the expression in single quotation marks:

```
`a$bc`
```

$$a_b^c$$

If you use `a_b^c`, it creates the subscripted expression `a_b` and then attaches the superscript `c` to that expression. In this case, the letters `b` and `c` do not appear one above the other.

`a_b^c`

A mathematical expression where the letter 'a' is followed by a subscript 'b' and a superscript 'c'. The entire expression is rendered in a purple color.

The same happens when you use a nested call to `Symbol::subScript` and `Symbol::superScript`:

`Symbol::superScript(Symbol::subScript(a, b), c)`

A mathematical expression where the letter 'a' is followed by a subscript 'b' and a superscript 'c'. The entire expression is rendered in a purple color.

## Example 4

If you want to create identifiers in which the five special characters (`_`, `^`, `$`, `{`, `}`) appear explicitly, use string arguments:

`Symbol::subSuperScript("a", "b_c", "d_e")`

A mathematical expression where the letter 'a' is followed by a subscript 'b\_c' and a superscript 'd\_e'. The entire expression is rendered in a purple color.

## Parameters

`a`, `b`, `c`

Arbitrary expressions

## Return Values

Identifier

## See Also

### **MuPAD Functions**

`Symbol::subScript` | `Symbol::superScript`

# Symbol::superScript

Combines two expressions to a new superscripted identifier

## Syntax

Symbol::superScript(a, b)

## Description

Creates a new superscripted identifier, such as  $a^b$ . If the arguments are not yet identifiers, they are first converted into identifiers.

You can also use `_`, `^`, `$`, `{`, and `}` to create arguments with superscripts and subscripts. For these arguments a new superscripted identifier appears on top of the existing ones:

$a^{b^c}$  or  $a^{b^d}$ .

## Examples

### Example 1

Even if  $X1$  and  $X2$  look identical, only  $X1$  is an identifier whereas  $X2$  is a `_power-expression`:

```
X1 := Symbol::superScript(x, 2): X2 := x^2:
X1, X2; domtype(X1), domtype(X2)
```

$x^2, x^2$

DOM\_IDENT, DOM\_EXPR

Pre-scripts are possible by superscripting the empty identifier `` and appending an identifier:

```
Symbol::superScript(``, 1).x
```

 $x^1$ 

## Example 2

You can use the nested form of the function:

```
Symbol::superScript(x, Symbol::superScript(i, j))
```

 $x^{i^j}$ 

## Example 3

Use `Symbol::subSuperScript` or `$` to create an expression with both sub- and superscript properly aligned one above the other:

```
Symbol::subSuperScript(a,b,c)
```

 $a_b^c$ 

If you use the shortcut `$`, put the expression in single quotation marks:

```
`a$bc`
```

 $a_b^c$ 

If you use `a_b^c`, it creates the subscripted expression `a_b` and then attaches the superscript `c` to that expression. In this case, the letters `b` and `c` do not appear one above the other.

```
a_b^c
```



$$a_b^c$$

The same happens when you use a nested call to `Symbol::subScript` and `Symbol::superScript`:

```
Symbol::superScript(Symbol::subScript(a, b), c)
```

$$a_b^c$$

## Example 4

If you want to create identifiers in which the five special characters (`_`, `^`, `$`, `{`, `}`) appear explicitly, use string arguments:

```
Symbol::superScript("a", "b^c")
```

$$a^{b^c}$$

## Parameters

**a, b**

Arbitrary expressions

## Return Values

Identifier

## See Also

### MuPAD Functions

`Symbol::subScript` | `Symbol::subSuperScript`



# Type - Type Checking and Mathematical Properties

---

## Type::AlgebraicConstant

Type representing algebraic constants

### Syntax

```
testtype(obj, Type::AlgebraicConstant)
```

### Description

Type::AlgebraicConstant represents algebraic constants.

In MuPAD, algebraic constants are characterized as follows: a complex number is an algebraic constant, if both its real part and its imaginary part are rational. Sums and products of algebraic constants are again algebraic constants. Further, rational powers of algebraic constants are again algebraic constants.

Taken together, these rules characterize algebraic constants over the rationals defined as usual, i.e., as roots of polynomial expressions.

This type does not represent a property: it cannot be used in `assume` to mark an identifier as an algebraic constant.

### Examples

#### Example 1

The following number is composed of radicals involving rational numbers and therefore is an algebraic constant:

```
testtype((3^(1/2)*I + 1/8)^(1/7), Type::AlgebraicConstant)
```

TRUE

The following objects are not algebraic constants:

```
testtype(2^I, Type::AlgebraicConstant),  
testtype(PI, Type::AlgebraicConstant)
```

```
FALSE, FALSE
```

## Example 2

Symbolic objects cannot represent algebraic constants:

```
testtype(x, Type::AlgebraicConstant)
```

```
FALSE
```

## Example 3

The following call selects the algebraic constants in an expression:

```
select(x + PI + 2^(1/2) + I, testtype, Type::AlgebraicConstant)
```

```
 $\sqrt{2} + i$ 
```

## Parameters

**obj**

Any MuPAD object

## Return Values

See `testtype`

## See Also

### **MuPAD Functions**

Type::Constant | testtype

# Type::AnyType

Type representing arbitrary MuPAD objects

## Syntax

```
testtype(obj, Type::AnyType)
```

## Description

Type::AnyType represents arbitrary MuPAD objects.

This type is meant to represent arbitrary MuPAD objects in constructors of composite types such as Type::ListOf.

This type does not represent a property: it cannot be used in `assume`.

## Examples

### Example 1

Any object matches this type:

```
testtype(3, Type::AnyType),  
testtype(x, Type::AnyType),  
testtype(array(1..1, [x]), Type::AnyType),  
testtype(Dom::Matrix(), Type::AnyType)
```

TRUE, TRUE, TRUE, TRUE

This type is meant for constructing composite types. The following call tests, whether an object is a list with arbitrary elements:

```
testtype([3, x, array(1..1, [x]), Dom::Matrix()],  
         Type::ListOf(Type::AnyType))
```

TRUE

## Parameters

**obj**

Any MuPAD object

## Return Values

testtype always returns TRUE

## See Also

**MuPAD Functions**

testtype



# Type::Arithmetical

Type representing arithmetical objects

## Syntax

```
testtype(obj, Type::Arithmetical)
```

## Description

Type::Arithmetical represents arithmetical objects.

In MuPAD, arithmetical objects are objects that represent complex numbers if all identifiers in them also represent complex numbers. Arithmetical objects include numbers, most expressions, and elements of certain library domains. In particular, the latter include `rectform` objects and series expansions of domain type `Series::Puisseux`.

Certain infinite objects such as `dirac(0)`, `infinity`, or `complexInfinity` are also defined to be arithmetical expressions.

The following objects are *not* regarded as arithmetical objects:

- equations and inequalities,
- Boolean objects and Boolean expressions involving `and`, `or`, `not`,
- lists,
- sets and set expressions involving `union`, `intersect`, `minus`,
- polynomials of domain type `DOM_POLY`,
- functions and procedures,
- arrays and tables.

This type does not represent a property: it cannot be used in `assume` to mark an identifier as an arithmetical object.

## Examples

### Example 1

The expression  $\overline{BAB}$  may represent a matrix if  $A$  and  $B$  are matrices, or it may represent a number if  $A$  and  $B$  are numbers. However, MuPAD regards identifiers as numbers: hence they commute with each other, and a product of identifiers represents a number, too:

```
A(-1) * B * A * B
```

$B^2$

```
testtype(%, Type::Arithmetical)
```

TRUE

### Example 2

Numbers and expressions are regarded as arithmetical objects:

```
testtype(3 + I, Type::Arithmetical),  
testtype(x + sqrt(2) + I*PI, Type::Arithmetical),  
testtype(x/y + y/x, Type::Arithmetical)
```

TRUE, TRUE, TRUE

Equations and inequalities are not regarded as arithmetical objects:

```
testtype(x2 = 2, Type::Arithmetical),  
testtype(x <> 2, Type::Arithmetical),  
testtype(x < 2, Type::Arithmetical),  
testtype(x >= 2, Type::Arithmetical)
```

FALSE, FALSE, FALSE, FALSE

Sets, lists, tables and arrays are not arithmetical:

```
testtype({a, b, c}, Type::Arithmetical),  
testtype(array(1..1, [x]), Type::Arithmetical)
```

FALSE, FALSE

Most domain objects such as matrices of some matrix domain are not arithmetical:

```
testtype(Dom::Matrix()([[1, 2], [3, 4]]), Type::Arithmetical)
```

FALSE

## Parameters

**obj**

Any MuPAD object

## Return Values

See `testtype`

## See Also

**MuPAD Functions**

`testtype`

## Type::Boolean

Type representing boolean expressions

### Syntax

```
testtype(obj, Type::Boolean)
```

### Description

Type::Boolean represents logical formulas.

Boolean expressions are all of the following objects: the Boolean constants TRUE, FALSE, and UNKNOWN; identifiers; equations and inequalities; expressions with operator and, or, not, xor, \_implies, \_equiv if each operand is a Boolean expression; or results returned by `solveLib::isEmpty`.

### Examples

#### Example 1

Identifiers and boolean constants are Boolean expressions:

```
testtype(TRUE, Type::Boolean), testtype(a, Type::Boolean)
```

```
TRUE, TRUE
```

#### Example 2

In order that an expression be Boolean, it is not sufficient that only its operator is a logical operator; also its operands must be Boolean expressions.

```
testtype(a >= 3 and b, Type::Boolean);  
testtype(a+b and c, Type::Boolean)
```

TRUE

FALSE

## Parameters

**obj**

Any MuPAD object

## Return Values

See `testtype`

## See Also

**MuPAD Functions**

`testtype`

## Type::Complex

Type and property representing complex numbers

### Syntax

```
testtype(obj, Type::Complex)
```

```
assume(x, Type::Complex)
```

```
is(ex, Type::Complex)
```

### Description

`Type::Complex` represents complex numbers. This type can also be used as a property to mark identifiers as complex numbers.

The call `testtype(obj, Type::Complex)` checks, whether `obj` is a complex number and returns `TRUE`, if it holds, otherwise `FALSE`.

`testtype` only performs a syntactical test identifying MuPAD objects of type `DOM_INT`, `DOM_RAT`, `DOM_FLOAT` and `DOM_COMPLEX`. This does not include arithmetical expressions such as `exp(1)`, which are not identified as of type `Type::Complex`.

The call `assume(x, Type::Complex)` marks the identifier `x` as a complex number.

The call `is(ex, Type::Complex)` derives, whether the expression `ex` is a complex number (or this property can be derived).

This type represents a property that can be used in `assume` and `is`.

### Examples

#### Example 1

The following numbers are of type `Type::Complex`:

```
testtype(2, Type::Complex),
testtype(3/4, Type::Complex),
testtype(0.123, Type::Complex),
testtype(1 + I/3, Type::Complex),
testtype(1.0 + 2.0*I, Type::Complex)
```

TRUE, TRUE, TRUE, TRUE, TRUE

The following expressions are exact representations of complex numbers. Syntactically, however, they are not of type `Type::Complex`:

```
testtype(exp(3), Type::Complex),
testtype(PI^2 + 5, Type::Complex),
testtype(sin(2) + PI*I, Type::Complex)
```

FALSE, FALSE, FALSE

## Example 2

Identifiers may be assumed to represent a complex number:

```
assume(x, Type::Complex): is(x, Type::Complex)
```

TRUE

The real numbers are a subset of the complex numbers:

```
assume(x, Type::Real): is(x, Type::Complex)
```

TRUE

Without further information, it cannot be decided whether a complex number is real:

```
assume(x, Type::Complex): is(x, Type::Real)
```

UNKNOWN

```
unassume(x):
```

## Parameters

**obj**

Any MuPAD object

**x**

An identifier

**ex**

An arithmetical expression (Symbolic Math Toolbox)

## Return Values

See `assume`, `is` and `testtype`

## See Also

### **MuPAD Functions**

`Type::Imaginary` | `Type::Property` | `Type::Real` | `assume` | `is` | `testtype`



# Type::ConstantIds

Set of constant identifiers in MuPAD

## Syntax

`contains(Type::ConstantIds, obj)`

## Description

`Type::ConstantIds` is the set { CATALAN , E , EULER , I , PI }.

`Type::ConstantIds` is the set on page 7-50 of identifiers on page 7-29 that represent constants. As of version 4.0, these are CATALAN (Symbolic Math Toolbox), E (Symbolic Math Toolbox) (= `exp(1)`), EULER (Symbolic Math Toolbox), I (Symbolic Math Toolbox), PI (Symbolic Math Toolbox).

These constants will be returned by the function `indets`, but they cannot be treated like other identifiers. For example, they cannot have properties or be the left-hand side of an assignment on page 1-257.

See “Example 1” on page 33-15 (Symbolic Math Toolbox) for an application.

`Type::Constant` makes use of `Type::ConstantIds`, see “Example 2” on page 33-16 (Symbolic Math Toolbox).

## Examples

### Example 1

MuPAD implements  $\pi$  as the identifier PI (Symbolic Math Toolbox).

```
domtype(PI)
```

```
DOM_IDENT
```

However, PI is constant:

```
testtype(PI, Type::Constant)
```

TRUE

Still, `indets` regards PI as an identifier with no value (which is syntactically correct), and you can even use PI as an indeterminate of a polynomial on page 1-1601:

```
indets(PI/2*x);
poly(PI/2*x)
```

{x, π}

$\text{poly}\left(\frac{\pi x}{2}, [x, \pi]\right)$

To find the “real” indeterminates, use the following call:

```
indets(PI/2*x) minus Type::ConstantIdents
```

{x}

## Example 2

In the following, the `solve` command solves for all identifiers found in the equation:

```
solve(x^2 = KHINTCHINE)
```

{ [KHINTCHINE = z<sup>2</sup>, x = z] }

Assume you want MuPAD to regard the identifier KHINTCHINE as a constant. (Probably, it should represent the Khintchine constant  $K$ , which is approximately 2.685452.) First of all, you should make sure that the identifier does not have a value yet and protect on page 1-1679 it:

```
testtype(KHINTCHINE, DOM_IDENT);
protect(KHINTCHINE, ProtectLevelError)
```

```
TRUE
```

```
ProtectLevelNone
```

Next, add KHINTCHINE to `Type::ConstantIdents` (note that we have to unprotect the identifier `Type`, because `Type::ConstantIdents` is a slot on page 1-1980 of it):

```
old_protection := unprotect(Type):
Type::ConstantIdents := Type::ConstantIdents union {KHINTCHINE}:
protect(Type, old_protection):
Type::ConstantIdents
```

```
{i, KHINTCHINE, CATALAN, EULER, pi, e}
```

Now, MuPAD regards KHINTCHINE as a constant:

```
testtype(sin(PI + KHINTCHINE), Type::Constant)
```

```
TRUE
```

After clearing the remember table of `solve`, we now obtain:

```
solve(Remember, Clear):
solve(x^2 = KHINTCHINE)
```

```
{[x =  $\sqrt{\text{KHINTCHINE}}$ ], [x =  $-\sqrt{\text{KHINTCHINE}}$ ]}
```

## Parameters

**obj**

Any MuPAD object

## **Return Values**

See `contains`

## **See Also**

### **MuPAD Functions**

`Type::Constant` | `Type::Indeterminate` | `contains` | `indets`

# Type::Constant

Type representing constant objects

## Syntax

```
testtype(obj, Type::Constant)
```

## Description

`Type::Constant` represents constant objects, i.e., objects not containing symbolic identifiers.

Numbers, strings, Boolean constants, `NIL`, `FAIL` and the identifiers `PI` (Symbolic Math Toolbox), `EULER` (Symbolic Math Toolbox) and `CATALAN` (Symbolic Math Toolbox) in the set `Type::ConstantIdentifiers` are regarded as constant objects. A composite object is constant, if all its operands are constant.

Any function is identified as a constant, if all arguments are constant, also if the function is not defined (e.g., an identifier).

This type does not represent a property: it cannot be used in `assume` to mark an identifier as a constant.

## Examples

### Example 1

The following objects are elementary constants:

```
testtype(3, Type::Constant),  
testtype(sin(3/2), Type::Constant),  
testtype(TRUE, Type::Constant),  
testtype("MuPAD", Type::Constant),  
testtype(FAIL, Type::Constant)
```

TRUE, TRUE, TRUE, TRUE, TRUE

The following expression contains an indeterminate  $x$  and, consequently, is not a constant object:

```
testtype(exp(x + 1), Type::Constant)
```

FALSE

All constant operands of an expression are selected on page 1-1828:

```
select(x^2 + 3*x - 2, testtype, Type::Constant)
```

-2

Any function call is considered constant, if the arguments are constant:

```
testtype(f(1, 2, 3, 4), Type::Constant)
```

TRUE

## Parameters

**obj**

Any MuPAD object

## Return Values

See `testtype`

## See Also

### MuPAD Functions

testtype

## Type::Equation

Type representing equations

### Syntax

```
testtype(obj, Type::Equation(<lhs_type, <rhs_type>>))
```

### Description

Type::Equation represents equations. The types of the left hand side and the right hand side can be specified.

The call `testtype(obj, Type::Equation(lhs_type, rhs_type))` checks whether `type(obj)` yields `"_equal"` and `testtype(lhs(obj), lhs_type)` and `testtype(rhs(obj), rhs_type)` both yield `TRUE` and returns `TRUE`, if all holds, otherwise `FALSE`.

The two optional parameters `lhs_type` and `rhs_type` determine the types of the left hand side and the right hand side, respectively.

The default values of `lhs_type` and `rhs_type` are `Type::AnyType`.

---

**Note** The equations `lhs=rhs` and `rhs=lhs` are considered different! E.g., the equation `x=3` matches the type `Type::Equation(DOM_IDENT, DOM_INT)`, but it does not match the type `Type::Equation(DOM_INT, DOM_IDENT)`.

---

This type does not represent a property, it cannot be used in an `assume` call.

## Examples

### Example 1

The following object is an equation:



```
testtype(x = 3, Type::Equation())
```

```
TRUE
```

The following calls test, whether the object is an equation with an unknown on the left hand side and a positive integer on the right hand side:

```
testtype(x = 3, Type::Equation(Type::Unknown, Type::PosInt)),  
testtype(x = 0, Type::Equation(Type::Unknown, Type::PosInt))
```

```
TRUE, FALSE
```

## Parameters

### **obj**

Any MuPAD object

### **lhs\_type**

The type of the left hand side; a type can be an object of the library Type or one of the possible return values of domtype and type

### **rhs\_type**

The type of the right hand side

## Return Values

See testtype

## See Also

### **MuPAD Functions**

testtype

## Type::Even

Type and property representing even integers

### Syntax

```
testtype(obj, Type::Even)
```

```
assume(x, Type::Even)
```

```
is(ex, Type::Even)
```

### Description

Type::Even represents even integers. This type can also be used as a property to mark identifiers as even integers.

The call `testtype(obj, Type::Even)` checks, whether `obj` is an even number and returns TRUE, if it holds, otherwise FALSE.

`testtype` only performs a syntactical test identifying MuPAD objects of type `DOM_INT` and checks, if `bool(domtype(x/2) = DOM_INT)` holds.

The call `assume(x, Type::Even)` marks the identifier `x` as an even number.

The call `is(ex, Type::Even)` derives, whether the expression `ex` is an even number (or this property can be derived).

This type represents a property that can be used in `assume` and `is`.

## Examples

### Example 1

The following numbers are of type `Type::Even`:

```
testtype(2, Type::Even),
testtype(-4, Type::Even),
testtype(8, Type::Even),
testtype(-11114, Type::Even),
testtype(4185296581467695598, Type::Even)
```

TRUE, TRUE, TRUE, TRUE, TRUE

## Example 2

We use this type as a property:

```
assume(x, Type::Even):
```

The following calls to `is` derive the properties of a composite expression from the properties of its indeterminates:

```
is(3*x^2, Type::Even), is(x + 1, Type::Even)
```

TRUE, FALSE

```
is(x, Type::Integer), is(2*x, Type::Integer),
is(x/2, Type::Integer), is(x/3, Type::Integer)
```

TRUE, TRUE, TRUE, UNKNOWN

```
assume(y, Type::Odd): is(x + y, Type::Even)
```

FALSE

```
is(2*(x + y), Type::Even)
```

TRUE

```
delete x, y:
```

## Parameters

**obj**

Any MuPAD object

**x**

An identifier on page 7-29 or a mathematical expression containing identifiers

**ex**

An arithmetical expression (Symbolic Math Toolbox)

## Return Values

See `assume`, `is` and `testtype`

## See Also

### **MuPAD Functions**

`Type::Odd` | `Type::Property` | `assume` | `is` | `testtype`

# Type::Function

Type representing functions

## Syntax

```
testtype(obj, Type::Function)
```

## Description

Type::Function represents all MuPAD functions (procedures, executable objects etc).

The call `testtype(obj, Type::Function)` checks, whether `obj` is an executable MuPAD object. The call returns TRUE or FALSE, respectively.

“Executable objects” in MuPAD are procedures (of type `DOM_PROC`), function environments (of type `DOM_FUNC_ENV`), and pure kernel functions (of type `DOM_EXEC`).

Additionally, symbolic function iterates on page 1-77f@@n (representing the map  $x \rightarrow f(\dots(f(x))\dots)$ ) and symbolic function compositions on page 1-74f@g (representing the function  $x \rightarrow f(g(x))$ ) are regarded as executable objects.

This type does not represent a property.

## Examples

### Example 1

Type::Function accepts procedures:

```
testtype(proc(x) begin x^2 end, Type::Function)
```

TRUE

`Type::Function` accepts simple procedures generated with the “arrow operator” `->`, too:

```
testtype(x -> x^2, Type::Function)
```

**TRUE**

`sin` is a function environment, accepted by `Type::Function`:

```
testtype(sin, Type::Function)
```

**TRUE**

The first operand of the function environment `print` is a pure kernel function, accepted by `Type::Function`:

```
testtype(op(print, 1), Type::Function)
```

**TRUE**

The 3-fold iterate of the function `diff` is accepted by `Type::Function`:

```
testtype(diff@@3, Type::Function)
```

**TRUE**

The composition of functions is accepted by `Type::Function`:

```
testtype(f@g, Type::Function)
```

**TRUE**

Any other MuPAD object is determined as non executable object by `Type::Function`:

```
map([1, TRUE, x, {}], testtype, Type::Function)
```

**[FALSE, FALSE, FALSE, FALSE]**

## Parameters

**obj**

Any MuPAD object

## Return Values

See `testtype`

## See Also

**MuPAD Functions**

`testtype`

## Type::Imaginary

Type and property representing imaginary numbers

### Syntax

```
testtype(obj, Type::Imaginary)
```

```
assume(x, Type::Imaginary)
```

```
is(ex, Type::Imaginary)
```

### Description

Type::Imaginary represents complex numbers with vanishing real part. This type can also be used as a property to mark identifiers as imaginary numbers.

The call `testtype(obj, Type::Imaginary)` checks, whether `obj` is an imaginary number (or zero) and returns TRUE, if it holds, otherwise FALSE.

`testtype` only performs a syntactical test identifying MuPAD objects of type `DOM_COMPLEX` and checks, whether `iszero(Re(obj))` holds, or whether `iszero(obj)` is TRUE. This does not include arithmetical expressions such as `I*exp(1)`, which are not identified as of type `Type::Imaginary`.

The call `assume(x, Type::Imaginary)` marks the identifier `x` as an imaginary number.

The call `is(ex, Type::Imaginary)` derives, whether the expression `ex` is an imaginary number (or this property can be derived).

This type represents a property that can be used in `assume` and `is`.

The call `assume(Re(x) = 0)` has the same meaning as `assume(x, Type::Imaginary)`.



## Examples

### Example 1

The following numbers are of type `Type::Imaginary`:

```
testtype(5*I, Type::Imaginary),
testtype(3/2*I, Type::Imaginary),
testtype(-1.23*I, Type::Imaginary)
```

TRUE, TRUE, TRUE

The following expressions are exact representations of imaginary numbers. However, syntactically they are not of type `Type::Imaginary`, because their domain type is not `DOM_COMPLEX`:

```
testtype(exp(3)*I, Type::Imaginary),
testtype(PI*I, Type::Imaginary),
testtype(sin(2*I), Type::Imaginary)
```

FALSE, FALSE, FALSE

In contrast to `testtype`, the function `is` performs a semantical test:

```
is(exp(3)*I, Type::Imaginary),
is(PI*I, Type::Imaginary),
is(sin(2*I), Type::Imaginary)
```

TRUE, TRUE, TRUE

### Example 2

Identifiers may be assumed to represent an imaginary number:

```
assume(x, Type::Imaginary): is(x, Type::Imaginary), Re(x), Im(x)
```

TRUE, 0,  $-x i$

The imaginary numbers are a subset of the complex numbers:

```
is(x, Type::Complex)
```

```
TRUE
```

```
unassume(x):
```

## Parameters

**obj**

Any MuPAD object

**x**

An identifier

**ex**

An arithmetical expression (Symbolic Math Toolbox)

**obj**

Any MuPAD object

## Return Values

See `assume`, `is` and `testtype`

## See Also

### MuPAD Functions

`Type::Complex` | `Type::Property` | `assume` | `is` | `testtype`

# Type::IndepOf

Type representing objects that do not contain given identifiers

## Syntax

```
testtype(obj, Type::IndepOf(x))
```

```
testtype(obj, Type::IndepOf({x1, x2, ...}))
```

## Description

`Type::IndepOf(x)` represents objects that do not contain the identifier `x`.

`Type::IndepOf({x1, x2, ...})` represents objects that do not contain any of the identifiers `x1`, `x2` etc.

The call `testtype(obj, Type::IndepOf(x))` checks, whether `obj` does not contain the identifier `x` and returns a corresponding `TRUE` or `FALSE`.

`Type::IndepOf` uses `has` to check whether the object contains at least one of the specified identifiers.

This type does not represent a property.

## Examples

### Example 1

The following expression depends on `x`:

```
testtype(x^2 - x + 3, Type::IndepOf(x))
```

`FALSE`

It is independent of y:

```
testtype(x^2 - x + 3, Type::IndepOf(y))
```

TRUE

The following expression is independent of x and y:

```
testtype(2*(a + b)/c, Type::IndepOf({x, y}))
```

TRUE

The following call selects on page 1-1828 all operands of the expression that are independent of x:

```
select(sin(y) + x^2 - 3*x + 2, testtype, Type::IndepOf(x))
```

$\sin(y) + 2$

## Parameters

**obj**

Any MuPAD object

**x, x1, x2**

Identifiers of domain type DOM\_IDENT

## Return Values

See testtype

## See Also

### **MuPAD Functions**

Type::Indeterminate | has | indets | testtype

## Type::Indeterminate

Type representing indeterminates

### Syntax

```
testtype(obj, Type::Indeterminate)
```

### Description

Type::Indeterminate represents all objects that MuPAD regards as indeterminates: identifiers on page 7-29 except those in Type::ConstantIdsents, plus indexed identifiers on page 1-1017.

This type does not represent a property: it cannot be used in assume to mark an identifier as an algebraic constant.

### Examples

#### Example 1

The following call selects all indeterminates from a list:

```
delete x:  
testtype(x, Type::Indeterminate),  
testtype(sqrt(2), Type::Indeterminate);
```

TRUE, FALSE

```
l := [x, x[2], x[sqrt(2) + I], x[x], PI, PI[1], sin(x), 3.0];  
select(l, testtype, Type::Indeterminate)
```

$[x, x_2, x_{\sqrt{2}+i}, x_x, \pi, \pi_1, \sin(x), 3.0]$

$[x, x_2, x_{\sqrt{2}+i}, x_x, \pi_1]$ 

Note that `testtype` evaluates its arguments:

```
y := 5;  
testtype(y, Type::Indeterminate),  
testtype(hold(y), Type::Indeterminate);
```

5

FALSE, TRUE

## Parameters

**obj**

Any MuPAD object

## Return Values

See `testtype`

## See Also

**MuPAD Domains**

DOM\_IDENT

**MuPAD Functions**Type::ConstantIdents | Type::IndepOf | `_index` | `indets` | `testtype`

## Type::Integer

Type and property representing integers

### Syntax

```
testtype(obj, Type::Integer)
```

```
assume(x, Type::Integer)
```

```
is(ex, Type::Integer)
```

### Description

`Type::Integer` represents integers. This type can also be used as a property to mark identifiers as integers.

The call `testtype(obj, Type::Integer)` checks, whether `obj` is an integer number and returns `TRUE`, if it holds, otherwise `FALSE`.

`testtype` only performs a syntactical test identifying MuPAD objects of type `DOM_INT`.

The call `assume(x, Type::Integer)` marks the identifier `x` as an integer number.

The call `is(ex, Type::Integer)` derives, whether the expression `ex` is an integer number (or this property can be derived).

This type represents a property that can be used in `assume` and `is`.

### Examples

#### Example 1

The following numbers are of type `Type::Integer`:

```
testtype(0, Type::Integer), testtype(55, Type::Integer),  
testtype(-111, Type::Integer)
```



TRUE, TRUE, TRUE

## Example 2

We use this type as a property:

```
assume(x, Type::Integer):
```

The following calls to `is` derive the properties of a composite expression from the properties of its indeterminates:

```
is(3*x, Type::Real), is(2*x, Type::Even), is(x/2, Type::Integer)
```

TRUE, TRUE, UNKNOWN

```
assume(y, Type::Integer): is(x + y^2, Type::Integer)
```

TRUE

```
unassume(x), unassume(y):
```

## Parameters

### **obj**

Any MuPAD object

### **x**

An identifier on page 7-29 or a mathematical expression containing identifiers

### **ex**

An arithmetical expression (Symbolic Math Toolbox)

## **Return Values**

See `assume`, `is` and `testtype`

## **See Also**

### **MuPAD Functions**

`Type::Property` | `Type::Real` | `assume` | `is` | `testtype`

# Type::Intersection

Type representing the intersection of several types

## Syntax

```
testtype(obj, (obj_type, ...))
```

## Description

`Type::Intersection(type1, type2, ...)` represents all objects having all of the types `type1, type2, ...`

The call `testtype(obj, Type::Intersection(obj_types, ...))` checks, whether `obj` has all the given types `obj_types, ...`

The call `testtype(obj, Type::Intersection(obj_types, ...))` is thus equivalent to the call `_lazy_and(map(obj_types, x -> testtype(obj, x)))`, testing `obj` against all types in turn.

`obj_types, ...` must be a (nonempty) sequence on page 1-88 of types (see `testtype`).

This type does not represent a property.

## Examples

### Example 1

Check, whether the given object is a positive and odd integer:

```
testtype(1, Type::Intersection(Type::PosInt, Type::Odd))
```

TRUE

2 however, is not a positive and a odd number:

```
testtype(2, Type::Intersection(Type::PosInt, Type::Odd))
```

```
FALSE
```

## Example 2

testtype is used to select on page 1-1828 positive and odd integers:

```
SET:= {-2, -1.5, -1, -0.5, 0, 0.5, 1, 1.5, 2, 3};  
select(SET, testtype, Type::Intersection(Type::PosInt, Type::Odd))
```

```
{1, 3}
```

```
delete SET:
```

## Parameters

**obj**

Any MuPAD object

**obj\_type, ...**

A sequence of types; a type can be an object of the library Type (Symbolic Math Toolbox) or one of the possible return values of domtype and type

## Return Values

See testtype

## See Also

**MuPAD Functions**

testtype

# Type::Interval

Property representing intervals

## Syntax

`Type::Interval(a, b, <ndomain>)`

`Type::Interval([a], b, <ndomain>)`

`Type::Interval(a, [b], <ndomain>)`

`Type::Interval([a], [b], <ndomain>)`

`Type::Interval([a, b], <ndomain>)`

## Description

`Type::Interval(a, b, ...)` represents the interval  $(a, b)$ .

`Type::Interval([a], b, ...)` represents the interval  $[a, b)$ .

`Type::Interval(a, [b], ...)` represents the interval  $(a, b]$ .

`Type::Interval([a], [b], ...)` represents the interval  $[a, b]$ .

`Type::Interval([a, b], ...)` represents the interval  $[a, b]$ .

With the default domain `Type::Real`, the type object created by `Type::Interval` represents a real interval, i.e., the set of all real numbers between the border points `a` and `b`. If another domain is specified, then the type object represents the intersection of the real interval with the set represented by the domain. E.g., `Type::Interval(a, b, Type::Rational)` represents the set of all rational numbers between `a` and `b`, and `Type::Interval([a, b], Type::Residue(0, 2))` represents the set of all even integers between `a` and `b` including `a` and `b`.

The type object represents a property that may be used in `assume` and `is`. With

```
assume(x, Type::Interval(a, b, ndomain))
```

the identifier  $x$  is marked as a number from the interval represented by the type object.  
With

```
is(x, Type::Interval(a, b, ndomain))
```

one queries, whether  $x$  is contained in the interval.

Interval types should not be used in `testtype`. No MuPAD object matches these types syntactically, i.e., `testtype` always returns `FALSE`.

## Examples

### Example 1

The following type object represents the open interval  $(-1, 1)$ :

```
Type::Interval(-1, 1)
```

```
Type::Interval(-1, 1, Type::Real)
```

The following calls are equivalent: both create the type representing a closed interval:

```
Type::Interval([-1], [1]), Type::Interval([-1, 1])
```

```
Type::Interval([-1], [1], Type::Real), Type::Interval([-1, 1], Type::Real)
```

The following call creates the type representing the set of all integers from  $-10$  to  $10$ :

```
Type::Interval([-10, 10], Type::Integer)
```

```
Type::Interval([-10], [10], Type::Integer)
```

The following call creates the type representing the set of all rational numbers in the interval  $[0, 1)$ :

```
Type::Interval([0], 1, Type::Rational)
```

```
Type::Interval([0], 1, Type::Rational)
```

The following calls create the types representing the sets of all even/odd integers in the interval  $[-10, 10]$ :

```
Type::Interval([-10], [10], Type::Even),
Type::Interval([-10], [10], Type::Odd)
```

```
Type::Interval([-10], [10], Type::Residue(0, 2, Type::Integer)),
Type::Interval([-10], [10], Type::Residue(1, 2, Type::Integer))
```

## Example 2

We use intervals as a property. The following call marks  $x$  as a real number from the interval  $[0, 2]$ :

```
assume(x, Type::Interval([0], 2)):
```

Consequently,  $x^2 + 1$  lies in the interval  $[1, 5]$ :

```
is(x^2 + 1 >= 1), is(x^2 + 1 < 5)
```

```
TRUE, TRUE
```

The following call marks  $x$  as an integer larger than -10 and smaller than 100:

```
assume(x, Type::Interval(-10, 100, Type::Integer)):
```

Consequently,  $x^3$  is an integer larger than -730 and smaller than 970300:

```
is(x^3, Type::Integer), is(x^3 >= -729), is(x^3 < 970300),
is(x^3, Type::Interval(-10^3, 100^3, Type::Integer))
```

```
TRUE, TRUE, TRUE, TRUE
```

```
is(x <= -730), is(x^3 >= 970300)
```

FALSE, FALSE

`is(x > 0), is(x^3, Type::Interval(0, 10, Type::Integer))`

UNKNOWN, UNKNOWN

`unassume(x):`

## Parameters

**a, b**

The borders of the interval: arithmetical objects on page 33-7

**ndomain**

A type object such as `Type::Real`, `Type::Integer` or `Type::Rational` representing a subset of the real numbers or a property representing a residue class as `Type::Residue(0, 2)`. The default domain is `Type::Real`.

## Return Values

Type object

## See Also

### MuPAD Functions

`Type::Integer` | `Type::Rational` | `Type::Real` | `Type::Residue` | `assume` | `is` | `testtype`



# Type::ListOf

Type representing lists of objects with the same type

## Syntax

```
testtype(obj, Type::ListOf(obj_type, <min_nr, <max_nr>>))
```

## Description

Type::ListOf describes lists of objects of a specified type.

The call `testtype(obj, Type::ListOf(obj_types, ...))` checks, whether `obj` is a list on page 7-41 with elements of the given type `obj_type, ...` and returns `TRUE`, if it holds, otherwise `FALSE`.

The two optional parameters `min_nr` and `max_nr` determine the minimum and maximum number of elements in the analyzed list. If the numbers are not be given, the number of elements in the list will not be checked. If only the minimum is given, only the minimal number of elements in the list is checked.

Note especially that `Type::Union` provides a way to allow more than one type for the list elements.

This type does not represent a property.

## Examples

### Example 1

Is the given list a list of identifiers?

```
testtype([a, b, c, d, e, f], Type::ListOf(DOM_IDENT))
```

`TRUE`

Is the given list a list of at least five real numbers?

```
testtype([0, 0.5, 1, 1.5, 2, 2.5, 3], Type::ListOf(Type::Real, 5))
```

TRUE

## Example 2

testtype is used to select on page 1-1828 lists with exactly two identifiers:

```
S := {[a], [a, b], [d, 1], [0, d], [e], [d, e]}:  
select(S, testtype, Type::ListOf(DOM_IDENT, 2, 2))
```

{[a, b], [d, e]}

## Parameters

**obj**

Any MuPAD object

**obj\_type**

The type of the objects; a type can be an object of the library Type (Symbolic Math Toolbox) or one of the possible return values of domtype and type

**min\_nr**

The minimal number of objects as nonnegative integer

**max\_nr**

The maximal number of objects as nonnegative integer

## Return Values

See testtype

## See Also

### **MuPAD Domains**

DOM\_LIST

### **MuPAD Functions**

Type::ListProduct | Type::Set0f | Type::Union | testtype

## Type::**ListProduct**

Type representing lists

### Syntax

```
testtype(obj, Type::ListProduct(typedef, ...))
```

### Description

With `Type::ListProduct`, lists with different object types can be identified.

The call `testtype(obj, Type::ListProduct(typedef))` checks, whether `obj` is a list of objects, which have the types given by `typedef` and returns `TRUE`, if it holds, otherwise `FALSE`.

`obj` must have the same number of arguments as the sequence `typedef`. The elements of `obj` are checked one after another: the first element of `obj` is checked against the type given by the first element of `typedef`, and so on. All elements and types must match.

`typedef, ...` must be a nonempty sequence on page 1-88 of types. A type can be an object of the library `Type` (Symbolic Math Toolbox) or one of the possible return values of `domtype` and `type`.

This type does not represent a property.

### Examples

#### Example 1

The argument is a list of a positive integer followed by an identifier:

```
testtype([5, x], Type::ListProduct(Type::PosInt, Type::Unknown))
```

`TRUE`

Is the argument is a sequence of five positive integers?

```
testtype([5, 3, 5, -1, 0], Type::ListProduct(Type::PosInt $ 5))
```

**FALSE**

## Parameters

### **obj**

Any MuPAD object

### **typedef**

A sequence of types; a type can be an object of the library Type (Symbolic Math Toolbox) or one of the possible return values of `domtype` and `type`

## Return Values

See `testtype`

## See Also

### **MuPAD Functions**

Type::ListOf | Type::Product | `testtype`

## Type::NegInt

Type and property representing negative integers

### Syntax

```
testtype(obj, Type::NegInt)
```

```
assume(x, Type::NegInt)
```

```
is(ex, Type::NegInt)
```

### Description

Type::NegInt represents negative integers. Type::NegInt is a property, too, which can be used in an `assume` call.

The call `testtype(obj, Type::NegInt)` checks, whether `obj` is a negative integer number and returns TRUE, if it holds, otherwise FALSE.

`testtype` only performs a syntactical test identifying MuPAD objects of type `DOM_INT` and checks, if `bool(obj < 0)` holds.

The call `assume(x, Type::NegInt)` marks the identifier `x` as a negative integer number.

The call `is(ex, Type::NegInt)` derives, whether the expression `ex` is a negative integer number (or this property can be derived).

This type represents a property that can be used in `assume` and `is`.

### Examples

#### Example 1

The following numbers are of type `Type::NegInt`:

```
testtype(-2, Type::NegInt),  
testtype(-3, Type::NegInt),  
testtype(-55, Type::NegInt),  
testtype(-1, Type::NegInt),  
testtype(-111111111, Type::NegInt)
```

TRUE, TRUE, TRUE, TRUE, TRUE

## Example 2

Assume an identifier is a negative integer:

```
assume(x, Type::NegInt):  
is(x, Type::NegInt)
```

TRUE

Negative integers are integers, of course:

```
assume(x, Type::NegInt):  
is(x, Type::Integer)
```

TRUE

However, integers can be negative or not:

```
assume(x, Type::Integer):  
is(x, Type::NegInt)
```

UNKNOWN

delete x:

## Parameters

**obj**

Any MuPAD object

**x**

An identifier on page 7-29 or a mathematical expression containing identifiers

**ex**

An arithmetical expression (Symbolic Math Toolbox)

## **Return Values**

See `testtype`, `assume` and `is`

## **See Also**

### **MuPAD Functions**

`Type::Property` | `assume` | `is` | `testtype`



# Type::NegRat

Type and property representing negative rational numbers

## Syntax

```
testtype(obj, Type::NegRat)
```

```
assume(x, Type::NegRat)
```

```
is(ex, Type::NegRat)
```

## Description

Type::NegRat represents negative rational numbers. Type::NegRat is a property, too, which can be used in an `assume` call.

The call `testtype(obj, Type::NegRat)` checks, whether `obj` is a negative rational number and returns `TRUE`, if it holds, otherwise `FALSE`.

`testtype` only performs a syntactical test identifying MuPAD objects of type `DOM_INT` and `DOM_RAT` and checks, if `bool(obj < 0)` holds.

The call `assume(x, Type::NegRat)` marks the identifier `x` as a negative rational number.

The call `is(ex, Type::NegRat)` derives, whether the expression `ex` is a negative rational number (or this property can be derived).

This type represents a property that can be used in `assume` and `is`.

## Examples

### Example 1

The following numbers are of type `Type::NegRat`:

```
testtype(-2, Type::NegRat),  
testtype(-3/4, Type::NegRat),  
testtype(-55/111, Type::NegRat),  
testtype(-1, Type::NegRat),  
testtype(-111/111111, Type::NegRat)
```

TRUE, TRUE, TRUE, TRUE, TRUE

## Example 2

Assume an identifier is negative rational:

```
assume(x, Type::NegRat):  
is(x, Type::NegRat)
```

TRUE

Also negative rational numbers are rational:

```
assume(x, Type::NegRat):  
is(x, Type::Rational)
```

TRUE

However, rational numbers can be negative rational or not:

```
assume(x, Type::Rational):  
is(x, Type::NegRat)
```

UNKNOWN

```
delete x:
```

## Parameters

**obj**

Any MuPAD object

**x**

An identifier on page 7-29 or a mathematical expression containing identifiers

**ex**

An arithmetical expression (Symbolic Math Toolbox)

## **Return Values**

See `testtype`, `assume` and `is`

## **See Also**

### **MuPAD Functions**

Type::Property | `assume` | `is` | `testtype`

## Type::Negative

Type and property representing negative numbers

### Syntax

```
testtype(obj, Type::Negative)
```

```
assume(x, Type::Negative)
```

```
is(ex, Type::Negative)
```

### Description

Type::Negative represents negative numbers. Type::Negative is a property, too, which can be used in an `assume` call.

The call `testtype(obj, Type::Negative)` checks, whether `obj` is a negative real number and returns `TRUE`, if it holds, otherwise `FALSE`.

`testtype` only performs a syntactical test identifying MuPAD objects of type `DOM_INT`, `DOM_RAT` and `DOM_FLOAT` and checks, if `bool(obj < 0)` holds. This does not include arithmetical expressions such as `-exp(1)`, which are not identified as of type `Type::Negative`.

The call `assume(x, Type::Negative)` marks the identifier `x` as a negative real number.

The call `is(ex, Type::Negative)` derives, whether the expression `ex` is a negative real number (or this property can be derived).

This type represents a property that can be used in `assume` and `is`.

Instead of `Type::Negative` the assumption can also be `assume(x < 0)`.

## Examples

### Example 1

The following numbers are of type `Type::Negative`:

```
testtype(-2, Type::Negative),  
testtype(-3/4, Type::Negative),  
testtype(-0.123, Type::Negative),  
testtype(-1, Type::Negative),  
testtype(-1.02, Type::Negative)
```

TRUE, TRUE, TRUE, TRUE, TRUE

The following expressions are exact representations of negative numbers, but syntactically they are not of `Type::Negative`:

```
testtype(-exp(1), Type::Negative),  
testtype(-PI^2 - 5, Type::Negative),  
testtype(-sin(2), Type::Negative)
```

FALSE, FALSE, FALSE

### Example 2

Assume an identifier is negative:

```
assume(x, Type::Negative):  
is(x, Type::Negative)
```

TRUE

This is equal to:

```
assume(x < 0):  
is(x < 0)
```

TRUE

Also negative numbers are real:

```
assume(x, Type::Negative):  
is(x, Type::Real)
```

TRUE

However, real numbers can be negative or not:

```
assume(x, Type::Real):  
is(x, Type::Negative)
```

UNKNOWN

```
delete x:
```

## Parameters

### **obj**

Any MuPAD object

### **x**

An identifier on page 7-29 or a mathematical expression containing identifiers

### **ex**

An arithmetical expression (Symbolic Math Toolbox)

## Return Values

See `testtype`, `assume` and `is`

## See Also

### MuPAD Functions

Type::Property | Type::Real | assume | is | testtype

## Type::NonNegInt

Type and property representing nonnegative integers

### Syntax

```
testtype(obj, Type::NonNegInt)
```

```
assume(x, Type::NonNegInt)
```

```
is(ex, Type::NonNegInt)
```

### Description

Type::NonNegInt represents nonnegative integers. Type::NonNegInt is a property, too, which can be used in an assume call.

The call testtype(obj, Type::NonNegInt) checks, whether obj is a nonnegative integer number and returns TRUE, if it holds, otherwise FALSE.

testtype only performs a syntactical test identifying MuPAD objects of type DOM\_INT and checks, if bool(obj >= 0) holds.

The call assume(x, Type::NonNegInt) marks the identifier x as a nonnegative integer number.

The call is(ex, Type::NonNegInt) derives, whether the expression ex is a nonnegative integer number (or this property can be derived).

This type represents a property that can be used in assume and is.

### Examples

#### Example 1

The following numbers are of type Type::NonNegInt:



```
testtype(2, Type::NonNegInt),  
testtype(3/4, Type::NonNegInt),  
testtype(55/111, Type::NonNegInt),  
testtype(1, Type::NonNegInt),  
testtype(111/111111, Type::NonNegInt)
```

TRUE, FALSE, FALSE, TRUE, FALSE

## Example 2

Assume an identifier is nonnegative rational:

```
assume(x, Type::NonNegInt):  
is(x, Type::NonNegInt)
```

TRUE

Also nonnegative integers are integers:

```
assume(x, Type::NonNegInt):  
is(x, Type::Integer)
```

TRUE

However, integers can be nonnegative or not:

```
assume(x, Type::Integer):  
is(x, Type::NonNegInt)
```

UNKNOWN

delete x:

## Parameters

**obj**

Any MuPAD object

**x**

An identifier on page 7-29 or a mathematical expression containing identifiers

**ex**

An arithmetical expression (Symbolic Math Toolbox)

## **Return Values**

See `testtype`, `assume` and `is`

## **See Also**

### **MuPAD Functions**

`Type::Integer` | `Type::Property` | `assume` | `is` | `testtype`

# Type::NonNegRat

Type and property representing nonnegative rational numbers

## Syntax

```
testtype(obj, Type::NonNegRat)
```

```
assume(x, Type::NonNegRat)
```

```
is(ex, Type::NonNegRat)
```

## Description

Type::NonNegRat represents nonnegative rational numbers. Type::NonNegRat is a property, too, which can be used in an `assume` call.

The call `testtype(obj, Type::NonNegRat)` checks, whether `obj` is a nonnegative rational number and returns `TRUE`, if it holds, otherwise `FALSE`.

`testtype` only performs a syntactical test identifying MuPAD objects of type `DOM_INT` and `DOM_RAT` and checks, if `bool(obj >= 0)` holds.

The call `assume(x, Type::NonNegRat)` marks the identifier `x` as a nonnegative rational number.

The call `is(ex, Type::NonNegRat)` derives, whether the expression `ex` is a nonnegative rational number (or this property can be derived).

This type represents a property that can be used in `assume` and `is`.

## Examples

### Example 1

The following numbers are of type `Type::NonNegRat`:

```
testtype(2, Type::NonNegRat),  
testtype(3/4, Type::NonNegRat),  
testtype(55/111, Type::NonNegRat),  
testtype(0, Type::NonNegRat),  
testtype(111/111111, Type::NonNegRat)
```

TRUE, TRUE, TRUE, TRUE, TRUE

## Example 2

Assume an identifier is nonnegative rational:

```
assume(x, Type::NonNegRat):  
is(x, Type::NonNegRat)
```

TRUE

Also nonnegative rational numbers are rational:

```
assume(x, Type::NonNegRat):  
is(x, Type::Rational)
```

TRUE

However, rational numbers can be nonnegative rational or not:

```
assume(x, Type::Rational):  
is(x, Type::NonNegRat)
```

UNKNOWN

```
delete x:
```

## Parameters

**obj**

Any MuPAD object

**x**

An identifier on page 7-29 or a mathematical expression containing identifiers

**ex**

An arithmetical expression (Symbolic Math Toolbox)

## **Return Values**

See `testtype`, `assume` and `is`

## **See Also**

### **MuPAD Functions**

`Type::Property` | `Type::Rational` | `assume` | `is` | `testtype`

## Type::NonNegative

Type and property representing nonnegative numbers

### Syntax

```
testtype(obj, Type::NonNegative)
```

```
assume(x, Type::NonNegative)
```

```
is(ex, Type::NonNegative)
```

### Description

`Type::NonNegative` represents nonnegative numbers. `Type::NonNegative` is a property, too, which can be used in an `assume` call.

The call `testtype(obj, Type::NonNegative)` checks, whether `obj` is a nonnegative real number and returns `TRUE`, if it holds, otherwise `FALSE`.

`testtype` only performs a syntactical test identifying MuPAD objects of type `DOM_INT`, `DOM_RAT` and `DOM_FLOAT` and checks, if `bool(obj >= 0)` holds. This does not include arithmetical expressions such as `exp(1)`, which are not identified as of type `Type::NonNegative`.

The call `assume(x, Type::NonNegative)` marks the identifier `x` as a nonnegative real number.

The call `is(ex, Type::NonNegative)` derives, whether the expression `ex` is a nonnegative real number (or this property can be derived).

This type represents a property that can be used in `assume` and `is`.

Instead of `Type::NonNegative` the assumption can also be `assume(x >= 0)`.

## Examples

### Example 1

The following numbers are of type `Type::NonNegative`:

```
testtype(2, Type::NonNegative),  
testtype(3/4, Type::NonNegative),  
testtype(0.123, Type::NonNegative),  
testtype(0, Type::NonNegative),  
testtype(1.02, Type::NonNegative)
```

TRUE, TRUE, TRUE, TRUE, TRUE

The following expressions are exact representations of nonnegative numbers, but syntactically they are not of `Type::NonNegative`:

```
testtype(exp(1), Type::NonNegative),  
testtype(PI^2 + 5, Type::NonNegative),  
testtype(sin(2), Type::NonNegative)
```

FALSE, FALSE, FALSE

The function `is`, however, can find these expressions to be nonnegative:

```
is(exp(1), Type::NonNegative),  
is(PI^2 + 5, Type::NonNegative),  
is(sin(2), Type::NonNegative)
```

TRUE, TRUE, TRUE

### Example 2

Assume an identifier is nonnegative:

```
assume(x, Type::NonNegative):  
is(x, Type::NonNegative)
```

TRUE

This is equal to:

```
assume(x >= 0):  
is(x >= 0)
```

TRUE

Also nonnegative numbers are real:

```
assume(x, Type::NonNegative):  
is(x, Type::Real)
```

TRUE

But real numbers can be nonnegative or not:

```
assume(x, Type::Real):  
is(x, Type::NonNegative)
```

UNKNOWN

```
delete x:
```

## Parameters

**obj**

Any MuPAD object

**x**

An identifier on page 7-29 or a mathematical expression containing identifiers

**ex**

An arithmetical expression (Symbolic Math Toolbox)



## Return Values

See `testtype`, `assume` and `is`

## See Also

### MuPAD Functions

Type::Property | Type::Real | `assume` | `is` | `testtype`

## Type::NonZero

Type and property representing “unequal to zero”

### Syntax

```
testtype(obj, Type::NonZero)
```

```
assume(x, Type::NonZero)
```

```
is(ex, Type::NonZero)
```

### Description

Type::NonZero is a type of objects unequal to zero. Type::NonZero is a property, too, which can be used in an `assume` call.

The call `testtype(obj, Type::NonZero)` checks, whether `obj` is *not* zero and returns TRUE, if it holds, otherwise FALSE.

`testtype` only performs a syntactical test and uses the function `iszero` to determine, whether the object is not zero. This implies that identifiers without a value, for example, are considered as being different from zero, see “Example 1” on page 33-73 (Symbolic Math Toolbox).

The call `assume(x, Type::NonZero)` marks the identifier `x` as a complex number unequal to zero.

The call `is(ex, Type::NonZero)` derives, whether the expression `ex` is a complex number unequal to zero (or this property can be derived).

This type represents a property that can be used in `assume` and `is`.

The call `assume(x <> 0)` has the same meaning as `assume(x, Type::NonZero)`.

## Examples

### Example 1

Usage of Type::NonZero with testtype:

```
testtype(1.0, Type::NonZero)
```

TRUE

Since iszero(x) returns FALSE, the following call returns TRUE:

```
testtype(x, Type::NonZero)
```

TRUE

### Example 2

Usage of Type::NonZero with assume and is:

```
is(x, Type::NonZero)
```

UNKNOWN

Assumption: x is Type::NonZero:

```
assume(x, Type::NonZero):  
is(x, Type::NonZero)
```

TRUE

The same again:

```
assume(x <> 0):  
is(x <> 0)
```

TRUE

The difference between `testtype` and `is`:

```
delete x:  
is(x, Type::NonZero), testtype(x, Type::NonZero)
```

UNKNOWN, TRUE

x could be zero:

```
assume(x >= 0):  
is(x, Type::NonZero), testtype(x, Type::NonZero)
```

UNKNOWN, TRUE

```
delete x:
```

## Parameters

### **obj**

Any MuPAD object

### **x**

An identifier on page 7-29 or a mathematical expression containing identifiers

### **ex**

An arithmetical expression (Symbolic Math Toolbox)

## Return Values

See `testtype`, `assume` and `is`

## See Also

### **MuPAD Functions**

Type::Zero | assume | is | testtype

## Type::Numeric

Type representing numerical objects

### Syntax

```
testtype(obj, Type::Numeric)
```

### Description

With `Type::Numeric`, numeric objects (numbers) can be identified.

The call `testtype(obj, Type::Numeric)` checks, whether `obj` is a number and returns `TRUE`, if it holds, otherwise `FALSE`.

A number has the domain type on page 1-574 `DOM_INT`, `DOM_RAT`, `DOM_FLOAT` or `DOM_COMPLEX`.

This type does not represent a property.

### Examples

#### Example 1

The following objects are numbers.

```
testtype(2, Type::Numeric),  
testtype(3/4, Type::Numeric),  
testtype(0.123, Type::Numeric),  
testtype(1 + I/3, Type::Numeric),  
testtype(1.0 + 2.0*I, Type::Numeric)
```

`TRUE, TRUE, TRUE, TRUE, TRUE`

The following objects are not numerical objects.

```
testtype(ln(2), Type::Numeric),  
testtype(sin(3/4), Type::Numeric),  
testtype(x + I/3, Type::Numeric)
```

```
FALSE, FALSE, FALSE
```

## Parameters

**obj**

Any MuPAD object

## Return Values

See `testtype`

## See Also

### MuPAD Functions

Type::Complex | assume | is | testtype

## Type::Odd

Type and property representing odd integers

### Syntax

```
testtype(obj, Type::Odd)
```

```
assume(x, Type::Odd)
```

```
is(ex, Type::Odd)
```

### Description

Type::Odd represents odd integers. Type::Odd is a property, too, which can be used in an assume call.

The call `testtype(obj, Type::Odd)` checks, whether `obj` is an odd number and returns TRUE, if it holds, otherwise FALSE.

`testtype` only performs a syntactical test identifying MuPAD objects of type `DOM_INT` and checks, if `bool(domtype((x-1)/2) = DOM_INT)` holds.

The call `assume(x, Type::Odd)` marks the identifier `x` as an odd number.

The call `is(ex, Type::Odd)` derives, whether the expression `ex` is an odd number (or this property can be derived).

This type represents a property that can be used in `assume` and `is`.

### Examples

#### Example 1

The following numbers are of type `Type::Odd`:



```
testtype(1, Type::Odd),  
testtype(-3, Type::Odd),  
testtype(7, Type::Odd),  
testtype(-11113, Type::Odd),  
testtype(4185296581467695597, Type::Odd)
```

TRUE, TRUE, TRUE, TRUE, TRUE

## Example 2

Assume an identifier is odd:

```
assume(x, Type::Odd):  
is(x, Type::Odd)
```

TRUE

All odd numbers are integer:

```
assume(x, Type::Odd):  
is(x, Type::Integer)
```

TRUE

However, integers can be odd or not:

```
assume(x, Type::Integer):  
is(x, Type::Odd)
```

UNKNOWN

However, even numbers are not odd:

```
assume(x, Type::Odd):  
is(2*x, Type::Odd)
```

FALSE

```
assume(n, Type::Even):  
is(x*n, Type::Odd)
```

FALSE

```
is(x*n + 1, Type::Odd)
```

TRUE

```
delete x, n:
```

## Parameters

**obj**

Any MuPAD object

**x**

An identifier on page 7-29 or a mathematical expression containing identifiers

**ex**

An arithmetical expression (Symbolic Math Toolbox)

## Return Values

See `testtype`, `assume` and `is`

## See Also

### MuPAD Functions

`Type::Even` | `Type::Property` | `assume` | `is` | `testtype`

# Type::PolyExpr

Type representing polynomial expressions

## Syntax

```
testtype(obj, Type::PolyExpr(unknowns, <coeff_type>))
```

## Description

With `Type::PolyExpr`, polynomial expressions can be identified.

The call `testtype(obj, Type::PolyExpr(unknowns))` checks, whether `obj` is a polynomial expression in the indeterminates `unknowns` and, if so, returns `TRUE`, otherwise `FALSE`.

A polynomial expression in `indet` is an expression on page 7-20, where `indet` occurs only as operand of `_plus` or `_mult` expressions and in the base of `_power` with a positive integer exponent.

A polynomial expression is a representation of a polynomial, but it has the MuPAD type `DOM_EXPR` and is not produced by the function `poly`.

`indets` must be an identifier on page 7-29 or a list on page 7-41 of identifiers.

The optional argument `coeff_type` determines the type of the coefficients. If it is not given, `Type::AnyType` will be used.

This type does not represent a property.

## Examples

### Example 1

Is the object a polynomial expression with variable `x`?

```
X := -x^2 - x + 3:  
testtype(X, Type::PolyExpr(x))
```

TRUE

But X is not a MuPAD polynomial in x:

```
testtype(X, Type::PolyOf(x))
```

FALSE

Is the object a polynomial expression with variables x and y and with integer coefficients?

```
X := -x^2 - x + 3:  
testtype(X, Type::PolyExpr([x, y], Type::Integer))
```

TRUE

The next example too?

```
X := -x^2 - y^2 + 3*x + 3*y - 1:  
testtype(X, Type::PolyExpr([x, y], Type::Integer))
```

TRUE

```
delete X:
```

## Parameters

### **obj**

Any MuPAD object

### **unknowns**

An indeterminate or a list of indeterminates

**coeff\_type**

The type of the coefficients; a type can be an object of the library Type (Symbolic Math Toolbox) or one of the possible return values of `domtype` and `type`

**Return Values**

See `testtype`

**See Also****MuPAD Functions**

`Type::PolyOf` | `indets` | `poly` | `testtype`

## Type::PolyOf

Type representing polynomials

### Syntax

```
testtype(obj, Type::PolyOf(coeff_type, <num_ind>))
```

### Description

With `Type::PolyOf`, polynomials can be identified.

The call `testtype(obj, Type::PolyOf(coeff_type))` checks, whether `obj` is a polynomial with coefficients of type `coeff_type` and, if so, returns `TRUE`, otherwise `FALSE`.

---

**Note** Only polynomials of type `DOM_POLY` can be identified with `Type::PolyOf`, see `Type::PolyExpr` for polynomial expressions.

---

`coeff_type` determines the type of the coefficients.

The optional argument `num_ind` determines the number of indeterminates. If this argument is not given, the polynomial may have any number of indeterminates.

This type does not represent a property.

## Examples

### Example 1

Is the object a polynomial with integer coefficients?

```
P := poly(-x^2 - x + 3):  
testtype(P, Type::PolyOf(Type::Integer))
```

TRUE

Is the object a polynomial with integer coefficients and two indets?

```
P := poly(-x^2 - x + 3, [x, y]):  
testtype(P, Type::PolyOf(Type::Integer, 2))
```

TRUE

```
delete P:
```

## Parameters

### **obj**

Any MuPAD object

### **coeff\_type**

The type of the coefficients; a type can be an object of the library `Type` or one of the possible return values of `domtype` and `type`

### **num\_ind**

The number of indeterminates

## Return Values

See `testtype`

## See Also

### **MuPAD Functions**

`indets` | `poly` | `testtype`

## Type::PosInt

Type and property representing positive integers

### Syntax

```
testtype(obj, Type::PosInt)
```

```
assume(x, Type::PosInt)
```

```
is(ex, Type::PosInt)
```

### Description

`Type::PosInt` represents positive integers. `Type::PosInt` is a property, too, which can be used in an `assume` call.

The call `testtype(obj, Type::PosInt)` checks, whether `obj` is a positive integer number and returns `TRUE`, if it holds, otherwise `FALSE`.

`testtype` only performs a syntactical test identifying MuPAD objects of type `DOM_INT` and checks, if `bool(obj > 0)` holds.

The call `assume(x, Type::PosInt)` marks the identifier `x` as a positive integer number.

The call `is(ex, Type::PosInt)` derives, whether the expression `ex` is a positive integer number (or this property can be derived).

This type represents a property that can be used in `assume` and `is`.

### Examples

#### Example 1

The following numbers are of type `Type::PosInt`:



```
testtype(2, Type::PosInt),  
testtype(3, Type::PosInt),  
testtype(55, Type::PosInt),  
testtype(1, Type::PosInt),  
testtype(111, Type::PosInt)
```

TRUE, TRUE, TRUE, TRUE, TRUE

## Example 2

Assume an identifier is positive integer:

```
assume(x, Type::PosInt):  
is(x, Type::PosInt)
```

TRUE

Also positive integers are integers:

```
assume(x, Type::PosInt):  
is(x, Type::Integer)
```

TRUE

However, integers can be positive or not:

```
assume(x, Type::Integer):  
is(x, Type::PosInt)
```

UNKNOWN

delete x:

## Parameters

**obj**

Any MuPAD object

**x**

An identifier on page 7-29 or a mathematical expression containing identifiers

**ex**

An arithmetical expression (Symbolic Math Toolbox)

## **Return Values**

See `testtype`, `assume` and `is`

## **See Also**

### **MuPAD Functions**

`Type::Property` | `assume` | `is` | `testtype`

# Type::PosRat

Type and property representing positive rational numbers

## Syntax

```
testtype(obj, Type::PosRat)
```

```
assume(x, Type::PosRat)
```

```
is(ex, Type::PosRat)
```

## Description

Type::PosRat represents positive rational numbers. Type::PosRat is a property, too, which can be used in an `assume` call.

The call `testtype(obj, Type::PosRat)` checks, whether `obj` is a positive rational number and returns `TRUE`, if it holds, otherwise `FALSE`.

`testtype` only performs a syntactical test identifying MuPAD objects of type `DOM_INT` and `DOM_RAT` and checks, if `bool(obj > 0)` holds.

The call `assume(x, Type::PosRat)` marks the identifier `x` as a positive rational number.

The call `is(ex, Type::PosRat)` derives, whether the expression `ex` is a positive rational number (or this property can be derived).

This type represents a property that can be used in `assume` and `is`.

## Examples

### Example 1

The following numbers are of type `Type::PosRat`:

```
testtype(2, Type::PosRat),  
testtype(3/4, Type::PosRat),  
testtype(55/111, Type::PosRat),  
testtype(1, Type::PosRat),  
testtype(111/111111, Type::PosRat)
```

TRUE, TRUE, TRUE, TRUE, TRUE

## Example 2

Assume an identifier is positive rational:

```
assume(x, Type::PosRat):  
is(x, Type::PosRat)
```

TRUE

Also positive rational numbers are rational:

```
assume(x, Type::PosRat):  
is(x, Type::Rational)
```

TRUE

However, rational numbers can be positive rational or not:

```
assume(x, Type::Rational):  
is(x, Type::PosRat)
```

UNKNOWN

```
delete x:
```

## Parameters

**obj**

Any MuPAD object

**x**

An identifier on page 7-29 or a mathematical expression containing identifiers

**ex**

An arithmetical expression (Symbolic Math Toolbox)

## **Return Values**

See `testtype`, `assume` and `is`

## **See Also**

### **MuPAD Functions**

Type::Property | `assume` | `is` | `testtype`

## Type::Positive

Type and property representing positive numbers

### Syntax

```
testtype(obj, Type::Positive)
```

```
assume(x, Type::Positive)
```

```
is(ex, Type::Positive)
```

### Description

`Type::Positive` represents positive numbers. `Type::Positive` is a property, too, which can be used in an `assume` call.

The call `testtype(obj, Type::Positive)` checks, whether `obj` is a positive real number and returns `TRUE`, if it holds, otherwise `FALSE`.

`testtype` only performs a syntactical test identifying MuPAD objects of type `DOM_INT`, `DOM_RAT` and `DOM_FLOAT` and checks, if `bool(obj > 0)` holds. This does not include arithmetical expressions such as `exp(1)`, which are not identified as of type `Type::Positive`.

The call `assume(x, Type::Positive)` marks the identifier `x` as a positive real number.

The call `is(ex, Type::Positive)` derives, whether the expression `ex` is a positive real number (or this property can be derived).

This type represents a property that can be used in `assume` and `is`.

Instead of `Type::Positive` the assumption can also be `assume(x > 0)`.

## Examples

### Example 1

The following numbers are of type `Type::Positive`:

```
testtype(2, Type::Positive),  
testtype(3/4, Type::Positive),  
testtype(0.123, Type::Positive),  
testtype(1, Type::Positive),  
testtype(1.02, Type::Positive)
```

TRUE, TRUE, TRUE, TRUE, TRUE

The following expressions are exact representations of positive numbers, but syntactically they are not of `Type::Positive`:

```
testtype(exp(1), Type::Positive),  
testtype(PI^2 + 5, Type::Positive),  
testtype(sin(2), Type::Positive)
```

FALSE, FALSE, FALSE

The function `is`, however, realizes that they are, indeed, positive:

```
is(exp(1), Type::Positive),  
is(PI^2 + 5, Type::Positive),  
is(sin(2), Type::Positive)
```

TRUE, TRUE, TRUE

### Example 2

Assume an identifier is positive:

```
assume(x, Type::Positive):  
is(x, Type::Positive)
```

TRUE

This is equivalent to:

```
assume(x > 0):  
is(x > 0)
```

TRUE

Also positive numbers are real:

```
assume(x, Type::Positive):  
is(x, Type::Real)
```

TRUE

But real numbers can be positive or not:

```
assume(x, Type::Real):  
is(x, Type::Positive)
```

UNKNOWN

```
delete x:
```

## Parameters

**obj**

Any MuPAD object

**x**

An identifier on page 7-29 or a mathematical expression containing identifiers

**ex**

An arithmetical expression (Symbolic Math Toolbox)



## Return Values

See `testtype`, `assume` and `is`

## See Also

### MuPAD Functions

Type::Property | `assume` | `is` | `testtype`

## Type::Predicate

Type for testing object satisfying a given predicate

### Syntax

```
testtype(obj, Type::Predicate(<pname>, predicate, <p1, p2, ...>))
```

### Description

Type::Predicate(predicate) represents the MuPAD objects which satisfy the predicate predicate.

The call testtype(obj, pname, Type::Predicate(< pname >, predicate , < p1 , p2 >)) test whether obj satisfies predicate; that is it returns predicate(obj, p1, p2, ...).

Type::Predicate(predicate), Type::Predicate(name, predicate), Type::Predicate ( predicate( p1 , p2 , ...)), and Type::Predicate(name, predicate p1 , p2 , , ...) are respectively pretty printed as Type::Predicate(predicate), Type::name, Type::Predicate(p, p1, p2, ...), and Type::name(p1, p2, ...).

### Examples

#### Example 1

We define a type which contains any MuPAD object:

```
t := Type::Predicate(x -> TRUE):  
testtype(1, t), testtype(2, t), testtype(x, t)
```

```
TRUE, TRUE, TRUE
```

We define a type which contains all the MuPAD object which are solution of  $(x-1)*(x+1)=0$ :

```
t := Type::Predicate(x -> bool((x - 1)*(x + 1) = 0)):
testtype(1, t), testtype(2, t), testtype(x, t)
```

TRUE, FALSE, FALSE

We define a type for partitions, that is, decreasing lists of integers:

```
part :=
  Type::Predicate(l -> _lazy_and(testtype(l, Type::ListOf(Type::Integer)),
    bool(revert(sort(l)) = l)):
testtype(a, part), testtype([3, 6, 1], part), testtype([3, 2, 2], part)
```

FALSE, FALSE, TRUE

Using the naming facility is recommended to improve the readability of error messages:

```
part :=
  Type::Predicate("Partition",
    l -> _lazy_and(testtype(l, Type::ListOf(Type::Integer)),
      bool(revert(sort(l)) = l)):
f := proc(p: part) begin end:
f(3);
```

```
Error: Invalid object '3'. Type of argument number 1 must be 'Type::Partition'.
Evaluating: f
```

## Parameters

### **pname**

A string which will be used for pretty printing the type

### **predicate**

A function of one argument which can return TRUE, FALSE or FAIL

**obj, p1, p2, ...**

Any MuPAD objects

## **Return Values**

See testtype

## **See Also**

**MuPAD Functions**

testtype

# Type::Prime

Type representing prime numbers

## Syntax

```
testtype(obj, Type::Prime)
```

## Description

Type::Prime represents prime numbers.

The call `testtype(obj, Type::Prime)` returns `TRUE` if `obj` is a prime number, and `FALSE` otherwise.

`testtype` only performs a syntactical test whether `obj` is an integer and `isprime(obj)` holds.

## Examples

### Example 1

The following numbers are of type `Type::Prime`:

```
testtype(2, Type::Prime),  
testtype(3, Type::Prime),  
testtype(7, Type::Prime),  
testtype(11113, Type::Prime),  
testtype(4185296581467695597, Type::Prime)
```

`TRUE, TRUE, TRUE, TRUE, TRUE`

## Parameters

**obj**

Any MuPAD object

## Return Values

See `testtype`

## See Also

**MuPAD Functions**

`isprime` | `testtype`

# Type::Product

Type representing sequences

## Syntax

```
testtype(obj, Type::Product(typedef, ...))
```

## Description

Type::Product is the type of sequences of objects of different types.

The call `testtype(obj, Type::Product( typedef , ...))` checks, whether `obj` is a sequence of objects, which have the types given by `typedef` and returns `TRUE`, if it holds, otherwise `FALSE`.

`obj` must have the same number of arguments as the sequence `typedef`. The elements of `obj` are checked one after another: the first element of `obj` is checked against the type given by the first element of `typedef` and so on. All elements and types must match.

`typedef, ...` must be a nonempty sequence on page 1-88 of types. A type can be an object of the library `Type` (Symbolic Math Toolbox) or one of the possible return values of `domtype` and `type`.

This type does not represent a property.

## Examples

### Example 1

The argument is a sequence of a positive integer followed by an identifier:

```
testtype((5, x), Type::Product(Type::PosInt, Type::Unknown))
```

`TRUE`

Is the argument is a sequence of five positive integers?

```
testtype((5, 3, 5, -1, 0), Type::Product(Type::PosInt $ 5))
```

**FALSE**

## Parameters

### **obj**

Any MuPAD object

### **typedef**

A sequence of types; a type can be an object of the library Type (Symbolic Math Toolbox) or one of the possible return values of `domtype` and `type`

## Return Values

See `testtype`

## See Also

### **MuPAD Functions**

`Type::ListProduct` | `testtype`



# Type::Property

Type representing any property

## Syntax

```
testtype(obj, Type::Property)
```

## Description

With `Type::Property`, properties can be identified.

The call `testtype(obj, Type::Property)` checks, whether the MuPAD object `obj` is a property and returns `TRUE`, if it holds, otherwise `FALSE`.

Some elements of the library `Type` serve two functions. One is to perform syntactical tests to identify the type of an object (with `testtype`), the other is to occur as a property within `assume` and `is`.

---

**Note** `Type::Property` itself is not a property.

---

To determine whether an element of `Type` is a property, `Type::Property` can be used with `testtype`.

This type does not represent a property.

## Examples

### Example 1

Is `Type::PosInt` a property?

```
testtype(Type::PosInt, Type::Property)
```

TRUE

Also an interval created with `Type::Interval` is a property:

```
testtype(Type::Interval(0, 1), Type::Property)
```

TRUE

Is `Type::Constant` a property?

```
testtype(Type::Constant, Type::Property)
```

FALSE

`Type::Constant` is not a property and cannot be used as argument of `assume`:

```
assume(x, Type::Constant)
```

Error: Second argument must be a property. [assume]

The next example shows the usage of `testtype` to select on page 1-1828 properties among operands of `Type`:

```
T := Type::Numeric, Type::PosInt, Type::Unknown, Type::Zero:  
select(T, testtype, Type::Property)
```

Type::PosInt, Type::Zero

```
delete x, T:
```

## Parameters

**obj**

Any MuPAD object

## Return Values

See `testtype`

## See Also

**MuPAD Functions**

`is` | `testtype`

## Type::RatExpr

Type representing rational expressions

### Syntax

```
testtype(obj, Type::RatExpr(indet, <coeff_type>))
```

### Description

With `Type::RatExpr`, rational expressions can be identified.

The call `testtype(obj, Type::RatExpr(indet))` checks, whether `obj` is a rational expression in the indeterminate `indet`, i.e., the quotient of two polynomial expressions in `indet`. If it is, the result is `TRUE`, otherwise `FALSE`.

A rational expression in `indet` is a expression on page 7-20, and `indet` occurs only as operand of `_plus` or `_mult` expressions and in `_power` with an integer exponent.

`indet` must be an identifier on page 7-29, and `coeff_type` a type for the coefficients of the rational expression.

This type does not represent a property.

### Examples

#### Example 1

A polynomial expression in `x` is also a rational expression in `x`:

```
testtype(-x^2 - x + 3, Type::RatExpr(x))
```

`TRUE`

`testtype` is used to select on page 1-1828 all rational operands in `x` with positive integer coefficients:

```
EX := sin(x) + x^2 - 3*x + 2 + 3/x:  
select(EX, testtype, Type::RatExpr(x, Type::PosInt))
```

$$\frac{3}{x} + x^2 + 2$$

`delete EX:`

## Parameters

### **obj**

Any MuPAD object

### **indet**

An indeterminate

### **coeff\_type**

A type for the coefficients; a type can be an object of the library `Type` (Symbolic Math Toolbox) or one of the possible return values of `domtype` and `type`

## Return Values

See `testtype`

## See Also

### **MuPAD Functions**

`indets` | `testtype`

## Type::Rational

Type and property representing rational numbers

### Syntax

```
testtype(obj, Type::Rational)
```

```
assume(x, Type::Rational)
```

```
is(ex, Type::Rational)
```

### Description

`Type::Rational` represents rational numbers. `Type::Rational` is a property, too, which can be used in an `assume` call.

The call `testtype(obj, Type::Rational)` checks, whether `obj` is a rational number and returns `TRUE`, if it holds, otherwise `FALSE`.

`testtype` only performs a syntactical test identifying MuPAD objects of type `DOM_INT` and `DOM_RAT`.

The call `assume(x, Type::Rational)` marks the identifier `x` as a rational number.

The call `is(ex, Type::Rational)` derives, whether the expression `ex` is a rational number (or this property can be derived).

This type represents a property that can be used in `assume` and `is`.

### Examples

#### Example 1

The following numbers are of type `Type::Rational`:

```
testtype(2, Type::Rational),  
testtype(3/4, Type::Rational),  
testtype(-1/2, Type::Rational),  
testtype(-1, Type::Rational),  
testtype(1024/11111, Type::Rational)
```

TRUE, TRUE, TRUE, TRUE, TRUE

## Example 2

Integers are rational:

```
assume(x, Type::Integer):  
is(x, Type::Rational)
```

TRUE

However, rational numbers can be integer or not:

```
assume(x, Type::Rational):  
is(x, Type::Integer)
```

UNKNOWN

```
delete x:
```

## Parameters

### **obj**

Any MuPAD object

### **x**

An identifier on page 7-29 or a mathematical expression containing identifiers

### **ex**

An arithmetical expression (Symbolic Math Toolbox)

## **Return Values**

See `testtype`, `assume` and `is`

## **See Also**

### **MuPAD Functions**

Type::Property | `assume` | `is` | `testtype`



# Type::Real

Type and property representing real numbers

## Syntax

```
testtype(obj, Type::Real)
```

```
assume(x, Type::Real)
```

```
is(ex, Type::Real)
```

## Description

`Type::Real` represents real numbers. `Type::Real` is a property, too, which can be used in an `assume` call.

The call `testtype(obj, Type::Real)` checks, whether `obj` is a real number and, if it is, returns `TRUE`, otherwise `FALSE`.

`testtype` only performs a syntactical test identifying MuPAD objects of type `DOM_INT`, `DOM_RAT` and `DOM_FLOAT`. This does not include arithmetical expressions such as `exp(1)`, which are not identified as of type `Type::Real`.

The call `assume(x, Type::Real)` marks the identifier `x` as a real number.

The call `is(ex, Type::Real)` derives, whether the expression `ex` is a real number (or this property can be derived).

This type represents a property that can be used in `assume` and `is`.

## Examples

### Example 1

The following numbers are of type `Type::Real`:

```
testtype(2, Type::Real),  
testtype(3/4, Type::Real),  
testtype(0.123, Type::Real),  
testtype(-1, Type::Real),  
testtype(-1.02, Type::Real)
```

TRUE, TRUE, TRUE, TRUE, TRUE

The following expressions are exact representations of real numbers, but syntactically they are not of `Type::Real`:

```
testtype(exp(1), Type::Real),  
testtype(PI^2 + 5, Type::Real),  
testtype(sin(2), Type::Real)
```

FALSE, FALSE, FALSE

The function `is` performs a semantical, mathematically more useful check:

```
is(exp(1), Type::Real),  
is(PI^2 + 5, Type::Real),  
is(sin(2), Type::Real)
```

TRUE, TRUE, TRUE

## Example 2

Integers are real numbers:

```
assume(x, Type::Integer):  
is(x, Type::Real)
```

TRUE

But real numbers can be integer or not:

```
assume(x, Type::Real):  
is(x, Type::Integer)
```

## UNKNOWN

The sine of a real number is a real number in the interval  $[-1, 1]$ :

```
getprop(sin(x))
```

```
[-1, 1]
```

```
delete x:
```

## Parameters

**obj**

Any MuPAD object

**x**

An identifier on page 7-29 or a mathematical expression containing identifiers

**ex**

An arithmetical expression (Symbolic Math Toolbox)

## Return Values

See `testtype`, `assume` and `is`

## See Also

### MuPAD Functions

Type::Property | `assume` | `is` | `testtype`

## Type::Relation

Type representing relations

### Syntax

```
testtype(obj, Type::Relation)
```

### Description

With `Type::Relation`, relational expression can be identified.

The call `testtype(obj, Type::Relation)` checks, whether `obj` is a relational expression and returns `TRUE`, if it is, otherwise `FALSE`.

A relation in MuPAD is an expression on page 7-20 of the type on page 33-12 (Symbolic Math Toolbox) "`_equal`", "`_unequal`", "`_less`" and "`_leequal`".

---

**Note** Expressions with the operations `>=` and `>` will be interpreted as expressions with `<=` and `<` by exchanging the operands (see "Example 2" on page 33-115 (Symbolic Math Toolbox)).

---

This type does not represent a property.

### Examples

#### Example 1

`x > 3` is a relation, while `TRUE` is not:

```
testtype(x > 3, Type::Relation),  
testtype(TRUE, Type::Relation)
```

`TRUE, FALSE`

## Example 2

MuPAD always interprets expressions with the operations  $\geq$  and  $>$  as expressions with  $\leq$  and  $<$  with the operands exchanged:

```
x > 3;
prog::expree(x > 3):
```

```
3 < x
```

```
_less
|
+-- 3
|
`-- x
```

The operator is *not*  $>$ , but  $<$ , and the operands have been swapped:

```
op(x > 3, 0..2)
```

```
_less, 3, x
```

## Parameters

**obj**

Any MuPAD object

## Return Values

See `testtype`

## See Also

**MuPAD Functions**

testtype

# Type::Residue

Property representing a residue class

## Syntax

```
assume(x, (rem, class, <sub_set>))  
is(ex, (rem, class, <sub_set>))  
testtype(ex, (rem, class, <sub_set>))
```

## Description

`Type::Residue(rem, class)` represents the integers  $n$  for which  $n - rem$  is divisible by *class*.

The call `assume(x, Type::Residue(rem, class))` marks the identifier  $x$  as an integer divisible by *class* with remainder *rem*.

The call `is(ex, Type::Residue(rem, class))` derives, whether the expression *ex* is an integer divisible by *class* with remainder *rem* (or this property can be derived).

This type represents a property that can be used in `assume` and `is`.

`Type::Even` and `Type::Odd` are objects created by `Type::Residue`.

The call `testtype(obj, Type::Residue(rem, class))` checks, whether *obj* is an integer on page 7-31 and is divisible by *class* with remainder *rem*. If the optional argument *sub\_set* is given, `testtype` checks additionally `testtype(obj, sub_set)`.

## Examples

### Example 1

`Type::Residue` can be used in `testtype`:

```
testtype(6, Type::Residue(2, 4)),  
testtype(13, Type::Residue(1, 20))
```

TRUE, FALSE

## Example 2

x is assumed to be divisible by 3 with remainder 1:

```
assume(x, Type::Residue(1, 3))
```

Which properties has  $x + 2$  got?

```
getprop(x + 2)
```

$\{3k \mid k \in \mathbb{Z}\}$

x is an integer, but it may be odd on page 33-78 or not:

```
is(x, Type::Integer), is(x, Type::Odd)
```

TRUE, UNKNOWN

This example restricts possible values of x to odd integers:

```
assume(x, Type::Residue(1, 4));  
is(x, Type::Odd),  
is((-1)^x < 0)
```

TRUE, TRUE

## Parameters

**x**

An identifier on page 7-29 or a mathematical expression containing identifiers



**rem**

Remainder as integer number between 0 and `class - 1`; an integer larger than `class - 1` will be divided by `class` and `rem` gets the remainder of this division

**class**

The divider as positive integer

**sub\_set**

A subset of the integers (e.g., `Type::PosInt`); otherwise `Type::Integer` is used

**ex**

An arithmetical expression (Symbolic Math Toolbox)

**obj**

Any MuPAD object

## Return Values

See `assume`, `is` and `testtype`

## See Also

**MuPAD Functions**

`Type::Even` | `Type::Integer` | `Type::Odd` | `assume` | `is` | `testtype`

## Type::SequenceOf

Type representing sequences

### Syntax

```
testtype(obj, (obj_type, <min_nr, <max_nr>>))
```

### Description

With `Type::SequenceOf`, sequences with specified objects can be identified.

The call `testtype(obj, Type::SequenceOf(obj_type))` checks, whether `obj` is a sequence on page 1-88 with elements of the given type `obj_type`. In that case, it `TRUE`, otherwise `FALSE`.

A sequence has the domain type on page 1-574 `DOM_EXPR` and the type on page 33-12 (Symbolic Math Toolbox) `"_exprseq"`.

The two optional parameters `min_nr` and `max_nr` determine the minimum and maximum number of arguments of the analysed sequence, respectively. If the numbers are not be given, the number of elements of the sequence will not be checked. If only the minimum is given, the sequence must have at least `min_nr` elements for the test to succeed.

This type does not represent a property.

### Examples

#### Example 1

Is the given sequence a sequence of identifiers?

```
testtype((a, b, c, d, e, f), Type::SequenceOf(DOM_IDENT))
```

`TRUE`

Is the given sequence a sequence of at least five real numbers?

```
testtype((0, 0.5, 1, 1.5, 2, 2.5, 3), Type::SequenceOf(Type::Real, 5))
```

TRUE

## Parameters

### **obj**

Any MuPAD object

### **obj\_type**

The type of the objects; a type can be an object of the library Type (Symbolic Math Toolbox) or one of the possible return values of `domtype` and `type`

### **min\_nr**

The minimal number of objects as nonnegative integer

### **max\_nr**

The maximal number of objects as nonnegative integer

## Return Values

See `testtype`

## See Also

### **MuPAD Functions**

`Type::ListOf` | `_exprseq` | `testtype`

## Type::Series

Type representing truncated Puiseux, Laurent, and Taylor series expansions

### Syntax

```
testtype(obj, (Puiseux | Laurent | Taylor))
```

```
testtype(obj, (Puiseux | Laurent | Taylor, x))
```

```
testtype(obj, (Puiseux | Laurent | Taylor, x = x0))
```

```
testtype(obj, (Puiseux | Laurent | Taylor, x, Undirected | Real | Right | Left))
```

```
testtype(obj, (Puiseux | Laurent | Taylor, x = x0, Undirected | Real | Right | Left))
```

### Description

`Type::Series(Puiseux)`, `Type::Series(Laurent)`, and `Type::Series(Taylor)` represent truncated Puiseux series, Laurent series, and Taylor series, respectively.

The call `testtype(obj, Type::Series(T))` checks, whether `obj` is a truncated series expansion of domain type `Series::Puiseux` and of mathematical type `T`.

The call `testtype(obj, Type::Series(T, x = x0))` checks in addition, whether the series variable is `x` and the expansion point is `x0`. If `x0` is omitted, `x0 = 0` is assumed.

The call `testtype(obj, Type::Series(T, x = x0, dir))` checks in addition, whether the direction of expansion is compatible with the specified direction `dir`. See the help pages of `series` and `Series::Puiseux` for more details about the direction.

See “Example 1” on page 33-123 (Symbolic Math Toolbox) and “Example 3” on page 33-126 (Symbolic Math Toolbox).

If `obj` is of domain type `Series::Puiseux`, but not a Puiseux expansion in the mathematical sense, then `testtype(obj, Type::Series(T))` returns `FALSE`. This is the case if the coefficients of `obj` depend on the series variable, or if the type flag of `obj`

is 1. See “Example 2” on page 33-124 (Symbolic Math Toolbox), and the help page of `Series::Puisseux` for more details.

A Laurent series is a Puisseux series with integral exponents. If the expansion point is finite, then a Taylor series is a Puisseux series with nonnegative integral exponents. If the expansion point is `complexInfinity`, then a Taylor series is a Puisseux series with nonpositive integral exponents. See “Example 1” on page 33-123 (Symbolic Math Toolbox) and “Example 4” on page 33-127 (Symbolic Math Toolbox).

For the expansion points `infinity` and `-infinity`, the directions `Left` and `Right`, respectively, are implicitly assumed.

Specifying `x0 = infinity` is equivalent to `x0 = complexInfinity` and `dir = Left`, and similarly `x0 = -infinity` is equivalent to `x0 = complexInfinity` and `dir = Right`.

See “Example 4” on page 33-127 (Symbolic Math Toolbox).

This type does not represent a property: it cannot be used in `assume` to mark an identifier as a truncated series expansion.

## Examples

### Example 1

The following call returns a Puisseux series:

```
s := series(sin(sqrt(x)), x);
domtype(s);
```

$$\sqrt{x} - \frac{x^{3/2}}{6} + \frac{x^{5/2}}{120} + O\left(x^{7/2}\right)$$

`Series::Puisseux`

However, `s` is not a Laurent series:

```
testtype(s, Type::Series(Puiseux)),
testtype(s, Type::Series(Laurent)),
testtype(s, Type::Series(Taylor))
```

TRUE, FALSE, FALSE

A Laurent series that is not a Taylor series:

```
s := series(1/sin(x), x);
domtype(s);
```

$$\frac{1}{x} + \frac{x}{6} + \frac{7x^3}{360} + O(x^5)$$

Series::Puiseux

```
testtype(s, Type::Series(Puiseux)),
testtype(s, Type::Series(Laurent)),
testtype(s, Type::Series(Taylor))
```

TRUE, TRUE, FALSE

The inverse of s is a Taylor series:

```
1/s;
testtype(1/s, Type::Series(Puiseux)),
testtype(1/s, Type::Series(Laurent)),
testtype(1/s, Type::Series(Taylor))
```

$$x - \frac{x^3}{6} + \frac{x^5}{120} + O(x^7)$$

TRUE, TRUE, TRUE

## Example 2

Type::Series represents only objects of domain type Series::Puiseux:

```
s := 1 + x + 2*x^2 + 0(x^3);
domtype(s), testtype(s, Type::Series(Puiseux));
```

$$x + 2x^2 + 1 + O(x^3)$$

DOM\_EXPR, FALSE

```
s := series(exp(x + 1/x), x = infinity, 3);
domtype(s), testtype(s, Type::Series(Puiseux));
```

$$e^x + \frac{e^x}{x} + \frac{e^x}{2x^2} + O\left(\frac{e^x}{x^3}\right)$$

Series::gseries, FALSE

For objects of domain type `Series::Puiseux`, whose coefficients contain the series variable or whose type flag is 1, the result is FALSE as well:

```
s := series(psi(x), x = infinity);
domtype(s), coeff(s, 0), testtype(s, Type::Series(Puiseux));
```

$$\ln(x) - \frac{1}{2x} - \frac{1}{12x^2} + \frac{1}{120x^4} + O\left(\frac{1}{x^6}\right)$$

Series::Puiseux, ln(x), FALSE

```
s := series(sin(sqrt(-x)), x);
domtype(s), testtype(s, Type::Series(Puiseux));
```

$$\sqrt{-x} - \frac{(-x)^{3/2}}{6} + \frac{(-x)^{5/2}}{120} + O(x^{7/2})$$

Series::Puiseux, FALSE

### Example 3

By specifying further arguments, you can check for the series variable, the expansion point, and the direction of expansion as well:

```
s := series(sin(sqrt(-x)), x, Left);
testtype(s, Type::Series(Puiseux, y)),
testtype(s, Type::Series(Puiseux, x)),
testtype(s, Type::Series(Puiseux, x = 0)),
testtype(s, Type::Series(Puiseux, x = 2));
```

$$-\sqrt{x}i - \frac{x^{3/2}i}{6} - \frac{x^{5/2}i}{120} + O(x^{7/2})$$

FALSE, TRUE, TRUE, FALSE

```
Series::Puiseux::direction(s),
testtype(s, Type::Series(Puiseux, x, Undirected)),
testtype(s, Type::Series(Puiseux, x, Real)),
testtype(s, Type::Series(Puiseux, x, Right)),
testtype(s, Type::Series(Puiseux, x, Left));
```

Left, FALSE, FALSE, FALSE, TRUE

```
s := series(x^5/(x - 2), x = 2, 3);
testtype(s, Type::Series(Laurent, x)),
testtype(s, Type::Series(Laurent, x = 2)),
testtype(s, Type::Series(Laurent, x = 3));
```

$$\frac{32}{x-2} + 80 + 80(x-2) + O((x-2)^2)$$

FALSE, TRUE, FALSE

If you specify a direction, `testtype` checks whether it is compatible with the direction of the series:



```
Series::Puisseux::direction(s),
testtype(s, Type::Series(Puisseux, x = 2, Undirected)),
testtype(s, Type::Series(Puisseux, x = 2, Real)),
testtype(s, Type::Series(Puisseux, x = 2, Right)),
testtype(s, Type::Series(Puisseux, x = 2, Left));
```

Undirected, TRUE, TRUE, TRUE, TRUE

## Example 4

The following example is a Laurent series around infinity, but not a Taylor series:

```
s := series(z*exp(1/z), z = infinity);
testtype(s, Type::Series(Puisseux)),
testtype(s, Type::Series(Laurent)),
testtype(s, Type::Series(Taylor))
```

$$z + 1 + \frac{1}{2z} + \frac{1}{6z^2} + \frac{1}{24z^3} + \frac{1}{120z^4} + O\left(\frac{1}{z^5}\right)$$

TRUE, TRUE, FALSE

The expansion point is infinity, or equivalently, complexInfinity from the left:

```
Series::Puisseux::point(s), Series::Puisseux::direction(s);
testtype(s, Type::Series(Laurent, z)),
testtype(s, Type::Series(Laurent, z = 0)),
testtype(s, Type::Series(Laurent, z = infinity)),
testtype(s, Type::Series(Laurent, z = -infinity)),
testtype(s, Type::Series(Laurent, z = complexInfinity));
```

complexInfinity, Left

FALSE, FALSE, TRUE, FALSE, TRUE

```
testtype(s, Type::Series(Laurent, z = complexInfinity, Undirected)),
testtype(s, Type::Series(Laurent, z = complexInfinity, Real)),
```

```
testtype(s, Type::Series(Laurent, z = complexInfinity, Right)),
testtype(s, Type::Series(Laurent, z = complexInfinity, Left));
```

FALSE, FALSE, FALSE, TRUE

Mathematically, the expression is even an undirected expansion around complexInfinity:

```
s := series(z*exp(1/z), z = complexInfinity);
Series::Puisseux::point(s), Series::Puisseux::direction(s);
```

$$z + 1 + \frac{1}{2z} + \frac{1}{6z^2} + \frac{1}{24z^3} + \frac{1}{120z^4} + O\left(\frac{1}{z^5}\right)$$

complexInfinity, Undirected

```
testtype(s, Type::Series(Laurent, z)),
testtype(s, Type::Series(Laurent, z = infinity)),
testtype(s, Type::Series(Laurent, z = -infinity)),
testtype(s, Type::Series(Laurent, z = complexInfinity));
```

FALSE, TRUE, TRUE, TRUE

```
testtype(s, Type::Series(Laurent, z = complexInfinity, Undirected)),
testtype(s, Type::Series(Laurent, z = complexInfinity, Real)),
testtype(s, Type::Series(Laurent, z = complexInfinity, Right)),
testtype(s, Type::Series(Laurent, z = complexInfinity, Left));
```

TRUE, TRUE, TRUE, TRUE

## Parameters

**obj**

Any MuPAD object

**x**

The series variable: an identifier on page 7-29

**x0**

The expansion point: an arithmetical expression (Symbolic Math Toolbox)

## Options

**Laurent, Puiseux, Taylor**

The type of series

**Left, Real, Right, Undirected**

The direction of the expansion

## Return Values

See `testtype`

## See Also

**MuPAD Functions**

`Series::Puiseux` | `Type::PolyExpr` | `Type::PolyOf` | `series` | `testtype`

## Type::SetOf

Type representing sets

### Syntax

```
testtype(obj, (obj_type, <min_nr, <max_nr>>))
```

### Description

`Type::SetOf(obj_type)` describes sets of elements of type `obj_type`.

The call `testtype(obj, Type::SetOf(obj_type))` checks, whether `obj` is a set on page 7-50 with elements of the given type `obj_type`. If it is, the function returns `TRUE`, otherwise `FALSE`.

A set has the domain type on page 1-574 `DOM_SET`.

The two optional parameters `min_nr` and `max_nr` determine the minimum and maximum number of elements in the analysed set. If the numbers are not be given, the number of elements in the set will not be checked. If only the minimum is given, the set must contain at least `min_nr` elements for the test to succeed.

This type does not represent a property.

### Examples

#### Example 1

Is the given set a set of identifiers?

```
testtype({a, b, c, d, e, f}, Type::SetOf(DOM_IDENT))
```

`TRUE`

Is the given set a set of at least five real numbers?

```
testtype({0, 0.5, 1, 1.5, 2, 2.5, 3}, Type::SetOf(Type::Real, 5))
```

TRUE

## Example 2

testtype is used to select on page 1-1828 sets with exactly two identifiers:

```
S := {{a}, {a, b}, {d, 1}, {0, d}, {e}, {d, e}}:
select(S, testtype, Type::SetOf(DOM_IDENT, 2, 2))
```

{{d, e}, {a, b}}

## Parameters

### obj

Any MuPAD object

### obj\_type

The type of the objects; a type can be an object of the library Type or one of the possible return values of domtype and type

### min\_nr

The minimal number of objects as nonnegative integer

### max\_nr

The maximal number of objects as nonnegative integer

## Return Values

See testtype

## See Also

### **MuPAD Domains**

DOM\_SET

### **MuPAD Functions**

Type::ListOf | Type::Union | testtype

# Type::Set

Type representing set-theoretic expressions

## Syntax

```
testtype(obj, Type::Set)
```

## Description

Type::Set comprises all expressions in which the operators are set-theoretic operations

A set-theoretic expression is defined to be any of the following: a set constant, an identifier, an unevaluated call to a set-valued function, or the composition of set-theoretic expressions by the operator union, intersect, or minus.

The following objects are set constants: finite sets of type DOM\_SET, intervals, the universe, and every object that belongs to a domain of category Cat::Set.

The following functions are set-valued: solve, discount, RootOf, and solvelib::Union.

The union, intersection, or difference of objects is not a set-theoretic expression unless each of the objects is. See “Example 2” on page 33-134 (Symbolic Math Toolbox).

## Examples

### Example 1

Sets are set-theoretic expressions.

```
testtype({3}, Type::Set)
```

```
TRUE
```

## Example 2

Unions, intersections, and differences are set-theoretic expressions if and only if all operands are.

```
testtype(a union {4}, Type::Set)
```

TRUE

```
testtype(a+1 union {4}, Type::Set)
```

FALSE

## Example 3

If the call to a set-valued function as `solve` returns unevaluated, then the result is a set-theoretic expression.

```
solve(x^2 = sin(x + 1), x)
```

$\text{solve}(x^2 - \sin(x + 1) = 0, x)$

```
testtype(%, Type::Set)
```

TRUE

## Parameters

**obj**

Any MuPAD object

## Return Values

See `testtype`



## See Also

**MuPAD Functions**

testtype

## Type::Singleton

Type representing exactly one object

### Syntax

```
testtype(obj, (t_obj))
```

### Description

`testtype(x, Type::Singleton(y))` is equivalent to `bool(x = y)`.

The call `testtype(obj, Type::Singleton(t_obj))` is equivalent to `bool(x = y)`, but the latter is faster.

`Type::Singleton` can be used to create combined types, especially in conjunction with `Type::Union`, `Type::Equation` and other types expecting type information for subexpressions (see “Example 2” on page 33-137 (Symbolic Math Toolbox)).

This type does not represent a property.

## Examples

### Example 1

Check, if x is really x:

```
testtype(x, Type::Singleton(x))
```

**TRUE**

But the next call does the same:

```
bool(x = x)
```

TRUE

## Example 2

Type::Singleton exists to create special testing expressions:

```
T := Type::Union(Type::Singleton(hold(All)), Type::Constant):
```

With the type T the option All and any constant can be identified with one call of testtype:

```
testtype(4, T), testtype(hold(All), T), testtype(x, T)
```

TRUE, TRUE, FALSE

But (e.g., in procedures) the following example works faster:

```
test := X -> testtype(X, Type::Constant) or bool(X = hold(All)):
test(4), test(hold(All)), test(x)
```

TRUE, TRUE, FALSE

One way to test a list of options for syntactical correctness is the following:

```
T := Type::Union(
  // Name = "...
  Type::Equation(Type::Singleton(hold(Name)), DOM_STRING),
  // Mode = n, n in {1, 2, 3}
  Type::Equation(Type::Singleton(hold(Mode)),
    Type::Interval([1,3], Type::Integer)),
  // Quiet
  Type::Singleton(hold(Quiet))
):
```

```
testtype((Name = "abcde", Quiet), Type::SequenceOf(T))
```

TRUE

We only allow the values 1, 2, and 3 for Mode, however:

```
testtype((Quiet, Mode = 0), Type::SequenceOf(T))
```

```
FALSE
```

Obviously, it would be a good idea to tell the user which options we could not grok:

```
error("Unknown option(s): ".expr2text(  
    select((Quiet, Mode = 0),  
    not testtype, Type::SequenceOf(T))))
```

```
Error: Unknown option(s): Mode = 0
```

```
delete T, test:
```

## Parameters

**obj**

Any MuPAD object

**t\_obj**

Any object to identify

## Return Values

See `testtype`

## See Also

### MuPAD Functions

`Type::Union` | `_equal` | `bool` | `testtype`

# Type::TableOfEntry

Type representing tables with specified entries

## Syntax

```
testtype(obj, (obj_type))
```

## Description

Type::TableOfEntry(obj\_type) describes tables with *entries* of type obj\_type.

The call testtype(obj, Type::TableOfEntry(obj\_type)) checks, whether obj is a table on page 1-2103 and all entries of this table are of the type obj\_type. If both conditions are met, the call returns TRUE, otherwise FALSE.

The entries of a table on page 1-2103 are the right hand sides of the operands of a table.

This type does not represent a property.

## Examples

### Example 1

The following table uses identifiers as keys and integers as entries:

```
T := table(a = 1, b = 2, c = 3, d = 4):
testtype(T, Type::TableOfEntry(DOM_INT))
```

TRUE

Type::TableOfEntry only checks the type of the entries, not the keys:

```
T := table(a = 1, b = 2, c = 3, d = 4):
testtype(T, Type::TableOfEntry(DOM_IDENT))
```

FALSE

delete T:

## Parameters

**obj**

Any MuPAD object

**obj\_type**

The type of the entries; can be an object of the library Type (Symbolic Math Toolbox) or one of the possible return values of `domtype` and `type`

## Return Values

See `testtype`

## See Also

**MuPAD Functions**

`Type::TableOfIndex` | `table` | `testtype`

# Type::TableOfIndex

Type representing tables with specified indices

## Syntax

```
testtype(obj, (obj_type))
```

## Description

`Type::TableOfIndex(obj_type)` represents tables with *indices* (keys) of type `obj_type`.

The call `testtype(obj, Type::TableOfIndex(obj_type))` checks, whether `obj` is a table on page 1-2103 and all indices (keys) are of the type `obj_type`. If both conditions are met, the call returns `TRUE`, otherwise `FALSE`.

The indices of a table on page 1-2103 are the left hand sides of the operands of a table.

This type does not represent a property.

## Examples

### Example 1

The following table uses identifiers as keys and integers as values:

```
T := table(a = 1, b = 2, c = 3, d = 4):  
testtype(T, Type::TableOfIndex(DOM_IDENT))
```

`TRUE`

`Type::TableOfIndex` only checks the types of the keys of the table, so the following call returns `FALSE`:

```
T := table(a = 1, b = 2, c = 3, d = 4):  
testtype(T, Type::TableOfIndex(DOM_INT))
```

FALSE

```
delete T:
```

## Parameters

### **obj**

Any MuPAD object

### **obj\_type**

The type of the indices; can be an object of the library Type (Symbolic Math Toolbox) or one of the possible return values of `domtype` and `type`

## Return Values

See `testtype`

## See Also

### **MuPAD Functions**

`Type::TableOfEntry` | `table` | `testtype`



# Type::TableOf

Type representing tables

## Syntax

```
testtype(obj, (<indices_type, <entries_type>>))
```

## Description

Type::TableOf represents tables; the types of the *indices* and of the *entries* can be specified.

The call `testtype(obj, Type::TableOf(indices_type, entries_type))` checks, whether `obj` is a table on page 1-2103 with indices of type `indices_type` and entries of type `entries_type`.

The *indices* (resp. the *entries*) of a table on page 1-2103 are the left (resp. right) hand sides of the operands of a table.

`indices_type` and `entries_type` default to `Type::AnyType`

This type does not represent a property.

## Examples

### Example 1

We test if the following objects are tables:

```
testtype(x, Type::TableOf());  
testtype(table(), Type::TableOf())
```

FALSE

TRUE

We test if the following objects are tables with integer indexes:

```
testtype(table(a = 1), Type::TableOf(Type::Integer));  
testtype(table(1 = 2), Type::TableOf(Type::Integer))
```

FALSE

TRUE

We test if the following objects are tables with integer entries:

```
testtype(table(a = a), Type::TableOf(Type::AnyType, Type::Integer));  
testtype(table(a = 2), Type::TableOf(Type::AnyType, Type::Integer))
```

FALSE

TRUE

We test if the following objects are tables with integer indexes and entries:

```
testtype(table(a = a), Type::TableOf(Type::Integer, Type::Integer));  
testtype(table(1 = 2), Type::TableOf(Type::Integer, Type::Integer))
```

FALSE

TRUE

## Example 2

Test if the following table uses identifiers as indexes:

```
T := table(a = 1, b = 2, c = 3, d = 4):  
testtype(T, Type::TableOf(DOM_IDENT))
```

TRUE

Test if the following table uses integers as indexes:

```
T := table(a = 1, b = 2, c = 3, d = 4):  
testtype(T, Type::TableOf(DOM_INT))
```

FALSE

```
delete T:
```

### Example 3

The following table uses identifiers as keys and integers as entries:

```
T := table(a = 1, b = 2, c = 3, d = 4):  
testtype(T, Type::TableOf(Type::AnyType, DOM_INT))
```

TRUE

Type::TableOf only checks the type of the entries, not the keys:

```
T := table(a = 1, b = 2, c = 3, d = 4):  
testtype(T, Type::TableOf(Type::AnyType, DOM_IDENT))
```

FALSE

```
delete T:
```

## Parameters

**obj**

Any MuPAD object

**indices\_type**

The type of the indices. It can be an object of the library `Type` (Symbolic Math Toolbox) or one of the possible return values of `domtype` and `type`

**entries\_type**

The type of the entries.

## Return Values

See `testtype`

## See Also

**MuPAD Functions**

`Type::TableOfEntry` | `Type::TableOfIndex` | `table` | `testtype`

# Type::Union

Type representing several types as one type object

## Syntax

```
testtype(obj, (obj_types, ...))
```

## Description

Type::Union ( type1 , type2 , ...) represents all objects having at least one of the types type1, type2, ...

The call `testtype(obj, Type::Union( obj_types , ...))` checks, whether `obj` has the type of at least one of the given types `obj_types, ...`. If such a type is found, the call returns `TRUE`, otherwise `FALSE`.

The call `testtype(Type::Union( obj , obj_types , ...))` is thus equivalent to the call `_lazy_or(map(obj_types, x -> testtype(obj, x)))`, testing `obj` against all types in turn until one is found which matches.

`obj_types, ...` must be a (nonempty) sequence on page 1-88 of types (see `testtype`).

This type does not represent a property.

## Examples

### Example 1

Check, whether the given object is a positive or negative integer:

```
testtype(2, Type::Union(Type::PosInt, Type::NegInt))
```

`TRUE`

$x$  however, is neither a positive nor a negative number:

```
testtype(x, Type::Union(Type::Positive, Type::Negative))
```

```
FALSE
```

## Example 2

`testtype` is used to select on page 1-1828 positive and negative integers:

```
SET:= {-2, -1.5, -1, -0.5, 0, 0.5, 1, 1.5, 2};  
select(SET, testtype, Type::Union(Type::PosInt, Type::NegInt))
```

```
{-2, -1, 1, 2}
```

```
delete SET:
```

## Parameters

**obj**

Any MuPAD object

**obj\_types**

A sequence of types; a type can be an object of the library `Type` (Symbolic Math Toolbox) or one of the possible return values of `domtype` and `type`

## Return Values

See `testtype`

## See Also

**MuPAD Functions**

testtype

## Type::Unknown

Type representing variables

### Syntax

```
testtype(obj, Type::Unknown)
```

### Description

Type::Unknown represents identifiers and indexed identifiers.

The call `testtype(obj, Type::Unknown)` checks, whether `obj` is an identifier or an indexed identifier with an integer index. If it is, the call returns `TRUE`, otherwise `FALSE`.

An identifier has the domain type on page 1-574 `DOM_IDENT`. An indexed identifier is an expression on page 7-20 with type on page 33-12 (Symbolic Math Toolbox) `_index` and two operands, the first of which is an identifier and the second one is an integer. A local variable on page 7-56 is not of type `Type::Unknown`.

This type does not represent a property.

### Examples

#### Example 1

Type::Unknown accepts identifiers:

```
testtype(x, Type::Unknown)
```

`TRUE`

`x[0]` is an indexed identifier accepted by `Type::Unknown`:

```
testtype(x[0], Type::Unknown)
```



TRUE

The index must be an integer:

```
testtype(x[-1], Type::Unknown),  
testtype(x[1.0], Type::Unknown)
```

TRUE, FALSE

## Parameters

**obj**

Any MuPAD object

## Return Values

See `testtype`

## See Also

**MuPAD Functions**

`indets` | `testtype`

## Type::Zero

Type and property representing zero

### Syntax

```
testtype(obj, Type::Zero)
```

```
assume(x, Type::Zero)
```

```
is(ex, Type::Zero)
```

### Description

`testtype(obj, Type::Zero)` is equivalent to `iszero(obj)`. `Type::Zero` is a property, too, which can be used in an `assume` call.

The call `testtype(obj, Type::Zero)` is equivalent to `iszero(obj)`, which performs a syntactical test if `obj` is zero. If it is, the call returns `TRUE`, otherwise, `FALSE` is returned.

The call `assume(x, Type::Zero)` marks the identifier `x` as zero.

The call `is(ex, Type::Zero)` derives, whether the expression `ex` is zero (or this property can be derived).

This type represents a property that can be used in `assume` and `is`.

The call `assume(x = 0)` has the same meaning as `assume(x, Type::Zero)`.

### Examples

#### Example 1

`testtype` determines the syntactical equality to zero:

```
testtype(0.0, Type::Zero)
```

TRUE

```
testtype(x, Type::Zero)
```

FALSE

## Example 2

Type::Zero can be used within assume and is:

```
is(x, Type::Zero)
```

UNKNOWN

Assumption that x is zero:

```
assume(x, Type::Zero):  
is(x^2, Type::Zero)
```

TRUE

The next example shows the difference between testtype and is:

```
is(x, Type::Zero), testtype(x, Type::Zero)
```

TRUE, FALSE

Now the property of x is removed:

```
delete x:  
is(x, Type::Zero), testtype(x, Type::Zero)
```

UNKNOWN, FALSE

A positive number cannot be zero:

```
assume(x > 0):  
is(x, Type::Zero), testtype(x, Type::Zero)
```

FALSE, FALSE

But in the next example x could be zero:

```
assume(x >= 0):  
is(x, Type::Zero), testtype(x, Type::Zero)
```

UNKNOWN, FALSE

```
delete x:
```

## Parameters

### **obj**

Any MuPAD object

### **x**

An identifier on page 7-29 or a mathematical expression containing identifiers

### **ex**

An arithmetical expression (Symbolic Math Toolbox)

## Return Values

See testtype, assume and is

## See Also

### **MuPAD Functions**

Type::NonZero | assume | is | testtype